



# Disclaimer

This user manual is provided as a free service by FixYourDLP.com. FixYourDLP is in no way responsible for the content of this manual, nor do we guarantee its accuracy. FixYourDLP does not make any claim of copyright and all copyrights remain the property of their respective owners.

About FixYourDLP.com

FixYourDLP.com (<http://www.fixyourdlp.com>) is the World's #1 resource for media product news, reviews, do-it-yourself guides, and manuals.

Informational Blog: <http://www.fixyourdlp.com>

Video Guides: <http://www.fixyourdlp.com/guides>

User Forums: <http://www.fixyourdlp.com/forum>

FixYourDLP's Fight Against Counterfeit Lamps:

<http://www.fixyourdlp.com/counterfeits>

## Sponsors:

RecycleYourLamp.org – Free lamp recycling services for used lamps:

<http://www.recycleyourlamp.org>

Lamp Research - The trusted 3rd party lamp research company:

<http://www.lampresearch.com>

Discount-Merchant.com – The worlds largest lamp distributor:

<http://www.discount-merchant.com>



**FixYourDLP.com**

Sponsored by 





EPSON®

# EMP-74/54 User's Guide

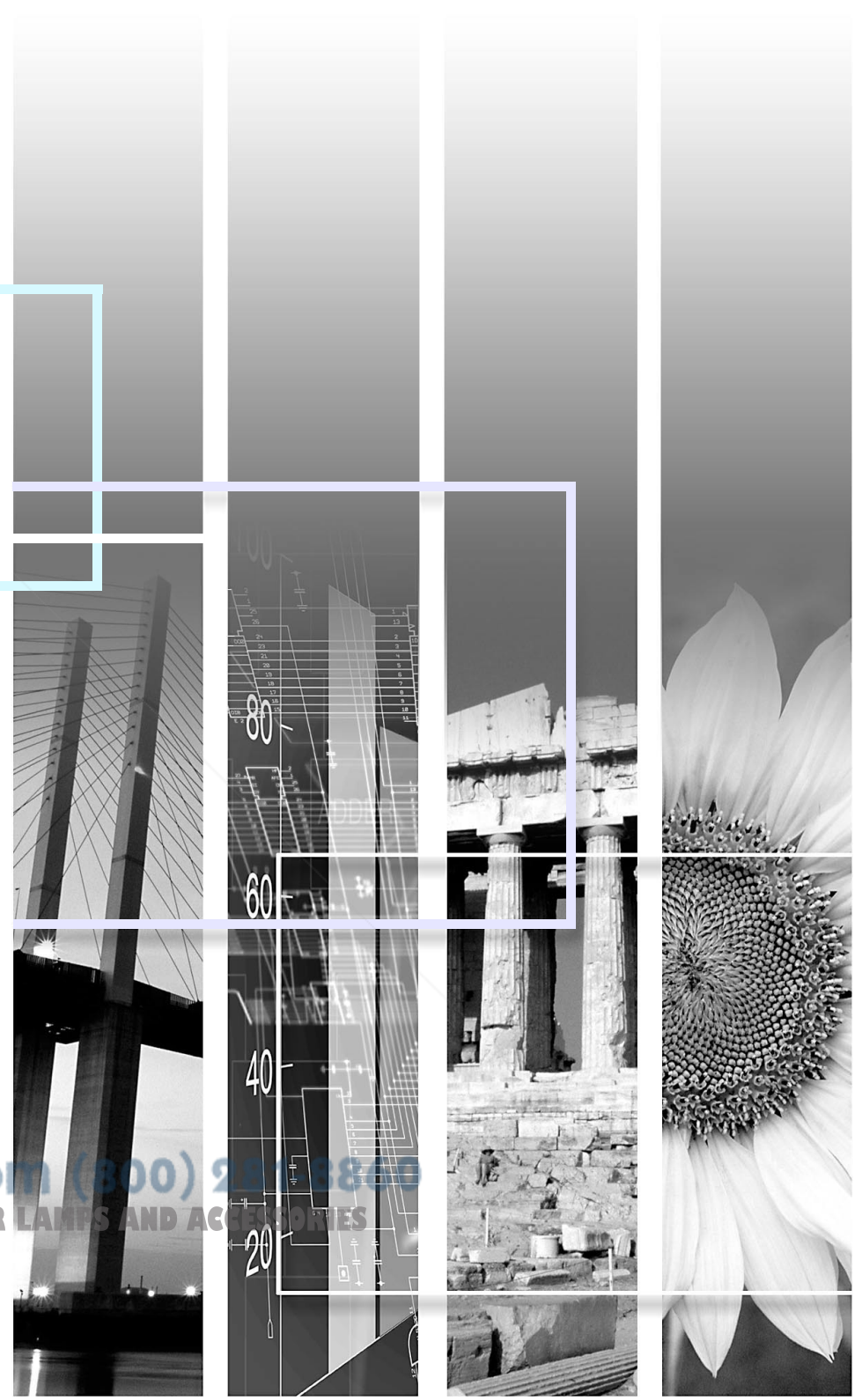
 FixYourDLP.com  
Sponsored by 

Discount-Merchant.com (800) 281-8855  
THE TRUSTED SOURCE FOR PROJECTOR LAMPS AND ACCESSORIES



 <b>CAUTION</b>	Indicates procedures which may result in damage or injury if sufficient care is not taken.
 <b>TIP</b>	Indicates additional information and points which may be useful to know regarding a topic.
	Indicates a page where useful information regarding a topic can be found. Click on the page number to display that page.
	Indicates that an explanation of the underlined word or words in front of this symbol appears in the glossary of terms. Click the underlined word or words to display the corresponding entry in the "Glossary" section of the "Appendices".  <a href="#">p.94</a>
<b>PROCEDURE</b>	Indicates operating methods and the order of operations. The procedure indicated should be carried out in the order of the numbers.

When "unit" or "projector" appears in the text of this *User's Guide*, it may refer to items which are accessories or optional equipment in addition to the main projector unit itself.

## Colour mode function

The following six preset colour modes are provided so that you can easily obtain the optimum images simply by selecting the image quality.

In addition, if projecting onto blackboards rather than projection screens in places such as schools, you can select the "Blackboard" setting to allow images to be projected in their natural tints.

Troublesome colour adjustments can thus be avoided.

☛ p.44, p.52, p.55

- Dynamic
- Presentation
- Theatre
- Living Room
- [sRGB](#)
- Blackboard

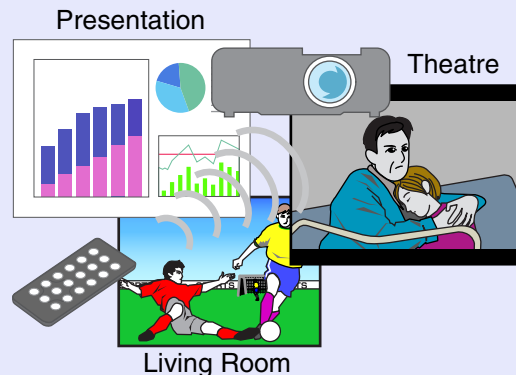

## Brightness Control

The brightness of the lamp can be set to one of two settings. If projecting images in a dark room or onto a small screen and the images are too bright, change the setting to "Low".

In addition, when the setting is changed to "Low", the amount of power consumed and noise produced are reduced and the operating life of the lamp can be extended.

- Reduction in power consumption of approximately 20%
- Reduction in operating noise of approximately 10%
- Approximately 1.5 times longer lamp life

☛ p.61

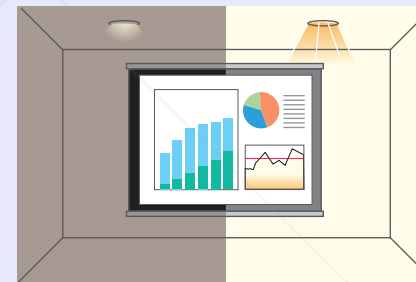

## Automatic keystone correction function

The vertical angle of the projector is detected, so that any vertical keystone distortion in the projected images can be automatically corrected. ☛ p.38

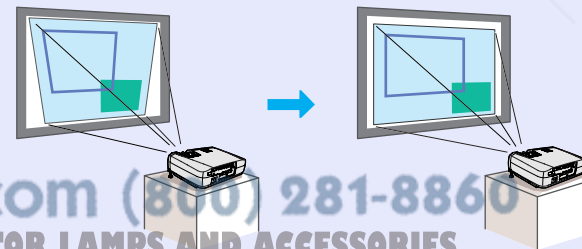

### Compact and lightweight while producing beautiful, crisp images

The projector has a compact body with a footprint the size of an A4 page (24 (D) × 31.5 (W) × 8.7 (H) cm (9.45 (D) × 12.4 (W) × 3.43 (H) in.) and is light in weight (approximately 2.9 kg. (6.4 lbs)), making it easy to carry. Clear and attractive images can be obtained even in bright locations.

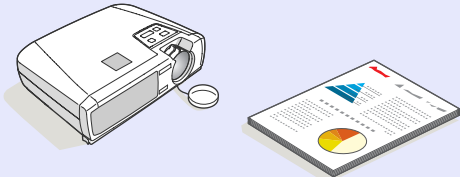

### Easy to Operate

The accessory remote control can be used for operations such as pausing projection (see "Freeze" on [p.47](#)) and zooming in on important areas of an image (see "E-Zoom" on [p.49](#)). In addition, the remote control can be used to move the pointer around on the computer screen during projection (see "Wireless Mouse Function" on [p.19](#)). If using the wireless mouse function, you can use the remote control to scroll back and forth through pages when projecting a PowerPoint presentation.

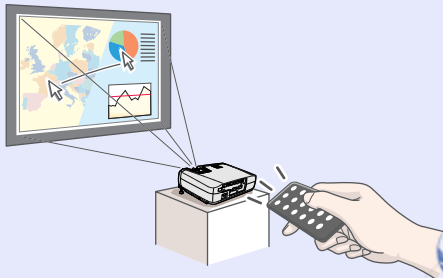

### Password protect function assists administration and theft prevention

If the password Protect function is employed, a password can be used to limit operation of the projector and changing of settings. This means that the projector cannot be used if it is taken without authorisation, and thus serves as a theft-prevention feature. [p.27](#)

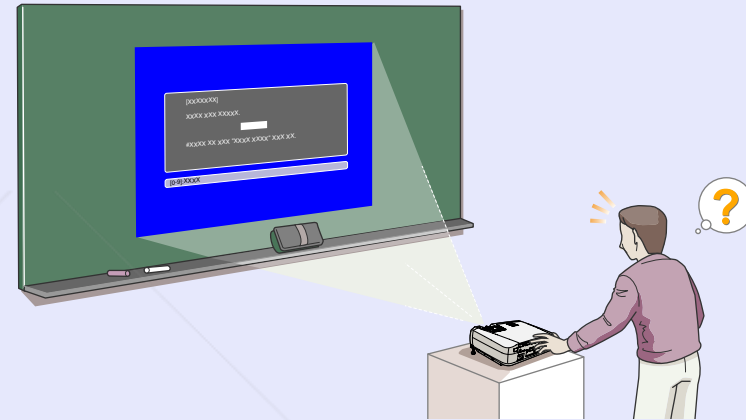

Notations Used in This User's Guide .....	1
Features of the Projector .....	2

## **Before Using the Projector**

---

Part Names and Functions .....	7
Front/Top .....	7
Control Panel .....	8
Rear .....	9
Base .....	10
Remote Control .....	11
Before Using the Remote Control .....	12
Using the Remote Control and Remote Operating Range .....	12
Installation .....	14
Setting Up the Projector .....	14
Screen Size and Projection Distance .....	15
Connecting to a Computer .....	16
Eligible Computers .....	16
Projecting Images from the Computer .....	17
Using the Remote Control to Operate the Mouse Pointer (Wireless Mouse Function) .....	19
Connecting to an External Monitor .....	21
Connecting to a Video Source .....	22
Projecting Composite Video Images .....	22
Projecting S-Video Images .....	23
Projecting Component Video Images .....	23
Projecting RGB Video Images .....	24
Playing Sound from the Video Equipment .....	25
Preventing theft (Password Protect) .....	27
When Password Protect is enabled .....	27
Setting Password Protect .....	28

## **Basic Operations**

---

Turning On the Projector .....	32
Connecting the Power Cable .....	32
Turning On the Power and Projecting Images .....	33
Turning Off the Projector .....	35
Adjusting the Screen Image .....	37
Adjusting the Image Size (Zoom Function) .....	37
Focusing the Screen Image .....	37
Adjusting the Image Angle and Automatic Keystone Correction Function .....	38
Manually Correcting Keystone Distortion .....	40
Adjusting the Image Quality .....	41
Adjusting Computer Images and RGB Video Images .....	41
Selecting the Projection Quality (Colour Mode Selection) .....	44

## **Advanced Operations**

---

Functions for Enhancing Projection .....	46
A/V Mute .....	46
Freeze .....	47
Wide-screen Projection of Images from Video Equipment (Changing the Aspect Ratio) .....	48
E-Zoom .....	49
Using the Configuration Menu Functions .....	50
List of Functions .....	51
Using the Configuration Menus .....	66



## Troubleshooting

---

Using the Help .....	69
Problem Solving .....	71
Reading the Indicators .....	71
When the Indicators Provide No Help .....	74

## Appendices

---

Maintenance .....	83
Cleaning .....	83
Replacing Consumables .....	84
Saving a User's Logo .....	90
Optional Accessories .....	93
Glossary .....	94
List of ESC/VP21 Commands .....	97
Command List .....	97
Communication Protocol .....	97
Cable Layouts .....	98
USB Connection Setup .....	99
List of Supported Monitor Displays .....	100
Specifications .....	101
Appearance .....	102
Index .....	103

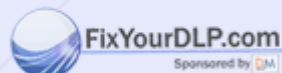

**Discount-Merchant.com (800) 281-8860**  
**THE TRUSTED SOURCE FOR PROJECTOR LAMPS AND ACCESSORIES**



# Before Using the Projector









This chapter describes the procedures for setting up the projector before use.

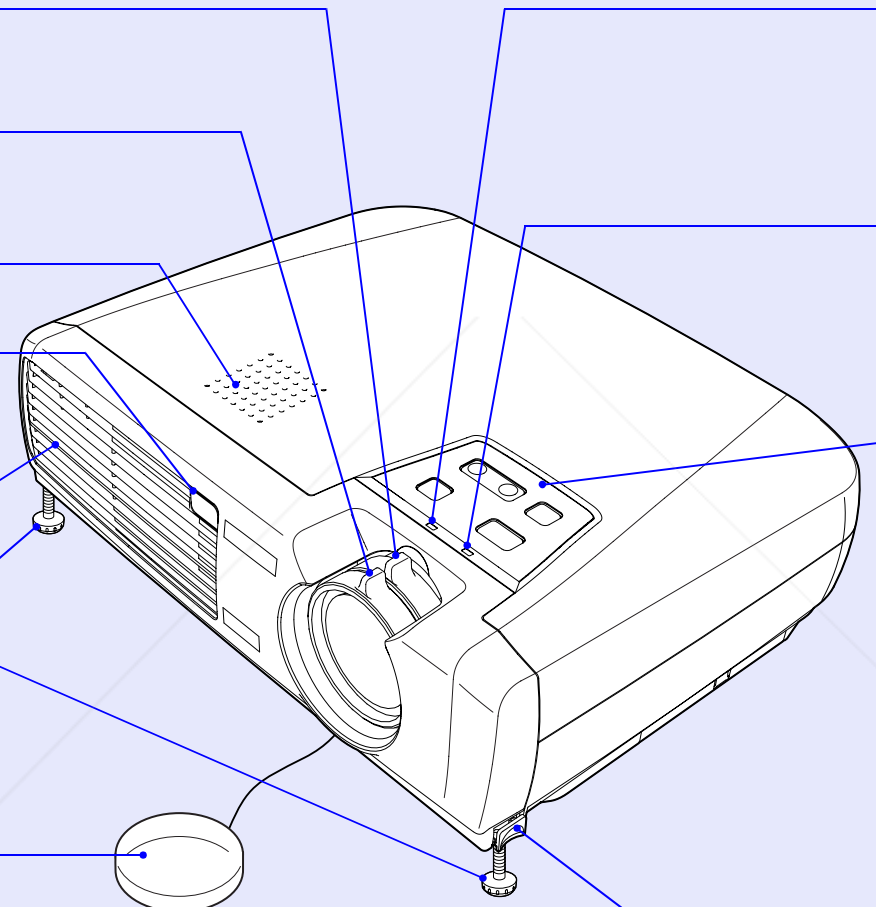

<b>Part Names and Functions.....</b>	<b>7</b>	<b>• Using the Remote Control to Operate the Mouse Pointer (Wireless Mouse Function) .....</b>	<b>19</b>
• Front/Top .....	7	<b>• Connecting to an External Monitor .....</b>	<b>21</b>
• Control Panel.....	8	<b>Connecting to a Video Source .....</b>	<b>22</b>
• Rear .....	9	• Projecting Composite Video Images .....	22
• Base.....	10	• Projecting S-Video Images.....	23
• Remote Control .....	11	• Projecting Component Video Images .....	23
<b>Before Using the Remote Control .....</b>	<b>12</b>	• Projecting RGB Video Images.....	24
• Using the Remote Control and Remote Operating Range .....	12	<b>Playing Sound from the Video Equipment.....</b>	<b>25</b>
• Using the Remote Control .....	12	<b>Preventing theft (Password Protect) .....</b>	<b>27</b>
• Remote Operating Range.....	13	• When Password Protect is enabled .....	27
<b>Installation .....</b>	<b>14</b>	• When "Power ON Protect" is enabled (ON) .....	27
• Setting Up the Projector .....	14	• When "User's Logo Protect" is enabled (ON).....	28
• Screen Size and Projection Distance.....	15	<b>• Setting Password Protect .....</b>	<b>28</b>
<b>Connecting to a Computer.....</b>	<b>16</b>		
• Eligible Computers .....	16		
• Projecting Images from the Computer.....	17		
• If the Monitor Port is a Mini D-Sub 15-pin Port .....	17		
• If the Monitor Port is a 13w3 Port.....	17		
• If the Monitor Port is a 5BNC Port.....	18		





## Front/Top

- 
- **Zoom ring**  [p.37](#)  
Adjusts the image size.
  - **Focus ring**  [p.37](#)  
Adjusts the image focus.
  - **Speaker**
  - **Remote control light-receiving area**  [p.12](#)  
Receives signals from the remote control.
  - **Air exhaust vent**
  - **Front adjustable foot**  [p.38](#)  
Extend and retract to adjust the projection angle when the projector is placed on a surface such as a shelf.
  - **Lens cover**  
Attach when not using the projector to prevent the lens from becoming dirt damaged.
  - **(Warning) indicator**  [p.72](#)  
The colour and ON status (illuminated/ flashing) indicates problems with the projector.
  - **Power indicator**  [p.71](#)  
Flashes or lights in different colours to indicate the operating status of the projector.
  - **Control panel**  [p.8](#)
  - **Foot adjust button**  [p.38](#)  
Another foot adjust button is located on the right side. Press both foot adjust buttons when extending and retracting the front adjustable feet.

 [FixYourDLP.com](#)  
Sponsored by 

[Discount-Merchant.com](#) (800) 291-2960  
THE TRUSTED SOURCE FOR PROJECTOR LAMPS AND ACCESSORIES

## Control Panel

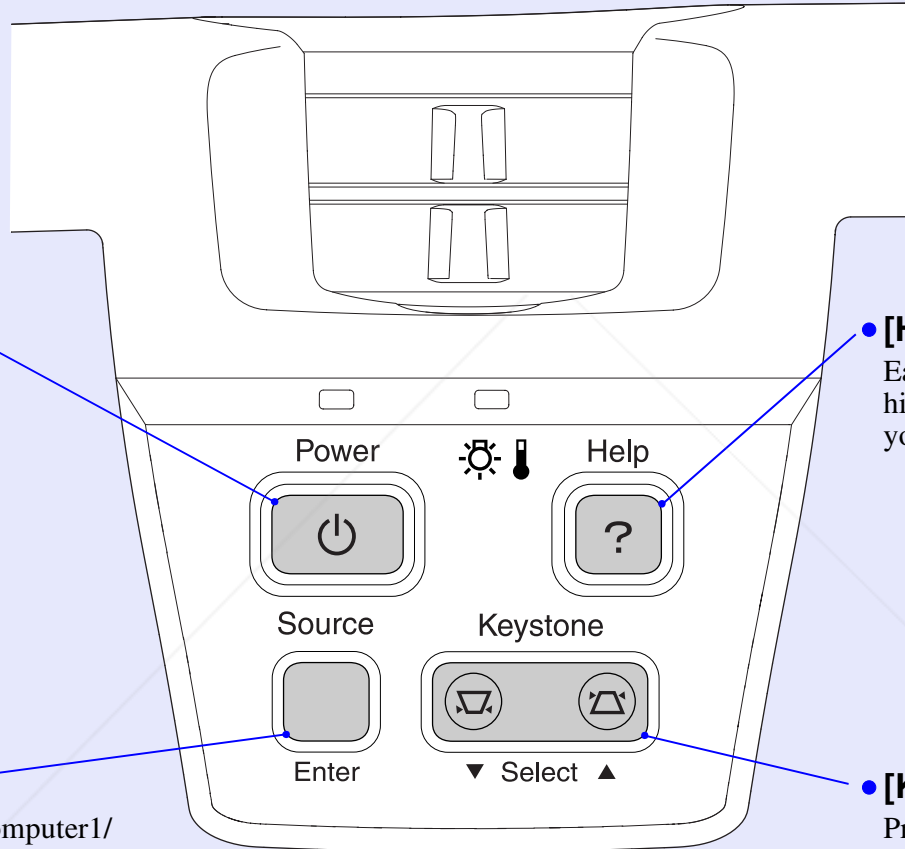

- **[Power] button**  [p.33, p.35](#)

Turns the projector power on and off.

- **[Help] button**  [p.69](#)

Each time this button is pressed, it displays and hides the online help menu that can assist you if you have a problem.

- **[Source] button**  [p.34](#)

Switches the input source between the [Computer1/Component Video1] port, [Computer2/Component Video2] port, [S-Video] port and [Video] port each time the button is pressed.

When pressed while a help menu is being displayed, it accepts the menu item that is currently selected.

 [p.69](#)

- **[Keystone] button**  [p.40](#)

Press to correct keystone distortion in images. When pressed while a help menu is being displayed, it selects items in the menu.  [p.69](#)

## Rear

- **[Computer1/Component Video1] port**
- **[Computer2/Component Video2] port**  
**p.17, p.23, p.24**

Input analogue RGB video signals from a computer and RGB video signals and [component video](#) signals from other video sources.

- **Remote control light-receiving area** **p.12**

Receives signals from the remote control.

- **Power inlet** **p.32**

Connects to the power cable.

- **[Audio1] port** **p.25**

Inputs audio signals from a computer, RGB video or component video equipment.

- **[Monitor Out] port** **p.21**

Outputs the projected analogue video signals or RGB video signals to an external monitor from the source that is connected to the [Computer1/Component Video1] port. This feature is not available for video equipment signals.

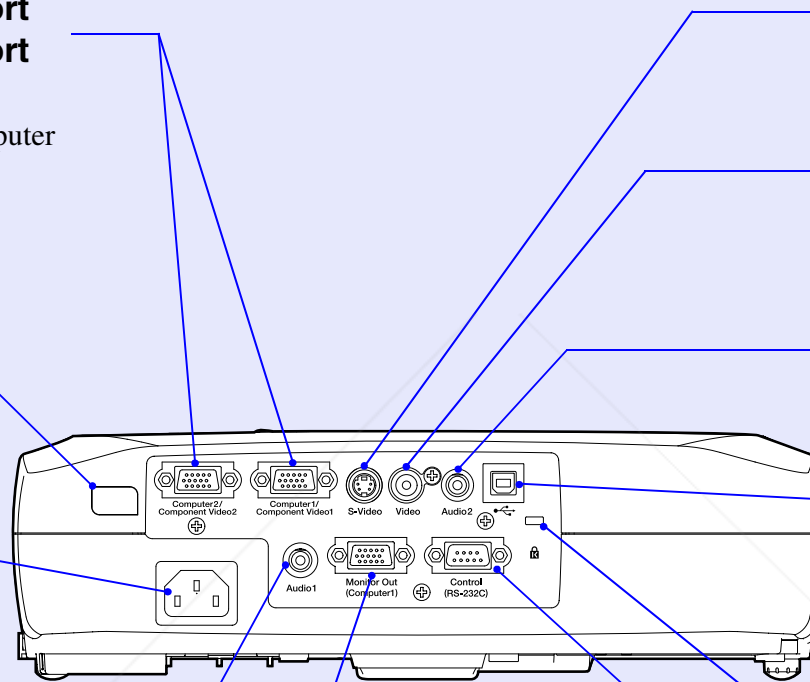

- **[S-Video] port** **p.23**

Inputs [S-Video](#) signals to the projector from other video sources.

- **[Video] port** **p.22**

Inputs [composite video](#) signals to the projector from other video sources.

- **[Audio2] port** **p.25**

Inputs audio signals from a video source.

- **[USB] port** **p.19, p.98**

Connects the projector to a computer via the USB cable when using the wireless mouse function. Computer images cannot be projected by the projector by using the USB cable to connect the computer.

- **Security lock** **p.95**

- **[Control (RS-232C)] port** **p.98**

Connects the projector to a computer using an RS-232C cable. This port is for control use and should not be used by the customer.

FixYourDLP.com  
Sponsored by DLP

Mount-Merchant.com (800) 281-8800  
THE TRUSTED SOURCE FOR PROJECTOR LAMPS AND ACCESSORIES

## Base

- **Suspension bracket fixing points (4 points)**

☞ p.14, p.102

Install the optional ceiling mount here when suspending the projector from a ceiling.

- **Air filter (air intake vent)**

☞ p.83, p.89

This prevents dust and other foreign particles from getting inside the projector when air is drawn in. It should be cleaned and replaced periodically.

- **Air intake vent** ☞ p.83

- **Lamp cover** ☞ p.86

Open this cover when replacing the lamp inside the projector.

- **Remote control holder** ☞ p.12



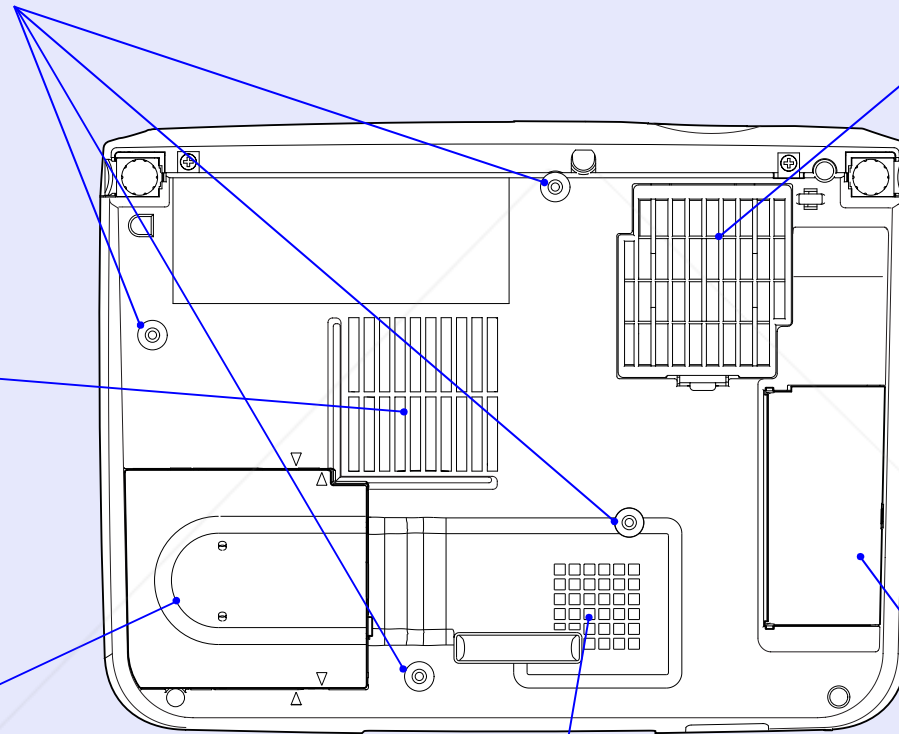







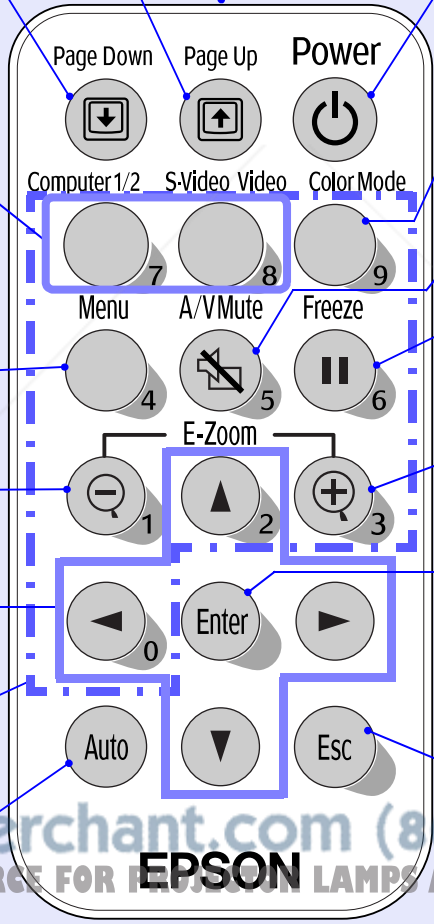





Store the accessory remote control in here when not using it.



- **Air intake vent** ☞ p.83

Clean the air filters periodically.

## Remote Control

- 
- **Remote control light-emitting area**  **p.12**  
Outputs remote control signals.
  - **[Page down]/[Page up] buttons**  **p.19**  
When using the remote control as a wireless mouse, press these buttons to scroll back and forth through pages in a PowerPoint file.
  - **Input select buttons**  **p.34**  
[Computer1/2]:  
Switches between images that are being input to the [Computer1/Component Video1] port and the [Computer2/Component Video2] port.  
[S-Video/Video]:  
Switches the signal source being input from the [S-Video] port and the [Video] port.
  - **[Menu] button**  **p.66**  
Displays and hides the configuration menu.
  - **[E-Zoom] button (⊖)**  **p.49**  
Reduces the part of images that have been enlarged using the [⊕] button.
  - **[▲][▼][←][→] buttons**  **p.20, p.66, p.69**  
When a configuration menu or help menu is displayed, these buttons select menu items and setting values.  
When pressed while using the wireless mouse function, it moves the pointer in the direction of
  - **Numeric buttons**  **p.27**  
Use these buttons to enter a password when using Password Protect.
  - **[Auto] button**  **p.41**  
Automatically adjusts and optimises analogue RGB computer video signals.
  - **[Power] button**  **p.33, p.35**  
Turns the projector power on and off.
  - **[Color Mode] button**  **p.44**  
Selects the colour mode. The colour mode changes in the order of Dynamic, Presentation, Theatre, Living Room, **sRGB** and Blackboard each time the button is pressed.
  - **[A/V Mute] button**  **p.46**  
The audio and video are turned on or off each time the button is pressed.
  - **[Freeze] button**  **p.47**  
Images are paused or unpaused each time the button is pressed.
  - **[E-Zoom] button (⊕)**  **p.49**  
Enlarges parts of images without changing the size of the projection area.
  - **[Enter] button**  **p.20, p.66, p.69**  
Accepts a menu or help item or displays the next screen or menu when viewing a configuration menu or help menu. Acts as a mouse left-click when using the wireless mouse function.
  - **[Esc] button**  **p.20, p.67**  
Stops the current function.  
Displays the previous screen or menu while viewing a configuration menu.  
Acts as a mouse right-click when using the wireless mouse function.

## Using the Remote Control and Remote Operating Range

When using the remote control for the first time, pull out the insulating tape that is protruding from the battery holder. When the insulating tape is pulled out, the remote control can then be used.

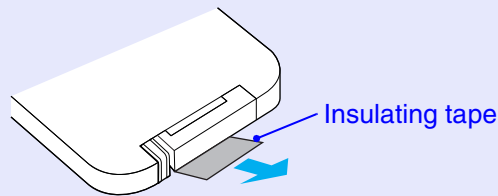

## Using the Remote Control

The remote control is used in the following way.

### PROCEDURE

Point the remote control light-emitting area toward one of the remote control light-receiving areas on the projector and operate the remote control buttons.

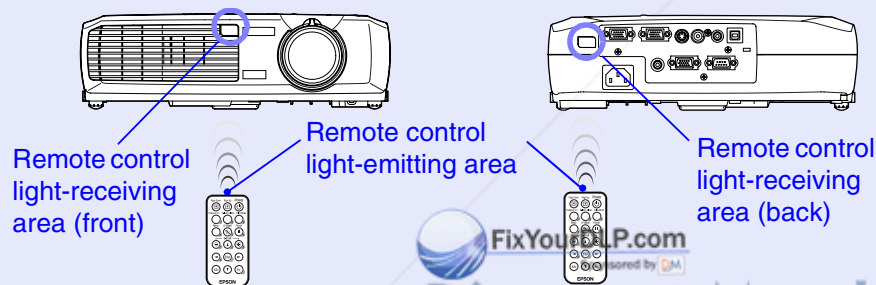

### TIP

- Do not allow sunlight or light from fluorescent lamps to shine directly onto the projector's remote control light-receiving areas, otherwise it may interfere with the reception of signals from the remote control.
- If delays in the responsiveness of the remote control occur or if it does not operate after it has been used for some time, it probably means that the battery is getting flat. If this happens, replace the battery with a new one. [p.84](#)
- When not using the remote control, place it into the remote control holder underneath the projector so that it does not get lost.

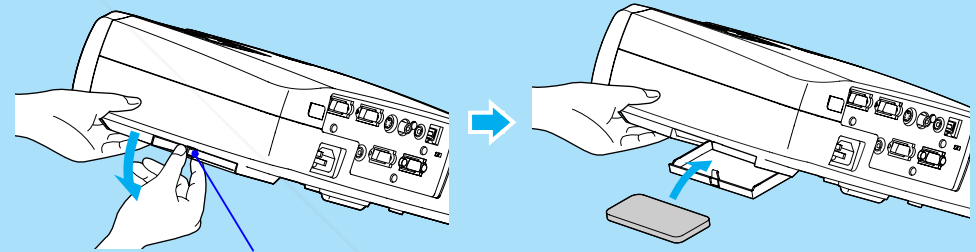

Hook a finger into the middle of the remote control holder and pull it downwards.

After placing the remote control into the holder, push the remote control holder in until it clicks into place.

### Remote Operating Range

Use the remote control within the ranges indicated below. If the distance or angle between the remote control and the remote control light-receiving area is outside the normal operating range, the remote control may not work.

Operating distance	Operating angle
Approx. 6 m (20 ft.)	Approx. $\pm 30^\circ$ horizontally Approx. $\pm 15^\circ$ vertically

Operating angle (horizontal)

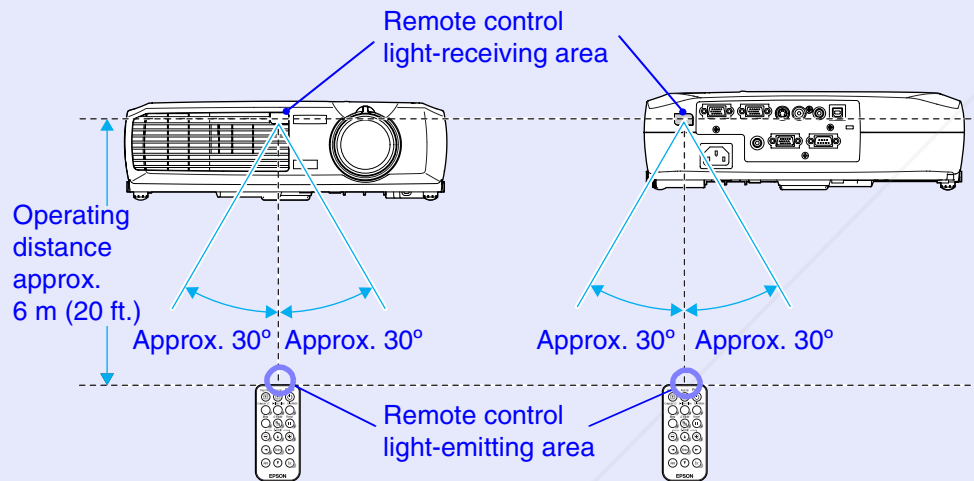

Operating angle (vertical)

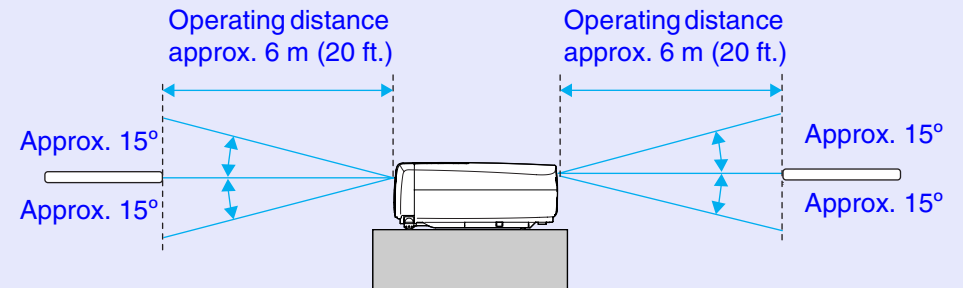

When suspended from the ceiling

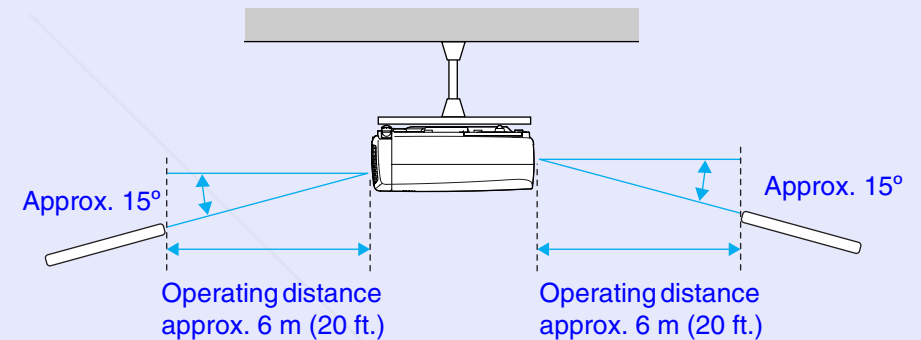

## Setting Up the Projector

The projector supports the following four different projection methods, allowing you to choose the best method for displaying your images.



### CAUTION

*Before setting up the projector, be sure to first read the separate Safety Instructions/World-Wide Warranty Terms.*

- Front projection (Front projection)

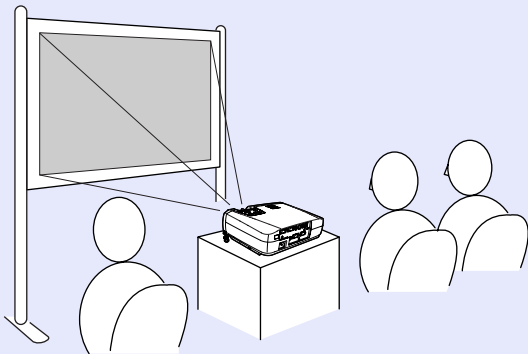

- Rear projection using a translucent screen (Rear projection)

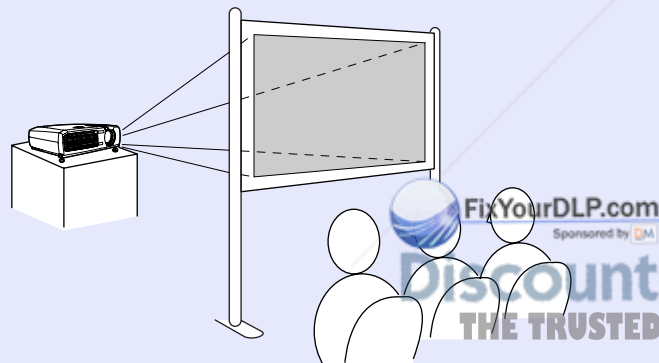

- Front/ceiling projection (Front/Ceiling projection)

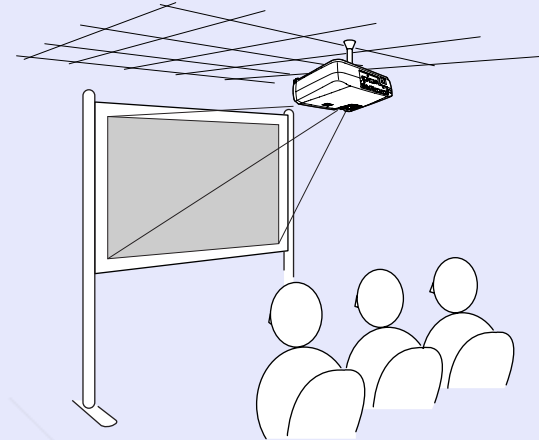

- Rear/ceiling projection using a translucent screen (Rear/Ceiling projection)

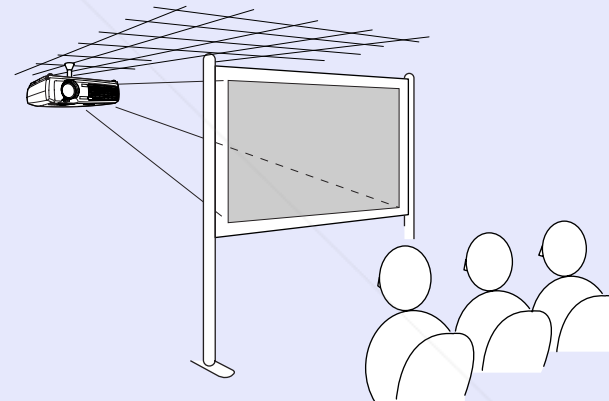

\* A special method of installation is required for suspending the projector from the ceiling. Please contact your supplier if you would like to use this installation method. The optional ceiling mount is required when installing the projector on the ceiling. 🗨️ p.93



### TIP

*When using ceiling projection or projection using a translucent screen, set the "Projection" command in the "Advanced" menu to match the installation method. 🗨️ p.62*



## Screen Size and Projection Distance

The distance between the projector's lens and the screen determines the actual image size.

<b>Recommended distance</b>	89–1050 cm (2.9–34.4 ft.)
-----------------------------	---------------------------

While referring to the following table, position the projector so that the images are projected onto the screen at the optimum size.

The values should be used as a guide for setting up the projector. The actual values will vary depending on projection conditions and the zoom setting.

4:3 Screen size (cm (in.))	Projection distance A (cm (ft.))		Distance from centre of lens to bottom edge of screen B (cm (in.))
	Shortest (wide)	Longest (tele)	
30" (61 × 46 (24.0 × 18.1))	89 (2.9)	103 (3.4)	4 (1.6)
40" (81 × 61 (31.9 × 24.0))	120 (3.9)	138 (4.5)	6 (2.2)
50" (100 × 76 (39.4 × 30.0))	151 (4.9)	173 (5.7)	7 (2.7)
60" (120 × 90 (47.2 × 35.4))	181 (5.9)	208 (6.8)	8 (3.3)
80" (160 × 120 (63.0 × 47.2))	243 (8.0)	278 (9.1)	11 (4.4)
100" (200 × 150 (78.7 × 59.1))	304 (10.0)	349 (11.4)	14 (5.5)
200" (410 × 300 (161.4 × 118.1))	610 (20.0)	699 (22.9)	28 (10.9)
300" (610 × 460 (240.2 × 181.1))	916 (30.1)	1050 (34.4)	42 (16.4)

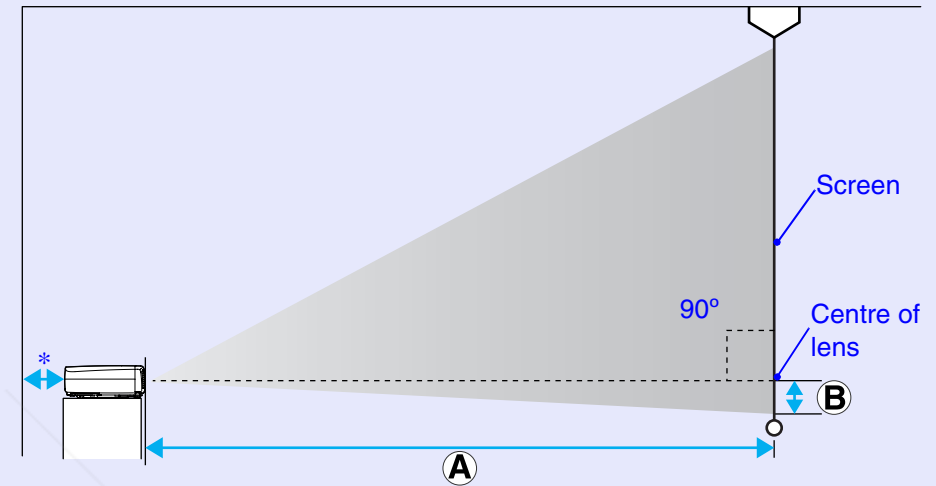

\* When installing against a wall, leave a space of about 20 cm (7.9 in.) between the projector and the wall.



**TIP**

- *The projector's lens allows a zoom ratio of up to about 1.2. The image size at the maximum zoom setting is about 1.2 times bigger than the image size at the minimum zoom setting.*
- *The image size will be reduced when keystone correction is carried out.*

## CAUTION

*When connecting the projector to a computer, be sure to check the following.*

- *Turn off the power for both the projector and the computer before connecting them. If the power for either device is on at the time of connection, damage may result.*
- *Check the shapes of the cable connectors and the device ports before making the connections. If you try to force a connector to fit a device port with a different shape or number of terminals, damage to the connector or port may result.*
- *Do not bind the power cable and the connecting cable together. If the power cable and the connecting cable are bound together, image interference or errors in operation may result.*

## Eligible Computers

The projector cannot be connected to some types of computer, or projection of images may not be possible even if actual connection is possible. Make sure that the computer you intend to use satisfies the conditions given below.

- **Condition 1:** The computer must have an image signal output port. Check that the computer has a port such as an "RGB port", "monitor port" or "CRT port" which can output image signals. If the computer has a built-in monitor, or if using a laptop computer, it may not be possible to connect the computer to the projector, or alternatively you may need to purchase a separate external output port. Refer to the documentation for your computer under a heading such as "Connecting an external monitor" or similar for further details.
- **Condition 2:** The display resolution and frequency of the computer must be listed in the "List of Supported Monitor Displays". See "Appendices: List of Supported Monitor Displays"  p.100. Some computers allow you to change the output resolution, so if necessary, change the resolution to one that matches a setting in the "List of Supported Monitor Displays", while referring to the documentation provided with the computer.

## TIP

- *You may need to purchase a separate adapter depending on the shape of the computer's port. Refer to the documentation provided with the computer for further details.*
- *If the computer and projector are too far away from each other for the accessory computer cable to reach, use the optional VGA-HD15 PC cable. See "Appendices: Optional Accessories"  p.93*

## Projecting Images from the Computer

The shape and specifications of the computer's monitor port will determine what type of cable should be used. Check the following to see which type of port your computer has.

### ■ If the Monitor Port is a Mini D-Sub 15-pin Port

Use the accessory computer cable to make the connection.

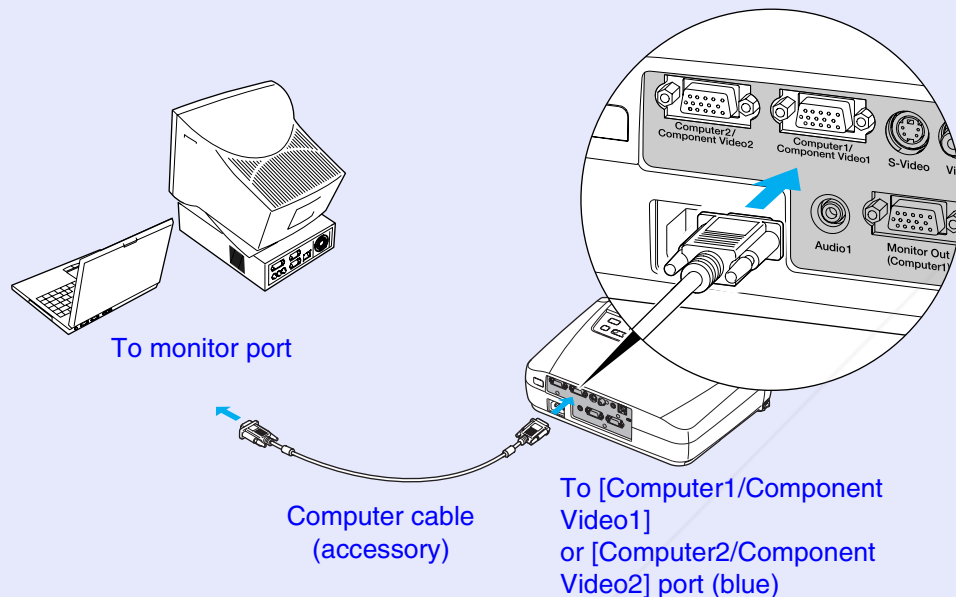

### ■ If the Monitor Port is a 13w3 Port

Some workstation-type computers have a 13w3 monitor port. In such cases, use a commercially-available 13w3 ⇔ D-Sub 15-pin cable to make the connection.

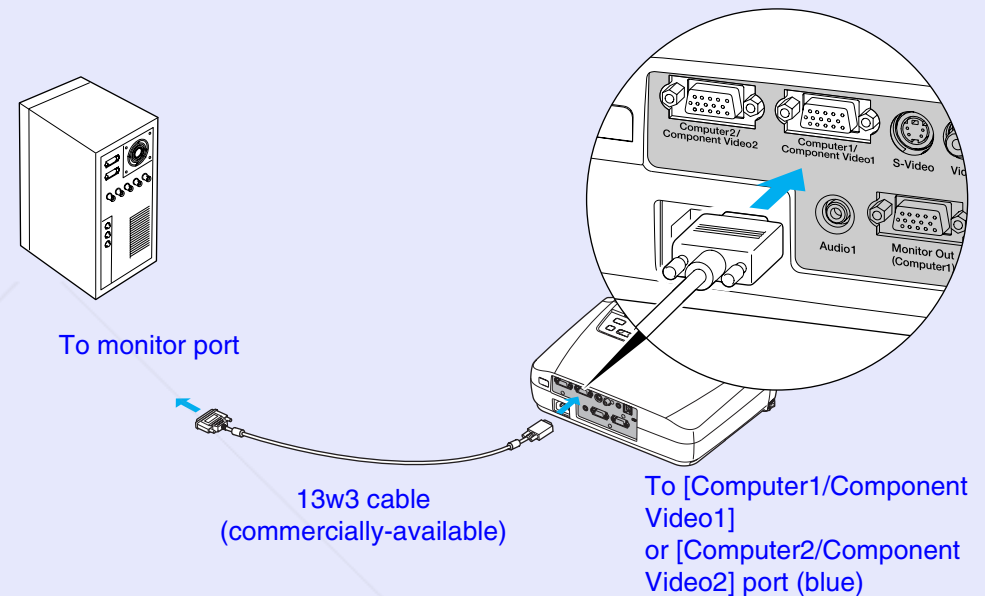

TIP

- After projection starts, change the "Input Signal" setting in the "Image" menu to either "Computer1" or "Computer2" to match the signals from the port being used for the connection. [p.52](#)
- If more than one external component is connected to the projector, after projection starts, use the [Computer1/2] button on the remote control or the [Source] button on the projector's control panel to select the Computer port as the input source. [p.34](#)



TIP

- After projection starts, change the "Input Signal" setting in the "Image" menu to either "Computer1" or "Computer2" to match the signals from the port being used for the connection. [p.52](#)
- If more than one external component is connected to the projector, after projection starts, use the [Computer1/2] button on the remote control or the [Source] button on the projector's control panel to select the Computer port as the input source. [p.34](#)
- Some workstations may require a special cable. Consult the workstation manufacturer for further details.

■ If the Monitor Port is a **5BNC»** Port

Use the optional VGA- HD15/BNC PC Cable to make the connection.

See "Appendices: Optional Accessories" ➡ p.93

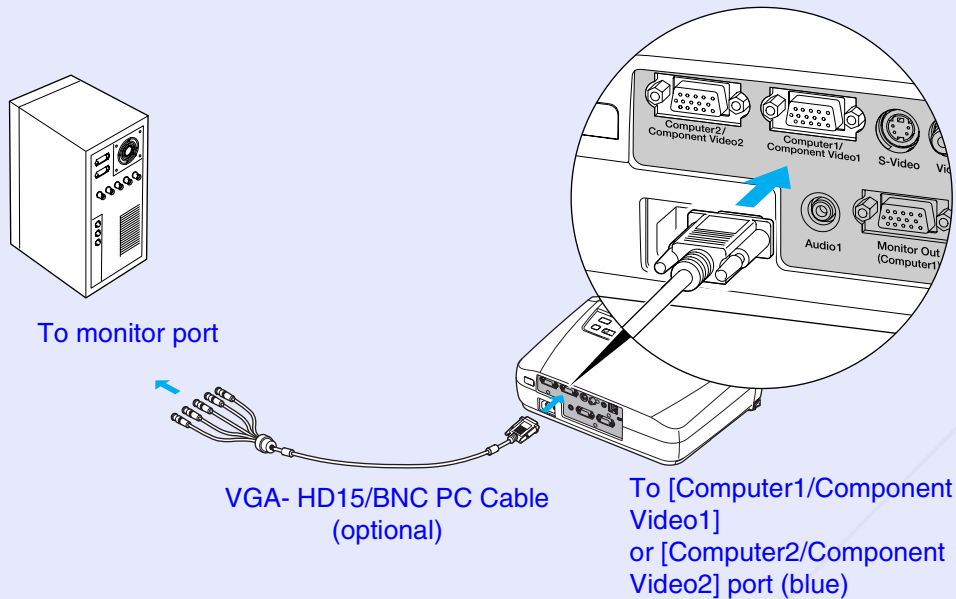

**TIP**

- After projection starts, change the "Input Signal" setting in the "Image" menu to either "Computer1" or "Computer2" to match the signals from the port being used for the connection. ➡ p.52
- If more than one external component is connected to the projector, after projection starts, use the [Computer1/2] button on the remote control or the [Source] button on the projector's control panel to select the Computer port as the input source ➡ p.34

## Using the Remote Control to Operate the Mouse Pointer (Wireless Mouse Function)

You can use the remote control as a wireless mouse to control the mouse pointer on the computer screen. To do this, you must use the accessory [USB](#) cable to connect the USB port of the computer to the [USB] port at the rear of the projector.

Computer	Mouse used	Applicable cable
Windows 98/2000/Me/XP Home Edition/XP Professional	USB mouse	USB cable (accessory)
Macintosh (OS 8.6–9.2/X/10.0–10.2)	USB mouse	USB cable (accessory)

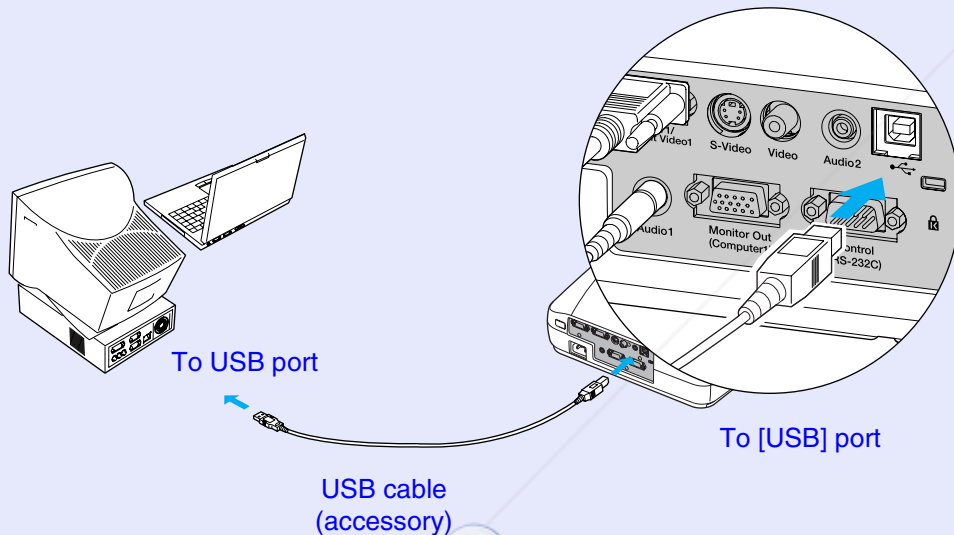

**TIP**

- *The USB cable can only be connected to computers with a standard USB interface. If using a computer which is running Windows, the computer must have had a full version of Windows 98/2000/Me/XP Home Edition/XP Professional installed. If the computer is running a version of Windows 98/2000/Me/XP Home Edition/XP Professional that has been upgraded from an earlier version of Windows, correct operation cannot be guaranteed.*
- *It may not be possible to use the mouse function under some versions of both the Windows and Macintosh operating systems.*
- *Some computer settings may have to be changed in order for the mouse function to be used. Consult the documentation for the computer for further details.*

\* When using the remote control wireless mouse, the [Page down] and [Page up] buttons on the remote control can be used to scroll back and forth through pages when projecting a PowerPoint presentation.



Once the connection has been made, the mouse pointer can be operated as follows.

### Moving the mouse pointer

Press the [▲], [▼], [◀] or [▶] button to move the mouse pointer in the direction of the button pressed.

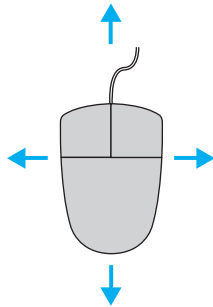
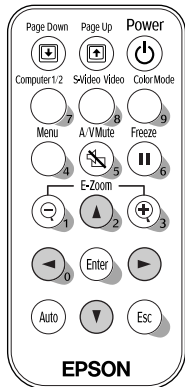

### Left click

Press the [Enter] button. If you press the [Enter] button twice in rapid succession, it has the effect of a double-click.

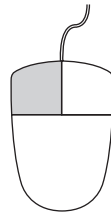
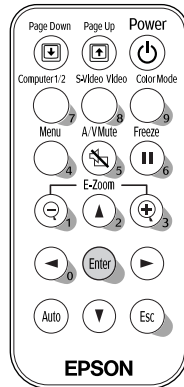

### Right click

Press the [Esc] button.

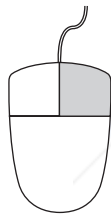
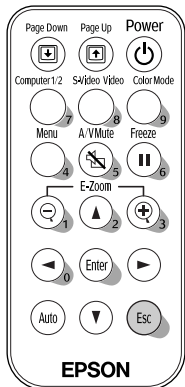

### Drag and drop

While holding down the [Enter] button, press the [▲], [▼], [◀] or [▶] button to drag items. Release the [Enter] button to drop the items being dragged at the desired position.

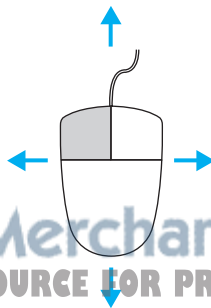

### TIP

- If the mouse button settings have been reversed at the computer, the operation of the remote control buttons will also be reversed.
- The wireless mouse function cannot be used while the following functions are being used.
  - While a configuration menu is being displayed
  - While a help menu is being displayed
  - While the E-Zoom function is being used
  - While a user's logo is being captured



## Connecting to an External Monitor

Analogue RGB images and RGB video images from a computer that are being input to the [Computer1/Component Video1] port can be viewed on an external computer monitor at the same time they are being projected by the projector, so that the images can be checked at times such as when giving presentations.

If the images being projected are from a source that is connected to the [Computer2/Component Video2] port, these images cannot be output to an external monitor.

Connect the external monitor using the cable that is provided with the monitor.

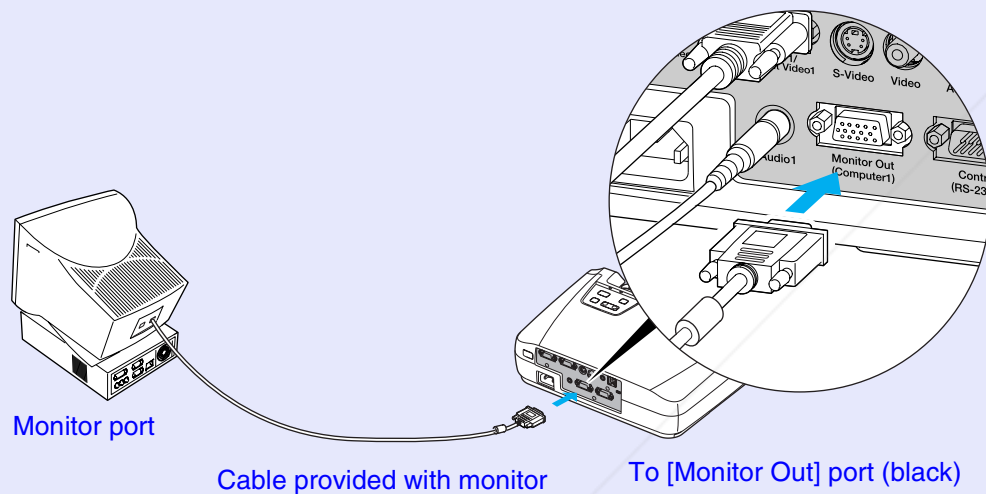
**TIP**

- *Video images cannot be output to an external monitor.*
- *The setting gauge for keystone correction and the configuration menus and help menus are not output to the external monitor.*



FixYourDLP.com

Sponsored by

 Discount-Merchant.com (800) 281-8860  
 THE TRUSTED SOURCE FOR PROJECTOR LAMPS AND ACCESSORIES

## CAUTION

When connecting the projector to other video sources, take the following precautions.

- Turn off the power for both the projector and the video source before connecting them. If the power for either device is on at the time of connection, damage may result.
- Check the shapes of the cable connectors and the device ports before making the connections. If you try to force a connector to fit a device port with a different shape or number of terminals, a malfunction or damage to the connector or port may result.
- Do not bind the power cable and the connecting cable together. If the power cable and the connecting cable are bound together, image interference or errors in operation may result.

## Projecting Composite Video Images

Use the accessory A/V cable to make the connection.

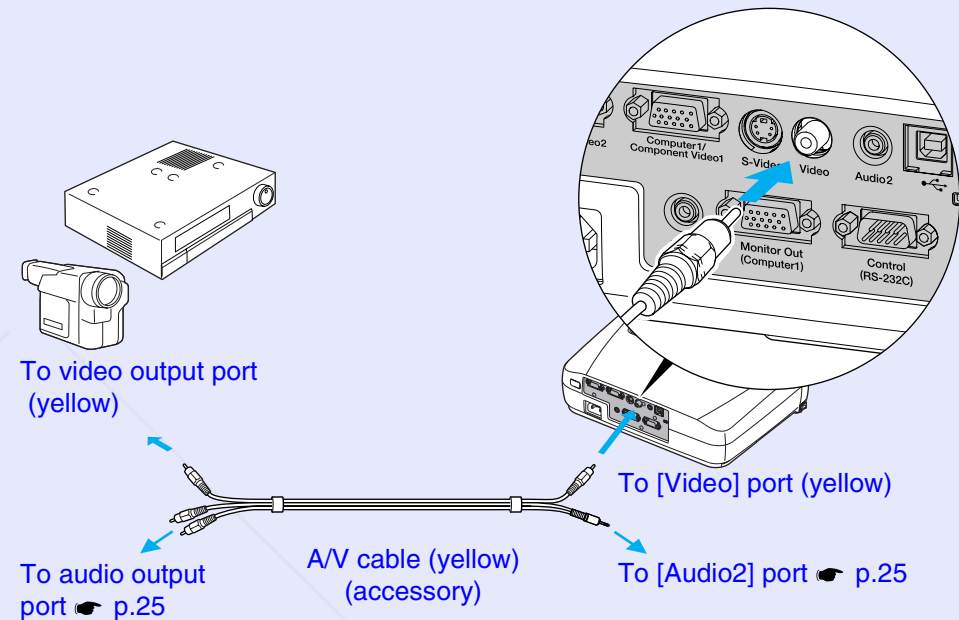

## TIP

If more than one external component is connected to the projector, after projection starts, press the [S-Video/Video] button on the remote control or the [Source] button on the projector's control panel until "Video" is displayed in the projected image. [p.34](#)



### Projecting S-Video Images

Use a commercially-available [S-Video](#) cable to make the connections.

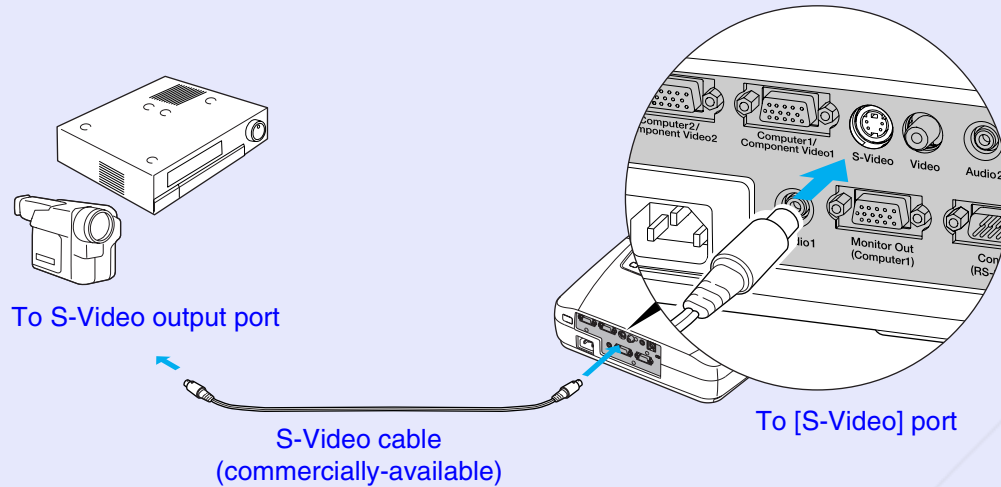

### Projecting Component Video Images

Use the optional [component video](#) cable to make the connection. See "Appendices: Optional Accessories" [p.93](#)

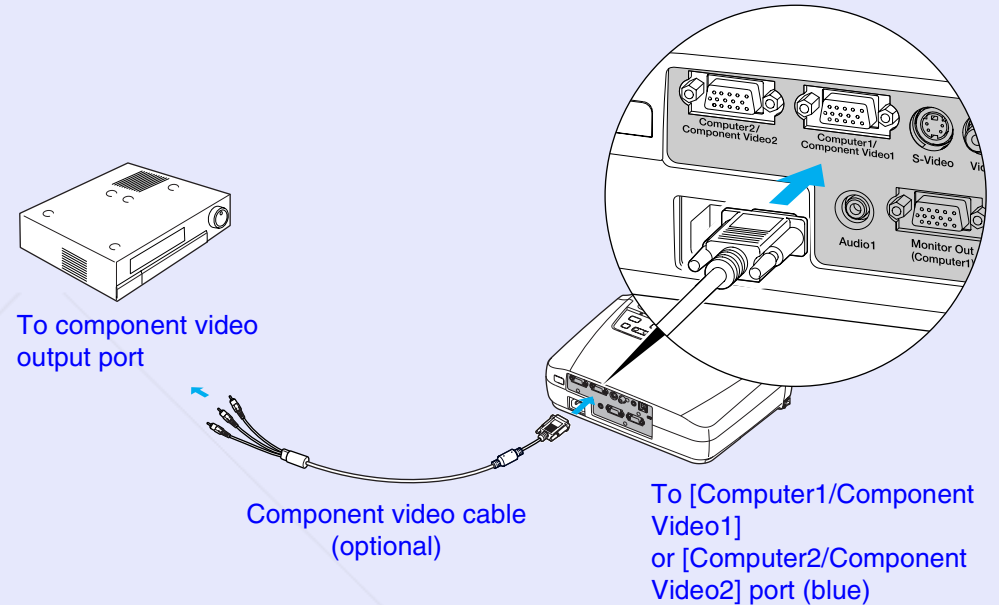

**TIP**

*If more than one external component is connected to the projector, after projection starts, press the [S-Video/Video] button on the remote control or the [Source] button on the projector's control panel until "S-Video" is displayed in the projected image. [p.34](#)*

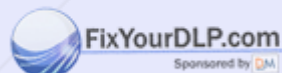

**Discount-Merchant.com (800) 281-8860**  
THE TRUSTED SOURCE FOR PROJECTOR LAMPS AND ACCESSORIES





## TIP

- If the source is connected to the [Computer1/Component Video1] port, after projection starts, change the "Input Signal" setting in the "Image" menu to either "Component Video1 (YCbCr)" or "Component Video1 (YPbPr)" to match the signals from the video equipment. [p.55](#)
- If the source is connected to the [Computer2/Component Video2] port, after projection starts, change the "Input Signal" setting in the "Image" menu to either "Component Video2 (YCbCr)" or "Component Video2 (YPbPr)" to match the signals from the video equipment. [p.55](#)
- If more than one external component is connected to the projector, after projection starts, press the [Computer1/2] button on the remote control or the [Source] button on the projector's control panel to select the signal being input until "Component Video1 (YCbCr)", "Component Video1 (YPbPr)", "Component Video2 (YCbCr)" or "Component Video2 (YPbPr)" is displayed in the projected image. [p.34](#)

## Projecting RGB Video Images

Use the accessory computer cable to make the connections.

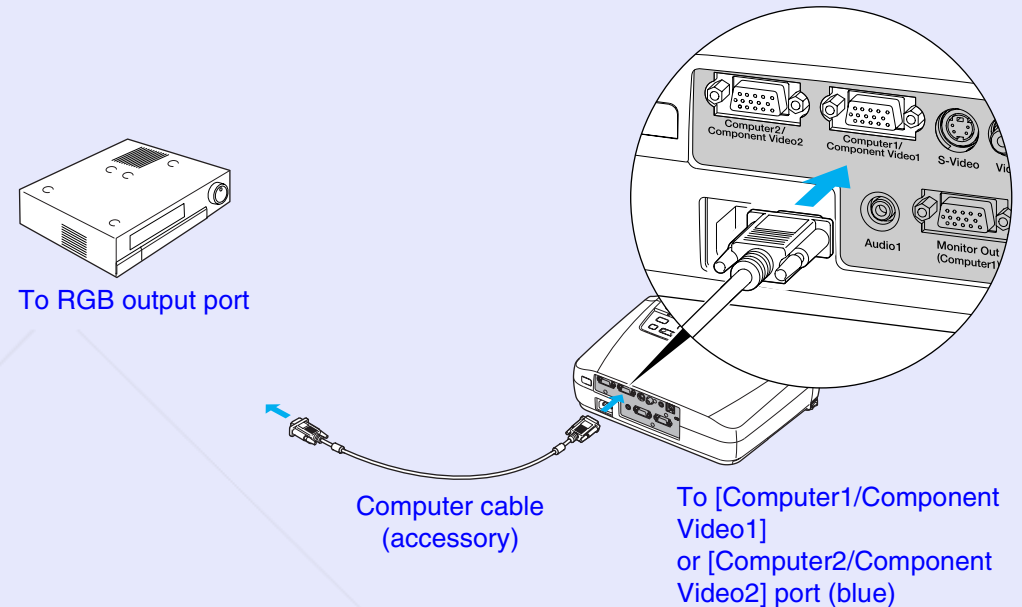

## TIP

- After projection starts, change the "Input Signal" setting in the "Image" menu to either "Computer1" or "Computer2" to match the signals from the port being used for the connection. [p.52](#)
- If more than one external component is connected to the projector, after projection starts, use the [Computer1/2] button on the remote control or the [Source] button on the projector's control panel to select the signal to be projected so that "Computer1" or "Computer2" is displayed on the screen. [p.34](#)



The projector has a built-in speaker with a maximum output of 1 W. You can output sound from the connected video equipment (such as a computer or video deck) through the projector's built-in speaker if the video equipment has an audio output port.

Select the audio cable that is used for this connection from the following, depending on the shape of the other equipment's port.

- If connecting to a stereo mini jack (such as the audio output port of a computer): Use a commercially-available stereo mini jack audio cable to make the connection.
- If connecting to an RCA pin jack ×2 (red/white) (such as the audio output port of video equipment): Use the accessory A/V cable to make the connection.

The default setting for the "Audio Input" command in the "Audio" menu is "Audio1" when analogue RGB images from a computer or RGB video images or component video images are being input, and "Audio2" when composite video and S-Video images are being input. Change the setting depending on the equipment being connected, or select the appropriate audio input port.

## When connecting to the [Audio1] port

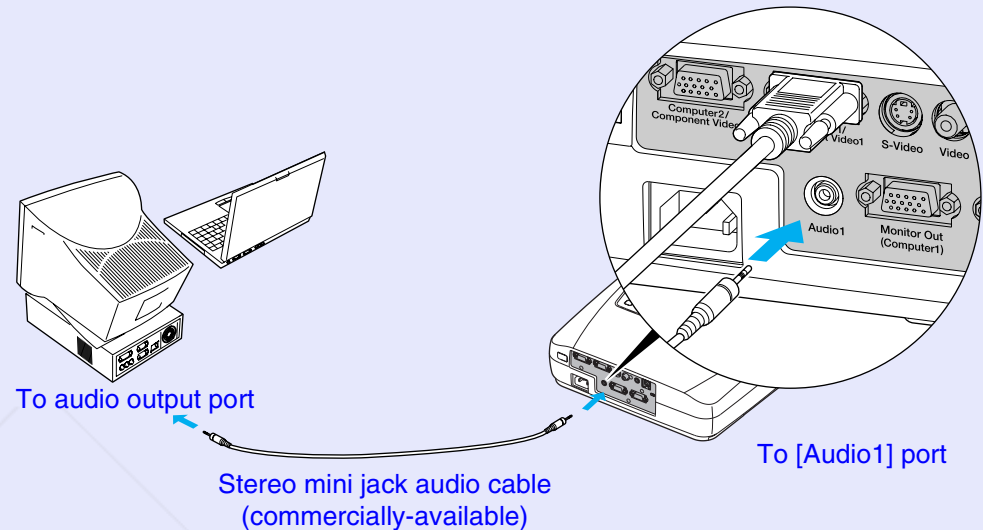

## When connecting to the [Audio2] port

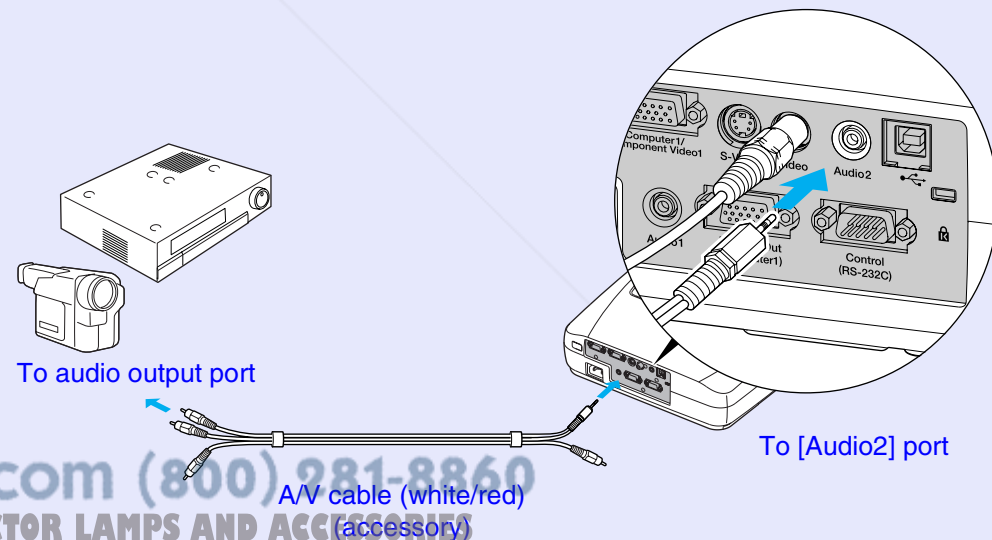

**TIP**

- You can adjust the volume after projection has started. [p.26](#)
- If using a commercially-available 2RCA (L/R)/stereo mini-jack audio cable, use one that is marked as "No resistance".



Use the following procedure to adjust the volume of the sound output.

**PROCEDURE**

- 1 Press the [Menu] button on the remote control, and then select "Volume" from the "Audio" menu.**

For details on this operation, refer to "Using the Configuration Menus". [p.66](#)

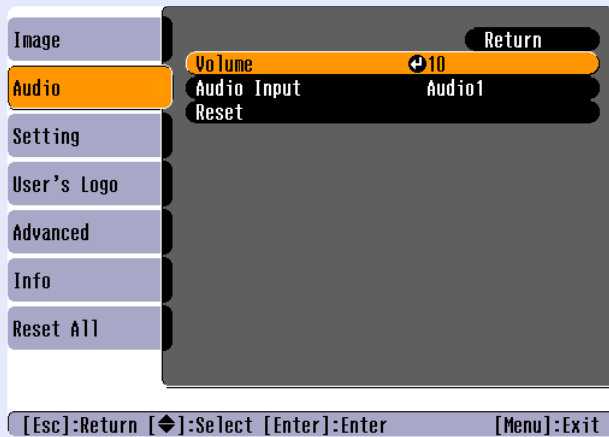

- 2 Use the [◄] and [►] buttons to adjust the volume.**

The volume is increased or reduced each time a button is pressed.



- 3 After making the adjustment, press the [Menu] button to exit the configuration menu.**



When the Password Protect function is activated, people who do not know the password cannot use the projector to project images when the power is turned on. Furthermore, the company logo and administrator's name that are displayed when the power is turned on cannot be changed. This means that the projector cannot be used if it is taken without authorisation, and thus serves as a theft-prevention feature.

## When Password Protect is enabled

### ■ When "Power ON Protect" is enabled (ON)

When the power is turned on, the password entry screen is displayed. The buttons shown in the frame below operate as numeric keypad buttons while the password entry screen is displayed.

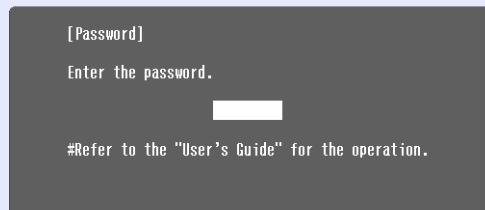

[0-9]:Enter

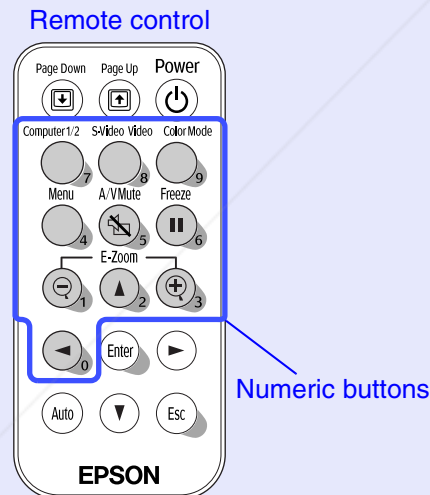

Use the numeric keypad buttons to enter the password that has been set. If the password is entered correctly, projection will then start.



### TIP

- ***If an incorrect password is entered three times in succession, the message "The projector's operation will be locked." will be displayed for approximately five minutes, and then the projector will switch to standby mode. If this happens, disconnect the power plug from the electrical outlet and then reinsert it and turn the projector's power back on. A window requesting you to enter the password will be displayed, so enter the correct password. If you happen to forget the password, make a note of the "request code: xxxx" number that appears in the Password screen and contact the nearest address provided in the "International Warranty Conditions" section of the Safety Instructions/World-Wide Warranty Terms booklet.***
- ***If the above operation should happen to be repeated nine times without a correct password being entered, the following message will be displayed and the projector's power will not be able to be turned on. "The projector's operation will be locked. Contact the nearest address provided in the "International Warranty Conditions" section of the Safety Instructions/World Wide Warranty Terms booklet."***



FixYourDLP.com

DiscountMerchant.com (800) 281-8860

THE TRUSTED SOURCE FOR PROJECTOR LAMPS AND ACCESSORIES

### When "User's Logo Protect" is enabled (ON)

If an attempt is made to carry out any of the following user logo operations, a message is displayed and the setting can not be changed. To change the setting, set "User's Logo Protect" to "OFF" first.  p.29

- Capturing a user's logo
- Changing the setting for the "Background Color" command in the "Setting" menu from "Logo" to "Black" or "Blue", or from "Black" or "Blue" to "Logo"
- Changing the "Startup Screen" setting in the "Advanced" menu ("ON" or "OFF")

## Setting Password Protect

Use the following procedure to set Password Protect.

### PROCEDURE

#### 1 Hold down the [Freeze] button for approximately 7 seconds.

The "Password Protect" menu will be displayed.

Remote control

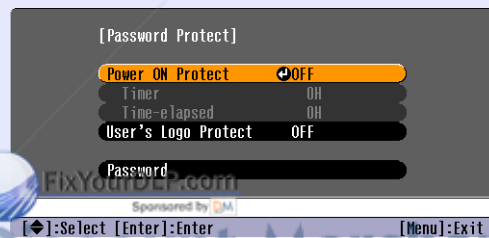
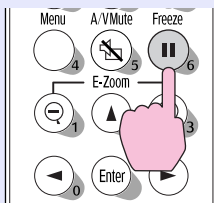

### TIP

- If Password Protect has already been enabled, the "Password" screen will be displayed.  
If the password has been entered correctly, the "Password Protect" menu will be displayed.  
See "When Password Protect is enabled"  p.27
- If Password Protect is set to "ON", attach the accessory Password Protect sticker to your preferred position on the projector as a theft-prevention measure.

#### 2

#### Turn "Power ON Protect" on.

- (1) Select "Power ON Protect", and then press the [Enter] button.
- (2) Select "ON", and then press the [Enter] button.
- (3) Press the [Esc] button.

The next time the "Timer" setting is made, you can set the time that the projector can be used without needing to enter a password.

If setting the time, continue on to the next step. If not setting the time, continue on to step 5.



### TIP

The portion of the length of time set that has already been used can be checked using the "Time-elapsed" command.

#### 3

#### Select "Timer" and then press the [Enter] button.

#### 4 Enter the length of time to be set using up to three digits.

Press the numeric keypad buttons to enter a setting time within the range of 0 to 999 hours, and then press the [Enter] button. If you make a mistake entering the time, press the [Esc] button and re-enter the time.

A message will appear after this.

When you have finished using the "Password Protect" menu, the countdown for the elapsed time will start.



#### TIP

*If the length of time is set to "0", you will need to enter the password each time the power is turned on, otherwise projection will not be possible.*

#### 5 Turn "User's Logo Protect" on.

- (1) Select "User's Logo Protect", and then press the [Enter] button.
- (2) Select "ON", and then press the [Enter] button.
- (3) Press the [Esc] button.

#### 6 To set a password, select "Password" and then press the [Enter] button.

#### 7 The message "Change the password?" will be displayed, so select "Yes" and then press the [Enter] button.

The default setting for the password is "0000", but you should be sure to change this to your own desired password. If you select "No", the screen shown at step 1 will be displayed again.

#### 8 Enter a 4-digit password.

Use the numeric keypad buttons to enter a 4-digit password.

The password entered will be displayed as "\* \* \* \*".

When the 4th digit is entered, the following confirmation screen will be displayed.

#### 9 Re-enter the password that you entered in step 8.

The message "The new password is stored." will be displayed.

If you enter the password incorrectly, a message will be displayed prompting you to re-enter the password.

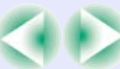

**10** Once the setting is complete, press the [Menu] button.



**TIP**

- *When the time period has elapsed and the password is entered, projection will start again, the "Time-elapsed" setting will be reset to "0" and the countdown will start again.*
- *Make a note of the password so that you do not forget it and keep it in a safe place.*
- *If you lose the remote control, you will not be able to enter the password. Keep the remote control in a safe place at all times.*

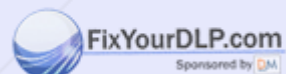

**Discount-Merchant.com (800) 281-8860**  
THE TRUSTED SOURCE FOR PROJECTOR LAMPS AND ACCESSORIES





# Basic Operations

This chapter describes basic operations such as turning the projector on and off and adjusting the projected images.

<b>Turning On the Projector.....</b>	<b>32</b>	<b>Adjusting the Image Quality.....</b>	<b>41</b>
• Connecting the Power Cable .....	32	• Adjusting Computer Images and RGB Video Images ....	41
• Turning On the Power and Projecting Images .....	33	• Automatic Setup .....	41
<b>Turning Off the Projector .....</b>	<b>35</b>	• Adjusting the Tracking .....	42
<b>Adjusting the Screen Image .....</b>	<b>37</b>	• Adjusting the Sync .....	43
• Adjusting the Image Size (Zoom Function).....	37	• Selecting the Projection Quality	
• Focusing the Screen Image.....	37	(Colour Mode Selection) .....	44
• Adjusting the Image Angle and Automatic Keystone			
Correction Function.....	38		
• Manually Correcting Keystone Distortion.....	40		

Turn on the power to start projecting images.



## CAUTION

*Be sure to read the separate Safety Instructions/World-Wide Warranty Terms before projecting images.*

## Connecting the Power Cable

### PROCEDURE

**1** Check that the power is turned off for the projector and all components connected to the projector.

**2** Connect the computer or other video source to the projector.  [p.16](#), [p.22](#)

**3** Remove the lens cover.

Hook your finger under the top of the lens cover and pull to remove it.

**4**

**Connect the accessory power cable to the projector.**

Check that the power cable connector is facing the same way as the power inlet on the projector, and then insert the power cable connector securely into the projector.

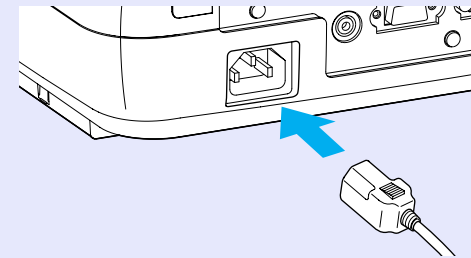

**5**

**Connect the other end of the power cable to an earthed electrical outlet.**

Wait until the Power indicator lights orange.

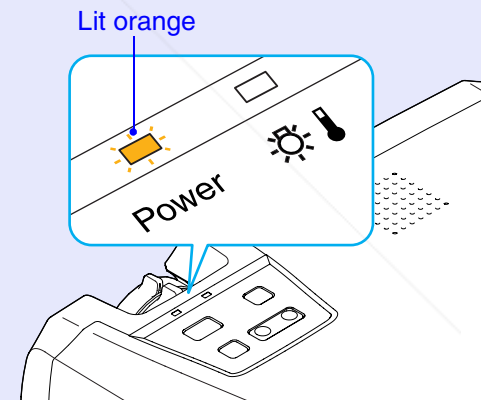

### TIP

*The projector's control panel and remote control buttons cannot be operated while the Power indicator is flashing orange.*

## Turning On the Power and Projecting Images



### TIP

The Password Protect setting may cause the password entry screen to be displayed each time the power is turned on. If this happens, enter the password. [p.27](#)

### PROCEDURE

- 1 Check that the Power indicator has stopped flashing and is lit orange.

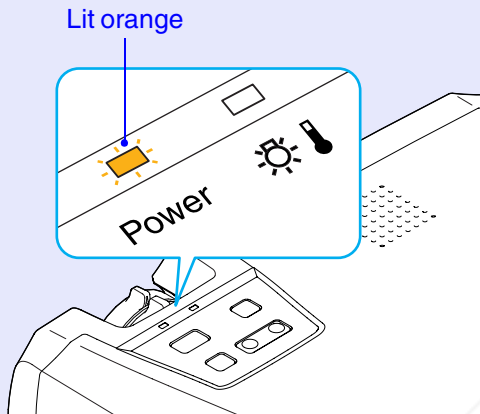

- 2 Turn on the power for all equipment connected to the projector.

For a video source, press the [Play] button at the video source to start playback if necessary.

3

- 3 Press the [Power] button on either the projector's control panel or the remote control to turn on the power for the projector.

A beep will sound to indicate that the projector is starting up. The Power indicator flashes green.

After a short period it stops flashing and lights steadily, and projection starts.

Wait until the Power indicator lights green (it normally takes about 40 seconds to change).

Changes from flashing to lit green

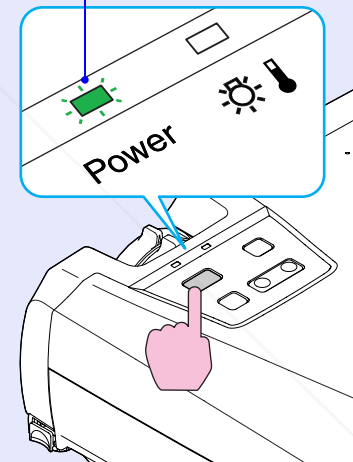

Remote control

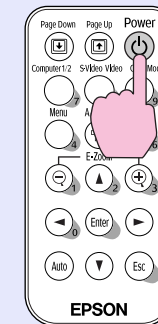

### TIP

- If the Power indicator is flashing green, operation of the [Power] buttons is disabled.
- Depending on the settings, the message "No Signal." may appear. See "Setting" - "Message" [p.58](#)

FixYourDLP.com  
Sponsored by

Discount-Merchant.com (800) 281-8860  
THE TRUSTED SOURCE FOR PROJECTOR LAMPS AND ACCESSORIES



- 4** If more than one external device is connected to the projector, use the remote control or projector control panel buttons to select the image source to be projected while referring to the following table.

Remote control

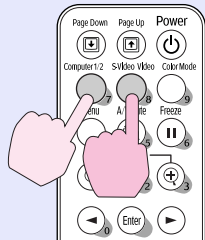

Projector

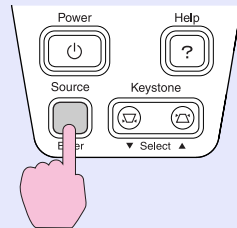

Port	Button to press		Display at top-right of screen
	Remote control	Projector	
Computer1/ Component Video1	[Computer1/2]	The image source changes each time [Source] is pressed. If no S-Video signal source is connected, "S-Video" will not appear.	Computer1* Component Video1 ( <a href="#">YCbCr▶▶</a> ) * Component Video1 ( <a href="#">YPbPr▶▶</a> ) *
Computer2/ Component Video2			Computer2* Component Video2 ( <a href="#">YCbCr▶▶</a> ) * Component Video2 ( <a href="#">YPbPr▶▶</a> ) *
S-Video Video	[S-Video/ Video]		S-Video Video

\* The items selected using the "Input Signal" command in the "Image" menu will appear.



**TIP**

- If only one signal source has been connected, the signals from that source will be projected without needing to press any of the buttons on the remote control or the projector's control panel.
- If the "No Signal." message does not disappear, check the connections again.
- If a laptop computer or a computer with an LCD screen has been connected to the projector, the images may not be projected straight away. After starting projection, check that the computer has been set up to output signals externally. The following table shows examples of how to toggle output settings. For details, refer to the section of the documentation provided with your computer under a heading such as "External output", "Connecting an external monitor" or similar.

NEC	Panasonic	Toshiba	IBM	Sony	Fujitsu	Macintosh
[Fn]+[F3]	[Fn]+[F3]	[Fn]+[F5]	[Fn]+[F7]	[Fn]+[F7]	[Fn]+[F10]	After startup, change the Control Panel adjustments so that Mirroring is active

- If the same still picture is projected for a long period of time, the projected image may become burned in on the computer screen. You should avoid leaving the same image displayed for long periods.



Follow the procedure below to turn off the power of the projector.

## PROCEDURE

### 1 Turn off the power for the signal sources that are connected to the projector.

Check that the power for all connected components has been turned off.

### 2 Press the [Power] button.

Remote control

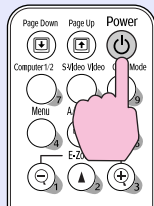

Projector

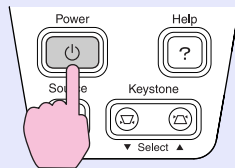

The following confirmation message will appear.

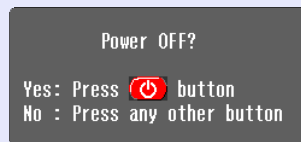

If you do not want to turn off the power, press any button except the [Power], [Page down] or [Page up] button.

If you do not press any button, the message will disappear automatically after seven seconds. (The power will not turn off at this time.)

### CAUTION

*If the message "The projector is overheating. Clean or replace the air filter and lower the room temperature." appears on the screen, press the [Enter] button on either the projector's control panel to turn the power off and then clean the air filters. [p.83](#)*

### 3 Press the [Power] button once more.

The lamp will switch off. The Power indicator will flash orange and [cool-down](#) will start.

The cool-down period lasts for about 20 seconds.

When cool-down is complete, the Power indicator lights orange.

Stops flashing and lights orange

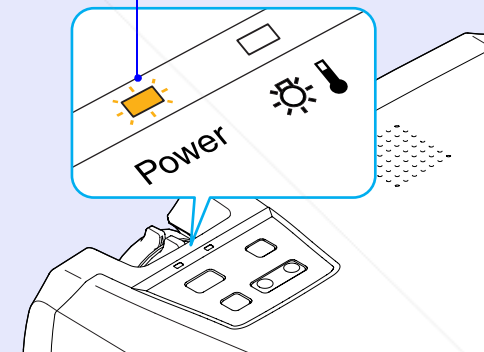

### TIP

*If the Power indicator is flashing orange, operation of the [Power] buttons is disabled. Wait until the indicator lights continuously.*



- 4** If not using the projector for a long period, unplug the power cable from the electrical outlet.



### CAUTION

*Do not disconnect the power cable from the outlet while the Power indicator is still flashing orange, otherwise it may result in errors in projector operation and reduce the lamp unit operating life.*

- 5** **Attach the lens cover.**

Attach the lens cover to the lens when not using the projector, in order to stop the lens from getting dusty or dirty.

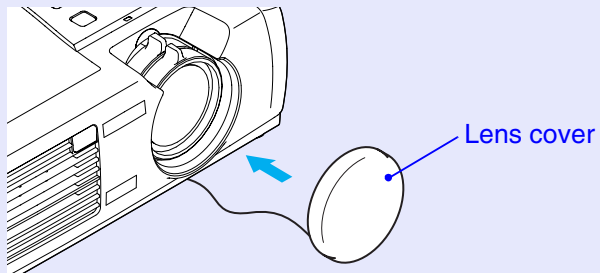

These functions correct and adjust the projected images so that the optimum images can be obtained.

## Adjusting the Image Size (Zoom Function)

The size of the projected image is basically determined by the distance from the projector to the screen. p.15

The following procedures explain how to adjust the screen image once the projector itself has been set up.

**TIP**

*The E-Zoom function lets you enlarge parts of the image.* p.49

### PROCEDURE

#### Adjust by turning the zoom ring.

The image can be enlarged in this way to 1.2 times the normal size.

Turn to "W" (wide) to enlarge the images.

Turn to "T" (tele) to reduce the images.

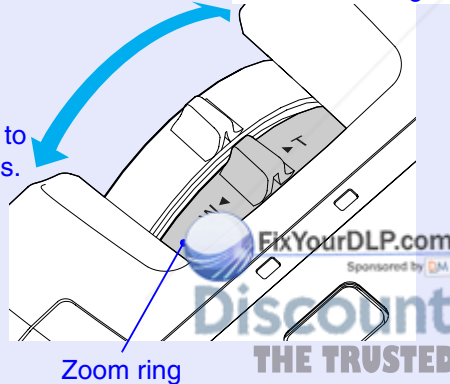

FixYourDLP.com  
Sponsored by

Discount-Merchant.com (800) 281-8860

THE TRUSTED SOURCE FOR PROJECTOR LAMPS AND ACCESSORIES

If you would like to enlarge the image further, move the projector further away from the screen. p.15

## Focusing the Screen Image

### PROCEDURE

Turn the focus ring to adjust the image focus.

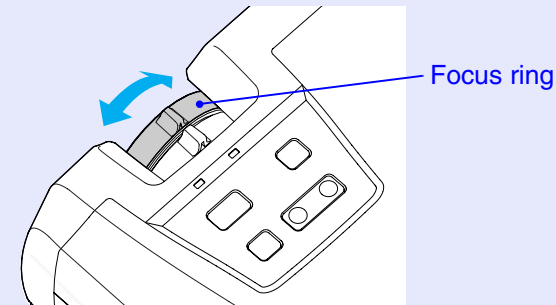
**TIP**

- *If the surface of the lens is dirty or misted over as a result of condensation, it may not be possible to adjust the focus correctly. If this happens, clean or de-mist the lens.* p.77, p.83
- *If the projector is positioned outside the normal projecting range of 89–1050 cm (2.9–34.4 ft.), it may not be possible to obtain the correct focus. If you have trouble obtaining the correct focus, check the projection distance.*

## Adjusting the Image Angle and Automatic Keystone Correction Function

The projector should be set up so that it is as perpendicular to the screen as possible.

Seen from the side

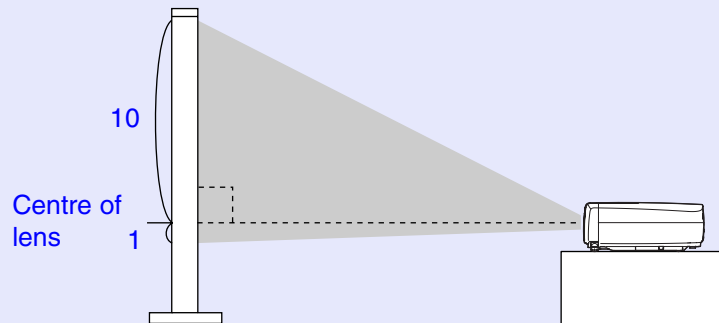

Seen from above

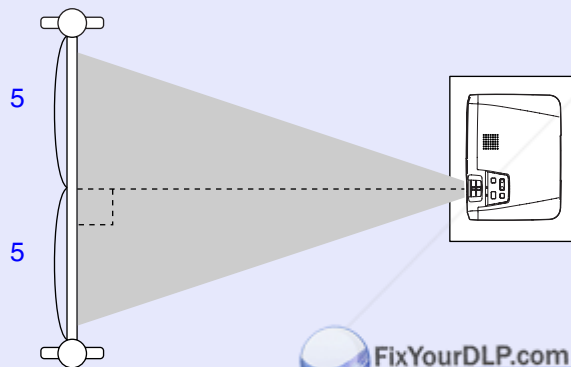

If it is not possible to set up the projector so that it is perpendicular to the screen, it can be set up at a slight vertical angle instead. You can extend or retract the front adjustable feet to adjust the upward projection angle within a maximum range of 10°.

### PROCEDURE

**While pressing the two foot adjust buttons at either side, lift up the front of the projector so that the front adjustable feet can extend.**

Extend the front adjustable feet until the desired angle is obtained, and then release the foot adjust buttons.

To retract the front adjustable feet, gently push down on the projector while pressing the two foot adjust buttons.

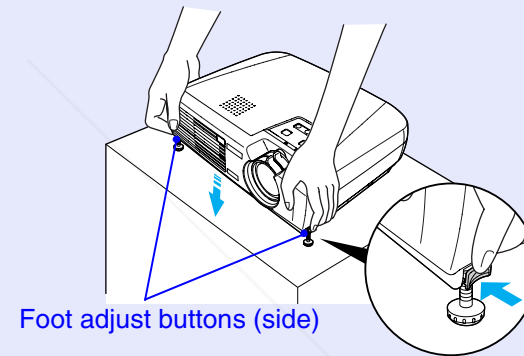

### TIP

*If the projector is tilted horizontally, turn the bases of the front adjustable feet to adjust the angle. When the projector is tilted horizontally, the correction may not be carried out correctly. [p.39](#)*

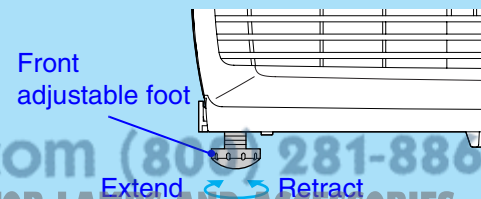



When the projector is tilted vertically, it will cause keystone distortion to appear in the image. However, the projector is equipped with an automatic keystone correction function that can automatically correct this keystone distortion as long as the vertical angle of tilt is within a range of approximately 15°. Automatic keystone correction is carried out approximately one second after the projector's power is turned on and the projector has been positioned.

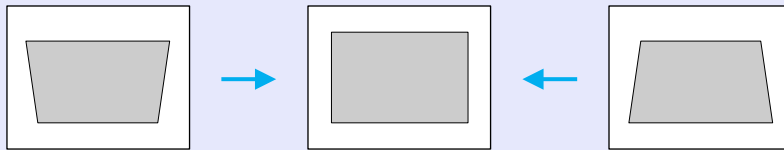

Approx. 15° above

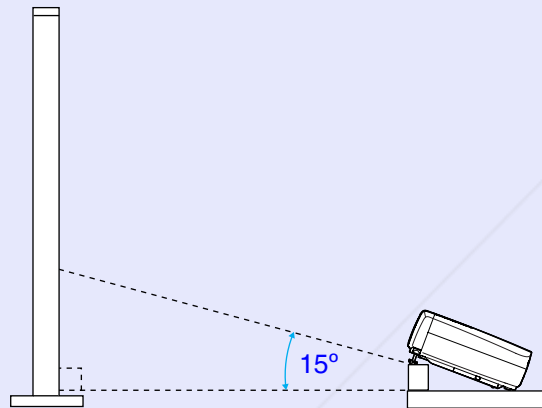

Approx. 15° below

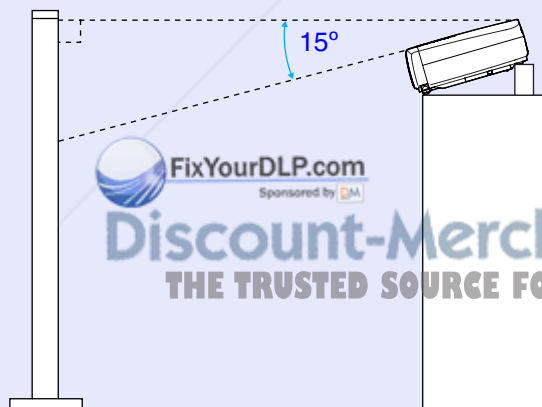

\* This value applies when the zoom ring is turned to the maximum "T" setting. If the zoom ring is turned to the "W" setting, the available angle of tilt for automatic adjustment will be less.

**TIP**

- **Automatic keystone correction is not carried out when the "Projection" command in the "Advanced" menu is set to "Front".**
- **If you would like to make further adjustments after automatic keystone correction has been carried out, you can use the [Keystone] button on the projector's control panel. [p.40](#)**
- **When keystone correction is carried out, the projected image will become smaller.**
- **If the images become uneven in appearance after keystone correction is carried out, decrease the sharpness setting. [p.51](#), [p.54](#)**
- **If automatic keystone correction is not required, set "Auto Keystone" in the "Setting" menu to "OFF". [p.58](#)**



## Manually Correcting Keystone Distortion

The projector is provided with an automatic keystone correction function which detects the vertical angle of the projector and carries out keystone correction automatically. If further correction adjustment is required after automatic keystone correction has been carried out, use the [Keystone] buttons on the projector's control panel to make the adjustment.

### PROCEDURE

If the bottom of the image is elongated

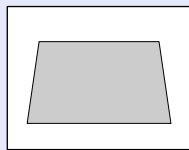

Projector

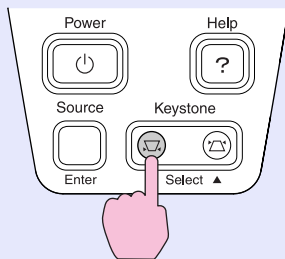

If the top of the image is elongated

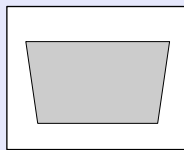

Projector

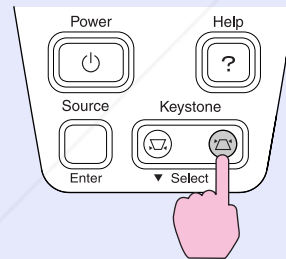

### TIP

- When keystone correction is carried out, the projected image will become smaller.
- If the images become uneven in appearance after keystone correction is carried out, decrease the sharpness setting. [☞ p.51, p.54](#)
- Keystone correction can also be carried out using the configuration menu. [☞ p.58](#)
- If the value displayed in the gauge on the screen stops changing when keystone correction is being carried out, it indicates that the limit for keystone correction has been reached. Check that the projector has not been set up at an angle which exceeds the proper limit.

The quality of the screen images can be adjusted as follows.

## Adjusting Computer Images and RGB Video Images

### Automatic Setup

Automatic setup detects analogue RGB signals coming from a connected computer, and automatically adjusts these signals so that the optimum images can be obtained.

Automatic setup involves adjustment of the following three items:

[Tracking](#)», Position and [Sync. \(Synchronization\)](#)».



- If "Auto Setup" in the "Image" menu is set to "OFF" (the default setting for this item is "ON"), automatic setup is not carried out. If you press the [Auto] button on the remote control while computer or RGB video signals are being projected, adjustment will then be carried out.

Remote control



- If you press the [Auto] button while the E-Zoom or Freeze function is being used or while a configuration menu or help menu is being displayed, the function will be cancelled when you press the [Auto] button, and then the adjustment will be carried out.
- Sometimes the signals may not be adjusted correctly depending on the type of computer or RGB video signals being output. In such cases, use the configuration menu commands to adjust the tracking and sync settings manually. ➔ [p.42](#), [p.43](#)

## Adjusting the Tracking

If vertical stripes appear in the projected computer or RGB video images, and this cannot be fixed using automatic setup, you will need to adjust the [tracking](#) manually using the following procedure.

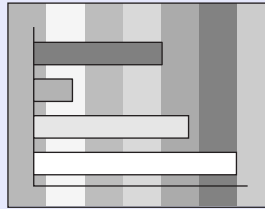

### PROCEDURE

- 1 Press the [Menu] button on the remote control, and then select "Tracking" from the "Image" menu.

For details on this operation, refer to "Using the Configuration Menus". [p.66](#)

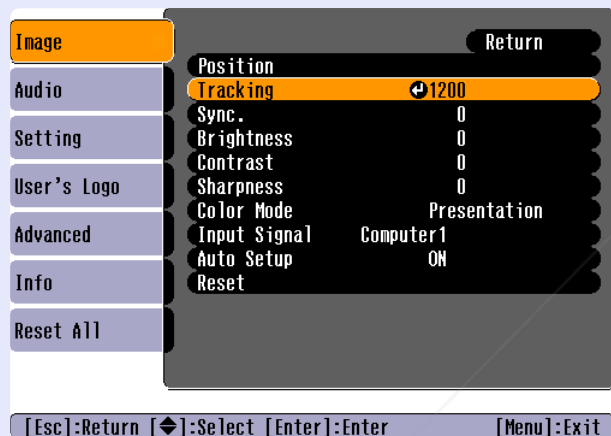

- 2 Press the [Left Arrow] and [Right Arrow] buttons to set the tracking value to a value that causes the vertical stripes to disappear from the image.

The tracking value increases or decreases each time a button is pressed.



- 3 After making the adjustment, press the [Menu] button to exit the configuration menu.



### TIP

*The image will flash when continuous tracking adjustment is carried out, but this is normal.*



FixYourDLP.com  
Sponsored by 

Discount-Merchant.com (800) 281-8860

THE TRUSTED SOURCE FOR PROJECTOR LAMPS AND ACCESSORIES

## Adjusting the Sync

If flickering, fuzziness or interference appear in computer or RGB video images, and this cannot be fixed using automatic setup, you will need to adjust the [sync. \(synchronization\)](#) manually using the following procedure.

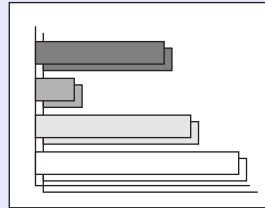

### PROCEDURE

- 1 Press the [Menu] button on the remote control, and then select "Sync." from the "Image" menu.

For details on this operation, refer to "Using the Configuration Menus". [p.66](#)

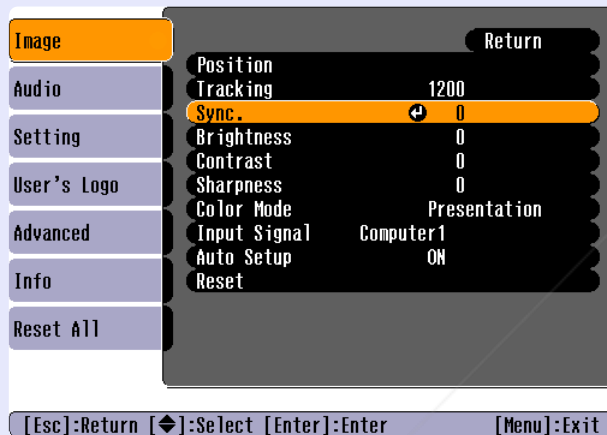

- 2 Press the [◀] and [▶] buttons to set the sync value to a value that causes the flickering, fuzziness or interference to disappear from the image.

The sync value increases or decreases each time a button is pressed.

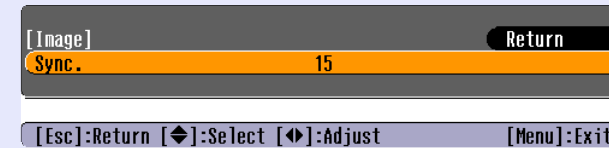

- 3 After making the adjustment, press the [Menu] button to exit the configuration menu.



### TIP

- If you adjust the sync without adjusting the tracking first, it will not be possible to get the best adjustment results. Incorrect tracking adjustment may not be noticeable with some types of picture. However, pictures with lots of lines and shading will tend to show incorrect tracking adjustments more clearly, so be sure to check the tracking adjustment first.
- It may also be possible to fix flickering and fuzziness by adjusting the brightness, [contrast](#), sharpness and keystone correction settings.

## Selecting the Projection Quality (Colour Mode Selection)

The following six preset colour modes are available for use depending on the characteristics of the images that are being projected. You can easily obtain the optimum image quality simply by selecting the colour mode that corresponds to the projected images. The brightness of the images will vary depending on which colour mode is selected.

Mode	Application
Dynamic	Brightness is emphasised, so that images are fresher and have greater modulation than in Presentation mode.
Presentation	Brightness is emphasised to produce images that are ideal for presentations.
Theatre	Movie images are optimised using natural tints.
Living Room	Brightness is emphasised to produce images that are ideal for projecting TV images, etc. in bright rooms.
<a href="#">sRGB</a> »	Images conform to the sRGB colour standard. If the connected source has a sRGB mode, set both the projector and the
Blackboard	Images with natural tints can be obtained when projecting onto a blackboard (green).

The default setting for the colour mode is as follows.  
 When computer or RGB video images are being input: "Presentation"  
 When other images are being input: "Dynamic"

### PROCEDURE

The colour mode changes as follows each time the [Color Mode] button is pressed.

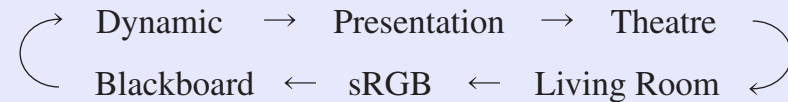

#### Remote control

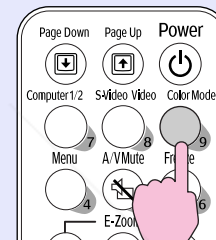

The current setting appears in the top-right corner of the screen each time the colour mode is changed.

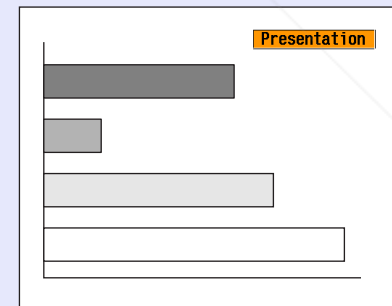

The colour mode can also be set using the "Color Mode" command in the "Image" menu. [p.52](#), [p.55](#)

# Advanced Operations

This chapter describes functions for enhancing the projection of images, and how to use the configuration menus.

<b>Functions for Enhancing Projection .....</b>	<b>46</b>
• <b>A/V Mute.....</b>	<b>46</b>
• <b>Freeze .....</b>	<b>47</b>
• <b>Wide-screen Projection of Images from Video Equipment (Changing the Aspect Ratio) .....</b>	<b>48</b>
• <b>E-Zoom.....</b>	<b>49</b>
<b>Using the Configuration Menu Functions .....</b>	<b>50</b>
• <b>List of Functions.....</b>	<b>51</b>
• "Image" Menu.....	51
• "Audio" Menu.....	57
• "Setting" Menu .....	58
• "User's Logo" Menu .....	60
• "Advanced" Menu.....	61
• "Info" Menu .....	64
• "Reset All" Menu.....	65
• <b>Using the Configuration Menus.....</b>	<b>66</b>



FixYourDLP.com  
Sponsored by DM

Discount-Merchant.com (800) 281-8860

THE TRUSTED SOURCE FOR PROJECTOR LAMPS AND ACCESSORIES

This section describes the various useful functions that can be used to enhance presentations.

## A/V Mute

This function momentarily pauses the image and sound.

For example, it can be used when you do not want to show details of operations such as selecting different files while computer images are being projected.

However, if you use this function when projecting moving images, the images and sound will still continue to be played back by the source, and you cannot return to the point where the mute function was activated.

### PROCEDURE

**Press the [A/V Mute] button.**

The image and sound will then be paused.

Projection starts again when the [A/V Mute] button on the remote control is pressed.

You can also continue normal projection by pressing the [Esc] button.

#### Remote control

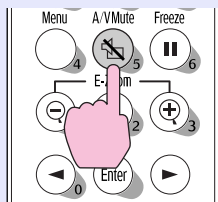

You can use the "Background Color" function in the "Setting" menu to set the screen appearance when the images and sound have been paused to any one of the following three settings. [p.58](#)

Solid black



Solid blue



User's logo

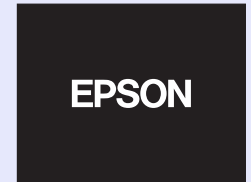

Default setting



### TIP

- *The default user's logo is the EPSON logo. To change the user's logo, you need to record your own logo. [p.90](#)*
- *When the A/V Mute function is being used, the "Brightness Control" setting in the "Advanced" menu will automatically change to "Low". When the A/V mute function is cancelled, the "Brightness Control" setting will return to the original setting.*



## Freeze

This function pauses only the projected images. The sound keeps playing without pausing.

The image source will still be playing back the images even while projection is paused, and so it will not be possible to resume projection from the point where it was paused.

### PROCEDURE

**Press the [Freeze] button.**

The images will then be paused.

To continue projecting the images, press the [Freeze] button once more.

You can also continue normal projection by pressing the [Esc] button.

#### Remote control

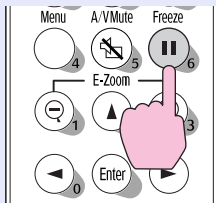

#### TIP

- Pressing the [Freeze] button also clears configuration menu displays and help messages.
- The freeze function still works when the E-Zoom function is being used.

FixYourDLP.com

Discount-Merchant.com (800) 281-8860

THE TRUSTED SOURCE FOR PROJECTOR LAMPS AND ACCESSORIES

## Wide-screen Projection of Images from Video Equipment (Changing the Aspect Ratio)

This function changes the [aspect ratio](#) of images from 4:3 to 16:9 when [component video](#) images (YCbCr and YPbPr), [S-Video](#) or [composite video](#) images are being projected.

Images which have been recorded in digital video or onto DVDs can be viewed in 16:9 wide-screen format.

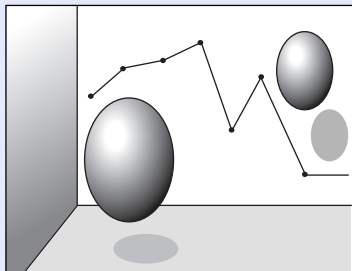

When images in [squeeze mode](#) are projected at 4:3

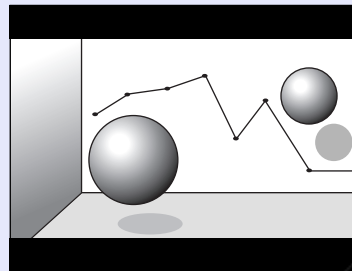

When images in [squeeze mode](#) are projected at 16:9

### PROCEDURE

- 1 Press the [Menu] button on the remote control, and then select "Aspect Ratio" from the "Image" menu. For details on this operation, refer to "Using the Configuration Menus". [p.66](#)



- 2 Press the [◀] and [▶] buttons to set the aspect ratio to either "4:3" or "16:9", and then press the [Enter] button.



- 3 After making the adjustment, press the [Menu] button to exit the configuration menu.

## E-Zoom

This function lets you enlarge and reduce a part of projected images such as graphs and tables.

### PROCEDURE

#### 1 Press the [E-Zoom ⊕] button.

A cursor (cross) indicating the centre point for the area to be enlarged will appear on the screen.

Remote control

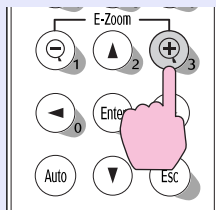

#### 2 Move the cross to the area of the image that is to be enlarged or reduced.

Press the [▲], [▼], [◀] and [▶] buttons on the remote control to move the cross.



Cross

3

When the [⊕] button is pressed, the image is enlarged with the cross at its centre. When the [⊖] button is pressed, the enlarged image is then reduced.

The enlargement ratio will appear on the screen.

You can scroll around the image by pressing the [▲], [▼], [◀] and [▶] buttons.



Shows enlargement ratio

To cancel the E-Zoom, press the [Esc] button.



#### TIP

The selected area can be enlarged to between 1–4 times, in 25 steps of  $\times 0.125$ .

The configuration menus can be used to carry out a variety of settings and adjustments.

The menus have a hierarchical structure, with a main menu that is divided into sub-menus, which are further divided into other sub-menus.

The remote control is used to operate the menus. Refer to "Using the Configuration Menus" [p.66](#) for details on using the menus.

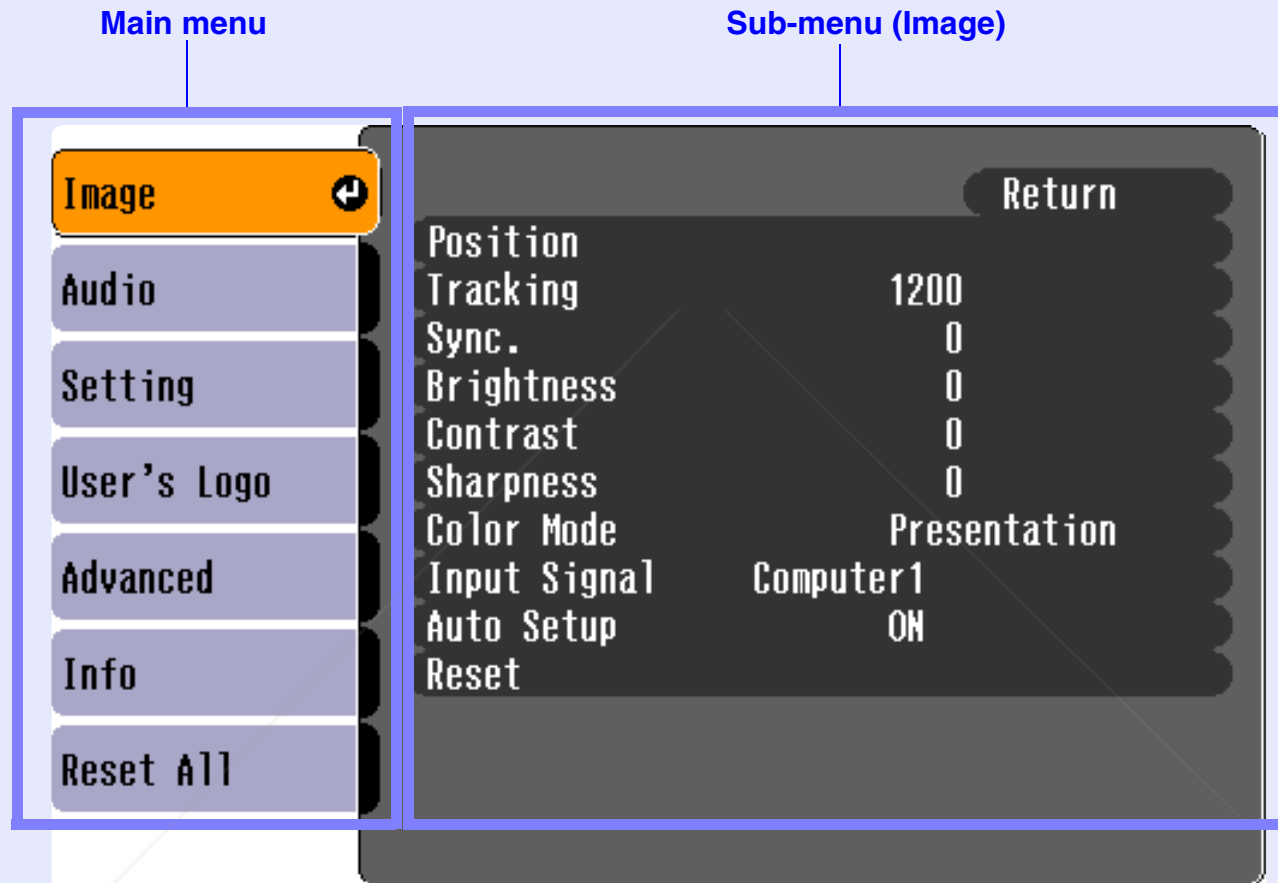

FixYourDLP.com

[Left Arrow]:Select [Enter]:Enter

[Menu]:Exit

Discount-Merchant.com (800) 281-8860

THE TRUSTED SOURCE FOR PROJECTOR LAMPS AND ACCESSORIES

## List of Functions

### "Image" Menu

- The functions in the "Image" menu apart from "Input Signal", "Auto Setup" and "Video Signal" cannot be adjusted while no image signal is being input.
- The functions which appear in the "Image" menu will change depending on the type of input source being used for the image signal. Functions which are not available in the "Image" menu for a particular input source cannot be adjusted.

#### Computer (Analogue-RGB)/RGB video

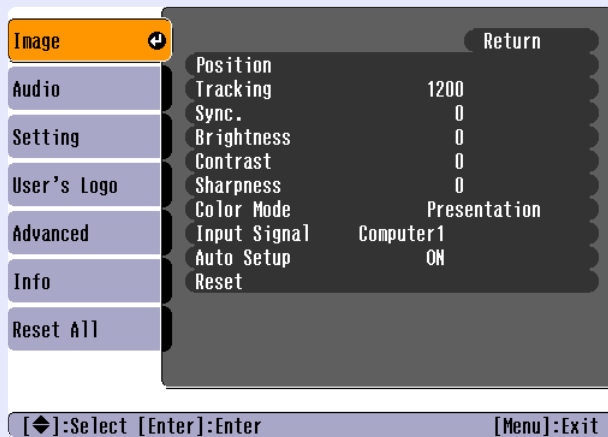

Sub-menu	Function	Default
Position	Moves the image display position vertically and horizontally. • Press the [Enter] button on the remote control and make the adjustment using the display position adjustment screen that appears.	Depends on connection
<a href="#">Tracking▶▶</a>	Adjusts computer images when vertical stripes appear in the images.	Depends on connection
<a href="#">Sync.▶▶</a>	Adjusts computer images when flickering, fuzziness or interference appear in the images. • Flickering and fuzziness may also appear when the brightness, <a href="#">contrast▶▶</a> , sharpness or keystone settings are adjusted. • You can obtain the best results if you adjust the tracking first and then adjust the sync.	Depends on connection
Brightness	Adjusts the image brightness.	Median value (0)
<a href="#">Contrast▶▶</a>	Adjusts the difference between light and shade in the images.	Median value (0)
Sharpness	Adjusts the image sharpness.	Median value (0)



Sub-menu	Function	Default
Color Mode	<p>Corrects the vividness of the image colour. The settings can be saved separately for each type of source (computer or video source). You can select from six different quality settings depending on the surroundings.</p> <ul style="list-style-type: none"> <li>•Dynamic : Brightness is emphasised, so that images are fresher and have greater modulation than in Presentation mode.</li> <li>•Presentation : Brightness is emphasised to produce images that are ideal for presentations.</li> <li>•Theatre : Images are optimised using natural tints. It emphasises colour gradations (differences between light and dark) when projecting images that are very dark or very light and bright, to make such images easier to see.</li> <li>•Living Room: Brightness is emphasised to produce images that are ideal for projecting TV images, etc. in bright rooms.</li> <li>•<a href="#">sRGB</a> : Images conform to the sRGB standard. If set to "sRGB", the <a href="#">Abs. Color Temp.</a> for the "Color Adjustment" command in the "Advanced" menu will be set to 6500K.</li> <li>•Blackboard : Images with natural tints can be obtained when projecting onto a blackboard (green).</li> </ul>	Presentation
Input Signal	<p>Selects the input signal in accordance with the source being used.</p> <p>The default setting varies according to the signal input source.</p> <p>If signals from the [Computer1/Component Video1] port are being input: Computer1</p> <p>If signals from the [Computer2/Component Video2] port are being input: Computer2</p> <ul style="list-style-type: none"> <li>•When projecting computer or RGB video images, select "Computer1" or "Computer2".</li> </ul>	Depends on input source
Auto Setup	<p>Selects whether the automatic adjustment function for automatically optimising images when the input source is changed is turned "ON" or "OFF".</p>	ON

Sub-menu	Function	Default
Reset	Resets all adjustment values for the "Image" menu functions except for the "Input Signal" setting to their default settings. <ul style="list-style-type: none"><li>• Press the [Enter] button on the remote control to reset the settings.</li><li>• Select "Reset All" to return all settings for menus such as "Image" and "Audio" to their default settings.  <a href="#">p.65</a></li></ul>	-



[Component video](#) ( [YCbCr](#) , [YPbPr](#) )

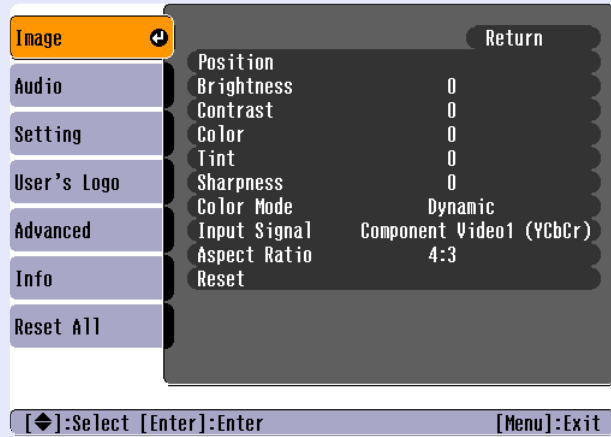

Sub-menu	Function	Default
Position	Moves the image display position vertically and horizontally. •Press the [Enter] button and make the adjustment using the display position adjustment sub-menu that appears.	Depends on connection
Brightness	Adjusts the image brightness.	Median value (0)
<a href="#">Contrast</a>	Adjusts the difference between light and shade in the images.	Median value (0)
Color	(Not available for RGB video) Adjusts the colour intensity for the images.	Median value (0)
Tint	(Not available for RGB video) (Adjustment is only possible when <a href="#">component video</a> or NTSC signals are being input.) Adjust the image tint.	Median value (0)
Sharpness	Adjusts the image sharpness.	Median value (0)

Video ( [Composite video](#) , [S-Video](#) )

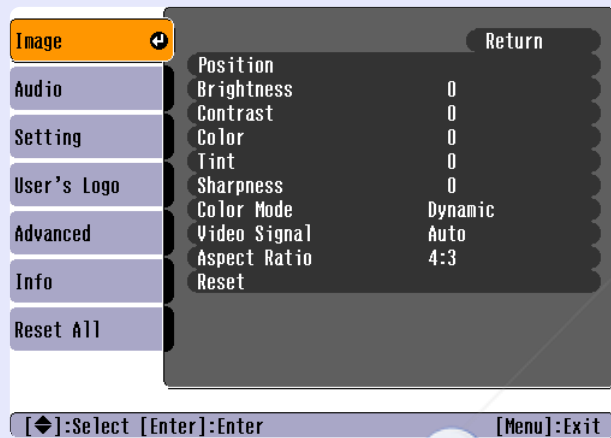



Sub-menu	Function	Default
Color Mode	<p>Corrects the vividness of the image colour. The settings can be saved separately for each type of source (computer or video source). You can select from six different quality settings depending on the surroundings.</p> <ul style="list-style-type: none"> <li>•Dynamic : Brightness is emphasised, so that images are fresher and have greater modulation than in Presentation mode.</li> <li>•Presentation : Brightness is emphasised to produce images that are ideal for presentations.</li> <li>•Theatre : Images are optimised using natural tints. It emphasises colour gradations (differences between light and dark) when projecting images that are very dark or very light and bright, to make such images easier to see.</li> <li>•Living Room: Brightness is emphasised to produce images that are ideal for projecting TV images, etc. in bright rooms.</li> <li>•<a href="#">sRGB</a> : Images conform to the sRGB standard. If set to "sRGB", the <a href="#">Abs. Color Temp.</a> for the "Color Adjustment" command in the "Advanced" menu will be set to 6500K.</li> <li>•Blackboard : Images with natural tints can be obtained when projecting onto a blackboard (green).</li> </ul>	Dynamic
Input Signal	<p>(Adjustment is only possible when component video signals are being input.)  Selects the input signal in accordance with the source being used.  The default setting varies according to the signal input source.  If signals from the [Computer1/Component Video1] port are being input: Computer1  If signals from the [Computer2/Component Video2] port are being input: Computer2</p>	Depends on input source

Sub-menu	Function	Default
Video Signal	<p>(Adjustment is only possible when composite video/S-Video signals are being input.) Sets the video signal format.</p> <ul style="list-style-type: none"> <li>• Press the [Enter] button on the remote control, and choose the setting from the video signal format selection sub-menu which appears.</li> <li>• When set to "Auto", the video signal format is set automatically.</li> </ul>	Auto
<a href="#">Aspect Ratio</a> »	Sets the aspect ratio for projected images.	Depends on connection
Reset	<p>Resets all adjustment values for the "Image" menu functions except for the "Input Signal" and "Video Signal" setting to their default settings.</p> <ul style="list-style-type: none"> <li>• Press the [Enter] button on the remote control to reset the settings.</li> <li>• Select "Reset All" to return all settings for menus such as "Image" and "Audio" to their default settings.  <a href="#">p.65</a></li> </ul>	-



**"Audio" Menu**

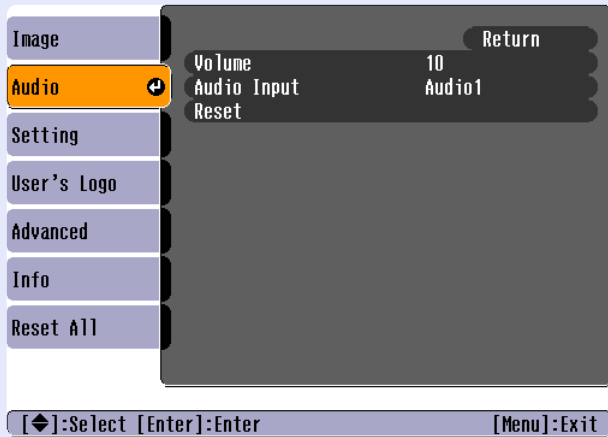

Sub-menu	Function	Default
Volume	Adjusts the volume.	Median value (10)
Audio Input	Selects the input source (port) for audio signals at the rear of the projector. The default setting varies depending on the type of signal being input (for computer, RGB video and component video input signals: Audio1; for video and S-Video input signals: Audio2) Therefore, if audio signals are being input to a different port from the default port, you will need to select the audio signal input source.	Depends on connection
Reset	Resets all adjustment values for the "Audio" menu functions to their default settings. <ul style="list-style-type: none"> <li>• Press the [Enter] button on the remote control to reset the settings.</li> <li>• Select "Reset All" to return all settings for menus such as "Image" and "Audio" to their default settings.  <a href="#">p.65</a></li> </ul>	-



**TIP**

*The "Audio" menu settings are saved individually for each input signal source.*



■ "Setting" Menu

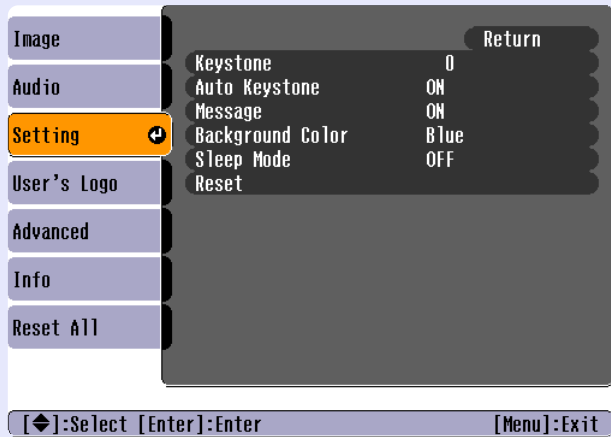

Sub-menu	Function	Default
Keystone	<p>Corrects vertical keystone distortion in images.</p> <ul style="list-style-type: none"> <li>•When keystone correction is carried out, the projected image will become smaller.</li> <li>•If the images become uneven in appearance after keystone correction is carried out, decrease the sharpness setting.</li> </ul>	Median value (0)
Auto Keystone	<p>Sets the function for automatically detecting the projector angle and correcting keystone "ON" or "OFF" when the projector is tilted vertically.</p> <p>This function is only enabled when the "Projection" command in the "Advanced" menu is set to "Front". If it is set to something other than "Front", this menu cannot be selected.</p>	ON
Message	<p>Sets whether display of the following messages is turned "ON" or "OFF".</p> <ul style="list-style-type: none"> <li>•Signal name when the video signal is switched</li> <li>•Colour mode name when the colour mode is switched</li> <li>•When no image signals are being input</li> <li>•When an incompatible signal is input</li> <li>•When the air filter needs replacing</li> </ul>	ON
Background Color	<p>Sets the screen status when the [A/V Mute] button on the remote control is being pressed or when no image signals are being input to "Black", "Blue" or "Logo".</p> <ul style="list-style-type: none"> <li>•To change the user's logo, you need to record your own logo. <a href="#">p.90</a></li> <li>•If the "User's Logo Protect" function of Password Protect has been set to "ON", the "Logo" setting cannot be changed from "Logo" to "Black" or "Blue", or from "Black" or "Blue" to "Logo". Cancel the Password Protect function before changing these settings. <a href="#">p.29</a></li> </ul>	Blue
Sleep Mode	<p>Sets the energy saving operation when no signal is being input.</p> <ul style="list-style-type: none"> <li>•When set to "ON", projection stops automatically and then after the <a href="#">cool-down</a> period is finished, the projector changes to sleep mode if no operations are carried out for 30 minutes while the "No Signal." message is being displayed. (The Power indicator lights orange.)</li> <li>•Projection starts again when the [Power] button is pressed.</li> </ul>	OFF

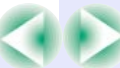

Sub-menu	Function	Default
Reset	<p>Resets all adjustment values for the "Setting" menu functions to their default settings.</p> <p>However, if "Background Color" has been set to "Logo", the setting cannot be returned to the default setting if the "User's Logo Protect" function of Password Protect has been set to "ON".</p> <ul style="list-style-type: none"><li>• Press the [Enter] button on the remote control to reset the settings.</li><li>• Select "Reset All" to return all settings for menus such as "Image" and "Audio" to their default settings.  <a href="#">p.65</a></li></ul>	-



■ "User's Logo" Menu

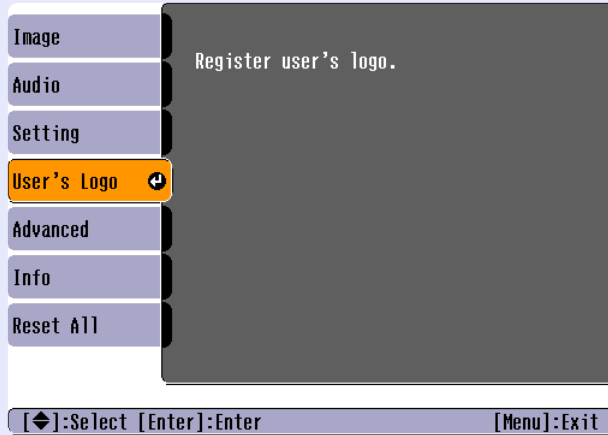

Sub-menu	Function	Default
Execute	<p>Records a user's logo. <a href="#">p.90</a></p> <ul style="list-style-type: none"> <li>• Press the [Enter] button on the remote control and follow the procedure appearing on the screen.</li> <li>• A user's logo cannot be recorded if the "User's Logo Protect" function of Password Protect has been set to "ON". Cancel the Password Protect function before recording a user's logo.</li> </ul>	EPSON logo

■ "Advanced" Menu

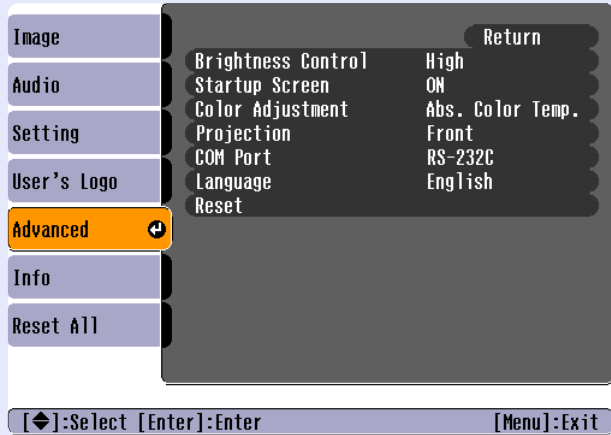

Sub-menu	Function	Default
Brightness Control	This lets you set the lamp brightness to one of two settings. Select "Low" if the images being projected are too bright such as when projecting images in a dark room or onto a small screen. When "Low" is selected, the brightness of the images is reduced, the amount of electricity consumed and noise produced during projection are reduced and the lamp's operating life is extended.	High
Startup Screen	Sets whether the startup screen is displayed or not. To change the user's logo, you need to record your own user's logo. <a href="#">p.90</a> This cannot be changed from enabled ("ON") to disabled ("OFF") if the "User's Logo Protect" function of Password Protect has been set to "ON". Cancel the Password Protect function before changing the setting.	ON



Sub-menu	Function	Default
Color Adjustment	<p>Adjusts the absolute <a href="#">Abs. Color Temp.</a> and intensity of each RGB (red, green, blue) colour for each input source.</p> <ul style="list-style-type: none"> <li>•Abs. Color Temp.: Lets you adjust bright colours within a range from reddish tinges to bluish tinges. If the colour temperature is lower, colours appear reddish and color tones appear softer. If the colour temperature is higher, colours appear bluish and colour tones appear sharper. Press the [Enter] button on the remote control and make the adjustment in the colour adjustment sub-menu that appears.</li> <li>•RGB : Press the [Enter] button on the remote control, select "R" (Red), "G" (Green) or "B" (Blue) and make the adjustment in the colour adjustment sub-menu that appears. The settings can be made while viewing the projected image on the screen.</li> </ul> <p>(This item cannot be selected if "sRGB" has been selected as the "Color Mode" setting in the "Image" menu.)</p>	Abs. Color Temp.: Depends on connection
Projection	<p>Sets the projection position for the projector.</p> <ul style="list-style-type: none"> <li>•Front : Select when the projector is in front of the screen.</li> <li>•Front/Ceiling: Select when the projector is in front of the screen and suspended from the ceiling.</li> <li>•Rear : Select when the projector is behind the screen.</li> <li>•Rear/Ceiling : Select when the projector is behind the screen and suspended from the ceiling.</li> </ul>	Front



Discount-Merchant.com (800) 251-3333

THE TRUSTED SOURCE FOR PROJECTOR LAMPS AND ACCESSORIES

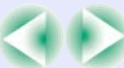



Sub-menu	Function	Default
COM Port	This can be set to either "RS-232C" or "USB", depending on the port that is being used for communication with a computer. When this setting is changed, turn off the power momentarily, and when the <a href="#">cool-down</a> period has finished, turn the power back on again. The new setting will be applied after the power turns back on.	RS-232C
Language	Sets the language for message displays. •Press the [Enter] button on the remote control and select the language.	English (Varies depending on country of purchase)
Reset	Resets all adjustment values for the "Advanced" menu functions except for the "Language" setting to their default settings. •Press the [Enter] button on the remote control to reset the settings. •Select "Reset All" to return all settings for menus such as "Image" and "Audio" to their default settings.  <a href="#">p.65</a>	-



**"Info" Menu**

- The "Info" menu shows the setting details for the current image source.
- The "Lamp Hours" item appears as 0H for 0–10 hours, and after that, it appears in units of 1 hour.

Computer (Analogue-RGB)/RGB Video/  
[Component video](#)» ([YCbCr](#)» , [YPbPr](#)»)

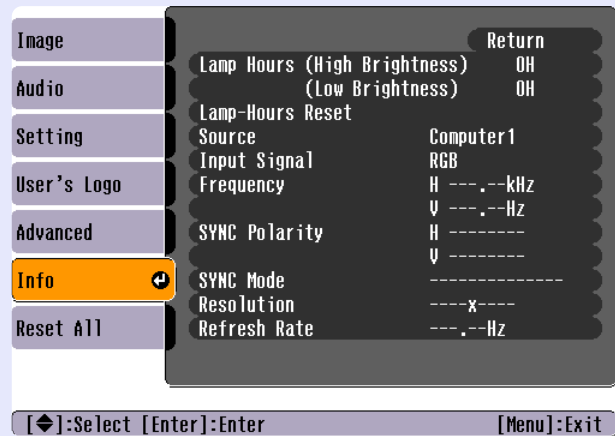

Video ([Composite video](#)» , [S-Video](#)»)



Sub-menu	Function	Default
Lamp Hours	Displays the cumulative lamp operating time for both "High" and "Low" brightness operation. •When the lamp warning period is reached, the display characters appear in red.	0H
Lamp-Hours Reset	Initialises the lamp operating time. When this command is selected, the cumulative lamp operating time is reset to the initial default value.	-
Source	Displays the input source which is currently being projected.	
Input Signal	Displays the input signal settings. (Does not appear when the input source is composite video or S-video.)	
Video Signal	Shows the video signal format. (Not displayed for computer, RGB video or component video images)	-
Frequency	Displays the horizontal and vertical scanning frequencies. (Does not appear when the input source is composite video or S-video.)	-
<a href="#">SYNC</a> » Polarity	Displays the sync polarity. (Does not appear when the input source is composite video or S-video.)	-
SYNC Mode	Displays the sync attributes. (Does not appear when the input source is composite video or S-video.)	-
Resolution	Displays the input resolution. (Does not appear when the input source is composite video or S-video.)	-
<a href="#">Refresh Rate</a> »	Displays the refresh rate. (Does not appear when the input source is composite video or S-video.)	-

■ "Reset All" Menu

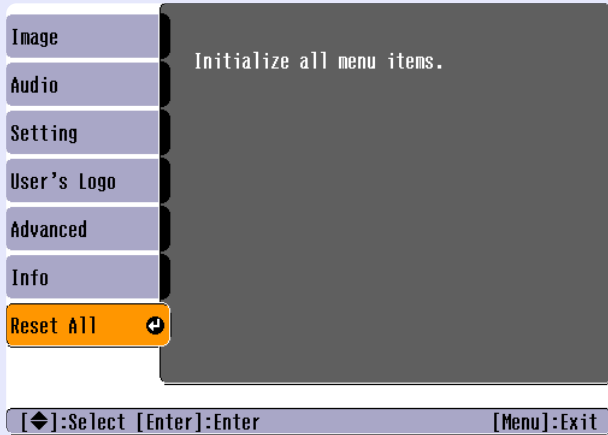

Sub-menu	Function	Default
Execute	<p>Resets all items in all menus to their default settings.</p> <ul style="list-style-type: none"> <li>• Press the [Enter] button on the remote control to reset the settings.</li> <li>• Select "Reset" in an individual sub-menu such as the "Image" or "Audio" menu to reset only the settings for the items in each sub-menu.</li> <li>• The "Input Signal", "User's Logo", "Lamp Hours" and "Language" settings will not return to their default values.</li> <li>• If "Background Color" has been set to "Logo", the setting cannot be returned to the default setting if the "User's Logo Protect" function of Password Protect has been set to "ON".</li> </ul>	-

## Using the Configuration Menus

The configuration menus can be operated using the remote control only.

### PROCEDURE

#### 1 Press the [Menu] button.

The configuration menu appears.

Remote control

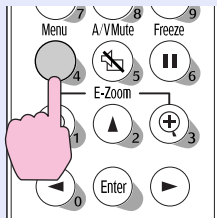

#### 2 Select a menu item.

Press the [▲] or [▼] button to move to an item to be selected.

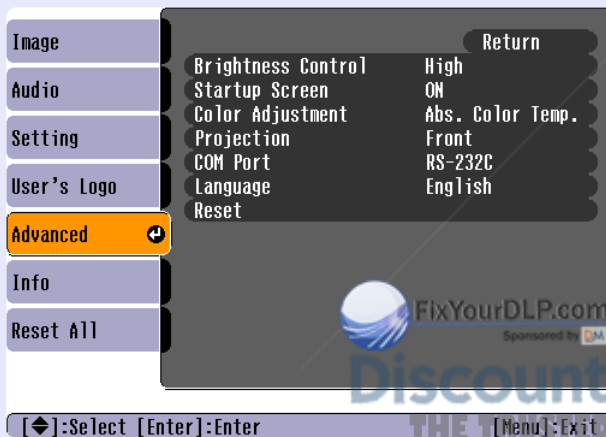

#### 3 Confirm the selection.

Press the [Enter] button to confirm the selection of a menu item. The selected sub-menu will then be displayed.

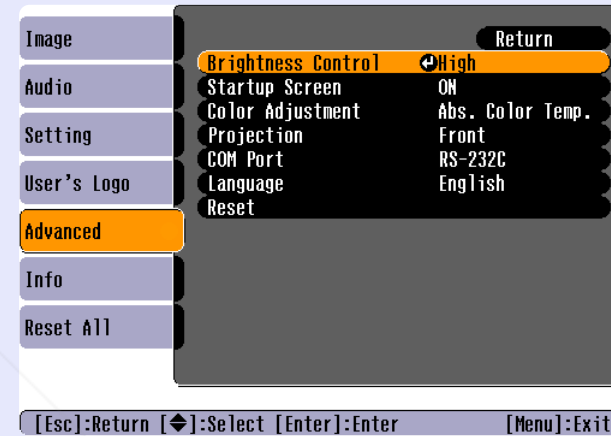

#### 4 Select a sub-menu item.

Press the [▲] and [▼] buttons to select the sub-menu item to be set, and then press the [Enter] button.

The items appearing in the "Image" menu and the "Info" menu will vary depending on the type of input source being projected.

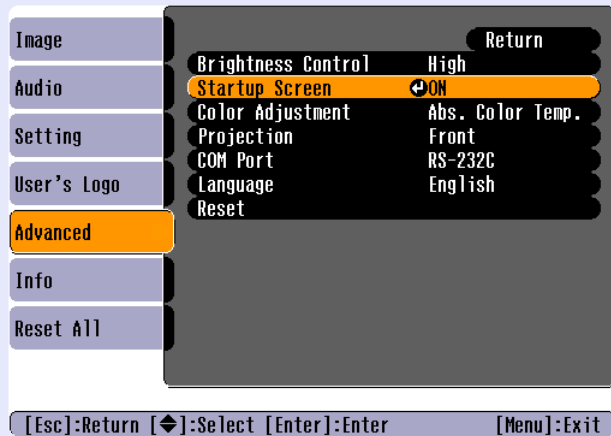

#### 5 Change the setting.

- Press the [▲], [▼], [◀] and [▶] buttons to change the setting.
  - : Current setting value
  - : Currently-selected setting item
- If you press the [Enter] button at items with a ⊙ displayed, the setting screen for that item will be displayed. After making the setting, press the [Enter] button to accept the setting. The ● will change to green.

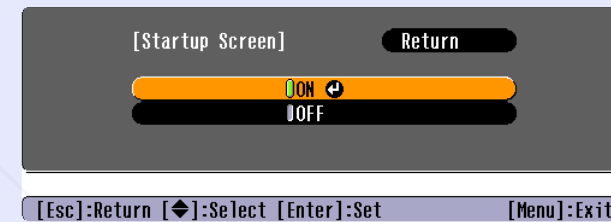

#### 6 Select other menu items in the same way.

Press the [Esc] button once to return to the previous level. Alternatively, select "Return" and then press the [Enter] button.

#### 7 Close the menu.

Press the [Menu] button.



**TIP**

Refer to "List of Functions" for details on the functions of each menu item. ➔ p.51



# Troubleshooting

This chapter describes how to identify problems and what to do if a problem is found.

<b>Using the Help</b> .....	<b>69</b>
<b>Problem Solving</b> .....	<b>71</b>
• <b>Reading the Indicators</b> .....	<b>71</b>
• Power Indicator.....	71
• ⚠ (Warning) Indicator .....	72
• <b>When the Indicators Provide No Help</b> .....	<b>74</b>
• Problems relating to images .....	75
• Problems when projection starts .....	80
• Other problems .....	81

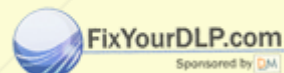

**Discount-Merchant.com (800) 281-8860**  
**THE TRUSTED SOURCE FOR PROJECTOR LAMPS AND ACCESSORIES**

If a problem occurs with the projector, the Help function uses on-screen displays to assist you in solving the problem. It uses a series of menus in a question and answer format.

## PROCEDURE

### 1 Press the [Help] button.

The help menu will be displayed.

Projector

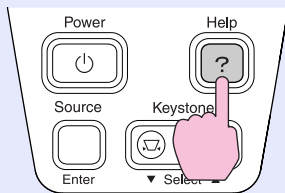

### 2 Select a menu item.

If using the control panel, the [ ▼ Select ▲ ] buttons function as the up and down keys.

If using the remote control, press the [▲] and [▼] buttons to select an item.

Remote control



Projector

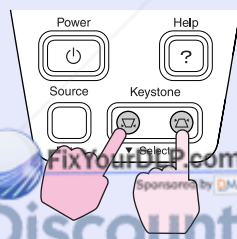

[Help Menu]

Help for the image

Help for the sound

Language selection (Language)

If the suggested solution in Help doesn't solve the problem, unplug the power from the wall outlet and contact your local dealer.

[◀]:Select [Enter]:Enter

[Help]:Exit

### 3

### Confirm the selection.

Press the [Enter] button to confirm the selection of a menu item.

Remote control



Projector

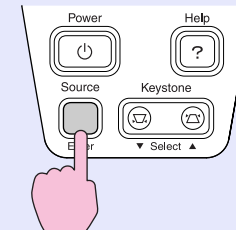

#### 4 Repeat the operations in steps 2 and 3 to proceed through the menu to more detailed items.

The help menu is cleared when the [Help] button is pressed.

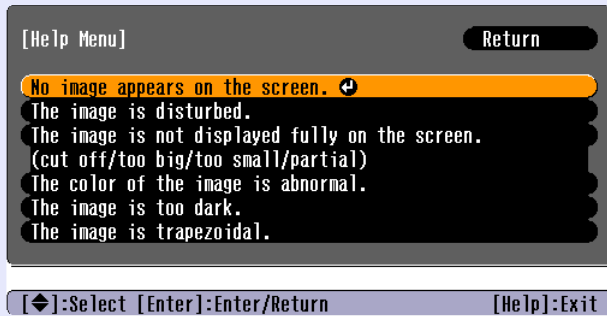

#### TIP

*If the Help function does not provide a solution to the problem, refer to "Problem Solving" [p.71](#)*

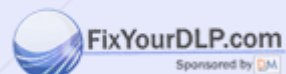

**Discount-Merchant.com (800) 281-8860**  
THE TRUSTED SOURCE FOR PROJECTOR LAMPS AND ACCESSORIES





If you are having a problem with the projector, first check the projector's indicators and refer to "Reading the Indicators" below. If the indicators do not show clearly what the problem might be, refer to "When the Indicators Provide No Help". [p.74](#)

## Reading the Indicators

The projector is provided with the following two indicators which alert you to the operating status of the projector.

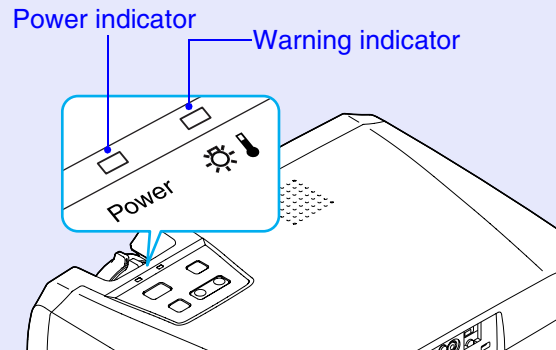

The following tables show what the indicators mean and how to remedy problems that they indicate. If both indicators are off, check that the power cable is connected correctly and that power is being supplied normally.

### ■ Power Indicator

■ : lit ■■■ : flashing

Status	Cause	Remedy or Status
Orange ■	Standby condition	(Not abnormal) Projection starts again when the [Power] button is pressed. You can disconnect the power plug from the electrical outlet when the status light is in this condition.
Orange ■■■	Cool-down progress	(Not abnormal) Please wait. •The <a href="#">cool-down</a> period lasts about 20 seconds. •The [Power] button will not operate if it is pressed while cool-down is in progress. Press the button again after cool-down ends when the indicator stops flashing.
Green ■	Projection in progress	(Not abnormal)

Discount-Me.com (800) 281-8860  
Sponsored by DM  
THE TRUSTED SOURCE FOR PROJECTOR LAMP AND ACCESSORIES



■ : lit ■■■ : flashing

Status	Cause	Remedy or Status
Green 	Warm-up in progress	(Not abnormal) Please wait. Warm-up time is approximately 40 seconds. After warm-up is complete, indicator stops flashing.

■ (Warning) Indicator

■ : lit ■■■ : flashing

Status	Cause	Remedy or Status
Red 	Internal temperature error (overheating)	The lamp will turn off automatically and projection will stop. Wait for about 5 minutes without operating the projector. After about 5 minutes have elapsed, unplug the power cable and then check the following two points. •Check that the air filter and air exhaust vent are clear, and that the projector is not positioned against a wall.  p.15 •If the air filters are blocked, clean or replace them.  p.83, p.89 When the power cable is plugged back in, the projector will return to its previous state, so press the [Power] button to turn the power back on. If the projector continues to overheat even after the above points have been checked, or if the indicators show a problem when the power is turned back on, stop using the projector, disconnect the power cable from the electrical outlet, and contact your dealer or the nearest address provided at "International Warranty Conditions" in <i>Safety Instructions/World-Wide Warranty Terms</i> booklet.
Red  (0.5-second intervals)	Lamp timer failure/ Lamp out	Take out the lamp and check if it is broken.  p.86 If the lamp is not broken, reinstall it, then reconnect the power cable and press the [Power] button on either the projector's control panel or the remote control to turn the power back on. If the indicators still show a problem, stop using the projector, disconnect the power cable from the electrical outlet, and contact your dealer or the nearest address provided at "International Warranty Conditions" in <i>Safety Instructions/World-Wide Warranty Terms</i> booklet. If the lamp is broken replace it with a new lamp, or contact your local dealer for further advice. If replacing the lamp yourself, be careful to avoid pieces of broken glass. (Projection cannot be carried out until the lamp is replaced.) Check that the lamp and the lamp cover are securely installed. If the lamp or lamp cover is not securely installed, the lamp will not switch on.
Red  (1-second intervals)	Internal error/ Fan related error/ Sensor error	Stop using the projector, disconnect the power cable from the electrical outlet, and contact your dealer or the nearest address provided in the "International Warranty Conditions" section of the <i>Safety Instructions/World-Wide Warranty Terms</i> booklet.

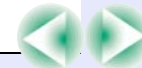
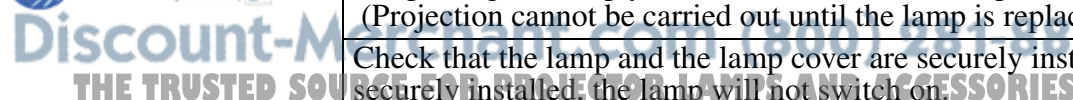

■ : lit ■■■ : flashing

Status	Cause	Remedy or Status
Orange 	High-speed cooling in progress	(This is not an abnormality, but if the temperature rises too high again, projection will stop automatically.) •Check that the air filters and air exhaust vent are clear and that they are not up against a surface such as a wall.  p.15 •If the air filters are blocked, clean or replace them.  p.83, p.89



**TIP**

- If the projector is not operating properly even though the indicators are all showing normal, refer to "When the Indicators Provide No Help" on the following page.
- If an indicator is showing a status which does not appear in the previous tables, contact your dealer or the nearest address provided at "International Warranty Conditions" in Safety Instructions/World-Wide Warranty Terms booklet.



FixYourDLP.com

Sponsored by DM

**Discount-Merchant.com (800) 281-8860**











**THE TRUSTED SOURCE FOR PROJECTOR LAMPS AND ACCESSORIES**



## When the Indicators Provide No Help

If any of the following problems occur and the indicators do not offer a solution, refer to the pages given for each problem.



### Problems relating to images

- No images appear  [p.75](#)  
Projection does not start, the projection area is completely black, the projection area is completely blue, etc.
- Projection stops automatically  [p.75](#)
- The message "Not Supported." is displayed.  [p.76](#)
- The message "No Signal." is displayed.  [p.76](#)
- Images are fuzzy or out of focus.  [p.77](#)
- Interference or distortion appear in images.  [p.77](#)  
Problems such as interference, distortion or black & white checked patterns appear.
- Image is truncated (large) or small  [p.78](#)  
Only part of the image is displayed.
- Image colours are not right  [p.79](#)  
The whole image appears purplish or greenish, images are black & white, colours appear dull, etc.  
(Computer monitors and LCD screens have different colour reproduction performance, so that the colours projected by the projector and the colours appearing on the monitor may not necessarily match, but this is not a sign of a problem.)
- Images appear dark  [p.79](#)
- Nothing appears on the external monitor  [p.80](#)

### Problems when projection starts

- Power does not turn on  [p.80](#)



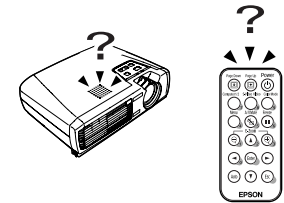

### Other problems

- No sound can be heard or the sound is faint  [p.81](#)
- The remote control does not work  [p.81](#)



■ Problems relating to images

■ No images appear

Check	Remedy
Was the [Power] button pressed?	Press the [Power] button to turn the power on.
Are both indicators switched off?	The power cable is not connected correctly or power is not being supplied normally. Connect the projector's power cable correctly.  <a href="#">p.32</a> Alternatively, check the circuit breaker to ensure that power is being supplied.
Is A/V Mute mode active?	Press the [A/V Mute] button on the remote control to cancel the mute.  <a href="#">p.46</a>
Has "Message" been set to "OFF"?	If the "Message" command is set to "OFF", set it to "ON" so that messages can be displayed. When a message is displayed, refer to the item that it indicates. "Setting" - "Message"  <a href="#">p.58</a>
Have the configuration menu settings been made correctly?	Reset all of the settings.  <a href="#">p.65</a>
Is the projected image completely black? <b>Only when projecting computer images</b>	Some input images, such as screen savers, may be completely black.
Are the image signal format settings correct? <b>Only when projecting images from a video source</b>	If a <a href="#">composite video</a> or <a href="#">S-Video</a> source is connected to the projector, use the "Video Signal" menu command to select the signal format. "Image" - "Video Signal"  <a href="#">p.56</a>

■ Projection stops automatically

Check	Remedy
Is "Sleep Mode" set to "ON"?	When the "Sleep Mode" menu command has been set to "ON", the lamp turns off automatically if no operations are carried out for about 30 minutes while no video signal is being input. The Power indicator will flash orange at this time. Press the [Power] button to turn the power on. If you do not want sleep mode to be used, change the "Sleep Mode" setting to "OFF". "Setting" - "Sleep Mode"  <a href="#">p.58</a>



■ The message "Not Supported." is displayed.

Check	Remedy
<p><b>Are the image signal format settings correct?</b></p> <p><b>Only when projecting computer images</b></p>	<p>If signals from the [Computer1/Component Video1] port or the [Computer2/Component Video2] port are being projected, use the "Input Signal" menu command to set the signal format that matches the signal that is being projected from the connected equipment.                      "Image" - "Input Signal" 🖱️ p.52, p.55                      If a <a href="#">composite video</a> or <a href="#">S-Video</a> source is connected to the projector, use the "Video Signal" menu command to select the signal format.                      "Image" - "Video Signal" 🖱️ p.56</p>
<p><b>Does the mode match the frequency and resolution of the image signals?</b></p> <p><b>Only when projecting computer images</b></p>	<p>Use the "Frequency" menu command to check the signals being input.                      "Info" - "Frequency" 🖱️ p.64                      Check the frequency and resolution of the computer.                      🖱️ Computer documentation</p>

■ The message "No Signal." is displayed.

Check	Remedy
<p><b>Are the cables connected correctly?</b></p>	<p>Check that all of the cables required for projection are securely connected. 🖱️ p.16–p.24</p>
<p><b>Has the correct video input port been selected?</b></p>	<p>Press the [Computer1/2] button or [S-Video/Video] button on the remote control or the [Source] button on the projector's control panel to select the images. 🖱️ p.34</p>
<p><b>Is the power for the computer or video source turned on?</b></p>	<p>Turn the power on for the devices. 🖱️ p.33</p>
<p><b>Are the image signals being output to the projector?</b></p> <p><b>Only when projecting images from a laptop computer or computer with a built-in LCD screen</b></p>	<p>If the image signals are only being output to the computer's LCD monitor or to the accessory monitor, you need to change the output to an external destination as well as the computer's own monitor. For some computer models, when the image signals are output externally, they no longer appear on the LCD monitor or accessory monitor.                      🖱️ Computer documentation, under a title such as "External output" or "Connecting an external monitor"                      If the connection is made while the power is already turned on, the function [Fn] key that switches the computer's video signal to external output may not work. Turn the power for the projector and the computer off and then back on again. 🖱️ p.33, p.35</p>



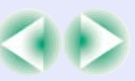

FixYourDLP.com  
Sponsored by DM

Discount-Merchant.com (800) 281-8860







THE TRUSTED SOURCE FOR PROJECTOR LAMPS AND ACCESSORIES



■ Images are fuzzy or out of focus.





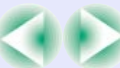

Check	Remedy
<b>Has the focus been adjusted correctly?</b>	Turn the focus ring on the projector to adjust the focus.  <a href="#">p.37</a>
<b>Is the lens cover still attached?</b>	Remove the lens cover.  <a href="#">p.32</a>
<b>Is the projector at the correct distance?</b>	The recommended projection distance range is 89–1050 cm (2.9–34.4 ft.). Set the projector up so that it is within this range.  <a href="#">p.15</a>
<b>Is the keystone adjustment value too large?</b>	Decrease the projection angle to reduce the amount of keystone correction.  <a href="#">p.40</a>
<b>Has condensation formed on the lens?</b>	If the projector is suddenly taken from a cold environment to a warm environment or if sudden ambient temperature changes occur, condensation may form on the surface of the lens, and this may cause the images to appear fuzzy. Set the projector up in the room approximately one hour before it is to be used. If condensation forms on the lens, turn the power off and wait for the condensation to disappear.

■ Interference or distortion appear in images.

Check	Remedy
<b>Are the image signal format settings correct?</b>	If signals from the [Computer1/Component Video1] port or the [Computer2/Component Video2] port are being projected, use the "Input Signal" menu command to set the signal format that matches the signal that is being projected from the connected equipment. "Image" - "Input Signal"  <a href="#">p.52</a> , <a href="#">p.55</a> If a <a href="#">composite video</a> or <a href="#">S-Video</a> source is connected to the projector, use the "Video Signal" menu command to select the signal format. "Image" - "Video Signal"  <a href="#">p.56</a>
<b>Are the cables connected correctly?</b>	Check that all of the cables required for projection are securely connected.  <a href="#">p.16–p.24</a>
<b>Is an extension cable being used?</b>	If an extension cable is used, electrical interference may affect the signals. Use the accessory cables and check if this helps.
<b>Has the correct resolution been selected?</b> <b>Only when projecting computer images</b>	Set the computer so that the signals that are output are compatible with this projector. "List of Supported Monitor Displays"  <a href="#">p.100</a>  Computer documentation
<b>Have the "Sync.▶" and "Tracking▶" settings been adjusted correctly?</b> <b>Computer and RGB video signals only</b>	Press the [Auto] button on the remote control to carry out automatic adjustment. If the images have not been adjusted correctly after using automatic adjustment, you can make the adjustments using the "Sync." and "Tracking" menus.  <a href="#">p.42</a> , <a href="#">p.43</a>



■ Image is truncated (large) or small

Check	Remedy
<b>Has the aspect ratio been set correctly?</b>	Set the "Aspect Ratio" menu command to "4:3". "Image" - "Aspect Ratio"  <a href="#">p.56</a>
<b>Is the image still being enlarged by the E-Zoom function?</b>	Press the [Esc] button on the remote control to cancel the E-Zoom function.  <a href="#">p.49</a>
<b>Has the "Position" setting been adjusted correctly?</b>	If analogue RGB images from a computer or RGB video images are being projected, press the [Auto] button on the remote control to carry out automatic adjustment. If the images have not been correctly adjusted after using the automatic setup function, adjust the setting manually using the "Position" menu command. If signals other than analogue RGB images from a computer or RGB video images are being input, adjust the setting manually using the "Position" menu command. "Image" - "Position"  <a href="#">p.51, p.54</a>
<b>Has the computer been set for dual display?</b> <b>Only when projecting computer images</b>	If dual display has been activated in the Display Properties of the computer's Control Panel, the projector will only project about half of the image on the computer screen. To display the whole of the image on the computer screen, turn off the dual display setting.  Computer video driver documentation
<b>Has the correct resolution been selected?</b> <b>Only when projecting computer images</b>	Set the computer so that the signals that are output are compatible with this projector. "List of Supported Monitor Displays"  <a href="#">p.100</a>  Computer documentation

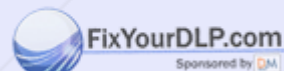



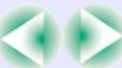



**Discount-Merchant.com (800) 281-8860**  
THE TRUSTED SOURCE FOR PROJECTOR LAMPS AND ACCESSORIES





■ Image colours are not right



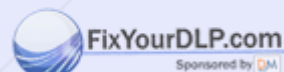

Check	Remedy
<p><b>Do the input signal settings match the signals from the connected device?</b></p>	<p>If the "Input Signal" menu command is set to a setting other than "Computer1" or "Computer2" when a computer or RGB video source is connected to the [Computer1/Component Video1] port or [Computer2/Component Video2] port, the images will appear purplish.                      If the "Input Signal" menu command is set to "Computer1" or "Computer2" when a <a href="#">component video</a> source is connected to the [Computer1/Component Video1] port or [Computer2/Component Video2] port, the images will appear greenish.                      Select the correct signal format for the connected source.                      "Image" - "Input Signal"  <a href="#">p.52, p.55</a>                      If a <a href="#">composite video</a> or <a href="#">S-Video</a> source is connected to the projector, use the "Video Signal" menu command to select the video signal format.                      "Image" - "Video Signal"  <a href="#">p.56</a></p>
<p><b>Has the image brightness been adjusted correctly?</b></p>	<p>Use the "Brightness" menu command to adjust the brightness.                      "Image" - "Brightness"  <a href="#">p.51, p.54</a></p>
<p><b>Are the cables connected correctly?</b></p>	<p>Check that all of the cables required for projection are securely connected.  <a href="#">p.16–p.24</a></p>
<p><b>Has the image <a href="#">contrast</a> been adjusted correctly?</b></p>	<p>Use the "Contrast" menu command to adjust the contrast.                      "Image" - "Contrast"  <a href="#">p.51, p.54</a></p>
<p><b>Has the colour been adjusted correctly?</b></p>	<p>Use the "Color Adjustment" menu command to adjust the colour.                      "Advanced" - "Color Adjustment"  <a href="#">p.62</a></p>
<p><b>Have the colour intensity and tint been adjusted correctly?</b></p> <div data-bbox="257 1061 734 1145" style="background-color: #333; color: white; padding: 5px; margin-top: 10px;"> <p>Only when projecting images from a video source</p> </div>	<p>Use the "Color" and "Tint" menu commands to adjust the colour and tint.                      "Image" - "Color", "Tint"  <a href="#">p.54</a></p>

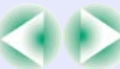

**Discount-Merchant.com (800) 281-8860**  
 THE TRUSTED SOURCE FOR PROJECTOR LAMPS AND ACCESSORIES



■ Images appear dark

Check	Remedy
Have the image brightness and luminance been adjusted correctly?	Use the "Brightness" and "Brightness Control" menu commands to adjust the brightness and luminance. "Image" - "Brightness"  <a href="#">p.51, p.54</a> "Advanced" - "Brightness Control"  <a href="#">p.61</a>
Has the image <a href="#">contrast</a> been adjusted correctly?	Use the "Contrast" menu command to adjust the contrast. "Image" - "Contrast"  <a href="#">p.51, p.54</a>
Is the lamp due for replacement?	When the lamp is nearly due for replacement, the images will become darker and the colour quality will become poorer. When this happens, the lamp should be replaced with a new one.  <a href="#">p.86</a>

■ Nothing appears on the external monitor

Check	Remedy
Are images from a port other than the [Computer1/Component Video1] port being projected?	The only images that can be displayed on an external monitor are those from the [Computer1/Component Video1] port.  <a href="#">p.21</a>

■ Problems when projection starts





■ Power does not turn on

Check	Remedy
Have you pressed the [Power] button?	Press the [Power] button to turn the power on.
Are all of the indicators switched off?	The power cable is not connected correctly or power is not being supplied. Connect the power cable to the projector correctly.  <a href="#">p.32</a> Alternatively, check the circuit breaker to see if power is being supplied.
Do the indicators turn off again when the power cable is touched?	There is probably a poor contact in the power cable, or the power cable may be defective. Reinsert the power cable. If this does not solve the problem, stop using the projector, disconnect the power cable from the wall outlet and contact the nearest address provided at "International Warranty Conditions" in <i>Safety Instructions/World-Wide Warranty Terms</i> booklet.







■ Other problems

- No sound can be heard or the sound is faint

Check	Remedy
<b>Is the audio source connected correctly?</b>	Check that the cable is connected to the correct [Audio] port.  <a href="#">p.25</a>
<b>Has the volume been adjusted to the minimum setting?</b>	Adjust the volume so that sound can be heard. "Audio" - "Volume"  <a href="#">p.57</a>
<b>Is A/V Mute mode active?</b>	Press the [A/V Mute] button on the remote control to cancel the A/V mute function.  <a href="#">p.46</a>
<b>Is the "Audio Input" setting correct?</b>	Set the "Audio Input" command to the port being used for audio input. "Audio" - "Audio Input"  <a href="#">p.57</a>

- The remote control does not work

Check	Remedy
<b>Is the remote control light-emitting area facing towards the remote control light-receiving area when it is operated?</b>	Face the remote control towards the remote control light-receiving area. The operating angle for the remote control is approximately $\pm 30^\circ$ horizontally and approximately $\pm 15^\circ$ vertically.  <a href="#">p.13</a>
<b>Is the remote control too far from the projector?</b>	The operating range for the remote control is approximately 6m.  <a href="#">p.13</a>
<b>Is direct sunlight or strong light from fluorescent lamps shining onto the remote control light-receiving area?</b>	Set the projector up in a location where strong light will not shine onto the remote control light-receiving area.
<b>Is the battery dead or has it been inserted the wrong way?</b>	Insert a new battery and make sure that it is inserted correctly.  <a href="#">p.84</a>
<b>Has the battery insulating tape been removed?</b>	Pull out the insulating tape.  <a href="#">p.12</a>



# Appendices

This chapter provides information on maintenance procedures to ensure the best level of performance from the projector.

<b>Maintenance .....</b>	<b>83</b>	<b>List of ESC/VP21 Commands.....</b>	<b>97</b>
• <b>Cleaning .....</b>	<b>83</b>	• <b>Command List .....</b>	<b>97</b>
• Cleaning the Projector Case.....	83	• <b>Communication Protocol .....</b>	<b>97</b>
• Cleaning the Lens .....	83	• <b>Cable Layouts .....</b>	<b>98</b>
• Cleaning the Air Filters and Air Intake Vent.....	83	• Serial connection .....	98
• <b>Replacing Consumables.....</b>	<b>84</b>	• USB connection.....	98
• Inserting the Battery .....	84	• <b>USB Connection Setup.....</b>	<b>99</b>
• Lamp Replacement Period.....	85	<b>List of Supported Monitor Displays .....</b>	<b>100</b>
• Replacing the Lamp.....	86	• Computer/RGB Video .....	100
• Resetting the Lamp Operating Time.....	88	• Component Video/RGB Video.....	100
• Replacing the Air Filter .....	89	• Composite Video/S-Video.....	100
<b>Saving a User's Logo .....</b>	<b>90</b>	<b>Specifications.....</b>	<b>101</b>
<b>Optional Accessories .....</b>	<b>93</b>	<b>Appearance.....</b>	<b>102</b>
<b>Glossary .....</b>	<b>94</b>	<b>Index.....</b>	<b>103</b>

This section describes maintenance tasks such as cleaning the projector and replacing consumable parts.

## Cleaning

You should clean the projector if it becomes dirty or if the quality of projected images starts to deteriorate.



### CAUTION

*Be sure to read the separate Safety Instructions/World-Wide Warranty Terms before cleaning.*

### Cleaning the Projector Case

Clean the projector case by wiping it gently with a soft cloth. If the projector is particularly dirty, moisten the cloth with water containing a small amount of neutral detergent, and then firmly wring the cloth dry before using it to wipe the projector case. Then wipe the case again with a soft, dry cloth.



### CAUTION

*Do not use volatile substances such as wax, alcohol or thinner to clean the projector case. These can cause the case to warp and make the coating finish peel off.*

### Cleaning the Lens

Use a commercially-available air blower, or use a lens cleaning paper to gently wipe the lens.



### CAUTION

*Do not rub the lens with harsh materials or subject the lens to shocks, as it can easily become damaged.*

### Cleaning the Air Filters and Air Intake Vent

If the air filters become clogged with dust, or if the message "The projector is overheating. Clean or replace the air filter and lower the room temperature." appears on the screen, clean the air filters and the air intake vent.

If the air filters become clogged with dust, it can cause overheating and damage the projector.

Turn the projector upside-down and use a vacuum cleaner to clean the air intake vent.

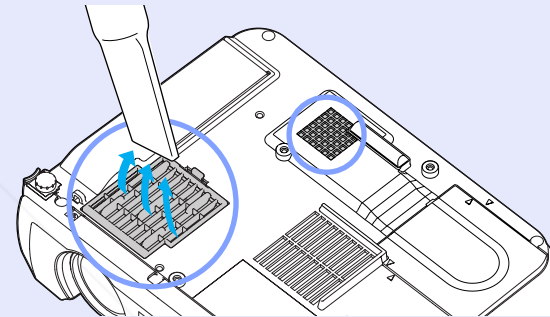

### TIP

- *If the air filters are broken or if the warning message reappears after they have been cleaned, they should be replaced. Replace with the accessory air filter or another new air filter. See "Appendices: Optional Accessories".* [p.93](#)
- *Spare lamps are provided with a spare air filter. The air filter should also be replaced when the lamp is replaced.*

## Replacing Consumables

This section describes how to replace the remote control battery, the lamp and the air filter.

### ■ Inserting the Battery

Use the following type of battery as a replacement.  
1 CR2025 lithium battery



#### CAUTION

*Be sure to read the Safety Instructions/World-Wide Warranty Terms before handling the battery.*

#### PROCEDURE

#### 1 Remove the battery holder.

While pushing the catch of the battery holder inwards, pull the battery holder out.

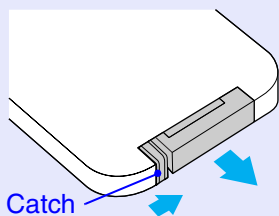

#### 2 Remove the old battery and insert the new battery.

Check the position of the (+) mark inside the battery holder to ensure that the battery is inserted the correct way.

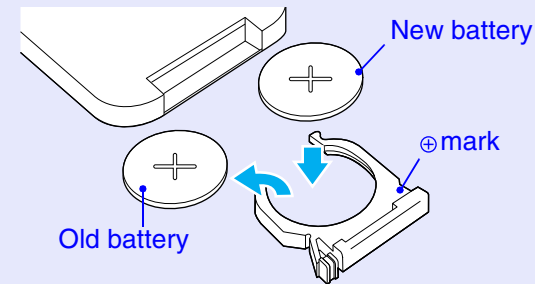

#### 3

#### Insert the battery holder into the remote control.

Push the battery holder in until it clicks.

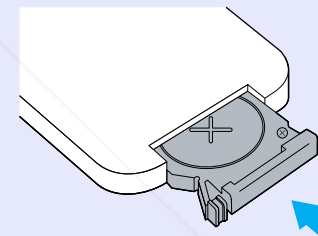

#### TIP

*Dispose of used batteries in accordance with local waste disposal regulations.*

## Lamp Replacement Period

It is time to replace the lamp when:

- The message "Replace the Lamp." appears on the screen when projection starts

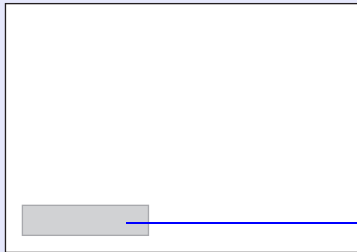

A message will be displayed.

- When the  (Warning) indicator is flashing red at 0.5-second intervals

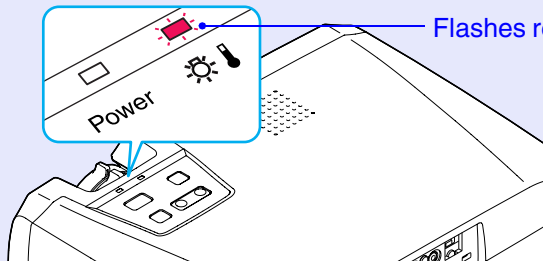

- The projected image gets darker or starts to deteriorate.



### TIP

- *The lamp replacement message is set to appear after the following periods of time in order to maintain the initial brightness and quality of the projected images.*
  - *When used continuously at high luminance: Approx. 1900 hours*
  - *When used continuously at low luminance : Approx. 2900 hours*
- *"Brightness Control"  p.61*
- *If you continue to use the lamp after this period, the possibility of the lamp breaking becomes greater. When the lamp replacement message appears, replace the lamp with a new one as soon as possible, even if it is still working.*
- *Depending on the characteristics of the lamp and on the way it has been used, the lamp may become darker or stop working before the lamp warning message appears. You should always have a spare lamp ready in case it is needed.*
- *Contact your dealer for a spare lamp.*

## ■ Replacing the Lamp

### ! CAUTION

- *If you are replacing the lamp because it has stopped working, it is possible that the lamp is broken. If replacing the lamp of a projector which has been installed to the ceiling, you should always assume that the lamp is broken and be extremely careful when removing the lamp cover.*
- *Wait until the lamp has cooled down sufficiently before removing the lamp cover. It takes a further one hour after the [cool-down](#) period has finished for the lamp to be cool enough.*

### PROCEDURE

- 1 Turn the projector power off, wait for the cool-down period to end, then disconnect the power cable.

The cool-down period lasts for about 20 seconds.

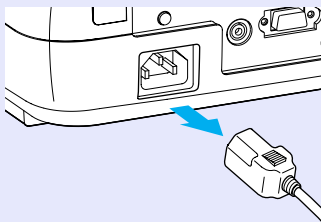

- 2 Wait until the lamp has cooled down, then remove the lamp cover from the base of the projector.

It takes approximately one hour for the lamp to cool down by itself after the cool-down period has finished. Insert the screwdriver that is supplied with the spare lamp or some other flat-tipped screwdriver into the hollow between the projector and the lamp cover, and turn it to release the lock. Slide the screwdriver in until the ▷ mark on the lamp cover and the ◁ mark on the projector are aligned. Then lift up the lamp cover to remove it.

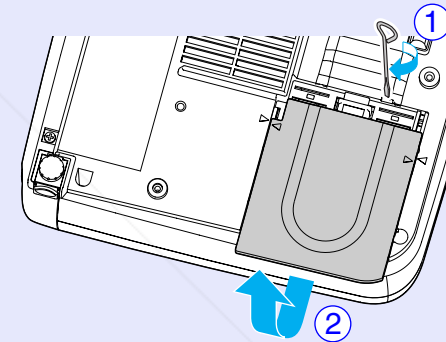

- 3 Loosen the two lamp fixing screws.

Use the screwdriver that is supplied with the spare lamp or some other flat-tipped screwdriver to loosen the two lamp fixing screws that are securing the lamp to the projector.

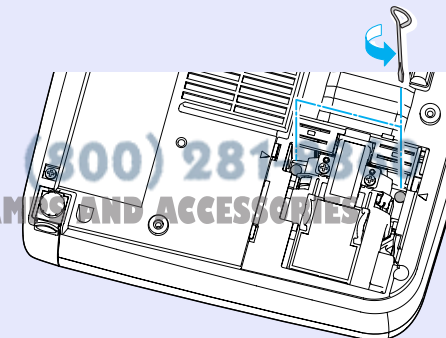



#### 4 Take out the lamp.

Hold the lamp as shown in the illustration below and lift it up and out of the projector.  
If the lamp is broken replace it with a new lamp, or contact your local dealer for further advice. If replacing the lamp yourself, be careful to avoid pieces of broken glass.

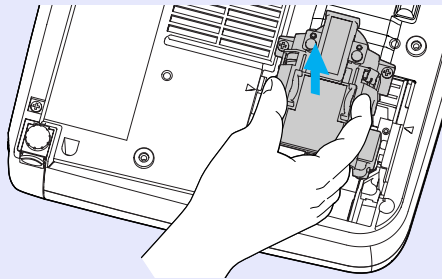

#### 5 Install the new lamp.

Hold the lamp so that it faces the correct way to fit into the projector, then insert the lamp until it clicks into place and tighten the two fixing screws.

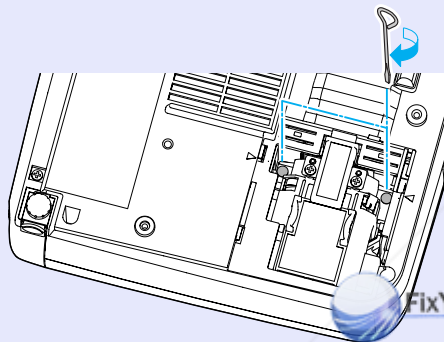

FixYourDLP.com  
Sponsored by 

#### 6 Install the lamp cover.

Insert the two cover tabs into the projector until the ▷ mark on the lamp cover is aligned with the ◁ mark on the projector, then slide the lamp cover in until it clicks into place.

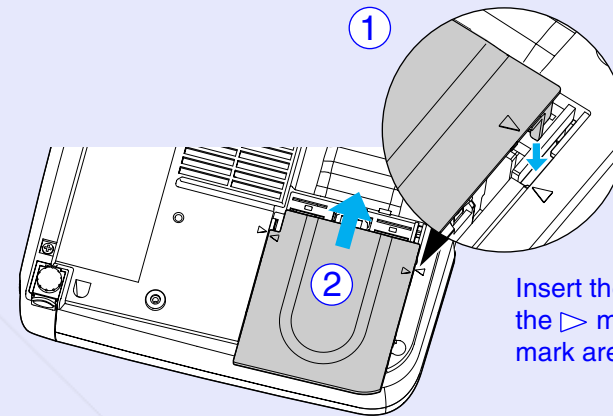

Insert the cover so that the ▷ mark and the ◁ mark are aligned.



#### TIP

- *Install the lamp securely. If the lamp cover is removed, the lamp turns off automatically as a safety precaution. Moreover, the lamp will not turn on if the lamp or the lamp cover is not installed correctly.*
- *Spare lamps are provided with a spare air filter. The air filter should also be replaced when the lamp is replaced.  p.89*
- *Dispose of used lamps properly in accordance with your local regulations.*



## Resetting the Lamp Operating Time

The projector has a built-in counter which keeps track of the lamp operating time. When the cumulative operating time reaches a certain point, it causes the replacement warning message to be displayed. Therefore, the counter needs to be reset after the lamp has been replaced with a new one. You can do this using the configuration menu.



### TIP

*Do not reset the lamp operating time except after the lamp has been replaced, otherwise the lamp replacement period will not be indicated correctly.*

## PROCEDURE

- 1 Connect the power cable, turn on the projector's power, and then press the [Menu] button.

The configuration menu will be displayed.

### Remote Control

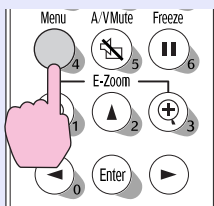

- 2 Select "Lamp-Hours Reset" from the "Info" menu and then press the [Enter] button.

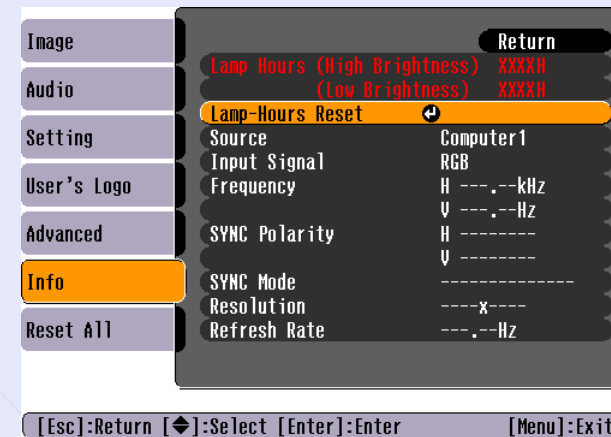

- 3 Select "Yes" and then press the [Enter] button. The lamp operating time will then be reset.

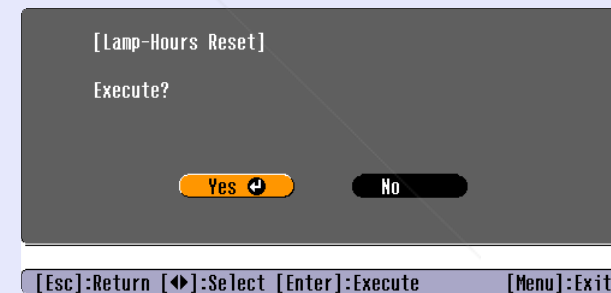

## ■ Replacing the Air Filter

The air filter can be replaced even if the projector is installed to a ceiling.

### PROCEDURE

- 1** Turn the projector power off, wait for the **cool-down** period to end, then disconnect the power cable.

The cool-down period lasts for about 20 seconds.

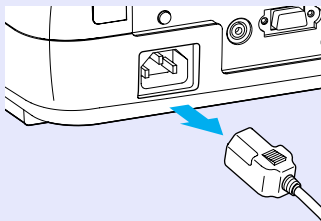

- 2** Put your finger into the recess in the knob of the air filter cover, and lift up the air filter cover to remove it.

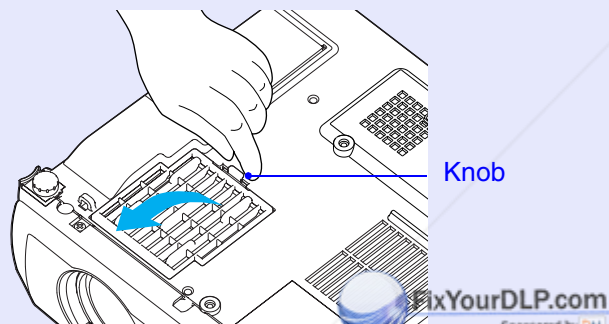

- 3** Replace the air filter with a new one.

Remove the old air filter, and install the new air filter. Place the new air filter so that it does not slip into the air intake vent.

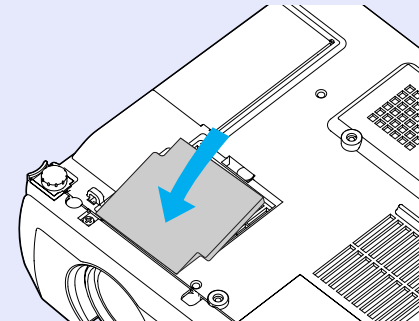

- 4** Install the air filter cover.

First insert the tabs, then press down on the opposite side until it clicks into place.

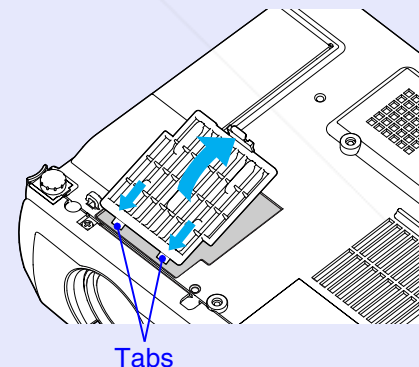

### TIP

Dispose of used air filters properly in accordance with your local regulations.

You can record the image that is currently being projected as a user's logo.

**TIP**

When a user's logo is recorded, the previous user's logo will be erased.

**TIP**

- If the "User's Logo Protect" function of "Password Protect" is set to "ON", a message is displayed and the user's logo can not be recorded. To record a user's logo, set "User's Logo Protect" to "OFF" first. [p.29](#)
- If keystone correction or E-Zoom have been carried out, they will be cancelled when the "User's Logo" menu is selected.

**PROCEDURE**

- 1 Project the image that you would like to use as a user's logo, and then press the [Menu] button.

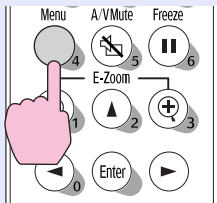
**Remote Control****3**

- 3 Select "Yes" in the sub-menu, then press the [Enter] button.

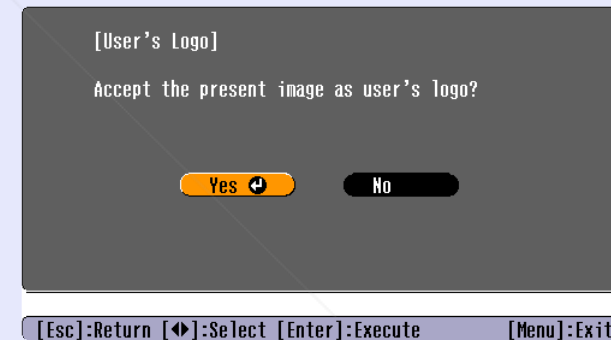
**TIP**

When you press the [Enter] button, the images will be displayed at the original image signal resolution, so that if you are projecting images that have a resolution that is different from the number of pixels on the projector's panel, and if you are projecting video images, the display size will change.

- 2 Select the "User's Logo" menu, and then press the [Enter] button.

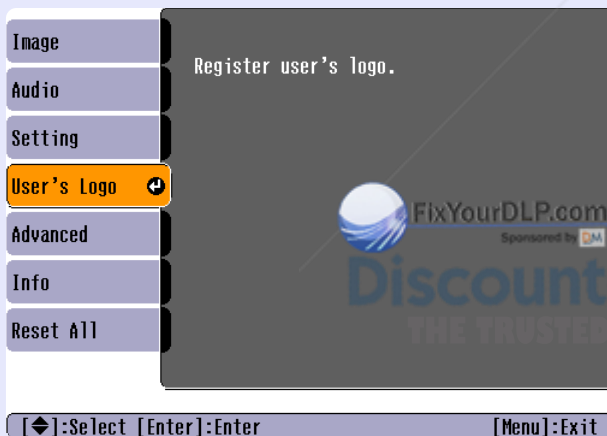

- 4** The image to be recorded and a selection marquee box will be displayed. Move the marquee box to select the part of the image to use.

Press the [▲], [▼], [◀] and [▶] buttons to select the part of the image to use as the user's logo, and then press the [Enter] button.

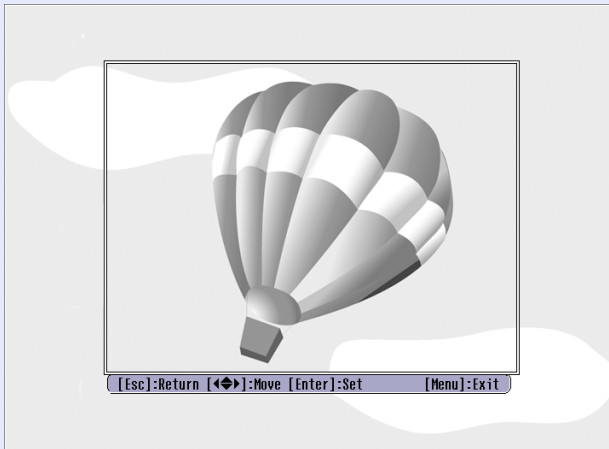

**TIP**

*User's logos can be saved at up to 480 × 360 dots in size.*

- 5** Select "Yes" at the confirmation screen, and then press the [Enter] button.

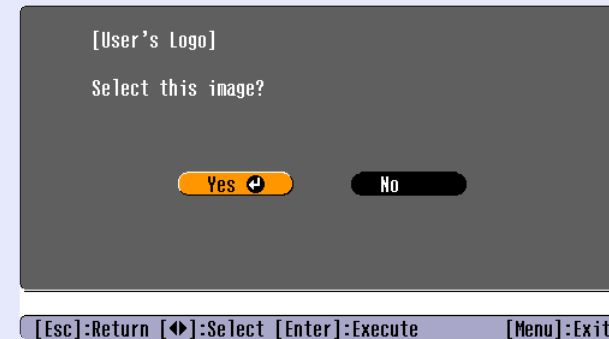

- 6** Select the zoom rate in the Zoom rate setting screen, and then press the [Enter] button.

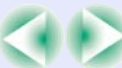
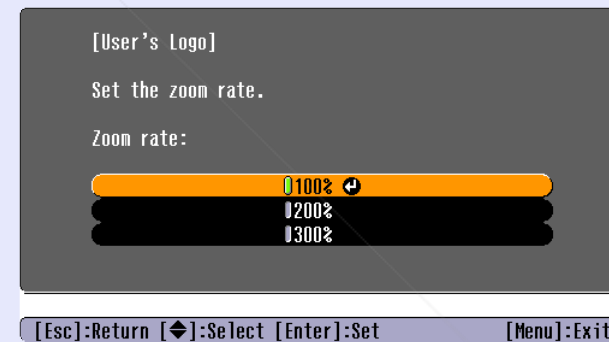

**7** Select "Yes" at the confirmation screen, and then press the [Enter] button.

The image will then be saved. Once the image has been saved, the message "Completed" will be displayed.

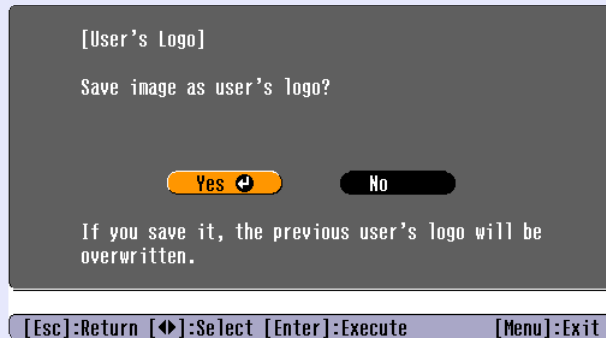

**TIP**

- *Saving the user's logo may take a few moments (about 15 seconds). Do not use the projector or any other sources which are connected to the projector while the user's logo is being saved, otherwise it may result in errors in projector operation.*
- *Once a user's logo has been saved, the logo setting cannot be returned to the factory default.*



The following optional accessories are available for purchase if required. This list of optional accessories is current as of July 2003. Details of accessories are subject to change without notice.

---

**Soft carry case ELPKS16**

Use this case if you need to carry the projector by hand.

---

**Spare lamp ELPLP27**

Use as a replacement for spent lamps.

---

**Filter kit ELPAF05**

(5 air filters)

These is the same as the projector's accessory air filters.

---

**60" screen ELPSC07**

80" screen ELPSC08

100" screen ELPSC10

A portable roll-type screen. ([Aspect ratio](#)▶ 4:3)

---

**50" portable screen ELPSC06**

A compact screen which can be carried easily. (Aspect ratio 4:3)

---

**VGA-HD15 PC cable ELPKC02**

(1.8 m (6 ft.) - for mini D-Sub 15-pin/mini D-Sub 15-pin)

This is the same computer cable as the projector's accessory computer cable.

---

**VGA-HD15 PC cable ELPKC09**

(3 m (9.8 ft.) - for mini D-Sub 15-pin/mini D-Sub 15-pin)

---

**VGA-HD15 PC cable ELPKC10**

(20 m (65.6 ft.) - for mini D-Sub 15-pin/mini D-Sub 15-pin)

Use this extension cable if the accessory computer cable is too short.

---

**Remote control unit ELPST13**

This is the same remote control as the projector's accessory remote control.

---

**VGA-HD15/BNC PC Cable ELPKC11**

(1.8 m (6 ft.) - for mini D-Sub 15-pin/5BNC)

Use in order to connect the projector to a computer with a 5BNC port.

---

**Component video cable ELPKC19**

(3 m (9.8 ft.) - for mini D-Sub 15-pin/RCA male × 3)

Use to connect a [component video](#)▶ source.

---

**Ceiling mount \* ELPMB12**

Use when installing the projector to a ceiling.

---

**Ceiling plate \* ELPFC03**

Pipe 370 (370 mm (14.57 in.)/silver)\* ELPFP04

Pipe 570 (570 mm (22.44 in.)/silver)\* ELPFP05

Pipe 770 (770 mm (30.31 in.)/silver)\* ELPFP06

Use when installing the projector to a high ceiling or a ceiling with veneer panels.

---

**Image presentation camera ELPDC02**

ELPDC03

ELPDC04

Use when projecting books, OHP films and slides.

\* A special method of installation is required in order to suspend the projector from the ceiling. Please contact the place of purchase if you would like to use this installation method.

Following is an explanation of some of the terms used in this guide which may be unfamiliar or which are not explained in the text of this guide itself. Further information can be obtained by referring to other commercially-available publications.

5BNC	A port used to input analogue video signals.
Abs. Color Temp.	The temperature of an object which is emitting light. If the absolute colour temperature is high, the colours tend to take on a bluish tinge. If the absolute colour temperature is lower, the colours tend to take on a reddish tinge.
Aspect ratio	The ratio between an image's length and its height. HDTV images have an aspect ratio of 16:9 and appear elongated. The aspect ratio for standard images is 4:3.
Component video	Video signals which have the video brightness signals and colour signals separated, in order to provide better image quality. In high-definition TV (HDTV), it refers to images which consist of three independent signals: Y (luminance signal), and Pb and Pr (colour difference signals).
Composite video	Video signals which have the video brightness signals and colour signals mixed together. The type of signals commonly used by household video equipment (NTSC, PAL and SECAM formats). The carrier signal Y (luminance signal) and chroma (colour) signal which are contained in the colour bar are overlapped to form a single signal.
Contrast	The relative brightness of the light and dark areas of an image can be increased or decreased in order to make text and graphics stand out more clearly, or to make them appear softer. Adjusting this particular property of an image is called "contrast adjustment".
Cool-down	This is the process by which the projector's lamp is cooled down after it has become hot through use. Cool-down is carried out automatically when the [Power] button is pressed to turn off the power. Do not disconnect the power cable while cool-down is in progress, otherwise the cool-down process will not work properly. If the cool-down period is not allowed to finish normally, the projector's lamp and internal components will remain at high temperatures, and this may shorten the operating life of the lamp or cause problems with the operation of the projector.
Dolby Digital	A sound format developed by Dolby Laboratories. Normal stereo is a 2-channel format which uses two speakers. Dolby Digital is a 6-channel (5.1-channel) system which adds to this a centre speaker two rear speakers and a sub-woofer.
EMP Link 21L	A utility software program that allows the projector to be connected to a computer so that the computer can be used to control the projector. For details on acquiring the software and for instructions on using the software and compatible projector models, please visit the Web site <a href="http://www.epson.co.uk/support/download/projector.htm">http://www.epson.co.uk/support/download/projector.htm</a> .
HDTV	An abbreviation for High-Definition Television. It refers to high-definition systems which satisfy the following conditions. <ul style="list-style-type: none"> <li>• Vertical resolution of 750p or 1125i or greater (p = <a href="#">progressive scanning</a>, i = <a href="#">interlaced scanning</a>)</li> <li>• <a href="#">Aspect Ratio</a> of 16:9</li> <li>• <a href="#">Dolby Digital</a> audio reception and playback (or output)</li> </ul>
Interlaced scanning	A method of image scanning whereby the image data is divided into fine horizontal lines which are displayed in sequence starting from left to right and then from the top to the bottom of the screen. The even-numbered lines and odd-numbered lines are displayed alternately.
Progressive scanning	A method of image scanning whereby the image data from a single image is scanned sequentially from top to bottom to create a single image.





Refresh rate	The light-emitting element of a display maintains the same luminosity and colour for an extremely short time. Because of this, the image must be scanned many times per second in order to refresh the light-emitting element. The number of refresh operations per second is called the "refresh rate", and is expressed in hertz (Hz).
Resize display	This function is used to project computer images that have a resolution more than or less than the projector's panel resolution to be projected so that they fill the whole of the projection area.
SDTV	An abbreviation for Standard Definition Television. It refers to standard television systems which do not satisfy the conditions for High-Definition Television.
Security lock	A device consisting of a projector case with a hole in it that a commercially-available theft-prevention cable can be passed through in order to secure the device to a table or pillar. This projector is compatible with the Microsaver Security System manufactured by Kensington.
Squeeze mode	In this mode, wide-screen images in 16:9 mode are compressed in the horizontal direction so that they are stored on the recording medium as 4:3 images. When these images are played back by the projector in squeeze mode, they are restored to their original 16:9 format.
sRGB	An international standard for colour intervals that was formulated so that colours which are reproduced by video equipment can be handled easily by computer operating systems (OS) and the Internet.
SVGA	A type of video signal with a resolution of 800 (horizontal) × 600 (vertical) dots which is used by IBM PC/AT-compatible computers.
S-Video	A video signal which has the luminance component and colour component separated in order to provide better image quality. It refers to images which consist of two independent signals: Y (luminance signal), and C (colour signal).
SXGA	A type of video signal with a resolution of 1280 (horizontal) × 1024 (vertical) dots which is used by IBM PC/AT-compatible computers.
Sync. (Synchronization)	The signals output from computers and RGB video equipment have a specific frequency. If the projector frequency does not match this frequency, the resulting images will not be of a good quality. The process of matching the phases of these signals (the relative position of the crests and troughs in the signal) is called "synchronisation". If the signals are not synchronized, problems such as flickering, blurriness and horizontal interference can occur.
Tracking	The signals output from computers and RGB video equipment have a specific frequency. If the projector frequency does not match this frequency, the resulting images will not be of a good quality. The process of matching the frequency of these signals (the number of crests in the signal) is called "tracking". If tracking is not carried out correctly, wide vertical stripes will appear in the projected images.
USB	An abbreviation for Universal Serial Bus. USB is an interface for connecting personal computers to peripheral devices which support relatively low data transmission speeds.
UXGA	A type of video signal with a resolution of 1600 (horizontal) × 1200 (vertical) dots which is used by IBM PC/AT-compatible computers.
VGA	A type of video signal with a resolution of 640 (horizontal) × 480 (vertical) dots which is used by IBM PC/AT-compatible computers.

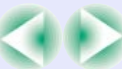

XGA	A type of video signal with a resolution of 1024 (horizontal) × 768 (vertical) dots which is used by IBM PC/AT-compatible computers.
YCbCr	The carrier signal which is contained in the colour bar signal used in modern TV transmissions. The name comes from the Y (luminance) signal and the CbCr (chroma (colour)) signals.
YPbPr	The carrier signal which is contained in the colour bar signal used in high-definition TV (HDTV) transmissions. The name comes from the Y (luminance) signal and the PbPr (colour difference) signals.



## Command List

When a power ON command is sent to the projector, the power for the projector turns on. When the projector is in a command ready state, it returns the "3Ah" (:) code. Furthermore, when command processing is complete, the projector also returns a ":" code.

The ":" code status can be used to determine whether the projector is ready or busy. If command processing terminates with an error, an error message is output and then the ":" code is sent.

	Item	Command
Power ON/OFF	ON	PWR ON
	OFF	PWR OFF
Signal selection	Computer1	SOURCE 11
	Component Video1 (YCbCr)	SOURCE 14
	Component Video1 (YPbPr)	SOURCE 15
	Computer2	SOURCE 21
	Component Video2 (YCbCr)	SOURCE 24
	Component Video2 (YPbPr)	SOURCE 25
	Video	SOURCE 41
	S-Video	SOURCE 42
A/V Mute ON/OFF	ON	MUTE ON
	OFF	MUTE OFF
A/V Mute Selection	Black	MSEL 00
	Blue	MSEL 01
	User's Logo	MSEL 02

## Communication Protocol

- Standard baud rate : 9600 bps
- Data length : 8 bits
- Parity : None
- Stop bit : 1 bit
- Flow control : None
- Connector shape : D-Sub 9-pin (male)
- Projector input port : Control (RS-232C)

## Cable Layouts

### Serial connection

- Connector shape : D-Sub 9 pin (male)
- Projector input connector : Control (RS-232C)

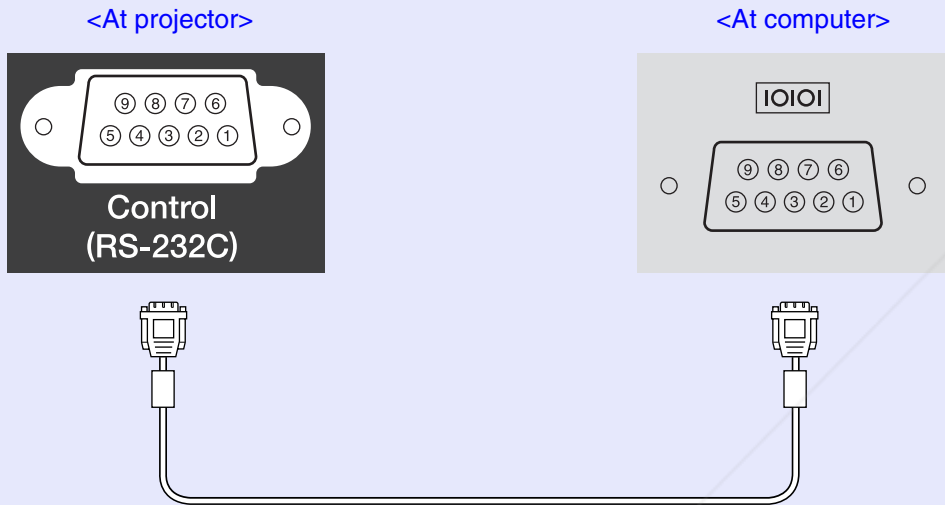

<At projector>	(PC serial cable)	<At computer>	Signal	Function
GND 5	—————	5 GND	GND	Signal wire ground
RD 2	←————	3 TD	TD	Transmit data
TD 3	————→	2 RD	RD	Receive data
DTR 4	————→	6 DSR	DSR	Data set ready
DSR 5	←————	4 DTR	DTR	Data terminal ready

### USB connection

- Connector shape : USB (type B)

<At projector>

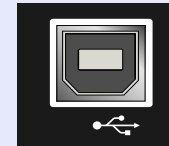

(type B)

<At computer>

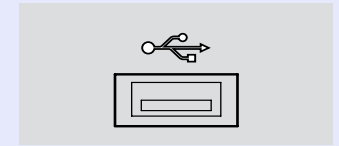

## USB Connection Setup

In order to control the projector using ESC/VP21 commands via a USB connection, the following preparations must be carried out.

### PROCEDURE

- 1** Download the [EMP Link 21L](#) utility software from the EPSON web site to the computer being used.

For details on acquiring the software, please visit the Web site <http://www.epson.co.uk/support/download/projector.htm>.

- 2** The USB driver (USB-Com Driver) will be downloaded together with the utility software, so install this USB driver into the computer that is to be used.

Refer to the EMP Link21L User's Guide that is downloaded together with the utility software for instructions on installing the USB driver.

- 3** Change the "COM Port" setting in the "Advanced" menu to "USB".

- 4** Turn the projector's power off.

- 5** After the [cool-down](#) period has finished, turn the projector's power back on.

Once the projector's power has turned back on, communication via a USB Connection will then be possible.



*If the power cable is disconnected before cool-down has finished, the communication port will not be changed.*

## ■ Computer/RGB Video

Signal	Refresh rate» (Hz)	Resolution (dots)	Resolutions for resize display» (dots)	
			EMP-74	EMP-54
			PC98	
<a href="#">VGA»</a>	60	640×480	1024×768	800×600
VGACGA		640×400	1024×640	800×500
VGAEGA		640×350	1024×560	800×438
VGA text		720×400	1024×568	800×444
		720×350	1024×498	800×388
VESA	60/72/75/85,iMac*	640×480	1024×768	800×600
<a href="#">SVGA»</a>	56/60/72/75/85,iMac*	800×600	1024×768	800×600
<a href="#">XGA»</a>	43i/60/70/75/85,iMac*	1024×768	1024×768	800×600
<a href="#">SXGA»</a>	70/75/85	1152×864	1024×768	800×600
SXGA	60/75/85	1280×960	1024×768	800×600
SXGA	43i/60/75/85	1280×1024	960×768	750×600
<a href="#">UXGA»</a>	48i/60	1600×1200	1024×768	-
MAC13"		640×480	1024×768	800×600
MAC16"		832×624	1024×768	800×600
MAC19"		1024×768	1024×768	800×600
MAC19"	60	1024×768	1024×768	800×600
MAC21"		1152×870	1016×768	794×600
<a href="#">SDTV»</a> (625i)	50	720×540	1024×768	800×600
SDTV(525i)	60	640×480	1024×768	800×600
SDTV(525p)	60	640×480	1024×768	800×600
<a href="#">HDTV»</a> (750p)	60	1280×720	1024×576	800×450
HDTV(1125i)	60	1920×1080	1024×576	800×450

\* Connection is not possible if the equipment does not have a VGA output port.

## ■ Component Video/RGB Video

Signal	Refresh rate» (Hz)	Resolutions (dots)			
		EMP-74		EMP-54	
		Aspect ratio» 4:3	Aspect ratio 16:9	Aspect ratio 4:3	Aspect ratio 16:9
<a href="#">SDTV»</a> (525i) (D1)	60	1024×768	1024×576	800×600	800×450
SDTV (625i)	50	1024×768	1024×576	800×600	800×450
SDTV (525p) (D2)	60	1024×768	1024×576	800×600	800×450
<a href="#">HDTV»</a> (750p) 16:9 (D4)	60	1024×768	1024×576	800×600	800×450
HDTV (1125i) 16:9 (D3)	60	1024×768	1024×576	800×600	800×450

## ■ Composite Video/S-Video

Signal	Refresh rate» (Hz)	Resolutions (dots)			
		EMP-74		EMP-54	
		Aspect ratio» 4:3	Aspect ratio 16:9	Aspect ratio 4:3	Aspect ratio 16:9
TV (NTSC)	60	1024×768	1024×576	800×600	800×450
TV (PAL, SECAM)	60	1024×768	1024×576	800×600	800×450

The projection of some signals not listed in the table may still be possible. However, not all functions may be supported.

Product name	Multimedia Projector EMP-74/54	
Dimensions	315 (W) × 87 (H) × 240 (D) mm (12.4 (W) × 3.43 (H) × 9.45 (D) in.) (not including feet)	
Panel size	0.7 inches	
Display method	Polysilicon TFT active matrix	
Resolution	EMP-74 : <a href="#">XGA</a> ▶ 786,432 pixels (1024 (W) × 768 (H) dots) × 3 EMP-54 : <a href="#">SVGA</a> ▶ 480,000 pixels (800 (W) × 600 (H) dots) × 3	
Focus adjustment	Manual	
Zoom adjustment	Manual (approx. 1:1.2)	
Lamp (light source)	UHE lamp, 200 W, Model No.: ELPLP27	
Max. audio output	1W monaural	
Speaker	1	
Power supply	100–240VAC 50/60Hz 3.2–1.6A	
Operating temperature	+5°– +35°C (41°–95°F) (No condensation)	
Storage temperature	-10°– +60°C (14°–140°F) (No condensation)	
Weight	Approx. 2.9 kg (6.4 lbs)	
Connectors	Monitor Out :	1 Mini D-Sub 15-pin (female) Black
	Computer1/ Component Video1:	1 Mini D-Sub 15-pin (female) Blue
	Computer2/ Component Video2:	1 Mini D-Sub 15-pin (female) Blue
	S-Video:	1 Mini DIN 4-pin
	Video:	1 RCA pin jack
	USB*:	1 USB connector (B series)
	Audio1:	1 Stereo mini jack
	Audio2:	1 Stereo mini jack
	Control (RS-232C):	1 D-Sub 9-pin (male)

## Safety

### USA

UL1950 3<sup>rd</sup> Edition

### Canada

CSA C22.2 No.950-95 (cUL)

### European Community

The Low Voltage Directive (73/23/EEC)

IEC60950 2<sup>nd</sup> Edition, +Amd.1, +Amd.2, +Amd.3,  
+Amd.4

## EMC

### USA

FCC 47CFR Part15B Class B (DoC)

### Canada

ICES-003 Class B

### European Community

The EMC Directive (89/336/EEC)

EN55022, 1998 Class B

EN55024, 1998

IEC61000-4-2, IEC61000-4-3, IEC61000-4-4,

IEC61000-4-5,

IEC61000-4-6, IEC61000-4-8, IEC61000-4-11,

IEC61000-3-2, IEC61000-3-3

### Australia/New Zealand

AS/NZS 3548:1995, A1:1997, A2:1997 Class B

CISPR Pub.22:1993, A1:1995, A2:1996, Class B

\* The USB interface complies with the USB 1.1 standard. The USB connector is not guaranteed to operate correctly with all USB-compatible devices.

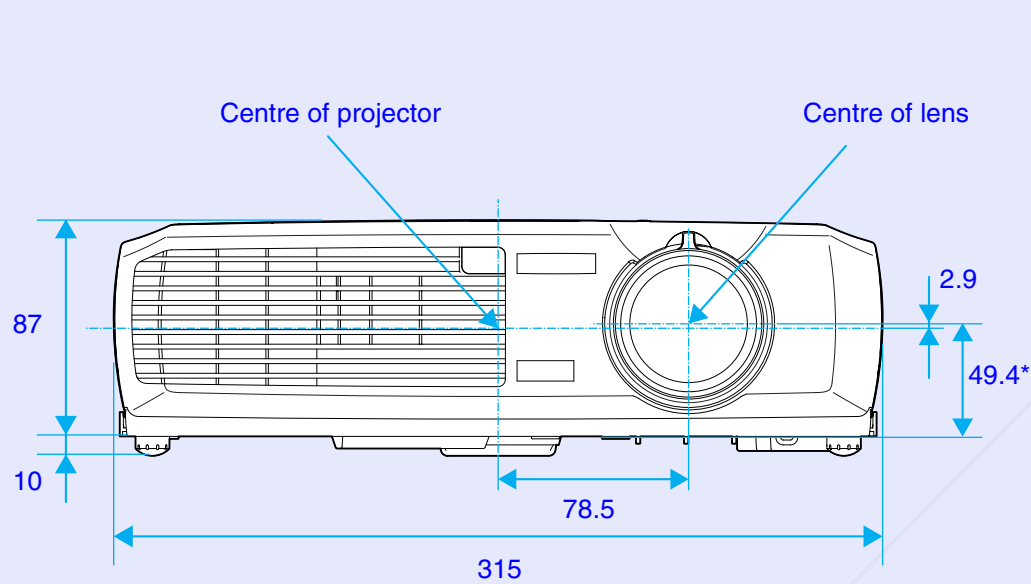

\*Distance from center of lens to suspension bracket fixing point

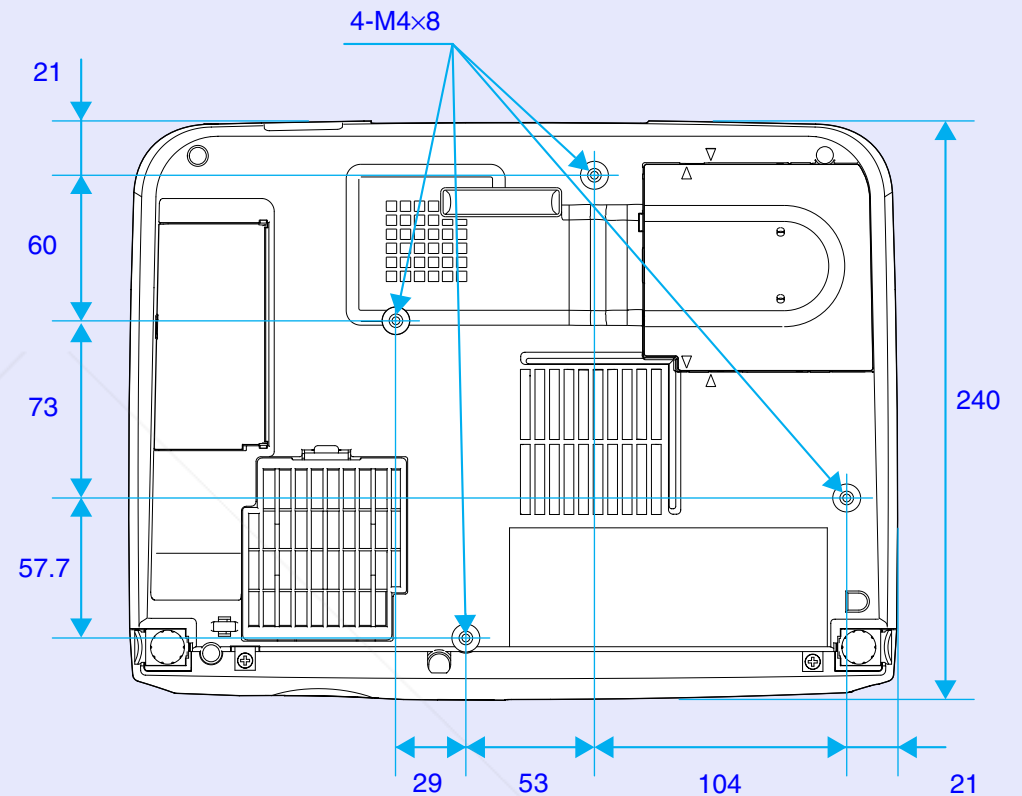

Units: mm



## General Terms

13w3 Port..... 17  
5BNC Port ..... 18

## A

Abs. Color Temp. .... 62  
"Advanced" Menu ..... 61  
Air exhaust vent..... 7  
Air filter ..... 10  
Air intake vent ..... 10  
Analogue-RGB ..... 51, 64  
Aspect ratio..... 48  
[Audio1] port ..... 9, 25  
[Audio2] port ..... 9, 25  
"Audio" Menu..... 57  
Auto Keystone ..... 58  
Automatic Setup ..... 41  
Auto Setup ..... 41, 52  
A/V cable..... 22, 25  
A/V Mute..... 46, 58

## B

Background Color ..... 58  
Battery holder ..... 84  
Blackboard..... 44, 52, 55  
Brightness ..... 51, 54  
Brightness Control..... 61

## C

Cleaning the Air Filter ..... 83  
Cleaning the Lens..... 83  
Cleaning the Projector Case..... 83  
Color..... 54  
Color Adjustment ..... 62  
Color Mode ..... 44, 52, 55  
Component video ..... 23  
COM Port..... 63  
Composite video..... 22  
[Computer1/Component Video1]  
port ..... 9  
[Computer2/Component Video2]  
port ..... 9  
Computer cable ..... 17, 24  
Connecting to a Computer ..... 16  
Connecting to a Video Source..... 22  
Contrast ..... 51, 54  
Control Panel..... 8  
[Control (RS-232C)] port..... 9  
Cool-down..... 35, 71  
Cross..... 49

## D

Dynamic..... 44, 52, 55

## E

Eligible computers ..... 16  
EMP Link21L ..... 99  
ESC/VP21 ..... 97  
E-Zoom ..... 49

## F

Focus..... 37  
Focus ring ..... 7  
Foot adjustment ..... 38  
Freeze..... 47  
Frequency ..... 64

## G

Glossary ..... 94

## H

HDTV ..... 100  
Help function ..... 69  
High ..... 61

## I

Image Menu..... 51  
Image size ..... 15, 37  
Indicators ..... 7, 71

"Info" Menu..... 64  
Input resolution ..... 64  
Input Signal ..... 52, 55, 64  
Inserting the Battery ..... 84

## K

Keystone ..... 38, 58

## L

Lamp cover..... 10  
Lamp Hours..... 64  
Lamp-Hours Reset..... 64, 88  
Lamp replacement period..... 85  
Language ..... 63  
Lens cover ..... 7  
Living Room ..... 44, 52, 55  
Low..... 61

## M

Main menu..... 50  
Manually Correcting Keystone  
Distortion..... 40  
Menu..... 50  
Message ..... 58  
Mini D-Sub 15-pin port..... 17  
[Monitor Out] port..... 9  
Mouse pointer..... 19



FixYourDLP.com  
Sponsored by DLP

Discount-Merchant.com (800) 281-8860  
THE TRUSTED SOURCE FOR PROJECTOR LAMPS AND ACCESSORIES



**N**

Numeric buttons ..... 11

**O**

Operating distance  
(Remote control)..... 13

Operating range  
(Remote control)..... 13

Operating temperature ..... 101

Optional accessories ..... 93

Overheating ..... 72

**P**

Part Names and Functions ..... 7

Password Protect ..... 27

Password Protect stickers ..... 28

Port ..... 9, 34

Position ..... 41, 51, 54

Power cable ..... 32

Power indicator..... 7

Power inlet..... 9

Power ON Protect..... 27

Presentation ..... 44, 52, 55

Projecting Images ..... 33

Projection..... 62

Projection angle ..... 39

Projection distance..... 15

**R**

Refresh Rate ..... 64

Remote control ..... 11, 12, 19

Remote control light-emitting  
area ..... 11

Remote control light-receiving  
area ..... 7, 9

Replacing the Air Filter..... 89

Replacing the Lamp ..... 86

Request code ..... 27

"Reset All" Menu ..... 65

Resized display..... 100

Resolution ..... 100

RGB..... 62

RGB Video..... 24

**S**

Screen size..... 15

Security lock..... 9

"Setting" Menu..... 58

Setting Up the Projector ..... 14

Sharpness..... 51, 54

Sleep mode..... 58

Source..... 64

Speaker ..... 7, 25

Specifications ..... 101

Squeeze mode..... 48

sRGB ..... 44, 52, 55

Startup screen..... 61

Stereo mini jack audio cable..... 25

Storage temperature ..... 101

Sub-menu ..... 50

Supported Monitor Displays..... 100

Suspension bracket  
fixing point..... 10, 102

S-Video ..... 23, 54, 64

[S-Video] port..... 9

Sync ..... 41, 51

SYNC Mode ..... 64

SYNC Polarity ..... 64

**T**

Theatre ..... 44, 52, 55

Tint..... 54

Tracking..... 41, 51

Translucent screen ..... 14

Turning off..... 35

**U**

USB cable ..... 19

USB connection ..... 99

USB mouse ..... 19

[USB] port ..... 9

User's Logo ..... 46, 90

"User's Logo" Menu ..... 60

User's Logo Protect ..... 28

Using the Configuration Menu  
Functions ..... 50

**V**

Video ..... 54, 64

Video Signal ..... 56, 64

[Video] port ..... 9

Volume ..... 57

**W**

Warning indicator..... 7

When Having Some Trouble..... 71

Wide-screen Projection ..... 48

Wireless Mouse Function..... 19

Workstation ..... 17

**Y**

YCbCr ..... 34, 54, 64

YPbPr ..... 34, 54, 64

**Z**

Zoom ring ..... 7

Discount-Merchant.com (800) 281-8860  
Sponsored by  
THE TRUSTED SOURCE FOR PROJECTOR LAMPS AND ACCESSORIES



**DECLARATION of CONFORMITY**

According to 47CFR, Part 2 and 15  
Class B Personal Computers and Peripherals; and/or  
CPU Boards and Power Supplies used with Class B  
Personal Computers

We :EPSON AMERICA, INC.  
Located at :3840 Kilroy Airport Way  
MS: 3-13  
Long Beach, CA 90806  
Tel :562-290-5254

Declare under sole responsibility that the product identified herein, complies with 47CFR Part 2 and 15 of the FCC rules as a Class B digital device. Each product marketed, is identical to the representative unit tested and found to be compliant with the standards. Records maintained continue to reflect the equipment being produced can be expected to be within the variation accepted, due to quantity production and testing on a statistical basis as required by 47CFR 2.909. Operation is subject to the following two conditions : (1) this device may not cause harmful interference, and (2) this device must accept any interference received, including interference that may cause undesired operation.

Trade Name :EPSON  
Type of Product :Projector  
Model :EMP-74/54

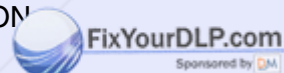

**Discount-Merchant.com (800) 281-8860**  
**THE TRUSTED SOURCE FOR PROJECTOR LAMPS AND ACCESSORIES**

**FCC Compliance Statement  
For United States Users**

This equipment has been tested and found to comply with the limits for a Class B digital device, pursuant to Part 15 of the FCC Rules. These limits are designed to provide reasonable protection against harmful interference in a residential installation. This equipment generates, uses, and can radiate radio frequency energy and, if not installed and used in accordance with the instructions, may cause harmful interference to radio or television reception. However, there is no guarantee that interference will not occur in a particular installation. If this equipment does cause interference to radio and television reception, which can be determined by turning the equipment off and on, the user is encouraged to try to correct the interference by one or more of the following measures.

- Reorient or relocate the receiving antenna.
- Increase the separation between the equipment and receiver.
- Connect the equipment into an outlet on a circuit different from that to which the receiver is connected.
- Consult the dealer or an experienced radio/TV technician for help.

**WARNING**

The connection of a non-shielded equipment interface cable to this equipment will invalidate the FCC Certification or Declaration of this device and may cause interference levels which exceed the limits established by the FCC for this equipment. It is the responsibility of the user to obtain and use a shielded equipment interface cable with this device. If this equipment has more than one interface connector, do not leave cables connected to unused interfaces. Changes or modifications not expressly approved by the manufacturer could void the user's authority to operate the equipment.

All rights reserved. No part of this publication may be reproduced, stored in a retrieval system, or transmitted in any form or by any means, electronic, mechanical, photocopying, recording, or otherwise, without the prior written permission of SEIKO EPSON CORPORATION. No patent liability is assumed with respect to the use of the information contained herein. Neither is any liability assumed for damages resulting from the use of the information contained herein.

Neither SEIKO EPSON CORPORATION nor its affiliates shall be liable to the purchaser of this product or third parties for damages, losses, costs, or expenses incurred by purchaser or third parties as a result of: accident, misuse, or abuse of this product or unauthorized modifications, repairs, or alterations to this product, or (excluding the U.S.) failure to strictly comply with SEIKO EPSON CORPORATION's operating and maintenance instructions.

SEIKO EPSON CORPORATION shall not be liable against any damages or problems arising from the use of any options or any consumable products other than those designated as Original EPSON Products or EPSON Approved Products by SEIKO EPSON CORPORATION.

**General Notice:**

EPSON is a registered trademark of SEIKO EPSON CORPORATION. Macintosh, Mac, and iMac are registered trademarks of Apple Computer, Inc.

IBM is a registered trademark of International Business Machines Corporation.

Windows and Windows NT are trademarks of Microsoft Corporation in the United States of America.

Dolby is registered trademarks of Dolby Laboratories.

Other product names used herein are also for identification purposes only and may be trademarks of their respective owners. EPSON disclaims any and all rights in those marks.



**Discount-Merchant.com (800) 281-8860**  
THE TRUSTED SOURCE FOR PROJECTOR LAMPS AND ACCESSORIES



# Disclaimer

This user manual is provided as a free service by FixYourDLP.com. FixYourDLP is in no way responsible for the content of this manual, nor do we guarantee its accuracy. FixYourDLP does not make any claim of copyright and all copyrights remain the property of their respective owners.

About FixYourDLP.com

FixYourDLP.com (<http://www.fixyourdpl.com>) is the World's #1 resource for media product news, reviews, do-it-yourself guides, and manuals.

Informational Blog: <http://www.fixyourdpl.com>

Video Guides: <http://www.fixyourdpl.com/guides>

User Forums: <http://www.fixyourdpl.com/forum>

FixYourDLP's Fight Against Counterfeit Lamps:

<http://www.fixyourdpl.com/counterfeits>

## Sponsors:

RecycleYourLamp.org – Free lamp recycling services for used lamps:

<http://www.recycleyourlamp.org>

Lamp Research - The trusted 3rd party lamp research company:

<http://www.lampresearch.com>

Discount-Merchant.com – The worlds largest lamp distributor:

<http://www.discount-merchant.com>



**FixYourDLP.com**

Sponsored by 