



Disclaimer

This user manual is provided as a free service by FixYourDLP.com. FixYourDLP is in no way responsible for the content of this manual, nor do we guarantee its accuracy. FixYourDLP does not make any claim of copyright and all copyrights remain the property of their respective owners.

About FixYourDLP.com

FixYourDLP.com (<http://www.fixyourdpl.com>) is the World's #1 resource for media product news, reviews, do-it-yourself guides, and manuals.

Informational Blog: <http://www.fixyourdpl.com>

Video Guides: <http://www.fixyourdpl.com/guides>

User Forums: <http://www.fixyourdpl.com/forum>

FixYourDLP's Fight Against Counterfeit Lamps:

<http://www.fixyourdpl.com/counterfeits>

Sponsors:

RecycleYourLamp.org – Free lamp recycling services for used lamps:

<http://www.recycleyourlamp.org>

Lamp Research - The trusted 3rd party lamp research company:

<http://www.lampresearch.com>

Discount-Merchant.com – The worlds largest lamp distributor:

<http://www.discount-merchant.com>



FixYourDLP.com

Sponsored by 



EPSON PowerLite® 5300/7200/7300 User's Guide

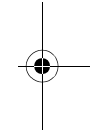
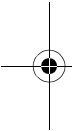

FixYourDLP.com

Sponsored by 

Discount-Merchant.com (800) 281-8860

THE TRUSTED SOURCE FOR PROJECTOR LAMPS AND ACCESSORIES





All rights reserved. No part of this publication may be reproduced, stored in a retrieval system, or transmitted in any form or by any means, electronic, mechanical, photocopying, recording, or otherwise, without the prior written permission of SEIKO EPSON CORPORATION. No patent liability is assumed with respect to the use of the information contained herein. Neither is any liability assumed for damages resulting from the use of the information contained herein.

Neither SEIKO EPSON CORPORATION nor its affiliates shall be liable to the purchaser of this product or third parties for damages, losses, costs, or expenses incurred by purchaser or third parties as a result of: accident, misuse, or abuse of this product or unauthorized modifications, repairs, or alterations to this product, or (excluding the U.S.) failure to strictly comply with SEIKO EPSON CORPORATION's operating and maintenance instructions.

SEIKO EPSON CORPORATION shall not be liable against any damages or problems arising from the use of any options or any consumable products other than those designated as Original EPSON Products or EPSON Approved Products by SEIKO EPSON CORPORATION.

EPSON and PowerLite are registered trademarks of SEIKO EPSON CORPORATION.

SoundAdvice is a service mark and FaxAdvice is a trademark of Epson America, Inc.

General Notice: Other product names used herein are for identification purposes only and may be trademarks of their respective owners. EPSON disclaims any and all rights in those marks.

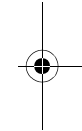
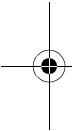

Copyright © 1998 by Epson America, Inc.
Torrance, California, USA

CPD-7925
7541655
12/98



Discount-Merchant.com (800) 281-8860
THE TRUSTED SOURCE FOR PROJECTOR LAMPS AND ACCESSORIES

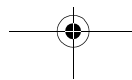



Important Information About Your Projector

Important Safety Information

WARNING: Never look into the projector lens when the lamp is turned on; the bright light can damage your eyes. Never let children look into the lens when it is on. Never open any cover on the projector, except the lamp and filter covers. Dangerous electrical voltages inside the projector can severely injure you. Except as specifically explained in this User's Guide, do not attempt to service this product yourself. Refer all servicing to qualified service personnel.

WARNING: The projector and its accessories come packaged in plastic bags. Keep plastic bags away from small children to avoid any risk of suffocation.

Caution: When you replace the lamp, never touch the new lamp with your bare hands; the invisible residue left by the oil on your hands may shorten the lamp life. Use a cloth or glove to handle the new lamp.

Remote Control Information

You can operate the projector by remote control via a line-of-sight infrared (IR) receiver at the front and rear of the projector. The projector may not respond to remote control commands under the following conditions:

- There is an object between the remote control IR emitter and the IR receiver on the projector.
- Ambient light is too bright.
- Certain types of fluorescent lighting are used.
- A strong light source shines into the IR receiver.
- Other equipment that emits infrared energy, such as a radiant room heater, is in the room.

These conditions commonly cause problems for most infrared-controlled equipment. Try the following:

- The remote control unit's batteries may be low on power; replace them.
- Dim the ambient lighting and/or turn off any fluorescent lights.
- Close any window coverings and/or move the projector out of direct sunlight.
- Turn off other equipment that emits infrared energy.

If the remote control still does not work properly, remember you can always control your computer-based presentation directly from the computer, even in an environment containing one of the conditions listed above.



FixYourDLP.com

Sponsored by 

Discount-Merchant.com (800) 281-8860

THE TRUSTED SOURCE FOR PROJECTOR LAMPS AND ACCESSORIES

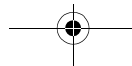
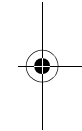
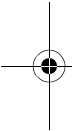



FCC Compliance Statement For United States Users

This equipment has been tested and found to comply with the limits for a Class B digital device, pursuant to Part 15 of the FCC Rules. These limits are designed to provide reasonable protection against harmful interference in a residential installation. This equipment generates, uses, and can radiate radio frequency energy and, if not installed and used in accordance with the instructions, may cause harmful interference to radio or television reception. However, there is no guarantee that interference will not occur in a particular installation. If this equipment does cause interference to radio and television reception, which can be determined by turning the equipment off and on, the user is encouraged to try to correct the interference by one or more of the following measures.

- Reorient or relocate the receiving antenna.
- Increase the separation between the equipment and receiver.
- Connect the equipment into an outlet on a circuit different from that to which the receiver is connected.
- Consult the dealer or an experienced radio/TV technician for help.

WARNING

The connection of a non-shielded equipment interface cable to this equipment will invalidate the FCC Certification of this device and may cause interference levels which exceed the limits established by the FCC for this equipment. It is the responsibility of the user to obtain and use a shielded equipment interface cable with this device. If this equipment has more than one interface connector, do not leave cables connected to unused interfaces. Changes or modifications not expressly approved by the manufacturer could void the user's authority to operate the equipment.

For Canadian Users

This Class B digital apparatus meets all requirements of the Canadian Interference-Causing Equipment Regulations.

Cet appareil numérique de la classe B respecte toutes les exigences du Règlement sur le matériel brouilleur du Canada.



Discount-Merchant.com (800) 281-8860
THE TRUSTED SOURCE FOR PROJECTOR LAMPS AND ACCESSORIES

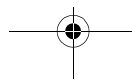
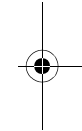
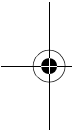

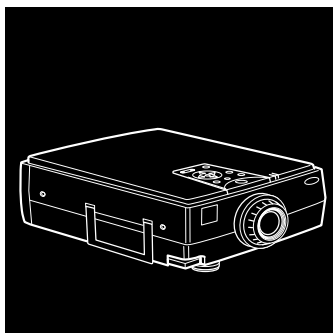

Contents

Introduction	1
Getting the Most Out of Your Projector	3
Optional Accessories	4
About This Guide	5
Where to Get Help	6
Electronic Support Services	6
Automated Telephone Services	7
Safety Instructions	8
1 Setting Up the Projector	11
Unpacking the Projector	12
Additional Components	14
Before You Connect the Projector	15
Installing the Remote Control Batteries	16



Discount-Merchant.com (800) 281-8860
THE TRUSTED SOURCE FOR PROJECTOR LAMPS AND ACCESSORIES



Connecting to a Computer18

- Connecting to a PC Desktop Computer19
- Connecting to a PC Laptop Computer26
- Connecting to a Desktop Macintosh31
- Connecting to a PowerBook40
- Connecting to a High-End Workstation49
- Connecting to a Video Source49

Connecting to an External Speaker or PA System53

Turning the Equipment On and Off54

- Turning the Projector On and Off55

2 Using the Projector 57

Positioning the Projector58

- Calculating Image Size and Projection Distance60

Focusing and Positioning the Screen Image63

- Resize Button65

Sleep Mode65

Controlling the Projector66

- Using the Remote Control67
- Using the Control Panel70

Projector Status Lights72

3 Using the Projector Menus 75

Accessing the Main Menu76

Changing a Menu Setting78

Video Menu (Image Source = Computer)80

Video Menu (Image Source = Video)82

Audio Menu83

Options Menu85

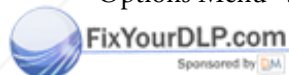

Discount-Merchant.com (800) 281-8860

THE TRUSTED SOURCE FOR PROJECTOR LAMPS AND ACCESSORIES

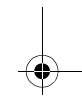
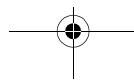
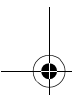
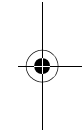
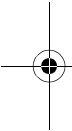

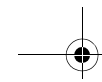

Custom Menu 87
 About Menu 90
 Reset All Menu 90

4 Using the ELP Link III Software 91

Installing the Software 92
 Connecting Needed Cables 92
 Installing the Software for Windows 92
 Installing the Software for a Macintosh 94
 Launching the Software 94
 Launching the Software from Windows 95
 Launching the Software on a Macintosh 96
 Using the Software 96
 Customizing the Remote Control Effects Buttons 96
 Controlling Projector Features 103

5 Maintenance 117

Cleaning the Lens 118
 Cleaning the Projector Case 118
 Cleaning the Air Filter 119
 Replacing the Lamp 120
 Transporting the Projector 123

6 Troubleshooting 125

Problems with the Projector 126
 Problems with the Remote Control 129
 Problems with the Image or Sound 130



Discount-Merchant.com (800) 281-8860
THE TRUSTED SOURCE FOR PROJECTOR LAMPS AND ACCESSORIES

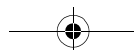

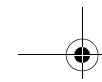

7 Technical Specifications	133
Supported Monitor Displays	137
Glossary	139
Index	141

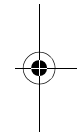
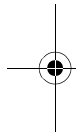

Discount-Merchant.com (800) 281-8860
THE TRUSTED SOURCE FOR PROJECTOR LAMPS AND ACCESSORIES

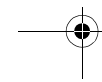
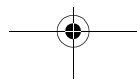

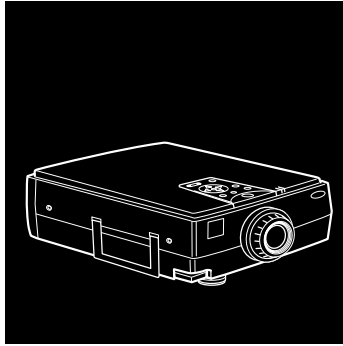

Introduction

Your PowerLite® projector is a brilliant, lightweight, portable projector that allows you to project full-color images and video onto a large screen for presentations. You can connect it simultaneously to three image sources: two computers or workstation sources, plus one video source, such as a VCR or camcorder. You can also connect audio for each image source.

Images are displayed in full color (16,770,000 colors) at an SVGA resolution of 800×600 pixels on the PowerLite 5300, or an XGA resolution of 1024×768 pixels on the PowerLite 7200 and PowerLite 7300. The projector supports a wide variety of video inputs, from VGA to SXGA with resolutions up to 1280×1024 . It produces bright images that can be easily seen in rooms light enough to take notes.

Your projector's two speakers employ a built-in 3D Sound System for rich, powerful audio output. You can even connect an external speaker when further amplification is required.



Discount-Merchant.com (800) 281-8860
THE TRUSTED SOURCE FOR PROJECTOR LAMPS AND ACCESSORIES ¹



For your presentations, you can select front, rear, or ceiling projection. This provides maximum flexibility in choosing the best display method for each environment.

You control your projector through a hand-held remote control unit, with menus provided for image source switching and image adjustment. The remote control can also act as a wireless mouse to control operations on your computer screen during presentations. Additionally, you can install the projector's ELP Link III software to control the projector's settings from your computer and enhance your presentations with special effects.

Your projector features a new patented SizeWise™ chip for support of VGA, SVGA, XGA, and SXGA output. No matter what type of computer output is used, the result is a full-size video image of outstanding clarity.

The projector supports a wide range of computers and workstations: IBM® compatible PCs and laptops, Apple® Macintosh®, Power Macintosh™ and PowerBook™ computers, and workstations such as the Sun® SPARCstation™ (The PowerLite 5300 is not recommended for use with high-end workstations). The video source can be NTSC, PAL, or SECAM. The projector automatically senses the video format, which can be composite video, S-Video, or component video. See Chapter 7 for details on supported computers and video formats.

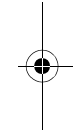
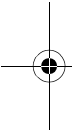

FixYourDLP.com

Sponsored by DM

Discount-Merchant.com (800) 281-8860

2

Introduction

THE TRUSTED SOURCE FOR PROJECTOR LAMPS AND ACCESSORIES

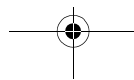



Getting the Most Out of Your Projector

Your projector comes with a full set of features that enable you to control the settings for the image display, video, and audio. To get the most out of the projector, read this section for a quick summary of the important features.

Remote Control

The buttons on the remote control enable you to turn the projector on and off, and provide direct access to blank, freeze, volume, mute, and image source switching. Use the remote control buttons to access custom functions (with the ELP Link III software) and the projector's menu system. You can even use the remote control to control your computer in place of your computer's mouse.

Sleep Mode

Sleep mode conserves electricity by automatically turning off the lamp after the projector has not been used for 30 minutes. In sleep mode, the projector remains on but the lamp is turned off, conserving electricity, cooling the projector, and extending the life of the lamp.

Control Panel

The control panel buttons on the projector duplicate the remote control buttons.

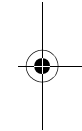
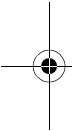

Discount-Merchant.com (800) 281-8860

THE TRUSTED SOURCE FOR PROJECTOR LAMPS AND ACCESSORIES

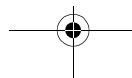

Optional Accessories

To enhance your use of the projector, EPSON provides the following:

- Customized carrying cases for the projector and its cables:

Hard Shell Carrying Case	ELPKS12
Soft Shell Carrying Case	ELPKS10
- Replacement lamp and air filter ELPLP05
- Long throw zoom lens ELPLL01
- Communication kit cable set and computer cable so you can connect your projector to a second computer. There is also a Mac[®] adapter set so you can connect to a second Macintosh. You may also need the VGA-13W3 video cable if you're connecting the projector to a high-end workstation.

ELP communication cable set	ELPKC04
Computer video cable	ELPKC02
Mac adapter set	ELPAP01
VGA-13W3 video cable	ELPKC06
VGA-5BNC video cable	ELPKC07
- Portable projection screen ELPSC06
- Remote control receiver module ELPST02
- Mediaphile[™] PAS ELPPAS1
(personal audio system)

You can purchase these accessories from your dealer or by calling EPSON Accessories at **(800) 873-7766**; or visit our web site at www.epsonsupplies.com (U.S. sales only). In Canada, please call (800) 873-7766 for dealer referral.



Discount-Merchant.com (800) 281-8860



About This Guide

This guide describes how to set up and use the EPSON PowerLite 5300, PowerLite 7200, and PowerLite 7300 projectors. The instructions pertain to all these models, except where otherwise noted.

Chapter 1, "Setting Up the Projector," provides step-by-step instructions on how to set up your projector; connect it to your computer, video source, or other optional equipment; and turn it on.

Chapter 2, "Using the Projector," explains how to position the projector relative to the screen, focus and position the screen image, control the projector using the remote control and the control panel, and monitor the projector's operating status.

Chapter 3, "Using the Projector Menus," describes how to use the projector's built-in menus to adjust the color and image settings, change the display of the projected image, and modify audio settings such as bass and treble.

Chapter 4, "Using the ELP Link III Software," explains how to use the ELP Link III software to control the projector settings from the computer and use the special effects functions.

Chapter 5, "Maintenance," covers basic procedures for maintaining your projector in good working order and gives guidelines for transporting it.

Chapter 6, "Troubleshooting," describes how to interpret your projector's warning lights and gives helpful information for avoiding errors, optimizing image quality, and solving problems.

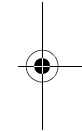
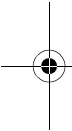

Discount-Merchant.com (800) 281-8860

THE TRUSTED SOURCE FOR PROJECTOR LAMPS AND ACCESSORIES

About This Guide

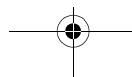

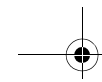

Chapter 7, "Technical Specifications," lists the technical specifications for the projector.

A Glossary and Index are provided at the end of the manual.

Where to Get Help

If you are having trouble setting up or running your projector, first see Chapter 6, "Troubleshooting." If you cannot resolve the problem, EPSON provides technical assistance through electronic support services and automated telephone services 24 hours a day. The following tables list the contact information.

Electronic Support Services

Service	Access
World Wide Web	From the Internet, you can reach EPSON's Home Page at http://www.epson.com .
EPSON Internet FTP Site	If you have Internet FTP capability, use your Web browser (or other software for FTP downloading) to log onto ftp.epson.com with the user name anonymous and your e-mail address as the password.
EPSON Download Service	You can call the EPSON Download Service at (800) 442-2007 . Set your communications software to 8 data bits, 1 stop bit, no parity. Modem speed can be up to 28.8 Kbps.
EPSON Forum on CompuServe®	Members of CompuServe can type GO EPSON at the menu prompt to reach the Epson America Forum. For a free introductory CompuServe membership, call (800) 848-8199 and ask for representative #529.



Discount-Merchant.com (800) 281-8860

6 Introduction

THE TRUSTED SOURCE FOR PROJECTOR LAMPS AND ACCESSORIES

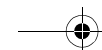

Automated Telephone Services

Service	Access
EPSON SoundAdvice SM	For pre-recorded answers to commonly asked questions about EPSON products 24 hours a day, seven days a week, call (800) 922-8911 .
EPSON FaxAdvice TM	Access EPSON's technical information library by calling (800) 922-8911 . You must provide a return fax number to use this service.
EPSON Referral Service	For the location of your nearest Authorized EPSON Reseller or Customer Care Center, call (800) 922-8911 .

When you need support, follow the calling instructions on the back of the EPSON Private Line Technical Support card included with the projector. Technical support is also available by calling (800) 974-1202 between 6 AM and 6 PM, Pacific Time, Monday through Friday. Toll or long distance charges may apply.

Before you call, please have the following information ready:

- Product name
- Product serial number
- Personal identification number (PIN) for EPSON Private Line Technical Support
- Computer configuration
- Description of the problem



Discount-Merchant.com (800) 281-8860

THE TRUSTED SOURCE FOR PROJECTOR LAMPS AND ACCESSORIES Where to Get Help



You can purchase accessories from EPSON Accessories at (800) 873-7766, or visit our web site at www.epsonsupplies.com (U.S. sales only). In Canada, please call (800) 873-7766 for dealer referral.

Safety Instructions

Follow these safety instructions when setting up and using the projector:

1. Do not place the projector on an unstable cart, stand, or table.
2. Do not use the projector near water or sources of heat.
3. Use attachments only as recommended.
4. Use the type of power source indicated on the projector. If you are not sure of the power available, consult your dealer or power company.
5. Place the projector near a wall outlet where the plug can be easily unplugged.
6. Insert the projector's three-wire grounding-type plug into a properly grounded outlet. If you have a two-prong outlet, contact an electrician to replace it. Do not hold the plug with wet hands.
7. Take the following precautions for the plug. Failure to comply with these precautions could result in sparks or fire.
 - Do not insert the plug into an outlet with dust present.
 - Insert the plug firmly into the outlet.

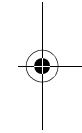
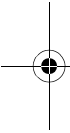

Discount-Merchant.com (800) 281-8860

8

Introduction

THE TRUSTED SOURCE FOR PROJECTOR LAMPS AND ACCESSORIES

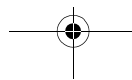

8. Do not overload wall outlets, extension cords, or integral convenience receptacles. This can cause fire or electric shock.
9. Do not place the projector where the cord can be walked on. This may result in fraying or damage to the plug.
10. Unplug the projector from the wall outlet before cleaning. Use a damp cloth for cleaning. Do not use liquid or aerosol cleaners.
11. Do not block the slots and openings in the projector case. They provide ventilation and prevent the projector from overheating. Do not operate the projector on a sofa, rug, or other soft surface, or in a closed-in cabinet unless proper ventilation is provided.
12. Never push objects of any kind through cabinet slots. Never spill liquid of any kind into the projector.
13. Except as specifically explained in this *User's Guide*, do not attempt to service this product yourself. Refer all servicing to qualified service personnel. Opening or removing covers may expose you to dangerous voltages and other hazards.
14. Unplug the projector during lightning storms or when it will not be used for extended periods.
15. Do not place the projector and remote control on top of heat-producing equipment or in a heated place, such as a car.



Discount-Merchant.com (800) 281-8860
THE TRUSTED SOURCE FOR PROJECTOR LAMPS AND ACCESSORIES

Safety Instructions



16. Unplug the projector from the wall outlet and refer servicing to qualified service personnel under the following conditions:

- When the power cord or plug is damaged or frayed
- If liquid has been spilled into the projector, or if it has been exposed to rain or water
- If it does not operate normally when you follow the operating instructions, or if it exhibits a distinct change in performance, indicating a need for service
- If it has been dropped or the housing has been damaged.

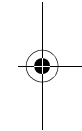
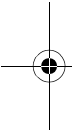

FixYourDLP.com

Sponsored by 

Discount-Merchant.com (800) 281-8860

10

Introduction

THE TRUSTED SOURCE FOR PROJECTOR LAMPS AND ACCESSORIES

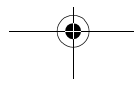

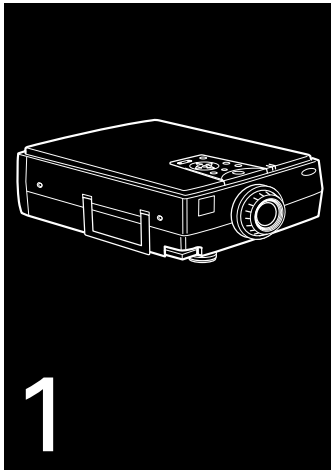

Setting Up the Projector

This chapter describes how to unpack your projector, connect it to your other equipment, and turn everything on. The projector must be connected to a computer or a video source such as a VCR, camcorder, or laser disc player before it can project any images. You may also want to set up the projector for one or more of the following:







- Connect the mouse cable to use the remote control as a wireless mouse. Except for some laptops, this disables your computer's mouse. If you are also viewing the display on your monitor, you use the remote control's pointer to control the screen cursor.
- Provide audio for one or both image sources. The audio source can be the computer, video source, or another device such as a stereo.
- Connect to an external speaker or PA system to amplify the audio.

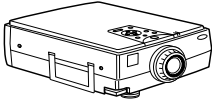
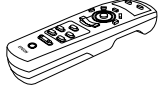

Discount-Merchant.com (800) 281-8860
THE TRUSTED SOURCE FOR PROJECTOR LAMPS AND ACCESSORIES

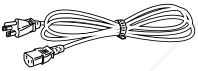
Unpacking the Projector

When you unpack the projector, make sure you have all these components:

-  Projector
-  Remote control
-  2 AA batteries
-  Power cord
-  Projector video cable
-  Audio cable
-  Audio/video (A/V) cable



Discount-Merchant.com (800) 281-8860

- Macintosh adapter set:

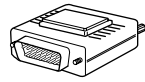

Macintosh desktop adapter

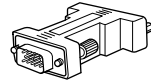

Macintosh monitor adapter

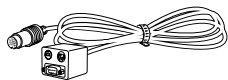
-  Main cable (for connecting a mouse cable to use the remote as a wireless mouse and/or a serial cable to use the ELP Link III software)

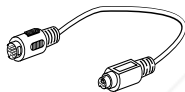
-  PS/2[®] mouse cable (for the PC)

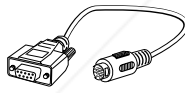
-  Serial mouse cable (for the PC)

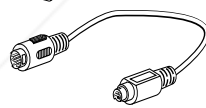
-  Mac mouse cable (for the Macintosh)

-  PC serial cable

-  Macintosh serial cable

-  Projector Software CD ROM



Discount-Merchant.com (800) 281-8860

THE TRUSTED SOURCE FOR PROJECTOR LAMPS AND ACCESSORIES



You will not need all these components; your configuration will determine which ones you need.

Save all packaging in case you need to ship the projector in the future. Always transport the projector in its original packaging (or the equivalent), or use a carrying case if you are carrying the projector by hand. (See page 123 for instructions.)

Additional Components

Depending on how you plan to use the projector, you may need additional components:

- To receive an S-Video signal, you need an S-Video cable. (One is usually provided with your video device.) A separate cable is required for each video source.
- To connect a second computer, you need a computer video and audio cable.
- To connect the projector to a Macintosh PowerBook, you need a video-out cable. (One is provided by—or can be purchased from—Apple for all new PowerBooks that have video-out capability.) If your PowerBook does not include one, see your Macintosh dealer.
- To connect the projector to an external sound system, you need an RCA-to-3.5 mm stereo audio cable. You can obtain one from your computer dealer.
- To connect the mouse cable to your computer, you may require a special connector, cable, or other components. You can obtain these items from your computer dealer.

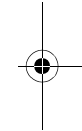
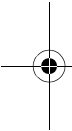

Discount-Merchant.com (800) 281-8860

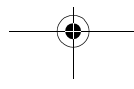

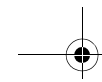

Note: You can connect a Kensington MicroSaver® anti-theft device in the hole on the projector's right side. Contact your computer dealer.

Before You Connect the Projector

Before you start connecting the projector to your equipment, decide where you will want to place your projector and computer or video source. The distance between the projector and the screen determines the actual image size. Place the projector somewhere between 4 and 54.7 feet (1.2 and 16.7 meters) away from the screen; use the general guidelines in the table below to determine the proper distance. (For more precise calculations, see "Positioning the Projector" on page 58.)



Caution: Do not hold or lift the projector by the lens. This can damage the lens.

Image size (diagonal)	Horizontal distance from projector to screen	
	Minimum	Maximum
200 inches (5.1 m)	324.1 inches (8.2 m)	436.5 inches (11.1 m)
100 inches (2.54 m)	160.8 inches (4.1 m)	217.1 inches (5.5 m)
80 inches (2.03 m)	128.1 inches (3.3 m)	173.1 inches (4.4 m)
60 inches (1.52 m)	95.5 inches (2.4 m)	129.2 inches (3.3 m)
40 inches (1.02 m)	62.8 inches (1.6 m)	85.3 inches (2.2 m)
30 inches (0.76 m)	46.5 inches (1.2 m)	63.3 inches (1.6 m)
23 inches (0.58 m)	35.1 inches (0.9 m)	48.0 inches (1.2 m)



Discount-Merchant.com (800) 281-8860

THE TRUSTED SOURCE FOR PROJECTOR LAMPS AND ACCESSORIES

Before You Connect the Projector

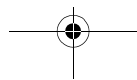
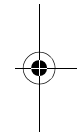
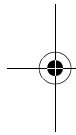



Be sure to place the projector on a sturdy, level surface within five feet of the computer or video source.

Installing the Remote Control Batteries

You can use the remote control as a wireless mouse instead of your computer's mouse to control your presentation. You can also use it to control the projector menus and use the Effects buttons.

Follow these steps to install the batteries in the remote control:

1. Slide off the battery compartment cover.

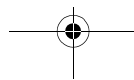
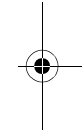
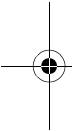
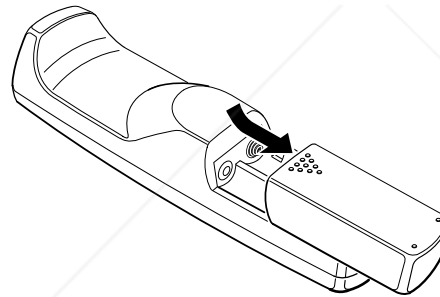

2. Insert the two AA batteries included with the projector. Make sure the polarity of the batteries is correct.

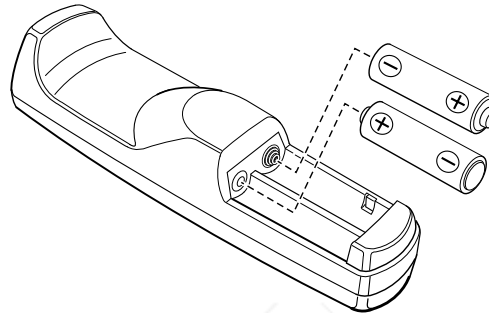

3. Replace the battery compartment cover.

When replacing batteries, take the following precautions:

- Do not mix old and new batteries.
- Replace batteries as soon as they run out. If the batteries leak, wipe away battery fluid with a soft cloth. If fluid gets on your hands, wash them immediately.
- Remove batteries if you will not be using the projector for a long period of time.



Connecting to a Computer

You can connect the projector to any computer capable of producing standard VGA, Super VGA, XGA, or Super XGA output, such as:

- IBM compatible desktop PCs
- IBM compatible laptop PCs
- Apple Macintosh desktop computers, including Macintosh Quadra[®], Macintosh Centris[®], and Power Macintosh
- Any Apple PowerBook with video-out capability
- (PowerLite 7200 and 7300 only) Most high-end workstations from Sun, Silicon Graphics[®], IBM, and Hewlett-Packard[®] (You may need an adapter cable to connect to a high-end workstation; see page 49.)

See the section that applies to your computer. Make sure both the computer and projector are turned off before you start.

When you have finished connecting all your components, go to page 54 to turn on the projector and equipment.

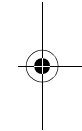
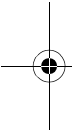

Discount-Merchant.com (800) 281-8860

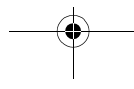

The illustration below identifies all the interface ports on the back of the projector; you may want to refer to this as you connect your computer or other equipment to the projector.

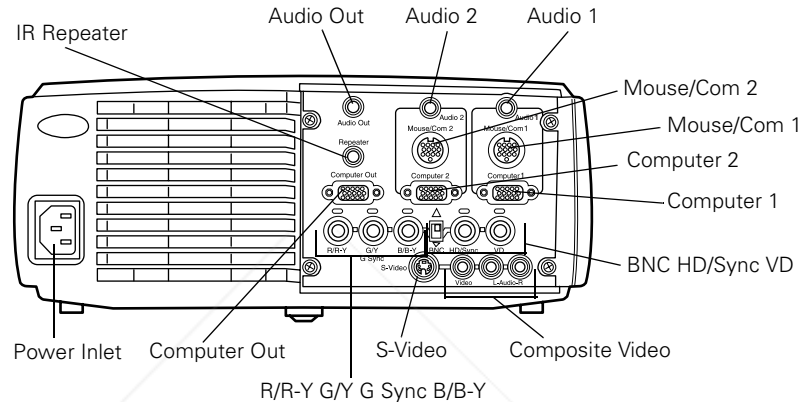

Connecting to a PC Desktop Computer

To connect the projector to your PC desktop computer, you need to:

- Connect the projector video cable and computer monitor cable
- Connect the mouse and/or serial cable (if you want to use the remote control as a mouse or use the ELP Link III software)
- Connect the audio cable (if you'll be projecting with audio)

Follow the steps in each section for the cables you need to connect.
Before beginning, turn off the projector and computer if they are on.

Note: Computer configurations vary. See your computer manual for the location of the ports needed to connect your projector.

Connecting the Video and Monitor Cables

First connect the projector video cable and computer monitor cable.
Refer to this illustration while following the steps below.

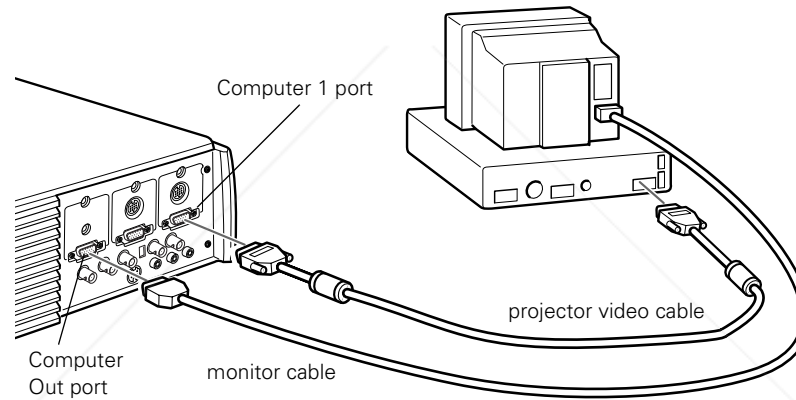

1. If you will be viewing the video on your computer monitor as well as the projector screen, disconnect the monitor cable from the video port on the back of your computer. Then connect the monitor cable to the projector's Computer Out port, as shown below. (This is useful when you need to view the video output but the projection screen is behind you.)

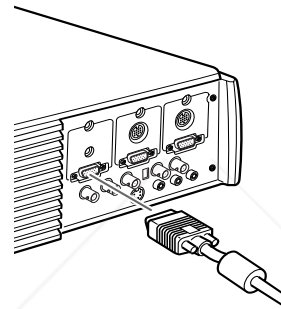

2. Connect one end of the projector video cable to the projector's Computer 1 port. (Use the Computer 2 port if you are connecting a second computer.)

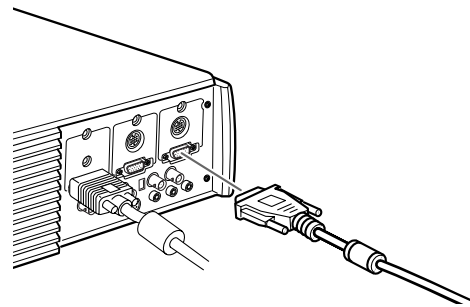

3. Connect the other end of the projector video cable to the computer's video port.
4. Tighten the screws on all connectors.

Connecting the Mouse and Serial Cables

If you want to use the remote control as a mouse or use the ELP Link III software, you need to connect the main cable. It provides connectors for:

- The PS/2 mouse cable (to use the remote control as a mouse)
- The serial cable (to use the ELP Link III software and the Effects buttons on the remote control)

Refer to this illustration while following the steps below.

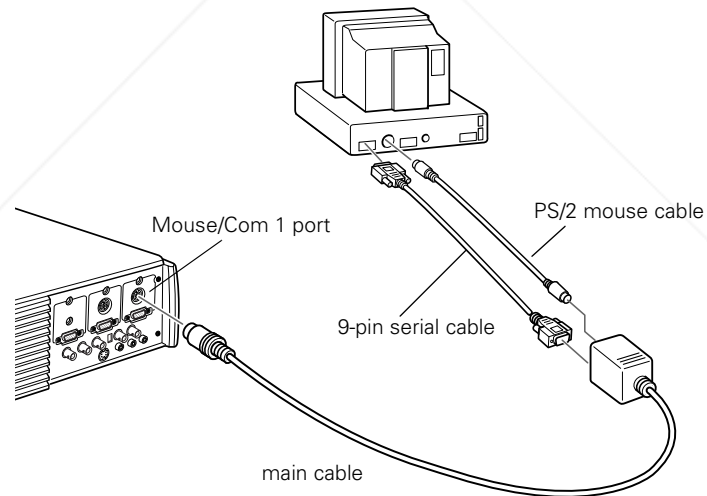

1. Connect the small end of the main cable to the projector's Mouse/Com 1 port. (Use the Mouse/Com 2 port if you are connecting a second computer.)

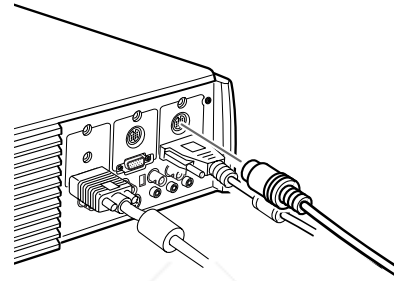

2. To use the remote control as a wireless mouse, connect the 9-pin end of the PS/2 mouse cable included with the projector to the MOUSE terminal on the square end of the main cable.

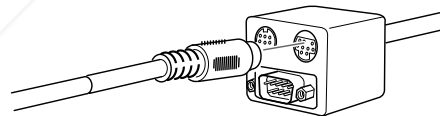

3. Disconnect your mouse from the mouse port on the back of your computer and replace it with the other end of the PS/2 mouse cable included with the projector. (Your computer's mouse will be disabled while you are using the remote control as a mouse.)

Note: If your system uses a serial mouse, perform steps 2 and 3 using the PC mouse serial cable instead of the PS/2 mouse cable (not shown in the illustration).



- To use the ELP Link III software or to use the Effects buttons on the remote control, connect one end of the serial cable to the SERIAL terminal on the square end of the main cable.

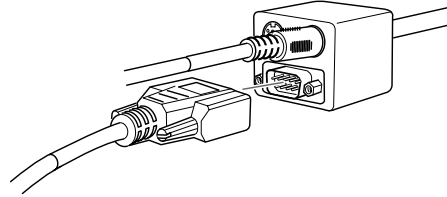

Connect the other end of the serial cable to the serial port on the back of your computer.

Note: You will not be able to use ELP Link III software if your system has only one serial port that is being used to support a serial mouse.

- Tighten the screws on all connectors.

Connecting the Audio Cable

1. If you will be using audio, connect one end of the audio cable to the Audio 1 jack on the projector. (Use the Audio 2 jack if you are connecting a second computer.)

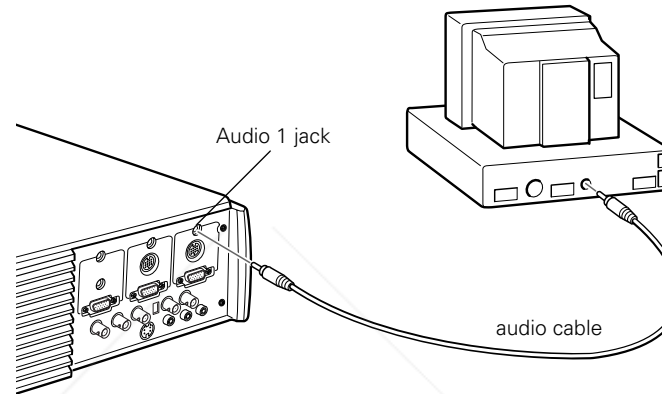

2. Connect the other end of the audio cable to the speaker or audio out port on the computer's sound card.

Connecting to a PC Laptop Computer

To connect the projector to your PC laptop computer, you need to:

- Connect the projector video cable
- Connect the mouse and/or serial cable (if you want to use the remote control as a mouse or use the ELP Link III software)
- Connect the audio cable (if you'll be projecting with audio)

Follow the steps in each section for the cables you need to connect. Before beginning, turn off the projector and computer if they are on.

Note: Laptop configurations vary. See your computer manual for the location of the ports needed to connect your projector.

Connecting the Video Cable

First connect the projector's video cable to your laptop.

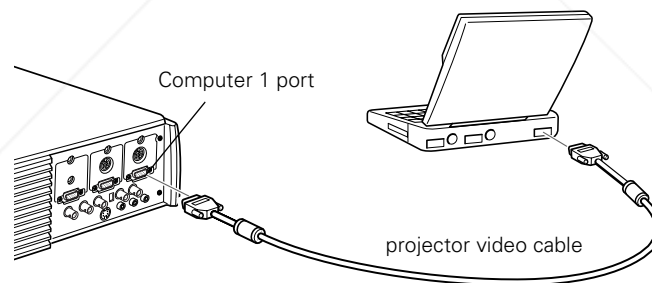

1. Connect one end of the projector video cable to the projector's Computer 1 port. (Use the Computer 2 port if you are connecting a second computer.)

2. Connect the other end of the video cable to the laptop's video (monitor) port.
3. Tighten the screws on all connectors.

Connecting the Mouse and Serial Cables

If you want to use the remote control as a mouse or use the ELP Link III software, you need to connect the main cable. It provides connectors for:

- The PS/2 mouse cable (to use the remote control as a mouse)
- The serial cable (to use the ELP Link III software and the Effects buttons on the remote control)

Refer to this illustration while following the steps below.

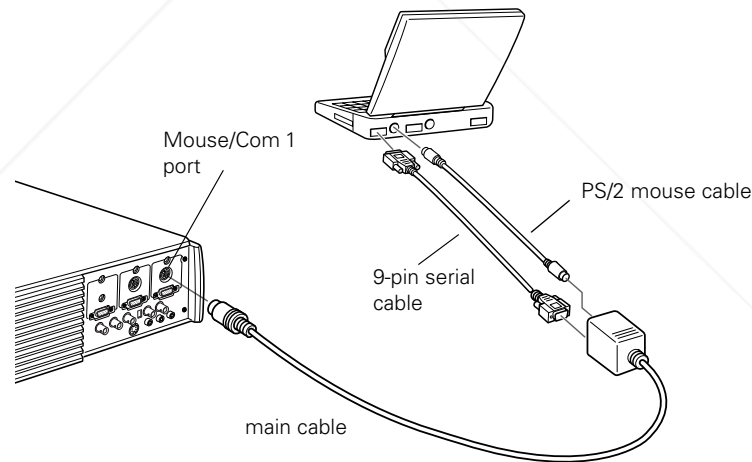

1. Connect the small end of the main cable to the projector's Mouse/Com 1 port. (Use the Mouse/Com 2 port if you are connecting a second computer.)

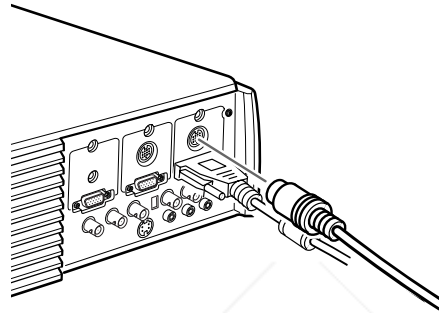

2. To use the remote control as a wireless mouse, connect the 9-pin end of the PS/2 mouse cable included with the projector to the MOUSE terminal on the square end of the main cable.

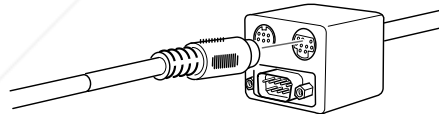

3. Connect the 6-pin (mini-DIN) end of the PS/2 mouse cable to the external mouse port on your laptop.

Note: If your laptop uses a serial mouse, perform steps 2 and 3 using the PC serial mouse cable instead of the PS/2 mouse cable (not shown in the illustration).

- To use the ELP Link III software or to use the Effects buttons on the remote control, connect one end of the serial cable to the SERIAL terminal on the square end of the main cable.

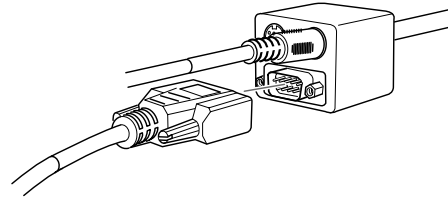

- Connect the other end of the serial cable to the serial port on the back of your computer.

Note: You will not be able to use ELP Link III software if your laptop has only one serial port that is being used to support a serial mouse.

- Configure your laptop to work with an external mouse.

Note: You may have to set the display to appear on both the laptop's screen and the projector. Some laptops let you change this setting with the keyboard's function keys or by using a setup utility provided by the computer manufacturer. Check your laptop's manual or online help for instructions.

Connecting the Audio Cable

1. If you will be using audio, connect one end of the audio cable to the Audio 1 jack on the projector. (Use the Audio 2 jack if you are connecting a second computer.)

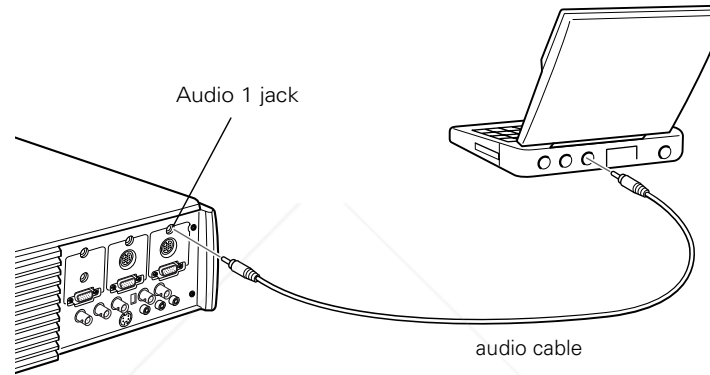

2. Connect the other end of the audio cable to your laptop.



Connecting to a Desktop Macintosh

To connect the projector to your desktop Macintosh, you need to:

- Connect the projector video cable and computer monitor cable
- Connect the mouse and/or serial cable (if you want to use the remote control as a mouse or use the ELP Link III software)
- Connect the audio cable (if you'll be projecting with audio)

Follow the steps in each section for the cables you need to connect. Before beginning, turn off the projector and computer if they are on.

Note: Macintosh configurations vary. See your computer manual for the location of the ports needed to connect your projector.

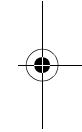
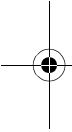

Discount-Merchant.com (800) 281-8860

THE TRUSTED SOURCE FOR PROJECTOR LAMPS AND ACCESSORIES

Connecting to a Computer

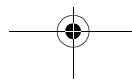

Connecting the Video and Monitor Cables

First connect the video and monitor cables. Refer to this illustration as you follow the steps below.

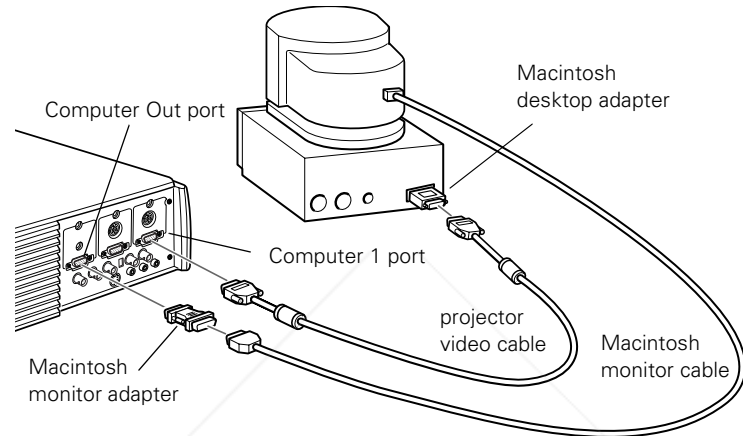

1. Connect one end of the projector video cable to the projector's Computer 1 port. (Use the Computer 2 port if you are connecting a second computer.)

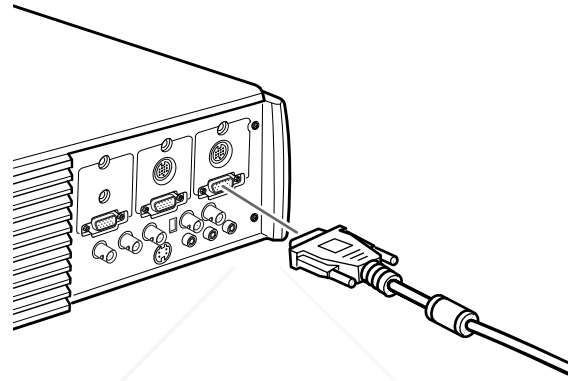

2. Remove the small cover on the Macintosh desktop adapter (as shown below) and set its DIP switches in accordance with the resolution you want to use, such as 16-inch mode. See your Macintosh documentation for instructions.

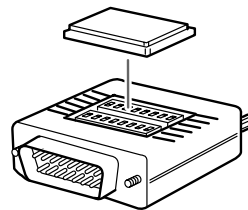

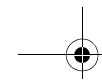

3. Connect the small terminal of the Macintosh desktop adapter to the other end of the projector video cable.

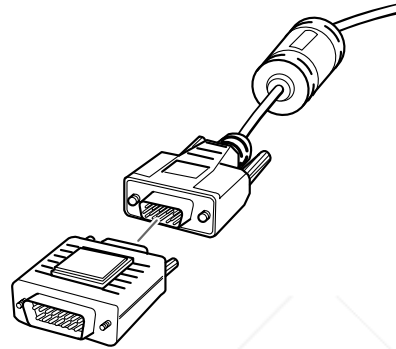

4. Disconnect the monitor cable from the video port on the back of the Macintosh. Then connect the projector video cable (with the Macintosh desktop adapter attached) to the video port on the Macintosh.

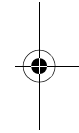
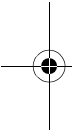

FixYourDLP.com

Sponsored by 

Discount-Merchant.com (800) 281-8860

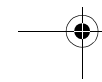
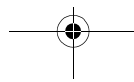

- To also view the video on the computer's monitor, attach the large end of the Macintosh monitor adapter to the monitor cable and connect the other end of the adapter to the projector's Computer Out port.

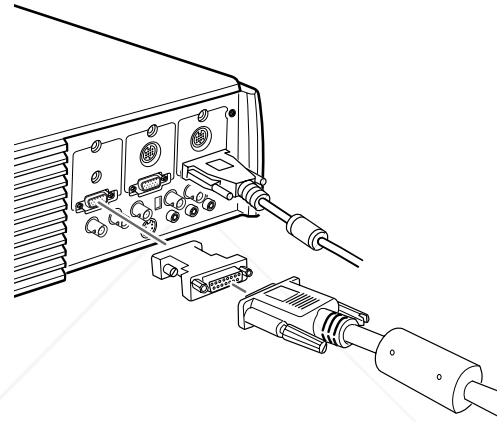

- Tighten the screws on all the connectors.

Connecting the Mouse and Serial Cables

If you want to use the remote control as a mouse or use the ELP Link III software, you need to connect the main cable. It provides connectors for:

- The Mac mouse cable (to use the remote control as a mouse)
- The Mac serial cable (to use the ELP Link III software and the Effects buttons on the remote control)

Refer to this illustration while following the steps below.

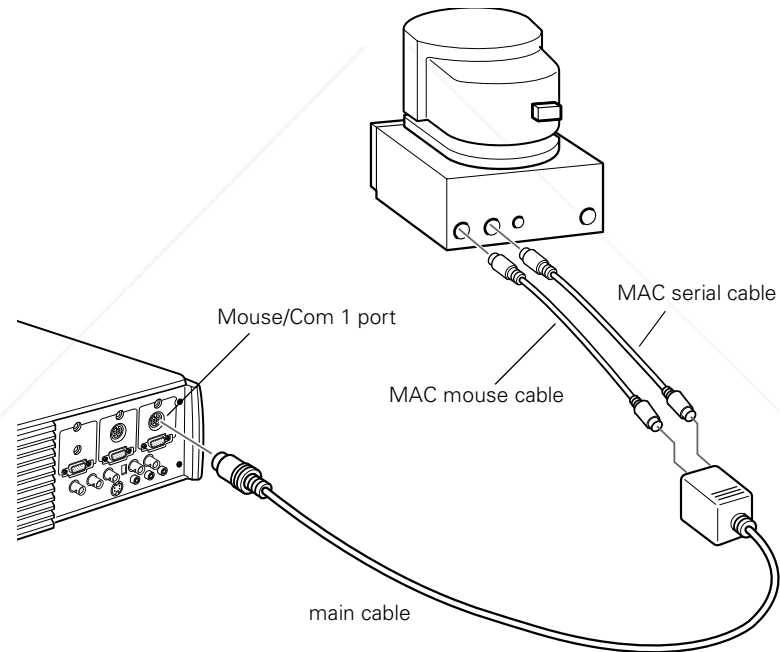

1. Connect the small end of the main cable to the projector's Mouse/Com 1 port. (Use the Mouse/Com 2 port to connect a second computer.)

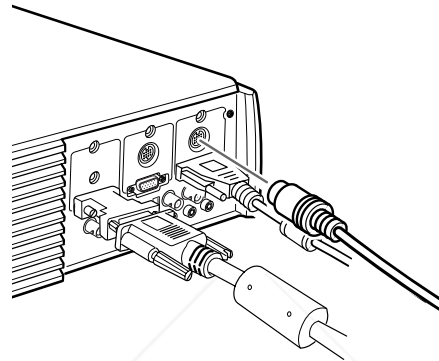

2. To use the remote control as a wireless mouse, connect one end of the projector's Mac mouse cable to the MOUSE terminal on the large end of the main cable.

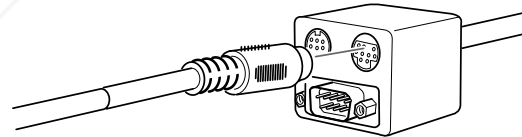

3. Disconnect your Macintosh's mouse cable. Connect the other end of the projector's Mac mouse cable to the mouse port on your Macintosh.

- To use the ELP Link III software or use the Effects button on the remote control, connect one end of the Mac serial cable to the Mac SERIAL terminal on the large end of the main cable.

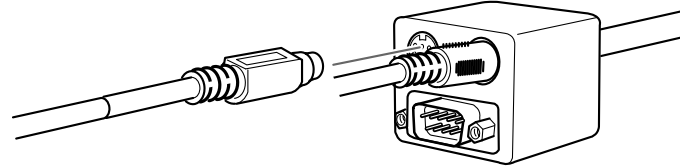

- Connect the other end of the Mac serial cable to the printer or modem port on the back of your Macintosh.

Connecting the Audio Cable

1. If you will be using audio, connect one end of the audio cable to the Audio 1 jack on the projector. (Use the Audio 2 jack if you are connecting a second computer.)

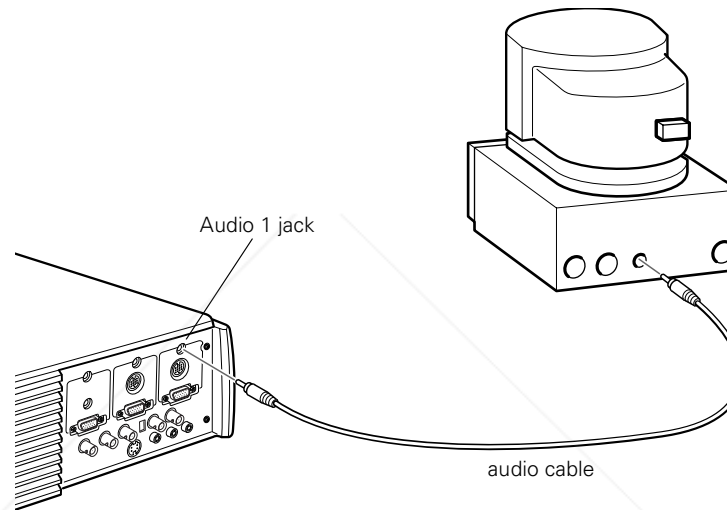

2. Connect the other end of the audio cable to the audio-out port on your computer.



Connecting to a PowerBook

Your PowerBook must have video-out capability in order to connect to the projector.

To connect the projector to your PowerBook, you need to:

- Connect the projector video cable
- Connect the mouse and/or serial cable (if you want to use the remote control as a mouse or use the ELP Link III software)
- Connect the audio cable (if you'll be projecting with audio)

Follow the steps in each section for the cables you need to connect. Before beginning, turn off the projector and computer if they are on.

Note: PowerBook configurations vary, so the location of your computer's ports may not match the illustrations. See your PowerBook manual for the port locations if necessary.

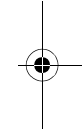
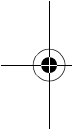

Discount-Merchant.com (800) 281-8860

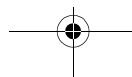

Connecting the Video Cable

First connect the projector video cable. Refer to this illustration as you follow the steps below.

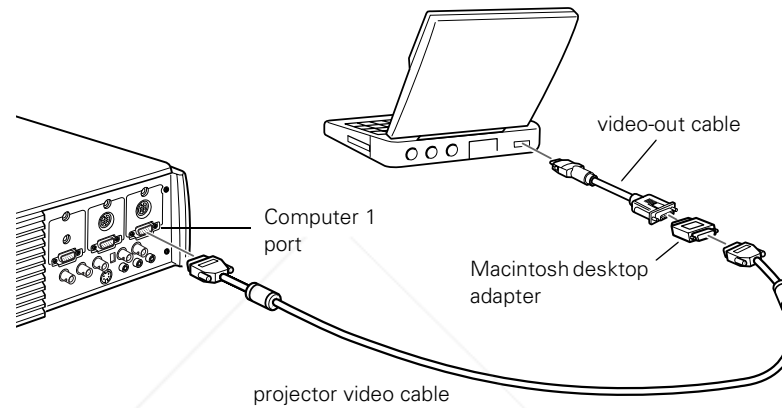

Note: Some new PowerBooks may allow you to connect the video cable directly to the computer without using a video-out cable. See your PowerBook manual for additional information on connecting a video cable.

1. Connect one end of the projector video cable to the projector's Computer 1 port. (Use the Computer 2 port if you are connecting a second computer.)

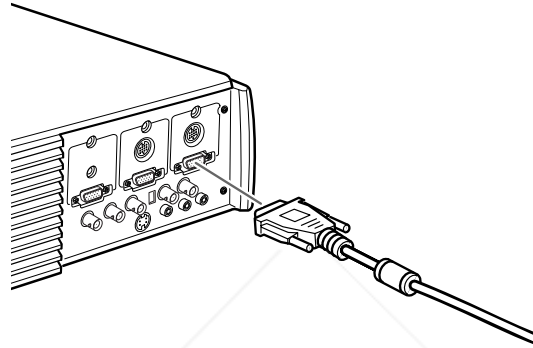

2. Remove the small cover on the Macintosh desktop adapter and set its DIP switches in accordance with the resolution you want to use (such as 16-inch mode). See your Macintosh documentation for instructions.

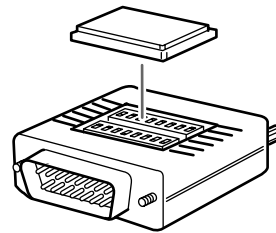

3. Connect the small terminal of the Macintosh desktop adapter to the other end of the video cable.

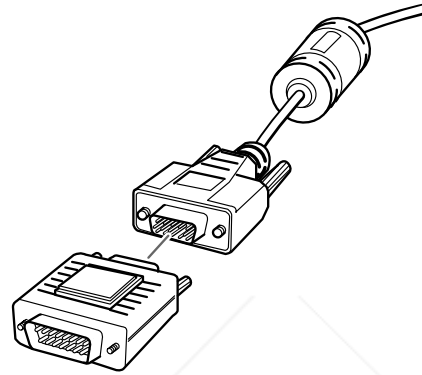

4. Connect the projector video cable (with the Macintosh desktop adapter attached) to the video-out port on the PowerBook.



If a video-out cable was provided with your PowerBook, connect the smaller end of the video-out cable to the video-out port on the back of the PowerBook. Connect the other end to the Macintosh desktop adapter on the end of the projector video cable.

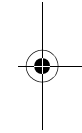
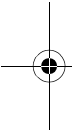
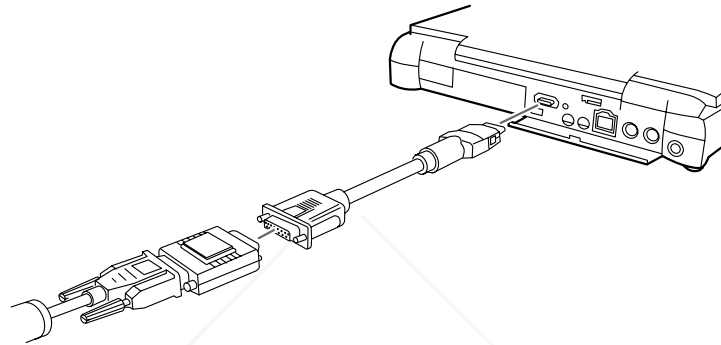

FixYourDLP.com

Sponsored by 

Discount-Merchant.com (800) 281-8860

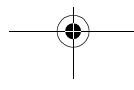

Connecting the Mouse and Serial Cables

If you want to use the remote control as a mouse or use the ELP Link III software, you need to connect the main cable. It provides connectors for:

- The Mac mouse cable (to use the remote control as a mouse)
- The Mac serial cable (to use the ELP Link III software and the Effects buttons on the remote control)

Refer to this illustration while following the steps below.

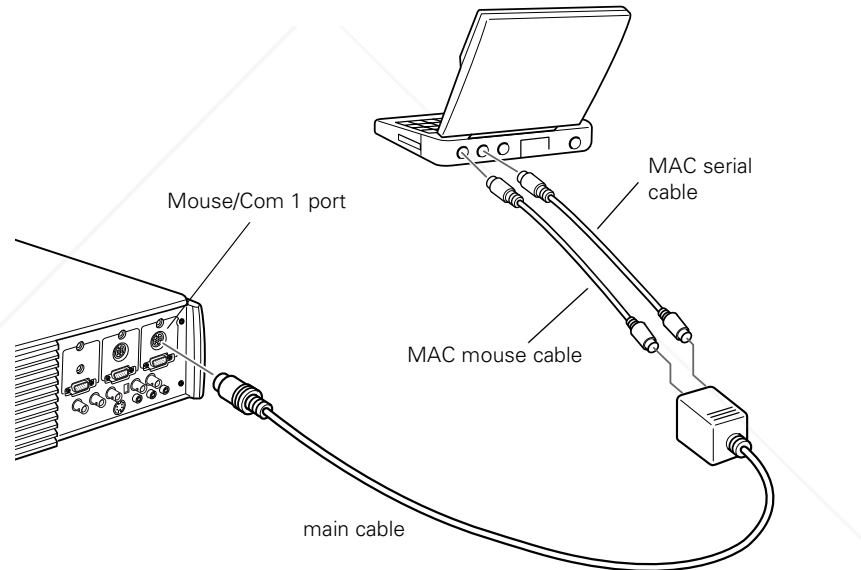

1. Connect the small end of the main cable to the projector's Mouse/Com 1 port. (Use the Mouse/Com 2 port if you are connecting a second computer.)

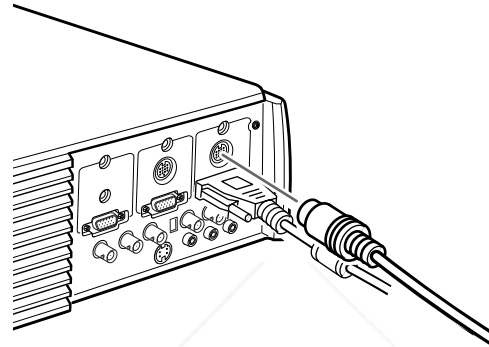

2. To use the remote control as a wireless mouse, connect one end of the projector's Mac mouse cable to the MOUSE terminal on the large end of the main cable.

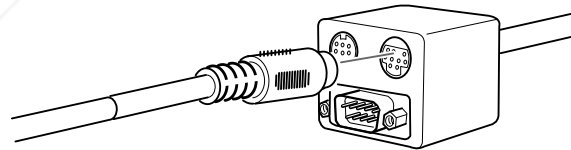

3. Connect the other end of the Mac mouse cable to the mouse port on the back of the PowerBook.

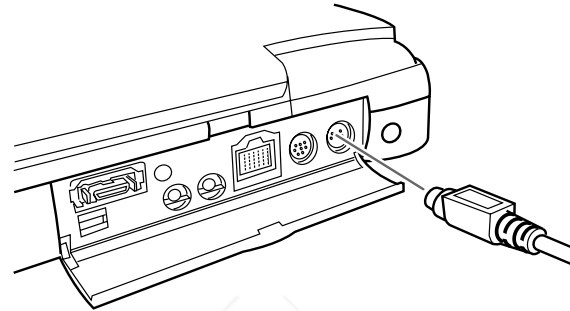

4. To use the ELP Link III software or the Effects button on the remote control, connect one end of the Mac serial cable to the MAC SERIAL terminal on the large end of the main cable.

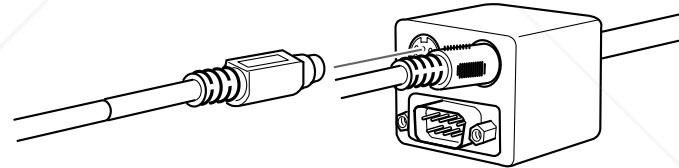

5. Connect the other end of the serial cable to the  printer/modem port on the back of your PowerBook.

Connecting the Audio Cable

1. If you will be using audio, connect one end of the audio cable to the Audio 1 jack on the projector. (Use the Audio 2 jack if you are connecting a second computer.)

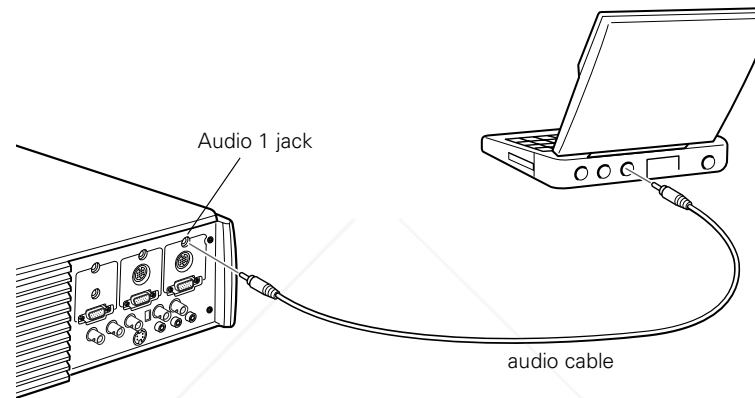

2. Connect the other end of the audio cable to the audio-out port on your PowerBook.

Note: After you turn on the projector and computer, you'll need to choose Mirroring in the Display Control Panel if you set up your configuration to display on the LCD screen as well as the projector screen.



Connecting to a High-End Workstation

The PowerLite 7200 and 7300 are capable of remapping input resolutions up to 1280×1024 pixels. Since 1280×1024 pixels is the default resolution for most leading workstations, this capability makes these projectors the best portable solution for the display of workstation video output.

There is no standard for workstation video output. Those workstations that follow the SXGA standard and use the HD15 connector don't need an adapter cable. The most popular workstations use a 13-pin 13W3 connector, which requires an adapter cable (ELPKC06).

In addition, workstations pass the sync (synchronization) signal differently, so the ELPKC06 adapter cable has a DIP switch to control sync routing. Contact your audio/video dealer for information on connecting your workstation.

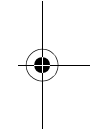
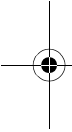

Connecting to a Video Source

You can connect a VCR, a camcorder, a laser disc player, DVD player, or any other compatible video image source to your projector.

The projector can receive composite video, S-Video, or component video. Your equipment has composite video if your video source has a one-pin RCA video jack. Your equipment has S-Video if your video source has a four-pin (mini-DIN) video jack. Your equipment has component video if your video source has a three-connector (Y, R-Y, B-Y) video jack.

Note: The projector is not compatible with a cable TV-style F connector.



Discount-Merchant.com (800) 281-8860

THE TRUSTED SOURCE FOR PROJECTOR LAMPS AND ACCESSORIES

Connecting to a Computer

49

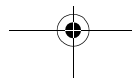



You can connect the projector to an S-Video source, a composite video source, and a component video source at the same time. However, the projector automatically selects the S-Video as the video source. To display composite or component video, first disconnect the S-Video source.

The projector supports NTSC, PAL, and SECAM video formats, and automatically detects and identifies the video format. However, you can specify that a single broadcast format be detected. (See Chapter 3.) Note that the projector will then be able to detect only one type of video signal.

The type of cable you use to connect the video source to the projector depends on whether you have composite video, S-Video, or component video. For composite video, use the audio/video (A/V) cable supplied with the projector. For S-Video, use the S-Video cable supplied with your video device or obtain one from your computer or video equipment dealer. For component video, use the BNC type cable that came with your video source. The illustration below shows the S-Video, component, and composite connectors.

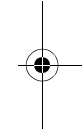
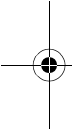

S-Video
4-pin, mini-DIN

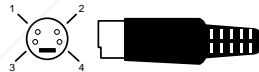

component
BNC connector



composite
RCA

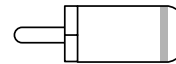

FixYourDLP.com

Sponsored by EM

Discount-Merchant.com (800) 281-8860

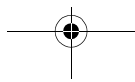

To connect a video source to the projector:

1. Turn off the projector and video source if they are on.
2. If your video source uses a small, round, one-prong composite (RCA) video connector, you'll need the audio/video cable that comes with the projector. If your video source uses a large, round, four-prong S-Video connector or a BNC type connector, you will need to purchase the appropriate cable or use the cable that came with your video source.
3. For composite video, connect the yellow RCA plug on one end of the audio/video cable to the projector's Video jack. Connect the other yellow RCA plug to the video-out jack of your video source.

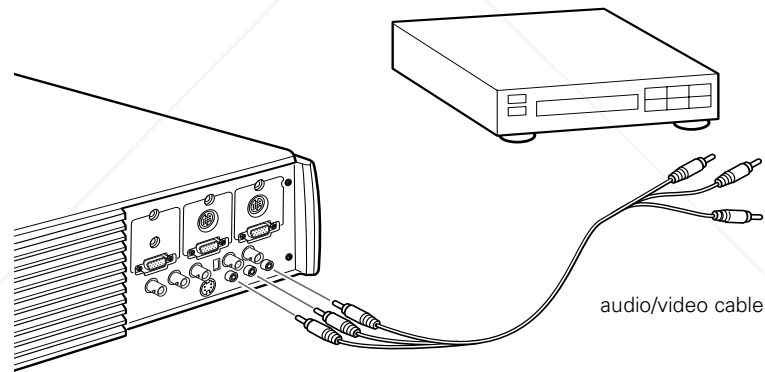

4. Connect the other plugs on the audio/video cable to the Audio jacks of the projector: insert the white plug into the L jack and the red plug into the R jack. Connect the plug at the other end of the audio/video cable to the audio output jacks of the video source.
5. For S-Video, insert one end of an S-Video cable into the projector's S-Video connector. Insert the other end into the S-video-out jack of your video source.

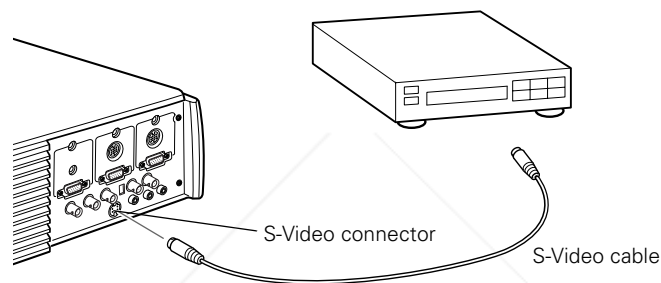

6. For component, insert three ends of a BNC cable into the projector's R/R-Y, G/Y and B/B-Y jacks. Insert the opposite ends of the cable into the Y/Video, C/R-Y, and B-Y jacks on your component video source. (Don't insert any of the cable ends into the HD/Sync and VD jacks.)
7. Make sure the Computer 2/BNC switch is set to BNC.

Note: When the Computer 2/BNC switch is set to BNC, the projector is unable to project the Computer 2 image signal.

Note: Use a standard BNC cable, which you can purchase from any computer store. The 5BNC video cable supplied by EPSON as an optional accessory does not work with component video.

Connecting to an External Speaker or PA System

Although the projector's internal speakers are enough for most small- or medium-size rooms, you can connect the projector to an external speaker or public address (PA) system for large rooms or to gain maximum benefit from the projector's built-in 3D sound function.

To connect the projector to an external sound system, you need to obtain an RCA-to-3.5 mm stereo audio cable. You can get one from your computer dealer.

1. Turn off the projector and speaker or PA system if they are on.
2. Connect the cable's 3.5 mm stereo miniplug to the projector's Audio Out jack.

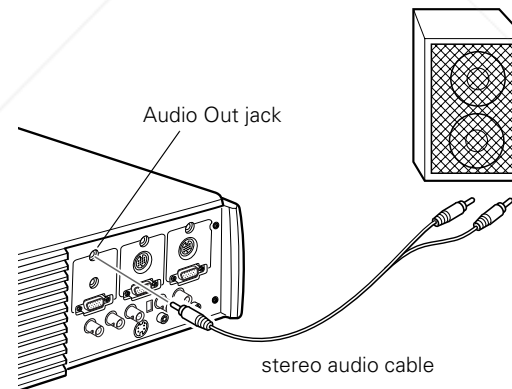



Note: EPSON offers the Mediaphile PAS (personal audio system) for external amplification. See page 4 for the part number and ordering information.

3. Connect the RCA plugs to the external amplified speaker or PA system. Insert the cable's red plug into the Audio R jack, and the white plug into the Audio L jack.

Note: The internal speakers are disabled when an external audio system is used.

Turning the Equipment On and Off

It's best to turn on the projector and its attached equipment in the following order:

1. Video source (such as a VCR), if your video source is not your computer
2. Audio source (if different from computer or video source)
3. Computer
4. External amplified speaker or PA system (if necessary)
5. Projector

When you are ready to turn off the equipment, turn them off in the reverse order.



Discount-Merchant.com (800) 281-8860

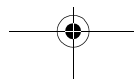
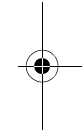
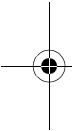

Turning the Projector On and Off

Follow these steps to turn on the projector:

1. Connect one end of the power cord to the projector's power inlet.

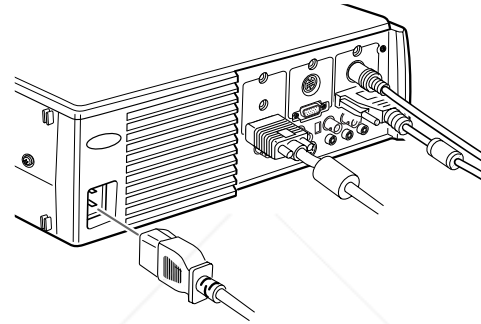

2. Connect the other end to a grounded electrical outlet. The Power light on the projector's control panel turns orange, indicating that the projector is in sleep mode. (The projector is not turned on yet.)
3. Remove the projector lens cap.

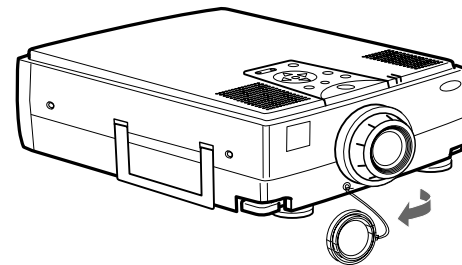



4. Press the Power button on the remote control or control panel to turn on the projector. The Power light flashes green as the projector warms up.

If computer or video equipment is attached, the computer or video signal is projected. Allow about 30 seconds for full illumination.



Warning: Never look into the lens when the lamp is on. This can damage your eyes. It is especially important that children not look into the lens.

When you want to stop projecting images, press the Power button again. The fan remains on and the projection lamp light flashes orange for about 60 seconds as the projector cools down. When the projector has cooled down, flashing stops. The power light remains orange.

Note: If you press the Power button to turn the projector back on while the Power light is orange, there may be a delay before a projected image appears.

When you are done using the projector, unplug the power cord.

Never unplug the power cord when the power light is green or you may damage the lamp.

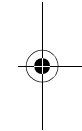
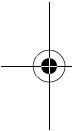

FixYourDLP.com

Sponsored by 

Discount-Merchant.com (800) 281-8860

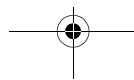

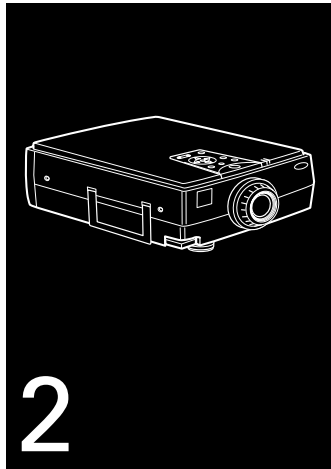

Using the Projector

This chapter provides the following information about using your projector:

- Positioning the projector relative to the screen
- Focusing and positioning the screen image
- Controlling the projector with the remote control and the control panel
- Monitoring the projector's operating status



Discount-Merchant.com (800) 281-8860
THE TRUSTED SOURCE FOR PROJECTOR LAMPS AND ACCESSORIES

The illustration below identifies the parts of your projector.

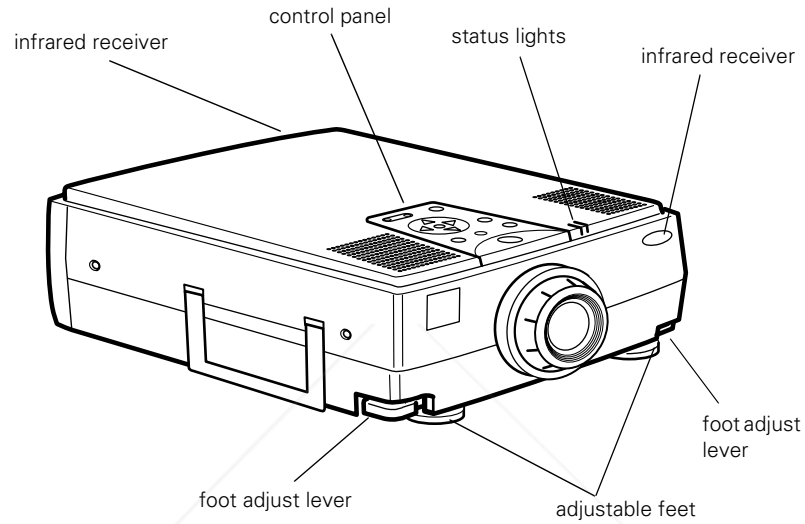

Positioning the Projector

Your projector supports front, rear, and ceiling projection, allowing you to choose the best method for displaying your images. If you use rear or ceiling projection, you need to select this in the projector's Options menu. See page 85 for more information.



To get the best results when projecting your images, it's important to position the projector at the proper height and distance relative to the screen.

When projecting from a table or desk, place the projector so the lens is aligned as closely as possible with the bottom of your screen:

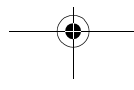
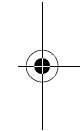
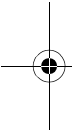
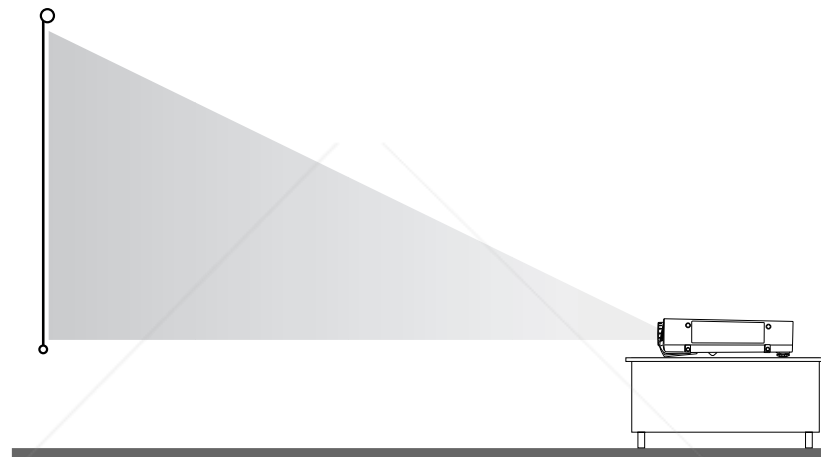

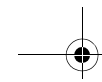

When projecting from the ceiling, align the lens as closely as possible with the top of your screen:

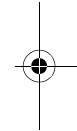
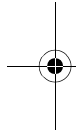

Calculating Image Size and Projection Distance

The distance between the projector and the screen determines the actual image size. To determine the exact distance required for a particular image size (or to determine the size of an image at a particular distance), use the formulas given below. (Remember that the size of the image can be changed by rotating the zoom ring; see page 63 for more information.)



FixYourDLP.com

Sponsored by 

Discount-Merchant.com (800) 281-8860

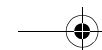



To determine the minimum and maximum diagonal size of an image when you know the projection distance:

- Inches:**
 Maximum diagonal size = $(0.6124 \times \text{projection distance}) + 1.5264$
 Minimum diagonal size = $(0.4556 \times \text{projection distance}) + 1.1410$
- Centimeters:**
 Maximum diagonal size = $(0.6124 \times \text{projection distance}) + 3.8771$
 Minimum diagonal size = $(0.4556 \times \text{projection distance}) + 2.8981$

To determine the projection distance when you know the diagonal size of the screen image:

- Inches:**
 Maximum projection distance = $(2.1949 \times \text{diagonal size}) - 2.5044$
 Minimum projection distance = $(1.6328 \times \text{diagonal size}) - 2.4923$
- Centimeters:**
 Maximum projection distance = $(2.1949 \times \text{diagonal size}) - 6.3612$
 Minimum projection distance = $(1.6328 \times \text{diagonal size}) - 6.3304$

For example, here are the measurements for three installations:

Image size (diagonal)	Horizontal distance from projector to screen	
	Minimum	Maximum
300 inches* (762 cm)	487.3 inches (12.4 m)	656.0 inches (16.7 m)
200 inches (508 cm)	324.1 inches (8.2 m)	436.5 inches (11.1 m)
100 inches (254 cm)	160.8 inches (4.1 m)	217.1 inches (5.5 m)

* For an image size of 300 inches, the projector may be up to 54 feet away from the screen, depending on the setting of the zoom ring.

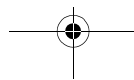
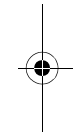
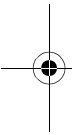



Long Throw Zoom Lens Calculations

If you are using the optional long throw zoom lens, use the following formulas instead:

To determine the minimum and maximum diagonal size of an image when you know the projection distance:

- **Inches:**
 Maximum diagonal size = $(0.4742 \times \text{projection distance}) + 3.2489$
 Minimum diagonal size = $(0.2849 \times \text{projection distance}) + 1.8968$
- **Centimeters:**
 Maximum diagonal size = $(1.2045 \times \text{projection distance}) + 8.2522$
 Minimum diagonal size = $(0.7236 \times \text{projection distance}) + 4.8179$

To determine the projection distance when you know the diagonal size of the screen image:

- **Inches:**
 Maximum projection distance = $(3.5094 \times \text{diagonal size}) - 6.6568$
 Minimum projection distance = $(2.1090 \times \text{diagonal size}) - 6.8519$
- **Centimeters:**
 Maximum projection distance = $(8.9139 \times \text{diagonal size}) - 16.9083$
 Minimum projection distance = $(5.3569 \times \text{diagonal size}) - 17.4038$

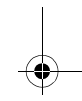
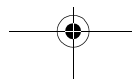
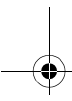
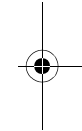
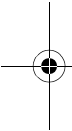

Focusing and Positioning the Screen Image

When an image appears on screen, check that it is in focus and correctly positioned on the screen.

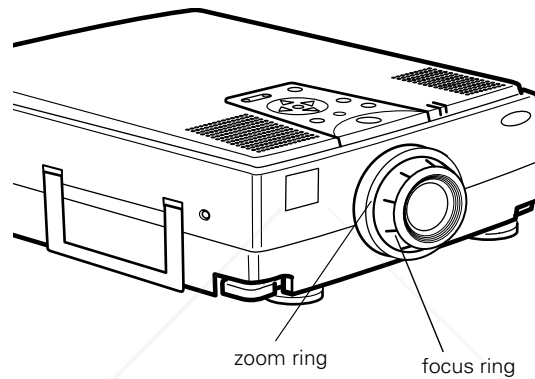

- To focus the image, rotate the focus ring (the inside ring on the lens).
- To adjust the size of the image, rotate the zoom ring (the outside ring). Rotate the zoom ring clockwise to make the screen image larger or counterclockwise to make it smaller.

If you need to raise or lower the image on the screen, extend or retract the two feet at the bottom of the projector as follows:

1. Stand behind the projector and support the front of it while you lift up on the foot adjust levers, located above the feet. This unlocks the adjustable feet so they can move up and down. Don't let the projector drop.



Caution: Don't hold or lift the projector by its lens. This can damage the lens.

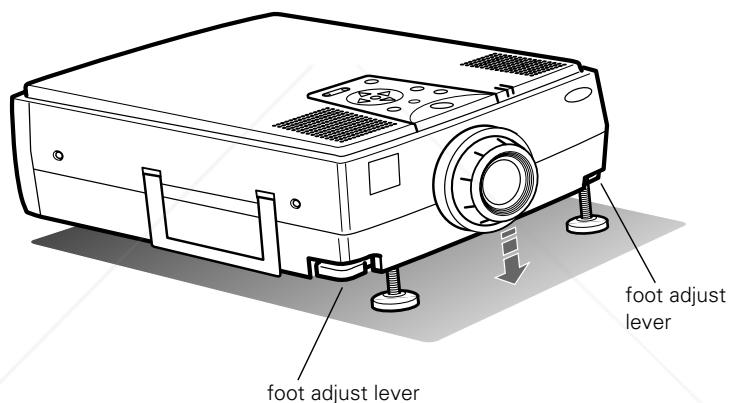

2. While lifting the levers, raise or lower the projector until the screen image is correctly positioned.
3. Release the levers to lock the feet in their new position.
4. If you want to fine-tune the height of the projector, turn the adjustable feet clockwise to raise the height, and counterclockwise to lower the height.



Discount-Merchant.com (800) 281-8860

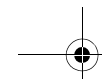

Resize Button

The Resize button lets you select the projection method for certain types of image signals input from a computer.

With images below SVGA size (800 × 600 pixels) on the PowerLite 5300, or below XGA size (1024 × 768 pixels) on the PowerLite 7200 or PowerLite 7300, you can choose from two projection methods. Either display the image in the center of the projection area or display the image full size.

You can also choose from two projection methods with images greater than SVGA size (PowerLite 5300) or XGA size (PowerLite 7200 or PowerLite 7300). Either project a portion of the image or project the entire image in a compressed format. The projector automatically reduces the image size to the projector's maximum resolution.

The Resize button cannot be used with SVGA (800 × 600) on the PowerLite 5300, or with XGA (1024 × 768) on the PowerLite 7200 or PowerLite 7300.

There's a Resize button on both the control panel and remote control.

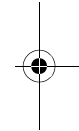
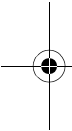

Sleep Mode

Sleep mode conserves electricity by automatically turning off the lamp after the projector has not been used for 30 minutes. In sleep mode, the projector's power status indicator is orange and only a minimum amount of the projector's circuitry remains on. This conserves

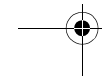
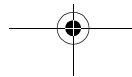



electricity, cools the projector, and extends the life of the lamp. When the projector is in sleep mode, you can press the POWER button to start projecting images, or you can unplug the projector's power cord.

Controlling the Projector

You can use the remote control or the control panel on top of the projector to perform the following actions:

- Turn the power on or off
- Switch between input images (Computer 1, Computer 2, or Video)
- Access the projector menus to adjust the image, audio, video, and display settings
- Control resizing
- Control display freeze (remote control only)
- Control display blanking
- Adjust or mute audio output
- Use custom functions (remote control only)
- Adjust or mute the video

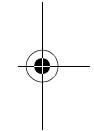
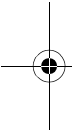

Discount-Merchant.com (800) 281-8860

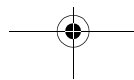

Using the Remote Control

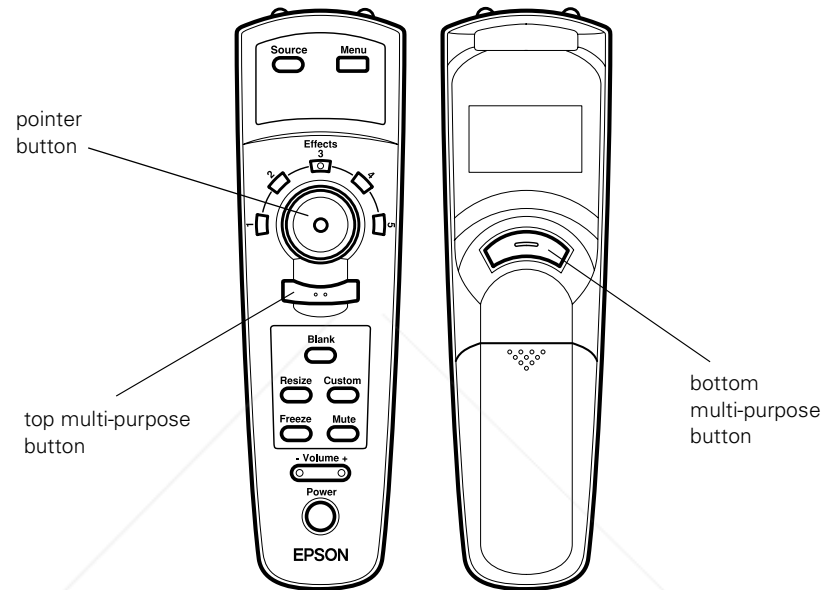

The remote control uses a line-of-sight infrared signal. To use the remote control, point it towards one of the remote control receivers located at the front and back of the projector. (See page 58.)

You can use the remote control up to about 32.8 feet (10 meters) from the projector. (This distance may be shorter if the remote control batteries are low.) You must also be within a $\pm 30^\circ$ angle from the front or rear sensor.



***Note:** The projector may not respond to remote control commands in these conditions: ambient light is too bright; a certain type of fluorescent light is present; a strong light source (such as direct sunlight) shines into the infrared receiver; or other equipment emitting infrared energy is present (such as a radiant room heater). Correct these conditions to use the remote control or control the projector from a computer.*

The following table summarizes the remote control functions.

Button	Function
Menu	Displays or hides the menu.
Source	Switches between Computer 1 and Computer 2, and from video to computer. (When the Computer 2 BNC switch on the back of the projector is set to BNC, the source is switched to 5 BNC.)
Pointer button	Use the pointer button to navigate the menus or use the remote as a mouse pointer when the projector is connected to the computer with the main cable and the mouse cable.
Effects buttons	Use to display special effects in conjunction with the ELP Link III software. (See page 96 for instructions.)
Top multi-purpose button	Acts as a right mouse click, selects a menu option, and activates other custom functions.
Bottom multi-purpose button	Acts as a left mouse click, selects a menu option, and activates other custom functions.
Blank	Clears the screen of special effects and switches to a blue or black display, or a user logo.

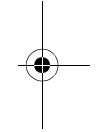
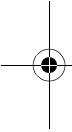

Discount-Merchant.com (800) 281-8860



Button	Function
Resize	Switches the display dot mode and resize mode for VGA, XGA, SVGA, and SXGA input. You cannot resize the image if the input resolution matches the output resolution of the projector (SVGA for the PowerLite 5300, or XGA for the PowerLite 7200 and 7300).
Custom	Accesses Custom menu functions (Zoom, Preview, and Strobe). See page 88 for more information.
Freeze	Keeps the current computer or video image on the screen.
Mute	Turns off audio.
- Volume +	Adjusts the volume.
Power	Starts or stops the projector.

Using the Control Panel

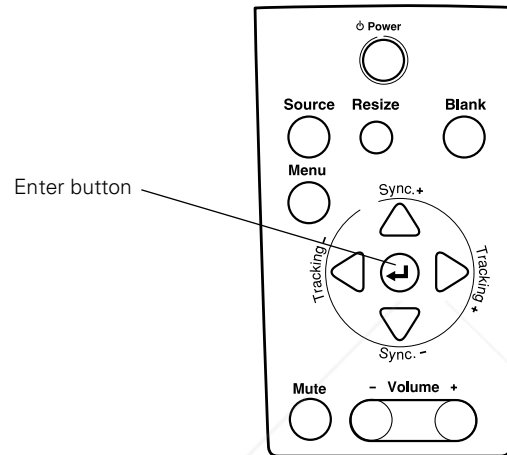

You can use the control panel to control the projector instead of the remote control. However, you can program and access the custom features only when you are using the remote control.

The following table summarizes the control panel functions.

Button	Function
Power	Starts or stops projection.
Source	Switches between Computer 1 and Computer 2, and from video to computer. (When the Computer 2/BNC switch on the back of the projector is set to BNC, the source is switched to 5BNC.)
Menu	Displays or hides the menu.
Up, down arrows (Sync+/Sync-)	Synchronizes the computer's graphic signal. Use these buttons to adjust an overall image that is fuzzy or streaked, or to select menu items during menu operations. Allows movement within the menus, if a menu is displayed.
Left, right arrows (tracking-/tracking+)	Matches the projector's internal clock to various computer graphic signals (tracking adjustment). Use these buttons to adjust an image with vertical fuzzy lines, or to change numeric settings during menu operations. Allows movement within the menus, if a menu is displayed.
Enter	Selects a menu option.
Resize	Switches the display dot mode and resize mode for VGA, XGA, SVGA, and SXGA input. You can't resize the image if the input resolution matches the output resolution of the projector (SVGA for the PowerLite 5300, or XGA for the PowerLite 7200/7300).
Mute	Turns off audio.
- Volume +	Adjusts the volume.
Blank	Clears the screen of special effects and switches to a blue or black display, or a user logo.



Projector Status Lights

The lights on top of the projector tell you the projector's operating status.

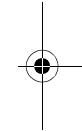
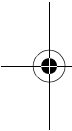
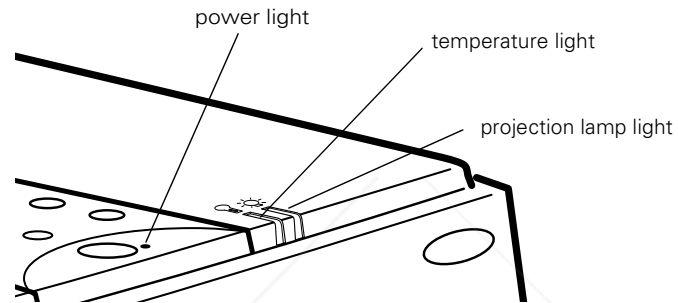

Caution: A red light warns you if a serious problem occurs. See Chapter 6 for what to do if a warning light comes on.



FixYourDLP.com

Sponsored by 

Discount-Merchant.com (800) 281-8860

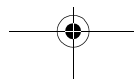



Power Light

Light status	Meaning
Steady orange	Sleep mode. (The projector is plugged in, but not projecting.)
Steady green	Power and lamp are on.
Flashing green	The projector is warming up. Allow about 30 seconds.
Flashing orange	The projector is cooling down.
Off	There is an internal projector problem.

Projection Lamp Light

Light status	Meaning
Orange and red flashing alternately	Projection lamp needs replacing.
Steady red	Projection lamp has burned out. Replace it to project images.
Flashing red	Problem with projection lamp or lamp power supply.
Off	Lamp is functioning normally.

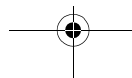
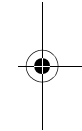
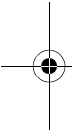



Temperature Light

Light status	Meaning
Flashing orange	Projector is too hot.
Steady red	Projector has turned off automatically because of overheating.
Flashing red	Problem with the cooling fan or temperature sensor.
Off	The projector is functioning normally.

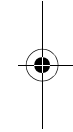
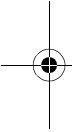

FixYourDLP.com

Sponsored by 

Discount-Merchant.com (800) 281-8860



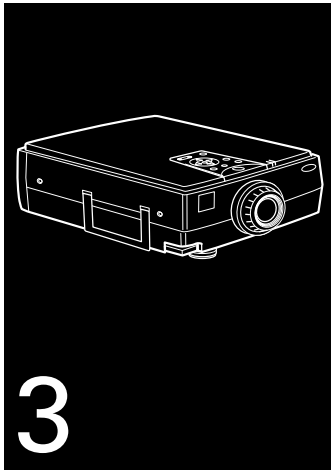

Using the Projector Menus

The six projector menus enable you to control your projector from either the remote control or the control panel:

- The Video menu controls the look and quality of the projected image, and whether the image source is a computer or a video source (for example, a VCR).
- The Audio menu controls audio features, such as the volume level, treble, bass, and 3D sound.
- The Options menu lets you adjust a variety of basic projector settings.
- The Custom menu allows you to access features such as zoom, preview, and strobe through the remote control's Custom button.



Discount-Merchant.com (800) 281-8860
THE TRUSTED SOURCE FOR PROJECTOR LAMPS AND ACCESSORIES



- The About menu provides information about H/V frequency, lamp hours, and computer selection.
- The Reset All menu lets you restore the factory defaults for all the projector settings.

Accessing the Main Menu

To display the Main menu, press the Menu button on the control panel or the remote control. The Main menu appears:



Press the Menu button again to hide the menu.



FixYourDLP.com

Sponsored by

As you select a menu, a submenu of options appears to the right. The options available in some submenus vary, depending on whether the current image source is the computer or a video source. The following illustration shows a list of submenus for the Video menu when the image source is the computer.

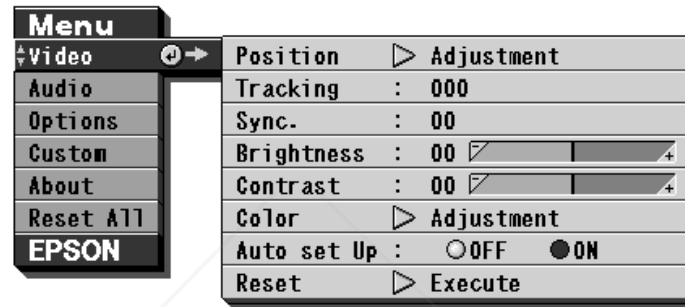

Changing a Menu Setting

To change a menu setting:

1. Press the Menu button on the control panel or remote control to display the Main menu.
2. Press the up or down arrows (control panel) or press up or down on the pointer button (remote) to scroll through the menu choices.

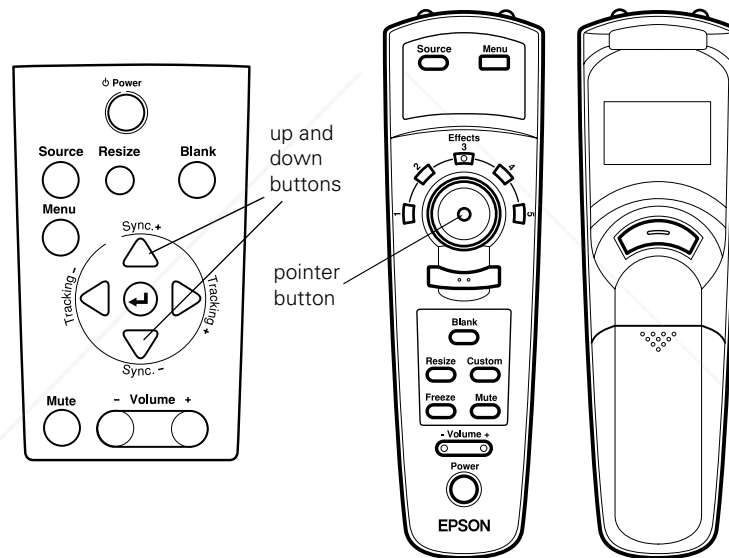

- Press either the Enter button (control panel) or the top or bottom multi-purpose button (remote) to move to a submenu list.

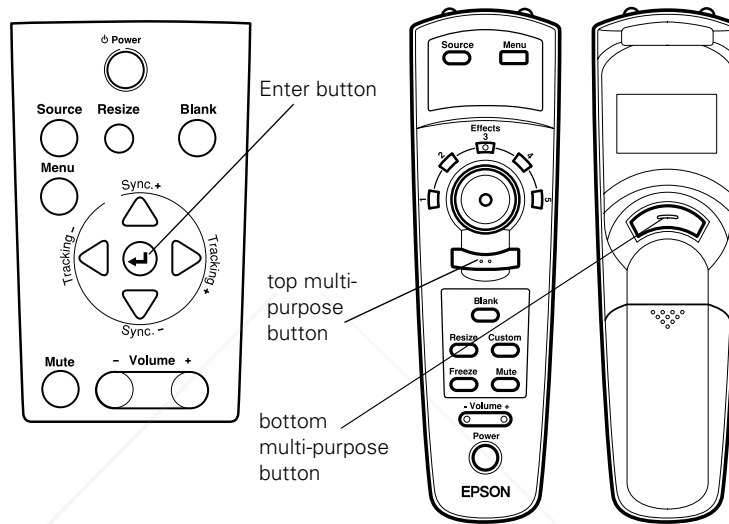

- Press the up or down arrows (control panel) or up or down on the pointer button (remote) to scroll through the submenu choices.
- Press either the left or right arrow buttons (control panel) or right or left on the pointer button (remote) to change a setting on one of the submenus.
- When you are finished changing settings, press Enter (control panel) or the top or bottom multi-purpose button (remote) to go back to the Main menu. The changes are saved automatically.



7. Press the Menu button to hide menus.

The settings available in each of the menus are described below.

Video Menu (Image Source = Computer)

The Video menu enables you to make adjustments to the projected image. The following options are available when the image source is Computer 1 or Computer 2.

Note: The computer must be connected and operating, and the image source on the projector must be set to Computer 1 or Computer 2 for you to access these menu options.

Menu item	Description
Position	Select this item and then press the right arrow button (control panel) or press right on the pointer button (remote) to enter the screen position adjustment mode. Then use the pointer button (remote) or up, down, left, and right buttons (control panel) to move the screen position in the corresponding direction. When you finish making adjustments, press the Enter button (control panel) or a multi-purpose button (remote) to return to the Video menu (Image Source = Computer).
Tracking	Matches the projector's internal clock to various computer graphic signals. Adjust this setting to remove vertical lines from the image.
Sync	Synchronizes with the tracking signal sent from the computer. Adjust this setting to correct fuzziness or screen flicker.
Brightness	Lightens or darkens the overall image. Increase brightness to lighten an image, or decrease it to darken the image.

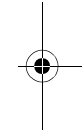
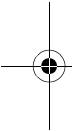

Discount-Merchant.com (800) 281-8860

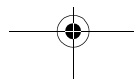



Menu item	Description
Contrast	Adjusts the difference between light and dark areas. Increase the contrast to make light areas lighter and dark areas darker. Decrease it to minimize the difference between light and dark areas.
Color	Adjusts the color balance of the input source. Select this item and then press the right arrow button (control panel) or press right on the pointer button (remote) to enter the color adjustment mode. Then use the pointer button or up and down buttons (control panel) to select a color. Next, use the pointer button or left and right buttons (control panel) to adjust the selected color. Increase the color setting for more intense color on the screen, and lower the setting for less intense color. When you finish making adjustments, press the Enter button (control panel) or a multi-purpose button (remote) to return to the Video menu.
Auto Set Up	When enabled, this item allows the projector to sense the computer signal input and adjust it to the current projector settings. If the projector doesn't automatically recognize the video source, try turning this off and choosing your settings manually.
Reset	Returns all menu items to their initial factory defaults. Select this item and then press the right arrow button (control panel) or right on the pointer button (remote) to display the confirmation screen. Select Yes and then press the Enter button (control panel) or a multi-purpose button (remote) to reset the menu. If you change your mind, select No and then press a multi-purpose button (remote) or the Enter button to clear the confirmation screen without changing any settings.

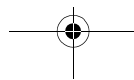
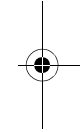
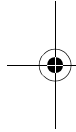



Video Menu (Image Source = Video)

The Video menu enables you to make adjustments to the projected image. The following options are available when the image source is Video.

Note: The projector's image source must be set to Video, and the video source (such as a VCR or camcorder) must be connected and operating for you to access these menu options (for example, the projector must actually be projecting the image from your video tape, if you're using a VCR).

Menu item	Description
Brightness	Lightens or darkens the overall image. Increase brightness to lighten an image, or decrease it to darken the image.
Contrast	Adjusts the degree of difference between light and dark areas. Increase the contrast to make light areas lighter and dark areas darker. Decrease it to minimize the difference between the lightest and darkest areas of the image.
Sharpness	Adjusts the sharpness of the screen image.
Color	Adjusts color density. Increase the setting for darker and more opaque colors. Decrease it for lighter and less opaque colors.
Tint (NTSC only)	Adjusts the red-green color balance of the screen. Increase tint to add more green, or decrease it to add more red.
Mode	Specifies the video signal system. Normally this signal system setting should be left at AUTO to automatically detect the type of video signal. If automatic selection is not possible for some reason, use this menu to manually specify NTSC, PAL, or SECAM.

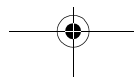
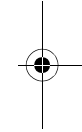
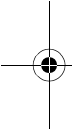

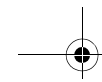

Menu item	Description
Reset	Returns all video menu items to their initial factory defaults. Select this item and then press the right arrow button (control panel) or right on the pointer button (remote) to display the confirmation screen. Next, select Yes and then press a multi-purpose button (remote) or the Enter button (control panel) to reset the Video Menu. If you change your mind, select No and then press a multi-purpose button (remote) or the Enter button (control panel) to clear the confirmation screen without changing any settings.

Audio Menu

The Audio menu enables you to make adjustments related to audio.

Menu item	Description
Volume	Adjusts the volume level for the speakers and audio-out terminal. Increase the audio volume to raise the volume, or decrease it to lower the volume.
Treble	Adjusts the treble tone of the speakers. (Press the right arrow button on the control panel or press right on the remote's pointer button to increase the treble tone; press the control panel's left arrow button or left on the remote's pointer button to decrease the treble tone.)
Bass	Adjusts the bass tone of the speakers. See Treble for details.

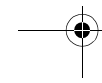
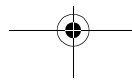
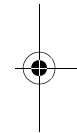
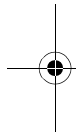



Menu item	Description
3D Sound	Adjusts the speakers' stereo input. For a more expansive stereo sound, increase this setting.
Reset	Returns all audio menu items to their initial factory defaults. Select this item and then press the Enter button (control panel) or a multi-purpose button (remote) to display the confirmation screen. Next, select Yes and then press a multi-purpose button (remote) or the Enter button (control panel) to reset the Audio Menu. If you change your mind, select No and then press a multi-purpose button (remote) or the Enter button (control panel) to clear the confirmation screen without changing any settings.

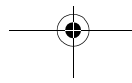
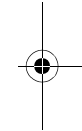
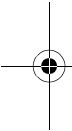



Options Menu

The Options menu lets you adjust basic projector settings.

Menu item	Description
Prompt	Temporarily displays a prompt on the projector screen to identify which source (computer or video) is providing the image.
Color Temperature	<p>Adjusts the whiteness of the screen. The H setting provides a cold white, M a standard white, and L a warm white.</p> <p>To set the color temperature setting more precisely, select the User item, then press the right arrow button (control panel) or right on the pointer button (remote) to enter the color temperature adjustment mode. Select the color you want to adjust, and then use the left and right buttons (control panel) or the pointer button (remote) to change the selected value. A high color temperature value enhances the selected color within the overall image, while a lower value weakens the color.</p> <p>Press the Enter button (control panel) or either multi-purpose button (remote) to return to the Options menu.</p>
Rear Projection	Mirrors the projected image on its Y-axis (left-right). Selecting ON turns mirroring on, while OFF turns it off (for a normal image). Turn on this option when projecting from behind onto a transparent screen.
Ceiling	Mirrors the projected image on its X-axis (top-bottom). Selecting ON turns mirroring on, while OFF turns it off (for a normal image). Turn this option on when the projector is mounted upside-down from the ceiling.
Blank	Specifies whether a black screen, a blue screen, or a user logo displays when the screen is blanked. See page 113 for more information about creating a user logo.

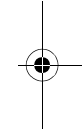
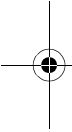



Menu item	Description
View Change	Specifies the screen switching effect to use when changing from one input source to another.
Off	No screen switching effect.
Upper Left - Lower Right	Original source screen shrinks from upper left to lower right, and new source screen expands from upper left to lower right.
Left-Right:	Original source screen shrinks from left to right, and new source screen expands from left to right.
Outside-Middle	Original source screen shrinks from outside in, and new source screen expands from inside out.
Language	Selects the menu language: English, Japanese, French, German, Italian, Spanish, or Portuguese.
Mouse/Com	Locks and unlocks the Mouse/Com port. Select 1 to assign the wireless mouse control to the computer connected to the Mouse/Com 1 port only. Select 2 to assign the wireless mouse control to the computer connected to the Mouse/Com 2 port only. Selecting 1 ↔ 2 tells the projector to automatically switch wireless mouse control whenever the input source computer is changed.

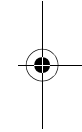
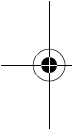

Discount-Merchant.com (800) 281-8860

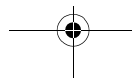



Menu item	Description
BNC Format	Specifies the format for BNC input.
Reset	Returns all option menu items to their initial factory defaults. Select this item and then press the right arrow button (control panel) or right on the pointer button (remote) to display the confirmation screen. Next, select Yes and then press a multi-purpose button (remote) or the Enter button (control panel) to reset the Options Menu. If you change your mind, select No and then press a multi-purpose button (remote) or the Enter button (control panel) to clear the confirmation screen without changing any settings.

Custom Menu

The Custom menu allows you to use your remote control to access special features, such as zoom, preview, or strobe effects.

To open the Custom menu, select CUSTOM from the Main menu. Zoom is highlighted.

Unlike the other menus, the Custom menu requires that you press the Custom button on the remote control to access a Custom menu function. Refer to the table below for a description of those functions and details on how to use them.

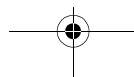
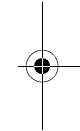
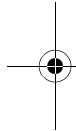



The Custom menu functions are:

Menu item	Function	Description
Zoom		<p>Press the Custom button to access the Zoom function. An indicator appears in the lower right of the screen while the zoom function is on. Zoom remains on until you press the Custom button again.</p> <p>The following remote control functions are available while the zoom function is on:</p>
	Zoom In	Each press of the remote control's bottom multi-purpose button zooms in on the center of the displayed image, enlarging it +0.25 times.
	Zoom Out	Each press of the remote control's top multi-purpose button zooms out on the center of the displayed image, reducing it +0.25 times.
	Zoom Screen Shift	Press the pointer button to zoom in on a portion of the enlarged display. You can move the image up, down, left, right, and diagonally to closely view any part of the display.
Preview		<p>Lets you preview the current image from the three input sources: Computer 1, Computer 2, and Video. (Video input is previewed in real time.)</p> <p>Press the Custom button to access the Preview function. Press right on the pointer button to select Preview.</p> <p>Use the top multi-purpose button to select the input source.</p> <p>The preview function remains on until you press either the Custom button or the remote control's bottom multi-purpose button.</p>

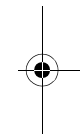
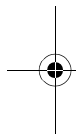

FixYourDLP.com

Sponsored by CM

Discount-Merchant.com (800) 281-8860

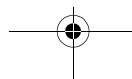



Menu item	Function	Description
Strobe		Allows you to strobe moving images on up to 16 frames in time intervals from 0.1 to 1 second. To turn on the strobe function, press the Custom button, then press right on the pointer button to select Strobe. Then press the Custom button, followed by the bottom multi-purpose button. The strobe function remains on until you press the Custom button again.
	Number of Frames, Time	Press the top multi-purpose button while the strobe effect is running to display a screen specifying the number of frames flashed and the time interval between them. You can specify the number of frames as 4, 9, or 16, and the time interval from 0.1 to 1 second in 0.1 second increments. Press the top multi-purpose button again to clear the setting screen. Press the Custom button to exit.

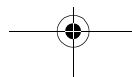
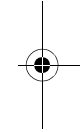
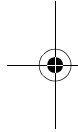



About Menu

The About menu displays information about the projector's horizontal and vertical frequency, lamp hours, and computer connection.

Menu item	Function	Description
H/V Freq.		Displays the projector's horizontal and vertical frequency.
Lamp		Displays the number of hours the current lamp has been used.
Computer 2/BNC		Displays which source is selected on the back of the projector: BNC or Computer 2.

Reset All Menu

The Reset All menu lets you return all the projector settings to their default values. Select **Reset All** and press the **Enter** button on the control button or a multi-purpose button on the remote control to display the confirmation screen. Select **YES** to reset all the default settings or **NO** to cancel.



Discount-Merchant.com (800) 281-8860

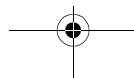
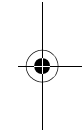
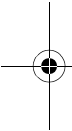

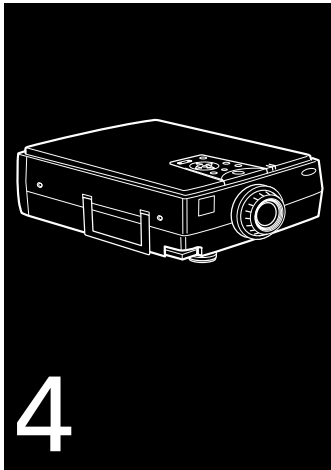

Using the ELP Link III Software

The ELP Link III software is a utility you can run from your desktop or laptop computer to control projector features and draw special graphics on your screen. You can also use the software to reconfigure the special effects buttons on the remote control.



Discount-Merchant.com (800) 281-8860
THE TRUSTED SOURCE FOR PROJECTOR LAMPS AND ACCESSORIES

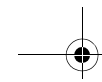

Installing the Software

ELP Link III software can be used with the following operating systems:

- Windows 3.x
- Windows 95 or 98
- Windows NT 4.0
- Macintosh OS System 7 and OS System 8

Connecting Needed Cables

Before installing the software, make sure the projector is properly connected to your computer. See Chapter 1 for instructions on installing the main and serial cables needed to use the ELP Link III software.

Installing the Software for Windows

Follow these steps to install ELP Link III for Windows 3.x, Windows 95 or 98, or Windows NT:

1. Turn on your computer and start Windows.
2. Insert the Projector Software CD into your CD-ROM drive.
3. If you have Windows 95, 98, or NT, click Start and then Run.

If you have Windows 3.x, in Program Manager click on the File menu, then on Run.



Discount-Merchant.com (800) 281-8860

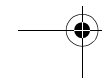
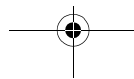
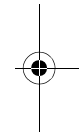
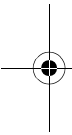

4. The Run dialog box appears. Type E:\SETUP (substitute the correct drive letter for your CD-ROM drive if it is not E), then press Enter or click OK. You see the ELP Link III welcome screen listing the languages available for installation screens.
5. Select the language you want for running the software and click OK.
6. You see the ELP Link III main menu. Click Install ELP Link III V2.0.
7. You see a list of items to install. Make sure ELP Link III V2.0 and ELP Link User's Guide are checked. If you don't have Adobe® Acrobat® Reader on your system, also check Acrobat Reader to install the program so you can view your online manual. Then click Install.
8. After a moment, you see the ELP Link3 Welcome screen. Click Next.
9. You see the Software License Agreement screen. Read the agreement and click Yes.
10. Follow the instructions on the screen to select a directory or a folder for the software. Then the Installer copies the ELP Link III files to your system.
11. When the installation is complete, click Finish.
12. If you selected to install the online User's Guide and Acrobat Reader, follow the on-screen instructions to install them.
13. When you return to the ELP Link III main menu, click QUIT.



Discount-Merchant.com (800) 281-8860

THE TRUSTED SOURCE FOR PROJECTOR LAMPS AND ACCESSORIES

Installing the Software



Installing the Software for a Macintosh

Follow these steps to install the software for the Macintosh:

1. Insert the Projector Software CD into your CD-ROM drive.
2. Open the CD-ROM drive icon, if necessary.
3. Double-click the Installer icon.
4. You see a dialog box asking you to select a language for the software. Select a language and click OK.
5. You see the ELP Link III main menu. Click Install ELP Link III V2.0.
6. You see the Software License Agreement screen. Read the agreement and click Accept.
7. You see the Installer dialog box. Click Install. The installer copies the program to your hard disk.
8. When the installation is finished, click Quit.

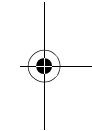
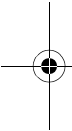

Launching the Software

Follow the steps in the appropriate section below to launch the software. If you're using the remote control as a mouse, use the pointer button to position the cursor and the bottom multi-purpose button to launch the software.

Note: If you have a Macintosh, your screens may look slightly different than the screens in this chapter.



Discount-Merchant.com (800) 281-8860

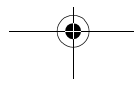

Launching the Software from Windows

1. If you have Windows 3.x, double-click the ELP Link III program icon in the Windows 3.x ELP Link III program group. If you have Windows 95, 98, or NT, click Start, then select Programs, ELP Link III, and then click the ELP Link3 program icon.

The ELP Link III program icon appears minimized at the bottom of your screen, or on the taskbar if you're running Windows 95, 98 or NT.

Note: If you see a prompt asking you to select a port or open the software with the projector disconnected, it may be because the projector is disconnected or is connected to an incorrect COM port. If you want to run the software without the projector connected, select Unconnected and Execute. If it is connected, click Select a port, and retry. Then select the COM port you're using on the next screen.



2. Click the minimized program icon. The ELP Link III main dialog box appears.





Launching the Software on a Macintosh

1. Open the ELPLink3 folder.
2. Double-click the ELPLink3 icon.

ELP Link III launches and three menus—File, Option, and Help—appear at the top of the screen. If you're launching ELP Link III for the first time, select COM PORT from the Option menu, then choose either the  printer or  modem port (whichever port you connected the serial cable to). Then open the Option menu and select Property Setting to display the ELP Link III main window.

Using the Software

The ELP Link III software can be used to:

- Customize the remote control Effects buttons
- Control standard and special projector features

Note: If you ever select Unconnected and Execute from the Option menu, always uncheck the setting before exiting ELP Link III so the program starts correctly the next time you use it.

Customizing the Remote Control Effects Buttons

You can assign functions to the remote control Effects buttons so you can use them to perform special operations, such as drawing shapes on the projected image or changing the cursor shape. You customize the Effects buttons from the ELP Link III main dialog box.



Discount-Merchant.com (800) 281-8860

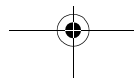



Function Description and Usage

To assign a function to an Effects button on the remote control, select the corresponding Effects button on the ELP Link III main dialog box, then choose a function for it from the pull-down menu. (See page 99 for more information.)

The table below describes these functions and how to use them.

Note: To use the Effects buttons, the ELP Link III software must be running and the computer connected to the projector. Once you have pressed an Effects button, you can size and position the effect by using either your mouse or your remote control (if you've set up the remote control to function as a mouse).

Function	Description and usage
Line	<p>Draws a straight line on the screen.</p> <p>Press the Effects key assigned to this effect. Then press the bottom multi-purpose button once to define the line start position. Move the cursor using the remote Pointer button. Then press the bottom multi-purpose button again to define the line end position. To draw another line, move the cursor away from the line you just created and press the bottom multi-purpose button again to define the new line start position.</p>
Ellipse	<p>Draws an ellipse (oval) on the screen.</p> <p>Press the Effects key assigned to this effect. Then press the bottom multi-purpose button once to define the start position of the ellipse. Move the cursor using the remote Pointer button. Then press the bottom multi-purpose button again to define the end position of the ellipse. To draw another ellipse, move the cursor away from the one you just created and press the bottom multi-purpose button again to define the start position for the new ellipse.</p>

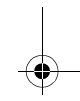
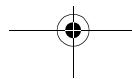
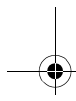
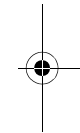
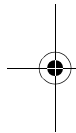



Function	Description and usage
Box	<p>Draws a square on the screen.</p> <p>Press the Effects key assigned to this effect. Then press the bottom multi-purpose button once to define the position of one corner of the square. Move the cursor using the remote Pointer button. Then press the bottom multi-purpose button again to define the position of the opposite corner of the square. To draw another square, move the cursor away from the one you just created and press the bottom multi-purpose button again to define the start position for the new square.</p>
Bar	<p>Creates a horizontal or vertical bar. You can use this function to highlight a portion of the screen with a horizontal or vertical bar.</p> <p>Press the Effects key assigned to this effect. Move the bar using the remote pointer button. Press the bottom multi-purpose button to lock the bar in place. To draw another bar, move the cursor away from the bar you just created and press the bottom multi-purpose button again to lock the new bar in place.</p>
Stamp	<p>Leaves one or several copies of a pre-selected image on the screen.</p> <p>Press the Effects key assigned to this effect. Use the pointer button to place the cursor where you want the stamp to appear. Then press the assigned Effects button to display the stamp. To draw another stamp, move the cursor away from the stamp you just created and press the bottom multi-purpose button again to lock the new stamp in place.</p>
Cursor Change	<p>Changes the cursor shape.</p> <p>Press the assigned Effects button to change the cursor shape.</p>
Screen Clear	<p>Clears all Effects functions previously executed.</p> <p>Press the assigned Effects button to clear the screen.</p>
Key Macro	<p>Types a pre-defined key sequence. This is useful when you often need to type a sequence of characters into your computer.</p> <p>Press the assigned Effects button to automatically type the key sequence.</p>

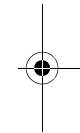
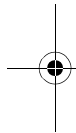

FixYourDLP.com

Sponsored by 

Discount-Merchant.com (800) 281-8860

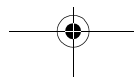

Note: To cancel or end a function, double-click with your mouse or press the bottom multi-purpose button twice (if you're using the remote control as a mouse).

Assigning Functions



Each of the five Effects buttons is assigned a default function. If you want to assign a different function to a button, click the list box that corresponds to the button number and select a new function from the list.

Setting Effects Options

Once you have assigned functions to one or more Effects buttons, you can specify detailed options for each function.

To set detailed options, click Detail Setting. A dialog box similar to the following appears. (The options and tabs displayed depend on which functions are currently assigned to the Effects buttons.)

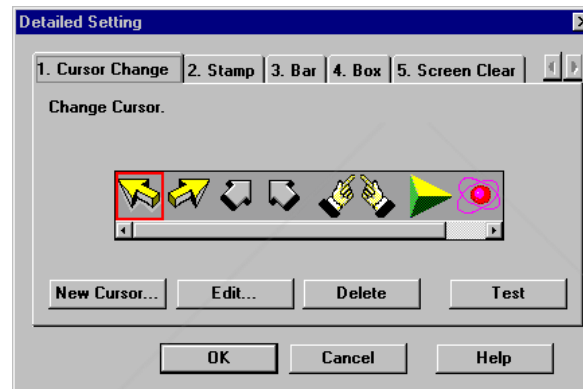

Click the tab for the function you want to adjust, then make any settings you wish.

To test each setting, click the Test button and then click the left mouse button to start and stop each setting. To end the test, click the right mouse button. (If you are using the remote control as a mouse pointer, use the bottom and top multi-purpose buttons, respectively.)

To save the changes, click OK.



The following table describes the available options for each function.

Function	Options	
Line	Width	Specify the line width, from 1 to 32 points.
	Grid	Specify whether to have the line “snap” to the corners of a grid by entering the size of the sides of the box, in pixels (dots).
	Color	Choose a color for the line.
	Transparent	Click this check box to make the background text or image visible through the line.
Ellipse	Width	Specify the line width, from 1 to 32 points.
	Color	Choose a color for the line.
	Transparent	Click this check box to make the background text or image visible through the ellipse.
	Fill	Click this check box to fill the ellipse with color.
Box	Width	Specify the line width, from 1 to 32 points.
	Color	Choose a color for the line.
	Transparent	Click this check box to make the background text or image visible through the square.
	Fill	Click this check box to fill the square with color.
	Make oval shape	Click this check box to round the corners of the square.
Bar	Width	Specify the line width, from 1 to 300 points.
	Color	Choose a color for the bar.
	Direction	Choose Horizontal or Vertical.
	Transparent	Click this check box to make the background text or image visible through the bar.
Stamp	Click on the stamp to be used.	

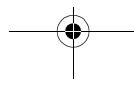
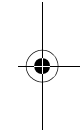
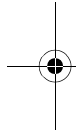



Function	Options
Cursor Change	Click on the cursor shape to be used.
Screen Clear	No options available.
Key Macro	Enter up to 16 characters, including combinations such as Ctrl + A, in the Registration Key field. The Backspace and Delete keys are also recorded. Click the Clear button to clear the current key assignment. Note: Although you can save multiple sets of key assignments, only one key set can be active at a time. Click the Registration button to save more than one set of key assignments.

Saving and Recalling Effects Button Assignments

To save Effects button assignments, click Execute.

To save multiple sets of button assignments, click Registration and specify a name for the current settings.

To recall a saved set of assignments, select its name from the Setting menu.

To delete a set of assignments from the Setting menu, select its name and then click Delete.

To exit without saving the settings, select Exit from the file menu.

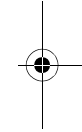
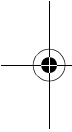

Discount-Merchant.com (800) 281-8860

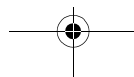

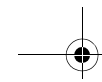

Changing the COM Port Assignment

If you did not select the correct COM (communication) port when setting up the software, or if you have changed the COM port to which the projector is connected, you can change the COM port setting from the ELP Link III software.

1. Select Com Port from the Options menu.
2. Choose a COM port from the list that appears.

Controlling Projector Features

You can use the Projector Setting window to control the following features:

- Projector Controls
- Test Pattern
- Color Properties

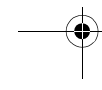
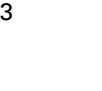
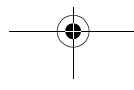
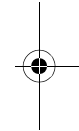
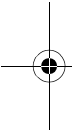

Displaying the Projector Set Window

Follow these steps to display the Projector Setting window from Windows:

1. Display the ELP Link III main dialog box. See page 95 for details.
2. Select the Projector Setting icon at the bottom of the screen.
The Projector Setting window appears:

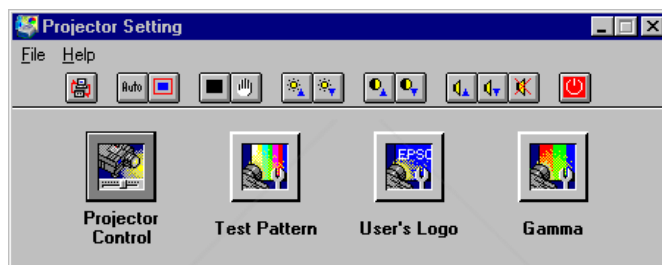

Note: See “Launching the Software on a Macintosh” on page 96 for information about displaying the Projector Setting window on a Macintosh.

Using the Quick Change Toolbar

To quickly change some basic projector settings, click one of the toolbar buttons described below:

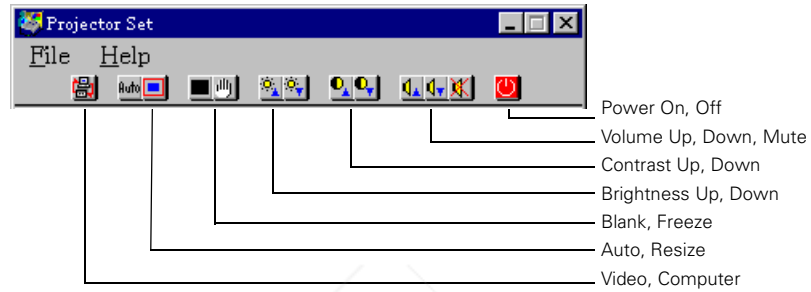

Changing Projector Settings

1. Click Projector Control on the Projector Set dialog box. The following window appears:



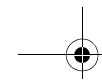

2. Click the tab for the settings you want to adjust.
3. Change one or more of the following options.

Video Tab (Computer Input)

Option	Description
Brightness	Adjusts screen brightness.
Contrast	Adjusts screen contrast.
Sync.	Adjusts the sync (synchronization) to remove screen flicker.
Tracking	Adjusts tracking to remove vertical lines.
Color	Adjusts the balance of red, green, and blue in the image.
Position	Adjusts the horizontal and vertical screen position.
Auto Set Up	Enables or disables automatic adjustment of the graphic signal being sent from the computer to optimize it for the projector.
Pattern Display	Displays the test pattern currently selected.
Reset	Resets all fields to their default values.

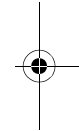
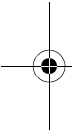

Discount-Merchant.com (800) 281-8860

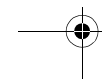
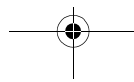



Video Tab (Video Input)

Option	Description
Brightness	Adjusts screen brightness.
Contrast	Adjusts screen contrast.
Sharpness	Adjusts screen sharpness.
Color	Adjusts the color density.
Tint	Adjusts the color tint. (NTSC only)
Mode	Selects the signal format. You can select AUTO, PAL, NTSC, or SECAM. AUTO automatically adjusts the image to the signal received.
Pattern Display	Displays the test pattern currently selected.
Reset	Resets all fields to their default values.

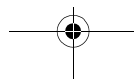
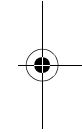
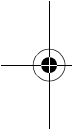

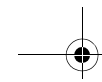

Audio Tab

Option	Description
Volume	Adjusts sound volume.
Treble	Adjusts the treble tone.
Bass	Adjusts the bass tone.
3D Sound	Adjusts stereo sound effects. When you increase the number, the stereo effect is enhanced.
Pattern Display	Displays the test pattern currently selected.
Reset	Resets all fields to their default values.

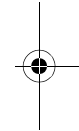
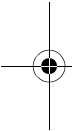

Discount-Merchant.com (800) 281-8860

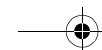

Option Tab

Option	Description
Blank	Specifies blank screen states: Logo The user's logo displays briefly. Black A black screen displays. Blue A blue screen displays.
View Change	Specifies how the screen should disappear when changing the image source: Off Turns the View Change setting off. Diagonally Images disappear and appear from the top left of the screen to the bottom right. Left to Right Images disappear and appear from the left to the right. Fade In Images appear from the center of the screen and disappear to the center.
Color Temp	Specifies a color temperature. H High (more blue) M Medium (normal white) L Low (more red) User Create a custom color temperature by using the slide bars to specify the amount of red and blue.
Install	Specifies how the projector is being used: Rear Proj. Use this setting when projecting to the back of a screen so the image is flipped left to right. Ceiling Use this setting when the projector is installed on the ceiling so the image is flipped top to bottom.
Prompt	Temporarily displays a prompt on the projector screen identifying which source (computer or video) is providing the image.



Option	Description
BNC Format	Specifies the input image signal mode as either RGB or Y, R-Y, B-Y.
Pattern Display	Displays the test pattern currently selected.
Reset	Resets all fields to their default values.

Custom Tab

Option	Description
Customize Function	Zoom Preview Strobe Frame Counts Frame Times
Zoom	Zooms in on the screen image.
Preview	Displays the images from all the connected devices on the screen at one time.
Strobe	Displays the selected images in the specified number of frames and time interval.
Frame Counts	Specifies the number of frames in which to show the image.
Frame Times	Specifies the interval for the strobe, in seconds.
Pattern Display	Displays the test pattern currently selected.

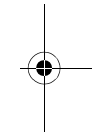
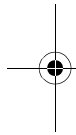

Discount-Merchant.com (800) 281-8860

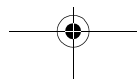

Changing the Test Pattern

1. Click Test Pattern on the Projector Setting dialog box. The following window appears:



2. You can display a test pattern to verify that the projector is working properly. Choose one of the following:
 - Color Image Displays a color bar test pattern.
 - Gray Scale Displays a gray scale test pattern.
 - Focus Pattern Displays a character-based focus pattern.
 - User File (bmp) Displays a bitmapped test pattern from the file name specified. Either type the name or click Ref... (refer) to browse the hard disk for the file. The bitmap should be 1024 × 768 pixels (PowerLite 7200 and 7300) or 800 × 600 pixels.
3. Click Pattern Display to display the test pattern selected. Then click Close.

Specifying an Image Gamma

1. Click Gamma on the Projector Setting dialog box. The Gamma Setting window appears.

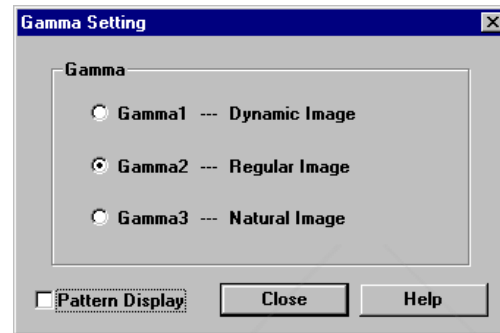

2. Select the desired gamma:
Gamma 1 Provides a dynamic and contrastive image.
Gamma 2 Provides an image between Gamma 1 and Gamma 3.
Gamma 3 Provides a natural image.
3. Click Pattern Display to display the test pattern selected.

Creating a User Logo

You can create or edit a logo from the Projector Setting dialog box, then save it to a file on your hard disk or download it to the projector.

1. Click User's Logo on the Projector Setting dialog box. The User's Logo Setting window appears.

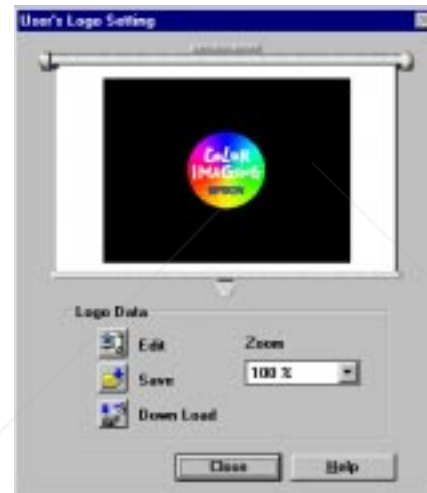

2. Click the Edit button. The following window appears.

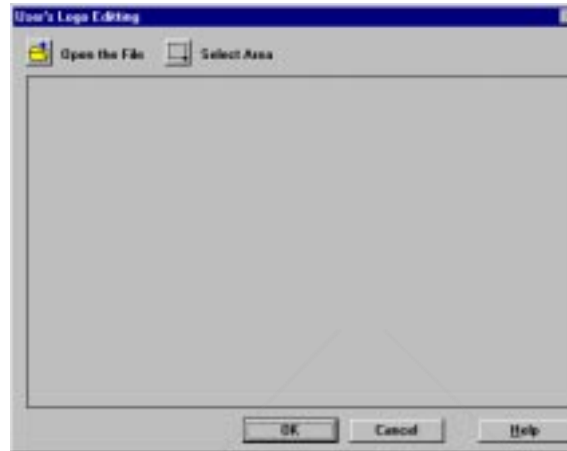

3. Click the Open the File icon to locate and open a bitmap (or TIFF, JPG, PSO) file. The selected image appears in the display area.
4. To crop the image, click the Select Area button and position the crop marks. Click OK to accept the changes. The User's Logo window reappears.
5. To increase or decrease the size at which the logo displays, select a zoom percentage from the Zoom list box.
6. Click the Save button to save your logo to your hard disk. The Save As dialog box appears.

Note: You must save logo files with the extension .lgo.



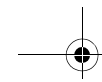

7. To download a logo file to the projector, click the Download button and follow the directions on the screen.

Note: To change the logo that appears in the display area of the User's Logo Setting window, click the File icon to locate and open a different file.

8. Click Close to return to the Projector Setting dialog box.

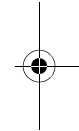
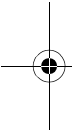

Discount-Merchant.com (800) 281-8860
THE TRUSTED SOURCE FOR PROJECTOR LAMPS AND ACCESSORIES

Using the Software

115

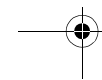
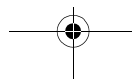

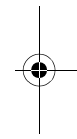
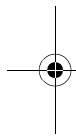

Discount-Merchant.com (800) 281-8860

THE TRUSTED SOURCE FOR PROJECTOR LAMPS AND ACCESSORIES

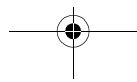

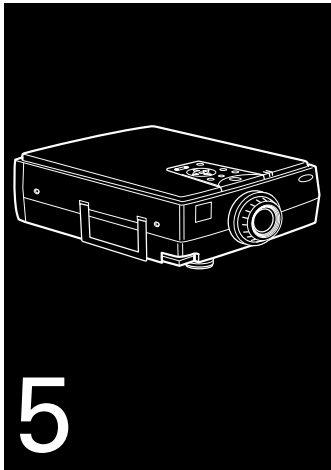

Maintenance

Your projector needs little maintenance. You should keep the lens clean because any dirt or smears appear on the screen. You also need to periodically clean the air filter at the bottom of the projector. A clogged air filter can block ventilation needed to cool the projector and keep it from overheating.

The only parts you should replace are the lamp and air filter. If any other part needs replacing, contact your dealer or a qualified service person.



Discount-Merchant.com (800) 281-8860

THE TRUSTED SOURCE FOR PROJECTOR LAMPS AND ACCESSORIES



Warning: Before you clean any part of the projector, turn off the projector and unplug the power cord. Never open any cover on the projector, except the lamp and filter covers. Dangerous electrical voltages in the projector can injure you severely. Do not try to service this product yourself, except as specifically explained in this User's Guide. Refer all other servicing to qualified service personnel.

Cleaning the Lens

Clean the lens whenever you notice dirt or dust on the surface. Lightly wipe the lens surface with a soft, dry, lint-free cloth. To remove dirt or smears on the lens, moisten a soft cloth with an alcohol-based cleaner and gently wipe the lens surface.

Cleaning the Projector Case

To clean the projector case, first unplug the power cord. To remove dirt or dust, wipe the case with a soft, dry, lint-free cloth. To remove stubborn dirt or stains, moisten a soft cloth with water and a neutral detergent. Then wipe the case.

Do not use alcohol, benzene, thinner, or other chemical detergents. These can cause the case to warp.

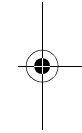
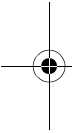

Discount-Merchant.com (800) 281-8860

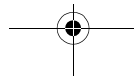

Cleaning the Air Filter

Clean the air filter at the bottom of the projector after every 100 hours of use. If it is not cleaned periodically, it can become clogged with dust, preventing proper ventilation. This can cause overheating and damage the projector. To clean the air filter, follow these steps:

1. Turn off the projector and unplug the power cable.
2. Turn the projector on its side so that the handle is on top and you can access the filter easily.

Note: Standing the projector with the handle at the top keeps dust from getting inside the projector housing.

3. Pull up on the filter cover tab to release the filter cover. Remove the cover.

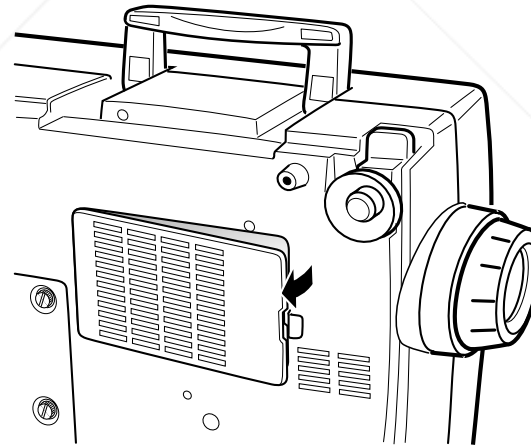



- The filter is attached to the inside of the filter cover. It is recommended that you use a small vacuum cleaner designed for computers and other office equipment to clean the filter. If you don't have one, use a dry, lint-free cloth.

If the dirt is difficult to remove or if the filter is torn, replace it. Contact your dealer or call EPSON Accessories at (800) 873-7766 in the United States and Canada to obtain a new one.

- Replace the filter cover when you're done.

Replacing the Lamp

The projection lamp typically lasts for about 2000 hours of use. It is time to replace the lamp when:

- The projected image gets darker or starts to deteriorate.
- The projection lamp light is either red, or flashing orange and red alternately.
- The message **LAMP REPLACE** appears on the screen when the projection lamp comes on.

Contact your dealer or call EPSON Accessories at (800) 873-7766 in the United States and Canada for a replacement lamp. Request part number ELPLP05.



Warning: Let the lamp cool before replacing it. Also, do not touch the glass portion of the lamp assembly. Touching the glass portion of the lamp will result in premature lamp failure.



Discount-Merchant.com (800) 281-8860

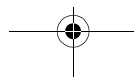
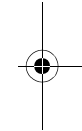
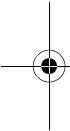

1. Turn off the projector and unplug the power cable.
2. Turn the projector over so you can access the lamp cover.
3. Use a screwdriver, coin, or similar object to loosen the two retaining screws on the lamp cover. When the screws are loose, lift off the lamp cover. (You cannot remove these screws from the cover.)

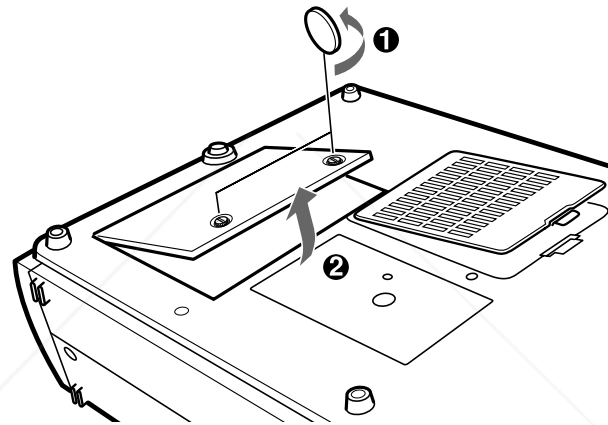

4. Use a screwdriver, coin, or similar object to loosen the two screws holding the lamp unit in place. (You cannot remove these screws.)

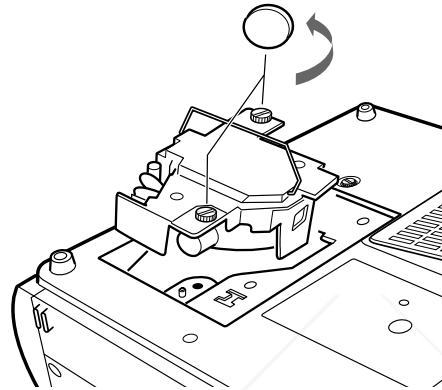

5. Lift up the handle and pull out the lamp unit.

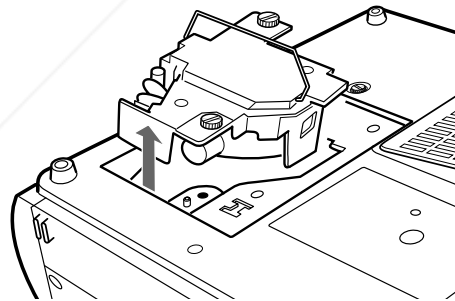

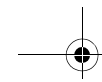

6. Gently insert the new lamp unit by lowering it into position. Make sure it's inserted securely. Tighten the screws on the new lamp unit.
7. Replace the lamp cover and tighten the cover screws. (Make sure the lamp cover is securely fastened. The projector turns itself off if the lamp cover is open.)

Transporting the Projector

The projector contains many glass parts and precision parts. If you need to transport it, please follow these packing guidelines to prevent damaging the projector:

- When shipping the projector for repairs, use the original packaging material if possible. If you do not have the original packaging, use equivalent materials, placing plenty of cushioning around the projector.
- When transporting the projector for business use, first put the projector in a hard-shell carrying case (such as the optional EPSON accessory case), then pack it in a firm box, using cushioning around the case.
- When you are hand-carrying the projector, be sure to store it in a hard-shell or soft carrying case (such as the optional cases offered by EPSON).

Note: EPSON shall not be liable for any damages incurred during transportation.



Discount-Merchant.com (800) 281-8860

THE TRUSTED SOURCE FOR PROJECTOR LAMPS AND ACCESSORIES

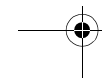
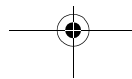
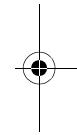
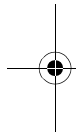

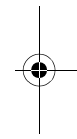
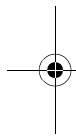

FixYourDLP.com

Sponsored by 

Discount-Merchant.com (800) 281-8860

THE TRUSTED SOURCE FOR PROJECTOR LAMPS AND ACCESSORIES

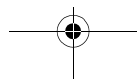

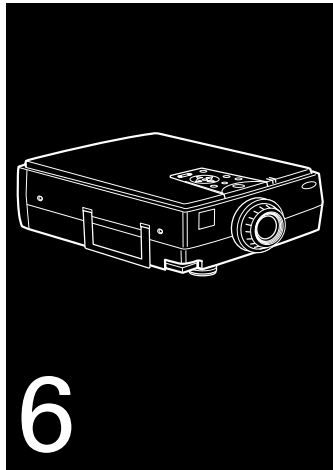

Troubleshooting

This chapter describes the problems indicated by the warning lights and provides information on how to solve problems with the projector. It is divided into the following sections:

- Problems with the projector. See this section if the projector is not working and to find out what the warning lights are indicating.
- Problems with the remote control. See this section if the projector is not responding to remote control commands.
- Problems with the screen image. See this section if you cannot project an image or if the screen image is not good.



Discount-Merchant.com (800) 281-8860

THE TRUSTED SOURCE FOR PROJECTOR LAMPS AND ACCESSORIES



If you have a problem, check the appropriate section and follow all suggestions that apply to your problem. If none of the suggestions solves the problem, call your dealer or contact EPSON as described on page 6.

Problems with the Projector

If you have problems with the projector, first turn it off and unplug it. Then plug the power cord back in and turn on the projector. If this does not solve the problem, check the warning lights at the top of the projector. These lights alert you to problems with projector operation.

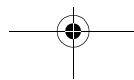
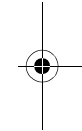
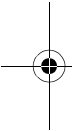
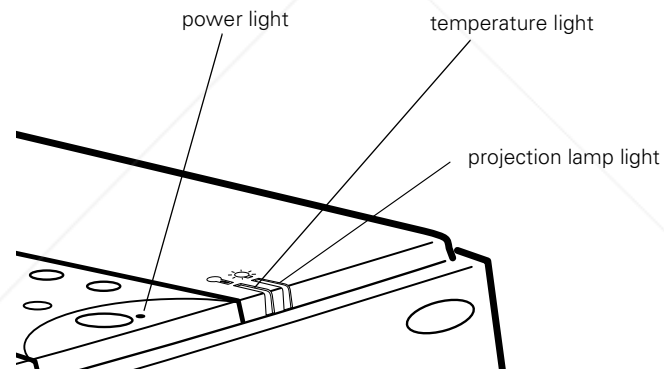

Light	Color	Meaning
Temperature	Flashing orange	The projector is hot.
	Red	The projector is too hot and has turned off automatically.
	Flashing red	There's a problem with the cooling fan or temperature sensor. Call a service representative.
Projection lamp	Red or flashing orange and red	The lamp needs to be replaced. (See "Replacing the Lamp" in Chapter 5 for instructions.)
	Flashing red	There's a problem with the projection lamp, lamp power supply, lamp fuse, or a circuit malfunction in the projector.
Power	Flashing green	The projection lamp is warming up.
	Flashing orange	The projection lamp is off and the projector is cooling down.
	Green	The projector is operating normally.
	Orange	The projector is in sleep mode.
	Off	The projector has turned off automatically because of internal problems. Contact your service representative.

See the following pages for information on what to do when you see these warning lights or encounter other specific problems with the projector.



Discount-Merchant.com (800) 281-8860
THE TRUSTED SOURCE FOR PROJECTOR LAMPS AND ACCESSORIES



- ▶ **The power light is flashing orange and you cannot turn on the projector.**

The lamp is cooling down. Wait until the light turns off and then turn on the projector.

- ▶ **The power light does not come on.**

Turn off the projector, check that the power cable is connected securely both at the power outlet and the projector, and press the POWER button again. Try removing and reseating the lamp.

- ▶ **Projected images get darker or start to deteriorate, or the projection lamp light is red.**

Replace the projector lamp as described in Chapter 5.

- ▶ **The temperature light is red.**

The projector is overheating, which turns the lamp off automatically. Let the projector cool for a few minutes, then turn it back on. Make sure nothing is blocking the ventilation vents.

The air filter may be clogged. Clean it as described in Chapter 5 and then let the projector cool for awhile.

If the projector continues to overheat after you clean the air filter, the problem may be caused by damage to the cooling fan or internal circuits. Contact a qualified service person.



Warning: Except as specifically explained in this User's Guide, do not attempt to service this product yourself.



Discount-Merchant.com (800) 281-8860

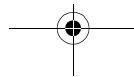
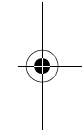
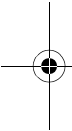

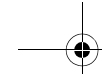

Problems with the Remote Control

- ▶ **The projector doesn't respond to remote control commands.**

The remote control unit's batteries may be low on power. Replace them.

Make sure the projector's mouse cable is securely connected to both your computer's mouse port and the projector's main cable. See Chapter 1 for details.

Make sure you selected the correct COM (communication) port for the wireless mouse control when you set up the ELP Link III software. If necessary, you can change the COM port from the projector's Options menu. See page 86 for more information.

Light that is too strong, or certain types of fluorescent lighting may affect the projector's infrared receivers. Dim the ambient lighting and turn off any fluorescent lighting. Move the projector out of direct sunlight.

Turn off any nearby equipment that emits infrared energy, such as a radiant room heater.

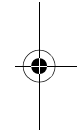
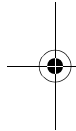

Discount-Merchant.com (800) 281-8860

THE TRUSTED SOURCE FOR PROJECTOR LAMPS AND ACCESSORIES

Problems with the Remote Control

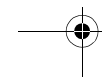
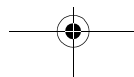

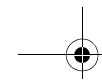

Problems with the Image or Sound

- ▶ **An image does not appear on the screen.**

Check that the Power light is on and the lens cover is off. Also make sure the cables are installed correctly, as described in Chapter 1.

The correct image source may not be selected. Press the SOURCE button on the remote control or the control panel to choose another image source.

- ▶ **Only part of the computer image is displayed.**

If the computer's output resolution setting is higher than 800×600 , the PowerLite 5300 resizes the image. If the computer's output resolution setting is higher than 1024×768 , the PowerLite 7200 or 7300 resizes the image. If the computer output is not compatible with this resizing, choose a different display setting on the computer. In Windows 3.x, use Windows Setup in the Main program group. In Windows 95/98, right-click on the desktop, select Properties, click the Settings tab, and use the dialog box to select the resolution you want. For a Macintosh, choose Control Panels under the Apple menu and then choose Monitors. In the Monitors screen, choose Options and make sure Macintosh Hi-Res Display or another 832×624 display (1024×768 for the PowerLite 7200 and PowerLite 7300) is selected. For supported display settings, see "Supported Monitor Displays" on page 137.

You also may need to modify existing presentation files if you created them for a different resolution. See your software manual for specific information.

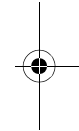
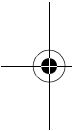

Discount-Merchant.com (800) 281-8860

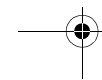
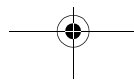



▶ **The message NO SIGNAL is displayed.**

An image source not connected to the projector is selected, the signal is not being output from the computer, or the signal is not reaching the projector. Make sure the connectors are securely attached to both the projector and the image source. Then check that the image source is selected correctly. If your projector is attached to a Macintosh, make sure that the DIP switches on your Macintosh desktop adapter are set correctly. (See your Macintosh documentation if you need instructions.) When NO SIGNAL is displayed, you cannot access the Video menu.

▶ **A blank screen is displayed.**

The computer signal cannot be interpreted by the projector. Verify the display format (see page 137). When you see a blank screen, you cannot access the projector menus.

▶ **The image or parts of the image are blurred or not in focus.**

Adjust the Brightness and Contrast settings on the Video menu. If you're viewing a computer image, also try adjusting the Tracking and Sync buttons on the projector's control panel.

There may be dirt or smears on the lens. Clean the lens as described on page 118.

▶ **The colors of the image are not right.**

The color balance may be incorrect. If you're displaying a computer image, use the Color option in the Video menu to adjust the balance of red, green, and blue. If you're displaying video, adjust the Color and Tint (NTSC only) settings on the Video menu.

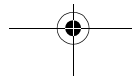
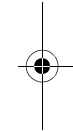
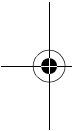



Check your monitor's color balance if you're displaying a computer image.

▶ **There is no sound.**

First check that the volume setting is not turned all the way down and that the audio/video cable is securely attached to both the projector and the audio source. Also, make sure that the Mute button is not enabled.

The wrong source is selected. Press the SOURCE button on the remote control or control panel to select the proper source.

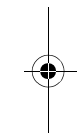
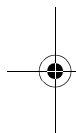

FixYourDLP.com

Sponsored by DM

Discount-Merchant.com (800) 281-8860

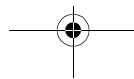

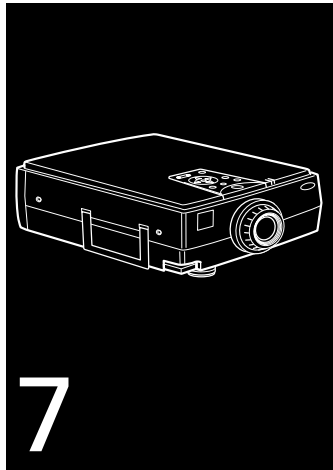

Technical Specifications

General	Type of display	Poly-silicon Thin Film Transistor (TFT) (PowerLite 5300 and 7300 models have a Micro Lens Array (MLA) built in)
	Size of liquid crystal panels	Diagonal: 1.3 inches (33.6 mm)
	Lens	F=2.0–2.3, f=55–72 mm
	Resolution	PowerLite 5300: SVGA, 800 × 600 pixels PowerLite 7200/7300: XGA, 1024 × 768 pixels
	Color reproduction	24 bit, 16.7 million colors
	Brightness	PowerLite 5300/7300: 1200 lumens (ANSI) PowerLite 7200: 1000 lumens (ANSI)



Discount-Merchant.com (800) 281-8860
THE TRUSTED SOURCE FOR PROJECTOR LAMPS AND ACCESSORIES



Image size	30 to 300 inches (at 3.9 to 40.6 feet distance), Wide angle 23 to 230 inches (at 5.1 to 54 feet distance), Tele angle
Projection distance	3.9 to 54.7 feet (1.2 to 16.7 meters)
Projection methods	Front, rear, upside-down (ceiling mount)
Internal speaker system	3 × 3 W stereo output 2 × 3 W 8 (ohm) speakers
Optical aspect ratio	4:3 (horizontal : vertical)
Zoom ratio	1:1.3
Tilt angle	0° to 12°
Supported video interface standards	NTSC, PAL, PAL-M, PAL-N, SECAM

Projection Lamp

Type	UHE (Ultra High Efficiency)
Power consumption	120 W
Lamp life	2000 hours at 50% brightness
Part number	ELPLP05

Remote Control

Range	32.8 feet (10 meters)
Batteries	Alkaline AA (2)



Discount-Merchant.com (800) 281-8860



Mouse Compatibility

Supports PS/2, serial, ADB

Repeater Interface

Supports Xantech® IR repeaters,
3.5 mm stereo mini-jack

Mechanical

Height	4.7 inches (120 mm)
Width	11.8 inches (300 mm)
Depth	14.3 inches (363 mm)
Weight	13.7 lb (6.2 kg)

Electrical

Rated frequency	50/60 Hz
Power supply	100 to 120 VAC, 2.4 A 200 to 240 VAC, 1.2 A
Power consumption	Operating: 200 W Standby: 8.4 W



Environmental Temperature

Operating: 41 to 104° F (5 to 40° C),
non-condensing

Storage: 14 to 140° F (-10 to 60° C),
non-condensing

Humidity

Operating: 20 to 80% RH,
non-condensing

Storage: 10 to 90% RH,
non-condensing

Safety

United States

FCC Part 15J Class B
UL1950 Rev. 3

Canada

DOC SOR/88-475
CSA C22.2 No. 950 Rev. 3

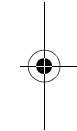
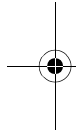

Discount-Merchant.com (800) 281-8860



Supported Monitor Displays

The following table lists the display formats supported by the projector:

Computer type	Formats	Resolutions
IBM PC and IBM PC compatible	EGA, VGA EGA	640 × 350
	VGA CGA	640 × 400
	VGA60, VESA	640 × 480
	VGA Text	720 × 350
	VGA Text	720 × 400
	SVGA	800 × 600
	XGA	1024 × 768
	SXGA	1152 × 864
	SXGA	1280 × 960
Apple Macintosh	Standard 8- and 24-bit color monitor	640 × 480
		832 × 624
		1024 × 768
		1152 × 870
TV	NTSC	640 × 480
	PAL, SECAM	768 × 576

Note: The frequencies of some computers may not allow the image to be displayed correctly.

Computer 1 and 2 and Computer Out connector pin assignments

The Computer 1, 2 and Computer Out connectors are female video RGB, 15-pin micro-D-style connectors. Here are the pin assignments:

Input pin	Computer Out connector signals	Computer 1 and 2 connector signals
1	Red out / red video	Red video
2	Green out / green video	Green video
3	Blue out / blue video	Blue video
4	Reserved	Monitor (ID bit 2)
5	GND	GND
6	GND	Red video GND
7	GND	Green video GND
8	GND	Blue video GND
9	Reserved	+5 V
10	GND	Synchronous GND
11	Reserved	Monitor (ID bit 0)
12	Reserved	SDA
13	Horizontal sync	Horizontal sync
14	Vertical sync	Vertical sync
15	Vertical sync	Reserved

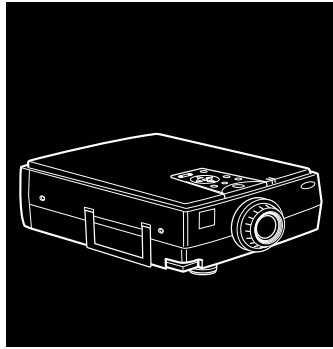

Glossary

Brightness. The balance of light and dark shades in an image.

Component video. The recording and transmission of video using separate red, green, blue and synchronization signals.

Composite video. A type of video signal that encodes picture, luminance, and synchronization information so it can be carried in one signal.

Contrast. A measure of the tonal differences between the highlights and shadows of an image. In a high-contrast image, light areas are very bright and dark areas are very dark, with relatively few levels of gray between white and black. Contrast is decreased by adding grays.

NTSC. A 525-line video broadcast format developed by the National Television Standards Committee. NTSC is widely used in North America, Mexico, and Japan.



Discount-Merchant.com (800) 281-8860
THE TRUSTED SOURCE FOR PROJECTOR LAMPS AND ACCESSORIES

PAL (Phase Alternation by Line). A 625-line video broadcast format used in Western Europe, India, China, Australia, New Zealand, and parts of Africa.

Point. A measurement of drawn or printed objects. One point equals 1/72 inch.

Resolution. A measure of the amount of detail contained in an image. Resolution can be measured in dots per inch or in pixels. Image sharpness and clarity improve as resolution increases.

RGB. A type of color scheme that defines color as percentages of red, green, and blue.

S-Video. A type of video signal used in S-VHS videotape formats. It transmits luminance and color separately.

SECAM (System Electronique pour Couleur Avec Memoire). A 625-line TV system used in France, Eastern Europe, Russia, and parts of Africa.

Sleep mode. A power-saving feature in which the projection lamp is turned off when the projector has not been used for 30 minutes. In sleep mode, only a minimum amount of the projector's circuitry remains on.

Super XGA. Super Extended Graphics Array. SXGA provides higher resolution than XGA.

VGA. Video Graphics Array. A high-resolution display adapter that provides a variety of video modes.

XGA. Extended Graphics Array. IBM's next generation display adapter, XGA provides higher resolution than VGA.



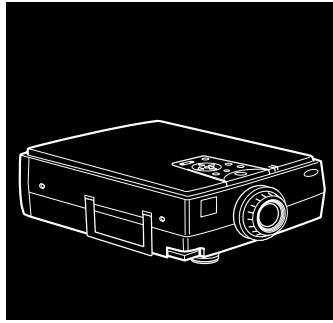

Index

Numerics

3D Sound, 84, 108

A

About menu, 90

Accessories, 4, 8

Air filter, cleaning, 119 to 120

Amplification, 53 to 54

Anti-theft device, 15

Audio

connecting desktop, 25, 39

connecting laptop, 30

connecting PowerBook, 48

menu, 75, 83 to 84

B

Bar function, 98, 101

Bass, 83, 108

Batteries, installing, 16 to 17

Blank

button, 68

menu option, 85

BNC Format, 87, 110

Brightness, 80, 82, 105, 106, 107, 133, 139

Buttons

control panel, 71, 78 to 80

customizing the Effects buttons, 96 to 102

remote control, 67 to 69, 78 to 80



C

- Cables, 4, 12 to 14
- Camcorder, adjusting the projected image, 82 to 83
- Case, cleaning, 118
- Ceiling, hanging the projector from, 85, 109
- Cleaning
 - air filter, 119 to 120
 - lens, 118
 - projector case, 118
- Color
 - adjusting screen whiteness, 85
 - balance, 82, 106
 - menu option, 81, 82
 - saturation, 82, 106, 107
- COM port, changing, 103
- CompuServe, 6
- Computer connector pin assignments, 138
- Computer, adjusting projected image for, 80 to 83
- Connecting projector
 - to a desktop Macintosh, 31 to 39
 - to a desktop PC, 19 to 25
 - to a high-end workstation, 49
 - to a laptop PC, 26 to 30
 - to a PA system, 53 to 54
 - to a PowerBook, 40 to 48
 - to a video source, 49 to 52
 - to an external speaker, 53 to 54

- Connector pin assignments, 138
- Contrast, 81, 82, 105, 106, 107, 139
- Control panel, 3
 - buttons, 71
 - functions, 71
 - using, 70 to 71
- Cursor, changing shape, 98, 102
- Custom
 - button, 69
 - menu, 87 to 89
- Customizing the Effects buttons, 96 to 102

D

- DIP switches, 33, 42
- Display formats, supported, 137
- Distance from projector to screen, 15 to 16, 58 to 62
- Download Service, EPSON, 6
- Drawing screen graphics, 97 to 99, 101

E

- Effects buttons
 - assigning functions, 99
 - customizing, 96 to 102
 - function options, 101 to 102
 - functions list, 97 to 98
 - saving and recalling assignments, 102
- Electrical specifications, 135
- Ellipse, 97, 101



ELP Link III software
installing, 92 to 94
launching, 94 to 96
using, 96 to 115
Environmental specifications, 135
EPSON support, 6 to 7
External speakers, 53 to 54

F

FaxAdvice, EPSON, 7
Features, 1 to 2
Feet, raising or lowering, 64
Focusing, 63 to 64
Formats, supported display, 137
Freeze button, 69
FTP site, EPSON, 6

G

Graphics, drawing screen, 97 to 98, 101

H

Help, EPSON, 6 to 7
High-end workstation, 49
Humidity requirements, 136

I

Image
adjusting position, 63 to 64, 80, 106
adjusting quality, 80 to 83

leaving a copy on the screen, 98
problems, 130 to 132
resizing, 65
size range, 134
Image Gamma, 112
Infrared receivers, location, 58
Installing batteries, 16 to 17
Installing the ELP Link III software, 92 to 94

Internet, 6

K

Key Macro function, 98, 102

L

Lamp
light, 72 to 73, 126 to 127
replacing, 120 to 123
specifications, 134
Language menu option, 86
Laptop, connecting to, 26 to 30, 40 to 48
Launching the ELP Link III software, 94 to 96
Lens, cleaning, 118
Lights, status, 72 to 74, 126 to 128
Line function, 97, 101
Logo, creating, 113 to 115
Long throw zoom lens, 62
Lumens, 133



Discount-Merchant.com (800) 281-8860
THE TRUSTED SOURCE FOR PROJECTOR LAMPS AND ACCESSORIES

M

Macintosh

- connecting projector to, 31 to 48
- installing software, 94

Mechanical specifications, 135

Menus

- accessing, 76 to 80
- Audio, 75, 83 to 84
- changing settings, 78 to 80
- Custom, 87 to 89
- Options, 75, 85 to 87
- Video, 75, 80 to 83

Mode, video signal, 82

Monitors, supported, 137

Mute button, 69, 71

O

Options for the projector, 4

Options menu, 75, 85 to 87

P

PA system, 53 to 54

Pin assignments, connector, 138

Pointer button, 68

Positioning the projector, 15 to 16, 58 to 62

Positioning the screen image, 63 to 64, 80, 106

Power

- button, 69 to 71

consumption, 135

light, 72 to 73, 126 to 128

supply, 135

PowerBook, connecting projector to, 40 to 48

Preview menu option, 88

Projection lamp light, 72 to 73, 126 to 127

Projector

changing ELP Link III settings, 105 to 110

connecting, 18 to 54

distance to screen, 15, 59 to 62

focusing, 63 to 64

hanging from the ceiling, 85, 109

lamp specifications, 134

parts identified, 58

positioning, 15 to 16, 58 to 62

positioning the screen image, 63 to 64, 80, 106

problems, 126 to 128

setting up, 11 to 54

status lights, 72 to 74, 126 to 128

turning on and off, 55 to 56

unpacking, 12 to 14

using the Quick Change Toolbar, 105

Projector case, cleaning, 118

Projector Control window, 105 to 110

Projector Setting window, 103 to 104

Prompt menu option, 85, 109



Q

Quick Change Toolbar, 105

R

Rear projection, 85, 109

Remote control

buttons, 67 to 69, 78 to 80

customizing the Effects buttons, 96 to 102

functions, 68 to 69

problems, 129

specifications, 134

using, 3, 67 to 69

Replacing the lamp, 120 to 123

Reset All menu, 90

Resize button, 65

Resolution, 133, 140

S

Safety instructions, 8 to 10

Saturation, 82, 107

Screen image, problems, 130 to 132

Screen, adjusting whiteness, 85

Sharpness, 82, 107

Sleep mode, 3, 65 to 66, 140

Software

installing, 92 to 94

launching, 94 to 96

using, 96 to 115

Sound problems, 132

Speakers

adjusting the tone, 83, 108

adjusting the volume, 83, 108

connecting projector to, 53 to 54

Specifications

electrical, 135

environmental, 135

general, 133 to 134

lamp, 134

mechanical, 135

remote control, 134

safety, 136

Square function, 98, 101

Stamp function, 98, 101

Status lights, 72 to 74, 126 to 128

Strobe menu option, 89, 110

Super XGA, 137, 140

Support, technical, 6 to 7

S-Video signal, 14, 140

Sync, 80, 106

T

Temperature

light, 74, 126 to 128

requirements, 136

Test pattern

changing, 111

displaying, 106



Discount-Merchant.com (800) 281-8860

THE TRUSTED SOURCE FOR PROJECTOR LAMPS AND ACCESSORIES

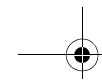

Tint, 82
Tone, adjusting, 83, 108
Toolbar, using, 105
Tracking, 80, 106
Treble, 83, 108
Troubleshooting
 image and sound problems, 130 to 132
 projector problems, 126 to 128
 remote control problems, 129
Turning the projector on and off, 55 to 56
TV, supported display formats, 137

U
Unpacking projector, 12 to 14
User logo, creating, 113 to 115

V
VCR, adjusting the projected image, 82 to 83
VGA, 137, 140

Video
 adjusting projected image for, 82
 jacks, 51
 menus, 75, 80 to 83
 signal mode, 82
Video source, connecting projector to, 49 to 52
Volume, 83, 105, 108

W
Warning lights, 72 to 74, 126 to 128
Workstations, connecting projector to, 49
World Wide Web, 6

X
XGA, 137, 140

Z
Zoom options, 87 to 88, 110
Zoom ratio, 134

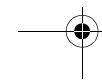
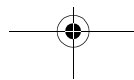
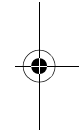
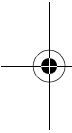



Disclaimer

This user manual is provided as a free service by FixYourDLP.com. FixYourDLP is in no way responsible for the content of this manual, nor do we guarantee its accuracy. FixYourDLP does not make any claim of copyright and all copyrights remain the property of their respective owners.

About FixYourDLP.com

FixYourDLP.com (<http://www.fixyourdlp.com>) is the World's #1 resource for media product news, reviews, do-it-yourself guides, and manuals.

Informational Blog: <http://www.fixyourdlp.com>

Video Guides: <http://www.fixyourdlp.com/guides>

User Forums: <http://www.fixyourdlp.com/forum>

FixYourDLP's Fight Against Counterfeit Lamps:

<http://www.fixyourdlp.com/counterfeits>

Sponsors:

RecycleYourLamp.org – Free lamp recycling services for used lamps:

<http://www.recycleyourlamp.org>

Lamp Research - The trusted 3rd party lamp research company:

<http://www.lampresearch.com>

Discount-Merchant.com – The worlds largest lamp distributor:

<http://www.discount-merchant.com>



FixYourDLP.com

Sponsored by 