



Disclaimer

This user manual is provided as a free service by FixYourDLP.com. FixYourDLP is in no way responsible for the content of this manual, nor do we guarantee its accuracy. FixYourDLP does not make any claim of copyright and all copyrights remain the property of their respective owners.

About FixYourDLP.com

FixYourDLP.com (<http://www.fixyourdpl.com>) is the World's #1 resource for media product news, reviews, do-it-yourself guides, and manuals.

Informational Blog: <http://www.fixyourdpl.com>

Video Guides: <http://www.fixyourdpl.com/guides>

User Forums: <http://www.fixyourdpl.com/forum>

FixYourDLP's Fight Against Counterfeit Lamps:

<http://www.fixyourdpl.com/counterfeits>

Sponsors:

RecycleYourLamp.org – Free lamp recycling services for used lamps:

<http://www.recycleyourlamp.org>

Lamp Research - The trusted 3rd party lamp research company:

<http://www.lampresearch.com>

Discount-Merchant.com – The worlds largest lamp distributor:

<http://www.discount-merchant.com>



FixYourDLP.com

Sponsored by 



LCD PROJECTOR

MODEL

XL8U

XL4U

SL4U

User Manual

ENGLISH

FRANÇAIS

DEUTSCH

ITALIANO

ESPAÑOL

中文

XL8
XL4
SL4



Discount-Merchant.com (800) 281-8860

THE TRUSTED SOURCE FOR PROJECTOR LAMPS AND ACCESSORIES

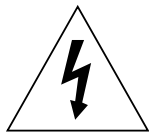
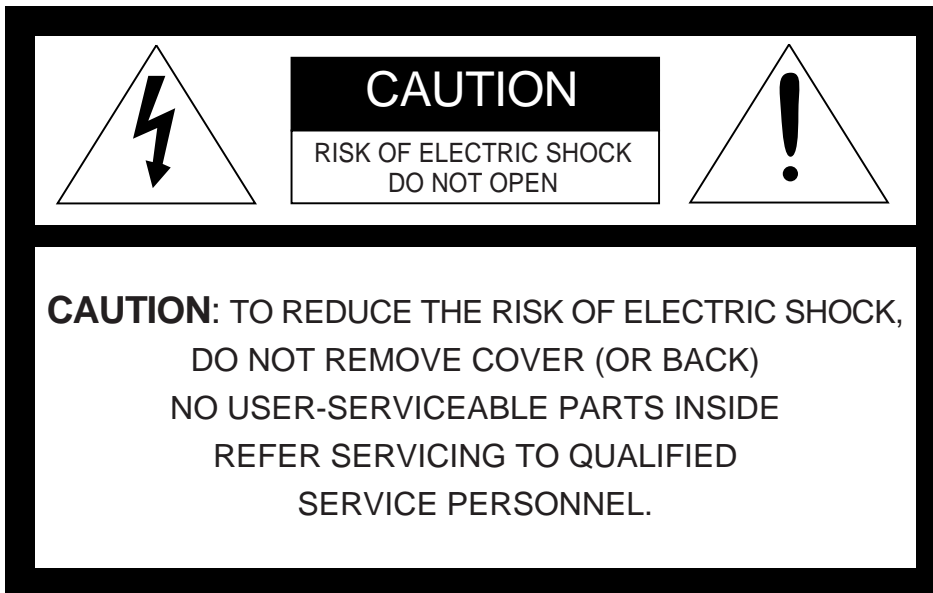

The lightning flash with arrowhead symbol within an equilateral triangle is intended to alert the user to the presence of uninsulated “dangerous voltage” within the product’s enclosure that may be of sufficient magnitude to constitute a risk of electric shock.



The exclamation point within an equilateral triangle is intended to alert the user to the presence of important operating and maintenance (servicing) instructions in the literature accompanying the appliance.

WARNING:

TO PREVENT FIRE OR SHOCK HAZARD, DO NOT EXPOSE THIS APPLIANCE TO RAIN OR MOISTURE.

CAUTION:

TO PREVENT ELECTRIC SHOCK, DO NOT USE THIS (POLARIZED) PLUG WITH AN EXTENSION CORD, RECEPTACLE OR OTHER OUTLET UNLESS THE BLADES CAN BE FULLY INSERTED TO PREVENT BLADE EXPOSURE.

NOTE:

SINCE THIS PROJECTOR IS PLUGGABLE EQUIPMENT, THE SOCKET-OUTLET SHALL BE INSTALLED NEAR THE EQUIPMENT AND SHALL BE EASILY ACCESSIBLE.

WARNING

Use the attached specified power supply cord. If you use another power-supply cord, it may cause interference with radio and television reception.

Use the attached RGB cable or RS-232C cable with this equipment so as to keep interference within the limit of a FCC Class B device.

apparatus must be grounded.

NOT LOOK DIRECTLY INTO THE LENS WHEN THE PROJECTOR IS IN THE POWER ON MODE.

CAUTION

Not for use in a computer room as defined in the Standard for the Protection of Electronic Computer/ Data Processing Equipment, ANSI/NFPA 75.

When using the projector in Europe:

COMPLIANCE NOTICE

This LCD Video Projector complies with the requirements of the EC Directive 89/336/EEC “EMC Directive” as amended by Directive 92/31/EEC and 93/68/EEC, and 73/23/EEC “Low Voltage Directive” as amended by Directive 93/68/EEC.

The electro-magnetic susceptibility has been chosen at a level that gains proper operation in residential areas, on business and light industrial premises and on small-scale enterprises, inside as well as outside of the buildings. All places of operation are characterised by their connection to the public low voltage power supply system.

WARNING

Use the attached RGB cable or RS-232C cable with this equipment so as to keep interference within the limits of an EN55022 Class B device. Please follow WARNING instructions.

Contents

Important safeguards	4
Overview	6
Remote control	8
Installation	9
Basic connections	10
Preparation	12
Basic operation	13
Menu operation	15
Image adjustment	18
Advanced features	20
Lamp replacement	24
Maintenance	25
Troubleshooting	26
Indicators	29
Specifications	30

Declaration of Conformity

Model Number : XL8U / XL4U / SL4U
Trade Name : MITSUBISHI ELECTRIC
Responsible party : Mitsubishi Digital Electronics America, Inc.
9351 Jeronimo Road, Irvine, CA 92618 U.S.A
Telephone number : +1-(949) 465-6000

This device complies with Part 15 of the FCC Rules. Operation is subject to the following two conditions:
(1) this device may not cause harmful interference, and
(2) this device must accept any interference received, including interference that may cause undesired operation.

Trademark, Registered trademark

Macintosh is registered trademark of Apple Computer Inc.

Other brand or product names are trademarks or registered trademarks of their respective holders.

Important safeguards

Please read all these instructions regarding your LCD projector and retain them for future reference. Follow all warnings and instructions marked on the LCD projector.

1. Read instructions
All the safety and operating instructions should be read before the appliance is operated.
2. Retain instructions
The safety and operating instructions should be retained for future reference.
3. Warnings
All warnings on the appliance and in the operating instructions should be adhered to.
4. Instructions
All operating instructions must be followed.
5. Cleaning
Unplug this projector from the wall outlet before cleaning it. Do not use liquid aerosol cleaners. Use a damp soft cloth for cleaning.
6. Attachments and equipment
Never add any attachments and/or equipment without the approval of the manufacturer as such additions may result in the risk of fire, electric shock or other personal injury.
7. Water and moisture
Do not use this projector near water or in contact with water.
8. Accessories
Do not place this projector on an unstable cart, stand, tripod, bracket or table. Use only with a cart, stand, tripod bracket, or table recommended by the manufacturer or sold with the projector. Any mounting of the appliance should follow the manufacturer's instructions and should use a mounting accessory recommended by the manufacturer.



An appliance and cart combination should be moved with care. Quick stops, excessive force and uneven surfaces may cause the appliance and cart combination to overturn.

3. Ventilation

Slots and openings in the cabinet are provided for ventilation, ensuring reliable operation of the projector and to protect it from overheating. Do not block these openings or allow them to be blocked by placing the projector on a bed, sofa, rug, or bookcase. Ensure that there is adequate ventilation and that the manufacturer's instructions have been adhered to.

10. Power sources
This projector should be operated only from the type of power source indicated on the marking label. If you are not sure of the type of power, please consult your appliance dealer or local power company.
11. Power-cord protection
Power-supply cords should be routed so that they are not likely to be walked on or pinched by items placed upon or against them. Pay particular attention to cords at plugs, convenience receptacles, and points where they exit from the appliance. Do not put the power cord under a carpet.
12. Overloading
Do not overload wall outlets and extension cords as this can result in a fire or electric shock.
13. Objects and liquids
Never push objects of any kind through openings of this projector as they may touch dangerous voltage points or short-out parts that could result in a fire or electric shock. Never spill liquid of any kind on the projector.
14. Servicing
Do not attempt to service this projector yourself. Refer all servicing to qualified service personnel.
15. Damage requiring service
Unplug this projector from the wall outlet and refer servicing to qualified service personnel under the following conditions:
 - (a) If the power-supply cord or plug is damaged.
 - (b) If liquid has been spilled, or objects have fallen into the projector.
 - (c) If the projector does not operate normally after you follow the operating instructions. Adjust only those controls that are covered by the operating instructions. An improper adjustment of other controls may result in damage and may often require extensive work by a qualified technician to restore the projector to its normal operation.
 - (d) If the projector has been exposed to rain or water.
 - (e) If the projector has been dropped or the cabinet has been damaged.
 - (f) If the projector exhibits a distinct change in performance - this indicates a need for service.
16. Replacement parts
When replacement parts are required, be sure that the service technician has used replacement parts specified by the manufacturer or parts having the same characteristics as the original part. Unauthorized substitutions may result in fire, electric shock or other hazards.
17. Safety check
Upon completion of any service or repair to this projector, ask the service technician to perform safety checks determining that the projector is in a safe operating condition.

WARNING:**Unplug immediately if there is something wrong with your projector.**

Do not operate if smoke, strange noise or odor comes out of your projector. It may cause fire or electric shock. In this case, unplug immediately and contact your dealer.

Never remove the cabinet.

This projector contains high voltage circuitry. An inadvertent contact may result in an electric shock. Except as specifically explained in User Manual, do not attempt to service this product by yourself. Please contact your dealer when you want to fix, adjust, or inspect the projector.

Do not modify the projector.

It can lead to fire or electric shock.

Do not keep using the damaged projector.

If the projector is dropped and the cabinet is damaged, unplug the projector and contact your dealer for inspection. It may lead to fire if you keep using the damaged projector.

Do not face the projection lens to the sun.

It can lead to fire.

Use correct voltage.

If you use incorrect voltage, it can lead to fire.

Do not place the projector on uneven surface.

Place the projector on a level and stable surface only.

Do not look into the lens when the projector is operating.

It may hurt your eyes. Never let children look into the lens when the projector is on.

Do not unplug the power cord during operation.

It can lead to lamp breakage, fire, electric shock or other trouble. Wait for the fan to stop before unplugging the power cord.

Do not touch the air outlet grilles and bottom plate.

Do not touch them or put other equipment close to the air outlet grilles because they become hot during operation. The heated air outlet grilles and bottom

plate may cause injury or damage to other equipment. Also, do not put the projector on a desk that is easily affected by heat.

Clean the air-filter once a month.

Clean the air-filter frequently. If the filter or ventilation slots become clogged with dirt or dust, the temperature inside of the projector may rise and cause some troubles, such as damage of inside parts, and shortening the life of the panels.

Do not look into the air outlet grilles when projector is operating.

Heat, dust, etc. may blow out of them and hurt your eyes.

Place of installation

For safety's sake, do not use the projector at any place subjected to high temperature and high humidity. Please maintain an operating temperature, humidity, and altitude as specified below.

- Operating temperature: between +41°F (+5°C) and +95°F (+35°C)
- Operating humidity: between 30% and 90%
- Never put any heat-producing device under the projector to prevent the projector from being overheated.
- Do not install the projector at a place that is unstable or subject to vibration.
- Do not install the projector near any equipment that produces a strong magnetic field. Also refrain from installing the projector near any cable carrying a large amount of current.
- Place the projector on a solid, vibration-free surface. Otherwise it may fall, causing serious injury or damage.
- Do not stand the projector on its end. It may fall, causing serious injury or damage.
- Slanting the projector more than ±10°(right and left) or ±30°(front and rear) may cause trouble or explosion of the lamp.
- Do not place the projector near air-conditioning unit or heater to avoid the air outlet and inlet grilles from being exposed to hot air.

COMPLIANCE NOTICE OF FCC

This equipment has been tested and found to comply with the limits for a Class B digital device, pursuant to Part 15 of the FCC Rules. These limits are designed to provide reasonable protection against harmful interference in a residential installation. This equipment generates, uses and can radiate radio frequency energy and, if not installed and used in accordance with the instructions, may cause harmful interference to radio communications. However, there is no guarantee that interference will not occur in a particular installation. If this equipment does cause harmful interference to radio or television reception, which can be determined by turning the equipment off and on, the user is encouraged to try to correct the interference by one or more of the following measures:

- Reorient or relocate the receiving antenna.
- Increase the separation between the equipment and receiver.
- Connect the equipment into an outlet on a circuit different from that to which the receiver is connected.
- Consult the dealer or an experienced Radio / TV technician for help.

Changes or modifications not expressly approved by Mitsubishi could void the user's authority to operate this equipment.

COMPLIANCE NOTICE OF INDUSTRY CANADA

This Class B digital apparatus complies with Canadian ICES-003.

Overview

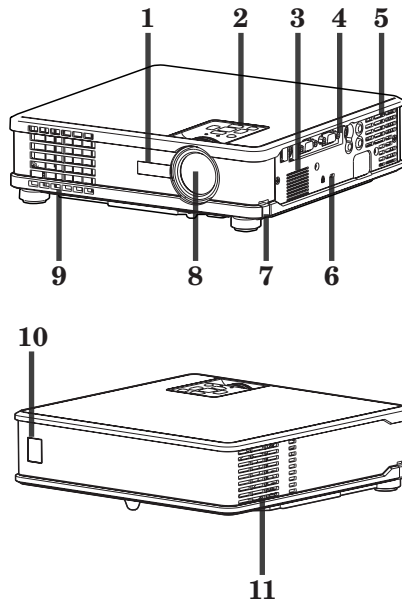

- 1 Remote control sensor (Front)
- 2 Control panel
- 3 Speaker
- 4 Terminal panel
- 5 Air outlet grille
- 6 Kensington Security Lock Standard connector
- 7 Foot adjustment button
- 8 Lens
- 9 Air outlet grille
- 10 Remote control sensor (Rear)
- 11 Air inlet grille

Control panel

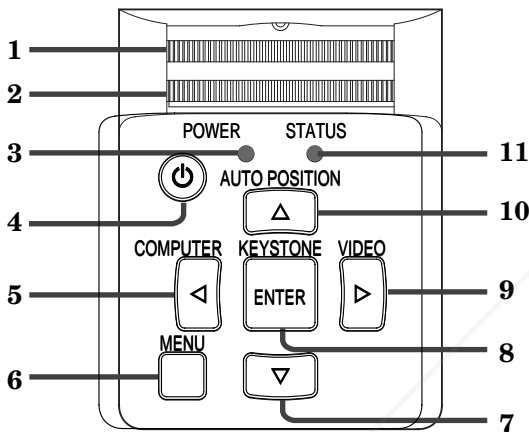

- 1 Focus ring
- 2 Zoom ring
- 3 POWER indicator
- 4 POWER button
- 5 COMPUTER / ◀ button
- 6 MENU button
- 7 ▼ button
- 8 KEYSTONE/ENTER button
- 9 VIDEO/▶ button
- 10 AUTO POSITION/▲ button
- 11 STATUS indicator

Important:

- While the menu or the screen for the keystone adjustment or password entry is being displayed or image capturing is being executed, the COMPUTER, VIDEO, and AUTO POSITION buttons function as the ◀, ▶, and ▲ buttons respectively.
- While the menu is on the screen, the KEYSTONE button functions as the ENTER button.

Terminal panel

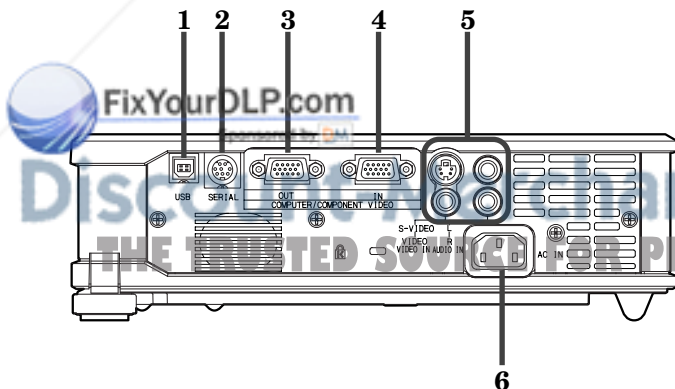

- 1 USB terminal
- 2 SERIAL terminal (8P)
- 3 COMPUTER / COMPONENT VIDEO OUT terminal (Mini D-SUB 15P)
- 4 COMPUTER / COMPONENT VIDEO IN terminal (Mini D-SUB 15P)
- 5 VIDEO and AUDIO terminals
- 6 Power jack

Bottom side

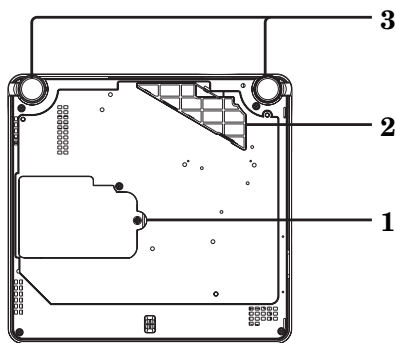

- 1 Lamp cover
- 2 Air inlet grille / Filter cover
- 3 Adjustment foot (Left/Right)

Caution:

Do not replace the lamp immediately after using the projector because the lamp would be extremely hot and it may cause burns.

Remote control

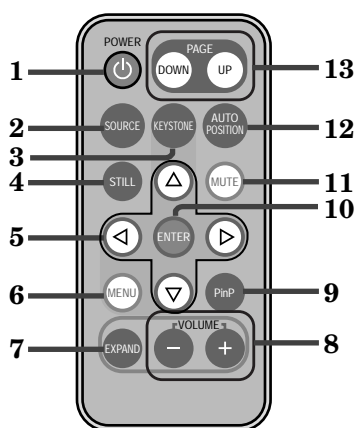

- 1 POWER button
- 2 SOURCE button
- 3 KEYSTONE button
- 4 STILL button
- 5 Direction buttons
- 6 MENU button
- 7 EXPAND button
- 8 VOLUME + and - buttons
- 9 PinP button (For XL8U only)
- 10 ENTER button
- 11 MUTE button (Audio/Video)
- 12 AUTO POSITION button
- 13 PAGE UP and DOWN buttons

Important:

The VOLUME + and - buttons are used for operation in the EXPAND mode as well as for volume control.

Remote control

Battery loading

First Loading:

When you use the remote control for the first time, pull out the insulation sheet.

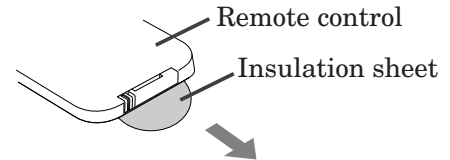

Replacement of the battery:

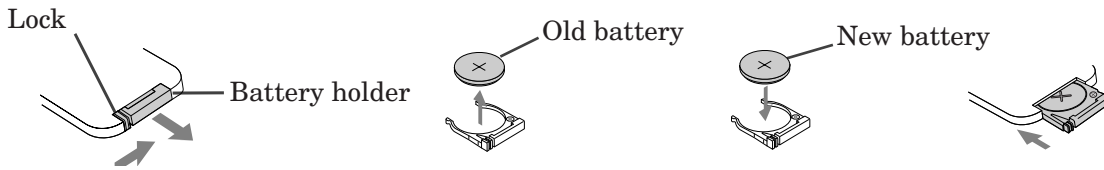

1. Turn the remote control upside down.
2. Push the lock inward and pull out the battery holder.
3. Remove the old battery.
4. Load a new battery with the positive (+) side up.
5. Push in and click the battery holder.

CAUTION

- Use of a battery of wrong type may cause explosion. Use MATSUSHITA battery, type CR2025 only.
- Dispose of used batteries according to the instructions. Batteries may explode if misused. Do not recharge, disassemble, or dispose of in fire.
- Be sure to handle the battery according to the instructions.
- Load the battery with its positive (+) and negative (-) sides correctly oriented as indicated on the remote control.
- Keep batteries out of reach of children and pets.
- Remove the battery, if the remote control is not used for a long time.

Operation range (of the remote control)

The maximum operation distance of the remote control is about 10 m (or about 32 feet) when the remote control is pointed at the remote control sensor of the projector. When the remote control is pointed to the screen, the distance from the remote control to the projector via the screen should be 6 m or less. However, the operation distance varies depending on the type of the screen used.

Reception angle (vertical)

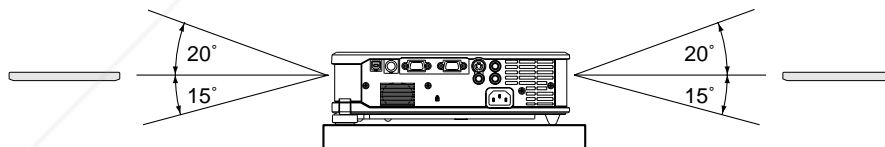

Reception angle (horizontal)

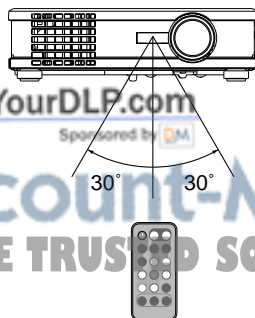

Reception angle (vertical), ceiling mount

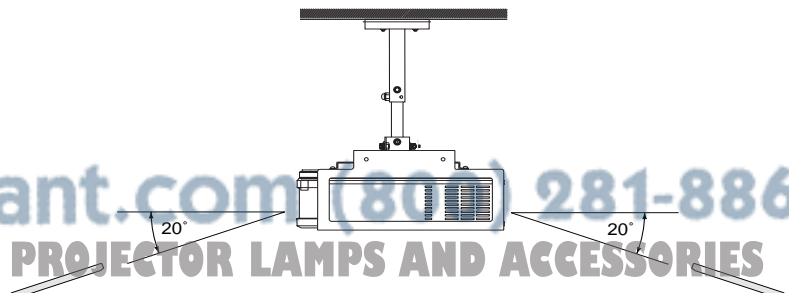

Important:

- Do not expose the remote control sensor to direct sunlight or fluorescent light. Keep a distance at least 2 m (6.5 feet) between the remote control sensor and the fluorescent light to ensure correct operation of the remote control. Inverted fluorescent light, if located near the projector, may interfere the remote control.
- When you use the remote control too close to the remote control sensor, the remote control may not work correctly.

Installation

Layout of the projector

Image size varies depending on the distance between the screen and the projector.

Front projection

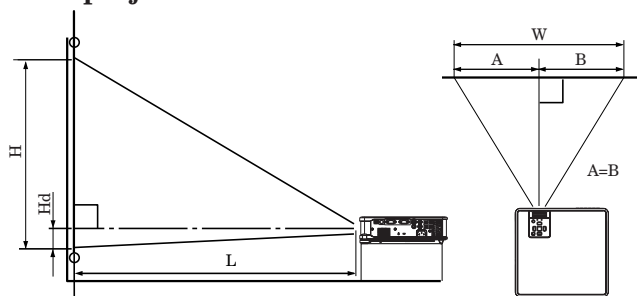

L : Between the screen and the front edge of the projector
Hd : Height of the projected image

Screen						Distance from the screen : L								Hd	
Diagonal size		Width : W		Height : H		Maximum zoom (WIDE)				Minimum zoom (TELE)					
inch	cm	inch	cm	inch	cm	XL8U		XL4U/SL4U		XL8U		XL4U/SL4U			
40	102	32	81	24	61	57	1.5	49	1.3	69	1.8	60	1.5	2.4	6.1
60	152	48	122	36	91	87	2.2	75	1.9	105	2.7	91	2.3	3.6	9.1
80	203	64	163	48	122	117	3.0	101	2.6	140	3.6	121	3.1	4.8	12.2
100	254	80	203	60	152	147	3.7	126	3.2	176	4.5	152	3.9	6.0	15.2
150	381	120	305	90	229	221	5.6	191	4.8	265	6.7	229	5.8	9.0	22.9
200	508	160	406	120	305	295	7.5	255	6.5	355	9.0	306	7.8	12.0	30.5
250	635	200	508	150	381	370	9.4	319	8.1	444	11.3	383	9.7	15.0	38.1
300	762	240	610	180	457	444	11.3	383	9.7	-	-	-	-	18.0	45.7

- The above figures are approximate and may be slightly different from the actual measurements.

Front projection, ceiling mounting

For ceiling mounting, you need the ceiling mount kit designed for this projector. Ask a specialist for installation. For details, consult your dealer.

- The warranty on this projector does not cover any damage caused by use of any non-recommended ceiling mount kit or installation of the ceiling mount kit in an improper location.

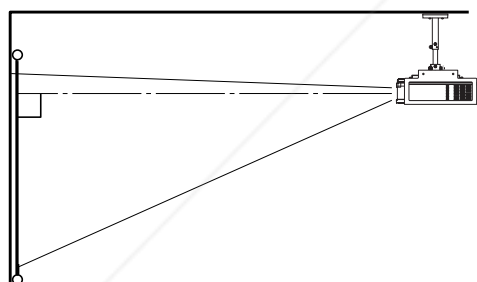

- When using the projector mounted on the ceiling, set IMAGE REVERSE in the INSTALLATION menu to MIRROR INVERT. See page 16.
- When the projector is mounted on the ceiling, images may appear darker than those projected in the case of tabletop mounting. This isn't a product malfunction.

Caution:

- Placing the projector directly on a carpet impairs ventilation by the fans, causing damage or failure. Put a hard board under the projector to facilitate ventilation.
- Place the projector at least 50 cm (or 20 inch) away from the wall to prevent the air inlet grille and the air outlet grilles that emit hot air from being blocked.
- Do not use the projector in the following locations and manners, which may cause fire or electric shock.
 - In a dusty or humid place.
 - In a sideways or upside-down position.
 - Near a heater.
 - In an oily, smoky, or damp place such as a kitchen.
 - In direct sunlight.
 - Where the temperature rises high, such as in a closed car.
 - Where the temperature is lower than 41°F (or +5°C) or higher than 95°F (or 35°C).

Important:

- Do not apply force to the lens, because the lens may be damaged.

Rear projection

Ask a specialist for installation. For details, consult your dealer.

- For rear projection, set IMAGE REVERSE in the INSTALLATION menu to MIRROR. See page 16.

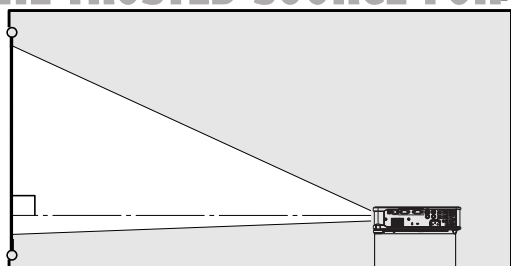

Basic connections

This projector can be connected with various devices such as a VCR, video camera, videodisc player, and personal computer that have analog RGB output connectors.

Important:

- Make sure that the connected device is turned off before starting connection.
- Plug in the power cords of the projector and the connected devices firmly. When unplugging, hold and pull the plug. Do not pull the cord.
- When the projector and the connected devices are located too close to each other, the projected image may be affected by their interference.
- See the owner's guide of each device for details about its connections.

Projector + AV device

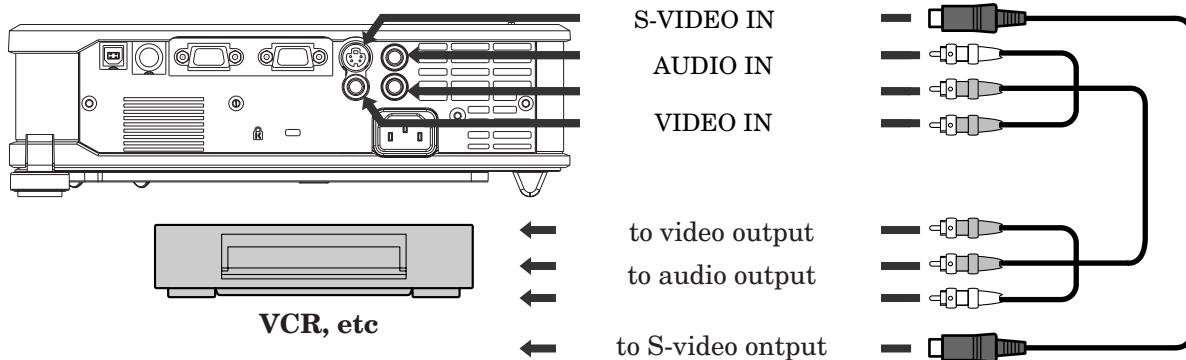

Important:

- Match the colors of the video and audio plugs on the AV cable with those of the terminals.
- Speaker output is mono.
- Set AUDIO MODE in the FEATURE menu to VIDEO to hear the audio only when the input source is VIDEO. (See page 17.)

Projector + DVD player or HDTV decoder

Some DVD players have an output connector for 3-line fitting (Y, C_B, C_R). When connecting such DVD player with this projector, use the COMPUTER/COMPONENT VIDEO IN terminal.

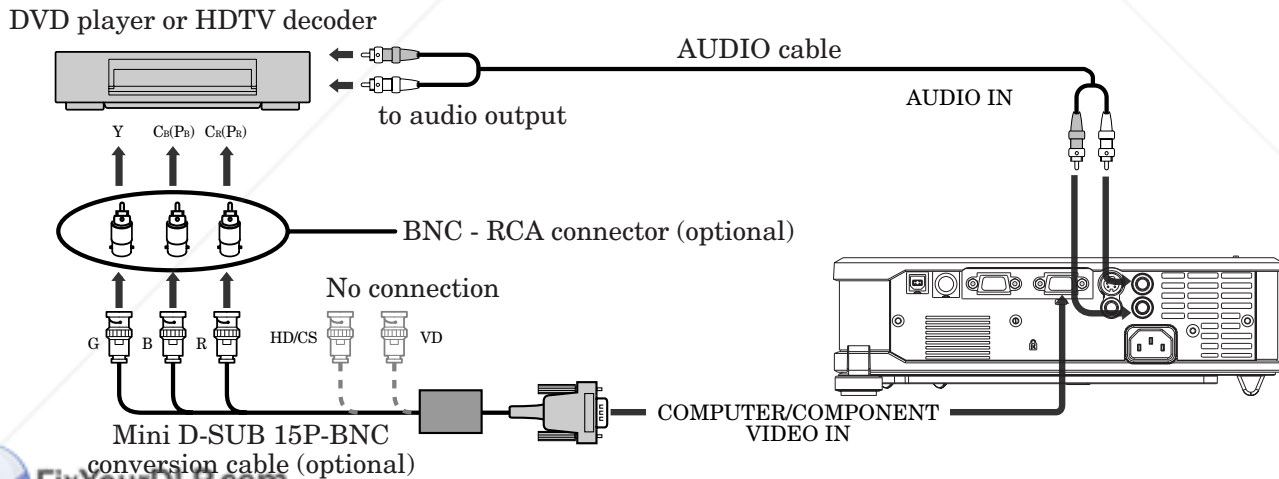

Important:

- The terminals' names Y, P_B, and P_R are given as examples of when a HDTV decoder is connected.
- The terminals' names vary depending on the connected devices.
- Use a Mini D-SUB 15P-BNC conversion cable for connection.
- Image may not be projected correctly with some DVD players.
- When connecting a HDTV decoder having RGB output terminals, set COMPUTER INPUT to RGB in the SIGNAL menu.
- Speaker output is mono.

Projector + Computer

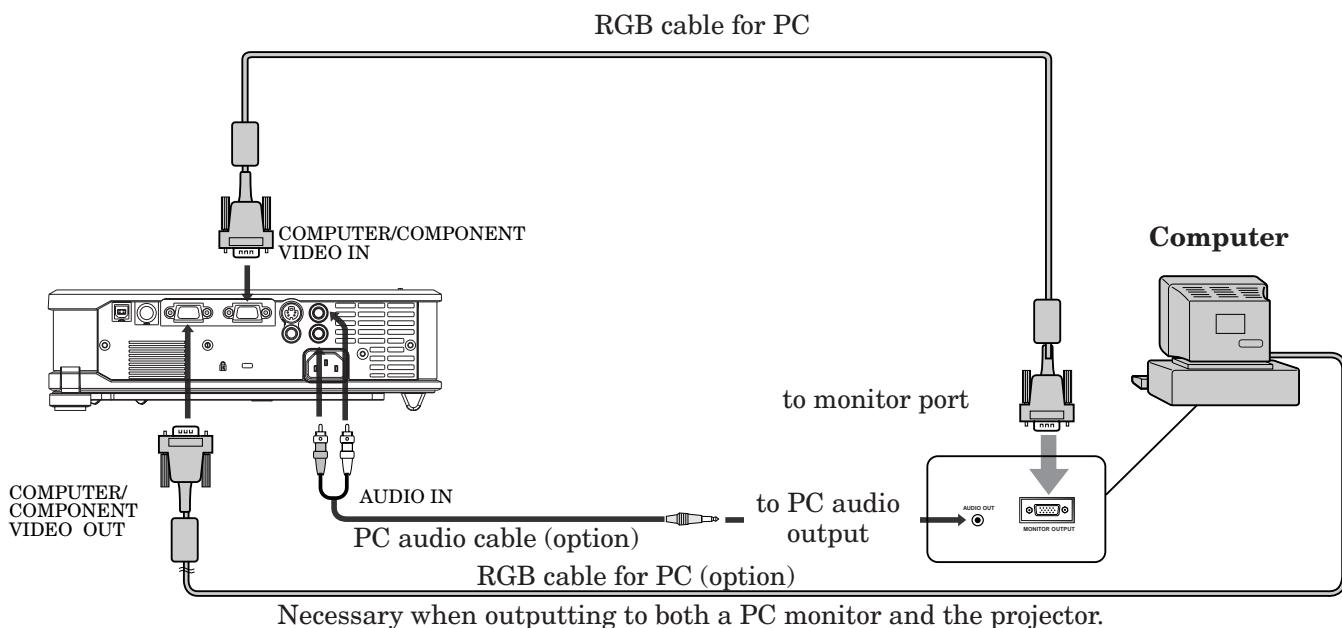

Important:

- When you use a longer RGB cable instead of the provided cable, the image quality may deteriorate.
- Some computers require additional connectors or analog RGB output adapters to be connected with this projector. Contact your dealer for further information.
- This projector uses RCA jacks for its audio input. Check the type of the audio output terminal of the connected computer and prepare a proper cable for connection. Some computers don't have the audio output terminal.
- Speaker output is mono.
- Set AUDIO MODE in the FEATURE menu to COMPUTER to hear the audio only when the input source is COMPUTER. (See page 17.)

For Macintosh

- If your Macintosh has no video port, a monitor output adapter is required. Contact your dealer for further information.
- Some Macintoshes require a MAC adapter for the RGB cable for connection with this projector. Contact your dealer for further information.

About DDC™

The COMPUTER/COMPONENT VIDEO IN terminal of this projector complies with the DDC1/2B standard. When a computer supporting this standard is connected to this terminal, the computer will automatically load the information from this projector and prepare for output of appropriate images.

- After connecting a computer supporting this standard to this terminal, plug the power cord of the projector in the wall outlet first, and then boot up the computer.
- You may need to install the DDC driver, depending on the computer you use. In this case, you need to download the driver from our Web site. Contact your dealer or Mitsubishi sales office for further information.



Discount-Merchant.com (800) 281-8860
THE TRUSTED SOURCE FOR PROJECTOR LAMPS AND ACCESSORIES

Preparation

Preparation for projection

1. Attach the provided power cord to the projector.
2. Plug the power cord in the wall outlet.
3. Remove the lens cap.

Warning:

- Do not look into the lens directly when the projector is on.
- The lens cap is for protecting the lens. If you leave the lens cap on the lens with the projector turned on, it may be deformed because of heat build-up. Remove the lens cap when you turn on the projector.
- The power cords for use in the U.S. and Europe are provided with this projector. Use the appropriate cord for your country.
- This projector uses the power plug of three-pin grounding type. Do not remove the grounding pin from the power plug. If the power plug doesn't fit your wall outlet, ask an electrician to change the wall outlet.
- The provided power cord for the U.S. is rated at 120 V. Never connect this cord to any outlet or power supply using other voltages or frequencies than rated. If you want to use a power supply using other voltage than rated, prepare an appropriate power cord separately.
- Use 100-240 V AC 50/60 Hz to prevent fire or electric shock.
- Do not place any objects on the power cord or do not place the projector near heat sources to prevent damage to the power cord. If the power cord should be damaged, contact your dealer for replacement because it may cause fire or electric shock.
- Do not modify or alter the power cord. If the power cord is modified or altered, it may cause fire or electric shock.

Caution:

- Plug in the power cord firmly. When unplugging, hold and pull the power plug, not the power cord.
- Do not plug in or out the power cord with your hand wet. It may cause electric shock.

Adjustment of the projection angle

For the best projection, project images on a flat screen installed at 90 degrees to the floor. If necessary, tilt the projector using the two adjustment feet on the bottom of the projector.

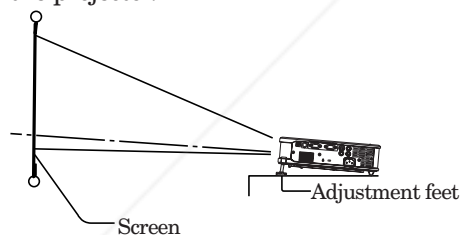

1. Tilt up the project to the appropriate angle.
2. Press the foot adjustment buttons next to the adjustment feet, and the adjustment feet will come out.
3. Release the buttons to lock the adjustment feet to that position.
4. Rotate the adjustment feet for fine adjustment.

After using the projector:

5. Put the adjustment feet back into the projector by pressing the foot adjustment buttons.

Important:

- Install the screen on a flat wall at 90 degrees to the floor.
- Slanting the projector more than $\pm 10^\circ$ (horizontally) or $\pm 30^\circ$ (vertically) may cause trouble or explosion of the lamp. You can tilt the projector up to 7 degrees using the adjustment feet only.

- Images may not be projected in a shape of a regular rectangle or with its aspect ratio 4:3, depending on the installation conditions of the projector and the screen.

For XL8U only

- This projector automatically corrects vertical keystone distortion. For fine adjustment, press the KEYSTONE button on the projector or the remote control to display KEYSTONE, and adjust the image by pressing the \blacktriangleright , \blacktriangleleft , \blacktriangleup , or \blacktriangledown button (or VOLUME + or - button on the remote control).

In the following cases:

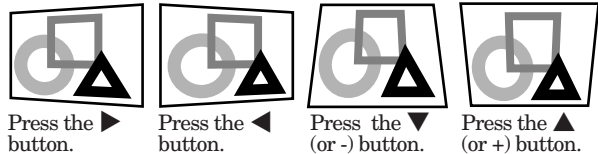

- The automatic keystone adjustment may not be carried out correctly because of the installation conditions of the projector and the screen. In such cases, correct the keystone manually.
- When the projector is projecting images where acceleration is present, such as in a vehicle and aircraft, the automatic keystone adjustment may not function correctly. In such cases, set AUTO KEYSTONE in the INSTALLATION menu to OFF and correct the keystone manually.
- You can correct the vertical and horizontal keystones at the same time. However, their adjustment ranges are limited in such correction.

For XL4U/SL4U only

- To correct vertical keystone distortion, press the KEYSTONE button on the projector or the remote control to display KEYSTONE, and adjust the image by pressing the \blacktriangledown , \blacktriangleup button (or VOLUME +, - button on the remote control).

In the following cases:

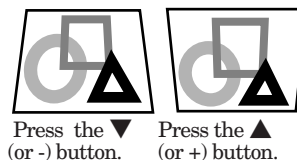

Important:

- When the keystone adjustment is carried out, the adjustment value is indicated. Note that this value doesn't mean a projection angle.
- The allowable range of the adjustment value in the keystone adjustment varies depending on the installation conditions.
- When the keystone adjustment takes effect, the resolution decreases. In addition, stripes may appear or straight lines may bend in images with complicated patterns. They are not due to product malfunctions.
- Noise may appear on the screen during the keystone adjustment because of the type of the video signal being projected and the setting values of the keystone adjustment. In such cases, set the keystone adjustment values in the range where the image is displayed without noise.
- When the keystone adjustment is carried out, the image may not be displayed correctly because of the type of input signal.
- When the 1080i signal is input, the keystone adjustment ranges are limited.

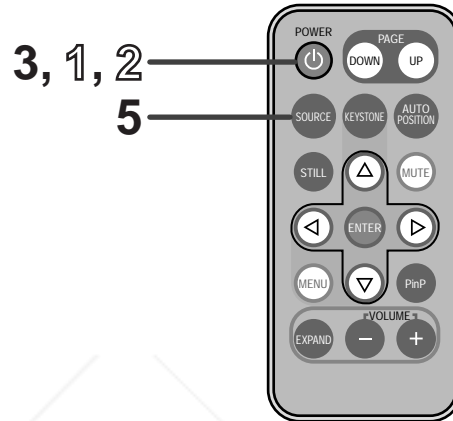
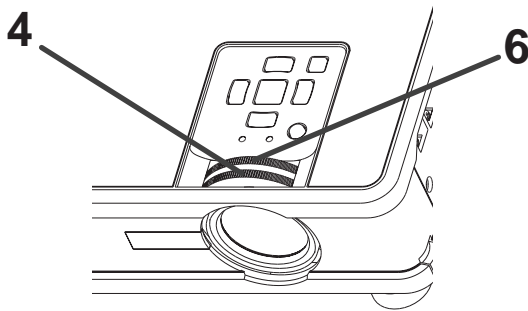
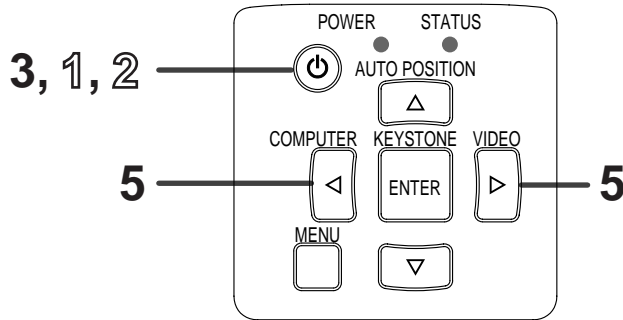

Power-on

1. Turn on the device connected to the projector first.
2. Plug the power cord in the wall outlet.
 - The POWER indicator lights up.
 - If the power cord is unplugged from the wall outlet before the projector is cooled down completely after use, the fans may start rotating when the power cord is plugged in next time and the POWER button may not function. In this case, wait for the fans to stop and press the POWER button to light the indicator.

3. Press the POWER button.
 - It may take about one minute for the lamp to light up.
 - The lamp occasionally fails to light up. Wait a few minutes and try to light the lamp again.
 - After the POWER button is pressed or the lamp mode is switched, the image may flicker before the lamp becomes stable. This is not a product malfunction.

The STANDARD lamp mode is activated by default whenever the projector is turned on. When the LOW lamp mode has been chosen, the default STANDARD lamp mode is switched to the LOW lamp mode in 1.5 minutes.

Condition	Indicator	STATUS	POWER
Stand-by		-	Red
When the lamp is on.		Green	Green
When the lamp is off temporarily.		-	Red

Important:

- The projector starts warming up when the POWER button is pressed. During the warm-up process, images may appear dark and no commands are accepted.
 - By blinking red, the STATUS indicator indicates that the lamp should be replaced soon. Replace the lamp when the STATUS indicator blinks red. (See page 26 and 29.)
 - Images may not be projected with good quality in an extremely hot or cold environment. (This is not a product malfunction.)
4. Adjust the focus by turning the focus ring.
 5. Choose your desired external input source using the SOURCE button on the remote control or the COMPUTER or VIDEO button on the control panel.
 - The input source is switched between VIDEO, S-VIDEO and COMPUTER at every press of the SOURCE button on the remote control.
 - The input source is switched between VIDEO and S-VIDEO at every press of the VIDEO button on the control panel.
 - The projector automatically selects the appropriate signal format. The selected signal format is displayed on the screen.
 - The COMPUTER, VIDEO, and SOURCE buttons don't function while the menu is being displayed.
 - Images supplied from the computer may flicker. Press the ◀ or ▶ button on the remote control to reduce flicker, if it occurs.
 6. Adjust the image size by turning the zoom ring.
 - If necessary, adjust the focus and zoom again.

Basic operation (continued)

Power-off

Use the following procedure to turn off the projector. Do not turn off the projector by unplugging the power cord while the lamp is on. Unplugging while the lamp is on degrades the lamp's performance and causes failure in the projector.

1. Press the POWER button.
 - The message "POWER OFF? YES : PRESS AGAIN" appears on the screen.
 - To cancel, press any button except the POWER button. (Some buttons on the remote control don't function for cancel.)
2. Press the POWER button within 10 seconds again.
 - The lamp will go out and the STATUS indicator will start blinking.
 - Though the lamp goes out at this second press of the POWER button, the air outlet fans continue operating for one minute to cool down the lamp and LCD panels. The STATUS indicator will stop blinking.
3. Unplug the power cord.
 - The POWER indicator will go out.
 - If the power cord should be unplugged accidentally while either the air inlet fan or the air outlet fans are operating or the lamp is on, allow the projector to cool down for 10 minutes with the power off. To light the lamp again, press the POWER button. If the lamp doesn't light up immediately, repeat pressing the POWER button two or three times. If it should still fail to light up, replace the lamp.

Important:

- When storing the projector in the provided carrying case, the lens should face up.

AUTO POSITION button

When the image isn't projected in the right position with COMPUTER selected as the input source, follow the procedure below.

1. Project a bright image such as the "Recycle Bin" window on the full screen.
2. If the screen saver is running, turn it off.
3. Press the AUTO POSITION button.
 - If the image is still not in the right position, adjust the image position using the SIGNAL menu.

Volume from the speaker

Press the VOLUME + or – button to change the volume from the speaker.

The volume control bar will appear on the screen.



- The volume control bar will disappear about 10 seconds after the VOLUME button is released.
- The VOLUME buttons don't function while the menu selection bar or the menu is being displayed.
- When a high-level audio signal, such as a DVD audio signal, is supplied to the AUDIO IN terminal, the output from the speaker may be distorted.

AV mute

The video and audio signals are temporarily muted when the MUTE button is pressed. To cancel muting, press the MUTE button again.

- If MUTE MODE in the INSTALLATION menu is set to IMAGE, the splash screen will appear when the MUTE button is pressed.
- You can alter the splash screen optionally. See page 21.
- When muting starts, the lamp mode becomes LOW, darkening the display of IMAGE. This is not a product malfunction.

Caution:

- After using the projector, wait one minute for the air outlet fans to stop. Then unplug the power cord from the wall outlet.
- The lamp can't be lit again for one minute after turned off for safety purpose. It will take another one minute for the STATUS indicator to go out. If you want to turn on the projector again, wait until the indicator goes out, and then press the POWER button.
- The air outlet fans rotate faster as the temperature around the projector rises.
- When the temperature around the projector rises high, the sign "TEMPERATURE!!" blinks red on the screen. If the temperature stays high, the lamp will go out automatically.

Menu operation

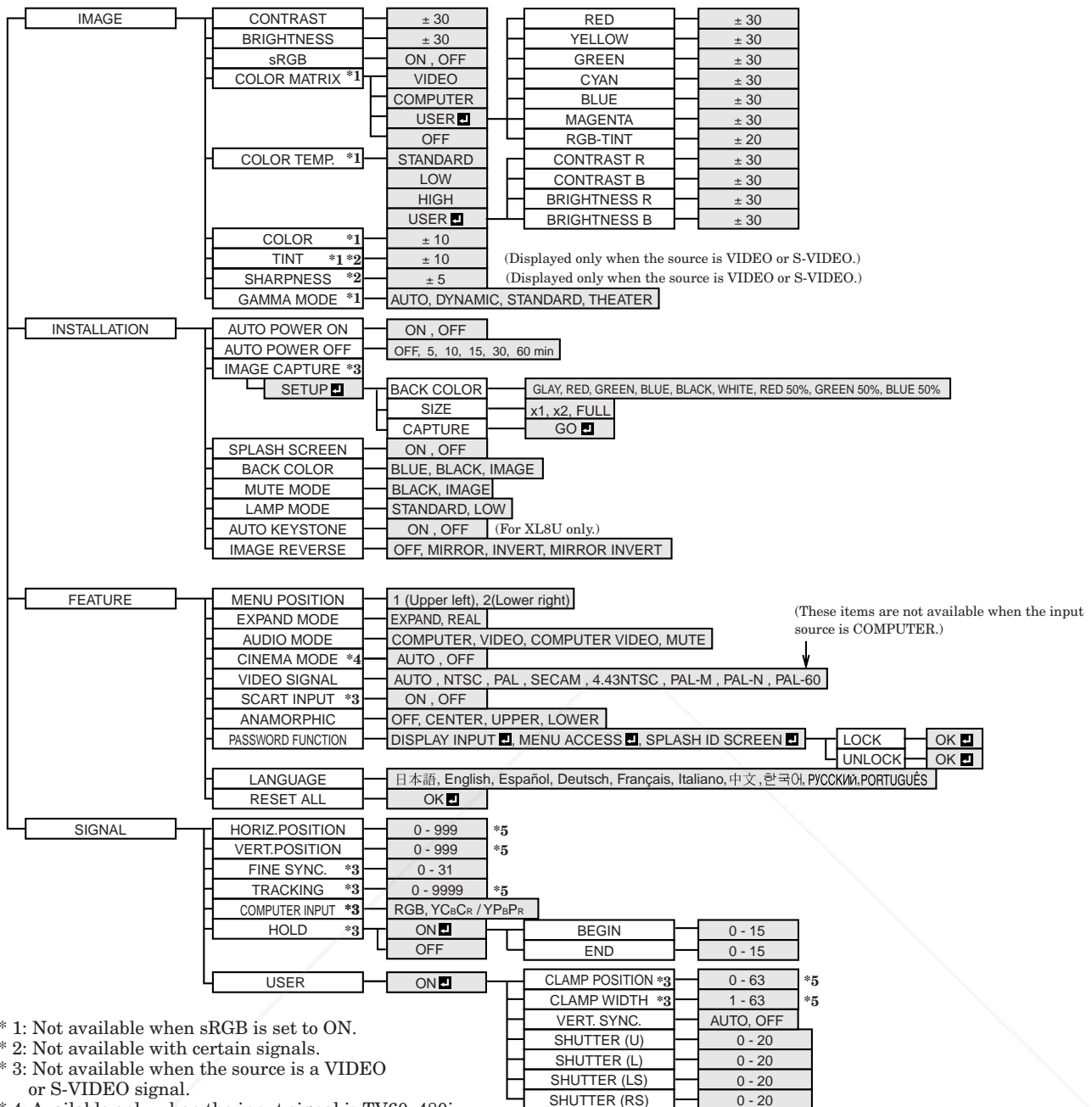

- * 1: Not available when sRGB is set to ON.
- * 2: Not available with certain signals.
- * 3: Not available when the source is a VIDEO or S-VIDEO signal.
- * 4: Available only when the input signal is TV60, 480i.
- * 5: Setting range differs depending on the input signals.

Basic operation

Several settings can be adjusted using the menu.

Example : Auto power off time setting

1. Press the MENU button.



2. Press the ◀ or ▶ button to select INSTALLATION.



3. Press the ENTER button (or ▼ button).

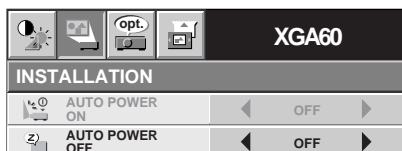

4. Press the ▲ or ▼ button to select AUTO POWER OFF.

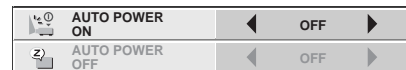

5. Press the ◀ or ▶ button to adjust the auto power off time.



6. Exit the menu by pressing the MENU button several times.

Important:

- When the MENU button doesn't function, unplug the power cord from the wall outlet. Wait about 10 minutes, plug the power cord in, and try again.
- After selecting the items marked with , press the ENTER button.

Menu operation (continued)

① IMAGE

CONTRAST Use to adjust the image contrast. The contrast becomes higher as the value increases.

BRIGHTNESS Use to adjust the image brightness. The image becomes brighter as the value increases.

sRGB Choose ON for projection emphasizing on the color reproducibility.

- When sRGB is ON, COLOR MATRIX, COLOR TEMP., COLOR, TINT, and GAMMA MODE can't be adjusted.

COLOR MATRIX . Use to adjust the color balance in each color of the image. See page 18.

COLOR TEMP. Use to adjust the color temperature. See page 18.

COLOR Use to adjust the color intensity of the image.

TINT Use to adjust the color balance of the image. The color balance shifts to green as the value increases and shifts to purple as the value decreases. (Available only when VIDEO is chosen as the source.)

- When the TV50 (PAL, SECAM) signal is input, TINT can't be adjusted.

SHARPNESS Use to adjust the image sharpness. The image becomes sharp as the value increases. (Available only when VIDEO is chosen as the source.)

GAMMA MODE ... When AUTO is selected, the appropriate gamma mode is automatically selected depending on the input signal. For normal use, select AUTO. Select DYNAMIC for computer sources. Select STANDARD for sport scenes and video sources. Select THEATER for film sources.

XGA60		
IMAGE		
CONTRAST	◀ 0 ▶	
BRIGHTNESS	◀ 0 ▶	
sRGB	◀ OFF ▶	
COLOR MATRIX	◀ COMPUTER ▶	
COLOR TEMP.	◀ STANDARD ▶	
COLOR	◀ 0 ▶	
TINT	◀ 0 ▶	
SHARPNESS	◀ 0 ▶	
GAMMA MODE	◀ AUTO ▶	

② INSTALLATION

AUTO POWER ON When ON is chosen, the lamp is automatically lit when the power cord is plugged in the wall outlet. Choose ON when using the projector mounted on the ceiling.

- The projector is in the stand-by mode when the lamp is off. Use the remote control to turn on the lamp.

AUTO POWER OFF Use to set the time elapsed before the projector enters the stand-by mode when there is no signal input from the source.

IMAGE CAPTURE Use to capture the screen for the splash screen. See page 21.

SPLASH SCREEN Choose ON to display the splash screen when the power is turned on.

- The splash screen can be changed. See page 21.

BACK COLOR..... Use to select the background from among BLUE, BLACK and IMAGE, which will be displayed when there is no signal input from the source. When IMAGE is selected, the splash screen will be displayed.

MUTE MODE Use to choose the background, either BLACK, or IMAGE, which will be displayed when the MUTE button is pressed. When IMAGE is chosen, the splash screen will be displayed.

LAMP MODE Use to change the brightness of the lamp. When LOW is chosen, the lamp brightness is kept low and the volume of the operation sound is reduced, resulting in a longer lamp replacement interval.

- The STANDARD lamp mode is activated by default whenever the projector is turned on. When the LOW lamp mode has been chosen, the default STANDARD lamp mode is switched to the LOW lamp mode in 1.5 minutes.
- When the lamp mode is switched, the projected image may flicker. This is not a product malfunction.

AUTO KEYSTONE Choose ON to adjust the vertical keystone distortion automatically. (For XL8U only.)

IMAGE REVERSE .. Use to reverse the projected image. Select MIRROR for rear projection with the tabletop-mounted projector. Select MIRROR INVERT for front projection with the ceiling-mounted projector.

XGA60		
INSTALLATION		
AUTO POWER ON	◀ OFF ▶	
AUTO POWER OFF	◀ OFF ▶	
IMAGE CAPTURE	◀ SETUP ▶	
SPLASH SCREEN	◀ ON ▶	
BACK COLOR	◀ BLUE ▶	
MUTE MODE	◀ BLACK ▶	
LAMP MODE	◀ STANDARD ▶	
AUTO KEYSTONE	◀ ON ▶	
IMAGE REVERSE	◀ OFF ▶	

- When you continue projection for a long time with BACK COLOR or MUTE MODE set to IMAGE, an after-image may persist on the screen.

- Do not change the setting of LAMP MODE frequently.

You can't set IMAGE CAPTURE or SPLASH SCREEN when PASSWORD FUNCTION in the FEATURE menu has been set to SPLASH ID SCREEN to enable the password lock.

③ **FEATURE**

- MENU POSITION** ... Use to select the position of the menu on the screen, 1. (upper left) or 2. (lower right).
- EXPAND MODE** .. Choose the mode for enlarging the image. See page 20.
- AUDIO MODE** Select **COMPUTER** to output the audio that is input to the **AUDIO IN** terminal when **COMPUTER** is chosen as the source. Select **VIDEO** to output the audio that is input to that terminal when **VIDEO** is chosen as the source. Select **COMPUTER VIDEO** mode to always output the audio that is input to that terminal. Select **MUTE** not to output the audio at all.
- CINEMA MODE** .. When **AUTO** is selected, the film mode will be automatically activated when a film source signal is inputted. When **OFF** is selected, the film mode will not be activated.
- VIDEO SIGNAL** ... When **AUTO** is selected, the appropriate video format is automatically selected depending on the input signal. If the image isn't displayed correctly, select the desired video format manually.
- SCART INPUT** Choose **ON** when connecting the projector with a device equipped with the **SCART** terminal that can output **RGB** signal. **SCART** terminal is used mainly in Europe. Choose **OFF** normally.
- ANAMORPHIC** Select the desired position from among **UPPER**, **CENTER**, and **LOWER** when playing DVD discs containing data of letterboxed images.
- PASSWORD FUNCTION** . Use to change the mode of the password lock or to enable or cancel the password lock. See page 23 for details.
- LANGUAGE** Use to select the language used in the menu. (日本語 / English / Español / Deutsch / Français / Italiano / 中文 / 한국어 / РУССКИЙ / PORTUGUÊS)
- RESET ALL** Use to reset the menu settings (except **IMAGE CAPTURE**, **PASSWORD**, and **LANGUAGE**).

XGA60	
FEATURE	
	MENU POSITION ◀ 1. ▶
	EXPAND MODE ◀ EXPAND ▶
	AUDIO MODE ◀ COMPUTER VIDEO ▶
	CINEMA MODE ◀ AUTO ▶
	VIDEO SIGNAL ◀ AUTO ▶
	SCART INPUT ◀ OFF ▶
	ANAMORPHIC ◀ OFF ▶
	PASSWORD FUNCTION ◀ DISPLAY INPUT ▶
	LANGUAGE ◀ English ▶
	RESET ALL ◀ OK ▶

- **CINEMA MODE** can be adjusted only when a TV60,480i signal is being displayed.
- When **SCART INPUT** is set to **ON**, nothing is output to the external monitor.
- When **SCART INPUT** is set to **ON**, normal computer signals aren't projected.
- Use a **SCART-BNC** (or **SCART-Mini D-SUB 15P**) cable (option) when connecting this projector with an AV device equipped with the **SCART** terminal.
- Some AV devices equipped with the **SCART** terminal aren't compatible with this projector.
- When **VIDEO SIGNAL** is set to **AUTO**, the image may not be projected with correct colors. Change the setting of **VIDEO SIGNAL** depending on the input signal in such cases.
- When **ANAMORPHIC** is set to except **OFF**, the keystone adjustment ranges are limited.

④ **SIGNAL**

- HORIZ. POSITION** ... Use to adjust the horizontal position of the image.
- VERT. POSITION** ... Use to adjust the vertical position of the image.
- FINE SYNC** Use to synchronize the projector with the PC input signal so that the image is not blurred.
- TRACKING** Use to eliminate image noise such as wide stripes.
- COMPUTER INPUT** ... The projector adjusts its settings automatically when connected to a DVD player equipped with a component video output (Y, C_B, C_R). When the projector is connected with a device having an **RGB** terminal, choose **RGB** manually.
- HOLD** Use to adjust the image when flagging occurs near the top of the screen.

XGA60	
SIGNAL	
	HORIZ. POSITION ◀ 0 ▶
	VERT. POSITION ◀ 0 ▶
	FINE SYNC. ◀ 0 ▶
	TRACKING ◀ 0 ▶
	COMPUTER INPUT ◀ RGB ▶
	HOLD ◀ ON ▶
	USER ◀ OK ▶

⑤ **SIGNAL - USER (No need to adjust in normal use.)**

- CLAMP POSITION/ CLAMP WIDTH** ... Use to correct solid white or solid black in the projected image.
- VERT.SYNC.** Use to adjust the image when its motion doesn't run smoothly. Select **AUTO** for normal use.
- SHUTTER (U)** Use to adjust the image when noise appears on the top part of the image.
- SHUTTER (L)** Use to adjust the image when noise appears on the bottom part of the image.
- SHUTTER (LS)** Use to adjust the image when noise appears on the left half of the image.
- SHUTTER (RS)** Use to adjust the image when noise appears on the right half of the image.

SIGNAL-USER	
	CLAMP POSITION ◀ 0 ▶
	CLAMP WIDTH ◀ 1 ▶
	VERT. SYNC. ◀ AUTO ▶
	SHUTTER (U) ◀ 0 ▶
	SHUTTER (L) ◀ 0 ▶
	SHUTTER (LS) ◀ 0 ▶
	SHUTTER (RS) ◀ 0 ▶

- If any setting of the **SIGNAL-USER** menu is changed, the image may not be displayed correctly. In this case, press the **AUTO POSITION** button.

Important:

- You can set the **IMAGE**, **SIGNAL**, and **SIGNAL-USER** menus only when the signal is supplied.
- TV60 and TV50 are equivalent to 480i and 576i respectively. Settings made for one of them apply automatically when its counterpart is supplied.

Image adjustment

Image adjustment

You can adjust the image using the IMAGE menu.

XGA60		
IMAGE		
CONTRAST	◀ 0 ▶	
BRIGHTNESS	◀ 0 ▶	
sRGB	◀ OFF ▶	
COLOR MATRIX	◀ COMPUTER ▶	
COLOR TEMP.	◀ STANDARD ▶	
COLOR	◀ 0 ▶	
TINT	◀ 0 ▶	
SHARPNESS	◀ 0 ▶	
GAMMA MODE	◀ AUTO ▶	

To control the white-to-black level of the image :

Adjust CONTRAST in the IMAGE menu. Press the ▶ button to increase the contrast and the ◀ button to reduce it.

To control the light level of the image :

Adjust BRIGHTNESS in the IMAGE menu. Press the ▶ button to lighten the image and the ◀ button to darken it.

To determine the intensity of the color :

Adjust COLOR in the IMAGE menu. Press the ▶ button to increase the amount of color in the image and the ◀ button to decrease it.

To adjust the red-green color balance of the image :

Adjust TINT in the IMAGE menu. Press the ▶ button to increase the amount of green in the image and the ◀ button to increase the amount of red in the image.

To adjust the detail and clarity of the image :

Adjust SHARPNESS in the IMAGE menu. Press the ▶ button to sharpen the image and the ◀ button to soften the image.

Color matrix

This projector adjusts the color balance in each color of RGB (red, green, and blue), and their neutral colors (yellow, cyan, and magenta) by the color correction adjustment. Use the color correct adjustment when you want to emphasize color or when only a certain color balance is not correctly adjusted.

1. Select COLOR MATRIX in the IMAGE menu.

Press the ◀ or ▶ button to select USER .

Press the ENTER button.

COLOR MATRIX		
RED	◀ 0 ▶	
YELLOW	◀ 0 ▶	
GREEN	◀ 0 ▶	
CYAN	◀ 0 ▶	
BLUE	◀ 0 ▶	
MAGENTA	◀ 0 ▶	
RGB-TINT	◀ 0 ▶	

4. Press the ▲ or ▼ button to select the desired color.

- If you want to adjust the all color balance of the image, select RGB-TINT.

5. Press the ◀ or ▶ button to adjust the color balance of the selected color.

6. Repeat steps 4 and 5 for optimum adjustment results.

7. Exit the menu by pressing the MENU button several times.

- When the input source is VIDEO or COMPUTER, the setting items in the color matrix adjustment are automatically set to the predetermined values. You can change these settings manually.
- To cancel the color matrix adjustment, select OFF in step 2.
- When the color matrix adjustment is carried out, the colors in the menu will also vary. This isn't a product malfunction.

Color temperature

1. Select COLOR TEMP. in the IMAGE menu.

2. Press the ◀ or ▶ button to select USER .

3. Press the ENTER button.

COLOR TEMP.-USER		
CONTRAST R	◀ 0 ▶	
CONTRAST B	◀ 0 ▶	
BRIGHTNESS R	◀ 0 ▶	
BRIGHTNESS B	◀ 0 ▶	

4. Press the ▲ or ▼ button to select the desired item.

5. Press the ◀ or ▶ button to adjust the selected item.

6. Repeat steps 4 and 5 for optimum adjustment results.

7. Exit the menu by pressing the MENU button several times.

About color temperature

There are different kinds of white color. Color temperature is a way to show the differences in white. White of which temperature is low appears reddish. When the color temperature rises, white appears bluish. This projector adjusts this color temperature by changing the values of contrast blue and red.

To rise the color temperature:

Increase the CONTRAST B (blue) and decrease the CONTRAST R (red).

To reduce the color temperature:

Decrease the CONTRAST B (blue) and increase the CONTRAST R (red).

Adjustment of the image from the computer

This projector adjusts the format of the video signal supplied from the computer. However, sometimes images are not projected correctly owing to the type of the computer used. When the image from the computer isn't projected correctly, press the AUTO POSITION button. (See page 14.) If the image isn't projected correctly yet, adjust the image from the computer using the menu.

XGA60		
SIGNAL		
HORIZ. POSITION	◀ 0 ▶	
VERT. POSITION	◀ 0 ▶	
FINE SYNC.	◀ 0 ▶	
TRACKING	◀ 0 ▶	
COMPUTER INPUT	◀ RGB ▶	
HOLD	◀ ON <input checked="" type="checkbox"/> ▶	
USER	OK <input checked="" type="checkbox"/>	

To move the image horizontally :

Adjust HORIZ. POSITION in the SIGNAL menu.
Press the ▶ button to move the image to the left.
Press the ◀ button to move the image to the right.

To move the image vertically :

Adjust VERT. POSITION in the SIGNAL menu.
Press the ▶ button to move the image upward.
Press the ◀ button to move the image downward.

When the image flickers or the image is out of focus :

Adjust FINE SYNC. in the SIGNAL menu.

When the top part of the image flags :

Change the setting of HOLD in the SIGNAL menu.
Select ON , press the ENTER button, and adjust BEGIN or END to minimize the flagging.

SIGNAL-USER		
CLAMP POSITION	◀ 0 ▶	
CLAMP WIDTH	◀ 1 ▶	
VERT. SYNC.	◀ AUTO ▶	
SHUTTER (U)	◀ 0 ▶	
SHUTTER (L)	◀ 0 ▶	
SHUTTER (LS)	◀ 0 ▶	
SHUTTER (RS)	◀ 0 ▶	

When wide strips appear :

Adjust CLAMP POSITION or CLAMP WIDTH in the SIGNAL - USER menu.

When the motion doesn't run smoothly :

Adjust VERT. SYNC. in the SIGNAL - USER menu.
Select AUTO for normal use.

When noise appears on the right or left half of the image :

Adjust SHUTTER (LS) or SHUTTER (RS) in the SIGNAL - USER menu.

When noise appears on the top or bottom part of the image :

Adjust SHUTTER (U) or SHUTTER (L) in the SIGNAL - USER menu.

Important:

Do not change any of the settings in the SIGNAL-USER menu for normal use.

Simple adjustment method

1. Select HORIZ. POSITION in the SIGNAL menu.
2. Press the ◀ or ▶ button to adjust the horizontal start position (or the left side of the image).
3. Select TRACKING in the SIGNAL menu.
4. Press the ◀ or ▶ button to adjust the horizontal end position (or the right edge of the image).
5. Repeat steps 1 to 4 for optimum adjustment results.
6. Select VERT. POSITION in the SIGNAL menu.
7. Press the ◀ or ▶ button to adjust the vertical start position (or the upper edge of the image).

Advanced features

Expand

By pressing the EXPAND button on the remote control, you can magnify the image to view the details. You can view the image in its original size in the REAL mode.

- The EXPAND mode doesn't work with video or S-video signal.
- The EXPAND mode doesn't function with some input signals. For details, see page 32 or 33.

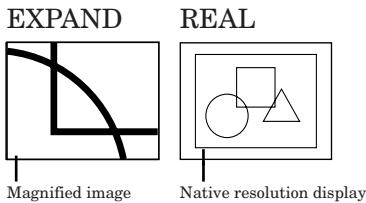

To choose the EXPAND or REAL mode:

1. Press the MENU button.
2. Press the ◀ or ▶ to select the FEATURE menu.
3. Press the ENTER button.
4. Press the ▲ or ▼ button to select EXPAND MODE.
5. Press the ◀ or ▶ to choose EXPAND or REAL.
6. Press the MENU button twice to exit the menu.

To use the EXPAND mode:

1. Press the EXPAND button.
 - You can select the area to be magnified by pressing the ▲, ▼, ◀, or ▶ button on the remote control.
 - You can change the magnification of the selected area by pressing the + or - button.
2. Press the EXPAND button again to exit the EXPAND mode.
 - The regular operation screen will appear.

Important:

- In the EXPAND mode, you can't adjust the volume.

To use the REAL mode:

1. Press the EXPAND button.
 - In the REAL mode, press the ◀ or ▶ button on the remote control for fine adjustment.
 - In the REAL mode, the AUTO POSITION button doesn't function. When this button is pressed, the prohibition mark (⊘) appears on the screen.
2. Press the EXPAND button again to exit the REAL mode.
 - The regular operation screen will appear.

Still

To stop the motion in the image temporarily (or to display a still image):

Press the STILL button on the remote control.

- The image will freeze temporarily.

To resume the motion in the image:

Press the STILL button on the remote control again.

For XLSU only

Picture in Picture (PinP)

One of the special features of this projector is the picture-in-picture (PinP) mode. The PinP mode allows you to view the images from different sources at the same time.

To use the PinP mode

1. Press the PinP button on the remote control.
 - When you press the PinP button with the image from the COMPUTER/COMPONENT VIDEO IN terminal displayed on the screen, the image from the VIDEO IN or S-VIDEO IN terminal is displayed as the sub image.
 - When the image from the VIDEO IN or S-VIDEO IN terminal is displayed, the PinP mode isn't activated.
2. If necessary, select the desired external input source of the sub image by using the SOURCE button on the remote control or the VIDEO button on the control panel.

To change the position of the sub image:

1. Press the ◀ or ▶ buttons on the remote control.
2. Press the PinP button on the remote control.
 - The sub image will disappear.

Important:

- The motion may not run smoothly in the PinP mode.
- The PinP mode isn't available with some input signals. For further information, see page 32.

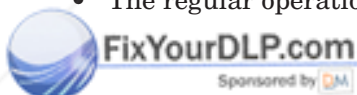

Discount-Merchant.com (800) 281-8860
THE TRUSTED SOURCE FOR PROJECTOR LAMPS AND ACCESSORIES

Setting of the image displayed during startup or muting

You can display your desired image as the startup screen (or splash screen). Using the menu, you can also use such image as a background that is displayed while the video is muted or no signal is supplied.

Important:

- You can't set IMAGE CAPTURE when PASSWORD FUNCTION in the FEATURE menu has been set to SPLASH ID SCREEN to enable the password lock.

Setting procedure

- Press the COMPUTER button to select the image supplied to the COMPUTER/COMPONENT VIDEO IN terminal.
- Display your desired image.
- Display the INSTALLATION menu.
- Select IMAGE CAPTURE by pressing the ▲ or ▼ button.
- Press the ENTER button.
 - The setting menu will be displayed.

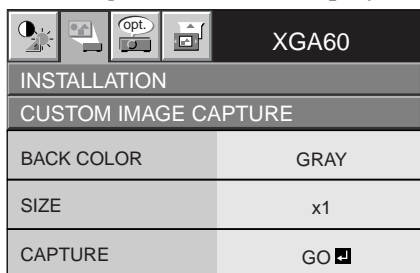

Set the background color

(Set the background color only when you set the image size to x1 or x2.)

- Select BACK COLOR by pressing the ▲ or ▼ button.
- Select your desired color for the background (GRAY, RED, GREEN, BLUE, BLACK, WHITE, RED50%, GREEN50%, or BLUE50%) by pressing the ◀ or ▶ button.

Set the image size

- Select SIZE by pressing the ▲ or ▼ button.
- Select x1, x2, or FULL by pressing the ◀ or ▶ button.



Capture the image

- Select CAPTURE by pressing the ▲ or ▼ button.
- Press the ENTER button.
 - A red frame appears. (The size of the red frame is 295x222 pixels.)

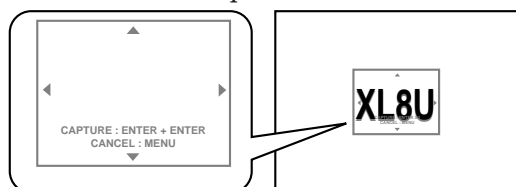

- Adjust the size of the image to be captured so that such image stays within the red frame.
 - Press the ▲, ▼, ◀, or ▶ button to move the red frame.
 - You can't move the red frame outside the screen.

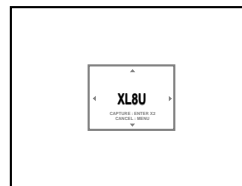

- Press the ENTER button twice.
 - Image capture will start.

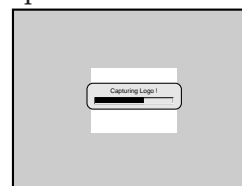

- Press the MENU button to cancel the procedure.
- When the image capture completes, the captured image will be displayed for three seconds.

Important:

- You can't change the new startup screen back to the original startup screen. (Even when you select RESET ALL in the FEATURE menu, the factory default screen isn't available any longer.) When you want to change the startup screen again, capture another image.
- The captured image will be displayed from the next startup. If the captured image isn't displayed, make sure that the setting of SPLASH SCREEN in the INSTALLATION menu isn't OFF. (See page 16.)
- To display the captured image while the video is muted, set MUTE MODE in the INSTALLATION menu to IMAGE. (See page 16.)
- When BACK COLOR in the INSTALLATION menu is set to IMAGE, the captured image will be displayed while no signal is supplied.
- Some images can't be captured correctly because of their signal type.

Advanced features (continued)

Page-up and page-down

You can control the computer to page-up and page-down the presentation data using the remote control. Switch the pages using the PAGE UP or DOWN button on the remote control.

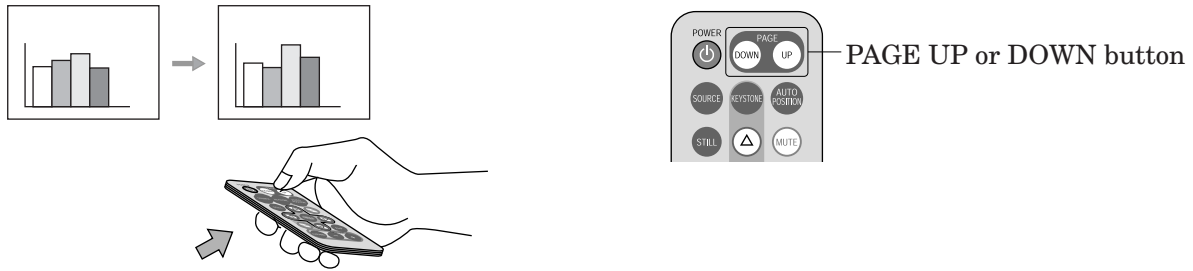

Connection

To control the computer using the remote control, connect the projector with the computer as shown below.

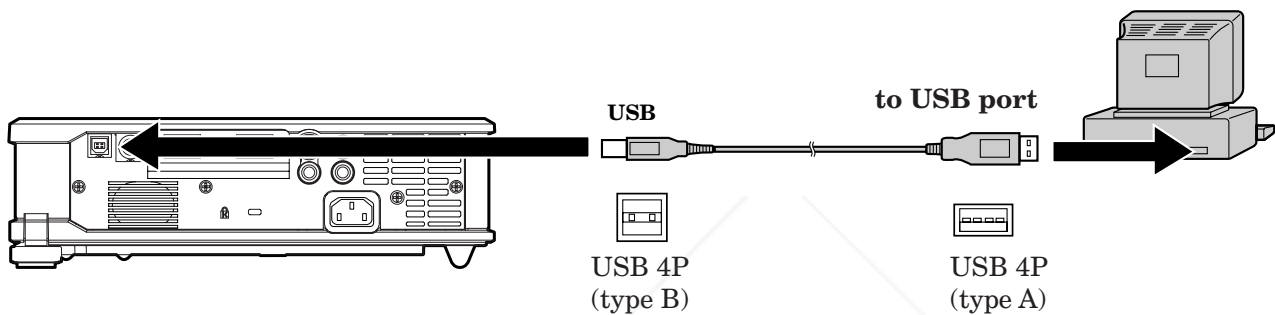

- Only the computers equipped with a USB port are supported.
- Wait for the lamp to light up before connecting the USB cable.

Password function

This projector is equipped with the password function that is designed for prevention of theft and wrong operation by children and restriction on operation by other than specified users. The password function has three modes as follows.

DISPLAY INPUT When the projector is turned on, the startup screen (or splash screen) will appear and stay on the screen until the password is entered. When the password is entered, the startup screen will switch to the regular operation screen.

MENU ACCESS All the buttons except for the POWER button on the projector are disabled. (The buttons on the remote control are enabled.) You can use this mode as a measure of prevention of wrong operation by children and restriction on operation by other than specified users.

SPLASH ID SCREEN .. **IMAGE CAPTURE** and **SPLASH SCREEN** in the menu become unavailable. **SPLASH SCREEN** will be set to ON automatically.

To enable the password function:

1. Display the FEATURE menu.
2. Press the ▲ or ▼ button to select PASSWORD FUNCTION.
3. Press the ► button to change the mode among DISPLAY INPUT, MENU ACCESS, and SPLASH ID SCREEN.
 - When the password has already been set, the mode won't be changed. In such cases, press the ENTER button to cancel the password function and try again.
4. Press the ENTER button.
 - The screen for setting the password function will appear.

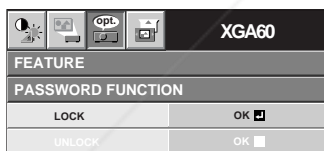

5. Press the ENTER button.
 - The screen for entering a password will appear.

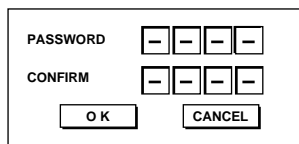

6. Press the ▲ or ▼ button to select a number from 0 to 9.
7. Press the ► button.
 - You can set the next digit.
8. Repeat steps 6 and 7 to set a four-digit password.
9. Enter the password again for confirmation using the same steps.
10. Select OK, and press the ENTER button.
 - If the entered passwords don't match, an error message will appear.
 - To cancel the procedure, select CANCEL, and press the ENTER button.
 - You can cancel the procedure by pressing the MENU button alternatively.

To cancel the password function:

1. Display the FEATURE menu.
2. Press the ▲ or ▼ button to select PASSWORD FUNCTION.
3. Press the ENTER button.
 - The screen for canceling the password function will appear.

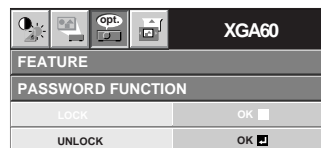

4. Press the ENTER button.
 - The screen for entering the password will appear.

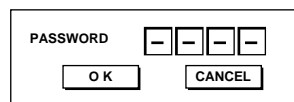

5. Press the ▲ or ▼ button to select a number from 0 to 9.
6. Press the ► button.
 - You can set the next digit.
7. Repeat steps 5 and 6 to enter the four-digit password.
8. Press the ► button, select OK, and press the ENTER button.
 - If you enter a wrong password, an error message will appear.
 - To cancel the procedure, press the ► button, select CANCEL, and press the ENTER button.
 - You can cancel the procedure by pressing the MENU button alternatively.

Lamp replacement

The lamp is designed to project the image on the LCD panels. When the lamp no longer functions, replace it with a new one.

Caution:

- Do not remove the lamp immediately after using the projector. You may get burned because the lamp is very hot after use.
- Before replacing the lamp, press the POWER button to turn off the lamp and wait for two minutes for the lamp and LCD panels to cool down. Unplug the power cord from the wall outlet and wait one hour for the lamp to cool down completely.
- Do not remove the lamp except for replacement. Careless handling can cause injury or fire.
- Do not touch the lamp directly. It may break and cause injury or burn.
- Be sure not to drop the lamp lid screw into the projector. Also be sure not to put metal or any flammable objects inside because it may cause fire or electric shock. If any objects should fall inside, unplug and contact your dealer.
- Install the lamp securely to prevent failure and fire.
- If the lamp should break, small glass fragments may fall out through the grilles and some may remain inside of the projector or the lamp box. When taking the lamp box out, be sure to turn over the projector and hold the handle of the lamp box to avoid injury due to the glass fragments.
- If the lamp should break, never shake the lamp box or hold it in front of your face after removing it. The glass fragments may fall out and cause injury to your eyes.

1. Reverse the projector gently.

2. Loosen the screw (a) using a Phillips screwdriver (+), and remove the lamp cover (b).

3. Remove the screws (c) using a Phillips screwdriver (+).

4. Pull up the handle.

5. Pull out the lamp box by the handle while holding the projector.

- Pull the lamp box out of the projector slowly. If it is pulled out quickly, the lamp may break scattering glass fragments.
- Do not spill liquid on the removed lamp box or do not place it near any flammable object or where children can reach to prevent injury or fire.
- Do not remove the screws (d). If they are removed, the lamp may fall in the course of removal of the box, resulting in lamp breakage.

6. Load a new lamp box securely into the projector in the right orientation.

7. Put the handle back to the original position.

- Make sure that the handle is locked.

8. Tighten up the screws (c) using a Phillips screwdriver (+).

9. Tighten up the screw (a) using a Phillips screwdriver (+) to secure the lamp cover.

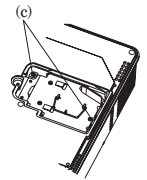

Reset of the lamp operation time

Plug in the power cord, turn on the lamp, and reset the lamp operation time by keep pressing the ◀, ▶, and POWER buttons on the control panel at the same time about three seconds.

Important:

- Unless these three buttons are pressed at the same time, the lamp operation time isn't reset.
- Make sure that the STATUS indicator is lit twice and the lamp operation time is reset successfully.
- The projector doesn't turn on if the lamp cover isn't attached securely.
- Be sure to reset the lamp operation time whenever you replace the lamp.
- Do not reset the lamp operation time unless you replace the lamp.

Caution:

- The lamp is fragile. If it is broken, be careful not to cut yourself with glass fragments.
- Contact your dealer for a new lamp.

Interval of lamp replacement

The recommended interval of lamp replacement is about 2,000 hours of consecutive use. Such interval differs depending on the operating environment and may be shorter than 2,000 hours. Decrease in luminance and/or color brightness indicates that the lamp needs to be replaced. When the lamp operation time exceeds 1,500 hours*¹, the indicator will blink alternately between green and red (while the lamp is lit; when the lamp is not lit, the indicator will be lit red only) and the lamp replacement message will appear on the screen for one minute everytime the lamp is turned on. When the lamp has been used for about 1,900 hours*¹, the replacement message (LAMP:>1900H) will appear on the screen for one minute every 10 hours thereafter.

When the lamp operation time exceeds 2,000 hours*¹ *², the projector automatically shuts off and can't be used until the lamp is replaced and the lamp operation time is reset.

*¹ When LAMP MODE of the INSTALLATION menu is set to STANDARD.

*² When LAMP MODE is set to LOW, this duration will be extended up to 3,000 hours.

Caution:

- This projector uses a lamp that contains mercury. Disposal of the lamp or the projector with the lamp may be regulated due to environmental considerations. For disposal or recycling information, please contact your local authorities or the Electronic Industries Alliance: www.eiae.org. (For US only).

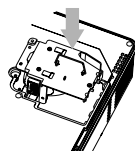
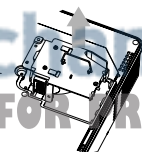
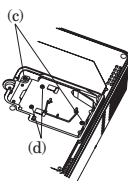
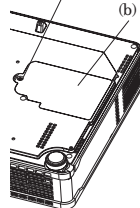
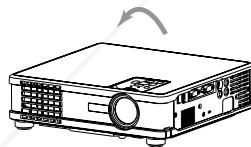

Maintenance

Caution:

Be sure to turn off the lamp and unplug the power cord from the wall outlet before you perform any maintenance on the projector.

Cleaning of the air-filter

Clean the air-filter frequently (about once a month). If the filter or ventilation grilles become clogged with dirt or dust, the temperature inside the projector may rise and cause troubles, such as damage to the inside parts and shortening the life of the panels.

- When the temperature inside the projector rises, the STATUS indicator will blink red and the lamp will be turned off.

1. Put the projector upside down and raise the lock of the filter cover in the direction of the arrow.

2. Remove the air-filter.

3. Wash the air-filter or change it with a new filter.
 - Use water or diluted mild detergent to clean the filter. Rinse the filter thoroughly and let it dry completely.

4. Attach the air-filter.

5. Attach the filter cover to the projector.
 - Make sure that the air-filter is attached correctly without displacement.

Important:

- If the filter is damaged or becomes extremely dirty, change it with a new filter. Contact your dealer for a new filter.
- The projector will not turn on if the air-filter cover is attached improperly .

Caution:

Be sure to use the projector with an air-filter. If not, dust may get inside the projector causing fire and failure.

Cleaning of the projector and the ventilation slots

Use a soft cloth to clean the projector and the ventilation grilles. When the grilles become dirty, wipe them with a soft cloth dampened with diluted mild detergent, and then wipe them with a dry cloth.

To protect the surface of the projector from fading or deteriorating:

- Do not spray insecticide on or inside the projector.
- Do not use benzine or thinner to clean it.
- Do not let rubber or plastic materials contact with projector.

Cleaning of the lens

Use a standard lens-cleaning brush or a piece of lens tissue dampened with lens cleaning fluid. The lens surface is fragile. Use only recommended, nonabrasive lens-cleaning materials. Do not touch the lens with your fingers.

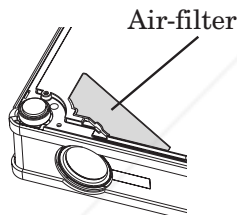
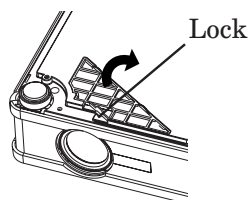
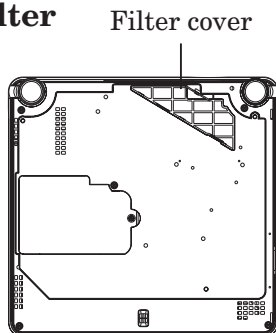

Troubleshooting

The following offers solutions to some of the common problems you may encounter. We suggest that you consult this chart before contacting your dealer.

Images aren't projected on the screen.

Problem	Cause and solution																				
Power isn't turned on.	<ul style="list-style-type: none"> Check the states of the indicators. <table border="1"> <thead> <tr> <th>POWER</th> <th>STATUS</th> <th>Solution</th> </tr> </thead> <tbody> <tr> <td>○ Off</td> <td>○ Off</td> <td> <ul style="list-style-type: none"> Connect the power cord to the projector. Plug the power cord into a wall outlet. </td> </tr> <tr> <td rowspan="4">☀ Steady red</td> <td>○ Off</td> <td> <ul style="list-style-type: none"> If any objects are blocking the air inlet or outlet grille, remove them and carry out the following. <ol style="list-style-type: none"> Unplug the power cord from the wall outlet. Make sure that the projector has cooled off. Plug the power cord into the wall outlet. Press the POWER button. </td> </tr> <tr> <td>○ ↻ ☀ Blinking orange</td> <td> <ul style="list-style-type: none"> If any objects are blocking the air inlet or outlet grille, remove them. Don't expose the air outlet grilles to hot air emitted from a heating appliance. Check whether the filter is clogged with dirt or dust. <ul style="list-style-type: none"> → Clean the filter, if clogged. (See page 25.) </td> </tr> <tr> <td>○ ↻ ☀ Blinking green</td> <td> <ul style="list-style-type: none"> After the STATUS indicator stops blinking, press the POWER button. If you unplug the power cord while the fan is rotating, the lamp may not turn on about one minute when you plug the power cord next time. The lamp can't turn on again for one minute after it goes out. Press the POWER button several times. </td> </tr> <tr> <td>☀ Steady red</td> <td> <ul style="list-style-type: none"> Replace the lamp. (The lamp is at the end of its life.) </td> </tr> <tr> <td rowspan="2">☀ ↻ ☀ Blinking red / green</td> <td>○ Off</td> <td> <ul style="list-style-type: none"> Attach the lamp cover on the bottom. </td> </tr> <tr> <td>☀ Steady or ○ ↻ ☀ Blinking</td> <td> <ul style="list-style-type: none"> Unplug the power cord from the wall outlet and contact your dealer. </td> </tr> </tbody> </table>	POWER	STATUS	Solution	○ Off	○ Off	<ul style="list-style-type: none"> Connect the power cord to the projector. Plug the power cord into a wall outlet. 	☀ Steady red	○ Off	<ul style="list-style-type: none"> If any objects are blocking the air inlet or outlet grille, remove them and carry out the following. <ol style="list-style-type: none"> Unplug the power cord from the wall outlet. Make sure that the projector has cooled off. Plug the power cord into the wall outlet. Press the POWER button. 	○ ↻ ☀ Blinking orange	<ul style="list-style-type: none"> If any objects are blocking the air inlet or outlet grille, remove them. Don't expose the air outlet grilles to hot air emitted from a heating appliance. Check whether the filter is clogged with dirt or dust. <ul style="list-style-type: none"> → Clean the filter, if clogged. (See page 25.) 	○ ↻ ☀ Blinking green	<ul style="list-style-type: none"> After the STATUS indicator stops blinking, press the POWER button. If you unplug the power cord while the fan is rotating, the lamp may not turn on about one minute when you plug the power cord next time. The lamp can't turn on again for one minute after it goes out. Press the POWER button several times. 	☀ Steady red	<ul style="list-style-type: none"> Replace the lamp. (The lamp is at the end of its life.) 	☀ ↻ ☀ Blinking red / green	○ Off	<ul style="list-style-type: none"> Attach the lamp cover on the bottom. 	☀ Steady or ○ ↻ ☀ Blinking	<ul style="list-style-type: none"> Unplug the power cord from the wall outlet and contact your dealer.
POWER	STATUS	Solution																			
○ Off	○ Off	<ul style="list-style-type: none"> Connect the power cord to the projector. Plug the power cord into a wall outlet. 																			
☀ Steady red	○ Off	<ul style="list-style-type: none"> If any objects are blocking the air inlet or outlet grille, remove them and carry out the following. <ol style="list-style-type: none"> Unplug the power cord from the wall outlet. Make sure that the projector has cooled off. Plug the power cord into the wall outlet. Press the POWER button. 																			
	○ ↻ ☀ Blinking orange	<ul style="list-style-type: none"> If any objects are blocking the air inlet or outlet grille, remove them. Don't expose the air outlet grilles to hot air emitted from a heating appliance. Check whether the filter is clogged with dirt or dust. <ul style="list-style-type: none"> → Clean the filter, if clogged. (See page 25.) 																			
	○ ↻ ☀ Blinking green	<ul style="list-style-type: none"> After the STATUS indicator stops blinking, press the POWER button. If you unplug the power cord while the fan is rotating, the lamp may not turn on about one minute when you plug the power cord next time. The lamp can't turn on again for one minute after it goes out. Press the POWER button several times. 																			
	☀ Steady red	<ul style="list-style-type: none"> Replace the lamp. (The lamp is at the end of its life.) 																			
☀ ↻ ☀ Blinking red / green	○ Off	<ul style="list-style-type: none"> Attach the lamp cover on the bottom. 																			
	☀ Steady or ○ ↻ ☀ Blinking	<ul style="list-style-type: none"> Unplug the power cord from the wall outlet and contact your dealer. 																			
Images aren't projected on the screen.	<ul style="list-style-type: none"> Cancel the AV mute by pressing the MUTE button. Remove the lens cap. The lamp sometimes takes about one minute to light up. On rare occasion, the lamp fails to light up. In such cases, wait a few minutes and try to light the lamp again. If the projector was turned off before the lamp cooled down completely, the fans may start rotating and the POWER button may not function when you plug the power cord into the wall outlet next time. Wait for the fans to stop and press the POWER button to turn on the lamp again. Set SCART INPUT in the FEATURE menu to OFF. (See page 17.) Check that the filter is clean. (See page 25.) Check that the lamp cover are closed. Check that the cable connected to the external device isn't broken. When an extension cord is being used, replace it with the supplied cable and check whether images are projected correctly. If images are projected correctly, use an RGB signal amplifier along with the extension cord. 																				
Images suddenly disappear.	<ul style="list-style-type: none"> The air inlet or outlet grille may be blocked. (In such cases, the STATUS indicator blinks green.) <ul style="list-style-type: none"> → Remove the objects blocking the air inlet or outlet grille and carry out the following. <ol style="list-style-type: none"> Wait for the air inlet or outlet fan to stop (or wait for the STATUS indicator to go out.) Unplug the power cord from the wall outlet. Wait about 10 minutes. Plug the power cord into the wall outlet. Press the POWER button. When the STATUS indicator is blinking red, it is indicating that the lamp should be replaced. Replace the lamp in this case. 																				
NO SIGNAL" is displayed	<ul style="list-style-type: none"> Turn on the power of the connected device, or check whether there is something wrong with the connected device. Check whether the external device outputs signals. (Check this especially when the external device is a notebook computer.) Check that the cable connected to the external device isn't defective. Check that the projector is connected to the external device using the correct terminals. Check that the connected device is correctly selected as the input source. When an extension cord is being used, replace it with the supplied cable and check whether images are projected correctly. If images are projected correctly, use an RGB signal amplifier along with the extension cord. 																				
The screen for entering the password appears.	<ul style="list-style-type: none"> PASSWORD FUNCTION in the FEATURE menu has been set to DISPLAY INPUT to enable the password lock. <ul style="list-style-type: none"> → Enter the password or contact the person in charge of management of the projector. (See page 23.) 																				

Images aren't projected correctly.

Problem	Cause and solution
Projected images are shaking. Projected images are displaced.	<ul style="list-style-type: none"> • Check that the cable connected to the external device isn't intermittent. • Connect the cable's plug with the external device's connector firmly. • Press the AUTO POSITION button. • Some computers output out-of-spec signals on rare occasion. Adjust the SIGNAL menu. (See page 19.)
Projected images are distorted.	<ul style="list-style-type: none"> • Adjust the projector and the screen so that they are perpendicular to each other. (See page 12.)
Projected images are dark.	<ul style="list-style-type: none"> • Adjust BRIGHTNESS in the IMAGE menu. (See page 18.) • Replace the lamp. (See page 24.)
Projected images are blurred.	<ul style="list-style-type: none"> • Adjust the focus. (See page 13.) • Clean the lens. • Press the ◀ or ▶ button on the remote control to eliminate flicker. • Adjust BRIGHTNESS and CONTRAST in the IMAGE menu. (See page 18.) • Adjust the projector and the screen so that they are perpendicular to each other. (See page 12.)
Afterimages persist on the screen.	<ul style="list-style-type: none"> • This phenomenon is improved by keeping projecting an evenly bright image. (Such "image burn-in" phenomenon where afterimages persist on the screen may occur if a stationary image is kept displayed on the screen for a long time.)
Red, blue, and green dots appear in projected images. Black dots appear in projected images.	<ul style="list-style-type: none"> • This phenomenon is unique to LCD projector and isn't a product malfunction. (A small number of pixels always stay on or off, which are not malfunctions. More than 99.99% of the pixels are effective.)
Fine streak pattern appears in projected images.	<ul style="list-style-type: none"> • It occurs because of interference with the screen and isn't a product malfunction. Change the screen or readjust the focus of the projector.
Projected images (and/or audio) appear wavy and distorted.	<ul style="list-style-type: none"> • Connect the cable's plug with the external device's connector firmly. • Keep the projector away from equipment generating interfering radio waves. • When the keystone adjustment is carried out, the image may not be displayed correctly because of the type of input signal. This isn't a product malfunction. In this case, readjust the keystone so that the amount of keystone correction is as small as possible.
Tint in projected images is incorrect.	<ul style="list-style-type: none"> • Check that COMPUTER INPUT in the SIGNAL menu is correctly set. (See page 17.) • Check that the cable connected to the external device isn't broken.
Only the motion areas in the images supplied from the computer aren't displayed.	<ul style="list-style-type: none"> • This is caused by the computer being used. Contact the manufacturer of your computer.
Projected images are obscured.	<ul style="list-style-type: none"> • Match the output resolution of your computer with the resolution of the projector. For the method to change the output resolution of the computer, contact the manufacturer of your computer. (See page 32.) • Some images and texts appear obscured during the keystone adjustment. In such cases, use the projector without applying the keystone adjustment. (See page 12.)



Discount-Merchant.com (800) 281-8860
THE TRUSTED SOURCE FOR PROJECTOR LAMPS AND ACCESSORIES

Troubleshooting (continued)

Others

Problem	Cause and solution
Hot air is emitted from the air outlet grilles.	<ul style="list-style-type: none">• This air comes out as a result of cooling the inside of the projector. This isn't a product malfunction.
No audio is output.	<ul style="list-style-type: none">• Check that the volume isn't set to low.
The menu can't be used.	<ul style="list-style-type: none">• The microcomputers inside the projector may be wrongly operating because of noise.<ul style="list-style-type: none">➔ Press the POWER button to turn off the lamp and unplug the power cord from the wall outlet. Wait about 10 minutes, plug the power cord in, and try again.
"TEMPERATURE!!" is displayed.	<ul style="list-style-type: none">• This indication appears when the ambient temperature rises high. When the ambient temperature stays high, the lamp goes out.<ul style="list-style-type: none">➔ Eliminate any causes of the rise in the ambient temperature.• This indication appears when the air inlet or outlet grille is blocked. When they are kept blocked, the lamp goes out.<ul style="list-style-type: none">➔ Remove the objects blocking the air inlet or outlet grille. Clean the filter. (See page 25.)
The  mark appears.	<ul style="list-style-type: none">• This mark appears when ineffective operation (such as switching the input source while the menu is being displayed) is carried out. This isn't a product malfunction.
The remote control doesn't function easily or at all.	<ul style="list-style-type: none">• Check that the battery is loaded in the remote control or the battery isn't weak. (See page 8.)• Check that the remote control sensor isn't exposed to direct sunlight or fluorescent light. (See page 8.)• Use the remote control within its operation range. (See page 8.)• Use the remote control at least 10 cm away from the projector.
The buttons on the control panel (except for the POWER button) don't function.	<ul style="list-style-type: none">• PASSWORD FUNCTION in the FEATURE menu has been set to MENU ACCESS to enable the password lock.<ul style="list-style-type: none">➔ Cancel the password lock or contact the person in charge of management of the projector. (See page 23.)

When the problems below occur after the lamp is replaced, check the following.

Problem	Cause and solution
The power isn't turned on.	<ul style="list-style-type: none">• Attach the lamp cover on the bottom correctly.• Reset the lamp operation time. (See page 24.)
The STATUS indicator blinks.	<ul style="list-style-type: none">• Reset the lamp operation time. (See page 24.)



Discount-Merchant.com (800) 281-8860
THE TRUSTED SOURCE FOR PROJECTOR LAMPS AND ACCESSORIES

Indicators

This projector has two indicators, each of which shows the operation condition of the projector. The following offer solutions to possible problems. If these problem persist, turn the projector off and consult your dealer.

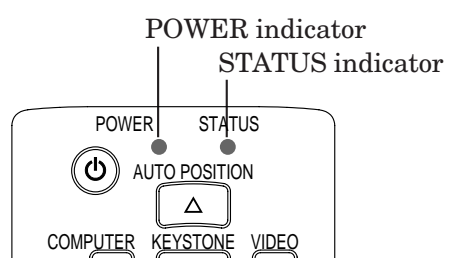

Normal condition

POWER	STATUS	CONDITION	NOTE
Steady red	Off	Stand-by	
Steady green	Blinking green	Lamp stand-by (about 1 minute)	The POWER button cannot be used to switch between on and off.
Steady green	Steady green	The power is on. (Normal condition)	

Abnormal condition

POWER	STATUS	CONDITION	POSSIBLE SOLUTION
Steady green or Steady red	Blinking orange	Abnormal temperature <ul style="list-style-type: none"> The ventilation grilles or air filter is clogged with dust or dirt. The room temperature is high. 	<ul style="list-style-type: none"> Clean the ventilation grilles or air filter. Relocate the projector to a cooler place.
Steady red	Blinking green	The protection circuit is working or the lamp is in an abnormal condition.	<ul style="list-style-type: none"> Wait until the STATUS indicator goes out, then press the POWER button. If the above solution is not effective, replace the lamp.
Steady green	Blinking green/red	Lamp operation time warning. (Total lamp operation time reached 1,500 hours* while the power was on.)	Replace the lamp. Change with a new lamp if this problem recurs.
Steady red	Blinking red	Lamp operation time warning. (Total lamp operation time reached 1,500 hours* while the power was off.)	
Steady red	Steady red	Lamp operation time warning. (Total lamp operation time reached 2,000 hours* while the power was off.)	
Blinking green/red	Off	The lamp cover isn't closed.	Close the cover correctly.
Blinking green/red or Steady by	Blinking	Abnormal.	Contact your dealer.

* When LAMP MODE of the INSTALLATION menu is set to STANDARD. When it is set to LOW, the duration will be extended.

FixYourDLP.com
 Discount-Merchant.com (800) 281-8860
 THE TRUSTED SOURCE FOR PROJECTOR LAMPS AND ACCESSORIES

Specifications

Type	LCD projector
Model	XL8U / XL4U / SL4U
Rated power supply	100 - 240 V AC, 50 / 60 Hz
Rated input	2.6 A
LCD panels	0.7-inch LCD panel: 3 pieces (for R, G, B) Pixels 1,024 x 768 = 786,432 pixels Total 2,359,296 pixels (XL8U/XL4U) Pixels 800 x 600 = 480,000 pixels Total 1,440,000 pixels (SL4U) Active pixel rate: 99.99% or more (each panel)
Colors	16,770,000 colors
Projection lens	F 1.8 - 2.1 f = 27 - 32 mm (XL8U) F 2.0 - 2.3 f = 23 - 27 mm (XL4U/SL4U)
Light source lamp	180 W NSH
Picture size	40 - 300 inch (aspect ratio 4:3)
PC compatibility	Resolution : 640 x 400 (Expand) - 1024 x 768 (Real) - 1280 x 1024 (Compress) (XL8U/XL4U) 640 x 400 (Expand) - 800 x 600 (Real) - 1024 x 768 (Compress) (SL4U) Sync on Green available
Video compatibility	NTSC / NTSC 4.43 / PAL (including PAL-M, N) / SECAM, PAL-60 Component Video (DVD/HDTV) (480i, 576i, 480p, 576p, 1080i, 720p)
Audio output	2 W Mono
Speaker	Oval type (16 Ω 2 W) × 1
S-video input	Luminance signal: 1.0 Vp-p 75 Ω (negative sync.) Chroma signal: 0.286 Vp-p 75 Ω (burst signal)
Video input	1.0 Vp-p 75 Ω (negative sync.)
Audio input	300 mVrms, 10 kΩ or more
Analog RGB input	RGB: 0.7 Vp-p 75 Ω (negative sync.) YP _B PR(YC _B CR): Y:1.0 Vp-p (negative sync.) PbPR(CbCr):0.7 Vp-p HD/CS : TTL level (positive or negative) VD : TTL level (positive or negative)
Control connector	Serial (8-pin connector) RS-232C standards USB terminal
Outside dimensions	275 × 70 × 261 mm (width × height × depth) Not included protrusion.
Weight	Approx. 2.7 kg
Length of power cord	114 inch (2.9 m)
Temperature, humidity (performance guaranteed)	+41°F (+5°C) - +95°F (+35°C), 30~90%



Discount-Merchant.com (800) 281-8860

Kensington Lock

This projector has a Kensington Security Standard connector for use with Kensington MicroSaver Security System. Refer to the information that came with the Kensington System for instructions on how to use it to secure the projector. Please contact Kensington Technology Group below.

Kensington Technology Group
 2855 Campus Drive
 San Mateo, CA 94403, U.S.A.

Phone : +1- (650)572-2700 Fax : +1- (650)572-9675

Connectors

SERIAL (8P)

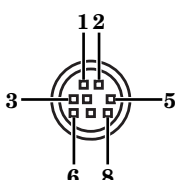

Pin No.	Name	I/O
1	TXD	IN
2	-	-
3	-	-
4	GND	-
5	-	-
6	-	-
7	RXD	OUT
8	-	-

COMPUTER / COMPONENT VIDEO IN/OUT (Mini D-SUB 15P)

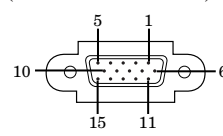

IN

Pin No.	Spec.
1	R(REDF)/C _R
2	G(GREEN)/Y
3	B(BLUE)/C _B
4	GND
5	GND
6	GND
7	GND
8	GND
9	-
10	GND
11	GND
12	DDC Data
13	HD/CS
14	VD
15	DDC Clock

OUT

Pin No.	Spec.
1	R(REDF)/C _R
2	G(GREEN)/Y
3	B(BLUE)/C _B
4	-
5	GND
6	GND
7	GND
8	GND
9	-
10	GND
11	-
12	-
13	HD/CS
14	VD
15	-

Dimensional drawings (unit : mm)

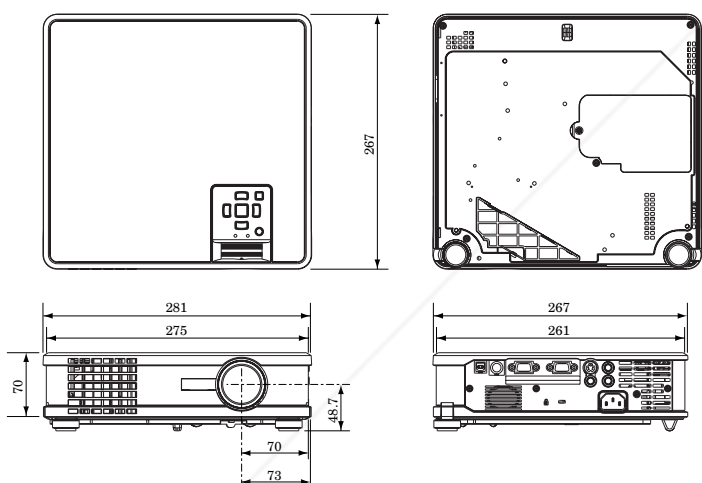

What's included in the box

2 AC power cord	246C483-10	1 Remote control (with battery)	
1 Audio/Video cable	246C383-20	(for XL8U)	939P961-10
1 RGB cable for PC	246C381-10	(for XL4U/SL4U)	939P961-20
1 RS-232C cable	246C448-10	1 Quick reference card	857D055-10
1 USB cable	246C447-10	1 Safety manual	871D393-10
	246C450-10	1 CD-ROM	919C133-10
		1 Carrying case	772P043-10

Replacement part (Option / Not included in the box)

Spare lamp	499B037-10 (VLT-XL8LP)
------------	---------------------------

Specifications (continued)

Specification of RGB signals in each computer mode of the projector (For XL8U/XL4U)

Signal mode	resolution (H x V)	horizontal frequency (kHz)	Vertical frequency (Hz)	Normal mode (H x V)	Real mode (H x V)	
TV60, 480i(525i)	–	15.73	59.94	1024 x 768	–	*1
TV50, 576i(625i)	–	15.63	50.00	1024 x 768	–	*1
1080i 60 (1125i 60)	–	33.75	60.00	1024 x 576	–	*1
1080i 50 (1125i 50)	–	28.13	50.00	1024 x 576	–	*1
1080i 50a (1250i 50)	–	31.25	50.00	1024 x 576	–	*1
480p (525p)	–	31.47	59.94	1024 x 768	–	*1
576p (625p)	–	31.25	50.00	1024 x 768	–	*1
720p 60 (750p 60)	–	45.00	60.00	1024 x 576	–	*1
720p 50 (750p 50)	–	37.50	50.00	1024 x 576	–	*1
PC98	640 x 400	24.82	56.42	1024 x 640	640 x 400	*2
CGA70	640 x 400	31.47	70.09	1024 x 640	640 x 400	*2
CGA84	640 x 400	37.86	84.13	1024 x 640	640 x 400	*2
CGA85	640 x 400	37.86	85.08	1024 x 640	640 x 400	*2
VGA60	640 x 480	31.47	59.94	1024 x 768	640 x 480	*2
VGA72	640 x 480	37.86	72.81	1024 x 768	640 x 480	*2
VGA75	640 x 480	37.50	75.00	1024 x 768	640 x 480	*2
VGA85	640 x 480	43.27	85.01	1024 x 768	640 x 480	*2
VGA120	640 x 480	61.89	120.17	1024 x 768	640 x 480	*2
SVGA56	800 x 600	35.16	56.25	1024 x 768	800 x 600	
SVGA60	800 x 600	37.88	60.32	1024 x 768	800 x 600	
SVGA72	800 x 600	48.08	72.19	1024 x 768	800 x 600	
SVGA75	800 x 600	46.88	75.00	1024 x 768	800 x 600	
SVGA85	800 x 600	53.67	85.06	1024 x 768	800 x 600	
SVGA95	800 x 600	59.97	94.89	1024 x 768	800 x 600	
SVGA120	800 x 600	77.11	119.93	1024 x 768	800 x 600	
XGA43i	1024 x 768	35.52	86.96	1024 x 768	1024 x 768	*2
XGA60	1024 x 768	48.36	60.00	1024 x 768	1024 x 768	
XGA70	1024 x 768	56.48	70.07	1024 x 768	1024 x 768	
XGA75	1024 x 768	60.02	75.03	1024 x 768	1024 x 768	
XGA85	1024 x 768	68.68	85.00	1024 x 768	1024 x 768	
XGA120	1024 x 768	98.58	119.78	1024 x 768	1024 x 768	
SXGA70a	1152 x 864	63.85	70.01	1024 x 768	1024 x 768	*2
SXGA75a	1152 x 864	67.50	75.00	1024 x 768	1024 x 768	*2
SXGA85a	1152 x 864	77.49	85.06	1024 x 768	1024 x 768	*2
SXGA60b	1280 x 960	60.00	60.00	1024 x 768	1024 x 768	*2
SXGA75b	1280 x 960	75.00	75.00	1024 x 768	1024 x 768	*2
SXGA43i	1280 x 1024	46.43	86.87	960 x 768	1024 x 768	*2
SXGA60	1280 x 1024	63.98	60.02	960 x 768	1024 x 768	*2
SXGA75	1280 x 1024	79.98	75.02	960 x 768	1024 x 768	*2
MAC13	640 x 480	35.00	66.67	1024 x 768	640 x 480	*2
MAC16	832 x 624	49.72	74.55	1024 x 768	832 x 624	*2
MAC19	1024 x 768	60.24	75.02	1024 x 768	1024 x 768	*2
MAC21	1152 x 870	68.59	74.96	1016 x 768	1024 x 768	*2
HP75	1024 x 768	62.94	74.92	1024 x 768	1024 x 768	*2
HP72	1280 x 1024	78.13	72.00	960 x 768	1024 x 768	*2
SUN66a	1152 x 900	61.85	66.00	984 x 768	1024 x 768	*2
SUN76a	1152 x 900	71.81	76.64	984 x 768	1024 x 768	*2
SUN66	1280 x 1024	71.68	66.68	960 x 768	1024 x 768	*2
SUN76	1280 x 1024	81.13	76.11	960 x 768	1024 x 768	*2
SGI72	1280 x 1024	76.92	72.30	960 x 768	1024 x 768	*2
SGI76	1280 x 1024	82.01	76.00	960 x 768	1024 x 768	*2
IBM60	1280 x 1024	63.42	60.00	960 x 768	1024 x 768	*2

*1 : The Expand mode and the PinP mode don't function with this signal.

The PinP mode don't function with this signal. When the EXPAND button on the remote control is pressed with EXPAND MODE in the FEATURE menu set to REAL, images are displayed in their original size. In the REAL mode, images are black-framed when the image resolution is lower than 1,024 x 768.

Important:

- Some computers aren't compatible with the projector.
- The projector's maximum resolution is 1,024 x 768 pixels. It may not display images of higher resolutions than 1,024 x 768 correctly.
- Images with SYNC on G (Green) signal may jitter.

- Images with SYNC on G (Green) signal may be tinged with green.
- If the resolution and frequency of your computer aren't shown on the table, find the compatible resolution and frequency by changing the resolution of your computer.
- Set COMPUTER INPUT in the SIGNAL menu to RGB when inputting the HDTV signal as RGB signal.
- In the case of SXGA, the right side of the image may not appear. In this case, adjust TRACKING in the SIGNAL menu.
- TV60 and TV50 are equivalent to 480i and 576i respectively. When these signals are supplied to the VIDEO or S-VIDEO signal, the signal mode is indicated as TV60 or TV50. When they are supplied to the COMPONENT terminal, the signal mode is indicated as 480i or 576i.

Specification of RGB signals in each computer mode of the projector (For SL4U)

Signal mode	resolution (H x V)	horizontal frequency (kHz)	Vertical frequency (Hz)	Normal mode (H x V)	Real mode (H x V)
TV60, 480i(525i)	–	15.73	59.94	800 x 600	–
TV50, 576i(625i)	–	15.63	50.00	800 x 600	–
1080i 60 (1125i 60)	–	33.75	60.00	800 x 450	–
1080i 50 (1125i 50)	–	28.13	50.00	800 x 450	–
1080i 50a (1250i 50)	–	31.25	50.00	800 x 450	–
480p (525p)	–	31.47	59.94	800 x 600	–
576p (625p)	–	31.25	50.00	800 x 600	–
720p 60 (750p 60)	–	45.00	60.00	800 x 450	–
720p 50 (750p 50)	–	37.50	50.00	800 x 450	–
PC98	640 x 400	24.82	56.42	800 x 500	640 x 400
CGA70	640 x 400	31.47	70.09	800 x 500	640 x 400
CGA84	640 x 400	37.86	84.13	800 x 500	640 x 400
CGA85	640 x 400	37.86	85.08	800 x 500	640 x 400
VGA60	640 x 480	31.47	59.94	800 x 600	640 x 480
VGA72	640 x 480	37.86	72.81	800 x 600	640 x 480
VGA75	640 x 480	37.50	75.00	800 x 600	640 x 480
VGA85	640 x 480	43.27	85.01	800 x 600	640 x 480
VGA120	640 x 480	61.89	120.17	800 x 600	640 x 480
SVGA56	800 x 600	35.16	56.25	800 x 600	800 x 600
SVGA60	800 x 600	37.88	60.32	800 x 600	800 x 600
SVGA72	800 x 600	48.08	72.19	800 x 600	800 x 600
SVGA75	800 x 600	46.88	75.00	800 x 600	800 x 600
SVGA85	800 x 600	53.67	85.06	800 x 600	800 x 600
SVGA95	800 x 600	59.97	94.89	800 x 600	800 x 600
SVGA120	800 x 600	77.11	119.93	800 x 600	800 x 600
XGA43i	1024 x 768	35.52	86.96	800 x 600	800 x 600
XGA60	1024 x 768	48.36	60.00	800 x 600	800 x 600
XGA70	1024 x 768	56.48	70.07	800 x 600	800 x 600
XGA75	1024 x 768	60.02	75.03	800 x 600	800 x 600
XGA85	1024 x 768	68.68	85.00	800 x 600	800 x 600
MAC13	640 x 480	35.00	66.67	800 x 600	640 x 480
MAC16	832 x 624	49.72	74.55	800 x 600	800 x 600
MAC19	1024 x 768	60.24	75.02	800 x 600	800 x 600
HP75	1024 x 768	62.94	74.92	800 x 600	800 x 600

*1 : The Expand mode don't function with this signal.

- When the EXPAND button on the remote control is pressed with EXPAND MODE in the FEATURE menu set to REAL, images are displayed in their original size. In the REAL mode, images are black-framed when the image resolution is lower than 800 x 600.

- TV60 and TV50 are equivalent to 480i and 576i respectively. When these signals are supplied to the VIDEO or S-VIDEO signal, the signal mode is indicated as TV60 or TV50. When they are supplied to the COMPONENT terminal, the signal mode is indicated as 480i or 576i.

Important:

- Some computers aren't compatible with the projector.
- The projector's maximum resolution is 800 x 600 pixels. It may not display images of higher resolutions than 800 x 600 correctly.
- Images with SYNC on G (Green) signal may jitter.
- Images with SYNC on G (Green) signal may be tinged with green.
- If the resolution and frequency of your computer aren't shown on the table, find the compatible resolution and frequency by changing the resolution of your computer.
- Set COMPUTER INPUT in the SIGNAL menu to RGB when inputting the HDTV signal as RGB signal.
- In the case of XGA, the right side of the image may not appear. In this case, adjust TRACKING in the SIGNAL menu.

MITSUBISHI Projector Contact Information

North America

MESCA (Mitsubishi Electric Sales Canada Inc.)
<http://www.mitsubishielectric.ca>
Information Technologies Group, 4299 14th Avenue, Markham, Ontario L3R 0J2, Canada

Sales Phone :+1-(905) 475-7728
Fax :+1-(905) 475-7958
E-mail :projectors@mitsubishielectric.ca
Technical Phone :+1-(905) 475-7728
Fax :+1-(905) 475-7958

Customer Care E-mail :support@mitsubishielectric.ca

MDEA (Mitsubishi Digital Electronics America, Inc.)
(Warranty Registration)
<http://www.mitsubishi-presentations.com/>
Presentation Products Division, 9351 Jeronimo Road, Irvine, CA 92618 U.S.A.

Phone Main Line :+1-(949) 465-6000
Technical :+1-(888) 307-0309
Product Information :+1-(888) 307-0312

Technical Support E-mail :tsupport@mdea.mea.com

Europe

MEU-FRA (Mitsubishi Electric Europe B.V French Branch)
25, Boulevard des Bouvets 92 741, Nanterre CEDEX, France

Sales Phone :+33 (0)1 55-68-55-07
Fax :+33 (0)1 55-68-57-31
Technical Phone :+33 (0)1 41-02-83-24
Fax :+33 (0)1 49-01-07-23

MEU-GER (Mitsubishi Electric Europe B.V. German Branch)
<http://www.mitsubishi-evs.de/>
Gothaer Strasse 8, 40880 Ratingen, Germany

MEU-IR (Mitsubishi Electric Europe B.V. Irish Branch)
<http://www.mitsubishi.ie/>
Westgate Business Park, Ballymount, Dublin 24, Ireland

Sales Phone :+353-(0)1- 4198844
Fax :+353-(0)1-4564422
Technical Phone :+353-(0)1-4198807
Fax :+353-(0)1-4198895

MEU-IT (Mitsubishi Electric Europe B.V. Italian Branch)
Centro Direzionale Colleoni, Palazzo Persero-Ingresso 2, Via Paracelso 12, 20041 Agrate Brianza, Italy

Sales Phone :+39-(0)39-60531
Fax :+39-(0)39-6053214
E-mail :info.projector@it.mee.com

MEU-NL (Mitsubishi Electric Europe B.V. Benelux Branch)
<http://www.mitsubishi.nl/LCD/ProdFrame.html>
Nijverheidsweg 23a, 3641 RP Mijdrecht, The Netherlands

Sales Phone :+31-297-282461
Fax :+31-297-283936
E-mail :info.lcd@nl.mee.com
Technical Phone :+31-297-282461
Fax :+31-297-283936
E-mail :info.lcd@nl.mee.com

MEU (MITSUBISHI ELECTRIC EUROPE B.V.)
<http://www.mitsubishi-projector.ru/>
Moscow Representative Office, 12/1 Goncharnaya St. 109240, Moscow, Russia

Sales Phone :+7 (095) 915 8602
Fax :+7 (095) 915 8603

MEU-SP (Mitsubishi Electric Europe B.V. Spanish Branch)
<http://www.mitsubishielectric.es/>
Ctra. de Rubi, 76-80, 08190 Sant Cugat del Valles, Barcelona, Spain

Sales Phone :+34-93.565.31.54
Fax :+34-93.589.43.88
E-mail :mitsubishi.profesional@sp.mee.com
Technical Phone :+34-93.586.27.51
Fax :+34-93.699.74.45
E-mail :mitsubishi.profesional@sp.mee.com

MEU-SWE (Mitsubishi Electric Europe B.V Scandinavian Branch)
Hammarbacken 14, Box 750, S-19127, Sollentuna, Sweden

Sales Phone :+46-(0)8-6251070
Fax :+46-(0)8-6251036
Technical Phone :+46-(0)8-6251052
Fax :+46-(0)8-6251036

MEU-UK (Mitsubishi Electric Europe)
<http://www.mitsubishi.co.uk/evs/>
Visual Information Systems Division, Travellers Lane, Hatfield, Hertfordshire, AL10 8XB

Phone :+44 (1707) 278684
Fax :+44 (1707) 278541
E-mail :projector.info@meuk.mee.com
Technical Phone :+44 (870) 606 5008
Fax :+44 (1506) 431927
E-mail :projector.info@meuk.mee.com

Russia (Mitsubishi Electric Europe B.V Moscow Representative Office)
52, bldg.5, Kosmodamianskaya Nab, 113054, Moscow, Russian Federation

Sales Phone :+7 (095) 721 2070
Fax :+7 (095) 721 2071
Technical Phone :+7 (095) 721 2070
Fax :+7 (095) 721 2071

Asia

RIL (Ryoden (Holdings) Ltd.)
<http://www.ryoden.com.hk>

• Hong Kong Office
15/F, Manulife Tower, 169 Electric Road, North Point, Hong Kong, China
Technical Support
Phone :+852 6510 1750
Fax :+852 2887 8027

• Beijing Office
9/F, Office Tower 1, Henderson Centre, 18 Jianguomennei Dajie, Dongcheng District, Beijing, 100005, China
Sales & Technical Support
Phone :+86 (10) 6518 2930
Fax :+86 (10) 6518 2530

• Shanghai Office
10/F, Shanghai Square Office Tower, 138 Huai Hai Zhong Road, Lu Wan District, Shanghai, 200021, China
Sales & Technical Support
Phone :+86 (21) 6327 2228
Fax :+86 (21) 6327 4918

• Shenzhen Office
Unit 01-04, 13/F, Building A, Tian An International Building, Renmin Road South, Shenzhen, 518005, China
Sales & Technical Support
Phone :+86 (755) 518 6386
Fax :+86 (755) 218 4775

• Chengdu Office
Block B-1, 23/F., Chuan Xin Mansion, 18 Section 2, Renmin Road South, Chengdu, 610016, China
Sales & Technical Support
Phone :+86 (28) 619 9730
Fax :+86 (28) 619 9801

REMECO (Ryoden Merchandising Co., Ltd.)

<http://www.mitsubishi-ryoden.com.hk>
Units 5-10, 20th Floor, Tower I, Ever Gain Plaza, 88 Container Port Road, Kwai Chung, N.T., Hong Kong, China

Sales Support Phone :+852 2510 2119
Fax :+852 2510 463
Technical Support Phone :+852 2510 2188

Sales & Technical Support E-mail :info.pav@remeco.meap.com

MEAP (Mitsubishi Electric Asia Pte Ltd)

<http://www.mitsubishielectric.com.sg>
307 Alexandra Road, Mitsubishi Electric Building, 289245, Singapore
Main Line Phone :+65 6 473 2308
Fax :+65 6 475 9503

Sales & Technical Support E-mail :peripherals@asia.meap.com

AMS (Antah Melco Sales & Services Sdn Bhd
(A Joint-Venture Company of Mitsubishi Electric Corporation))
<http://www.antahmelco.com.my>

6, Jalan 13/6, Petaling Jaya, Selangor Darul Ehsan, Malaysia
Main Line Phone :+603-7955 2088
Fax :+603-7956 3950
:+603-7958 2576

Technical Support
Phone :+603-7955 2088
E-mail :anmelco@po.jaring.my

Product Information
Phone :+603-7955 2088

ME-TWN (Mitsubishi Electric Taiwan Co., Ltd.)

<http://www.mitsubishi-electric.com.tw>
9th Floor., 90 Sec. 6, Chung Shan N. Rd., Taipei, Taiwan
Sales Support Phone :+886 (0) 2 2832 8255
Fax :+886 (0) 2 2833 9813

KYW (Kang Yong Watana Co., Ltd.)
<http://www.mitsubishi-kyw.in.th>
28 Krungthep Kreetha Road, Huamark Bangkok, Bangkok, 10240, Thailand
Sales Support Phone :+66 (2) 731 6901
Fax :+66 (2) 379 4763

STC (Setsuyo Trading Co.Ltd. Seoul Branch)
Dongseo Game Channel Bldg, 660-11, Deungchon-dong, Kangseo-ku, Seoul, Korea
Main Line Phone :+82 (0) 2 3665 4964
Fax :+82 (0) 2 3665 4965

Oceania

ME-AUST (Mitsubishi Electric Australia)
<http://www.mitsubishi-electric.com.au/prod.asp?prod=proj>
348 Victoria Road, Rydalmere, N.S.W. 2116, Australia

Sales Phone :+(612)9684-7777
Fax :+(612)9898-0484
E-mail :ped@meaust.meap.com

MENZ (BDT Ltd)
(Warranty Registration) <http://www.bdt.co.nz/projectors/warranty.asp>
1 Parliament St., Lower Hutt, Wellington, New Zealand

Sales Phone :+64-(0)4-560-9100
Fax :+64-(0)4-560-9133
E-mail :help@bdt.co.nz
Technical Phone :+64-(0)4-560-9100
Fax :+64-(0)4-560-9133

Manufactured by Mitsubishi Electric Corporation
1 Zusho Baba, Nagaokakyo-City, Kyoto Japan

 **MITSUBISHI ELECTRIC CORPORATION**



Disclaimer

This user manual is provided as a free service by FixYourDLP.com. FixYourDLP is in no way responsible for the content of this manual, nor do we guarantee its accuracy. FixYourDLP does not make any claim of copyright and all copyrights remain the property of their respective owners.

About FixYourDLP.com

FixYourDLP.com (<http://www.fixyourdpl.com>) is the World's #1 resource for media product news, reviews, do-it-yourself guides, and manuals.

Informational Blog: <http://www.fixyourdpl.com>

Video Guides: <http://www.fixyourdpl.com/guides>

User Forums: <http://www.fixyourdpl.com/forum>

FixYourDLP's Fight Against Counterfeit Lamps:

<http://www.fixyourdpl.com/counterfeits>

Sponsors:

RecycleYourLamp.org – Free lamp recycling services for used lamps:

<http://www.recycleyourlamp.org>

Lamp Research - The trusted 3rd party lamp research company:

<http://www.lampresearch.com>

Discount-Merchant.com – The worlds largest lamp distributor:

<http://www.discount-merchant.com>



FixYourDLP.com

Sponsored by 