



# Disclaimer

This user manual is provided as a free service by FixYourDLP.com. FixYourDLP is in no way responsible for the content of this manual, nor do we guarantee its accuracy. FixYourDLP does not make any claim of copyright and all copyrights remain the property of their respective owners.

About FixYourDLP.com

FixYourDLP.com (<http://www.fixyourdpl.com>) is the World's #1 resource for media product news, reviews, do-it-yourself guides, and manuals.

Informational Blog: <http://www.fixyourdpl.com>

Video Guides: <http://www.fixyourdpl.com/guides>

User Forums: <http://www.fixyourdpl.com/forum>

FixYourDLP's Fight Against Counterfeit Lamps:

<http://www.fixyourdpl.com/counterfeits>

## Sponsors:

RecycleYourLamp.org – Free lamp recycling services for used lamps:

<http://www.recycleyourlamp.org>

Lamp Research - The trusted 3rd party lamp research company:

<http://www.lampresearch.com>

Discount-Merchant.com – The worlds largest lamp distributor:

<http://www.discount-merchant.com>



**FixYourDLP.com**

Sponsored by 



# LCD Projector User Manual

ENGLISH

FRANÇAIS

DEUTSCH

ITALIANO

ESPAÑOL

中文



**Discount-Merchant.com (800) 281-8860**

**THE TRUSTED SOURCE FOR PROJECTOR LAMPS AND ACCESSORIES**

MODEL XL1U

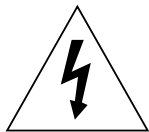
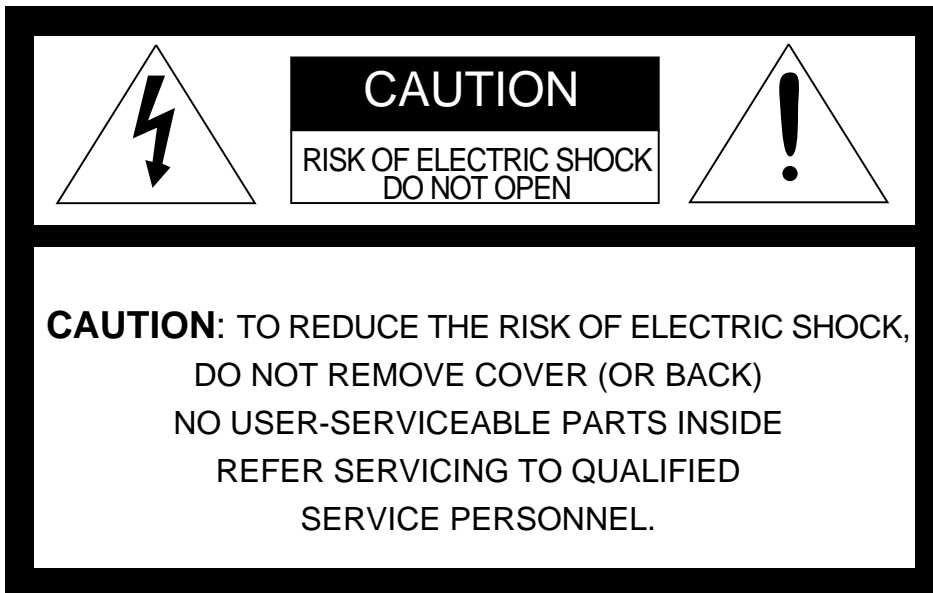

The lightning flash with arrowhead symbol, within an equilateral triangle, is intended to alert the user to the presence of uninsulated “dangerous voltage” within the product’s enclosure that may be of sufficient magnitude to constitute a risk of electric shock.



The exclamation point within an equilateral triangle is intended to alert the user to the presence of important operating and maintenance (servicing) instructions in the literature accompanying the appliance.

## **WARNING:**

TO PREVENT FIRE OR SHOCK HAZARD, DO NOT EXPOSE THIS APPLIANCE TO RAIN OR MOISTURE.

## **CAUTION:**

TO PREVENT ELECTRIC SHOCK, DO NOT USE THIS (POLARIZED) PLUG WITH AN EXTENSION CORD, RECEPTACLE OR OTHER OUTLET UNLESS THE BLADES CAN BE FULLY INSERTED TO PREVENT BLADE EXPOSURE.

## **NOTE:**

SINCE THIS PROJECTOR IS PLUGGABLE EQUIPMENT, THE SOCKET-OUTLET SHALL BE INSTALLED NEAR THE EQUIPMENT AND SHALL BE EASILY ACCESSIBLE.

### **WARNING**

Use the attached specified power supply cord. If you use another power-supply cord, it may cause interference with radio and television reception.

Use the attached RGB cable, RS-232C cable with this equipment so as to keep interference within the limit of a FCC Class B device.

apparaturs must be grounded.

**DO NOT LOOK DIRECTLY INTO THE LENS WHEN PROJECTOR IS IN THE POWER ON MODE.**

### **When using the projector in Europe COMPLIANCE NOTICE**

This LCD - Video Projector complies with the requirements of the EC Directive 89/336/EEC “EMC Directive” as amended by Directive 93/68/EEC and 73/23/EEC “Low Voltage Directive” as amended by Directive 93/68/EEC.

The electro-magnetic susceptibility has been chosen at a level that gains proper operation in residential areas, on business and light industrial premises and on small-scale enterprises, inside as well as outside of the buildings. All places of operation are characterised by their connection to the public low voltage power supply system.

### **WARNING**

Use the attached RGB cable or RS-232C cable with this equipment so as to keep interference within the limits of a EN55022 Class B. Please follow WARNINGS instructions.

Important safeguards .....	4
Overview .....	6
Using the remote control .....	8
Battery installation .....	8
Installation .....	9
Basic connections .....	10
Projector + AV equipment.....	10
Projector + DVD player or HDTV decoder .....	10
Projector + personal computer .....	11
Preparing the projector for operation .....	12
To operate projector power ON .....	13
Menu operation .....	15
Picture adjustment.....	18
Advanced feature for presentation .....	20
Expand .....	20
Still .....	20
Mouse remote control .....	21
Lamp replacement .....	22
Maintenance .....	23
Troubleshooting .....	24
Indicators .....	25
Specifications .....	26
Kensington Lock .....	26
Connectors .....	27
Dimensional drawings .....	27
What's included in the box .....	27
Replacement part .....	27
Specification of RGB signals in each computer mode of the projector .....	28



**Discount-Merchant.com (800) 281-8860**  
**THE TRUSTED SOURCE FOR PROJECTOR LAMPS AND ACCESSORIES**

### Trademark, Registered trademark

Windows 98 and Windows 95 are registered trademarks of Microsoft in the U.S. and other countries.

Macintosh is registered trademark of Apple Computer Inc.

IBM and PS/2 are trademarks or registered trademarks of International Business Machines Corporation.

MicroSaver and Kensington are registered trademarks of Kensington Technology Group.

Other brand or product names are trademarks or registered trademarks of their respective holders.

# Important safeguards

Please read all these instructions regarding your LCD projector and retain them for future reference. Follow all warnings and instructions marked on the LCD projector.

1. **Read instructions**  
All the safety and operating instructions should be read before the appliance is operated.
2. **Retain instructions**  
The safety and operating instructions should be retained for future reference.
3. **Warnings**  
All warnings on the appliance and in the operating instructions should be adhered to.
4. **Instructions**  
All operating instructions must be followed.
5. **Cleaning**  
Unplug this projector from the wall outlet before cleaning it. Do not use liquid aerosol cleaners. Use a damp soft cloth for cleaning.
6. **Attachments and equipment**  
Never add any attachments and/or equipment without the approval of the manufacturer as such additions may result in the risk of fire, electric shock or other personal injury.
7. **Water and moisture**  
Do not use this projector near water or in contact with water.
8. **Accessories**  
Do not place this projector on an unstable cart, stand, tripod, bracket or table. Use only with a cart, stand, tripod bracket, or table recommended by the manufacturer or sold with the projector. Any mounting of the appliance should follow the manufacturer's instructions and should use a mounting accessory recommended by the manufacturer.



An appliance and cart combination should be moved with care. Quick stops, excessive force and uneven surfaces may cause the appliance and cart combination to overturn.

9. **Ventilation**  
Slots and openings in the cabinet are provided for ventilation, ensuring reliable operation of the projector and to protect it from overheating. Do not block these openings or allow them to be blocked by placing the projector on a bed, sofa, rug, or bookcase. Ensure that there is adequate ventilation and that the manufacturer's instructions have been adhered to.

10. **Power sources**  
This projector should be operated only from the type of power source indicated on the marking label. If you are not sure of the type of power, please consult your appliance dealer or local power company.
11. **Power-cord protection**  
Power-supply cords should be routed so that they are not likely to be walked on or pinched by items placed upon or against them. Pay particular attention to cords at plugs, convenience receptacles, and points where they exit from the appliance. Do not put the power cord under a carpet.
12. **Overloading**  
Do not overload wall outlets and extension cords as this can result in a fire or electric shock.
13. **Objects and liquids**  
Never push objects of any kind through openings of this projector as they may touch dangerous voltage points or short-out parts that could result in a fire or electric shock. Never spill liquid of any kind on the projector.
14. **Servicing**  
Do not attempt to service this projector yourself. Refer all servicing to qualified service personnel.
15. **Damage requiring service**  
Unplug this projector from the wall outlet and refer servicing to qualified service personnel under the following conditions:
  - (a) If the power-supply cord or plug is damaged.
  - (b) If liquid has been spilled, or objects have fallen into the projector.
  - (c) If the projector does not operate normally after you follow the operating instructions. Adjust only those controls that are covered by the operating instructions. An improper adjustment of other controls may result in damage and may often require extensive work by a qualified technician to restore the projector to its normal operation.
  - (d) If the projector has been exposed to rain or water.
  - (e) If the projector has been dropped or the cabinet has been damaged.
  - (f) If the projector exhibits a distinct change in performance - this indicates a need for service.
16. **Replacement parts**  
When replacement parts are required, be sure that the service technician has used replacement parts specified by the manufacturer or parts having the same characteristics as the original part. Unauthorized substitutions may result in fire, electric shock or other hazards.
17. **Safety check**  
Upon completion of any service or repair to this projector, ask the service technician to perform safety checks determining that the projector is in a safe operating condition.

**WARNING:****Unplug immediately if there is something wrong with your projector.**

Do not operate if smoke, strange noise or odor comes out of your projector. It might cause fire or electric shock. In this case, unplug immediately and contact your dealer.

**Never remove the cabinet.**

This projector contains high voltage circuitry. An inadvertent contact may result in an electric shock. Except as specifically explained in the Owner's Guide, do not attempt to service this product yourself. Please contact your dealer when you want to fix, adjust or inspect the projector.

**Do not modify this equipment.**

It can lead to fire or electric shock.

**If you break or drop the cabinet.**

Do not keep using this equipment if you break or drop it. Unplug the projector and contact your dealer for inspection. It may lead to fire if you keep using the equipment.

**Do not face the projector lens to the sun.**

It can lead to fire.

**Use correct voltage.**

If you use incorrect voltage, it can lead to fire.

**Do not place the projector on uneven surface.**

Place the projection on a leveled and stable surface only. Please do not place equipment on unstable surfaces.

Do not look into the lens when it is operating. It may hurt your eyes.

Never let children look into the lens when it is on.

**Do not turn off the main power abruptly or unplug the projector during operation.**

It can lead to lamp breakage, fire, electric shock or other trouble. It is best to wait for the fan to turn off before turning main power off.

**Do not touch Air outlet grille and Bottom plate which becomes hot.**

Do not touch them or put other equipment in front of Air outlet grille. The heated Air outlet grille and Bottom plate may cause injury or damage to other equipment.

Also, do not set the projector on the desk which is easily affected by heat.

**Clean the air-filter once a month.**

Clean the air-filter frequently. If the filter or ventilation slots become clogged with dirt or dust, the temperature inside of the projector may rise and cause some troubles, such as damage of inside parts, and shortening the life of panel.

**Do not look into the air outlet grille when projector is operating.**

Heat, dust etc. may blow out of it and hurt your eyes.

**Place of installation**

For safety's sake, refrain from setting the projector at any place subjected to high temperature and high humidity. Please maintain an operating temperature, humidity, and altitude as specified below.

- Operating temperature: between +41°F (+5°C) and +95°F (+35°C)
- Operating humidity: between 30 and 90%
- Never put any heat-producing device under the projector so that the projector does not overheat.
- Do not attach the projector to a place that is unstable or subject to vibration.
- Do not install the projector near any equipment that produces a strong magnetic field. Also refrain from installing near the projector any cable carrying a large current.
- Place the projector on a solid, vibration free surface: otherwise it may fall, causing serious injury to a child or adult, and serious damage to the product.
- Do not stand the projector: it may fall, causing serious injury and damage to the projector.
- Slanting the projector more than  $\pm 10^\circ$  (right and left) or  $\pm 15^\circ$  (front and rear) may cause trouble or explosion of the lamp.
- Do not place the projector near air-conditioning unit or heater to avoid hot air to the exhaust and ventilation hole of the projector.

**COMPLIANCE NOTICE OF FCC**

This equipment has been tested and found to comply with the limits for a Class B digital device, pursuant to Part 15 of the FCC Rules. These limits are designed to provide reasonable protection against harmful interference in a residential installation. This equipment generates, uses and can radiate radio frequency energy and, if not installed and used in accordance with the instructions, may cause harmful interference to radio communications. However, there is no guarantee that interference will not occur in a particular installation. If this equipment does cause harmful interference to radio or television reception, which can be determined by turning the equipment off and on, the user is encouraged to try to correct the interference by one or more of the following measures:

- Reorient or relocate the receiving antenna.
- Increase the separation between the equipment and receiver.
- Connect the equipment into an outlet on a circuit different from that to which the receiver is connected.
- Consult the dealer or an experienced Radio / TV technician for help.

Changes or modifications not expressly approved by Mitsubishi could void the user's authority to operate this equipment.

**COMPLIANCE NOTICE OF INDUSTRY CANADA**

This Class B digital apparatus complies with Canadian ICES-003.

# Overview

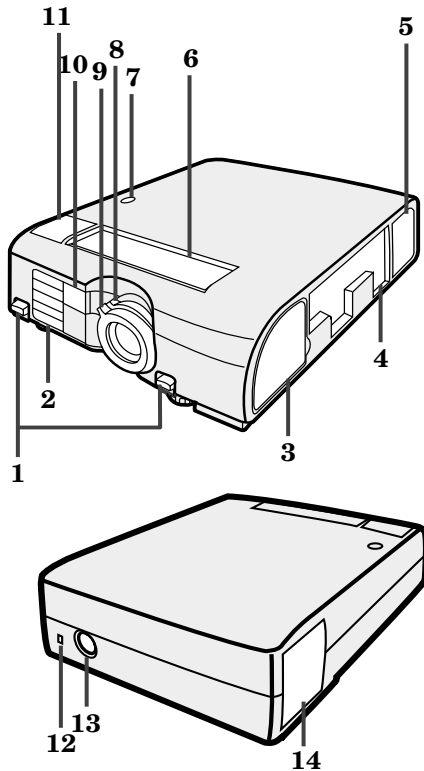

- 1 Front height adjuster buttons
- 2 Air outlet grille (Front)
- 3 Air inlet grille (Side-Front)
- 4 Terminal board
- 5 Air inlet grille (Side-Rear)
- 6 Control panel
- 7 IRIS sensor
- 8 Zoom ring
- 9 Focus ring
- 10 Remote control sensor (Front)
- 11 Speaker
- 12 Kensington Security Lock Standard connector
- 13 Remote control sensor (Rear)
- 14 Air outlet grille (Side-Rear)

## Control panel

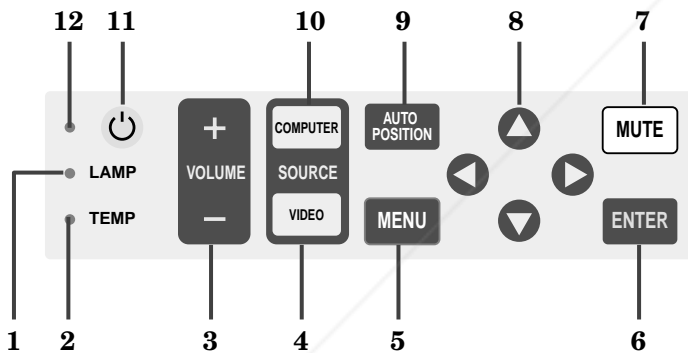

- 1 LAMP indicator
- 2 TEMP (temperature) indicator
- 3 +, - (VOLUME) button
- 4 VIDEO button
- 5 MENU button
- 6 ENTER button
- 7 MUTE button (Audio/Video)
- 8 Direction buttons
- 9 AUTO POSITION button
- 10 COMPUTER button
- 11 Power button
- 12 Power indicator

## Terminal board

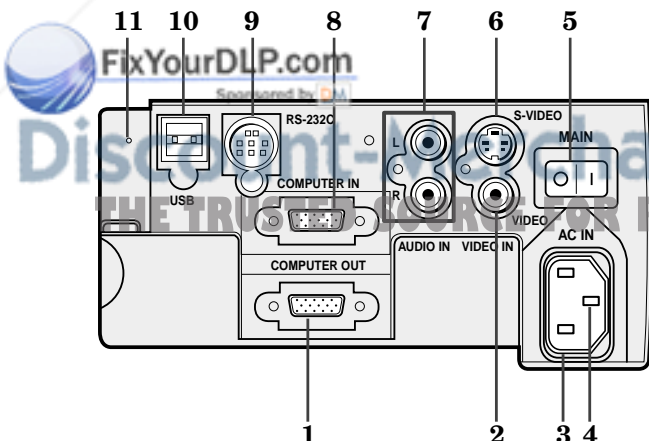

- 1 COMPUTER OUT terminal (D-SUB mini 15P)
- 2 Video input terminal
- 3 Power jack
- 4 Ground terminal
- 5 Main power  
I: ON  
O: OFF
- 6 S-video input terminal
- 7 Audio input terminals
- 8 COMPUTER IN terminal (D-SUB mini 15P)
- 9 RS-232C (DIN 8P) terminal
- 10 USB terminal
- 11 Reset button

## Bottom side

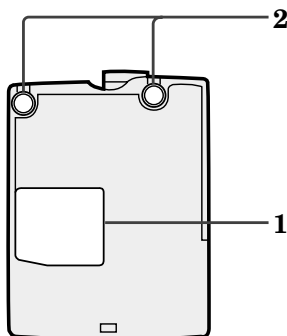

- 1 Lamp cover
- 2 Adjustment foot

### Caution:

Do not replace the lamp right after using the projector. The lamp is very hot.

## Remote control

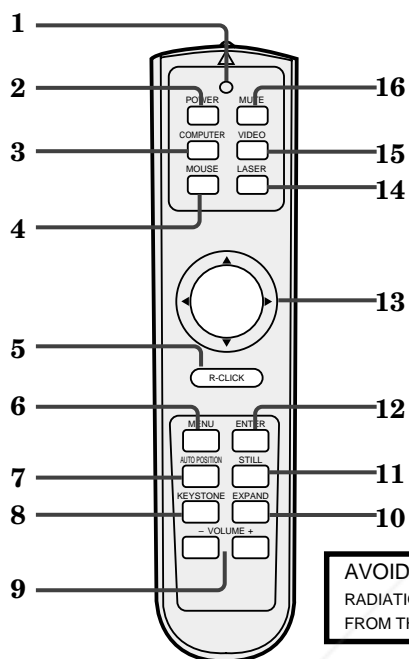

- 1 Transmitter indicator
- 2 Power button
- 3 COMPUTER button
- 4 Mouse button
- 5 Right click button (For mouse)
- 6 MENU button
- 7 AUTO POSITION button
- 8 KEYSTONE button
- 9 +, - (VOLUME) buttons
- 10 EXPAND button
- 11 STILL button
- 12 ENTER button
- 13 Mouse pointer / Direction buttons
- 14 LASER button
- 15 VIDEO button
- 16 MUTE button (Audio/Video)
- 17 Laser aperture
- 18 Left click button (For mouse)

- When pressing Mouse button, it illuminates and Direction buttons work as the mouse pointer. Press the Mouse button or MENU button to set off. (Direction buttons work as Direction buttons.)
- Pressing LASER button emits the laser beam about 1 minute. Release LASER button and press it again if you wish to emits the laser beam.

AVOID EXPOSURE -LASER  
RADIATION IS EMITTED  
FROM THIS APERTURE.



### About laser beam

This remote control is class 2 (max. output 1 mW laser diode 640 - 660 nm) laser equipment.  
Beam Divergence : 6m distance about 10mm x 10mm (±6mm)

### CAUTION

LASER RADIATION  
DO NOT STARE INTO BEAM



WAVE LENGTH : 640 - 660 nm  
MAX OUTPUT : 1 mW  
CLASS 2 LASER PRODUCT  
IEC 60825-1:1993+A1:1997

### CAUTION:

- Pressing the LASER button provided remote control emits laser beam. Do not look into the beam light directly. Do not point the laser beam at people. Looking the laser beam directly may damage eyesight.
- Use of controls or adjustments or procedures other than those specified herein may result in hazardous radiation exposure.



# Using the remote control

## Battery installation

Use two AAA size batteries.

1. Remove the back cover of the remote control by pushing the battery compartment door in the direction of the arrow.
2. Load the batteries making sure that they are positioned correctly (+ to +, and - to -).
  - Load the batteries from - spring side, and make sure to set them tightly.
3. Replace the back cover.

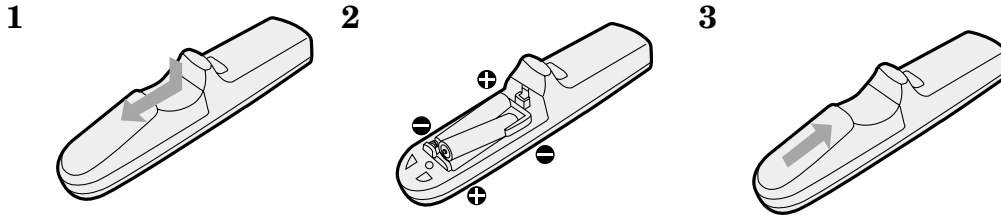

### Important:

- Do not combine a new battery with an old one.
- Load batteries in the correct position.
- Do not heat, take apart, or throw batteries into fire.
- Do not try to recharge batteries. Do not use rechargeable batteries.
- If the solution of batteries comes in contact with your skin or clothes, rinse with water. If the solution comes in contact with your eyes, rinse them with water and then consult your doctor.

## Operation area

The range for operation is about 10 m (33 feet) when the remote control points to the projector. The distance to the screen back to the projector must be less than 6 m (20 feet). Depending on the type of the screen, the distance is different.

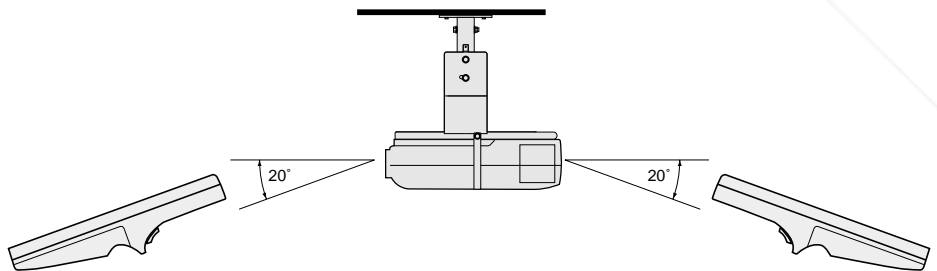
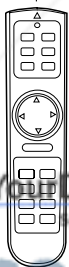
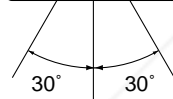
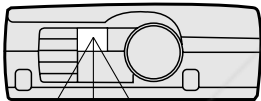
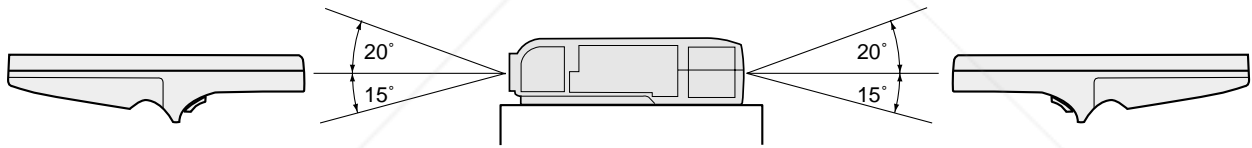

Discount-Merchant.com (800) 281-8860  
THE TRUSTED SOURCE FOR PROJECTOR LAMPS AND ACCESSORIES

### Important:

Avoid the direct sunlight or fluorescent light to the remote control sensor. Also keep the distance of more than 2 m between the remote control sensor and fluorescent lamp on the remote control may not work correctly.

# Installation

## Orientation of the projector

Picture size can be set by changing the distance between the screen and the projector.

### Front projection

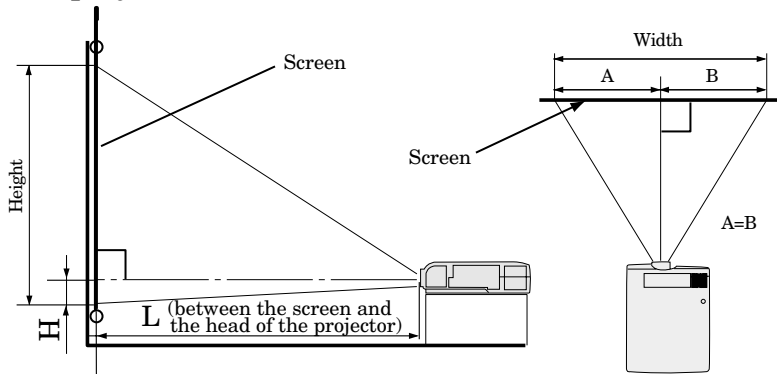

To find the approximate distance between the projector and screen: Multiply the width of the screen x 1.8 (min.), Multiply the width of the screen x 2.2 (max.).

- Refer to the chart for recommended distances in maximum zoom and minimum zoom.

Screen			Distance from screen (L) / (approximate)				Height projected image (H)	
Diagonal size (inch)	Height (inch)	Width (inch)	Maximum zoom (WIDE)		Minimum zoom (TELE)		(cm)	(inch)
			(m)	(inch)	(m)	(inch)		
30 "	18 "	24 "	—	—	1.3	52 "	4.6	1.8 "
40 "	24 "	32 "	1.5	59 "	1.8	70 "	6.1	2.4 "
60 "	36 "	48 "	2.3	89 "	2.7	106 "	9.1	3.6 "
80 "	48 "	64 "	3.0	119 "	3.6	142 "	12.2	4.8 "
100 "	60 "	80 "	3.8	149 "	4.5	178 "	15.2	6.0 "
150 "	90 "	120 "	5.7	224 "	6.8	268 "	22.9	9.0 "
200 "	120 "	160 "	7.6	299 "	9.1	358 "	30.5	12.0 "
250 "	150 "	200 "	9.5	374 "	11.4	448 "	38.1	15.0 "
300 "	180 "	240 "	11.4	449 "	13.6	537 "	45.7	18.0 "

- The above numbers are approximate, and may be slightly different from the actual measurements.

### Front projection, ceiling mount

For ceiling mount, you need the ceiling mount kit. Ask a specialist for installation. For more details, consult your dealer.

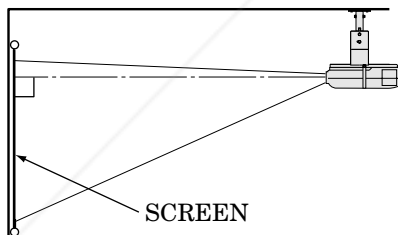

- When using the ceiling mount, set IMAGE REVERSE in the INSTALLATION menu to MIRROR INVERT. See Page 16.
- Projected images may appear darker when the unit is used as a ceiling installation than when it is used in the tabletop position. This does not signify a product malfunction.

### Rear projection

Ask a specialist for installation. For more details, consult your dealer.

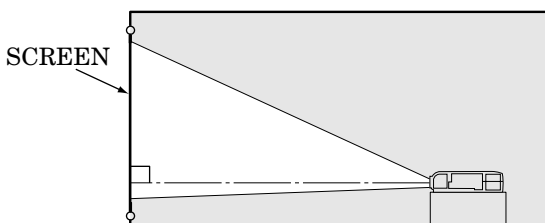

- For rear projection, set IMAGE REVERSE in the INSTALLATION menu to MIRROR. See Page 16.

### Caution:

- Placing the projector on a carpet reduces ventilation from the fan at the bottom and might cause problems. Place a hard board or similar item under the projector to facilitate ventilation of the unit.
- Place the projector more than 50cm (20 in.) from the wall to prevent blocking the intake, exhaust slots and ventilation of this projector because hot air comes out of it.
- Do not use the projector under the following circumstances, which may cause fire or electric shock.
  - in a dusty or humid place
  - while the projector is lying sideways or upside down
  - near a heater
  - in a kitchen or oily, smoky or damp place
  - in direct sunlight
  - with high temperature, such as the closed car
  - where the temperature is lower than +41°F (+5°C) or higher than +95°F (+35°C)

### Important:

- Do not put stress on the lens, as this may cause damage.

# Basic connections

This projector can be connected to equipment such as PC, VCRs, video cameras and DVD players.

## Important:

- Make sure that your equipment is turned off before connection.
- Plug in firmly and unplug by holding the plug, not by pulling the AC power cord.
- If connected units are set too close to one another, the image may be affected.
- Refer to the user manual of each component for details of connections.

## Projector + AV equipment

### Important:

- Match the color of video and audio plugs on the AV cable with the connections.

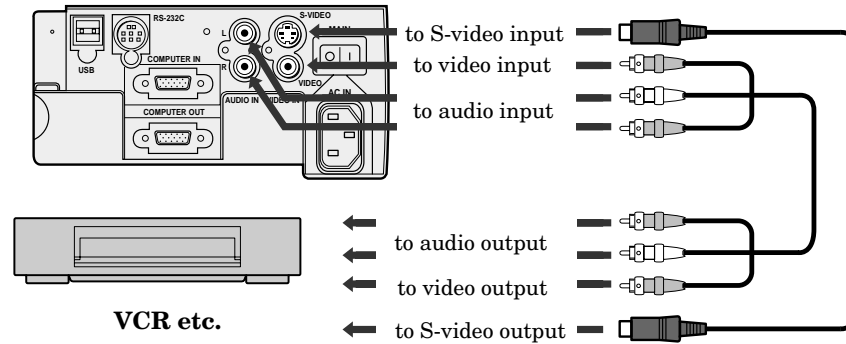

- Speaker output is mono.
- Select AUDIO MODE VIDEO to hear and to sound for the VIDEO. (Refer to page 16).

## Projector + DVD player or HDTV decoder

Some DVD players have output terminal for 3 line fitting (Y, C<sub>B</sub>, C<sub>R</sub>). When connecting them to the projector, connect to COMPUTER IN of the projector.

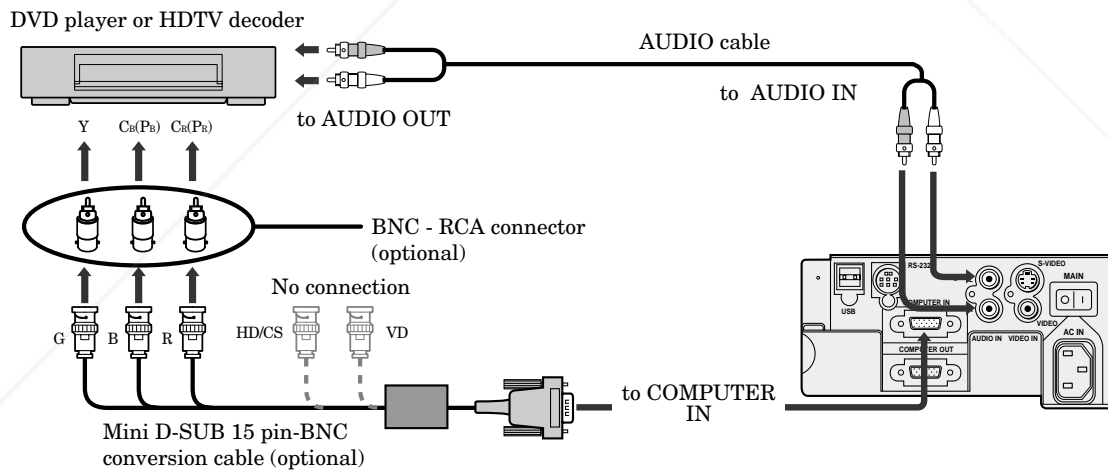

Y, C<sub>B</sub>, C<sub>R</sub> is an example of the terminal names for a HDTV decoder.

The terminal name is different depending on the connected equipment.

- Use mini D-SUB 15 pin-BNC conversion cable for connection.
- Some DVD players may not project the image correctly.
- When connecting with HDTV equipment which has R, G, B output, set RGB for the COMPUTER INPUT in the SIGNAL setting menu.
- Change the setting in the SIGNAL menu, when 525p signal is inputted. (Refer to page 28).

## Projector + Personal computer

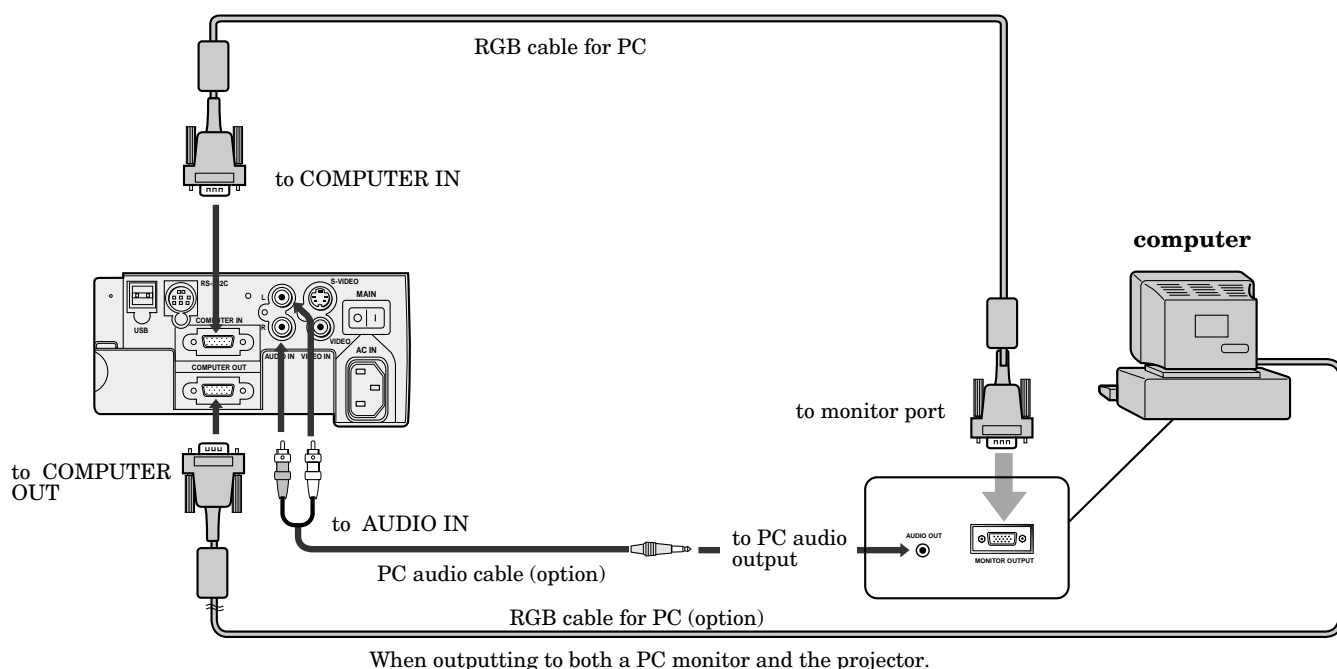

### Important:

- When you use a long RGB cable instead of the cable provided, the picture quality may be deteriorated.
- Connectors or analog RGB output adapters may be necessary depending on the PC connected to this projector. Please contact your dealer.
- The audio input for this projector is a stereo pin jack. (Speaker output is mono.) Please check the available cable for the audio input terminal of the PC. Some personal computer may not have the audio output terminal.
- Select AUDIO MODE COMPUTER to hear and to sound for the COMPUTER. (Refer to page 16).

### For using Macintosh

- A monitor output adapter is necessary for a Macintosh if it has no video port. Please contact your dealer.
- A MAC adapter for RGB cable may be necessary depending on the personal computer connected to this projector. Please contact your dealer.

# Preparing the projector for operation

## Getting ready for projection

1. Connect the power cord provided to the projector.
2. Connect the power cord to the wall power outlet.
3. Remove the lens cap.

### Warning:

- Do not look directly into the lens when projector is "ON".
- The lens cap is for protecting the lens. If you leave the power on with the cap on, the cap may be warped. Please remove the lens cap when you turn the power on.
- This projector is equipped with the power cords for both U.S. and Europe. Use the appropriate power cord for your country.
- A three-pin grounding type power plug is used with the projector. Do not remove the grounding pin on the power plug. If you are unable to insert the plug into the outlet, contact your electrician to replace your A/C outlet.
- The supplied power cord for U.S. is used for 120V only. Never connect to any outlet or power supply having a different voltage or frequency. If you connect to the power supply having a different voltage, please use the appropriate power cord.
- Use 100-240V AC 50/60Hz correct voltage otherwise it may lead to fire or electric shock.
- Do not place any objects on the power cord, and keep the projector away from heat sources to avoid breaking the power cord. A broken power cord can cause fire or electric shock.
- Do not revise or alter the power cord otherwise it may cause fire or electric shock. Contact your dealer if the cord is broken.

### Caution:

- Plug in firmly and unplug by holding the plug, not by pulling the cable out.
- Do not plug in or out with wet hands. It may cause an electric shock.

## Adjusting the angle of projection

For the best result, project onto a flat screen with a 90 degree angle to the floor. If necessary, tilt the projector by adjusting two foot adjustments on the bottom of the projector.

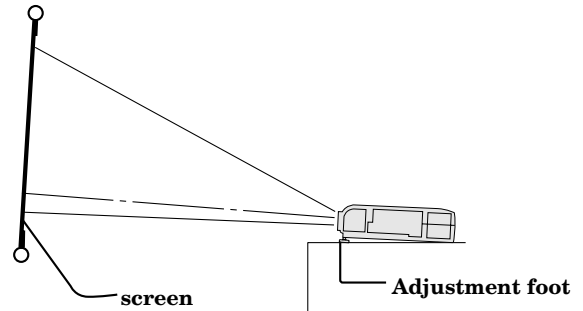

1. Lift the projector to the appropriate angle.
2. Press the buttons by the projector's adjustable front feet, this will allow the feet to slide out to the approximate position.
3. Release the foot adjustment buttons to lock the feet in that position.
4. Rotate the projector feet for fine adjustment.

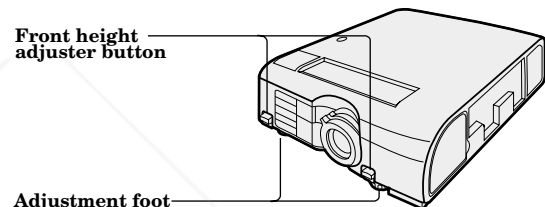

After using the projector

5. Return the adjustable feet into the projector.

### Important:

- The image becomes trapezoid shape when the screen or project is not level. Use KEYSTONE button and +, - buttons (or ▲, ▼ buttons) on the remote control to adjust, however, the circumference of the image may not be focused.
- When the KEYSTONE adjustment is carried out for a wide image such as a squeezed image, 1080i image, and 720p image, the size of the displayed image will be smaller.
- Screen on a flat wall with a 90° angle to the floor.
- Align projector to produce a full screen display as illustrated on page 9.
- The distance from the projector to the screen must be compatible with screen size chart on page 9. Note the distance from the screen chart.

# To operate projector power ON

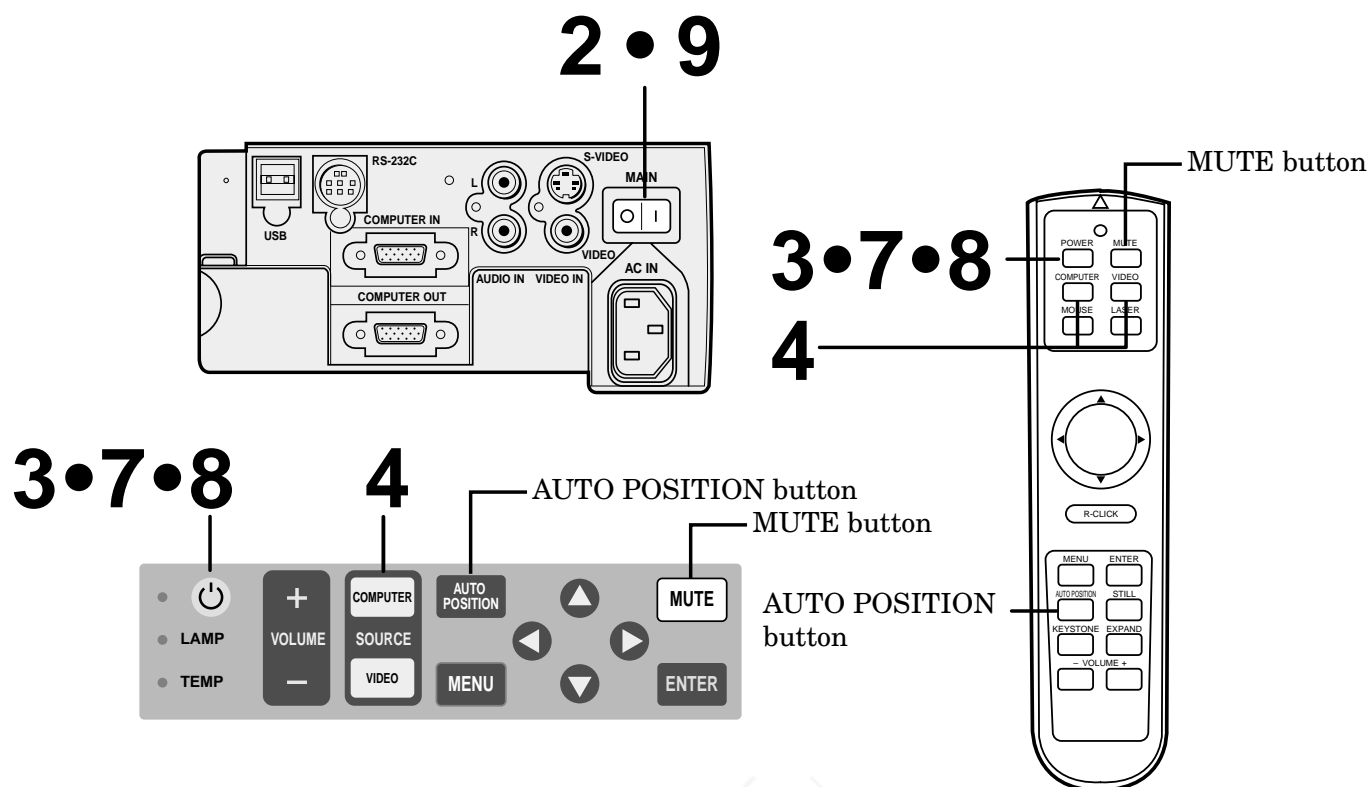

1. Turn on the equipment connected to the projector.
2. Put the projector into standby mode by pressing the main power switch. The POWER indicator lights up red.
3. Turn the projector on by pressing the POWER button. The light source lamp starts warming up, eventually turning completely on.
  - When the light source lamp does not light up, wait until the LAMP indicator is turned off, then press the POWER button again.
  - If the main power switch to the unit is turned off within two minutes of turning off the light source lamp, power will not be applied to the lamp for one minute when the next time the main unit power switch is turned on. When this happens, the indicator lamp will blink for one minute.

- When the lamp indicator is blinking red, the lamp should be replaced. Replace the lamp. See pages 22 and 25.
  - The picture might not be of optimum performance in extreme hot or cold conditions. (The projector is not malfunctioning.)
4. Select the desired external input source by using the COMPUTER or VIDEO buttons.
    - Pressing the VIDEO button repeatedly will select VIDEO IN and S-VIDEO IN.
    - The COMPUTER or VIDEO buttons do not work when MENU is displayed. At this time, the prohibition mark (⊘) appears on the screen.
    - The projector automatically selects the appropriate signal format. The selected signal format is displayed on the screen.
    - When selecting the COMPUTER input, the image may flicker. Press the ◀ or ▶ button to adjust the image.
    - The brightness of the lamp will be STANDARD for 3 minutes regardless of the setting of the LAMP MODE when the lamp turns on.
  5. Adjust the image size with the zoom ring by turning it.
  6. Adjust the focus with the focus ring by turning it.

Condition	Indicator	LAMP	POWER
Stand-by		-	Red
When light source lamp is on		Green	Green
Light source lamp held off temporarily		-	Red

- Important:**
- A darkened image may be seen right after pressing the POWER button due to warming up of this projector. While warming up, no other commands can be accepted.
  - After the power is turned on or the LAMP MODE is changed, the screen may flicker before the lamp operation becomes stable. This is due to the characteristics of the lamp, not a failure of the lamp.

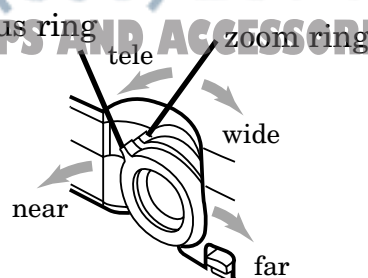

## To operate projector power ON (Continue)

### Turning off the projector

7. Press the POWER button.  
The message "POWER OFF? YES : PRESS AGAIN" appears on the screen.
  - To exit from this mode, press any button except POWER, LASER, mouse pointer, R/L-click, STILL and VOLUME + and - buttons.
8. Press the POWER button again.  
The light source lamp will be turned off.  
Pressing the POWER button second time will shut off the light source lamp, but the exhaust fan continues to operate for 60 seconds to cool down the light source lamp and LCD panels. In this time, the lamp indicator will be turned off.
9. Turn off the main power switch. When turning off the main switch, the POWER indicator turns off.
  - In cases where the main power switch is accidentally turned off when either the intake/exhaust fan or the power source lamp is in operation, allow the unit to cool down for 10 minutes with the power turned off. Repeat step 3 when turning on the power source lamp. If the lamp does not turn on immediately, repeat this step two or three times. Replace the lamp if it should still fail to turn on.

### AUTO POSITION button

When the source is selected to COMPUTER and the image is not in the right place, follow as shown below.

1. Set screen to the brightest display as possible (e.g., full-screen display of the "Trash" window).
2. If the screen saver is running, turn off the screen saver.
3. Press the AUTO POSITION button.
  - If the image is still not in the right place, adjust the image position by using the SIGNAL menu.

### The sound from the speaker

The sound from the speaker is mono.

- The output sound is selected by changing the setting of AUDIO MODE in the FEATURE menu. See page 16 for details.

### The volume from the speaker

Press the volume + or - button to change the volume from the speaker.

The volume control bar will appear on the screen.

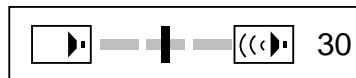

- The volume control bar will disappear about 4 seconds after releasing the volume buttons.
- The volume buttons do not work when MENU selection bar or MENU is displayed.

### AV mute

Image and audio are temporarily erased with pressing the MUTE button. To restore the image and audio to the normal mode, press the MUTE button again.

### Caution:

- When you have finished using this equipment, wait 60 seconds for the exhaust fans to stop. Then turn off the main switch and unplug the power cable from the wall outlet, for safety purposes.
- After the lamp is turned off, the lamp cannot be switched on again for 60 seconds as a precautionary measure. If you wish to turn on the projector again, wait until the indicator is off then press the POWER button.
- The exhaust fan rotates faster when the temperature around the projector rises.
- When the temperature around the projector becomes too high, the sign "TEMP!!" blinks red on the screen. If the temperature stays too high, the lamp will be shut off automatically.

# Menu operation

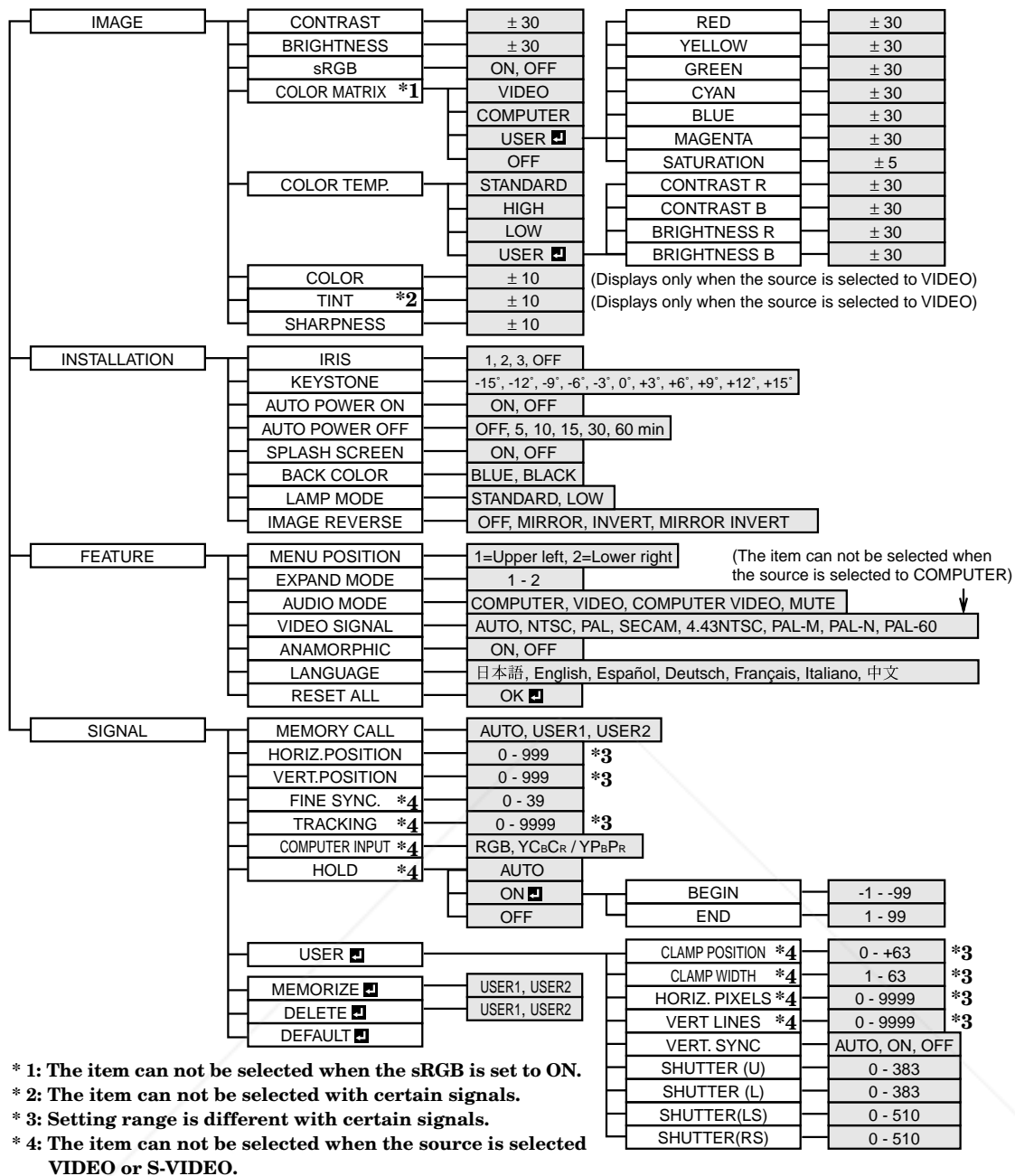

## Basic operation

Several settings can be adjusted using Menu.

EXAMPLE: Auto power off time setting

1. Press the MENU button.



2. Press the ◀ or ▶ button to select the INSTALLATION menu.



3. Press the ENTER button (or ▼ button).

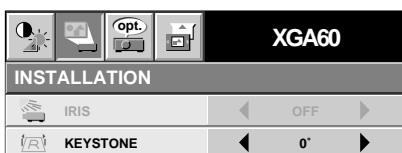

4. Press the ▲ or ▼ button to select AUTO POWER OFF.

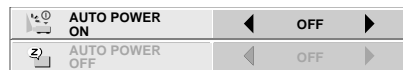

5. Press the ◀ or ▶ button to adjust auto power off time.

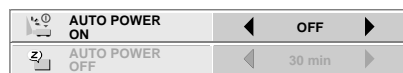

6. Exit the menu system by pressing the MENU button several times.

- If the menu operation is not working, press the RESET button on the terminal board using a suitable sharp object, push gently.
- The settings with  mark, you should press the ENTER button after selecting.



## Menu operation (continued)

### ① IMAGE

**CONTRAST** ..... Adjusts the picture contrast. The contrast becomes higher as the number increases.

**BRIGHTNESS** .... Adjusts the image brightness. The image becomes brighter as the number increases.

**sRGB** ..... Select ON to display an image emphasizing on the color reproducibility.

- When sRGB is ON, COLOR MATRIX, can't be adjusted.
- When sRGB is ON, the image will become darker.
- When COLOR TEMP. is set to other than STANDARD while sRGB is ON, colors won't be reproduced as per the standard value of sRGB.
- Though sRGB can be ON while a signal is input from VIDEO-IN or S-VIDEO IN, reproduced colors won't be in accordance with the sRGB standard value. Use sRGB to suit your color preference.

**COLOR MATRIX** ..... Adjusts the color balance in each color of the image. See page 18.

**COLOR TEMP.** .... Adjusts the color temperature. See page 18.

**COLOR** ..... Adjusts the color intensity of the image. (Available only when VIDEO is selected as the source.)

**TINT** ..... Adjusts the color balance of the image. The color balance of the image shifts green as the number increases and shifts to purple as the number decreases. (Available only when VIDEO is selected as the source.)

- When the TV50 (PAL, SECAM) signal is inputted, TINT can't be adjusted.

**SHARPNESS** ..... Adjusts the image sharpness. The image sharpness rises as the number increases.

XGA60		
IMAGE		
CONTRAST	◀ 0 ▶	
BRIGHTNESS	◀ 0 ▶	
sRGB	◀ OFF ▶	
COLOR MATRIX	◀ COMPUTER ▶	
COLOR TEMP.	◀ STANDARD ▶	
COLOR	◀ 0 ▶	
TINT	◀ 0 ▶	
SHARPNESS	◀ 0 ▶	

### ② INSTALLATION

**IRIS** ..... Adjusts the sensitivity of the function (IRIS) which automatically adjusts the brightness and contrast of the image depending on the degree of the light in the room. When using this projector in a room where the light and shade varies slightly, select 1. When using this projector in a normally lighted room, select 2. When using this projector in a room where the light and shade varies greatly, select 3. When you select OFF, IRIS won't operate.

- When the sensitivity is adjusted in a large amount, the image may be displayed solid white. Adjust the sensitivity depending on the operating environment and images to be displayed.

**KEystone** ..... Corrects keystone distortion. Select an optimum value for proper display. For normal use, select 0°.

**AUTO POWER ON** ..... Select ON to boot up the projector automatically by turning on an externally connected power switch such as a breaker even when the main power switch of the projector is off. Use this setting when the projector is hanging from the ceiling.

- The projector will be in the stand-by mode when the lamp is off. Use the remote control to turn on the lamp.

**AUTO POWER OFF** .... Set the time elapsed before the projector enters into the stand-by mode when there is no signal inputted from the selected source.

**SPLASH SCREEN** ..... Select ON to display the splash screen when the power is turned ON.

**BACK COLOR** ..... Use to select the color of the background, blue or black, which will be displayed when there is no signal inputted from the selected source.



**LAMP MODE** ..... Use to change the brightness of the lamp. When LOW is selected, the image will become darker, though the power will be saved, operating sound will be reduced.

- The brightness of the lamp will be STANDARD for 3 minutes regardless of the setting of the LAMP MODE when the lamp turns on.
- When the LAMP MODE is changed, the screen may flicker. This is not a failure of the lamp.

**IMAGE REVERSE** ..... Use to reverse or invert the projected image. Select MIRROR in rear projection. Select MIRROR, INVERT in rear projection with the projector hanging from the ceiling.



XGA60		
INSTALLATION		
IRIS	◀ OFF ▶	
KEystone	◀ 0° ▶	
AUTO POWER ON	◀ OFF ▶	
AUTO POWER OFF	◀ OFF ▶	
SPLASH SCREEN	◀ ON ▶	
BACK COLOR	◀ BLUE ▶	
LAMP MODE	◀ STANDARD ▶	
IMAGE REVERSE	◀ OFF ▶	

### ③ FEATURE

**MENU POSITION** ..... Use to select the position of the menu on the screen,  (upper left) or  (lower right).

**EXPAND MODE** .. Select the mode for enlarging screen. See page 20.

**AUDIO MODE** ..... Select COMPUTER to output the sound which is inputted to the audio input terminal when COMPUTER is selected as the source. Select VIDEO to output the sound which is inputted to the audio input terminal when VIDEO is selected as the source. Select COMPUTER VIDEO mode to always output the sound which is inputted to the audio input terminal. Select MUTE not to output the sound at all.

XGA60		
FEATURE		
MENU POSITION	◀ 1.  ▶	
EXPAND MODE	◀ 1.  ▶	
AUDIO MODE	◀ COMPUTER VIDEO ▶	
VIDEO SIGNAL	◀ AUTO ▶	
ANAMORPHIC	◀ OFF ▶	
LANGUAGE	◀ English ▶	
RESET ALL	◀ OK  ▶	

- VIDEO SIGNAL ... When AUTO is selected, the appropriate video format is automatically selected depending on the input signal. If the image isn't displayed correctly, select the desired video format manually.
- ANAMORPHIC .... Select ON when playing DVD discs containing data of letterboxed images.
- LANGUAGE ..... Use to select the language used in the menus. (日本語 / English / Español / Deutsch / Français / Italiano / 中文)
- RESET ALL ..... Use to reset the MENU settings (except LANGUAGE).

④ **SIGNAL**

- MEMORY CALL ..... Use to select AUTO, USER 1 or USER 2. See below.
- HORIZ. POSITION .... Use to adjust the horizontal position of the image.
- VERT. POSITION ..... Use to adjust the vertical position of the image.
- FINE SYNC. .... Use to synchronize the projector with PC input signals so that the image is not blurred.
- TRACKING ..... Use to avoid image noise such as wide stripes.
- COMPUTER INPUT .... The unit adjusts itself automatically when connected to a DVD player with a component video output (Y, C<sub>B</sub>, C<sub>R</sub>). In the case (Y, P<sub>B</sub>, P<sub>R</sub>). In the case the projector is connected to equipment that includes RGB output terminal, adjust to RGB mode.
- HOLD ..... Adjusts the image when flagging occurs near the top of the screen.

XGA60	
SIGNAL	
MEMORY CALL	◀ AUTO ▶
HORIZ. POSITION	◀ 0 ▶
VERT. POSITION	◀ 0 ▶
FINE SYNC.	◀ 0 ▶
TRACKING	◀ 0 ▶
COMPUTER INPUT	◀ RGB ▶
HOLD	◀ AUTO ▶
USER	MEMORIZE
DELETE	DEFAULT

⑤ **SIGNAL - USER** (Normally, there is no need for adjustments.)

- CLAMP POSITION/  
CLAMP WIDTH ..... If you use something similar, the brighter colors of the projected image may become blurred. In this case, adjust CLAMP POSITION or CLAMP WIDTH.
- HORIZ.PIXELS .. Use to adjust the width of the image. The image size grows wider as the number increases. (Adjust to the horizontal pixels of the input signal for normal setting.)
- VERT.LINES ..... Use to adjust the height of the image. The image size grows higher as the number increases. (Adjust to the vertical lines of the input signal for normal setting.)
- VERT.SYNC. .... Use to adjust the image when its motion does not run smoothly. Select AUTO for normal setting.
- SHUTTER(U) ..... Use to adjust the image when the noise etc. appears on top part of image.
- SHUTTER(L) ..... Use to adjust the image when the noise etc. appears on bottom part of image.
- SHUTTER(LS) .... Use to adjust the image when the noise etc. appears on left side of image.
- SHUTTER(RS) ... Use to adjust the image when the noise etc. appears on right side of image.

SIGNAL-USER	
CLAMP POSITION	◀ 0 ▶
CLAMP WIDTH	◀ 0 ▶
HORIZ. PIXELS	◀ 0 ▶
VERT. LINES	◀ 0 ▶
VERT. SYNC.	◀ AUTO ▶
SHUTTER(U)	◀ 0 ▶
SHUTTER(L)	◀ 0 ▶
SHUTTER(LS)	◀ 0 ▶
SHUTTER(RS)	◀ 0 ▶

**User memory for signal setting**

This projector can memorize the maximum of 2 signal menu settings.

**Memorizing the setting**

1. Select MEMORIZE  in the SIGNAL menu, and press the ENTER button.
2. Press the ◀ or ▶ button to select the memory which you wish to record (USER 1 or USER 2).
3. Press the ENTER button.
  - Any buttons are ineffective about 3 seconds of recording setting. Wait for recording to have been completed before operating the buttons.

**Initialite the setting which has been changed (Default)**

Select RESET  in the SIGNAL menu, and press the ENTER button.

**Select the user setting**

Select MEMORY CALL in SIGNAL menu, and press the ◀ or ▶ button to select the memory (USER 1 or USER 2).

**Reset the recorded setting**

1. Select DELETE  in the SIGNAL menu, and press the ENTER button.
2. Press the ◀ or ▶ button to select the memory which you wish to reset (USER 1 or USER 2).
3. Press the ENTER button.
  - The recorded setting will be reset.
  - Any buttons are ineffective about 3 seconds of resetting the recorded setting. Wait for resetting to have been completed before operating the buttons.

# Picture adjustment

## Adjusting the image

You can adjust the picture by using the IMAGE menu.

XGA60		
IMAGE		
CONTRAST	◀ 0 ▶	
BRIGHTNESS	◀ 0 ▶	
sRGB	◀ OFF ▶	
COLOR MATRIX	◀ COMPUTER ▶	
COLOR TEMP.	◀ STANDARD ▶	
COLOR	◀ 0 ▶	
TINT	◀ 0 ▶	
SHARPNESS	◀ 0 ▶	

### To control the level of white-to-black in the image :

Adjust CONTRAST in IMAGE menu. Press the ▶ button to increase the contrast and the ◀ button to reduce it.

### To control the light level of the image :

Adjust BRIGHTNESS in IMAGE menu. Press the ▶ button to lighten the image and the ◀ button to darken the image.

### To determine the intensity of the color :

Adjust COLOR in IMAGE menu. Press the ▶ button to increase the amount of color in the image and the ◀ button to decrease it.

### To adjust the red-green color balance of the image :

Adjust TINT in IMAGE menu. Press the ▶ button to increase the amount of red in the image and the ◀ button to increase the amount of green in the image.

### To adjust the detail and clarity of the image :

Adjust SHARPNESS in IMAGE menu. Press the ▶ button to make the picture seem sharper and the ◀ button to make it softer.

## Color matrix

This feature adjusts the color balance in each color of RGB (Red, Green, Blue), and their neutral colors (yellow, cyan, magenta) by using Color correction adjustment. Use Color correct adjustment when emphasizing a specific color, or when only a certain color balance is not correctly adjusted.

1. Select COLOR MATRIX in IMAGE menu.
2. Press the ◀ or ▶ button to select USER .
3. Press the ENTER button.

COLOR MATRIX		
RED	◀ 0 ▶	
YELLOW	◀ 0 ▶	
GREEN	◀ 0 ▶	
CYAN	◀ 0 ▶	
BLUE	◀ 0 ▶	
MAGENTA	◀ 0 ▶	
SATURATION	◀ 0 ▶	

4. Press the ▲ or ▼ button to select the desired color.
  - If you wish to adjust the color intensity of the image, select SATURATION.
5. Press the ◀ or ▶ button to adjust the color balance of the color.

6. Repeat steps 4 and 5 for more adjustments.
7. Exit the menu system by pressing the MENU button several times.

- When using the setting which has been already prepared, select desired position VIDEO or COMPUTER in step 2. When the source is selected to VIDEO or S-VIDEO, VIDEO will be selected automatically. When the source is selected to COMPUTER, COMPUTER will be selected automatically.
- When not using Color matrix adjustment, select OFF in step 2.

## Color temperature

1. Select COLOR TEMP in IMAGE menu.
2. Press the ◀ or ▶ button to select USER .
3. Press the ENTER button.

COLOR TEMP.-USER		
CONTRAST R	◀ 0 ▶	
CONTRAST B	◀ 0 ▶	
BRIGHTNESS R	◀ 0 ▶	
BRIGHTNESS B	◀ 0 ▶	

4. Press the ▲ or ▼ button to select the desired item.
5. Press the ◀ or ▶ button to adjust the item.
6. Repeat steps 4 and 5 for more adjustments.
7. Exit the menu system by pressing the MENU button several times.

### About color temperature

There are different kinds of white color. Color temperature is a way to show the differences. The white, which temperature is low, becomes reddish white. When the color temperature is higher, the white becomes more bluish. This projector sets this color temperature by changing the numbers of contrast blue and red.

To set the color temperature high:

Set the contrast B (Blue) number high, and the contrast R (Red) number low.

To set the color temperature low:

Set the contrast B (Blue) number low, and the contrast R (Red) number high.

### Adjustment from personal computer

Although this projector sets proper signal systems automatically for the image signal from personal computers, it cannot be applied to some of personal computers. In this case, press the AUTO POSITION button. If the images are still not projected correctly, use the MENU display to adjust the projected images.

XGA60	
<b>SIGNAL</b>	
MEMORY CALL	◀ AUTO ▶
HORIZ. POSITION	◀ 0 ▶
VERT. POSITION	◀ 0 ▶
FINE SYNC.	◀ 0 ▶
TRACKING	◀ 0 ▶
COMPUTER INPUT	◀ RGB ▶
HOLD	◀ AUTO ▶
USER	MEMORIZE
DELETE	DEFAULT

#### Image moved to right or left :

Adjust HORIZ. POSITION in SIGNAL menu. Press the ▶ button to move the image to left. Press the ◀ button to move the image to right.

#### Image moved to up or down :

Adjust VERT. POSITION in SIGNAL menu. Press the ▶ button to move the image to upward. Press the ◀ button to move the image to down.

#### Image flickers / Image is out of focus :

Adjust FINE SYNC. in SIGNAL menu.

SIGNAL-USER	
CLAMP POSITION	◀ 0 ▶
CLAMP WIDTH	◀ 0 ▶
HORIZ. PIXELS	◀ 0 ▶
VERT. LINES	◀ 0 ▶
VERT. SYNC.	◀ AUTO ▶
SHUTTER(U)	◀ 0 ▶
SHUTTER(L)	◀ 0 ▶
SHUTTER(LS)	◀ 0 ▶
SHUTTER(RS)	◀ 0 ▶

#### Wide stripes appear :

Adjust CLAMP POSITION or CLAMP WIDTH of each menu in SIGNAL - USER menu.

#### Noise appears on right or left side of image :

Adjust SHUTTER (LS), SHUTTER (RS) or HORIZ. PIXELS of the menu in SIGNAL - USER menu.

#### Noise etc. appears on top or bottom part of image :

Adjust SHUTTER (U), SHUTTER (L) or VERT. LINES of the menu in SIGNAL - USER menu.

#### Top part of image curves :

Change the setting of HOLD in SIGNAL menu. Select ON , press the ENTER button and adjust BEGIN or END for image which top part is the least curved.

#### Image does not move naturally :

Adjust VERT. SYNC. of the menu in SIGNAL - USER menu. Select AUTO for normal setting, curved. Select AUTO for normal setting.

- Do not change each menu setting in USER menu for normal setting.

#### Simple adjustment method

- Select HORIZ. POSITION in SIGNAL menu.
- Press the ◀ or ▶ button to adjust the horizontal start position (the left side of image).
- Select TRACKING in SIGNAL menu.
- Press the ◀ or ▶ button to adjust the horizontal end position (the right side of image).
- Repeat steps 1 to 4 for fine adjustment.
- Select VERT. POSITION in SIGNAL menu.
- Press the ◀ or ▶ button to adjust the vertical start position (the top end of image).

# Advanced features for presentation

## Expand

By pressing the EXPAND button on the remote control, you can magnify the detailed image of the picture.

### Using the Expand mode

1. Press the EXPAND button.
    - You can magnify different areas of the active picture by pressing the ▲, ▼, ◀, ▶ button.
    - You can change the magnification of the zoomed area by pressing the + or - button.
  2. Press the EXPAND button on the remote control again.

The normal screen display will appear on the screen.
- **Display enlargement does not work with video input or S-video input.**

## REAL screen display

You can view the screen displaying the picture as its original size (native resolution display).

### Setting the Expand mode for REAL screen display

1. Press the MENU button.
2. Press the ◀ or ▶ to select the FEATURE menu.
3. Press the ENTER button.
4. Press the ▲ or ▼ button to select EXPAND MODE.
5. Press the ◀ or ▶ to set the EXPAND MODE 2.

#### EXPAND MODE

(EXPAND MODE 1) (EXPAND MODE 2)

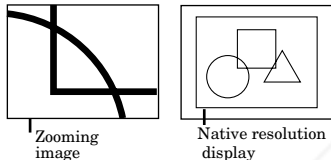

6. Press the MENU button twice to exit the menu system.

### Viewing the REAL screen display

1. Press the EXPAND button.
2. Exit the EXPAND mode, by pressing the EXPAND button again.

The normal screen display will appear on the screen.

**Display enlargement does not work with video input or S-video input.**

- During REAL mode, Press the ◀ or ▶ buttons for fine adjustment.
- During REAL mode, the ▲ and ▼ buttons are not working. At this time, the prohibition mark (⊙) appears on the screen.
- The expanding rate cannot be changed by pressing either the + or - button. They are working for volume adjustment.

## Still

How to stop the picture temporarily (still picture).

1. Press the STILL button on the remote control.

The picture will be frozen temporarily.

To resume picture activity.

2. Press the STILL button on the remote control again.

## Mouse remote control

By connecting to personal computer through the USB or PS/2 port, you can operate your computer with the projector remote control.

### Connection

#### Projector + PC through USB connector

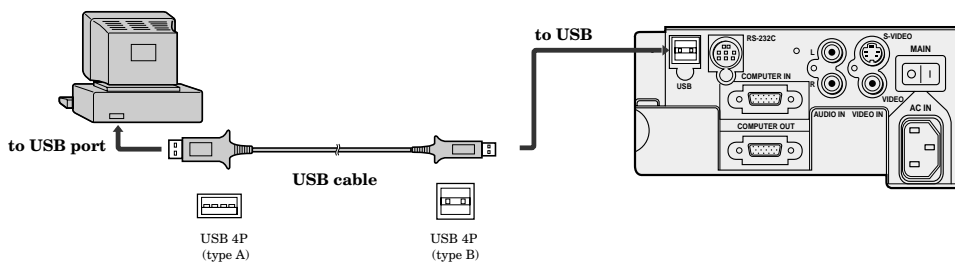

- You can use the mouse remote control function with computer supported USB only. If your system is Windows® 98 or higher, your computer supported USB in standard. If your system is Windows® 95 or lower, please contact your dealer. If your computer is Macintosh with USB port, you can use this function.
- When the lamp is turned ON, the computer connected with the USB cable may not work correctly. In this case, restart the projector and the computer. If possible, you should disconnect the USB cable when the lamp is turned ON.

#### Projector + PC through PS/2 connector

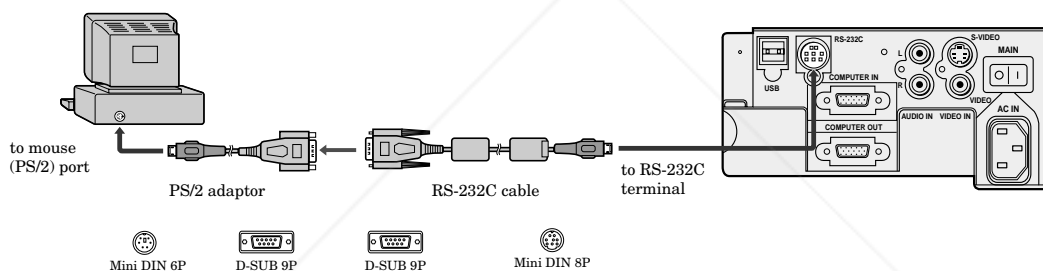

- Turn off PC and the projector before connecting with PS/2 port. When connecting the PC with the projector when the personal computer is on, the remote control does not work as a mouse. In that case, turn the projector on, then restart the personal computer.
- When the projector is connected with USB terminal and RS-232C terminal at the same time, only the terminal which the projector recognizes first will work.
- When you use the RS-232C cable together with an extension cable, the function may not work correctly.

### Operation

**Mouse**  
When pressing this button, it illuminates. Mouse pointer/ direction button operates as mouse pointer.

**Mouse pointer**  
Use to move the cursor on the image, instead of the computer mouse.

**Left click**  
This operates in the same way as the left button on the computer.

**Right click**  
This operates in the same way as the right button on the computer mouse.

- When L/R click buttons and the mouse button are not used for 6 seconds, the mode will be changed to the normal mode automatically.

# Lamp replacement

The lamp is designed to project the image on the LCD panels. When the lamp no longer functions, replace it with a new one.

## Caution:

- Do not remove the lamp immediately after turning off the lamp of the projector, you may get burned because of the high temperature of the lamp.
- For lamp replacement, press the power button to power off, then wait for 60 seconds in stand-by mode to allow the lamp and LCD panels to cool. Then turn off the main switch, unplug the power cord from the outlet, and wait one hour so that the lamp is cooled to the touch.
- Do not remove the lamp except for replacement. Careless treatment can cause injury or fire.
- Do not touch the lamp element directly. It may break and cause you to injure or burn yourself.
- Be sure not to drop the lamp lid screw into the projector. Also be sure not to insert metal or any flammable objects, it may cause fire or electric shock. If any objects are inserted, please unplug and contact your dealer.
- Install the lamp securely, failure may cause a fire.
- If the light bulb part breaks, some small glass fragments may fall out through the small cooling grille, and sticks to the inside of projector or the lamp box. When taking the lamp out, make sure to turn over the projector and hold the handle of the lamp box to avoid injury from the glass fragments.
- Never shake the lamp or hold it in front of your face after removing the lamp box. The glass fragments may fall out and cause injuries to your eyes and so on.

1. Reverse the projector gently.

2. Loosen the screws of the lamp lid (a) using a phillips screwdriver (+), and remove the lid.
- Remove the lamp cover in the direction of the arrow as indicated.

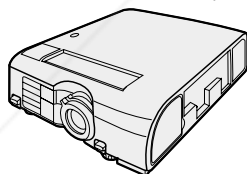

3. Loosen screws (b) using a phillips screwdriver (+).

4. Pull up the handle.

5. Hold onto the projector by the handle as you pull out the lamp.
- Pull out the lamp straight upward.
  - Pull the lamp out of the projector slowly. Should the light bulb be broken, glass fragments will spill out if the lamp is pulled out too quickly.
  - Once the lamp has been removed, do not spill liquid on it, place it near flammable objects or where children can touch it. Otherwise, it will cause injury or fire.

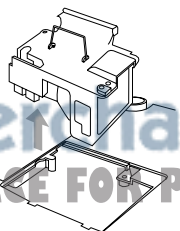
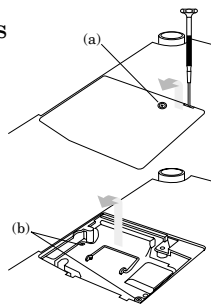

6. Insert the new lamp securely into the projector body in the right direction.

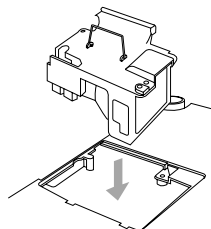

7. Put the handle back to the holding point.

- Make sure that the handle is locked.

8. Tighten up the screws (b) using a phillips screwdriver (+).

9. Tighten up the screws of the lamp lid (a) using a phillips screwdriver (+).

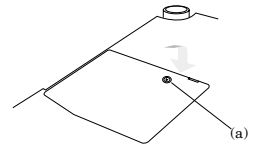
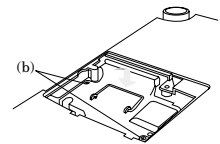

## How to reset the operation time meter

Plug in the power cord, switch on the projector, and reset lamp time by pressing the ◀, ▶ and POWER buttons simultaneously.

## Caution:

- Do not spill liquid on the lamp or place it near flammable objects or where children can touch it. Otherwise, it could cause injury or fire.
- Be sure that the projector guide is firmly inserted between the right and left lamp guides.

## Important:

- The projector will not turn on if you do not secure the lamp lid.
- You must reset the **operation time meter** after you replace the lamp.
- Do not reset the operation time meter unless the lamp has been replaced.

## Interval of the lamp replacement

The interval of the lamp replacement about 1,500 hours of consecutive use. Replacement span may differ according to operating environment, and may be shorter than 1,500 hours. Decreases in luminescence and/or color brightness will indicate that the light source lamp needs to be replaced. When lamp operation time exceeds 1,000 hours\*<sup>1</sup>, the indicator will flash alternately between green and red (while the lamp is in operation; when the lamp is not in operation, the indicator will appear red only). When the lamp has been used for about 1,400 hours\*<sup>1</sup>, the message "LAMP!!" will appear on the screen for one minute everytime the power is turned on. When the lamp has been used for about 1,500 hours\*<sup>1,\*2</sup>, the projector will automatically shut off for safety and the power indicator light will be red. The projector cannot be used until the lamp has been replaced and operation timer has been reset.

## Caution:

- The lamp is fragile. If broken, be careful not to cut yourself with glass fragments.
- The replacement span of the lamp depends on the environment. For replacement lamps, please contact your dealer.

**The projector automatically shuts off when the lamp is used up in about 1,500 hours\*<sup>2,\*2</sup> and cannot be used until the lamp is replaced and the internal timer is reset.**

\*<sup>1</sup>) When LAMP MODE of the INSTALLATION menu is set to STANDARD.

\*<sup>2</sup>) When LAMP MODE is set to low, the duration will be extended maximum up to 2,000 hours.

# Maintenance

## Caution:

Be sure to turn off the projector and unplug the power cord from the wall outlet before you perform any maintenance on the projector.

## Cleaning the air-filter

Clean the air-filter frequently. If the filter or ventilation grille become clogged with dirt or dust, the temperature inside the projector may rise and shut off the power (the TEMP indicator starts to blink red).

1. To remove the filter cover, press the ridged area gently, push the cover in the direction of the arrow and lift.
2. Remove the air-filter from the filter cover.
3. Wash the air-filter.
  - Use water or a mild detergent diluted with water to clean the filter. Rinse the filter thoroughly and let it dry completely.
4. Attach the filter to the cover.
5. Reinstall the filter cover.

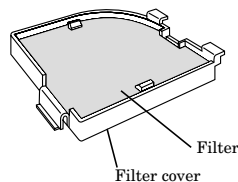
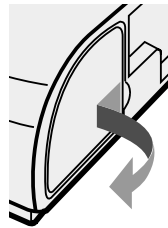

## Important:

- If the filter is damaged or becomes extremely dirty, contact your dealer for replacement.

## Caution:

Be sure to use the projector with an air-filter. If not, dust may get inside the projector, causing a fire or a breakdown.

## Cleaning the projector and the ventilation grille

Use a soft cloth to clean the projector and the ventilation grille. When the grille become dirty, wipe them with a soft cloth dampened with a diluted mild detergent, and then wipe them with a dry cloth.

To protect the surface of the projector from fading or deteriorating:

- Do not spray insecticide on or inside the projector.
- Do not use benzene or thinner to clean it.
- Do not let rubber or plastic materials come into contact with the projector.

## Cleaning the lens

Use a standard lens-cleaning brush or a piece of lens tissue dampened with lens cleaning fluid. The lens surface is fragile. Use only recommended, nonabrasive lens-cleaning materials. Do not touch the lens with your fingers.



# Troubleshooting

The following offers solutions to some of the common problems you may encounter. We suggest that you consult this chart before contacting your dealer.

PROBLEMS	CAUSE	POSSIBLE SOLUTIONS
The power is off.	<ul style="list-style-type: none"> <li>The air inlet grille, outlet grille or air filter is clogged with dust or some objects.</li> </ul> <p><b>POWER indicator does not light up.</b></p> <ul style="list-style-type: none"> <li>Power cord is unplugged from the outlet.</li> <li>Power cord is disconnected from the projector.</li> <li>The main switch is turned off.</li> <li>The lamp lid is open.</li> </ul> <p><b>POWER indicator blinks red.</b></p> <ul style="list-style-type: none"> <li>The projector has been turned on again too soon after having been turned off.</li> <li>When the power switch was turned off while the fan was running, during or after lamp operation.</li> <li>The room temperature is too high. (Does the LAMP indicator show an unusual condition?)</li> <li>Lamp is no longer working.</li> </ul> <p><b>POWER indicator blinks between red and green.</b></p> <ul style="list-style-type: none"> <li>The lamp cover is not closed.</li> <li>When the LAMP indicator or the TEMP indicator is either on or blinking, the main unit requires repairs.</li> </ul>	<ul style="list-style-type: none"> <li>Remove the object.</li> <li>Plug the power cord into the outlet.</li> <li>Insert the power cord into the projector.</li> <li>Turn the main switch on.</li> <li>Close the lamp lid.</li> <li>Wait for the lighting sequence.</li> <li>Turn the power switch on and off several times.</li> <li>Refer to "Indicators" on page 25.</li> <li>Replace the lamp with a new one.</li> <li>Close the cover correctly.</li> <li>Contact your dealer.</li> </ul>
No picture appears on the screen.	<ul style="list-style-type: none"> <li>Lens is covered by lens cap.</li> <li>When the LAMP indicator or the TEMP indicator is either on or blinking, the main unit requires repairs.</li> <li>The equipment connected to this projector is not turned on.</li> <li>Hookup is not made correctly with other equipment.</li> <li>The input source is not selected correctly.</li> </ul>	<ul style="list-style-type: none"> <li>Take the lens cap off.</li> <li>Replace the lamp with a new one.</li> <li>Turn on the connected equipment.</li> <li>Confirm the hookup.</li> <li>Select the correct source according to the equipment connected to this projector.</li> </ul>
The image is turned off.	<ul style="list-style-type: none"> <li>The air inlet grille, outlet grille or air filter is clogged with dust or some objects. (In this case, the TEMP indicator does not light up.)</li> </ul>	<ul style="list-style-type: none"> <li>Remove the object and turn off the main power switch. After about 10 minutes, Turn the projector on.</li> </ul>
The image is distorted.	<ul style="list-style-type: none"> <li>The projector is not at a right angle to the screen.</li> </ul>	<ul style="list-style-type: none"> <li>Adjust the angle of the projector to make a right angle to the screen. See page 12.</li> </ul>
The image is dark.	<ul style="list-style-type: none"> <li>Brightness, tint and color are not adjusted correctly.</li> </ul>	<ul style="list-style-type: none"> <li>Adjust brightness, tint and color correctly.</li> </ul>
The image is blurred.	<ul style="list-style-type: none"> <li>The projecting distance is beyond the focused area.</li> <li>Lens is dirty.</li> <li>Screen size exceeds screen size specifications.</li> <li>Brightness and contrast are not adjusted correctly.</li> <li>FINE adjustment is not made correctly.</li> <li>Tracking is not adjusted.</li> <li>The projector is not at a right angle to the screen.</li> </ul>	<ul style="list-style-type: none"> <li>Adjust the projecting distance. See page 9.</li> <li>Clean lens.</li> <li>Reduce screen size to within 30" to 300".</li> <li>Adjust brightness, contrast.</li> <li>Make FINE adjustment.</li> <li>Adjust tracking.</li> <li>Adjust the angle of the projector to make a right angle to the screen. See page 12.</li> </ul>
The image remains blurred.	<ul style="list-style-type: none"> <li>When you see the stationary image for a long time, it may remain on the screen if you change the image. It is not a breakdown. The blurred image will disappear in a few minutes.</li> </ul>	
Red, blue or green dots are viewed on the text of image.	<ul style="list-style-type: none"> <li>It is normal.</li> </ul>	
Image is distorted on the screen and noise is heard.	<ul style="list-style-type: none"> <li>The cable for connection with other equipment is not plugged securely into the terminal.</li> <li>The projector is installed too close to other equipment.</li> </ul>	<ul style="list-style-type: none"> <li>Plug the connecting cable securely into the terminal. See pages 10-11.</li> <li>Install the projector far away from other equipment.</li> </ul>
No sound is heard.	<ul style="list-style-type: none"> <li>Volume is not turned up.</li> <li>Connection to other equipment is not made correctly.</li> </ul>	<ul style="list-style-type: none"> <li>Turn up the volume.</li> <li>Check connections. See pages 10-11.</li> </ul>
Nothing is displayed on the PC monitor.	<ul style="list-style-type: none"> <li>The PC monitor is not turned on.</li> </ul>	<ul style="list-style-type: none"> <li>Turn on the monitor.</li> </ul>
Warm air comes out of the exhaust vents.	<ul style="list-style-type: none"> <li>This is typical of the LCD projector.</li> </ul>	
Adjustments cannot be made.	<ul style="list-style-type: none"> <li>The operation is incorrectly made due to noise or interference.</li> </ul>	<ul style="list-style-type: none"> <li>Press the reset button on the Terminal board. See page 15.</li> </ul>
⊙ is displayed.	<ul style="list-style-type: none"> <li>This mark is displayed when an invalid operation is executed (for example, when the COMPUTER or VIDEO button is pressed while the menu is displayed). This is not failure.</li> </ul>	

# Indicators

The projector has three LED Indicators which shows the working condition of the projector. The following offers solutions to possible problems. If a problem persists, turn the projector off and consult your dealer.

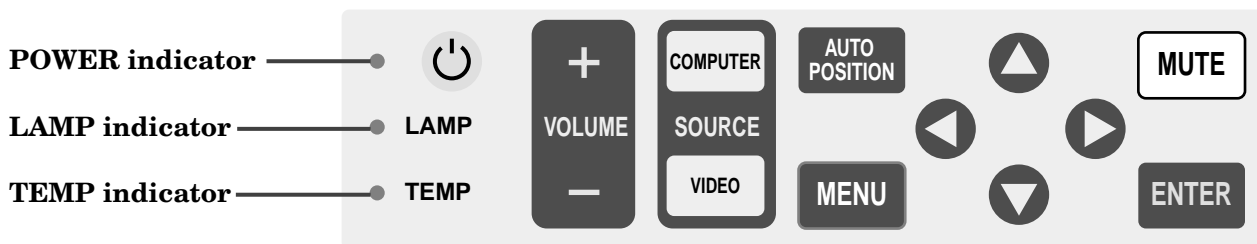

## Normal condition

POWER	LAMP	TEMP	CONDITION	Notes
Steady red	Off	Off	Stand-by	
Steady green	Blinking green	Off	Lamp stand-by (about for 1 minute)	The power button cannot be used to switch ON and OFF
Steady green	Steady green	Off	The POWER is ON. (Normal condition)	

## Abnormal condition

POWER	LAMP	TEMP	CONDITION	POSSIBLE SOLUTIONS
Steady green Steady red	Steady green ↓ Off	Blinking red  Blinking red	Unusual temperature <ul style="list-style-type: none"> <li>The ventilation slits or air filter is clogged with dust or debris.</li> <li>The room temperature is too high.</li> <li>The filter is dirty.</li> </ul>	<ul style="list-style-type: none"> <li>Remove the object from the ventilation slits.</li> <li>Relocate the projector to a cooler place.</li> <li>Clean the filter.</li> </ul>
Steady red	Blinking green	Off	The protection circuit is working or the lamp is in an abnormal condition.	<ul style="list-style-type: none"> <li>Wait until the LAMP indicator is turned off, then press the POWER button.</li> <li>If the above operation is not effective, replace the lamp.</li> </ul>
Steady green	Blinking green/red	Off	Lamp duration warning. (Lightning duration total about 1,000 hours*. When the POWER is ON.)	Replace the lamp. Exchange with a new lamp if the same problem recurs.
Steady red	Blinking red	Off	Lamp duration warning. (Lightning duration total about 1,000 hours*. When the POWER is OFF.)	
Steady red	Steady green	Off	Lamp duration warning. (Lightning duration total about 1,500 hours*.)	
Blinking green/red	Off	Off	The lamp cover is not closed.	Close the cover correctly.
Blinking green/red Blinking green/red	Steady or Blinking Blinking	Steady or Blinking Blinking	Abnormal.	Contact your dealer.

\*) When LAMP MODE of the INSTALLATION menu is set to STANDARD. When it is set to LOW, the duration will be extended.

# Specifications

Type	LCD projector
Model	XL1U
Rated power supply	AC100V - 240V, 50 / 60Hz
Rated input	2.3 A
LCD panels	0.7-inch LCD panel: 3 pieces (for R, G, B) Pixels 1,024 × 768 = 786,432 pixels Total 2,359,296 pixels Active pixel rate: 99.99 % or more (each panel)
Colors	16,770,000 colors
Projection lens	F 1.9 - 2.2 f = 27.0 mm - 32.0 mm
Light source lamp	150 W NSH
Picture size	30 inch - 300 inch (aspect ratio 4:3)
PC compatibility	Resolution : 640 x 400 - 1024 x 768 + Compressed 1280 x 1024 Sync on Green available
Video compatibility	NTSC / NTSC 4.43 / PAL (including PAL-M, N) / SECAM, PAL-60 DVD (Component) / HDTV (1080i) / 720p / (525p)
Audio output	1 W mono
Speaker	Round type (8Ω 1W)
S-video input	Luminance signal: V <sub>p-p</sub> =1.0V 75Ω (negative sync.) Chroma signal: V <sub>p-p</sub> =0.286V 75Ω (burst signal)
Video input	V <sub>p-p</sub> =1.0V 75Ω (negative sync.)
Audio inputs	350 mVrms, 10kΩ or more
Analog RGB input (mini D-SUB 15P)	RGB: V <sub>p-p</sub> =0.7V 75Ω (negative sync.) YC <sub>B</sub> Cr: Y: V <sub>p-p</sub> =1.0V (negative sync.) C <sub>B</sub> Cr: V <sub>p-p</sub> =0.7V HD/CS : TTL level (positive or negative) VD : TTL level (positive or negative)
Control connector	Serial (DIN 8 pin female connector) RS-232C standards USB terminal for Mouse
Outside dimensions	237 mm × 94 mm × 315 mm (9.3 inch × 3.7 inch × 12.4 inch) (width × height × depth) Legs and lens are included.
Weight	Approx. 2.9 kg (6.5 lbs)
Length of power cord	2.9m (9.5 feet)
Temperature, humidity (performance guarantee)	+41°F (+5°C) - +95°F (+35°C), 30 - 90%

## Kensington Lock

This projector has a Kensington Security Standard connector for use with a Kensington MicroSaver Security System. Refer to the information that came with the Kensington System for instructions on how to use it to secure the projector. Please contact to Kensington Technology Group as shown below.

Kensington Technology Group  
 2855 Campus Drive  
 San Mateo, CA 94403, U.S.A.

Phone : (650)572-2700 Fax : (650)572-9675

## Connectors

### PC analog RGB input

Use to input video signals (analog RGB) of a personal computer.

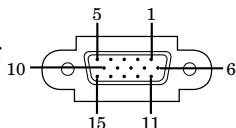

(Pin assignment of Mini D-SUB 15P jack)

PIN NO.	SPEC	PIN NO.	SPEC
1	R(RED)/C <sub>R</sub>	9	—
2	G(GREEN)/Y	10	GROUND
3	B(BLUE)/C <sub>B</sub>	11	GROUND
4	GROUND	12	—
5	GROUND	13	HD/CS
6	GROUND	14	VD
7	GROUND	15	—
8	GROUND		

### RS-232C input

Use to control the projector with the personal computer, or control the personal computer with remote control. Use the provided RS-232C cable (Mini DIN 8P-D-SUB 9P) for the connection.

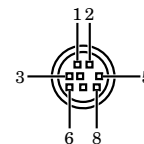

PIN NO.	NAME	I/O
1	TXD	IN
2	RTS	IN
3	DTR	IN
4	GND	—
5	CTS/5V	IN / OUT
6	DCD/CLOCK	OUT
7	RXD	OUT
8	RI/DATA	OUT

## Dimensional drawings (mm)

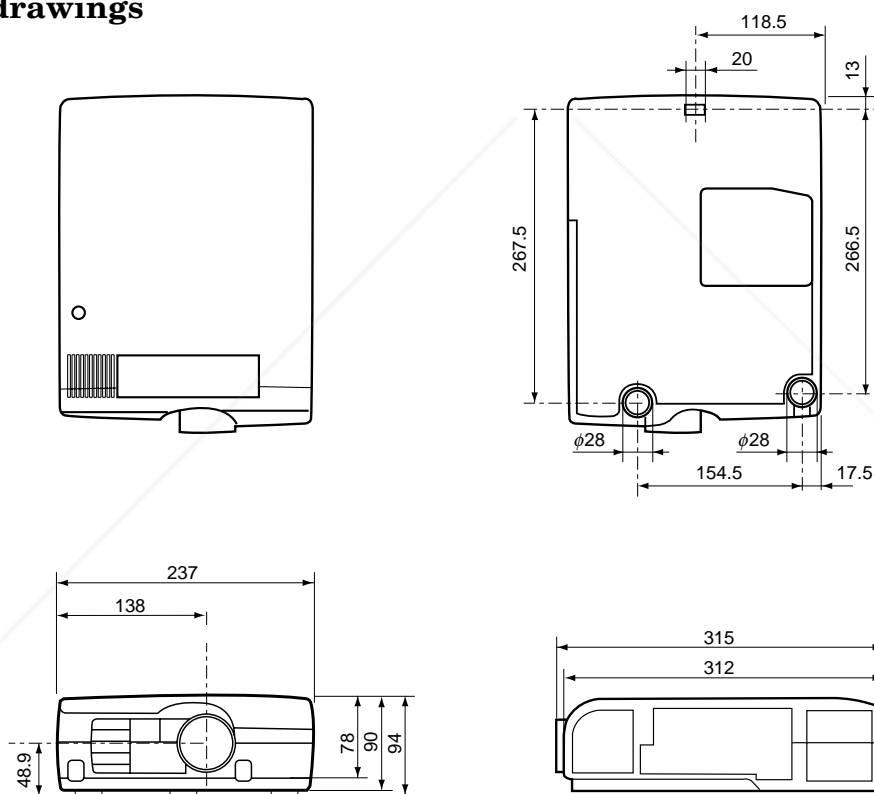

### What's included in the box

2 AC power cord	246C383-10	1 USB cable	246C413-10
1 AV(Audio/Video) cable	246C383-20	1 Remote control	939P876-10
1 RGB cable for PC	246C381-10	1 User manual	871D341-50
1 RS-232C cable	246C394-10	1 Quick reference card	857B053-10
1 PS/2 adapter	246C366-10	2 Battery for remote	—
	246C367-10	1 Carrying case	772P037-10

### Replacement part

#### (Option / Not included in the box)

Spare Mercury lamp	499B027-10 (VLT-XL1LP)
--------------------	---------------------------

## Specifications (continued)

### Specification of RGB signals in each computer mode of the projector

Signal mode	resolution (H x V)	horizontal frequency (kHz)	Vertical frequency (Hz)	Normal mode (H x V)	Real mode (H x V)
TV60	–	15.73	59.94	1024 x 768	–
TV50	–	15.63	50.00	1024 x 768	–
1080i	–	33.75	60.00	1024 x 576	–
720p	–	45.00	60.00	1024 x 576	–
PC98	640 x 400	24.82	56.42	1024 x 640	640 x 400
CGA70	640 x 400	31.47	70.09	1024 x 640	640 x 400
CGA84	640 x 400	37.86	84.14	1024 x 640	640 x 400
CGA85	640 x 400	37.86	85.08	1024 x 640	640 x 400
VGA60	640 x 480	31.47	59.94	1024 x 768	640 x 480
VGA72	640 x 480	37.86	72.81	1024 x 768	640 x 480
VGA75	640 x 480	37.50	75.00	1024 x 768	640 x 480
VGA85	640 x 480	43.27	85.01	1024 x 768	640 x 480
SVGA56	800 x 600	35.16	56.25	1024 x 768	800 x 600
SVGA60	800 x 600	37.88	60.32	1024 x 768	800 x 600
SVGA72	800 x 600	48.08	72.19	1024 x 768	800 x 600
SVGA75	800 x 600	46.88	75.00	1024 x 768	800 x 600
SVGA85	800 x 600	53.67	85.06	1024 x 768	800 x 600
XGA43i	1024 x 768	35.52	86.96	1024 x 768	1024 x 768
XGA60	1024 x 768	48.36	60.00	1024 x 768	1024 x 768
XGA70	1024 x 768	56.48	70.07	1024 x 768	1024 x 768
XGA75	1024 x 768	60.02	75.03	1024 x 768	1024 x 768
XGA85	1024 x 768	68.68	85.00	1024 x 768	1024 x 768
SXGA70a	1152 x 864	63.85	70.01	1024 x 768	1024 x 768
SXGA75a	1152 x 864	67.50	75.00	1024 x 768	1024 x 768
SXGA85a	1152 x 864	77.49	85.06	1024 x 768	1024 x 768
SXGA60b	1280 x 960	60.00	60.00	1024 x 768	1024 x 768
SXGA75b	1280 x 960	75.00	75.00	1024 x 768	1024 x 768
SXGA43i	1280 x 1024	46.43	86.87	1024 x 768	1024 x 768
SXGA60	1280 x 1024	63.98	60.02	1024 x 768	1024 x 768
SXGA75	1280 x 1024	79.98	75.03	1024 x 768	1024 x 768
MAC13	640 x 480	35.00	66.67	1024 x 768	640 x 480
MAC16	832 x 624	49.72	74.55	1024 x 768	832 x 624
MAC19	1024 x 768	60.24	75.02	1024 x 768	1024 x 768
MAC21	1152 x 870	68.59	74.96	1024 x 768	1024 x 768
HP75	1024 x 768	62.94	74.92	1024 x 768	1024 x 768
HP72	1280 x 1024	78.13	72.00	1024 x 768	1024 x 768
SUN66a	1152 x 900	61.85	66.00	1024 x 768	1024 x 768
SUN76a	1152 x 900	71.81	76.63	1024 x 768	1024 x 768
SUN66	1280 x 1024	71.68	66.68	1024 x 768	1024 x 768
SUN76	1280 x 1024	81.13	76.11	1024 x 768	1024 x 768
SGI72	1280 x 1024	76.92	72.30	1024 x 768	1024 x 768
SGI76	1280 x 1024	82.00	76.00	1024 x 768	1024 x 768
IBM60	1280 x 1024	63.42	60.00	1024 x 768	1024 x 768

- When the EXPAND MODE of FEATURES menu is set to real screen display, by pressing the EXPAND button on the remote control, it will switch to the screen displaying the picture as its original size (real screen display). In the real screen display, pictures will be black-framed when picture resolution is lower than 1,024 x 768. For example, a 640 x 480 image, 1080i image, and 720p image is displayed in the top portion of the screen.

#### Important:

- Some computers may not be compatible with the projector.
- The projector's maximum resolution is 1,024 x 768 pixels. It may not display correctly for the pictures of higher resolutions than 1,024 x 768.
- The picture with a SYNC on G (Green) signal may jitter.
- The picture with a SYNC on G (Green) signal may be tinted with green.

- If the resolution and frequency of your computer are not shown on the table, change the resolution of your computer. You may find the compatible resolution and frequency.
- Set the COMPUTER INPUT in SIGNAL menu to RGB, when inputting the HDTV signal as RGB signal.
- In case of the SXGA, the right side of the image may not appear. In this case, adjust the TRACKING in the SIGNAL menu.
- Set the SIGNAL menu and USER menu as shown below, when 525p signal is inputted. Set TRACKING first.

```

HORIZ. POSITION ..... 143
VERT. POSITION ..... 54
TRACKING ..... 800
COMPUTER INPUT ..... YCbCr/YPbPr
CLAMP POSITION ..... +9
CLAMP WIDTH ..... +3
HORIZ.PIXELS ..... 616
VERT.LINES ..... 444
VERT.SYNC. .... ON
HOLD ..... ON  BEGIN -1
END 8
  
```



**Discount-Merchant.com (800) 281-8860**  
**THE TRUSTED SOURCE FOR PROJECTOR LAMPS AND ACCESSORIES**

Manufactured by Mitsubishi Electric Corporation  
1 Zusho Baba, Nagaokakyo-City, Kyoto Japan

## Control projector by using a personal computer

This projector can be controlled by connecting a personal computer with RS-232C terminal. Functions can be controlled by a personal computer:

- Turn the ON or OFF
- Changing input signals
- Menu setting

### Connection

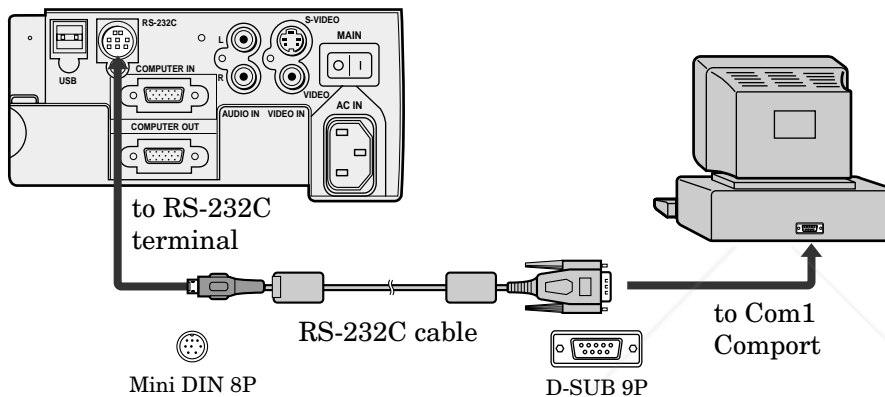

### Important:

- Make sure that your computer and projector are turned off before connection.
- Turn on the projector after the computer is started up.  
(If you do not follow this order, the Comport may not function.)
- Adapters may be necessary depending on the PC connected to this projector. Contact your dealer for details.

### 1) Interface

PROTOCOL	RS-232C
BAUD RATE	9600 [bps]
DATA LENGTH	8 [bits]
PARITY BIT	NONE
STOP BIT	1 [bit]
FLOW CONTROL	NONE

This projector uses RXD, TXD and GND lines for RS-232C control. For RS-232C cable, the reverse type cable should be used.

FixYourDLP.com

### 2) Control command diagram

The command is structured by the address code, function code, data code and end code. The length of the command is different by each function.

	Address code	Function code	Data code	End code
HEX	30h 30h	Function	Data	0Dh
ASCII	'0' '0'	Function	Data	↵

- [Address code] 30h 30h (In ASCII code, '0' '0') fixed.  
 [Function code] A code of each fixed control move.  
 [Data code] A code of each fixed control data (number) and not always indicated.  
 [End code] 0Dh (In ASCII code, '↵') fixed.

### 3) Control sequence

- (1) Send the command from a personal computer to the projector. (The commands must be sent at least 400ms apart.)
  - (2) The projector will send a return command 400ms\* after it has received an end code. If the command is not received correctly, the projector will not send the return command.
  - (3) The personal computer checks the command and confirms if the command which has been sent has been executed or not.
  - (4) This projector sends various codes other than the return code. When having a control sequence by RS-232C, reject other codes from personal computer side.
- \*: The sending time of return command may delay depending on the condition (during changing the input signal, etc.).

[Example] Turn the power ON ('!' is for ASCII code)

Sending commands from the PC etc.	Status code from projector	Meaning
30 30 21 0D '0' '0' '!' '␣'		Command for POWER ON
	30 30 21 0D '0' '0' '!' '␣'	Command received (Command echo back)

### 4) Operation commands

The operation commands execute the basic operation setting of this projector. It may not operate when changing the signal.

Operation	ASCII	HEX
POWER ON	!	21h
POWER OFF	"	22h
INPUT COMPUTER	_r1	5Fh 72h 31h
INPUT VIDEO	_v1	5Fh 76h 31h
INPUT S-VIDEO	_v2	5Fh 76h 32h

- POWER OFF command will not work for 1 minute after the power is turned on.
- POWER ON command will not work for 1 minute after the power is turned off.

[Example] Set the input signal to COMPUTER ('!' is for ASCII code)

Sending commands from the PC etc.	Status code from projector	Meaning
30 30 5F 72 31 0D '0' '0' '_' 'r' '1' '␣'		Command for setting the input signal to COMPUTER
	30 30 5F 72 31 0D '0' '0' '_' 'r' '1' '␣'	Command received (Command echo back)

### 5) Volume commands

The volume commands execute the volume setting of this projector with the value.

ITEM	ASCII	HEX	VALUE
VOLUME	VL	56h 4Ch	00 - 60

#### How to set the grade

Use ASCII letters code to set the grade for setting data. Please refer to the table below for HEX code.

ASCII	'0'	'1'	'2'	'3'	'4'	'5'	'6'	'7'	'8'	'9'
HEX	30h	31h	32h	33h	34h	35h	36h	37h	38h	39h

[Example] Set the volume to 30 (Standard value) ('!' is for ASCII code)

Sending commands from the PC etc.	Status code from projector	Meaning
30 30 56 4C 33 30 0D '0' '0' 'V' 'L' '3' '0' '␣'		Command for setting the volume
	30 30 56 4C 33 30 0D '0' '0' 'V' 'L' '3' '0' '␣'	Command received (Command echo back)



## 6) Remote commands

Some remote control operations can be done by remote command codes.

Button's name on remote	ASCII	HEX
+ VOLUME	r06	72h 30h 36h
- VOLUME	r07	72h 30h 37h
KEystone	r43	72h 34h 33h
EXPAND	r02	72h 30h 32h
MUTE	ra6	72h 61h 36h
▲	r53	72h 35h 33h
▼	r2b	72h 32h 62h
◀	r4f	72h 34h 66h
▶	r59	72h 35h 39h
MENU	r54	72h 35h 34h
ENTER	r10	72h 31h 30h
AUTO POSITION	r09	72h 30h 39h
STILL	ra4	72h 61h 34h

[Example] Display MENU selection bar. (' ' is for ASCII code)

Sending commands from the PC etc.	Status code from projector	Meaning
30 30 72 35 34 0D '0' '0' 'r' '5' '4' '↵'		Command as same as MENU button
	30 30 72 35 34 0D '0' '0' 'r' '5' '4' '↵'	Command received (Command echo back)

## 7) Reading command diagram

Monitor projector operation status. The power ON, OFF and input terminal settings can be monitored.

	ASCII		HEX	
	Function	Data (Receive)	Function	Data (Receive)
POWER ON	vP	1	76h 50h	31h
POWER OFF	vP	0	76h 50h	30h
INPUT COMPUTER	vI	r1	76h 49h	72h 31h
INPUT VIDEO	vI	v1	76h 49h	76h 31h
INPUT S-VIDEO	vI	v2	76h 49h	76h 32h

When a personal computer sends the command, data code will not be attached. On the other hand, the projector which has received a command will attach the recent operating status and then send.

[Example ] Input was Video when the operating status of the input terminal was confirmed.

Sending commands from the PC etc.	Status code from projector	Meaning
30 30 76 49 0D '0' '0' 'v' 'I' '↵'		Command to confirm input
	30 30 76 49 76 31 0D '0' '0' 'v' 'I' 'v' 'I' '↵'	Command (Input is Video) carried out

## 8) Menu setting commands

The menu setting commands execute the menu setting of this projector. If the personal computer doesn't send the commands without attaching the data code, the projector which has received the command replays the setting data as data code.

ITEM	ASCII	HEX	VALUE
CONTRAST	P	50h	<b>±30±30±30</b> (R from G+Main data+B from G)
BRIGHTNESS	Q	51h	<b>±30±30±30</b> (R from G+Main data+B from G)
sRGB	SRGB	53h 52h 47h 42h	<b>0</b> (OFF), <b>1</b> (ON)
COLOR MATRIX (MODE)	CMT	43h 4Dh 54h	<b>1</b> (VIDEO), <b>2</b> (COMPUTER), <b>3</b> (USER), <b>4</b> (OFF)
COLOR MATRIX (R, G, B)	MRGB	4Dh 52h 47h 42h	<b>±30±30±30</b> (R+G+B)
COLOR MATRIX (Y, C, M)	MYCM	4Dh 59h 43h 4Dh	<b>±30±30±30</b> (Y+C+M)
COLOR MATRIX (SATURATION)	MSAT	4Dh 53h 41h 54h	<b>±05</b>
COLOR TEMP.	A	41h	<b>1</b> (Standard), <b>2</b> (High), <b>3</b> (Low), <b>4</b> (User)
COLOR	T	54h	<b>±10</b>
TINT	S	53h	<b>±10</b>
SHARPNESS	R	52h	<b>±10</b>
IRIS	AI	41h 49h	<b>0</b> (OFF), <b>1</b> (1), <b>2</b> (2), <b>3</b> (3)
KEystone	KS	4Bh 53h	<b>±00, ±03, ±06, ±09, ±12, ±15</b>
AUTO POWER ON	APON	41h 50h 4Fh 4Eh	<b>0</b> (OFF), <b>1</b> (ON)
AUTO POWER OFF	APOF	41h 50h 4Fh 46h	<b>00</b> (Off), <b>05, 10, 15, 30, 60</b>

ITEM	ASCII	HEX	VALUE
SPLASH SCREEN	SS	53h 53h	0 (OFF), 1 (ON)
BACK COLOR	BB	42h 42h	0 (BLACK), 1 (BLUE)
LAMP MODE	LM	4Ch 4Dh	0 (STANDARD), 1 (LOW)
IMAGE REVERSE	IR	49h 52h	0 (OFF), 1 (Mirror), 2 (Invert), 3 (Mirror invert)
MENU POSITION	MP	4Dh 50h	0 (Upper left), 1 (Lower right)
EXPAND MODE	EX	45h 58h	1 - 2
AUDIO MODE	AU	41h 55h	1 (COMPUTER), 2 (VIDEO), 3 (COMPUTER & VIDEO), 4 (MUTE)
VIDEO SIGNAL	VS	56h 53h	0 (AUTO), 1 (NTSC), 2 (PAL), 3 (SECAM), 4 (4.43NTSC), 5 (PAL-M), 6 (PAL-N), 7 (PAL-60)
ANAMORPHIC	SC	53h 43h	0 (OFF), 1 (ON)
LANGUAGE	LG	4Ch 47h	0 (日本語), 1 (English), 2 (Español), 3 (Deutsch), 4 (Français), 5 (Italiano), 6 (中文)
RESET ALL	RSTALL	52h 53h 54h 41h 4Ch 4Ch	
MEMORY CALL	MMC	4Dh 4Dh 43h	0 (AUTO), 1 (USER1), 2 (USER2)
HORIZ. POSITION	HP	48h 50h	+ (increase), - (decrease)
VERT. POSITION	VP	56h 50h	+ (increase), - (decrease)
FINE SYNC.	FN	46h 4Eh	00 - 39
TRACKING	TRK	54h 52h 4Bh	+ (increase), - (decrease)
COMPUTER INPUT	CIN	43h 49h 4Eh	0 (RGB), 1 (YCbCr/YpPr)
HOLD	HLD	48h 4Ch 44h	0 (AUTO), 1 (ON), 2 (OFF)
HOLD BEGIN	HLB	48h 4Ch 42h	-01 - -99
HOLD END	HLE	48h 4Ch 45h	01 - 99
CLAMP POSITION	CLP	43h 4Ch 50h	00 - 63
CLAMP WIDTH	CLW	43h 4Ch 57h	01 - 63
HORIZ. PIXELS	HPL	48h 50h 4Ch	0000 - 9999
VERT. LINES	VLN	56h 4Ch 4Eh	0000 - 9999
VERT.SYNC	VSC	56h 53h 43h	0 (AUTO), 1 (ON), 2 (OFF)
SHUTTER (U)	SHU	53h 48h 55h	000 - 383 (000 - 299 for SL1U)
SHUTTER (L)	SHL	53h 48h 4Ch	000 - 383 (000 - 299 for SL1U)
SHUTTER (LS)	SHLS	53h 48h 4Ch 53h	000 - 510 (000 - 398 for SL1U)
SHUTTER (RS)	SHRS	53h 48h 52h 53h	000 - 510 (000 - 398 for SL1U)
MUTE	MUTE	4Dh 55h 54h 45h	0 (MUTE OFF), 1 (MUTE ON)

### How to set the grade

Use ASCII letters code to set the grade for setting data. Please refer to the table below for HEX code.

ASCII	'4'	'-'	'0'	'1'	'2'	'3'	'4'	'5'	'6'	'7'	'8'	'9'
HEX	2Bh	2Dh	30h	31h	32h	33h	34h	35h	36h	37h	38h	39h

[Example 1] Set the AUTO POWER ON to ON.

Sending commands from the PC etc.	Status code from projector	Meaning
30 30 41 50 4F 4E 31 0D '0' '0' 'A' 'P' 'O' 'N' '1' [Enter]		Command for setting the AUTO POWER ON to ON
	30 30 41 50 4F 4E 31 0D '0' '0' 'A' 'P' 'O' 'N' '1' [Enter]	Command received (Command echo back)

The data code of CONTRAST and BRIGHTNESS is structured by the difference data of R from G, the main data and the difference data of B from G.

[Example 2] Set the difference data of R from G to +10, the setting main data to 0 and the difference data of B from to -5.

Sending commands from the PC etc.	Status code from projector	Meaning
30 30 50 2B 31 30 2B 30 30 2D 30 35 0D '0' '0' 'P' '+' '1' '0' '+' '0' '0' '-' '0' '5' [Enter]		Command for setting the picture control
	30 30 50 2B 31 30 2B 30 30 2D 30 35 0D '0' '0' 'P' '+' '1' '0' '+' '0' '0' '-' '0' '5' [Enter]	Command received (Command echo back)

[Example 3] The TINT was set to +10 when the setting status was confirmed.

Sending commands from the PC etc.	Status code from projector	Meaning
30 30 53 0D '0' '0' 'S' [Enter]		Command to confirm setting of TINT
	30 30 53 2B 31 30 0D '0' '0' 'S' '+' '1' '0' [Enter]	Command (setting of TINT is +10) carried out



# Disclaimer

This user manual is provided as a free service by FixYourDLP.com. FixYourDLP is in no way responsible for the content of this manual, nor do we guarantee its accuracy. FixYourDLP does not make any claim of copyright and all copyrights remain the property of their respective owners.

About FixYourDLP.com

FixYourDLP.com (<http://www.fixyourdpl.com>) is the World's #1 resource for media product news, reviews, do-it-yourself guides, and manuals.

Informational Blog: <http://www.fixyourdpl.com>

Video Guides: <http://www.fixyourdpl.com/guides>

User Forums: <http://www.fixyourdpl.com/forum>

FixYourDLP's Fight Against Counterfeit Lamps:

<http://www.fixyourdpl.com/counterfeits>

## Sponsors:

RecycleYourLamp.org – Free lamp recycling services for used lamps:

<http://www.recycleyourlamp.org>

Lamp Research - The trusted 3rd party lamp research company:

<http://www.lampresearch.com>

Discount-Merchant.com – The worlds largest lamp distributor:

<http://www.discount-merchant.com>



**FixYourDLP.com**

Sponsored by 