



# Disclaimer

This user manual is provided as a free service by FixYourDLP.com. FixYourDLP is in no way responsible for the content of this manual, nor do we guarantee its accuracy. FixYourDLP does not make any claim of copyright and all copyrights remain the property of their respective owners.

About FixYourDLP.com

FixYourDLP.com (<http://www.fixyourdpl.com>) is the World's #1 resource for media product news, reviews, do-it-yourself guides, and manuals.

Informational Blog: <http://www.fixyourdpl.com>

Video Guides: <http://www.fixyourdpl.com/guides>

User Forums: <http://www.fixyourdpl.com/forum>

FixYourDLP's Fight Against Counterfeit Lamps:

<http://www.fixyourdpl.com/counterfeits>

## Sponsors:

RecycleYourLamp.org – Free lamp recycling services for used lamps:

<http://www.recycleyourlamp.org>

Lamp Research - The trusted 3rd party lamp research company:

<http://www.lampresearch.com>

Discount-Merchant.com – The worlds largest lamp distributor:

<http://www.discount-merchant.com>



**FixYourDLP.com**

Sponsored by 

# PLUS

## DATA PROJECTOR

# U5-632h/U5-732h

# U5-532h/U5-512h

## User's Manual

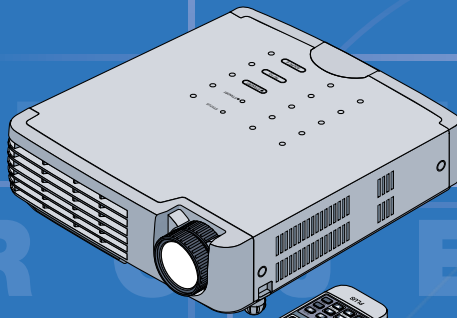

(U5-532h/U5-512h)

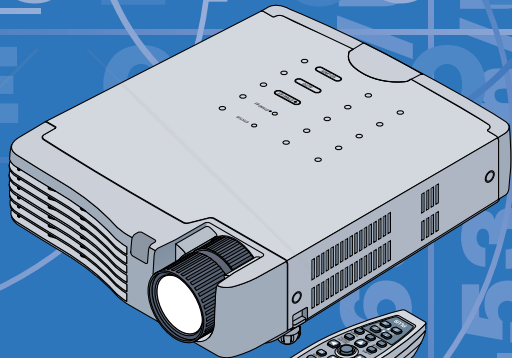

(U5-632h)

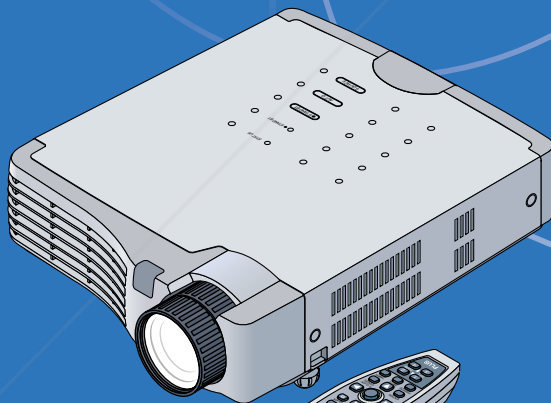

(U5-732h)



FixYourDLP.com

Sponsored by 

### IMPORTANT

- \* DLP™ (Digital Light Processing) and DLP™ chip are registered trademarks of Texas Instruments Incorporated (U.S.A.).
- \* DLP™ chip is an ultra-precise part developed by Texas Instruments (U.S.A.) which takes the place of liquid crystal (in the projector).
- \* VGA and XGA are trademarks or registered trademarks of International Business Machines Corporation (U.S.A.).
- \* S-VGA is a registered trademark of Video Electronics Standards Association.
- \* Microsoft, Windows, and PowerPoint are registered trademarks of Microsoft Corporation (U.S.A. and other countries).
- \* Macintosh is a trademark of Apple Computer Inc. (U.S.A.).

Note that even in the absence of explanatory notes, serious attention is paid to the trademarks of the various companies and to the product trademarks.

# IMPORTANT SAFETY INFORMATION

## Precautions

Please read this manual carefully before using your PLUS Data Projector and keep the manual handy for future reference. This User's Manual applies to the U5-632h, U5-732h, U5-532h and U5-512h Data Projectors. The resolution differs from model to model, and not all models have the high brightness black/white mode or the PC mouse function. This User's Manual describes the U5-632h (the full-function model). Also note that the included remote control unit differs from model to model. Please check the resolution, functions and type of remote control unit on the table below.

Model	Resolution (Full Functions)	Black/White mode	Type of included remote control unit
U5-632h	1024 × 768 (XGA)	○	Wireless remote control unit with laser pointer (w/ PC mouse function)
U5-732h	1024 × 768 (XGA)	—	
U5-532h	1024 × 768 (XGA)	○	Wireless remote control unit (w/o laser pointer or PC mouse function)
U5-512h	800 × 600 (S-VGA)	—	

○: Function included —: Function not included

Applicable projectors will be indicated by **Applicable Projector: U5-XXX** placed at the description location.



## CAUTION

**TO PREVENT SHOCK, DO NOT OPEN THE CABINET. NO USER-SERVICEABLE PARTS INSIDE. REFER SERVICING TO QUALIFIED PLUS SERVICE PERSONNEL.**



This symbol warns the user that uninsulated voltage within the unit may have sufficient magnitude to cause electric shock. Therefore, it is dangerous to make any kind of contact with any part inside of this unit.



This symbol alerts the user that important literature concerning the operation and maintenance of this unit has been included. Therefore, it should be read carefully in order to avoid any problems.

The above cautions are given on the bottom of the product.

## WARNING

**TO PREVENT FIRE OR SHOCK, DO NOT EXPOSE THIS UNIT TO RAIN OR MOISTURE. DO NOT USE THIS UNIT'S GROUNDED PLUG WITH AN EXTENSION CORD OR IN AN OUTLET UNLESS ALL THREE PRONGS CAN BE FULLY INSERTED. DO NOT OPEN THE CABINET. THERE ARE HIGH-VOLTAGE COMPONENTS INSIDE. ALL SERVICING MUST BE DONE BY QUALIFIED PLUS SERVICE PERSONNEL.**

**Applicable Projector: U5-632h/U5-732h**



## CAUTION

**Do not look at the laser pointer's light source.**

Be sure to heed the following. Pointing the laser beam at the eyes could lead to reduced vision or vision impairment.

- Never look at the laser pointer's light source.
- Do not point the laser beam at people.
- Do not let children use the laser pointer.

<b>CAUTION</b> LASER RADIATION DO NOT STARE INTO BEAM WAVELENGTH: 640-650nm MAX OUTPUT: 5mW CLASS II LASER PRODUCT	COMPLIES WITH ICHS 21 CFR SUBCHAPTER J REMOTE CONTROL MODEL: U5-V3-200R PLACE OF MANUFACTURE: B MANUFACTURED: OCTOBER 2003 MADE IN CHINA
	INTERLINK ELECTRONICS SHINODA BLDG., HIGASHIKANDA 1-107, CHIYODAKU, TOKYO, JAPAN

レーザ光線 照らす光線を直接見ると、目や皮膚にダメージを与える可能性があります。直射光線は避けてください。 波長: 640-650nm 最大出力: 5mW 規格: EN 60825-1:1994+A1:1997+A2:2001 EN 60825-1:1994+A2:2001+A1:2002 LWA OUTPUT: 5mW WAVELENGTH: 640-650nm	RAYONNEMENT LASER NE PAS REGARDER DANS LE FAISCEAU APPAREIL A LASER DE CLASSE 2 LASER-STRAHLUNG NICHT IN DEN STRAHL BLICKEN LASER KLASSE 2 PRODUKT	注意 レーザ光線は直射すると、目や皮膚にダメージを与える可能性があります。直射光線は避けてください。 波長: 640-650nm 最大出力: 5mW 規格: EN 60825-1:1994+A1:1997+A2:2001 EN 60825-1:1994+A2:2001+A1:2002 LWA OUTPUT: 5mW WAVELENGTH: 640-650nm
--	---	--

**This label is located on the side of the remote control.**

Hg: Lamp in This Product Contains Mercury. Dispose of Lamp According to Local, State or Federal Law.

## WARNING

This is a class A product. In a domestic environment this product may cause radio interference in which case the user may be required to take adequate measures.

## Interference

Sponsored by

## WARNING

The Federal Communications Commission does not allow any modifications or changes to the unit EXCEPT those specified by PLUS Vision in this manual. Failure to comply with this government regulation could void your right to operate this equipment. This equipment has been tested and found to comply with the limits for a Class A digital device, pursuant to Part 15 of the FCC Rules. These limits are designed to provide reasonable protection against harmful interference when the equipment is operated in a commercial environment. This equipment generates, uses, and can radiate radio frequency energy and, if not installed and used in accordance with the instruction manual, may cause harmful interference to radio communications. Operation of this equipment in a residential area is likely to cause harmful interference in which case the user will be required to correct the interference at his own expense.

## DOC Compliance Notice

This Class A digital apparatus meets all requirements of the Canadian Interference-Causing Equipment Regulations.

## IMPORTANT SAFETY INFORMATION

---

### Important Safeguards

These safety instructions are to ensure the long life of the unit and to prevent fire and shock. Please read them carefully and heed all warnings.

#### Installation

- For best results, use the unit in a darkened room.
- Place the unit on a flat, level surface in a dry area away from dust and moisture.
- Do not place the unit in direct sunlight, near heaters or heat radiating appliances.
- Exposure to direct sunlight, smoke or steam can harm internal components.
- Handle the unit carefully. Dropping or jarring can damage internal components.
- Do not place heavy objects on top of the unit.

#### Power Supply

- The unit is designed to operate on a power supply of 100 – 120/220 – 240 V 50/60 Hz AC. Ensure that your power supply fits these requirements before attempting to use the unit.
- Handle the power cable carefully and avoid excessive bending. A damaged cord can cause electric shock or fire.
- Disconnect the power cable (mains lead) from the power outlet after using the unit. Before disconnecting the power cable, make sure that the STANDBY indicator lights in amber (not blinking or in green).

#### Cleaning

- Disconnect the power cable (mains lead) from the unit.
- Clean the cabinet of the unit periodically with a damp cloth. If heavily soiled, use a mild detergent. Never use strong detergents or solvents such as alcohol or thinner.
- Use a blower or lens paper to clean the lens, and be careful not to scratch or mar the lens.
- Clean the ventilation slots and speaker grills on the unit periodically using a vacuum cleaner. If accumulated dust blocks the ventilation slots, the unit will overheat, which may cause the unit to malfunction. Use a soft brush attachment when using the vacuum cleaner. Do not use a hard attachment, such as a crevice tool, to prevent the damage to the unit.

#### Lamp Replacement

- Be sure to replace the lamp when the Status indicator comes on. If you continue to use the lamp after 2000 hours of usage, the lamp will turn off.

#### Fire and Shock Precautions

- Ensure that there is sufficient ventilation and that vents are unobstructed to prevent the buildup of heat inside the unit. Allow at least 10 cm (3 inches) of space between the unit and walls.
- Prevent foreign objects such as paper clips and bits of paper from falling into the unit. Do not attempt to retrieve any objects that fell into the unit. Do not insert any metal objects such as a wire or screwdriver into the unit. If something should fall into the unit, immediately disconnect the power cable from the unit and have the object removed by a qualified PLUS service person.
- Do not place any liquids on top of the unit.

#### Cautions on Handling the Storage Case

- Do not put anything other than the unit or its accessories in the storage case. Paper clips, staples or other metal or foreign objects getting inside could cause fire or electric shock.
- Do not swing the storage case around when the unit is inside. Also do not force objects that are too large to fit into the storage case. Doing so could scratch or damage the unit.



FixYourDLP.com

#### When Moving the Unit

- When moving the unit to a different place, put it in the included storage case and place the storage case in an insulating package to protect against falls and shocks.
- If there are paper clips, staples or other metal or foreign objects inside the storage case, the objects could get inside the unit while the unit is being moved, causing fire or electric shock when the power is turned on.

#### CAUTION – HOT!

The area around the exhaust vents is hot during and immediately after image projection.

To avoid burns, keep your hands away from this area.

Wait until the exhaust vents area cools off before touching it.

**Do not look into the lens while the unit is on. Serious damage to your eyes could result.**

# Major Features

## ■ Lightweight high-intensity projector

The synergy of the DLP™ (Digital Light Processing) display system and our own optical design serve to improve the optical utilization efficiency. The three primary colors (RGB) required in color expression are reproduced with one DLP™ chip. These factors have enabled a design that offers both high intensity and small size/lightweight features.

## ■ Sharp, clear picture

The DLP™ display system affords RGB color fidelity and inconspicuous gaps between the individual dots, thereby permitting the display of small characters and diagrams with distinct clarity.

## ■ Industry's first B/W mode for switching from the color mode to an image with a stronger brightness

Applicable Projector: U5-632h/U5-532h

When projecting documents, spreadsheets or other mostly black and white data, the image can be projected with stronger brightness than in the color mode by switching to the "Color B/W Switching" in the menu settings. This function is a first for a projector, and takes advantage of the features of high contrast rate DLP projectors.

## ■ Powerful functions for presentations

A wide variety of easy-to-set functions have been built into the projector, from a digital keystone correction function (used when making settings) that corrects picture distortion, to an auto adjustment function that automatically identifies the PC signal.

A presentation timer that supports presentations and a security lock function protecting against unauthorized projection have also been added.

## ■ High contrast ration of 2000:1

Use of a new generation of DLP™ chip devices has given birth to an amazing 2000:1 high contrast ratio.

By widening the difference of brightness between black and white, you can see a degree of sharpness that is greater than just the brightness based on specifications.

## ■ Beautiful reproduction of high-quality images from DVD

Faithful reproduction of color tones gives rise to the display of natural images. High-quality images such as those from DVD and digital high-definition television broadcasts bring out the display capabilities that are an essential strength of the DLP™ display system projector.

## ■ Econo-mode switch function for the lamp output

Using the lamp Econo-mode will extend the life of the lamp and lower the power consumption.

By switching the lamp mode to suit your operating environment, you will save on lamp cost as well as contribute to energy conservation and ecology.



**Discount-Merchant.com (800) 281-8860**  
**THE TRUSTED SOURCE FOR PROJECTOR LAMPS AND ACCESSORIES**

# Table of Contents

<b>IMPORTANT SAFETY INFORMATION</b> .....	<b>E-2</b>
<b>Major Features</b> .....	<b>E-4</b>
<b>Table of Contents</b> .....	<b>E-5</b>
<b>Checking the Supplied Accessories</b> .....	<b>E-7</b>
<b>Names of the Main Unit Parts</b> .....	<b>E-9</b>
<b>Names of the Remote Control Parts/Preparing the Remote Control</b> .....	<b>E-11</b>
Names of Parts/Preparing the Remote Control Unit	
Included with the U5-632h and U5-732h .....	E-11
Names of Parts/Preparing the Remote Control Unit	
Included with the U5-532h and U5-512h .....	E-12
Remote Control Range .....	E-12
<b>The Procedure Up to Projecting to the Screen</b> .....	<b>E-13</b>
<b>Placement Guide</b> .....	<b>E-14</b>
U5-632h Screen Size and Projection Distance .....	E-14
U5-732h Screen Size and Projection Distance .....	E-15
U5-532h/U5-512h Screen Size and Projection Distance .....	E-16
<b>Connecting Personal Computers and Video Equipment</b> .....	<b>E-17</b>
Connections with Personal Computer .....	E-17
Connect the projector's RGB connector using the included RGB signal cable. ..	E-17
To Output the External Output Signal of a Notebook Computer .....	E-18
Connections with Composite Signals .....	E-19
Video Equipment with VIDEO Connectors .....	E-19
Video Equipment with S-VIDEO Connectors .....	E-19
Connections with Component Signals .....	E-20
When the Video Equipment Has a YCbCr Connector or YPbPr Connector .....	E-20
Connections with the AUDIO Jack .....	E-21
Connections with the RGB OUT Connector .....	E-22
<b>Power Cable Connections and Switching the Power On/Off</b> .....	<b>E-23</b>
Operating .....	E-23
Finishing .....	E-25
<b>Adjustment of the Projection Screen</b> .....	<b>E-26</b>
Adjustment of the Projection Screen .....	E-26
Making Adjustments with the Adjusters .....	E-27
<b>General Operation</b> .....	<b>E-28</b>
Input Selection .....	E-28
Automatic Adjustment .....	E-28
Selection of Aspect Ratio .....	E-29
Freezing a Moving Picture .....	E-30
Cancelling Video and Audio Temporarily .....	E-30
Lamp Mode .....	E-30
Keystone .....	E-31
Adjustment of the Volume .....	E-31
Enlargement of the Image and Video Movement .....	E-32
Using the Presentation Timer .....	E-33
Using the Laser Pointer .....	E-34
Performing Mouse Operations on the Computer	
with the Remote Control Unit .....	E-35
Controlling the Projector from a Computer .....	E-36
Use as a High-Brightness Monochrome Projector .....	E-36
Protecting the Projector with the Security Lock .....	E-37
Using the Quick Menu .....	E-39
<b>Menu Operation Method</b> .....	<b>E-40</b>
Performing Menu Operations .....	E-42
List of Item Names Offering Input Selection and Adjustments/Settings .....	E-45
<b>Image</b> .....	<b>E-47</b>
Brightness / Contrast / Color / Tint / Sharpness .....	E-47
Picture Adj. / Fine Picture / H Position / V Position .....	E-47
Reset .....	E-48

## Table of Contents

---

<b>Color</b> .....	<b>E-49</b>
Quick Color Adj. ....	E-49
Gamma .....	E-49
Color Temp. ....	E-50
White .....	E-50
Color Space .....	E-50
White Balance .....	E-51
<b>View</b> .....	<b>E-52</b>
Aspect .....	E-52
Filter .....	E-52
Vertical Flip .....	E-53
Keystone .....	E-53
Keystone Save .....	E-53
<b>Setup</b> .....	<b>E-54</b>
Color B/W Switching .....	E-54
Auto Source .....	E-54
Auto Power Off .....	E-54
Menu Position .....	E-55
Lamp Mode .....	E-55
Input Format .....	E-56
Presentation Timer .....	E-56
<b>Option</b> .....	<b>E-57</b>
Language .....	E-57
On Screen .....	E-57
Background .....	E-57
Startup Screen .....	E-58
Security Lock .....	E-58
<b>Info</b> .....	<b>E-59</b>
Status .....	E-59
Factory Default .....	E-59
Lamp Timer Reset .....	E-59
Resolution / Frequency .....	E-60
Lamp Timer .....	E-60
<b>When an Indicator is Lit or Flashing</b> .....	<b>E-61</b>
<b>Troubleshooting</b> .....	<b>E-62</b>
<b>Cleaning</b> .....	<b>E-63</b>
<b>Replacing the Lamp Cartridge</b> .....	<b>E-64</b>
<b>Specifications</b> .....	<b>E-67</b>
<b>Table of Supported Frequency</b> .....	<b>E-71</b>
<b>Cabinet Dimensions</b> .....	<b>E-72</b>



**Discount-Merchant.com (800) 281-8860**  
**THE TRUSTED SOURCE FOR PROJECTOR LAMPS AND ACCESSORIES**

# Checking the Supplied Accessories

Remove the main unit and the accessories from the box and check that the following items are included.

## Wireless remote control unit with laser pointer [1] / Size AAA batteries [2]

Applicable Projector: U5-632h/U5-732h  
This controls the projector. (See Page E-11.)

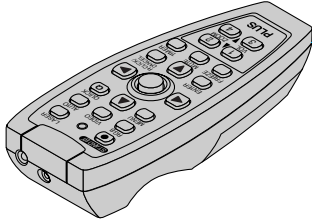

\* The wireless remote control is sold separately for the U5-532h and U5-512h.  
VR-100 remote mouse set (sold separately)  
(Ordering code: 28-052)

## Wireless remote control unit (includes one button battery) [1]

Applicable Projector: U5-532h/U5-512h  
This controls the projector. Please remove the transportation insulation sheet at time of purchase. (See Page E-12.)

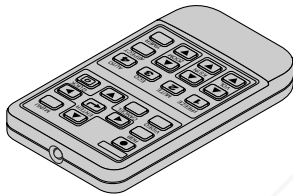

## RGB signal cable (Mini D-sub 15-pin, 2 m / 6.6 feet) [1]

This is used in making connections with a personal computer. See Page E-17 about connections.  
No. 777709000

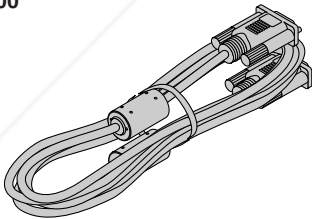

## Power cable (1.8 m / 5.9 feet) [1]

This cable supplies power to the unit. See Page E-23 about connections.

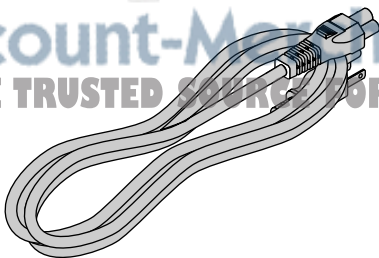

## S-Video cable (Mini DIN 4-pin plug, 2 m / 6.6 feet) [1]

Applicable Projector: U5-632h/U5-732h/U5-532h  
This cable is used in the connection of video equipment that has an S-video connector. Connections are described on Page E-19.

No. 777704000

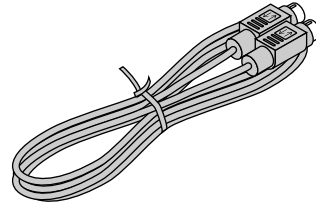

## Video cable (RCA pin plug, 2 m / 6.6 feet) [1]

Applicable Projector: U5-632h/U5-732h/U5-532h  
This cable is used in the connection of video equipment that has a video connector. Connections are described on Page E-19.

No. 777703000

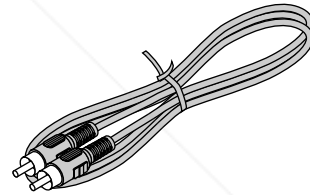

## Audio cable (Mini plug, 2 m / 6.6 feet) [1]

Applicable Projector: U5-632h/U5-732h/U5-532h  
This cable is used with equipment that has phono type audio jacks. Connections are described on Page E-21.  
No. 777705000

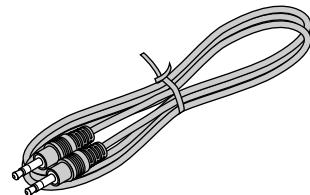

## Audio conversion adapter (Mini-jack/ RCA pin plug, 15 cm / 0.5 feet) [1]

Applicable Projector: U5-632h/U5-732h/U5-532h  
This cable is used with equipment whose audio connector is of the phono pin type. Connections are described on Page E-21.

No. 777706000

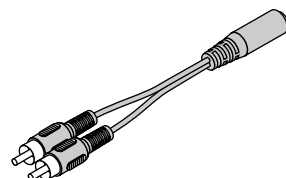



## Checking the Supplied Accessories

### USB cable (type A, 2 m / 6.6 feet) [1]

Applicable Projector: U5-632h/U5-732h

Used to perform mouse operations on a computer using the projector's remote control unit. Connections are described on Page E-35.

No. 777707000

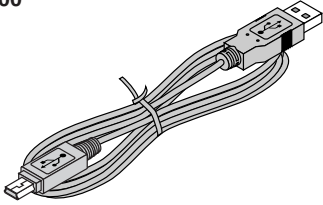

\* The wireless remote control is sold separately for the U5-532h and U5-512h.

VR-100 remote mouse set (sold separately)

(Ordering code: 28-052)

### Storage case (for projector and accessories) [1]

Applicable Projector: U5-632h/U5-732h/U5-532h

This case is designed to hold the projector itself and its accessories.

Use it when storing the projector.

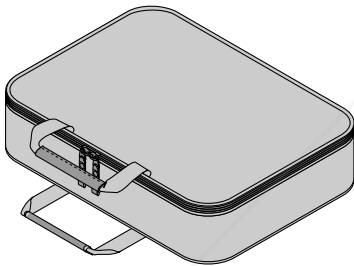

#### HOW TO PUT THE PROJECTOR INTO THE STORAGE CASE

Close the lens shutter or lens cap before putting the projector in its case, then fasten the projector in place with the Velcro belt. Place the accessories in the storage pocket.

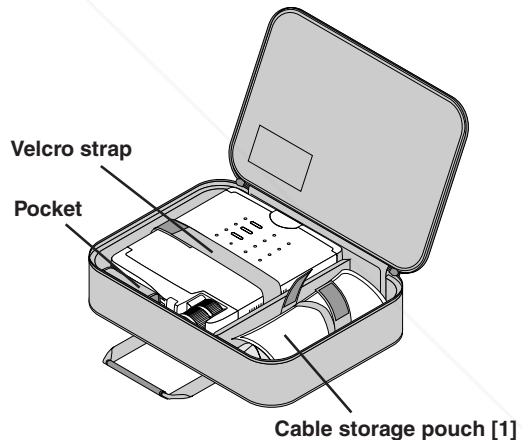

User's Manual (CD-ROM edition) [1]

User's Manual (Simplified Edition) [1]

Security Sheet [1]

Security Label [1]



FixYourDLP.com

Discount Merchant.com (800) 281-8860

THE TRUSTED SOURCE FOR PROJECTOR LAMPS AND ACCESSORIES

# Names of the Main Unit Parts

Applicable Projector: U5-632h

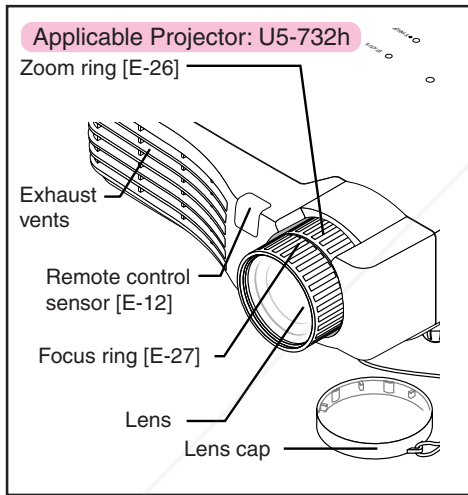
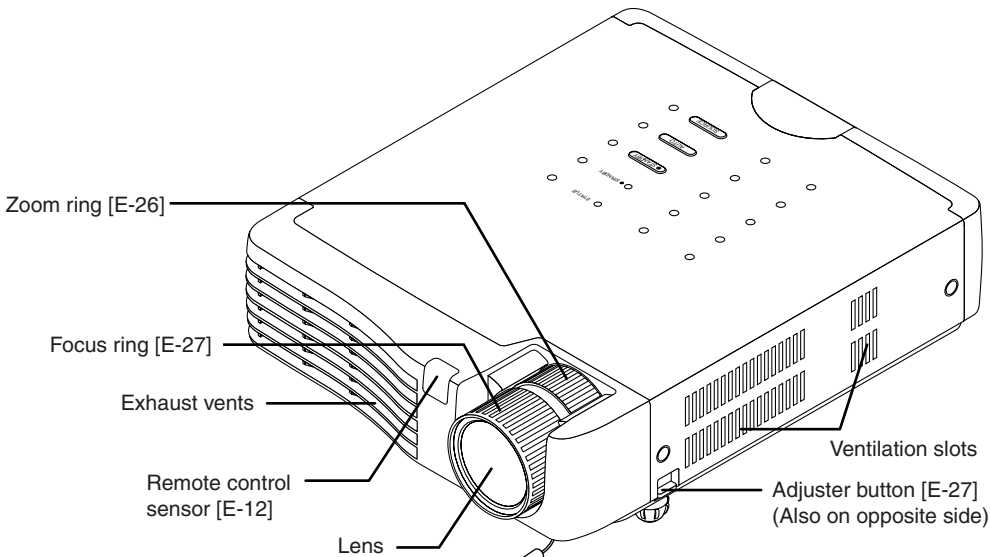

Lens cap  
Remove before use. Attach the lens cap after use to protect the lens.

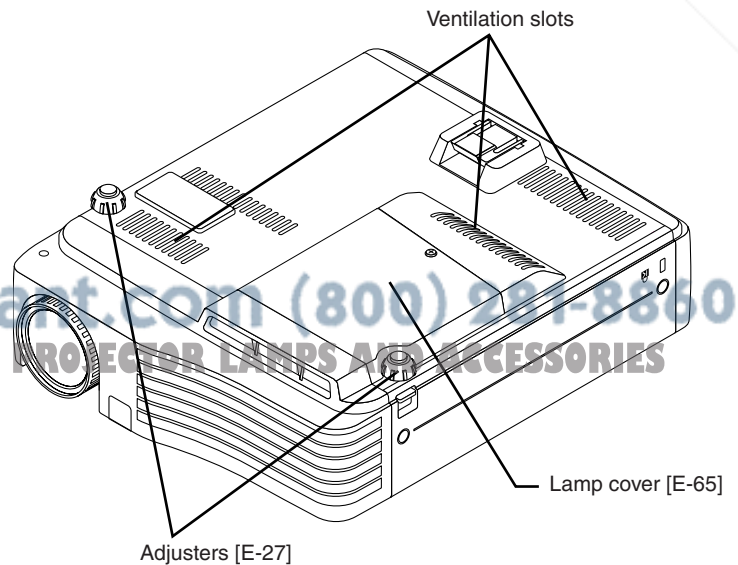
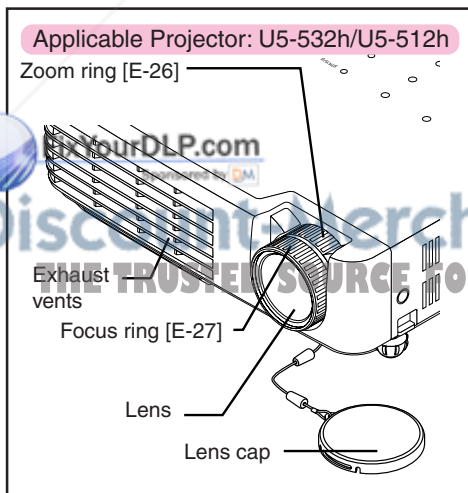

## Names of the Main Unit Parts

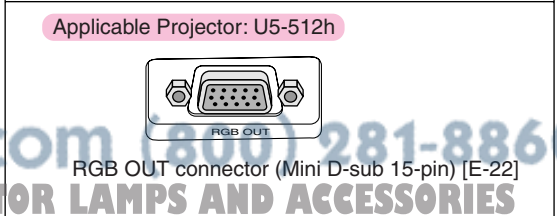
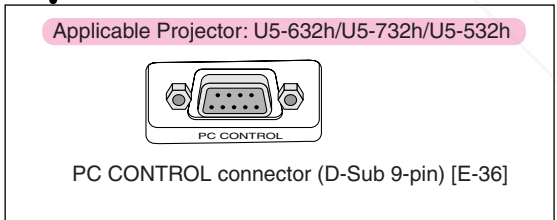
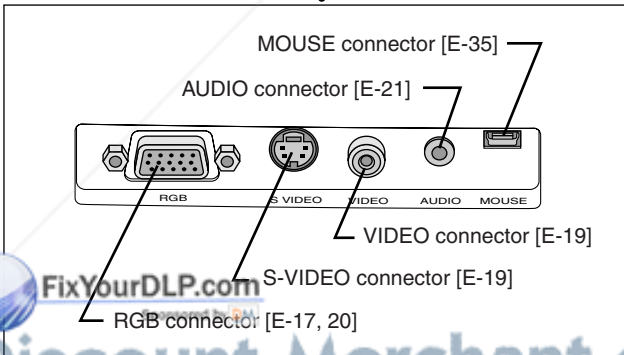
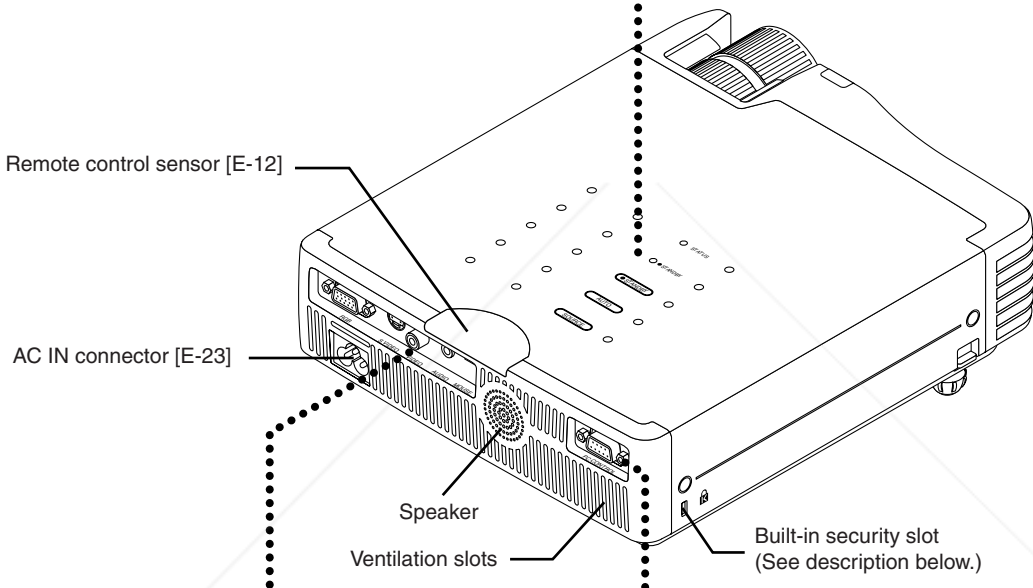
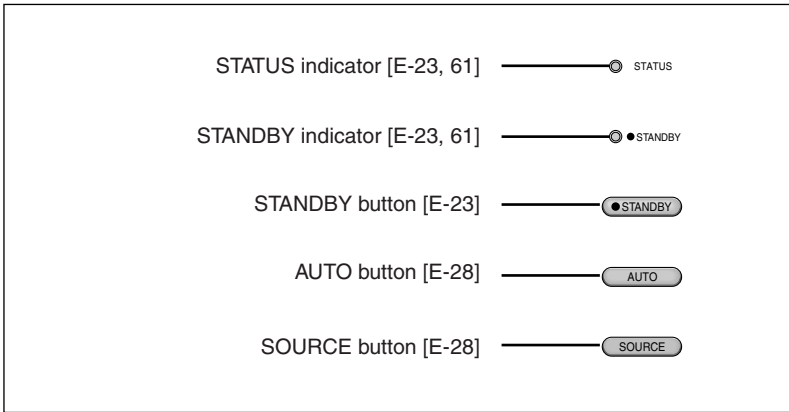

### Built-in Security Slot

This security slot supports the MicroSaver Security System manufactured by Kensington Microware Inc.

# Names of the Remote Control Parts/Preparing the Remote Control

There are two types of remote control units included with the U5 series of projectors. Both types are described below. Refer to the description (and diagram) for the remote control unit included with your projector.

## Precautions

### Handling of the Remote Control

- \* Do not drop the remote control or handle it inappropriately.
- \* Do not expose the remote control to water or other liquids. Should the remote control become wet, wipe it dry immediately.
- \* Try to avoid use in hot and/or humid locations.
- \* Please keep button batteries out of the reach of children. If a battery is swallowed, promptly obtain the medical care of a doctor.
- \* Remove the batteries from the remote control when it is not going to be used for a long period.
- \* Some operations (such as menu operations) are available only through the use of the remote control and attention should be given to its careful handling.

## Names of Parts/Preparing the Remote Control Unit Included with the U5-632h and U5-732h

Applicable Projector:  
U5-632h/U5-732h

### Names of the Remote Control Parts

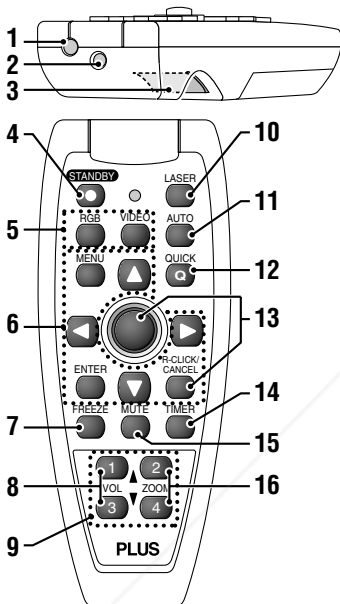

1. Infrared transmitter [E-12]
2. Laser transmitter [E-34]
3. L-CLICK button [E-35]
4. STANDBY button [E-23, 25]  
This button is used to switch ON the power and set the unit to the STANDBY mode.
5. Buttons used for input selection [E-28]  
RGB button and VIDEO button (VIDEO / S-VIDEO)
6. Buttons used for menu operations [E-40]  
The , , and buttons are the select ( , , and buttons.
7. FREEZE button [E-30]  
(Freezes moving pictures)
8. VOL button [E-31]  
(Volume adjustment)
9. Number buttons [E-37]  
(Used for the security lock.)
10. LASER button [E-34]  
(Turns the laser point on and off)

11. AUTO button [E-28]  
(Automatic adjustment of the RGB moving image)
12. QUICK button [E-39]  
(Displays a simplified menu)
13. Buttons used for the PC mouse function [E-35]  
(JOG button and R-CLICK button)
14. TIMER button [E-33]  
(Presentation timer time setting display)
15. MUTE button [E-30]  
(Temporarily cancels the video and audio)
16. ZOOM button [E-32]  
(Digital zoom adjustment)

#### Note:

If a button on the remote control unit is held in continuously for approximately 30 seconds, signal transfer will be suspended. To resume transferring signals, press the button again. Also, to use the jog button after signal transfer has been suspended, first press any other button, then press the jog button.

### Inserting the Batteries

When using the remote control for the first time, install the batteries that were supplied.

1 Slide the battery compartment cover (located on the bottom of the remote control) and pull off.

2 Insert the batteries to match the "+" and "-" as indicated inside the compartment.

3 (A) Leaving a little space in the front, close the lid, (B) then with the back pressed tightly, (C) press the lid towards the front.

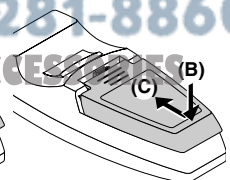
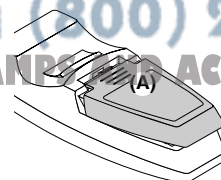
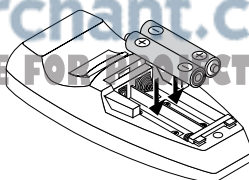
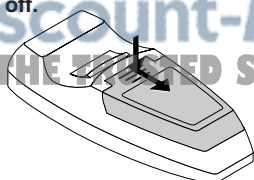

#### CAUTION

When replacing batteries, purchase two of the same type of AAA battery. Heed the regulations in effect in your region on the disposal of spent batteries.

**Names of Parts/Preparing the Remote Control Unit Included with the U5-532h and U5-512h**

Applicable Projector: U5-532h/U5-512h

**Names of the Remote Control Parts**

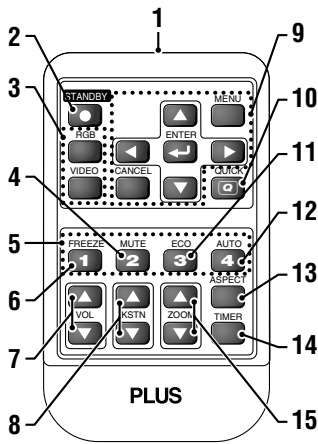

- 1. Infrared transmitter [E-12]
- 2. STANDBY button [E-23, 25]  
This button is used to switch ON the power and set the unit to the STANDBY mode.
- 3. Buttons used for input selection [E-28]  
RGB button and VIDEO button (VIDEO / S-VIDEO)
- 4. MUTE button [E-30]  
(Temporarily cancels the video and audio)
- 5. Number buttons [E-37]  
(Used for the security lock.)
- 6. FREEZE button [E-30]  
(Freezes moving pictures)
- 7. VOL button [E-31]  
(Volume adjustment)
- 8. KSTN button [E-31]  
(Keystone correction adjustment)
- 9. Buttons used for menu operations [E-40]  
The  $\blacktriangle$ ,  $\blacktriangledown$ ,  $\blacktriangleleft$  and  $\blacktriangleright$  buttons are the select ( $\blacktriangle$ ,  $\blacktriangledown$ ,  $\blacktriangleleft$  and  $\blacktriangleright$ ) buttons.
- 10. QUICK button [E-39]  
(Displays a simplified menu)
- 11. ECO button [E-30]  
(Selection of lamp mode)
- 12. AUTO button [E-28]  
(Automatic adjustment of the RGB moving image)
- 13. ASPECT button [E-29]  
(Selects the vertical and horizontal ratio of the screen)
- 14. TIMER button [E-33]  
(Presentation timer time setting display)
- 15. ZOOM button [E-32]  
(Digital zoom adjustment)

**Button Battery Replacement**

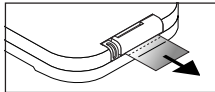

**Using the remote control for the first time**

The battery compartment is fitted with a transportation insulation sheet at the time of shipping. Pull out the sheet and remove it. The remote control is now ready for use.

**Replacement Method**

**1** (A) With the knob pressed to the right side, (B) draw out the battery case.

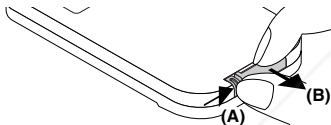

**2** Remove the old battery and install a new button battery with (+) side facing upward in the battery holder.

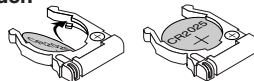

Purchase a CR2025 type battery for replacement.

**3** Insert the battery holder into the remote control and push in until the battery holder closes with a "click" sound.



**CAUTION**

Danger of explosion if battery is incorrectly replaced.  
Replace only with the same or equivalent type (CR2025) recommended by the manufacturer.  
Dispose of used batteries according to your local regulations.

**Remote Control Range**

Point the infrared transmitter of the remote control toward the remote control sensor located at the front or rear of the main unit and operate. Reception of the remote control signal should generally be possible within the range illustrated below.

Applicable Projector: U5-632h/U5-732h

Applicable Projector: U5-532h/U5-512h

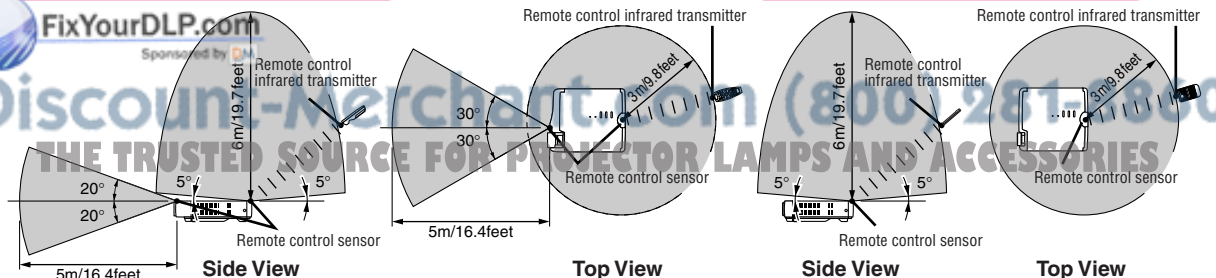

**Note**

- \* Exposure of the main unit's remote control sensor or the remote control infrared transmitter to bright light or the obstruction of the signal by an obstacle located in the pathway may prevent operation.
- \* The remote control will not function when the battery is exhausted.

# The Procedure Up to Projecting to the Screen

Perform setup adjustments in the following order.

## 1 Position the projector

Determine the locations to set up the screen and the projector.  
See “Placement Guide” on Page E-14.

## 2 Connect the video equipment and personal computer

### Connect your equipment to the projector.

When making connections with the personal computer’s RGB connector, see “Connections with Personal Computer” on Page E-17.

When making connections with the video equipment’s video connector or an S-video connector, see “Connections with Composite Signals” on Page E-19.

When making connections with the video equipment’s YCbCr connector or YPbPr connector, see “Connections with Component Signals” on Page E-20.

When playing the audio through the built-in speaker of the projector, see “Connections with the AUDIO Jack” on Page E-21.

Monitoring the analog RGB input signal, see “Connections with the RGB OUT Connector” on Page E-22.

Applicable Projector: U5-512h

## 3 Opening the lens cap

## 4 Connecting the power cable and switching on the power

See “Operating” on Page E-23.

See “Finishing” on Page E-25.

## 5 When selecting the language of menu displays, etc.

(Only when the power is first switched on following purchase)

See “When [Menu Language Select] Is Displayed Upon Switching On the Power” on Page E-24.

## 6 Switching on the power of the personal computer and video equipment

## 7 Properly adjust the projection image to the screen

See “Adjustment of the Projection Screen” on Page E-26.

## 8 Selecting input equipment

See “Input Selection” on Page E-28.

## 9 Adjust the screen or video image

Adjust the image to the optimum condition as required.

See the Table of Contents for the adjustment items.

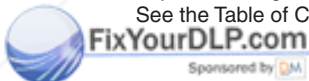

### About DLP projectors

Though careful attention is paid to providing optimum quality, please note that with DLP type projectors, in rare cases there may be black spots or bright spots among the picture elements.

#### Note:

\* Please purchase a screen.

\* A component cable (order code 28-690), which is available separately, is required to connect a DVD player or other equipment with YCbCr connectors.

\* A component cable (order code 28-690), which is available separately, is required to connect high definition (HD) video equipment or other equipment with YPbPr connectors.

# Placement Guide

- Use this information as a guide to find out about the screen size when the projector is placed at a certain location, or to find out the approximate size of a screen that will be required.
- Refer to the projection distance table for your projector model.
- When suspending the projector from the ceiling, change the projection method. See “Vertical Flip” on E-53.

## U5-632h Screen Size and Projection Distance

- The projection distance over which focussing is adjustable is 1.20 m (3.94 feet) to 9.59 m (31.46 feet). The projector should be placed within this range.

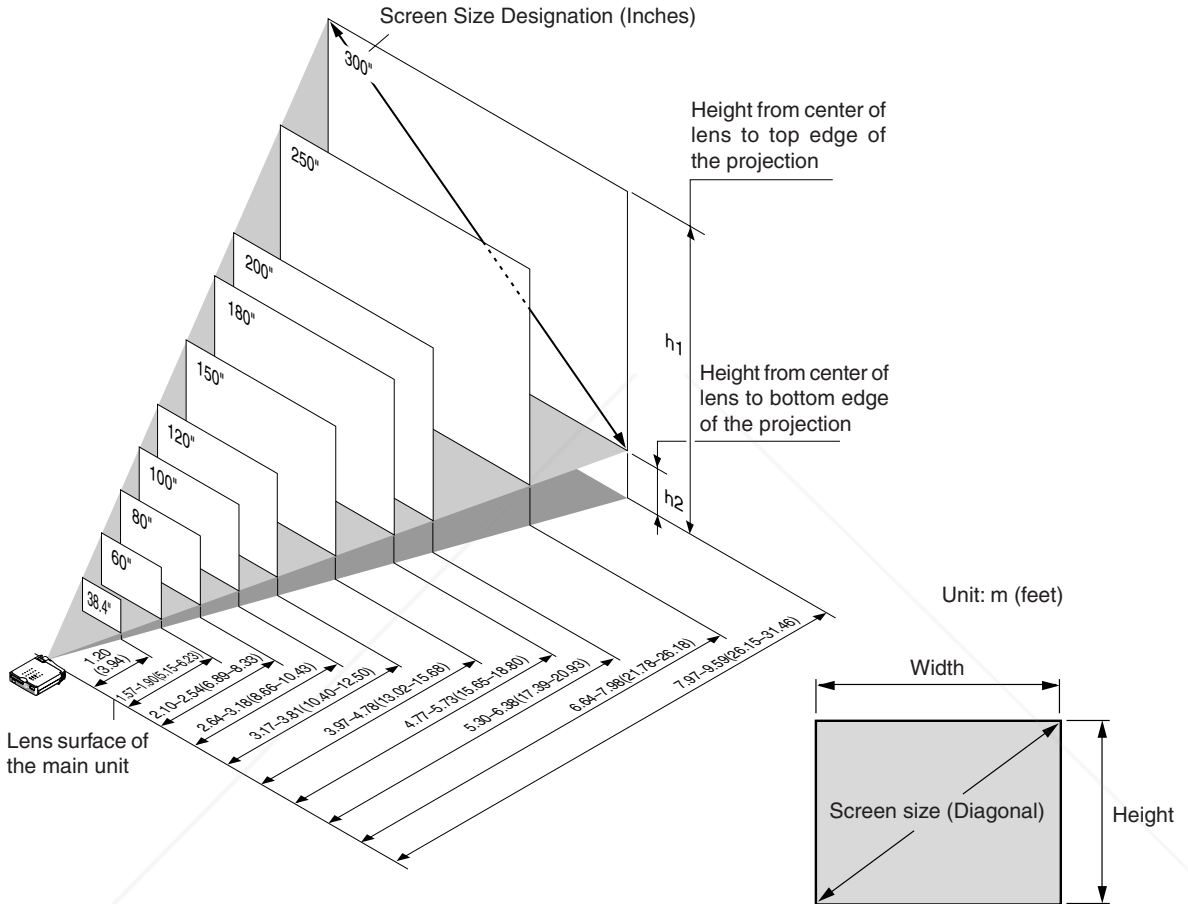

Screen Size Designation (Inches)	Screen Size Width x Height		Projection Distance		Height h1		Height h2	
	(m)	(feet)	(m)	(feet)	(m)	(feet)	(m)	(feet)
38.4"	0.78 × 0.59	2.56 × 1.92	— — 1.20	— — 3.94	0.69	2.26	0.10	0.33
50"	1.02 × 0.91	4.00 × 3.00	1.57 — 1.90	5.15 — 6.23	1.08	3.54	0.16	0.52
80"	1.63 × 1.22	5.33 × 4.00	2.10 — 2.54	6.89 — 8.33	1.43	4.69	0.22	0.72
100"	2.03 × 1.52	6.67 × 5.00	2.64 — 3.18	8.66 — 10.43	1.79	5.87	0.27	0.89
120"	2.44 × 1.83	8.00 × 6.00	3.17 — 3.81	10.40 — 12.50	2.15	7.05	0.32	1.05
150"	3.05 × 2.29	10.00 × 7.50	3.97 — 4.78	13.02 — 15.68	2.69	8.83	0.40	1.31
180"	3.66 × 2.74	12.00 × 9.00	4.77 — 5.73	15.65 — 18.80	3.23	10.60	0.49	1.61
200"	4.06 × 3.05	13.33 × 10.00	5.30 — 6.38	17.39 — 20.93	3.59	11.78	0.54	1.77
250"	5.08 × 3.81	16.67 × 12.50	6.64 — 7.98	21.78 — 26.18	4.48	14.70	0.67	2.20
300"	6.10 × 4.57	20.00 × 15.00	7.97 — 9.59	26.15 — 31.46	5.38	17.65	0.81	2.66

\* There is a tolerance of ±5% due to design values.

\* This table uses the lens apex and lens center as references and requires that the projector be in a horizontal condition (with front and rear adjusters fully withdrawn).

## U5-732h Screen Size and Projection Distance

- The projection distance over which focussing is adjustable is 1.20 m (3.94 feet) to 13.81 m (45.31 feet). The projector should be placed within this range.

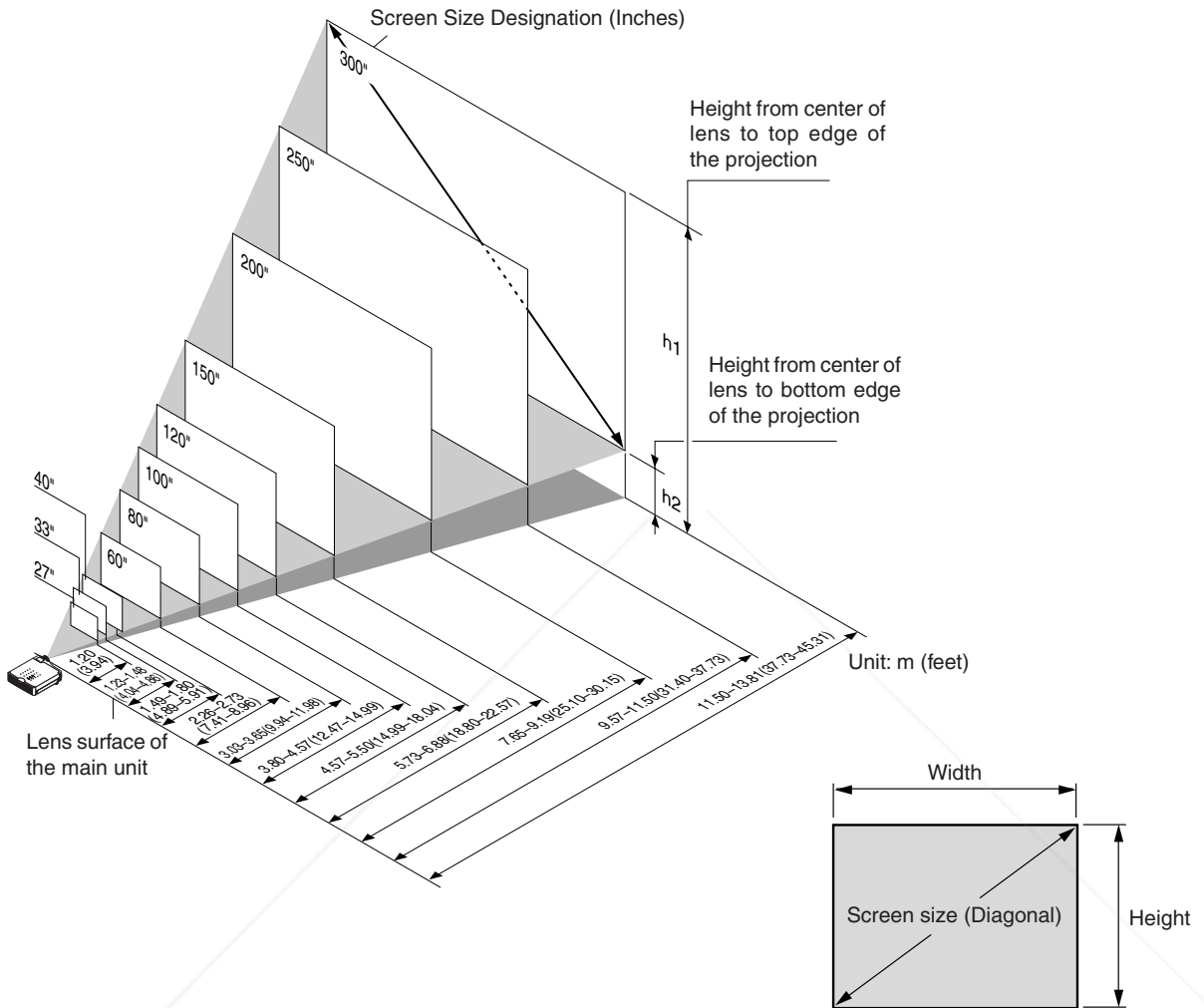

Screen Size Designation (Inches)	Screen Size Width x Height		Projection Distance		Height h1		Height h2	
	(m)	(feet)	(m)	(feet)	(m)	(feet)	(m)	(feet)
27"	0.56 × 0.41	1.83 × 1.35	Wide – Tele	Wide – Tele	0.48	1.57	0.07	0.23
33"	0.67 × 0.50	2.19 × 1.64	1.23 – 1.48	4.04 – 4.86	0.59	1.94	0.09	0.30
40"	0.81 × 0.61	2.65 × 2.00	1.49 – 1.80	4.89 – 5.91	0.72	2.36	0.11	0.36
60"	1.21 × 0.91	3.96 × 2.98	2.26 – 2.73	7.41 – 8.96	1.07	3.51	0.16	0.52
80"	1.62 × 1.21	5.31 × 3.96	3.03 – 3.65	9.94 – 11.98	1.43	4.69	0.22	0.72
100"	2.03 × 1.52	6.66 × 4.98	3.80 – 4.57	12.47 – 14.99	1.79	5.87	0.27	0.89
120"	2.43 × 1.82	7.97 × 5.97	4.57 – 5.50	14.99 – 18.04	2.14	7.02	0.32	1.05
150"	3.04 × 2.28	9.97 × 7.48	5.73 – 6.88	18.80 – 22.57	2.68	8.79	0.40	1.31
200"	4.06 × 3.04	13.32 × 9.97	7.65 – 9.19	25.10 – 30.15	3.58	11.75	0.54	1.77
250"	5.08 × 3.81	16.66 × 12.50	9.57 – 11.50	31.40 – 37.73	4.48	14.70	0.67	2.20
300"	6.09 × 4.57	19.98 × 14.99	11.50 – 13.81	37.73 – 45.31	5.38	17.65	0.81	2.66

\* There is a tolerance of ±5% due to design values.

\* This table uses the lens apex and lens center as references and requires that the projector be in a horizontal condition (with front and rear adjusters fully withdrawn).



**U5-532h/U5-512h Screen Size and Projection Distance**

- The projection distance over which focussing is adjustable is 1.20 m (3.94 feet) to 13.36 m (43.83 feet). The projector should be placed within this range.

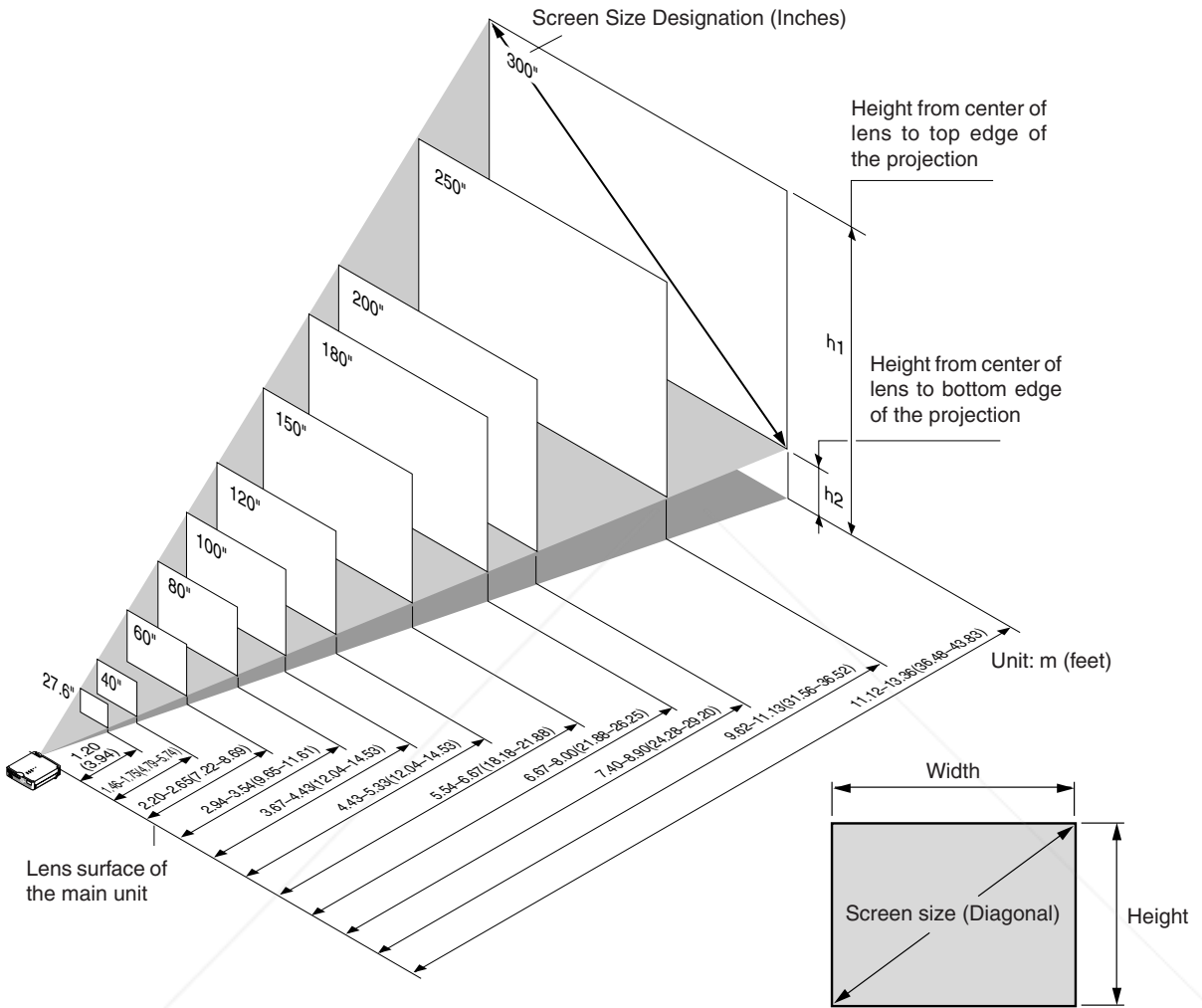

Screen Size Designation (Inches)	Screen Size Width x Height		Projection Distance		Height h1		Height h2	
	(m)	(feet)	(m)	(feet)	(m)	(feet)	(m)	(feet)
27.6"	0.56 × 0.42	1.84 × 1.38	— — 1.20	— — 3.94	0.49	1.61	0.07	0.23
40"	0.81 × 0.61	2.67 × 2.00	1.46 — 1.75	4.79 — 5.74	0.72	2.36	0.11	0.36
60"	1.22 × 0.91	4.00 × 3.00	2.20 — 2.65	7.22 — 8.69	1.07	3.51	0.16	0.52
80"	1.63 × 1.22	5.33 × 4.00	2.94 — 3.54	9.65 — 11.61	1.43	4.69	0.21	0.69
100"	2.03 × 1.52	6.67 × 5.00	3.67 — 4.43	12.04 — 14.53	1.79	5.87	0.27	0.89
120"	2.44 × 1.83	8.00 × 6.00	4.43 — 5.33	14.53 — 17.49	2.15	7.05	0.32	1.05
150"	3.05 × 2.29	10.00 × 7.50	5.54 — 6.67	18.18 — 21.88	2.69	8.83	0.40	1.31
180"	3.66 × 2.74	12.00 × 9.00	6.67 — 8.00	21.88 — 26.25	3.22	10.56	0.48	1.57
200"	4.06 × 3.05	13.33 × 10.00	7.40 — 8.90	24.28 — 29.20	3.59	11.78	0.54	1.77
250"	5.08 × 3.81	16.67 × 12.50	9.62 — 11.13	31.56 — 36.52	4.48	14.70	0.67	2.20
300"	6.10 × 4.57	20.00 × 15.00	11.12 — 13.36	36.48 — 43.83	5.38	17.65	0.81	2.66

\* There is a tolerance of ±5% due to design values.

\* This table uses the lens apex and lens center as references and requires that the projector be in a horizontal condition (with front and rear adjusters fully withdrawn).

# Connecting Personal Computers and Video Equipment

Connecting this unit with a personal computer permits presentation data to be projected as a large screen display at conferences, lectures, and on other occasions. Furthermore, connecting this unit to a DVD player or other video equipment source in combination with an audio/video amplifier and speaker system will allow you to enjoy convincing home theater.

## Connections with Personal Computer

Please check the following before making connections with the personal computer.

- A suitable resolution for the U5-512h is 800 × 600 dots (S-VGA) and the maximum displayable resolution is XGA (1024 × 768 dots).
- A suitable resolution for the U5-632h/U5-732h/U5-532h is 1024 × 768 dots (XGA) and the maximum displayable resolution is S-XGA (1280 × 1024 dots).

Make changes to a displayable resolution at the personal computer side. Please check with “Table of Supported Frequency” on Page E-71.

- The setting method for the personal computer will differ depending on the specific model. Please read the personal computer instruction manual or the on-line help information, or contact the manufacturer of your personal computer.

### Connect the projector's RGB connector using the included RGB signal cable.

- When making connections with the RGB connector of the projector, please make the connection via the supplied RGB signal cable.
- The projector has been set to “Auto” at the factory; however, if it does not project, please change the input setting to “RGB” using the menu sequence of [Setup] → [Input Format] → [RGB]. See “Input Format” on Page E-56.
- If the USB cable is connected to the projector's MOUSE connector, mouse operations can be performed on the computer from the projector's remote control unit. **Applicable Projector: U5-632h/U5-732h**  
See “Performing Mouse Operations on the Computer with the Remote Control Unit” on Page E-35.

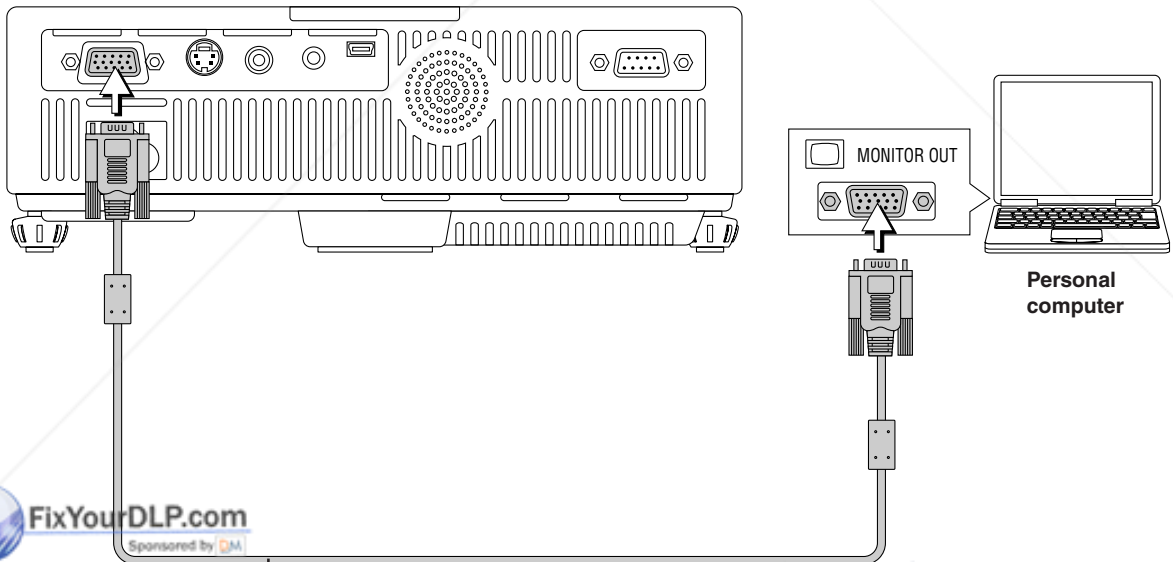

RGB signal cable (Supplied item)

#### Note:

- \* Before making connections, check the power of the projector and the equipment to be connected is switched off.
- \* When projection will be with a notebook computer connected, knowledge will be required for the cable connection and notebook computer startup procedure as well as the operation that follows startup. Please consult the instruction manual of your notebook computer or the on-line help.

### To Output the External Output Signal of a Notebook Computer

When projection will be with a notebook computer connected, knowledge will be required for the cable connection and notebook computer startup procedure as well as the operation that follows notebook startup. Please consult the instruction manual of your notebook computer or the on-line help while performing the following procedure.

- 1** Check whether a signal is being sent from the notebook computer to the projector.  
An indication appearing on the liquid crystal display of the notebook computer does not necessarily mean that an external output signal is being output.  
**REFERENCE:** When “Resolution” or “Frequency” is not displayed under “Info.” on the menu of the projector, this means that the external output signal is not being output from the personal computer. See “Resolution/Frequency” on Page E-60.

- 2** Should a sign not be output from the notebook computer, please try the operation described below.  
For an IBM PC/AT compatible computer, press the [Fn] key plus any one of the [F1] to [F10] keys. (See the table below.)

Manufacturer	Model	Key
DELL	All computers	Fn + F8
EPSON	All computers	Fn + F8
FUJITSU	All computers	Fn + F10
iiyama	All computers	Fn + F3
IBM	All computers	Fn + F7
NEC	All computers	Fn + F3
Panasonic	All computers	Fn + F3
SHARP	All computers	Fn + F5
SONY	All computers	Fn + F7
SOTEC	All computers	Fn + F3–F5
TOSHIBA	All computers	Fn + F5
Victor	All computers	Fn + F10

Note: Table information is current to December 2003.



**Discount-Merchant.com (800) 281-8860**  
**THE TRUSTED SOURCE FOR PROJECTOR LAMPS AND ACCESSORIES**

**Note:**

When the liquid crystal display of the notebook computer and the projector are displayed at the same time, the projected image might not be correct even though the liquid crystal display shows a correct indication. Should this occur, stop the simultaneous display of the notebook computer and try the mode with external output only. Try an operation such as that described in aforementioned Step 2 and try closing the liquid crystal panel which might result in external output only.

**Connections with Composite Signals**

Applicable Projector: U5-632h/U5-732h/U5-532h

**Video Equipment with VIDEO Connectors**

- The input setting of the VIDEO connector has been set to “Auto” at the factory; however, if the projector does not project, please change the input setting to “Your Country’s Television Broadcast System” using the menu sequence of [Setup] → [Input Format] → [Video].  
See “Input Format” on Page E-56.

**Video Equipment with S-VIDEO Connectors**

- Make the connection to the S-VIDEO connector of the projector using the supplied S-video cable.
- The input setting of the S-VIDEO connector has been set to “Auto” at the factory; however, if the projector does not project, please change the input setting to “Your Country’s Television Broadcast System” using the menu sequence of [Setup] → [Input format] → [S-Video].  
See “Input Format” on Page E-56.

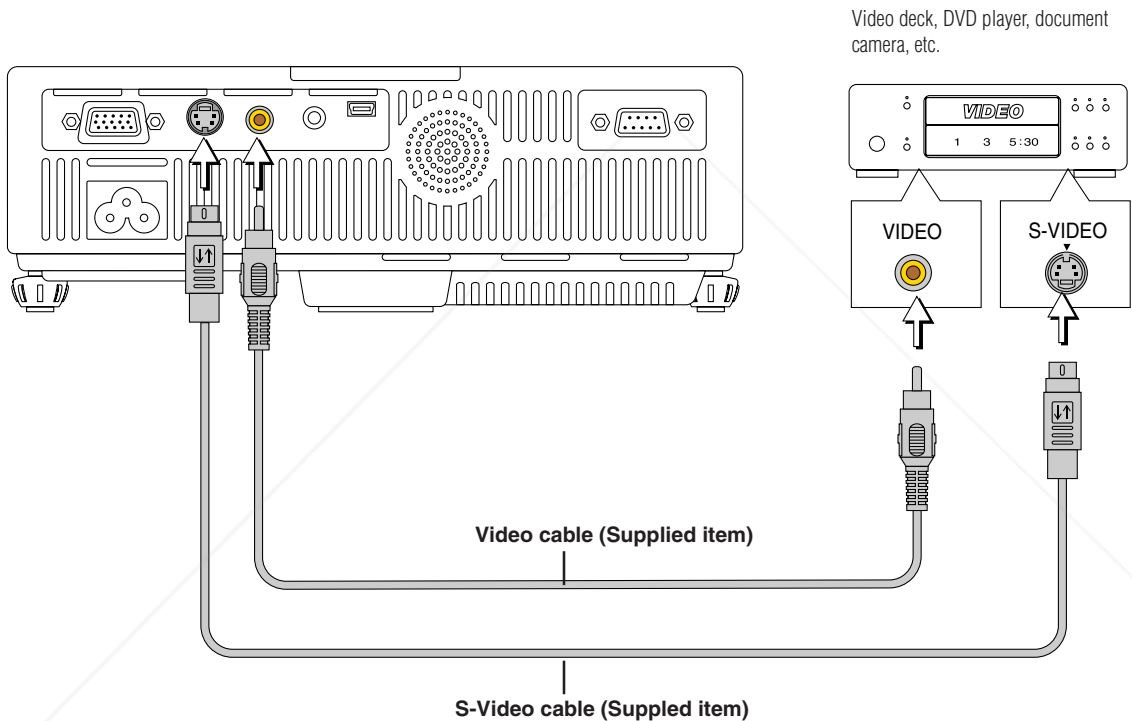

**Discount-Merchant.com (800) 281-8860**  
**THE TRUSTED SOURCE FOR PROJECTOR LAMPS AND ACCESSORIES**

## Connections with Component Signals

### When the Video Equipment Has a YCbCr Connector or YPbPr Connector

- The projector has been set to “Auto” at the factory; however, if it does not project, please change the input setting to “Component” using the menu sequence of [Setup] → [Input Format] → [RGB]. See “Input Format” on Page E-56.
- When projecting the YCbCr signal or YPbPr signal, if the color of the overall image strongly leans toward being greenish or another color, change the setting under the menu of [Color] → [Color Space]. See “Color Space” on Page E-50.

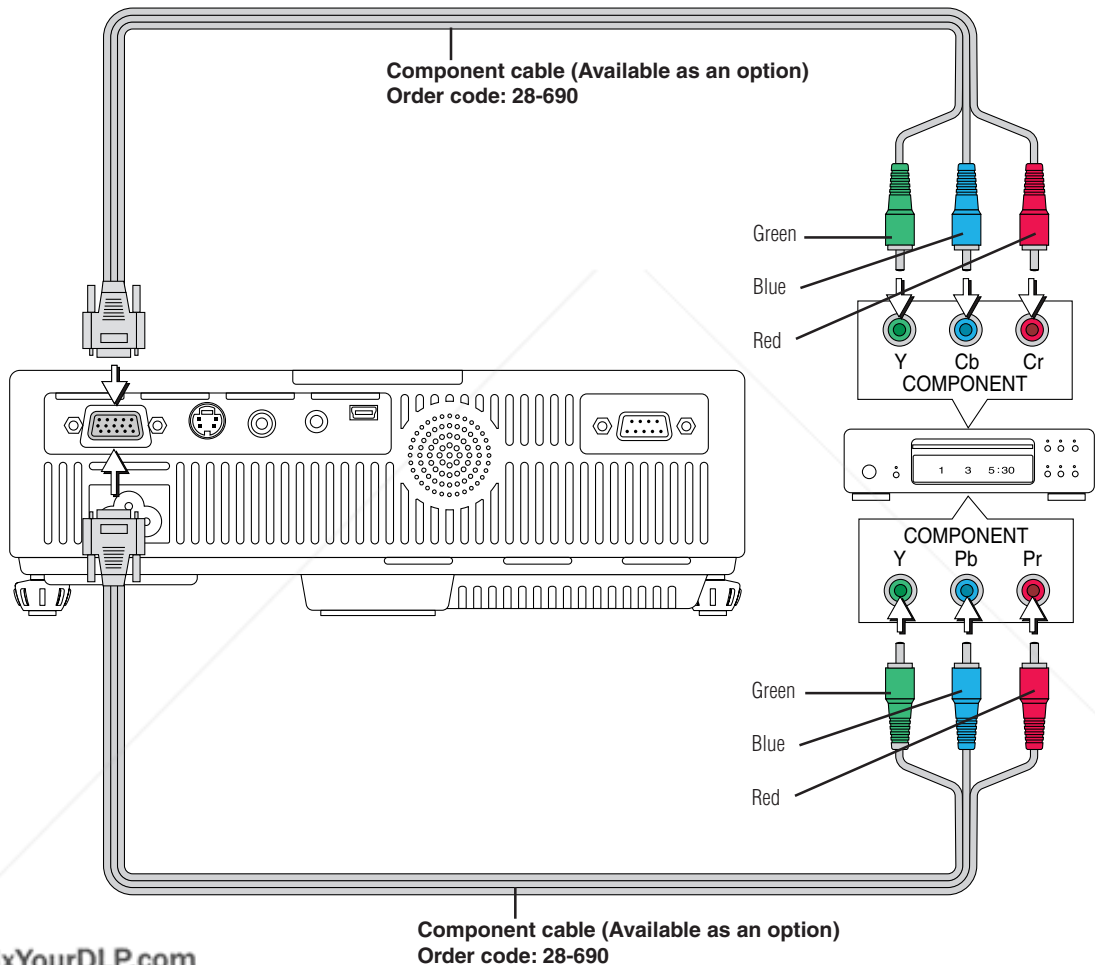

**Connections with the AUDIO Jack**

Applicable Projector: U5-632h/U5-732h/U5-532h

- \* Make the connection to the projector's AUDIO jack using the supplied audio cable. When the audio jack of the equipment that is to be connected is of the RCA phono type, make connection via the supplied audio conversion adapter.
- \* The built-in speaker of the projector provides monaural audio. To enjoy convincing audio reproduction, please connect the audio output of the video equipment to your audio system.
- \* The built-in speaker outputs the audio of the equipment connected to the AUDIO jack.

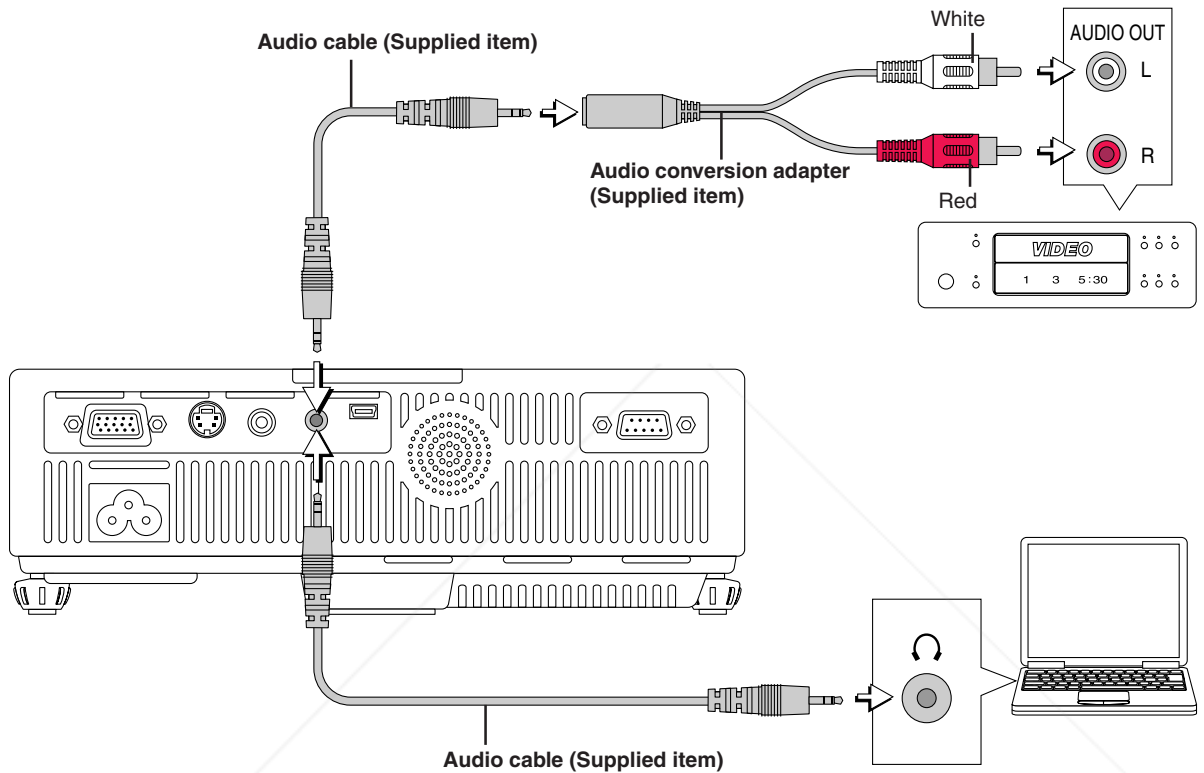

### Connections with the RGB OUT Connector

Applicable Projector: U5-512h

- The image from the computer connected to the RGB connector is output.
- The image of the connector selected with the input selection function is output.
- If an input other than RGB is selected with the input selection function, the output does not switch.
- While controlling the personal computer in front of you, the same screen can be projected with the projector. This allows personal computer control even from a position at which the projector image cannot be viewed.

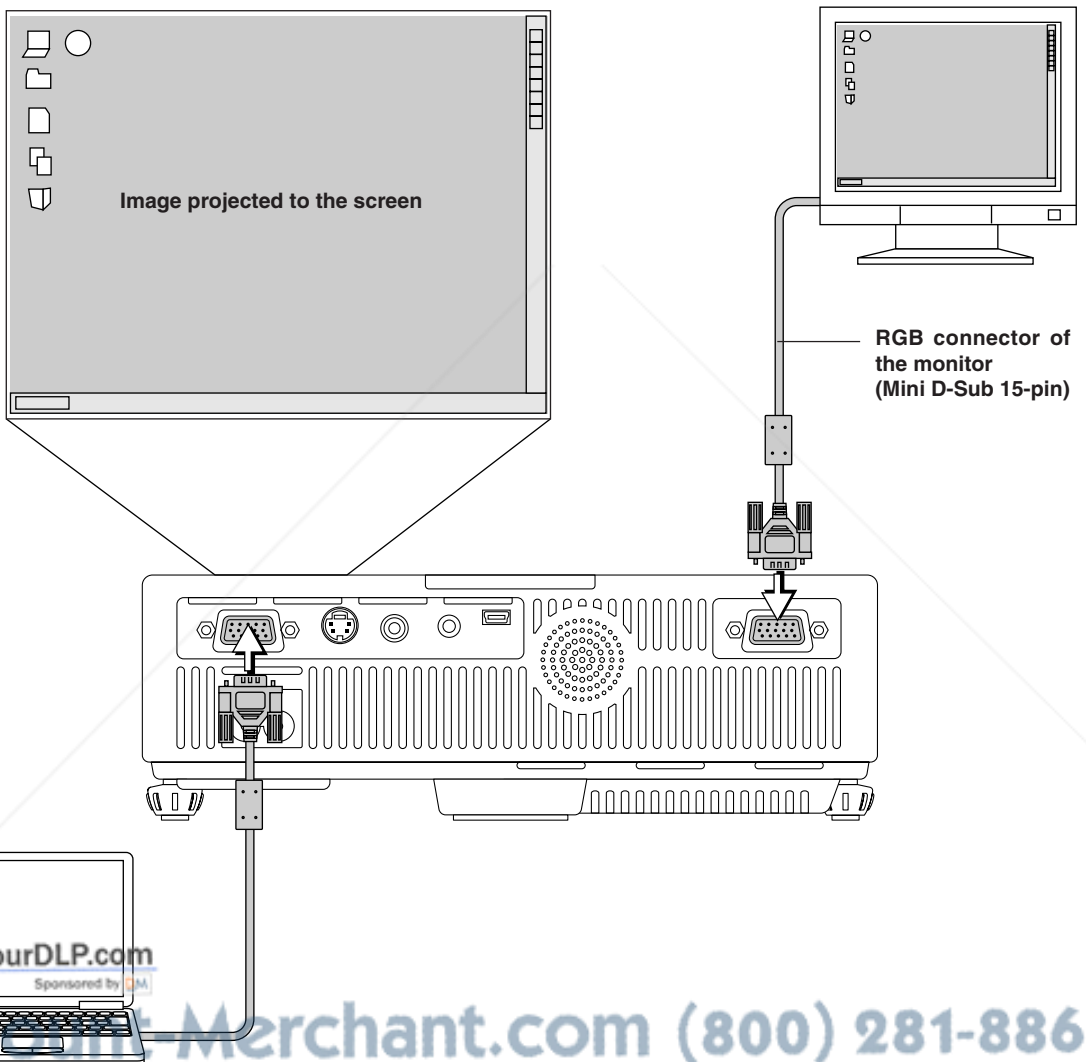

# Power Cable Connections and Switching the Power On/Off

There is an order in which the power cable is connected and the power is switched on/off.

## Operating

- 1 Connect the AC IN connector of the projector and the power outlet using the supplied power cable.**  
The STANDBY indicator will light in amber, and the unit will enter the standby mode.

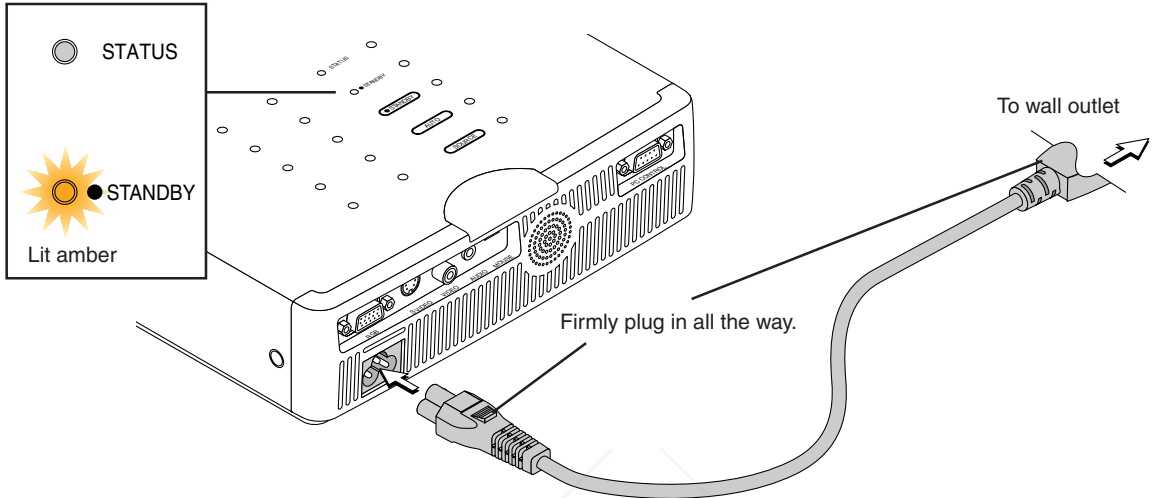

- 2 Switch on the projector power**

Press the STANDBY button.

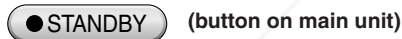

The first time the power is switched on after purchase, [Menu Language Select] will be displayed. See Page E-24 for information about language selection.

- When the power is turned on, the STANDBY indicator starts flashing green, then stops flashing after about 60 seconds. If the STATUS indicator lights green at this time, the lamp mode is set to "Eco". See E-30 and 55 for instructions on selecting.
- If the power does not come on, see "When the STATUS Indicator is Lit or Flashing" on Page E-61.

This indicator is also lit green in Eco-mode.

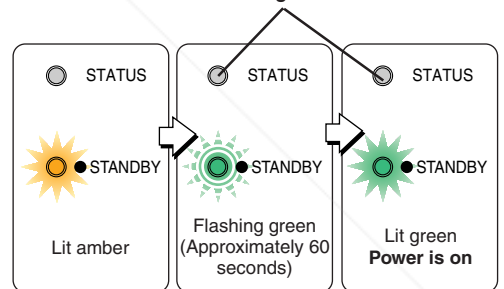

If the "Password" input window is displayed: See E-38.

**A password is set for this projector.**

The projector cannot be used unless the correct password is input.

To turn off the power: See E-25.

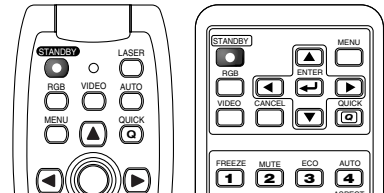

- 3 Switch on the power of the connected equipment**

Password

### Note:

- When the power plug will be unplugged from the power outlet, please place the projector near the power outlet so that it may be reached easily.
- Press the STANDBY button after the STANDBY indicator is lit in amber.
- The included power cable is exclusively for use with the U5-632h/U5-732h/U5-532h/U5-512h. Never use it with other products.



## When [Menu Language Select] is Displayed Upon Switching On the Power

The first time the power is switched on after purchase, [Menu Language Select] will be displayed. Follow the procedure described below and select the display language of the projector.

If the image is blurred, turn the focus ring counterclockwise or clockwise to focus it. See Page E-27.

Menu Language Select	
Please select a menu language.	English
Wählen Sie bitte die Menü Sprache aus.	Deutsch
S'il vous plait choisir la langue de menu.	Français
Per favore di scegliere la lingua di menu.	Italiano
Escoja por favor el idioma de menú.	Español
Välj meny språken.	Svenska
메뉴언어를 선택하십시오	한국어
请选择项目单语言	中文
メニュー言語を選択して下さい。	日本語
Select "▲" "▼" & "ENTER"	

- 1 Press the SELECT (▲▼) buttons of the Remote control and align the deep blue cursor with [English].

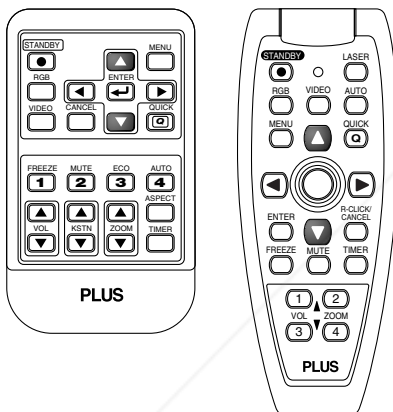

Menu Language Select		Cursor
Please select a menu language.	English	
Wählen Sie bitte die Menü Sprache aus.	Deutsch	
S'il vous plait choisir la langue de menu.	Français	
Per favore di scegliere la lingua di menu.	Italiano	
Escoja por favor el idioma de menú.	Español	
Välj meny språken.	Svenska	
메뉴언어를 선택하십시오	한국어	
请选择项目单语言	中文	
メニュー言語を選択して下さい。	日本語	
Select "▲" "▼" & "ENTER"		

- 2 Press the ENTER button to set.  
This will set the language and [Menu Language Select] will close.

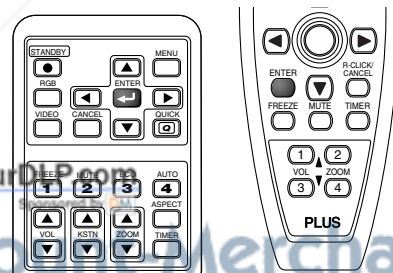

This completes the selection of the display language.

**Caution:**

[Menu Language Select] will not appear the next time the power is switched on. Should a change of language become necessary, see "Language" on Page E-57.

## Finishing

### 1 Switch off the power of the connected equipment

### 2 Switch off the power of the projector

Press the STANDBY button.



(button on main unit)

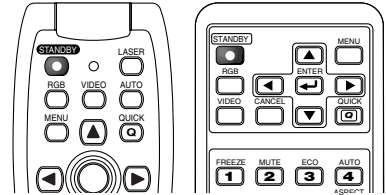

The [Power Off] display appears. When the level gauge reaches maximum, the projection screen will go off (in about 5 seconds) and the projector will enter the power-off operation.

#### Note

\* The operation can be cancelled by pressing a button other than the STANDBY button.

\* One more press of the STANDBY button will switch off the power.

The STANDBY indicator changes to flashing amber and lights a steady amber after about 90 seconds (when the unit enters the standby mode).

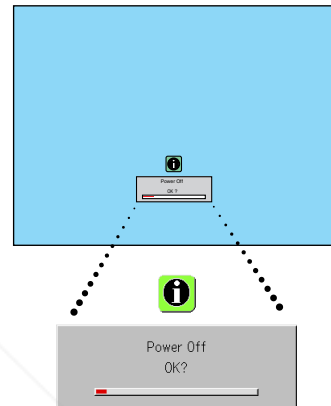
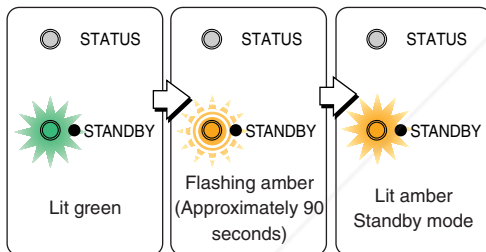

### 3 Unplug the power cable

Check that the STANDBY indicator is lit in amber and then unplug the power cable. The STANDBY indicator will go off when the power cable is unplugged.

#### Warning

Do not unplug the power cable while the STANDBY indicator is flashing amber. Doing so may shorten the life of the lamp or damage the projector.

# Adjustment of the Projection Screen

Switch on the power of the connected equipment and make the adjustments with the video signal being input to the projector.

## Adjustment of the Projection Screen

### 1 Turn the zoom ring to adjust the screen size of the projection image.

Adjust the image to match the desired screen size. When outside of the adjustment range, move the projector to the rear or forward.

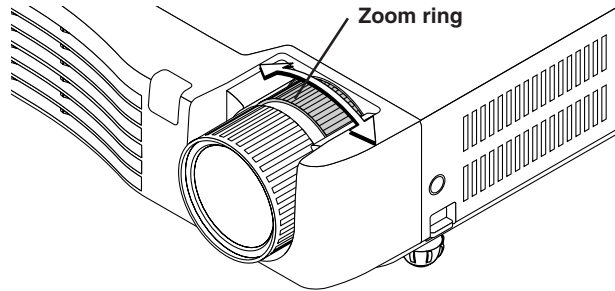

### 2 Adjust the projection image to the screen.

Check that the screen is set level and vertically.

- (1) If the image is shifted to the left or right, move the main unit horizontally. (Align the center of the screen and the center of the projector lens.)
- (2) If the image is shifted vertically, move the image up or down with the adjuster. See "Making Adjustments with the Adjusters" on Page E-27.
- (3) If the image is slanted, adjust by turning the right or left adjuster. See "Making Adjustments with the Adjusters" on Page E-27.
- (4) A projection image such as that illustrated in the diagram is the result of the projector not being perpendicular to the screen. Set the projector so that it is pointing straight toward the screen.
- (5) If the image shows keystone distortion, adjust using remote control or menu operations. See "Keystone" on Page E-31, 53.

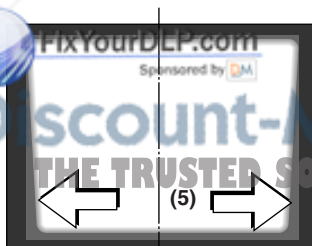
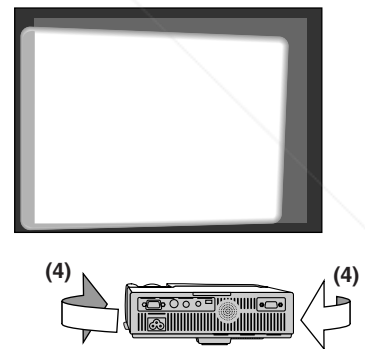
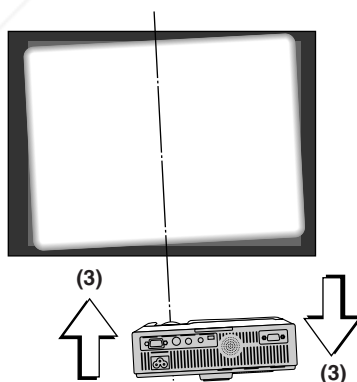
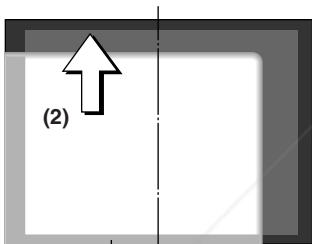

Discount-Merchant.com (800) 281-8860  
THE TRUSTED SOURCE FOR PROJECTOR LAMPS AND ACCESSORIES

**3** Turn the focus ring and adjust the focus of the screen

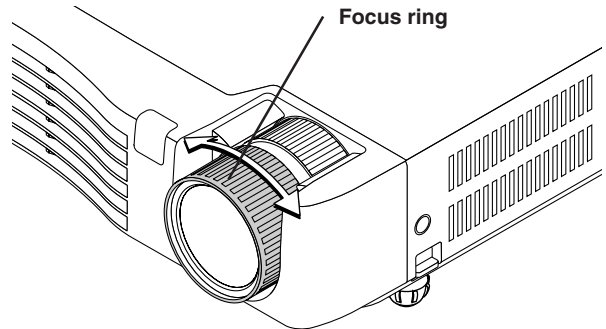

**Making Adjustments with the Adjusters**

**Raising the projection image**

While viewing the projection image, (1) press and hold the front adjuster buttons located at the left and right and, (2) raise the projector to align the image with the screen, then release your fingers.

Turn the left and right front adjusters for fine adjustment. Adjust so that there is no shaking of the projector.

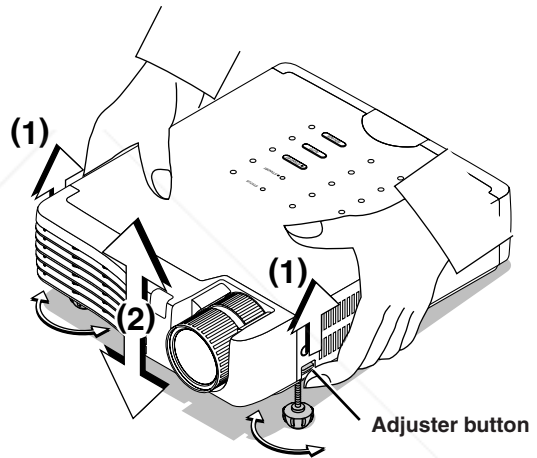

**Lowering the projection image**

Lower the front adjusters using the operation described above.

To lower the projection screen further, raise the rear adjuster. Fine adjustments are made by turning the left and right front adjusters. Make adjustments so that there is no rattling.

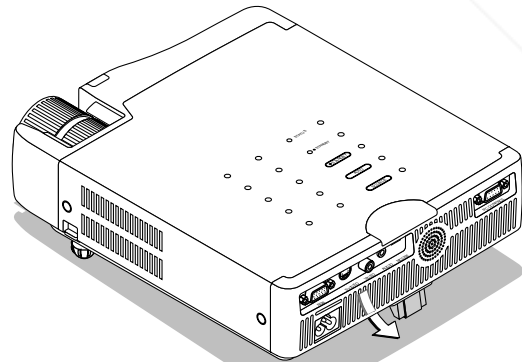

**Discount-Merchant.com (800) 281-8860**  
**THE TRUSTED SOURCE FOR PROJECTOR LAMPS AND ACCESSORIES**

**Note:**

When the projector has a suspended or rear installation is used, the orientation of the projection will need to be changed. Please see "Vertical Flip" on Page E-53.

# General Operation

This section describes the use of direct operation with the main unit or remote control buttons.

For information about operation using the menu, see “Menu Operation Method” on Page E-40 and the various items on Pages E-47 to E-60.

## Input Selection

This operation selects the input signal to be projected.

**Main unit operation: Press the SOURCE button.**

(It will not function while the menu or the quick menu is displayed.)

**When Auto Source is On**

Whenever the SOURCE button is pressed, the projector automatically selects another source that has the next input signal.

**When Auto Source is Off**

The input selection condition used last time will be set.

Each press of the button moves the selection one step in the sequence of RGB → VIDEO → S-VIDEO. Note that the various input signals will become the signal type set with [Input Format] See “Input Format” on page E-56.

**Remote control operation: Press the desired input selection button.**

RGB button ..... Switches the RGB input.

VIDEO button ..... The input switches between VIDEO and S-VIDEO each time the button is pressed.

**When Auto Source is On**

When an input signal is not present at the selected source, the projector automatically selects the next source that has an input signal.

**When Auto Source is Off**

The projector switches to the selected source regardless of whether an input signal is present.

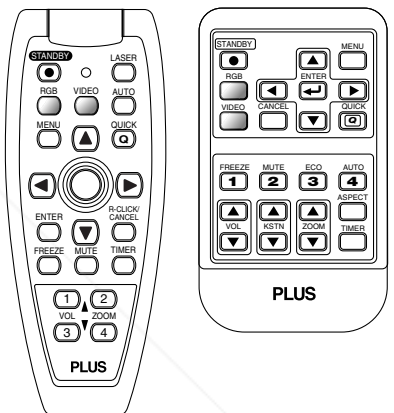
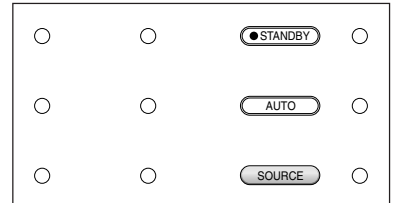

**Note:**

\* When you do not operate source selection, the projector will assume the input selection condition that was previously used.

\* See “Auto Source” on Page E-54 for information about the Auto Source on and off conditions.

## Automatic Adjustment

This function automatically adjusts the position shift, screen size, vertical stripes, and color infidelity of the projected analog RGB input signal.

Normally automatic adjustment is performed at the time of signal selection.

**Main unit operation/Remote control operation: Press the AUTO button.**

(This will not function while the menu or the quick menu is displayed.)

A press of the AUTO button starts the automatic adjustment.

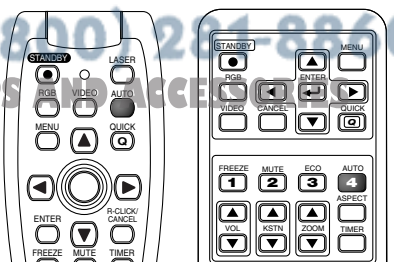
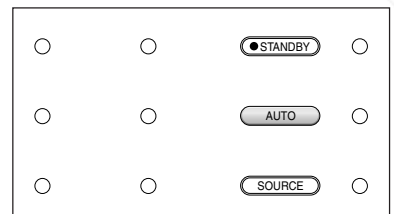

FixYourDLP.com

Sponsored by DLP

\* If the display position is shifted, vertical lines appear on the picture, or the projection is not good even after using automatic adjustment, please perform image adjustment manually. See “Picture Adj. / Fine Picture / H Position / V Position” on Page E-47.

\* When the image extends beyond the boundaries of the screen or is smaller than the screen, set Aspect to “Auto”. See “Selection of Aspect Ratio” on Page E-29 and “Aspect” on Page E-52.

**Selection of Aspect Ratio**

Applicable Projector: U5-532h/U5-512h

This function selects horizontal and vertical picture proportions of the input signal.

Press the ASPECT button while viewing the projected image and select the aspect ratio.

**Personal Computer Signal**

Each press of the ASPECT button advances the selection one step in the sequence of Auto → Direct → Real, and then repeats.

- Auto ..... Automatically enlarges or reduces the image to project a full screen in a ratio of 4:3
- Direct ..... Maintains the aspect ratio and projects a picture of the maximum displayable size
- Real ..... Projects the input signal without pixel conversion.

For the U5-632h/U5-732h projector, these operations are possible using the menus. The operations are the same. See E-52 [Aspect].

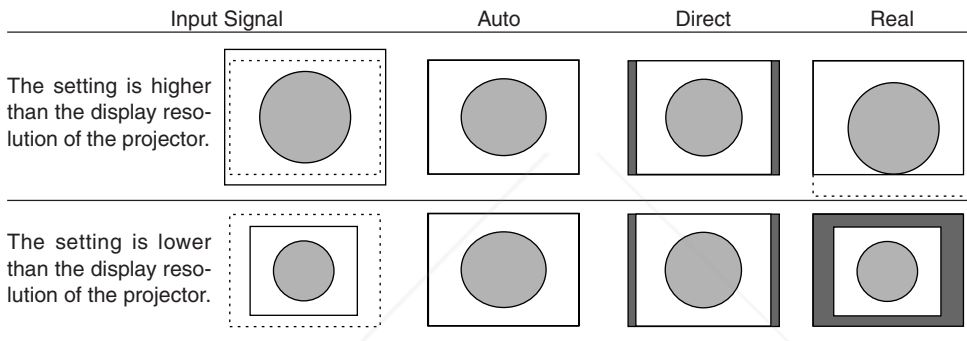
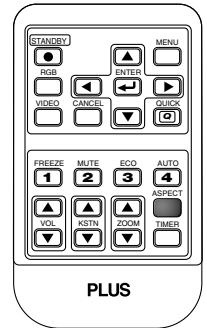

**Video Signals / Component Signals**

Each press of the ASPECT button advances the selection one step in the sequence of Auto → Wide → Zoom, and then repeats.

- Auto ..... While maintaining the aspect ratio, projects a full screen so that no portions extend beyond the boundaries of the screen. The top and bottom of the 16:9 image becomes black.
- Wide ..... Projects to fill the full width with the entire image at 16:9. (This feature is used to project a squeezed image in a proper aspect ratio.)
- Zoom ..... Projects only the 4:3 portion within 16:9 image to fill the screen. (Portion that extend off screen is cut.)

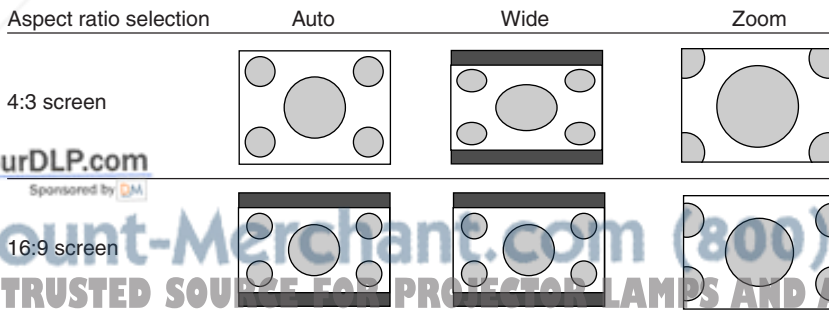

Discount-Merchants.com (800) 281-8860  
THE TRUSTED SOURCE FOR PROJECTOR LAMPS AND ACCESSORIES

**Note:**

When selection has been made for the "Real" setting of the personal computer signal (i.e., when the input signal and the projector display resolution are high) and the "Zoom" setting of the video signal, pressing the SELECT (▲▼◀▶) buttons on the remote control will permit movement of the display position. Note that there will not be any movement when the menu or the quick menu is displayed.

## General Operation

### Freezing a Moving Picture

This function is used to stop and view a moving picture. Note that the input image continues to advance even though the picture there is a still picture condition.

**A press of the FREEZE button changes the screen to a still picture. A further press returns the screen to a moving picture.**

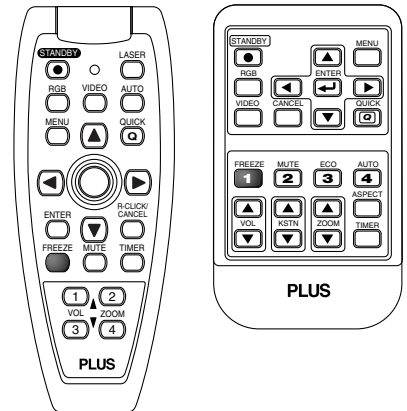

### Canceling Video and Audio Temporarily

This function is used to cancel the video and audio at the same time.

**A press of the MUTE button will blank the picture and the sound, and the screen will take on the background color that has been set. Another press will cause a return to the original conditions.**

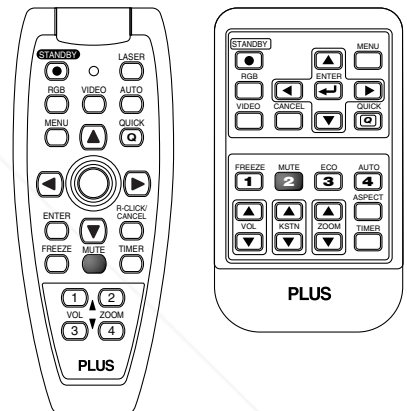

### Lamp Mode

Applicable Projector: U5-532h/U5-512h

**Use this if the picture is projected on a small screen and the picture is too bright or when projecting images in dark rooms.**

Pressing the ECO button will set the lamp mode.

#### Eco (STATUS indicator is lit green)

Lamp brightness is set to 80% and the lamp life is extended.

#### Normal (STATUS indicator is off)

Lamp brightness is set to 100% and the screen is bright.

#### Note:

Frequent switching this mode can degrade the lamp.

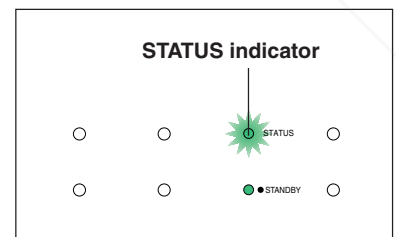

For the U5-632h/U5-732h projector, these operations are possible using the menus. The operations are the same. See E-55 [Lamp Mode].

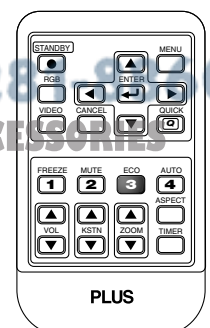

## General Operation

### Keystone

Applicable Projector: U5-532h/U5-512h

Use this to adjust for trapezoidal (keystone) distortion of the projected image.

#### Adjustment Method

- (1) Press the ▲ or ▼ KSTN button to make the left and right sides parallel.  
The keystone adjustment display appears when one of the buttons is pressed.

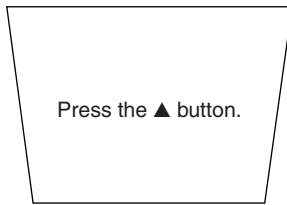

- (2) Press the CANCEL button to immediately close the display.  
The display will close when there has not been an operation in about 10 seconds.

#### Note:

- \* Keystone adjustment values can be saved. See "Keystone Save" on Page E-53.
- \* Screen examples have been drawn in an exaggerated style for the purpose of description.
- \* Please note that depending on the projected picture and the projection conditions, it may not be possible to eliminate keystone distortion completely.

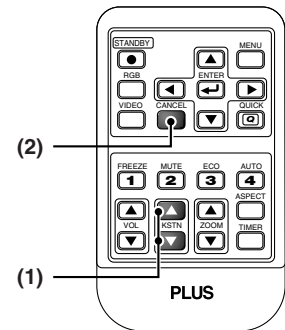

For the U5-632h/U5-732h projector, these operations are possible using the menu. The operations are the same. See E-39, 53.

### Adjustment of the Volume

This function adjusts the volume of the built-in speaker.

- (1) Press the ▲ or ▼ VOL button to adjust the volume.  
The volume adjustment display appears when one of the buttons is pressed.



The ▲ button increases the volume and the ▼ button decreases the volume.

- (2) Press the CANCEL button to immediately close the display.  
The display will close when there has not been an operation in about 10 seconds.

#### Note:

- \* Adjustment of the volume will not produce any sound unless an image is being projected.
- \* Please make connections to the AUDIO connectors of the projector with the supplied audio cable.

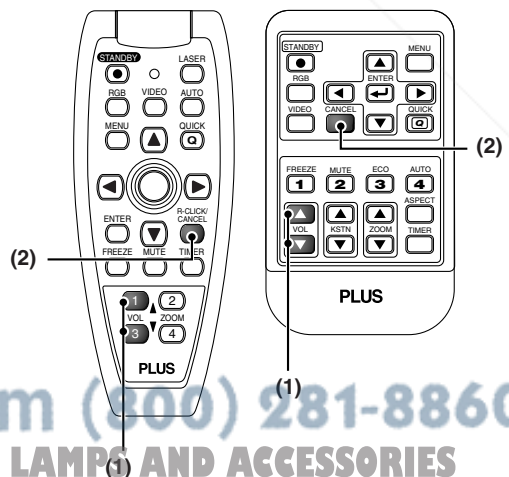



## Enlargement of the Image and Video Movement

This function digitally enlarges the personal computer image and video image.

**(1) Press the ZOOM button to enlarge the image.**

The zoom display appears when the ZOOM button is pressed.



Each press of the ▲ button enlarges the image and each press of the ▼ button makes the image smaller (returning it to 1:1).

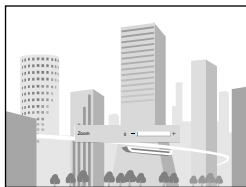

(No enlargement)

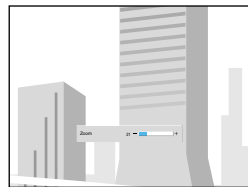

(Approximately 2 times enlargement)

**(2) Pressing the SELECT (▲▼◀▶) buttons on the remote control at the time of the zoom operation will cause the display position to move.**

(There will not be any movement when zoom is at 0.)

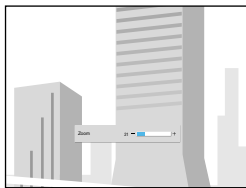

(Approximately 2 times enlargement)

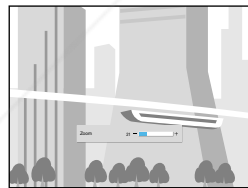

(Movement)

**(3) Press the CANCEL button to immediately close the display.**

The display will close when there has not been an operation in about 10 seconds.

**Note:**

After magnifying the image, be sure to use the ZOOM button to bring the gauge value back to "0".

**The image can also be moved in the following circumstances.**

- When "Aspect" is set to "Real" by the signal of the personal computer, and the input resolution is higher than the display resolution of the projector.

When "Aspect" is set to "Zoom" by the video signal.

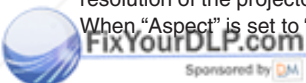
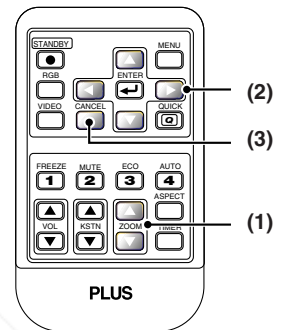
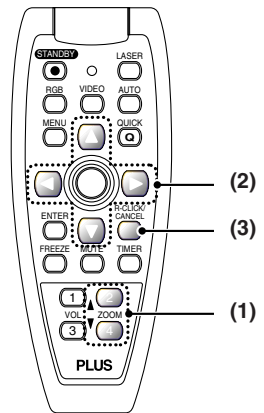

**Discount-Merchant.com (800) 281-8860**  
**THE TRUSTED SOURCE FOR PROJECTOR LAMPS AND ACCESSORIES**

**Note:**

- \* Zoom and image movement functions are cancelled when the input is switched.
- \* The greater the zoom enlargement, the less distinct the image will appear. The reason for this is that the dots are being digitally corrected so that they are not conspicuous.
- \* Movement of the screen will not be possible when the menu screen is being displayed.

## Using the Presentation Timer

The presentation is given while checking the timer displayed on the screen.

The gauge display allows the remaining time to be known at a glance.

**(1) Press the TIMER button to show the settings display.**

The display will close when an operation has not been made for about 10 seconds.



[Timer settings display]

Press the CANCEL button to close the display immediately.

**(2) Use the ◀ and ▶ SELECT buttons to set the time.**

The setting contents are "Off" and from 10 to 60 minutes (in 10-minute intervals)

Settings can also be made with the SELECT (◀▶) buttons.



**(3) Press the ENTER button and start the timer.**

- The display of the timer setting will close, the display of the timer will appear and simultaneously the timer will start.



[Timer Display]

The blue gauge indicates the remaining time. When the gauge disappears, the time is up.

The gauge continues to be displayed when the timer is stopped.

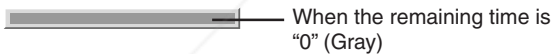

- Press the ENTER button to restart the timer. The timer will start with the same time setting.
- Press the CANCEL button to close the timer display. The timer setting will return to "Off".

**Moving the Position of the Timer Display**

The SELECT (▲▼◀▶) buttons on the remote control permit movement within the movable range of the timer display.

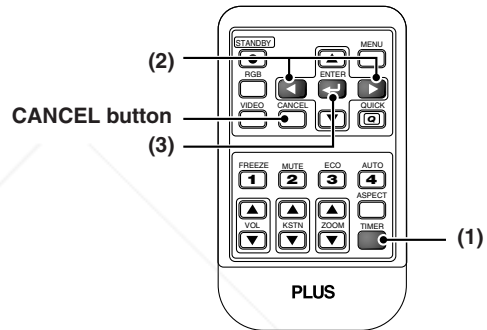
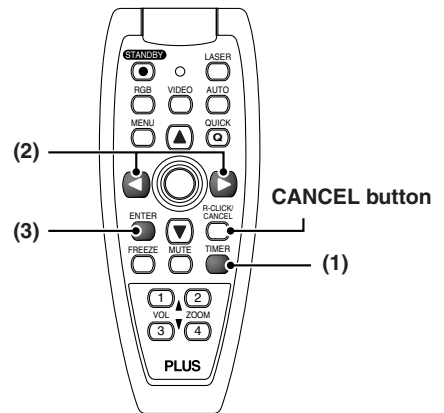

Movable Range of the Timer Display



Discount-Merchant.com (800) 281-8860  
THE TRUSTED SOURCE FOR PROJECTOR LAMPS AND ACCESSORIES

**Note:**

\* The timer display will be closed while the menu or the quick menu is displayed, and while a message is displayed; however, the timer will still be operating at such times. Also, the timer will not be displayed unless a signal is being input.

\* While the presentation timer is being displayed, screen movement will not be possible in the zoom mode.

## General Operation

### Using the Laser Pointer

Applicable Projector: U5-632h/U5-732h

The remote control unit's laser pointer can be used to point to the section currently being explained, making presentations more effective.



### CAUTION

**Do not look at the laser pointer's light source.**

Be sure to heed the following. Pointing the laser beam at the eyes could lead to reduced vision or vision impairment.

- Never look at the laser pointer's light source.
- Do not point the laser beam at people.
- Do not let children use the laser pointer.



This label is located on the side of the remote control.

### Operation

The red laser beam is emitted from the tip of the remote control unit while the LASER button is pressed in. Point the remote control unit's transmitter in the direction you want to indicate. The laser beam turns off when you release your finger from the LASER button.

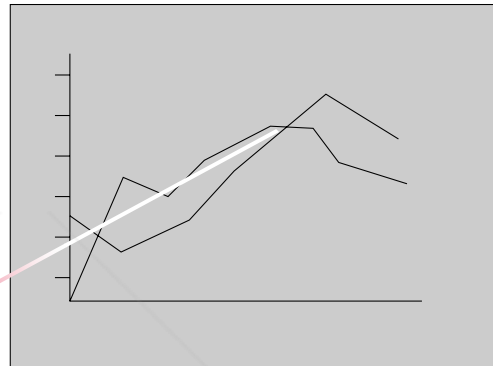
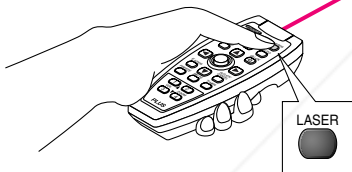

**Discount-Merchant.com (800) 281-8860**  
THE TRUSTED SOURCE FOR PROJECTOR LAMPS AND ACCESSORIES

## Performing Mouse Operations on the Computer with the Remote Control Unit

Applicable Projector:  
U5-632h/U5-732h

When a computer and the projector are connected, mouse operations can be performed on the computer using the projector's remote control unit. When projecting images from the computer, the projector can be operated and mouse operations on the computer performed with the same remote control unit, making for efficient presentations.

### Connecting the computer and projector

Use the USB cable included with the projector to connect the computer's USB (type A) connector to the projector's MOUSE connector.

**Note:**

- \* Be sure to plug the cable in securely.
- \* Depending on the type of connection, the computer's operating system, etc., it may be necessary to change settings or restart the computer after making the connections.

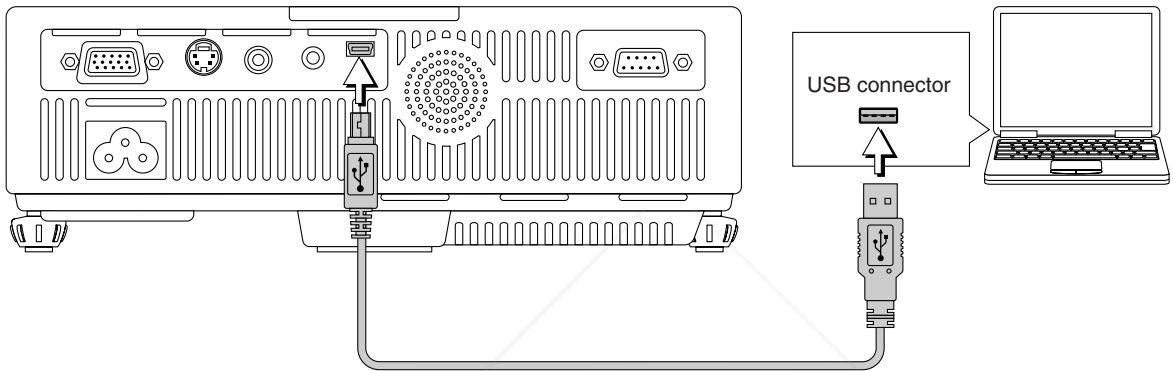

USB cable (mini B to A type) (Supplied item)

### Functions of the mouse function buttons

When operating, point the remote control unit's transmitter towards the remote control sensor on the projector.

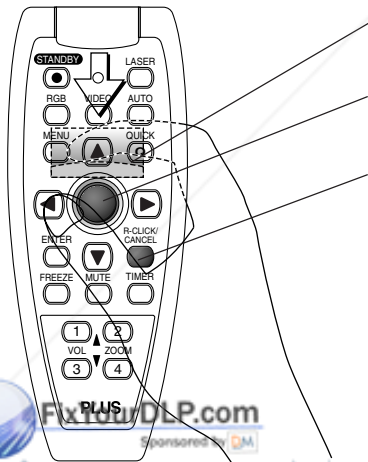

**L-CLICK button (on back)**

Press this to perform the left-click operation.

**JOG buttons**

These move the computer's pointer in the corresponding direction.

**R-CLICK button**

Press this to perform the right-click operation.

**INFORMATION**

The R-CLICK/CANCEL button is used for both the projector and mouse function. When the R-CLICK/CANCEL button is pressed while a menu is open, the menu is closed.

**Note:**

**Connections with USB Cables**

- \* For PC/AT compatible computers, this function cannot be used with operating systems other than Windows 9xSE, Me, 2000 and XP. For Macintosh computers, this function cannot be used with operating systems other than OS 9 and later.
- \* When the cable is disconnected and then reconnected to the USB port of the personal computer or the MOUSE connector of the projector, allow at least 5 seconds before reconnecting. Do not repeatedly disconnect and reconnect the cable in a momentary fashion. The personal computer may not be able to correctly identify the projector as a result.
- \* The supplied USB cable is a dedicated cable for this projector. There is no guaranty that it will work in connections with other USB equipment.
- \* This function may not work with some computers.

**Controlling the Projector from a Computer** — Applicable Projector: U5-632h/U5-732h/U5-532h

Use the control connector if the projector cannot be operated with the remote control unit, for example when it is suspended from the ceiling.

**Connecting the computer and projector**

Use a commercially available serial cable (D-Sub 9-pin, straight) to connect the computer's RS-232C connector to the projector's control connector (PC CONTROL).

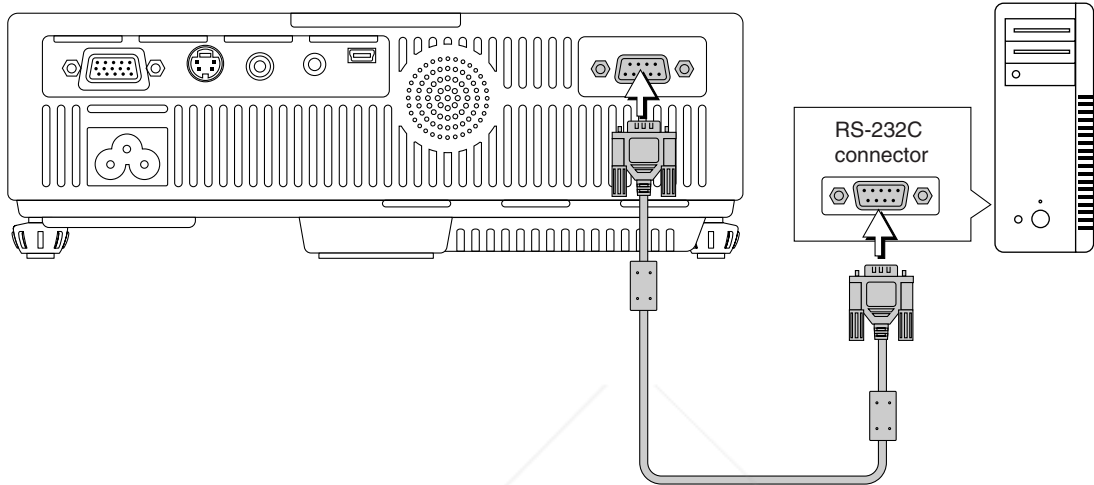

Serial cable (D-Sub 9-pin, straight) (commercially available)

**Note:**

- \* This function may not work with some computers.
- \* Specialized knowledge is required to use the control connector. Consult a specialist, such as the person suspending the projector from the ceiling.

**Use as a High-Brightness Monochrome Projector** — Applicable Projector: U5-632h/U5-532h

Data comprising a lot of black-and-white content such as documents and spreadsheets can be projected as a highbrightness black-and-white image. While being projected, the image can be switched between black-and-white and color.

Switching between color and black-and-white is done using the menus. For instructions on operating the menus, see “Menu Operation Method” on E-40.

Select “Color B/W Switching” in the “Setup” menu, then press one of the ◀ or ▶ SELECT buttons on the remote control unit to select “B/W”.

When selected, the image switches to a high brightness black-and-white image. Press the “Color” button on the remote control unit to switch back to a color image.

Press the CANCEL button on the remote control unit to close the menu display.

Image	Color	View	Setup	Option	Info.
			Color B/W Switching		◀ B/W ▶
			Auto Source		◀ On ▶
			Auto Power Off		◀ Off ▶
			Menu Position		◀ [Icon] ▶
			Lamp Mode		◀ Normal ▶
			Input Format		◀ [Icon] ▶
			Presentation Timer		◀ Off ▶

**THE TRUSTED SOURCE FOR PROJECTOR LAMPS AND ACCESSORIES**

## Protecting the Projector with the Security Lock

A password can be registered and the security lock set in order to protect the projector from unauthorized use.

### Registering the password

The password is registered using the menus. For instructions on operating the menus, see “Menu Operations” on E-40.

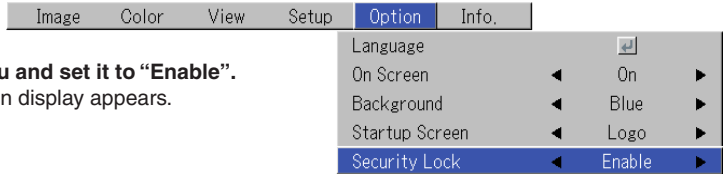

- (1) Select “Security Lock” in the “Option” menu and set it to “Enable”.  
The menu closes and the password registration display appears.

- (2) Use the number buttons (1 to 4) to register the password.

Be sure to input a 4-digit number.

Example: Registering the password “2441”

- (1) Press number button “2”. An “\*” (asterisk) appears at the first place.  
Next press number buttons “4”, “4” and “1” in that order. Asterisks appear in all four places.

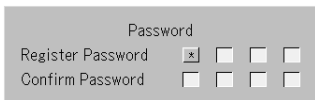

- (2) Input the password again. An “\*” appears when the input number matches. If there is a mistake, the asterisks turn off. Start over from step (1) above.  
If the password matches, the password registration display closes.

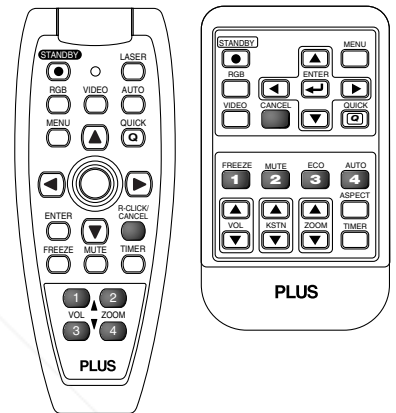
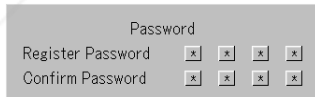
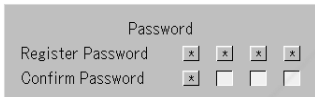

**Note:**

To cancel the number you have input, press the CANCEL button.  
The asterisks disappear and the display returns to the input standby mode at the first place.  
To cancel the password registration mode, press the CANCEL button again. The “Password” display turns off.

This completes password registration.

The “Password” input display appears the next time the power is turned on.

**Note:**

The numbers you have input are not displayed. Be sure to write down the password and store it in a safe place.

## General Operation

### If the password input display appears when the power is turned on

When a password has been registered, the “Password” input window appears on the projected image when the power is turned on. The projector continues projecting this image until the correct password is input. At this time, only the STANDBY button (power off) works. Use the procedure described below to input the registered password. For instructions on registering the password, see E-37.

### Input the password using the number buttons (1 to 4).

Be sure to input the registered 4-digit number.

Example: To input the password “2441”  
Press number button “2”. An “\*” (asterisk) appears at the first place.

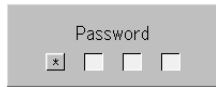

Next press number buttons “4”, “4” and “1” in that order. Asterisks appear in all four places.

If the password matches, the window turns off and the projector can be used normally.

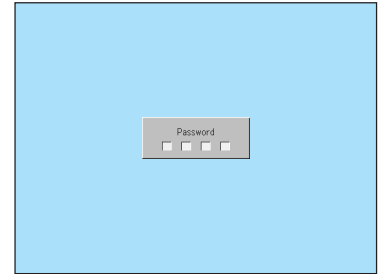

[Password input window]

### Canceling the password/Changing the password

The password is canceled and changed using the menus. For instructions on operating the menus, see “Menu Operations” on E-40.

#### Canceling the password

Select “Security Lock” in the “Option” menu and set it to “Disable”.

This clears the password and disables the security lock.

The password input display no longer appears when the power is turned on.

#### Changing the password

After setting “Security Lock” to “Disable” as described above, set it back to “Enable”. The menu closes and the password registration display appears.

Register the new password. See “Registering the password” on E-37.

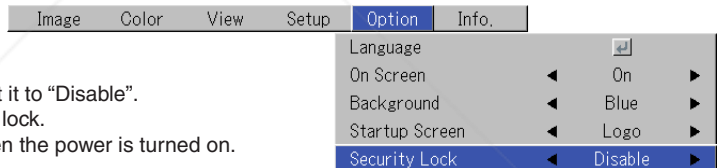

## Using the Quick Menu

This function permits frequently used adjustments to be performed quickly.

Note that the Quick Menu will not be displayed unless the signal of the connected equipment is input. Please select the input that you wish to adjust.

- (1) A press of the QUICK MENU button brings up the quick adjustment display. Further presses cause the adjustment display to change in sequence. The adjustment display can be selected with use of either the SELECT ▲ or ▼ button.
- (2) Press the cursor ◀ or ▶ button to make the adjustment.
- (3) To close the display immediately, press the CANCEL button. In the absence of operations for a period of about 10 seconds, the display will close automatically.

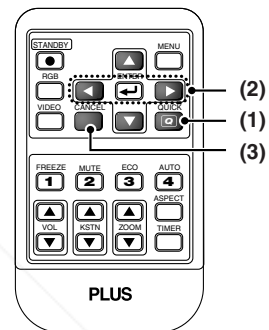
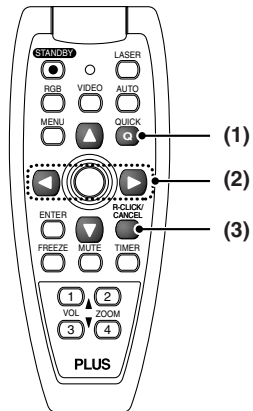

## Content of Adjustments and Settings

Example: Brightness adjustment display

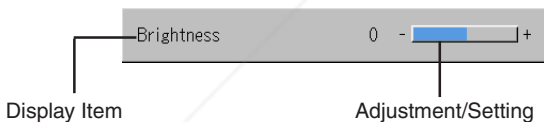

Brightness	Adjusts the brightness of the image. See page E-47.
Contrast	Adjusts the contrast of the image. See page E-47.
Keystone	Corrects (vertical) keystone distortion of the screen. See page E-31.
Volume	This function adjusts the volume of the built-in speaker. See page E-31.
Presentation timer	Sets the time of the presentation timer. See page E-33.
Quick Color Adj.	Select the preset color mode. See page E-49.



# Menu Operation Method

- This section describes only the menu operation method. Please see this item should you need information while performing menu operations.
- For information about a menu function, adjustment, or setting, please see one of the pages containing such descriptions.
- Adjustments and settings are made by projecting an image and adjusting to an optimum condition.
- The remote control should be pointed toward the remote control sensor of the projector and operated.
- To return the various items that have been changed via the menu to their standard values (i.e., default values at time of shipping from the factory), see "Factory Default" on Page E-59. (Some items will not return to their initial values.)
- The adjustment/setting items and contents will differ depending on the input selection and the adjustment/setting items that can be used with the input signal are displayed on the menu.

## Names and functions of remote control unit buttons used for menu operations

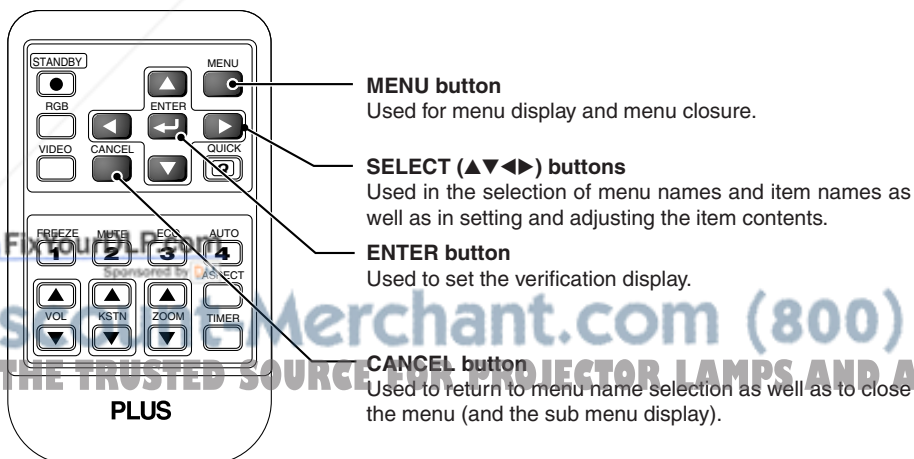
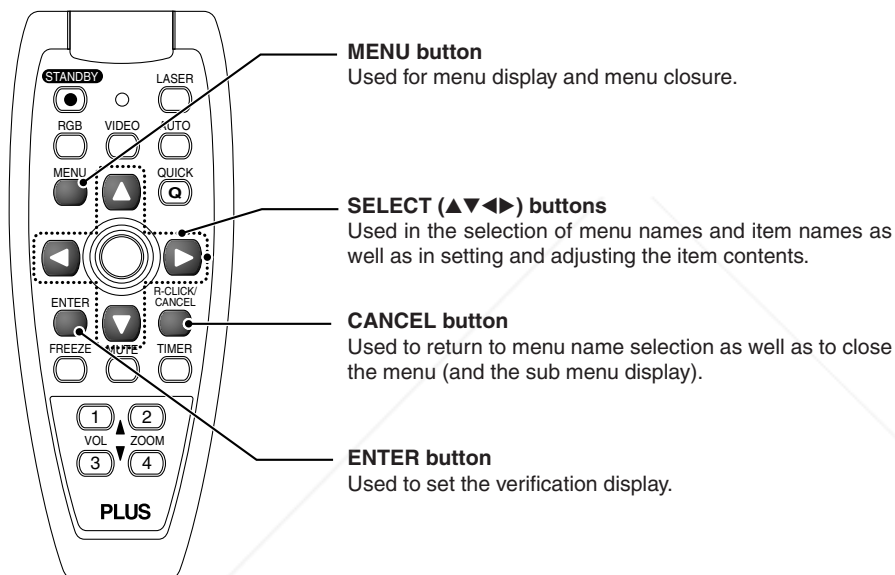

Menu Screen Names and Functions

**Menu Name**

This is the title of the menu.  
There is a change to the title screen when the menu is selected.  
The cursor moves to the selected menu name.

**Cursor (Deep Blue)**

This permits setting/adjustment of the item located at the cursor position.

Applicable Projector:  
U5-632h/U5-532h  
Not selectable for other models.

**Item Name**

This is the name of the adjustment or setting.

**Icon:** Pressing the ENTER button displays the sub menu or setting contents.

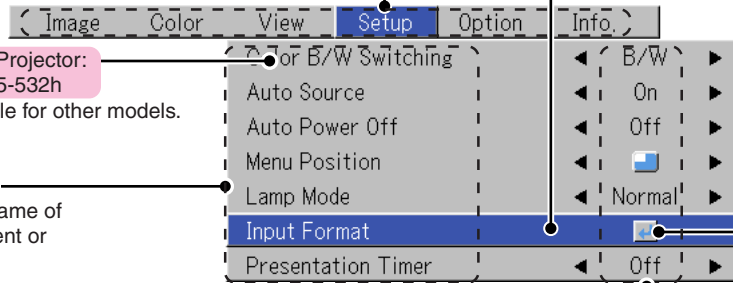

**Adjustment Bar and Settings Contents**

Adjustment Bar: The increases and decreases in bar length express the adjustment condition.  
Setting Contents: Displays the contents that have been set.

**Adjustment Bar**

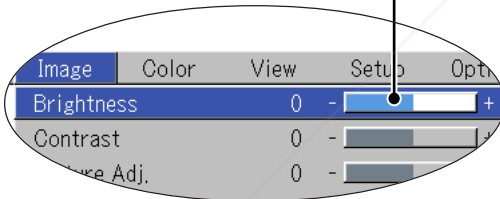

**Sub menu**

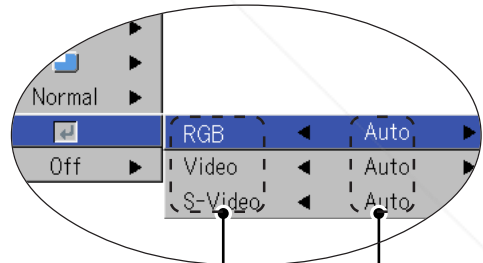

Item Name

Settings Contents

## Performing Menu Operations

- Only “Setup”, “Options” and “Info.” can be selected when no signal is being input.
- The menu display will close if, after pressing a button, the next button operation is not made within 30 seconds.
- The adjustment and the setting values are stored even when the power is switched off or the plug is disconnected from the power outlet.

(Note that some items are not stored.)

**Preparation** Switch on the power of the connected equipment, start the play operation or another operation, and input the signal to the projector.

Select the input that you wish to adjust.

The menu display of the description diagram depicts an example in which the “Keystone” item name is selected.

## Menu Display

### 1 Press the MENU button to display the menu

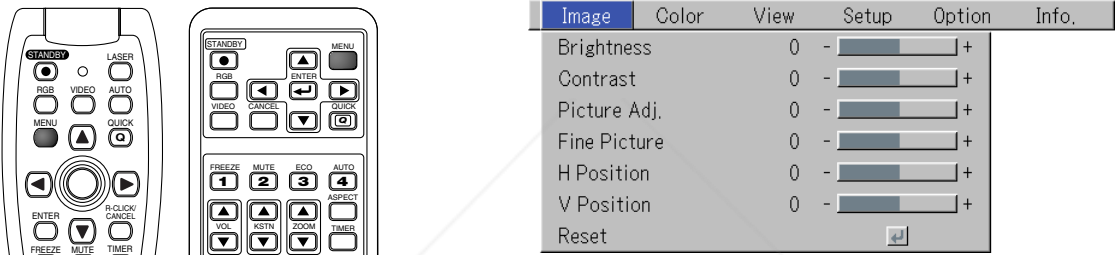

The menu name that existed when the menu was closed previously will be displayed.

## Selection of the Menu Name

### 2 Press the SELECT (◀▶) button to select the menu name



Each press of the SELECT ▶ button advances the selection one step in the sequence of “Color” → “View” → “Setup” → “Option” → “Info.” → “Image”. Each press of the SELECT ◀ button causes a return of one step. The cursor moves to the selected menu name.

**Note:**

Please check that the cursor of the item name has disappeared at the time of menu name selection. Press the CANCEL button to make the cursor disappear.

**Displaying the Cursor**

**3** Press the **▼ SELECT** button to display the item name selection cursor.

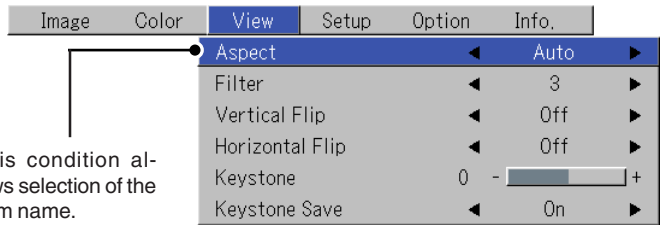
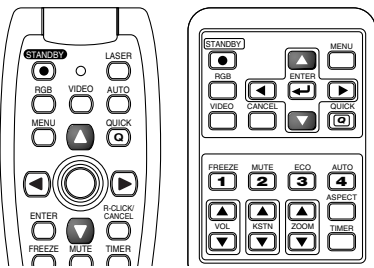

This condition allows selection of the item name.

**Selection of the Item Name**

**4** Press the **SELECT (▲▼)** button to align the cursor with the item name

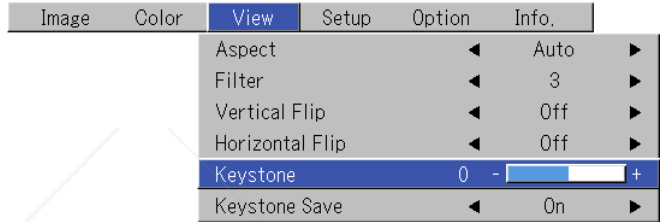
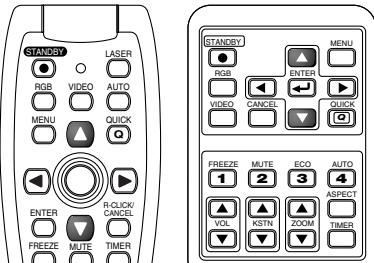

**Items for which the  Icon Is Displayed**

Press the ENTER button to display the submenu.

Press the SELECT (▲▼) button and align the cursor with the desired item name.

There are also some items for which the setting display or the verification display will appear. Please see the various item descriptions.

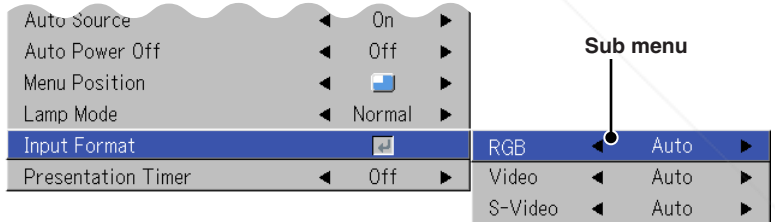
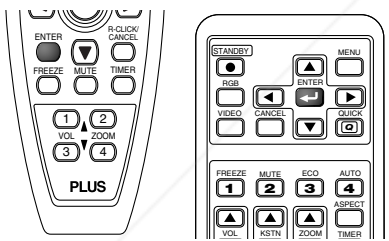

**Making Adjustments/Settings**

**5** Press the **SELECT (◀▶)** button and make the adjustment (or setting) while viewing the image

When a button is pressed, the image will also change.

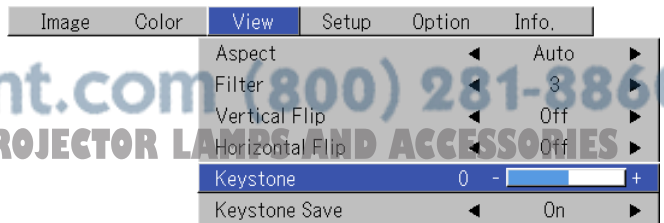
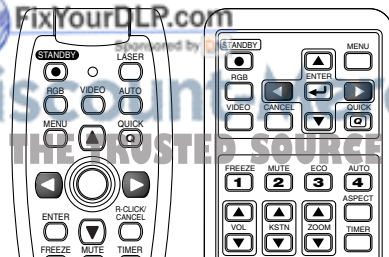

Adjustment display: Each press of the button results in a change of 1 point and continued presses cause changes to proceed in order.

Setting display: The setting contents display changes with each press of the button.

**Closing the Menu**

**6 Press the MENU button and close the menu display**

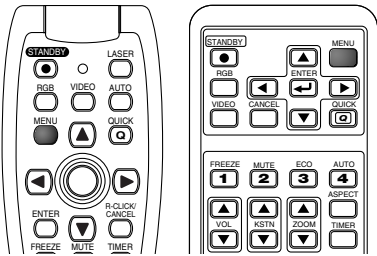

**Selecting Another Menu Name with Remote Control Operation**

When a sub menu is displayed, press the CANCEL button and close the sub menu.

Press the CANCEL button again to turn off the item name cursor.

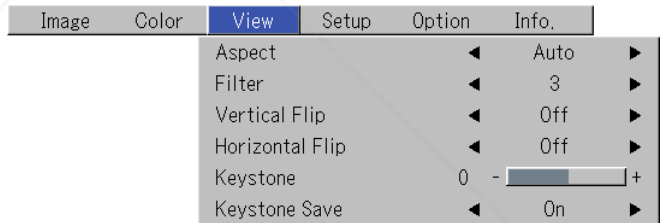
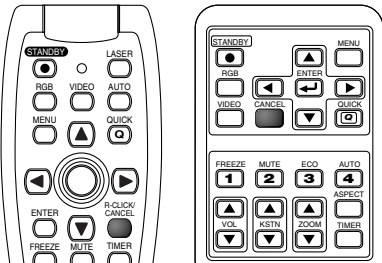
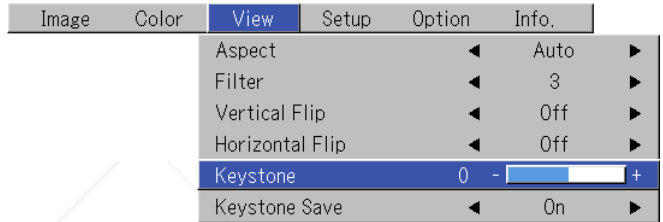

Press the SELECT (◀▶) button and select the menu name.

(Menu names cannot be selected when the item name cursor is displayed.)

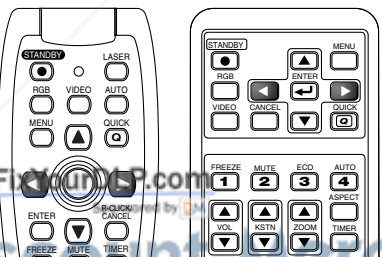
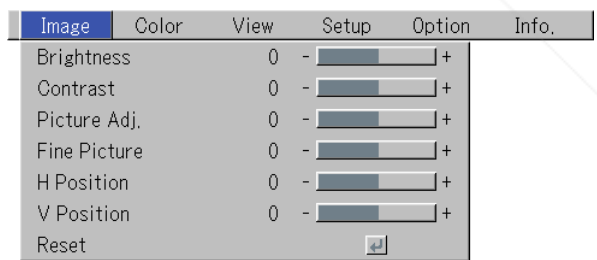

Discount-Merchant.com (800) 281-8860  
 THE TRUSTED SOURCE FOR PROJECTOR LAMPS AND ACCESSORIES

**Note:**

A press of the QUICK button while the menu is displayed will close the menu and display the quick menu. A press of the MENU button while the quick menu is displayed will close the quick menu and display the menu.

**List of Item Names Offering Input Selection and Adjustments/Settings**

The item names that can be adjusted/set will differ depending on the input signal.

[Example of Menu Display Items at the Time of Input Signal RGB Selection]



Menu name	Item Name	Sub Menu Item Name	Input Signal Component				Reference Page
			RGB	VIDEO	S-VIDEO		
Image	Brightness		<input type="radio"/>	<input type="radio"/>	<input type="radio"/>	<input type="radio"/>	E-47
	Contrast		<input type="radio"/>	<input type="radio"/>	<input type="radio"/>	<input type="radio"/>	E-47
	Color			<input type="radio"/>	<input type="radio"/>		E-47
	Tint		<input type="radio"/>	<input type="radio"/>	<input type="radio"/>		E-47
	Sharpness			<input type="radio"/>	<input type="radio"/>		E-47
	Picture Adj.			<input type="radio"/>			E-47
	Fine Picture			<input type="radio"/>			E-48
	H Position			<input type="radio"/>			E-48
	V Position			<input type="radio"/>			E-48
	Reset			<input type="radio"/>	<input type="radio"/>	<input type="radio"/>	E-48
Color	Quick Color Adj.			<input type="radio"/>			E-49
	Gamma		<input type="radio"/>	<input type="radio"/>	<input type="radio"/>	<input type="radio"/>	E-49
	Color Temp.		<input type="radio"/>	<input type="radio"/>	<input type="radio"/>	<input type="radio"/>	E-50
	White		<input type="radio"/>	<input type="radio"/>	<input type="radio"/>	<input type="radio"/>	E-50
	Color Space		<input type="radio"/>				E-50
	White Balance			<input type="radio"/>			E-51
View	Aspect		<input type="radio"/>	<input type="radio"/>	<input type="radio"/>	<input type="radio"/>	E-52
	Filter		<input type="radio"/>	<input type="radio"/>	<input type="radio"/>	<input type="radio"/>	E-52
	Vertical Flip		<input type="radio"/>	<input type="radio"/>	<input type="radio"/>	<input type="radio"/>	E-53
	Horizontal Flip		<input type="radio"/>	<input type="radio"/>	<input type="radio"/>	<input type="radio"/>	E-53
	Keystone		<input type="radio"/>	<input type="radio"/>	<input type="radio"/>	<input type="radio"/>	E-53
	Keystone Save		<input type="radio"/>	<input type="radio"/>	<input type="radio"/>	<input type="radio"/>	E-53

\*"Tint" can be adjusted only at the time of NTSC composite/S signal input.

## Menu Operation Method

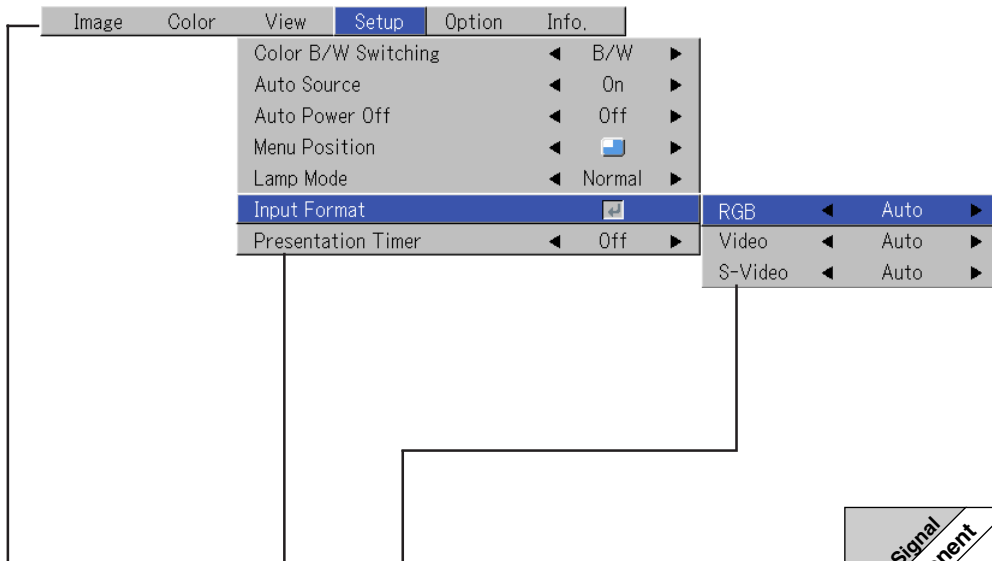

Menu name	Item Name	Sub Menu Item Name	Input Signal Component				Reference Page	
			RGB	VIDEO	S-VIDEO			
<b>Setup</b>	Color B/W Switching	Applicable Projector: U5-632h/U5-532h	<input type="checkbox"/>	<input type="checkbox"/>	<input type="checkbox"/>	<input type="checkbox"/>	E-54	
	Auto Source		<input type="checkbox"/>	<input type="checkbox"/>	<input type="checkbox"/>	<input type="checkbox"/>	E-54	
	Auto Power Off		<input type="checkbox"/>	<input type="checkbox"/>	<input type="checkbox"/>	<input type="checkbox"/>	E-54	
	Menu Position		<input type="checkbox"/>	<input type="checkbox"/>	<input type="checkbox"/>	<input type="checkbox"/>	E-55	
	Lamp Mode		<input type="checkbox"/>	<input type="checkbox"/>	<input type="checkbox"/>	<input type="checkbox"/>	E-55	
	Input Format	RGB		<input type="checkbox"/>	<input type="checkbox"/>	<input type="checkbox"/>	<input type="checkbox"/>	E-56
		Video		<input type="checkbox"/>	<input type="checkbox"/>	<input type="checkbox"/>	<input type="checkbox"/>	E-56
		S-Video		<input type="checkbox"/>	<input type="checkbox"/>	<input type="checkbox"/>	<input type="checkbox"/>	E-56
Presentation Timer		<input type="checkbox"/>	<input type="checkbox"/>	<input type="checkbox"/>	<input type="checkbox"/>	E-56		
<b>Option</b>	Language		<input type="checkbox"/>	<input type="checkbox"/>	<input type="checkbox"/>	<input type="checkbox"/>	E-57	
	On Screen		<input type="checkbox"/>	<input type="checkbox"/>	<input type="checkbox"/>	<input type="checkbox"/>	E-57	
	Background		<input type="checkbox"/>	<input type="checkbox"/>	<input type="checkbox"/>	<input type="checkbox"/>	E-57	
	Startup Screen		<input type="checkbox"/>	<input type="checkbox"/>	<input type="checkbox"/>	<input type="checkbox"/>	E-58	
	Security Lock		<input type="checkbox"/>	<input type="checkbox"/>	<input type="checkbox"/>	<input type="checkbox"/>	E-58	
<b>Info.</b>	Status		<input type="checkbox"/>	<input type="checkbox"/>	<input type="checkbox"/>	<input type="checkbox"/>	E-59	
	Factory Default		<input type="checkbox"/>	<input type="checkbox"/>	<input type="checkbox"/>	<input type="checkbox"/>	E-59	
	Lamp Timer Reset		<input type="checkbox"/>	<input type="checkbox"/>	<input type="checkbox"/>	<input type="checkbox"/>	E-59	
	Resolution		<input type="checkbox"/>	<input type="checkbox"/>	<input type="checkbox"/>	<input type="checkbox"/>	E-60	
	Frequency		<input type="checkbox"/>	<input type="checkbox"/>	<input type="checkbox"/>	<input type="checkbox"/>	E-60	
	Lamp Timer		<input type="checkbox"/>	<input type="checkbox"/>	<input type="checkbox"/>	<input type="checkbox"/>	E-60	



FixYourDL.com  
Specialize in Projector Lamps

**Discount-Merchant.com (800) 281-8860**  
THE TRUSTED SOURCE FOR PROJECTOR LAMPS AND ACCESSORIES

# Image

- Perform this operation while projecting the picture for which the adjustment/setting will be made.
- Select the menu name “Image”.  
See “Menu Operation Method” on Page E-40 for information about performing menu operations. The item name display will differ depending on the input signal. See “List of Item Names Offering Input Selection and Adjustments/Settings” on Page E-45.

## Brightness / Contrast / Color / Tint / Sharpness

Picture qualities such as brightness and contrast will change depending on the whether the room is bright or dark. Please adjust to suit your preference.

Select the desired item name and then adjust with the SELECT (◀▶) buttons.

Item Name	SELECT ◀ Button	SELECT ▶ Button
Brightness	Darker	Brighter
Contrast	Less contrast	More contrast
Color	Less dense color	Denser color
Tint	More red	More green
Sharpness	Softer image	Sharper image

**Note:**

- \* The adjustment values of the adjustable items are stored according to input source.
- \* “Tint” can only be adjusted when inputting NTSC composite/S-Video signals or component signals.

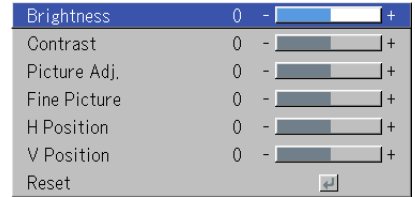

## Picture Adj. / Fine Picture / H Position / V Position

Usually, automatic adjustment is performed at the time of signal selection, but when automatic adjustment is not effective, these adjustments can be performed.

**Note:**

When the image extends beyond the boundaries of the screen or is smaller than the screen, check that the “View” → “Aspect” setting is set to “Auto”. See “Aspect” on Page E-52.

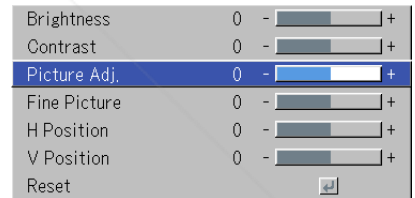

### Picture Adj. (Picture Adjustment)

Adjust this when bright and dark vertical bands appear on the screen.

Select the “Picture Adj.” item name and adjust with the SELECT (◀▶) buttons so that the vertical bands disappear and brightness becomes uniform across the screen.

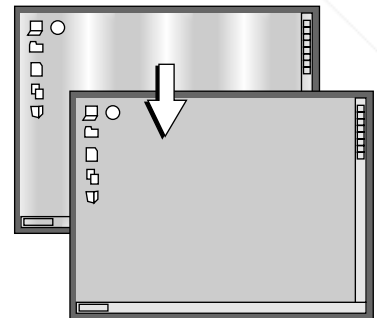



## Image

### Fine Picture

Adjust this when the picture shows a lack of color fidelity or flickering.

Select the "Fine Picture" item name and adjust with the SELECT (◀▶) buttons so that the lack of color fidelity or the flickering disappears.

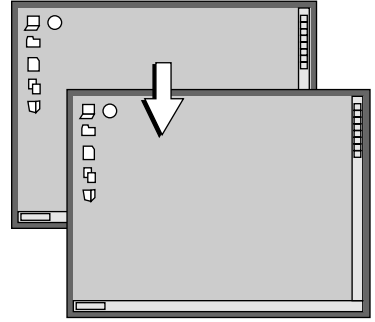

### H Position

Adjust this when the picture is shifted to the left or right.

Select the "H Position" item name and adjust with the SELECT (◀▶) buttons.

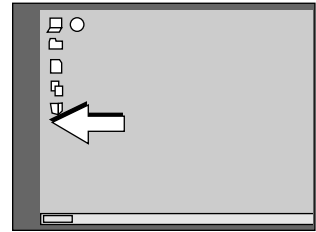

### V Position

Adjust this when the picture is shifted up or down.

Select the "V Position" item name and adjust with the SELECT (◀▶) buttons.

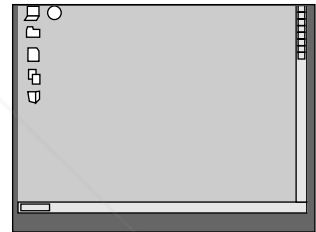

## Reset

This function resets (i.e., returns to the standard settings) the adjustment/setting value of the "Image" menu name.

A press of the ENTER button forces the reset.

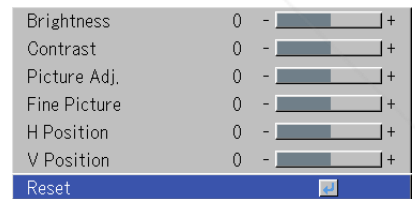

### Note:

\* The item name "Fine Picture" at the time of RGB input will not be reset.

\* "Reset" of the menu name "Image" can be reset for each input source.

To reset the adjustments/settings of all the menu items (while noting that there are some items that cannot be reset), see "Factory Default" on Page E-59.

Discount-Merchant.com (800) 281-8860  
THE TRUSTED SOURCE FOR PROJECTOR LAMPS AND ACCESSORIES

# Color

- Do the following operation while displaying the image you want to adjust or set.
- Select the menu name “Color”.

See “Menu Operation Method” on Page E-40 for information about performing menu operations. The item name display will differ depending on the input signal. See “List of Item Names Offering Input Selection and Adjustments/Settings” on Pages E-45.

## Quick Color Adj.

### Select the preset color mode.

Select the “Quick Color Adj.” item name and select the setting contents with the SELECT (◀▶) buttons.

Picture ..... Select this to prioritize color.

Standard ..... This is the standard selection. (Default setting)

Dynamic ..... Select this for prioritizing brightness.

\* When “Picture”, “Standard” or “Dynamic” is selected, the “Gamma”, “Color Temp.” and “White” adjustment items are displayed in gray and cannot be selected or adjusted.

Custom ..... “Gamma”, “Color Temp.” and “White” adjustment items can be selected and adjusted

\* The selected values for the different adjustment items are stored in the memory so the desired color adjustments can be set.

Quick Color Adj.	◀	Custom	▶
Gamma	◀	Normal	▶
Color Temp.	◀	Normal	▶
White	◀	Low	▶
White Balance			

## Gamma

**Gamma corrects the proportion of change of the dark portions from the bright portions of the input signal.**

**Set this to reproduce natural color tone or to distinctly project a personal computer picture in a bright conference room.**

Select the “Gamma” item name and select the setting contents with the SELECT (◀▶) buttons.

Normal ..... Correction with standard settings

Natural ..... Corrects for natural color tones

Real ..... Corrects with emphasis on brightness

**Note:**

*When “Picture”, “Standard” or “Dynamic” is selected for “Quick Color Adj.”, the “Gamma” adjustment item is displayed in gray and cannot be selected or adjusted.*

Quick Color Adj.	◀	Custom	▶
Gamma	◀	Normal	▶
Color Temp.	◀	Normal	▶
White	◀	Low	▶
White Balance			

## Color

### Color Temp.

The screen color is affected by the color of the illumination and other extraneous light.

This function adjusts the white, which is the reference color for video equipment, and improves the quality of color reproduction. Adjustment can also be used to enhance skin colors.

Select the item name "Color Temp." and select the setting contents with the SELECT (◀▶) buttons.

Low ..... Produces warm whites (reddish)  
Medium ..... Produces warm whites (yellowish)  
Normal ..... Produces the white of sunlight  
High ..... Produces cool whites (bluish)

**Note:**

When "Picture", "Standard" or "Dynamic" is selected for "Quick Color Adj.", the "Color Temp." adjustment item is displayed in gray and cannot be selected or adjusted. See "Quick Color Adj." on E-49.

Quick Color Adj.	◀	Custom	▶
Gamma	◀	Normal	▶
Color Temp.	◀	Normal	▶
White	◀	Low	▶
White Balance			

### White

When projecting, this function is used to emphasize the whites of text or diagrams on the personal computer.

Select the item name "White" and use the SELECT (◀▶) buttons to select the setting contents.

Select the desired degree of white from among "Low", "Medium", and "High".

**Note:**

When "Picture", "Standard" or "Dynamic" is selected for "Quick Color Adj.", the "White" adjustment item is displayed in gray and cannot be selected or adjusted. See "Quick Color Adj." on E-49.

Quick Color Adj.	◀	Custom	▶
Gamma	◀	Normal	▶
Color Temp.	◀	Normal	▶
White	◀	Low	▶
White Balance			

### Color Space

Set this function when a component signal (YPbPr) is projected and the image is extremely red or extremely green.

Select the item name "Color Space" and use the SELECT (◀▶) buttons to select a color space setting that provides a normal image.

**Selection contents at the time of YPbPr input**

BT.709, SMPTE240

Gamma	◀	Normal	▶
Color Temp.	◀	Normal	▶
White	◀	Low	▶
Color Space	◀	BT.709	▶

**Warning:**

When the component signal undergoes conversion processing to red, green, and blue which express the image of the projector, the correct color cannot be reproduced unless a system compliant with the color difference conversion system of the input signal is used. Color Space serves to make this selection.

\* The color space can only be adjusted with high definition TVs.

## White Balance

This function automatically adjusts the black level and the white level of the analog RGB input signal to suit the personal computer.

Quick Color Adj.	◀	Standard	▶
Gamma	◀	Normal	▶
Color Temp.	◀	Normal	▶
White	◀	Low	▶
White Balance			

- 1 Select the item name [White Balance] and press the ENTER button.  
The display will change to [Input Black Signal].
- 2 The screen background color of the connected personal computer will be set to black.
3. Press the ENTER button. The display will change to [Adjusting Black] and the black level will be adjusted.

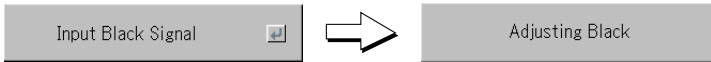

- 4 The adjustment of the black level is completed and the display changes to [Input White Signal].
- 5 The screen background color of the connected personal computer will be set to white.
- 6 Press the ENTER button. The display will change to [Adjusting White] and the white level will be adjusted.

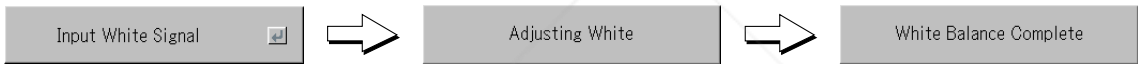

[White balance complete] is displayed for a while and the adjustment is completed.

# View

- Perform this operation while projecting the picture for which the adjustment/setting will be made.
  - Select the menu name “View”.
- See “Menu Operation Method” on Page E-40 for information about performing menu operations. The item name display will differ depending on the input signal. See “List of Item Names Offering Input Selection and Adjustments/Settings” on Page E-45.

## Aspect

This function sets the horizontal and vertical picture proportions of the input signal.

Select the item name “Aspect” and select the setting contents with the SELECT (◀▶) buttons.

### Personal Computer Signal

- Auto ..... Automatically enlarges or reduces the image to project a full screen in a ratio of 4:3
- Direct ..... Maintains the aspect ratio and projects a picture of the maximum displayable size
- Real ..... Projects the input signal without pixel conversion

### Video Signals

- Auto ..... While maintaining the aspect ratio, projects a full screen so that no portions extend beyond the boundaries of the screen. The top and bottom of the 16:9 image becomes black.
- Wide ..... Projects to fill the full width with the entire image at 16:9. (This feature is used to project a squeezed image in a proper aspect ratio.)
- Zoom ..... Projects only the 4:3 portion within 16:9 image to fill the screen. (Portion that extend off screen is cut.)

See “Selection of Aspect Ratio” on Page E-29 for diagrams of projection screen images that correspond to the input signals.

#### Note:

Please note that using this monitor for the purpose of commercial gain or the attraction of public attention in a venue such as a coffee shop or hotel and projecting a 4:3 screen in wide mode or leaving a squeezed screen as a compressed image raises concern about the infringement of the copyright holder's rights which are protected by copyright law.

Aspect	◀	Auto	▶
Filter	◀	3	▶
Vertical Flip	◀	Off	▶
Horizontal Flip	◀	Off	▶
Keystone	0	-	+
Keystone Save	◀	On	▶

## Filter

This function sets the sharpness when the input signal is adjusted to the resolution of the projector and enlarged or reduced.

Select the item name “Filter” and select the setting contents with the SELECT (◀▶) buttons.

Smaller numerical values result in a sharper picture and larger values result in softer picture. Please select your desired setting value.

Aspect	◀	Auto	▶
Filter	◀	3	▶
Vertical Flip	◀	Off	▶
Horizontal Flip	◀	Off	▶
Keystone	0	-	+
Keystone Save	◀	On	▶

## Vertical Flip

In selecting the method of projecting to the screen, these functions are set when the projector is in a suspended or a rear screen installation.

Select the item name “Vertical Flip” or “Horizontal Flip” and select the setting contents with the SELECT (◀▶) buttons.

Aspect	◀	Auto	▶
Filter	◀	3	▶
Vertical Flip	◀	Off	▶
Horizontal Flip	◀	Off	▶
Keystone	0	-	+
Keystone Save	◀	On	▶

“Vertical Flip” Off  
“Horizontal Flip” Off



“Vertical Flip” Off  
“Horizontal Flip” On



“Vertical Flip” On  
“Horizontal Flip” On



“Vertical Flip” On  
“Horizontal Flip” Off

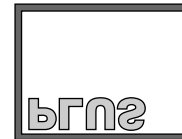

## Keystone

Keystone distortion will occur when the projector and screen are on an angle (in the vertical orientation). This function is used to correct this distortion.

Select the item name “Keystone” and correct the keystone distortion using the SELECT (◀▶) buttons.

Aspect	◀	Auto	▶
Filter	◀	3	▶
Vertical Flip	◀	Off	▶
Horizontal Flip	◀	Off	▶
Keystone	0	-	+
Keystone Save	◀	On	▶



### Note:

- \* The menus and other on-screen displays cannot be adjusted.
- \* Please note that depending on the projected picture and the projection conditions, it may not be possible to eliminate keystone distortion completely.

## Keystone Save

This function is used to save the keystone adjustment values.

Setting Keystone Save to on will set the previous keystone adjustment values when projecting after the power cable has been disconnected and then reconnected.

Select the item name “Keystone Save” and set with the SELECT (◀▶) buttons.

Aspect	◀	Auto	▶
Filter	◀	3	▶
Vertical Flip	◀	Off	▶
Horizontal Flip	◀	Off	▶
Keystone	0	-	+
Keystone Save	◀	On	▶

Off ..... The keystone adjustment values return to the initial values when the power cable is unplugged.

On ..... The keystone adjustment values are retained in storage even when the power cable has been unplugged.

### Note:

Regardless of whether Keystone Save is set to “On” or “Off”, when projection is from the standby condition, the picture is projected using the previous keystone adjustment values.

# Setup

- **Select menu name “Setup”.**

See “Menu Operation Method” on Page E-40 for information about performing menu operations. The item name display will differ depending on the input signal. See “List of Item Names Offering Input Selection and Adjustments/Settings” on Page E-45.

## Color B/W Switching



Applicable Projector: U5-632h/U5-532h

Documents, spreadsheets or other mostly black and white data can be projected with stronger brightness. It is possible to switch between the black/white and color mode while an image is being projected.

Select the “Color B/W Switching” item name, then use the ◀ and ▶ SELECT buttons to select the desired setting.

Color ..... The color image projection mode is set.

B/W ..... The high brightness black/white image projection mode is set.

Color B/W Switching	◀	Color	▶
Auto Source	◀	On	▶
Auto Power Off	◀	Off	▶
Menu Position	◀		▶
Lamp Mode	◀	Normal	▶
Input Format	◀		▶
Presentation Timer	◀	Off	▶



## Auto Source

The Auto Source function automatically detects the input signal when the power supply is switched on and when the input is switched.

Select the item name “Auto Source” and select the setting contents with the SELECT (◀▶) buttons.

On ..... Switches on the automatic detection function

Off ..... Switches off the automatic detection function

Color B/W Switching	◀	Color	▶
Auto Source	◀	On	▶
Auto Power Off	◀	Off	▶
Menu Position	◀		▶
Lamp Mode	◀	Normal	▶
Input Format	◀		▶
Presentation Timer	◀	Off	▶

### Signal Detection Order When On

The sequence of RGB → VIDEO → S-VIDEO is searched repeatedly.

When a signal is detected, the search is stopped and the image is projected.



## Auto Power Off

This function switches off the projector power automatically when the input of the projector enters a no-signal condition.

Select item name “Auto Power Off” and select the setting contents with the SELECT (◀▶) buttons.

On ..... The power is switched off when there is no signal.

Off ..... The power is not switch off even when there is no signal.

Color B/W Switching	◀	Color	▶
Auto Source	◀	On	▶
Auto Power Off	◀	Off	▶
Menu Position	◀		▶
Lamp Mode	◀	Normal	▶
Input Format	◀		▶
Presentation Timer	◀	Off	▶

### Operation when Function is On

- The “No Signal Power Off” display appears when a no-signal condition continues for approximately 10 seconds. The power is switched off about 5 minutes after this.

If a signal is input during the appearance of the display and an operation button other than the STANDBY button is pressed, the display is closed and the function is cancelled.

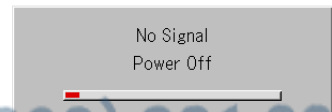

**Note:**

Some video decks and other equipment output a blue background or other video when playback ends. When this happens, a signal is being input to the projector and Auto Power Off is not activated.



## Setup

### Menu Position

This function sets the display position of the menu.

Select item name "Menu Position" and select the setting contents with the SELECT (◀▶) buttons.

- ..... Displays on the left side
- ..... Displays on the right side

Color B/W Switching	◀ Color ▶
Auto Source	◀ On ▶
Auto Power Off	◀ Off ▶
Menu Position	◀  ▶
Lamp Mode	◀ Normal ▶
Input Format	◀  ▶
Presentation Timer	◀ Off ▶

### Lamp Mode



Use this if the picture is projected on a small screen and the picture is too bright or when projecting images in dark rooms.

Select the item name "Lamp Mode" and select the setting contents with the SELECT (◀▶) buttons.

- Eco ..... The lamp brightness is set to 80% and the lamp life is extended. (STATUS indicator is green)
- Normal ..... The lamp brightness is set to 100% and the screen is bright. (STATUS indicator is off)

**Note:**

*Frequent switching this mode can degrade the lamp.*

Color B/W Switching	◀ Color ▶
Auto Source	◀ On ▶
Auto Power Off	◀ Off ▶
Menu Position	◀  ▶
Lamp Mode	◀ Normal ▶
Input Format	◀  ▶
Presentation Timer	◀ Off ▶

#### STATUS Indicator

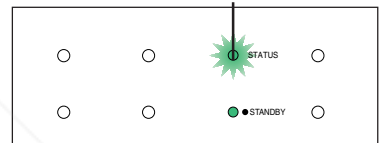



## Setup

### Input Format

This function is used in setting the input signals of the input connectors.

Normally, this should be set to Auto. When identification is not possible with Auto, make the setting.

Select the item name "Input Format", press the ENTER button, and the sub menu will open.

Select the connector that is to be changed, and select the setting contents with the SELECT (◀▶) buttons.



#### [RGB]

This is the signal setting for the RGB connector.

Auto ..... Automatically identifies the signal.

RGB ..... Analog RGB signal is set.

Component . Component signal is set.

Color B/W Switching	◀	Color	▶
Auto Source	◀	On	▶
Auto Power Off	◀	Off	▶
Menu Position	◀		▶
Lamp Mode	◀	Normal	▶
Input Format	◀		▶
Presentation Timer	◀	Off	▶

RGB	◀	Auto	▶
Video	◀	Auto	▶
S-Video	◀	Auto	▶

#### [Video] and [S-Video]

[Video] is the color system setting for the VIDEO connector and [S-Video] is the color system setting for the S-VIDEO connector.

Auto ..... Automatic identification.

NTSC ..... Fixed to the NTSC system.

NTSC 4.43 .. Fixed to the NTSC 4.43 system.

PAL ..... Fixed to the PAL system.

PAL M ..... Fixed to the PAL M system.

PAL N ..... Fixed to the PAL N system.

PAL 60 ..... Fixed to the PAL 60 system.

SECAM ..... Fixed to the SECAM system.

### Presentation Timer

The presentation is given while checking the timer displayed on the screen.

The gauge display allows the remaining time to be known at a glance.

Select the item name "Presentation Timer" and select the setting contents with the SELECT (◀▶) buttons.



**Setting contents:** Off, 10 min., 20 min., 30 min., 40 min., 50 min., 60 min.

#### To start the timer...

Press the MENU button and open the menu.

The timer display will appear at the lower right and the timer will start.

See "Using the Presentation Timer" on Page E-33 for details.

Color B/W Switching	◀	Color	▶
Auto Source	◀	On	▶
Auto Power Off	◀	Off	▶
Menu Position	◀		▶
Lamp Mode	◀	Normal	▶
Input Format	◀		▶
Presentation Timer	◀	Off	▶

# Option

- **Select menu name “Option”.**

See “Menu Operation Method” on Page E-40 for information about performing menu operations. The item name display will differ depending on the input signal. See “List of Item Names Offering Input Selection and Adjustments/Settings” on Page E-45.

## Language

This function sets the language that is displayed on screen in the messages and menu displays.

Select item name “Language” and press the ENTER button to open the Language sub menu.

Select the language with the SELECT (▲▼) buttons.

Language		English
On Screen	◀ On ▶	Deutsch
Background	◀ Blue ▶	Français
Startup Screen	◀ Logo ▶	Italiano
Security Lock	◀ Disable ▶	Español
		Svenska
		한국어
		中文
		日本語

## On Screen

This function switches on/off the messages displayed with a black frame such as the input signal information and the aspect ratio.

Select item name “On Screen” and select the setting contents with the SELECT (◀▶) buttons.

On ..... The message is displayed.

Off ..... The message is not displayed.

**Note:**

Even when set to off, messages that are not in a black frame will be displayed.

Language		
On Screen	◀ On ▶	
Background	◀ Blue ▶	
Startup Screen	◀ Logo ▶	
Security Lock	◀ Disable ▶	

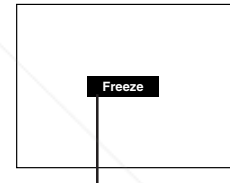

Example of a display when the FREEZE button is pressed

## Background

This function sets the screen color when the input source is no-signal.

Select item name “Background” and select the setting contents with the SELECT (◀▶) buttons.

Blue ..... Sets a blue screen when there is no signal

Black ..... Sets a black screen when there is no signal

Language		
On Screen	◀ On ▶	
Background	◀ Blue ▶	
Startup Screen	◀ Logo ▶	
Security Lock	◀ Disable ▶	

## Option

---

### Startup Screen

This is the selection of whether or not to display the logo screen at startup time.

Select item name “On Screen” and select the setting contents with the SELECT (◀▶) buttons.

Logo ..... Displays the logo.

Blank ..... Does not display the logo.

**Note:**

When “Logo” is selected at the startup screen, the “PLUS” logo is displayed.

Language		
On Screen	◀	On ▶
Background	◀	Blue ▶
Startup Screen	◀	Logo ▶
Security Lock	◀	Disable ▶

### Security Lock

A password can be registered and the security lock set in order to prevent unauthorized use of the projector.

For instructions on using the security function, see “Protecting the Projector with the Security Lock” on E-37.

Select item name “Security Lock” and select the setting contents with the SELECT (◀▶) buttons.

Disable ..... The security lock is disabled.

The projector can be operated without inputting the password.

Enable ..... The security lock is enabled.

The security lock is activated when the power is turned on, and the password must be input in order to operate the projector.

Language		
On Screen	◀	On ▶
Background	◀	Blue ▶
Startup Screen	◀	Logo ▶
Security Lock	◀	Disable ▶

# Info.

- **Select menu name “Info.”**

See “Menu Operation Method” on Page E-40 for information about performing menu operations. The item name display will differ depending on the input signal. See “List of Item Names Offering Input Selection and Adjustments/Settings” on Page E-45.

## Status

**This displays information about the equipment.**

Select item name “Status” and press the ENTER button.  
There is a change to the status display.  
Press the CANCEL button to return to the menu.

**Display Contents:**

Projector model, firmware version, and the internet home page address of PLUS Vision Corp.

Status	
Factory Default	
Lamp Timer Reset	
Resolution	1024 X 768
Frequency	60 Hz, 78KHz
Lamp Timer	1000 h

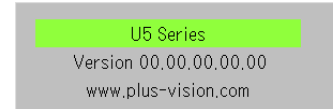

## Factory Default

**This function returns the adjustments and settings of all the input sources to the standard factory default values.**

Select item name “Factory Default” and press the ENTER button.  
There is a change to the display [Press “ENTER” to Factory Default Set].

Press the ENTER button to initialize.  
To cancel, press the CANCEL button and there will be a return to the menu.

**Items that are not set to the factory default:**

Projection method, Language and Lamp Timer and Security.

Status	
Factory Default	
Lamp Timer Reset	
Resolution	1024 X 768
Frequency	60 Hz, 78KHz
Lamp Timer	1000 h

Press “ENTER” to FactoryDefault Set

## Lamp Timer Reset

**This function resets the lamp timer. Be sure to perform the reset operation when the lamp cartridge has been replaced.**

Select item name “Lamp Timer Reset” and press the ENTER button.

There is a change to the display “Press “ENTER” to Lamp Timer Reset”.

Press the ENTER button to initialize.  
To cancel, press the CANCEL button and there will be a return to the menu.

Status	
Factory Default	
Lamp Timer Reset	
Resolution	1024 X 768
Frequency	60 Hz, 78KHz
Lamp Timer	1000 h

Press “ENTER” to LampTimer Reset

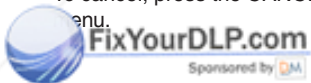

**Discount-Merchant.com (800) 281-8860**  
**THE TRUSTED SOURCE FOR PROJECTOR LAMPS AND ACCESSORIES**

## Info.

---

### Resolution / Frequency

This function displays the resolution and frequency of the detected input signal.

Status	
Factory Default	
Lamp Timer Reset	
Resolution	1024 X 768
Frequency	60 Hz, 78KHz
Lamp Timer	1000 h

### Lamp Timer

This displays the lamp timer.

This projector has an Eco mode function. The lamp life will differ between Normal mode and Eco mode.

#### Lamp Life

Use only in Normal mode: approx.2000 hours

Use only in Eco mode: approx.3000 hours

\* Lamp life will differ when there has been switching between the modes.

Status	
Factory Default	
Lamp Timer Reset	
Resolution	1024 X 768
Frequency	60 Hz, 78KHz
Lamp Timer	1000 h

- **When Lamp Life Has Been Reached**

"Replace the Lamp Cartridge" is displayed on the screen for 10 seconds in a 1-minute interval.

Please replace the lamp with a new one.

See "Replacing the Lamp Cartridge" on Page E-64 for information about lamp cartridge replacement.

- **When Over 100 Hours Have Elapsed Since Reaching Lamp Life (Including Eco Mode)**

[Warning!! System Shutdown] is displayed for 10 seconds and the power is switched off. Pressing the STANDBY button under this condition will not switch on the power. Please replace the lamp cartridge.











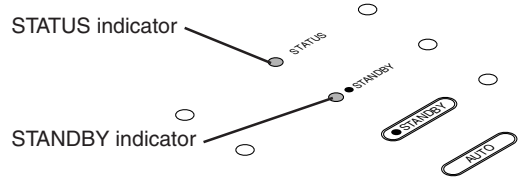



**Discount-Merchant.com (800) 281-8860**  
**THE TRUSTED SOURCE FOR PROJECTOR LAMPS AND ACCESSORIES**

# When an Indicator is Lit or Flashing

The indicators on the projector's control panel light or flash to notify of problems, as described below.

An indicator is also used to notify you of the currently set power mode (under normal circumstances). See "Power Cable Connections and Switching the Power On/Off" on page E-23.



Indicator status		What you should do
 STATUS Lit red  STANDBY <b>When the power is on</b> (Lit green) <b>Standby</b> (Lit amber)	<b>It is time to replace the lamp.</b> Replace with a new lamp cartridge.	
 STATUS Lit red  STANDBY Flashing amber for 60 seconds, then lit amber	<b>The lamp has reached the end of its service life. The power will no longer turn on.</b> The projector can be used for 100 hours after the lamp has reached the end of its service life. Replace with a new lamp cartridge.	
 STATUS Flashing red (lit for 1 seconds/off for 1 seconds)  STANDBY Lit red	<b>The lamp cover is open.</b> The lamp cover is not properly mounted. Mount it properly.	
 STATUS Flashing red (lit for 0.5 seconds/off for 0.5 seconds)  STANDBY Lit red	<b>The temperature is abnormally high.</b> <ul style="list-style-type: none"> <li>The temperature protector has been activated. If the room temperature is high, move the projector to a cool place. If the projector's internal temperature is high, check the cooling fan's ventilation slots and clean them if they are clogged.</li> <li>When the temperature protector is activated, the power turns off and in some cases will not turn back on immediately. In this case wait about 90 seconds, then try again.</li> </ul>	
 STATUS Flashing red (lit for 0.5 seconds/off for 0.5 seconds)  STANDBY Lit amber	<b>The fan has stopped.</b> Unplug the power cable and contact a store that sells the U5-632h/U5-732h/U5-532h/U5-512h for repairs.	
 STATUS Flashing red (lit for 1 seconds/off for 1 seconds)  STANDBY <b>When the lamp has burned out during use</b> Flashing amber for 90 seconds, then lit amber <b>When the lamp does not come on from the start</b> Lit amber	<b>The lamp will not light.</b> Wait at least 90 seconds, then turn the power back on. If the problem persists, unplug the power cord and contact a store that sells the U5-632h/U5-732h/U5-532h/U5-512h for repairs.	

Should an indicator be in a condition other than normal or flash at a rate other than the aforementioned, disconnect the power cable and contact your store of purchase.

## Thermal Protector

When the temperature inside the projector becomes abnormally high, the STATUS indicator flashes red (0.5 seconds on/0.5 seconds off), the STANDBY indicator is a steady red, and at the same time the temperature protector operates and switches off the power of the projector.

Should this happen, please take the following actions.

1. Switch off the power and disconnect the power plug from the wall outlet.
2. Check the following matters and take the required measures.

When the projector is being used in a location that has a high ambient temperature, set it up again in a cool location. Check the outflow and intake holes and clean them if they are obstructed.

3. Wait about 60 minutes until the temperature of the projector drops.

If after having performed the above matters, the problem still has not been solved, please contact your store of purchase.

# Troubleshooting

Check the following matters before requesting servicing.

Problem	Check	Reference Page
Power does not turn on	<ul style="list-style-type: none"> <li>Is the power cord plugged into a power outlet?</li> <li>Is the lamp cover properly mounted?</li> <li>Is the projector's temperature high? To protect the projector, the power cannot be turned on when the projector's temperature is abnormally high.</li> <li>Has the lamp reached the end of its service life?</li> <li>Depending on the timing with which the power cord is plugged in (the power is turned on), it may happen that the STANDBY indicator (LED) does not light and the power does not turn on. This is not a malfunction. If this happens, unplug the power cord then plug it back in.</li> </ul>	<p>E-23 E-66 E-61</p> <p>E-61 —</p>
No image is produced	<ul style="list-style-type: none"> <li>Is a connected input selected?</li> <li>Is the cable properly connected to the input terminal?</li> <li>When a computer is connected, are signals being output from the computer?</li> <li>Does the signal being input have a frequency usable with this projector?</li> <li>Are the brightness and contrast adjusted to the minimum?</li> <li>Is the STATUS indicator lit a steady red or flashing red?</li> <li>When the component signal of the DVD player is connected with the RGB connector and the image is not output, is [Input Settings] of the RGB connector properly selected?</li> <li>For a RGB input, has the picture been properly adjusted?</li> </ul>	<p>E-28 E-18–20 E-60 E-71 E-47 E-61 E-56</p> <p>E-47, 48</p>
Image is distorted	<ul style="list-style-type: none"> <li>Is the projector properly installed?</li> <li>For trapezoidal (keystone) distortion, perform keystone adjustment. Please note that depending on the projected picture and the projection conditions, it may not be possible to eliminate keystone distortion completely.</li> </ul>	<p>E-26 E-31, 53</p>
Image is out of focus	<ul style="list-style-type: none"> <li>Is the lens properly focused?</li> <li>Are the screen and projector installed at the proper distance?</li> <li>Does the projection distance exceed the focusing range?</li> <li>Is there condensation on the lens, etc.? If the projector is moved from a cool storage area to a warm place and the power is turned on, condensation may form on the lens or internal optical parts. If this happens, wait until the condensation has evaporated before using the projector.</li> </ul>	<p>E-27 E-14–16 E-14–16 —</p>
Image is not in proper position and is not displayed properly	<ul style="list-style-type: none"> <li>For a computer input, are the horizontal and vertical positions properly adjusted?</li> <li>Does the input signal have a compatible resolution and frequency? Check the computer's resolution.</li> </ul>	<p>E-48 E-71</p>
Video image is crushed	<ul style="list-style-type: none"> <li>If the image is crushed in the horizontal or vertical direction or if it is not displayed over the entire screen, select a different aspect ratio.</li> </ul>	E-29
Colors of the overall image are strange	<ul style="list-style-type: none"> <li>When inputting component signals, is "Color Space" setting correct?</li> <li>For a composite input, is "Tint" properly adjusted?</li> </ul>	<p>E-50 E-47</p>
Characters flicker or colors are offset for RGB inputs	<ul style="list-style-type: none"> <li>From the menu, select "Image" and adjust the "Picture Adj." and "Fine Picture".</li> </ul>	E-47, 48
Cannot select the menu name	<ul style="list-style-type: none"> <li>Other than [Settings], [Option] and [Information], selection will not be possible unless a signal is being input to the projector and the image/picture is projected.</li> </ul>	—
Remote control unit does not operate	<ul style="list-style-type: none"> <li>Are the remote control unit's batteries worn? Replace with new batteries.</li> <li>Is there an obstacle between the remote control unit and the projector's remote control signal sensor?</li> <li>Is the remote control unit outside of range?</li> <li>Are you pointing the remote control unit's transmitter towards the projector's remote control signal sensor?</li> </ul>	<p>E-11, 12 E-12 E-12 E-12</p>
STATUS indicator is lit red or flashing red	<ul style="list-style-type: none"> <li>See "When an indicator is lit or flashing".</li> </ul>	E-61

# Cleaning

- Be certain to disconnect the power plug from the power outlet before cleaning.
- Do not spray or otherwise expose the projector, lens, or screen to volatile substances such as insecticides. Do not leave rubber or vinyl products in contact with the projector for long periods. Doing so could cause them to undergo qualitative changes or the coatings may peel, etc.

## Cleaning a Soiled Projector Main Unit

- Wipe with a lint-free, soft, dry cloth.  
When very dirty, wipe with a cloth that has been moistened with a diluted neutral detergent, then finish with a dry cloth. If a chemically-treated cloth is going to be used, please follow any written warnings.
- Do not wipe with thinner, benzene, or other solvents. Doing so could cause them to undergo qualitative changes or the coatings may peel, etc.
- When removing the dust of the outflow and intake holes, use the brush attachment on a vacuum cleaner to clean out the dust. Avoid using the vacuum directly without attaching the adapter as well as the use of a nozzle adapter.
- Do not scratch or otherwise hit the projector body with your nails or other hard object, since this will cause scratches.

## Dirty Lens

- Clean using the same method you would use to clean a camera lens: Use a commercial blower for camera use or cleaning paper for eye glasses. Be careful not to scratch the lens at this time.

## Dust of the Intake and Outflow Holes

Dust that collects in the intake and outflow holes will obstruct the ventilation and cause the internal temperature to rise which could cause damage. Clean this area carefully. As a guideline, clean at least every 100 hours of usage.

- Switch off the power, check that the STANDBY indicator has changed to a steadily lit amber, then unplug the power cable.
- Clean out the holes from the outside using a vacuum cleaner. Use the brush adapter of the vacuum cleaner to do this. Avoid using the vacuum directly without attaching the adapter as well as the use of a nozzle adapter.

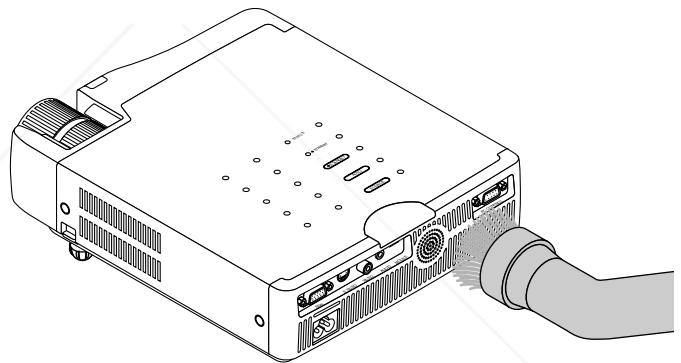

## Cleaning the Inside of the Projector

Cleaning of the inside of the projector is required about once a year. Failure to clean over a long period while dust has collected inside the projector could cause a fire or breakdown. Do not clean the inside of the projector by yourself. Please be sure to contact your dealer.



**Discount-Merchant.com (800) 281-8860**  
**THE TRUSTED SOURCE FOR PROJECTOR LAMPS AND ACCESSORIES**



# Replacing the Lamp Cartridge

- The lamp that is used as a light source in the projector has a limited service life. The rated service life of the lamp is about 2000 hours (when used in normal mode only). This could be shortened depending on conditions of use and other factors.  
Note that lamp life will be extended when the projector is often used in Eco mode. (The rated service life of the lamp means the average value of lamp life for lamps that have been manufactured over a long period, and it is derived from test conditions at this company.)
- When the life of the lamp is exceeded, the STATUS indicator lights a steady red and the message [Replace the Lamp Cartridge] is displayed on the screen. When this occurs, it is time to replace the lamp cartridge. Please make the replacement following the procedure below.
- If the projector is used another 100 hours after the lamp's service life is reached, the power is set to the standby mode and no longer turns on.
- Contact a store that sells the U5-632h/U5-732h/U5-532h/U5-512h for a replacement lamp. Indicate you need a U5-201 replacement lamp for the U5-632h/U5-732h/U5-532h/U5-512h (order code 28-030).

## CAUTION

- Replacement of the lamp cartridge is performed after switching off the power, waiting for the cooling fan to stop, disconnecting the power plug from the power outlet, and then leaving the projector for about 60 minutes before replacement is started. Replacement of the lamp cartridge during operation or immediately after operation stops will cause burns because of the high temperature.
- Do not remove any screws other than those specified.
- Do not touch the lamp with bare hands. Doing so could shorten the life of the lamp.
- If lamp has reached the end of its usable life, the lamp bulb may shatter. When this happens, an explosive sound can be heard and pieces of glass may be scattered in the lamp cartridge. Do not touch them as the pieces of glass may cause injury. If this happens, contact your dealer or the store the projector was purchased.



**Discount-Merchant.com (800) 281-8860**  
**THE TRUSTED SOURCE FOR PROJECTOR LAMPS AND ACCESSORIES**

## Replacing the Lamp Cartridge

**Preparations:** Turning the projector upside-down on top of a soft cloth, etc., so that it does not get scratched makes it easier to replace the lamp cartridge. Turn the projector right-side up after replacing the lamp cartridge.

**1** Unplug the power cord.

**2** Turn the projector upside-down.

**3** Remove the lamp cover.

(1) Turn the lamp cover's set screw counterclockwise and loosen until the screw turns freely. (The screw does not come off.)

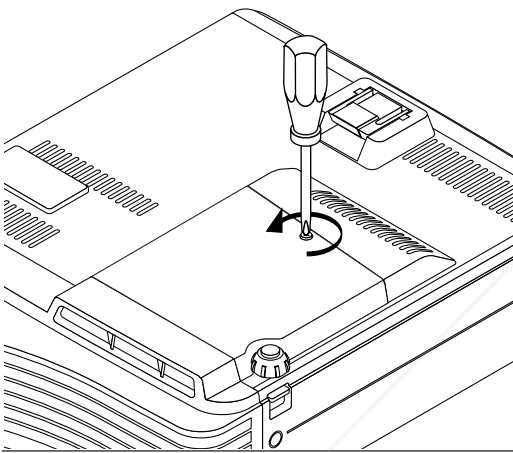

(2) Open the lamp cover a little, then pull it in the direction of the arrow and remove it.

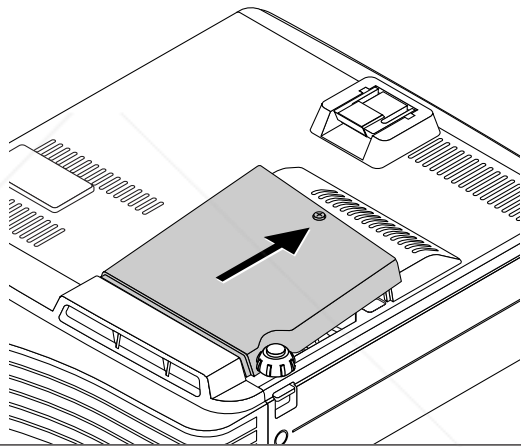

**4** Remove the lamp cartridge.

(1) Turn the lamp cartridge's screw counterclockwise and loosen them until the screw turn freely. (The screw do not come off.)

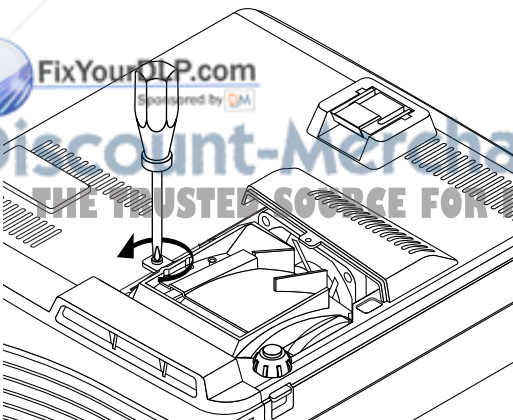

(2) Grasp the lamp cartridge's handle and pull upward to remove the lamp cartridge.

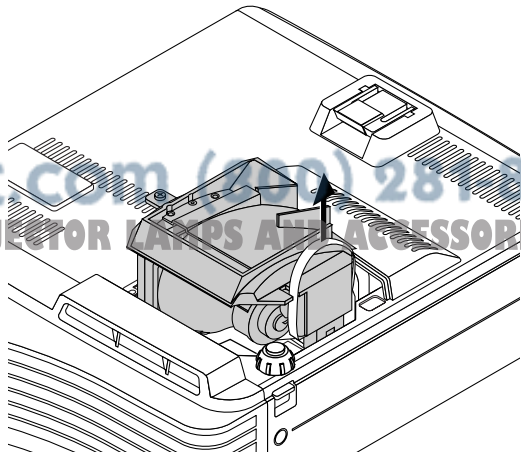

FixYourDLP.com  
Sponsored by DLP  
Discount-Merchant.com (800) 281-8860  
THE TRUSTED SOURCE FOR PROJECTOR LAMPS AND ACCESSORIES

## Replacing the Lamp Cartridge

### 5 Mount the new lamp cartridge.

- (1) Push the lamp cartridge in slowly.  
(Line it up with the screw holes in the projector.)
- (2) Turn the lamp cartridge screw clockwise to tighten them.

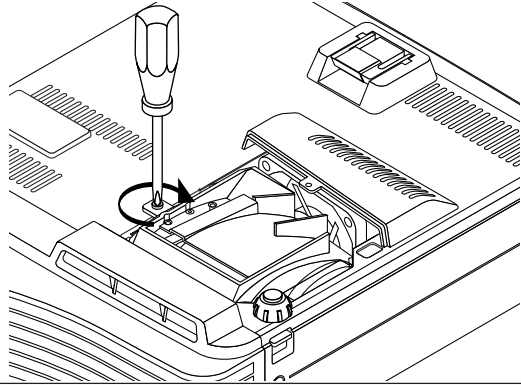
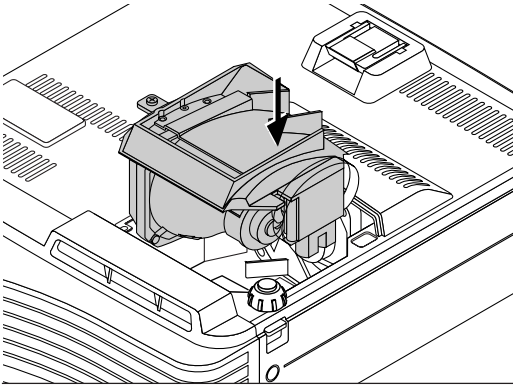

### 6 Mount the lamp cover.

- (1) Set the tip of the lamp cover in place, then close the lamp cover.
- (2) Turn the lamp cover's screw clockwise to tighten it.

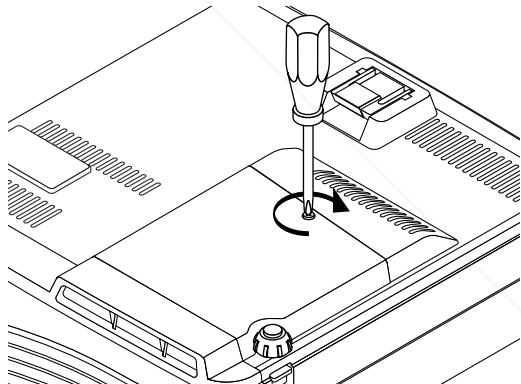
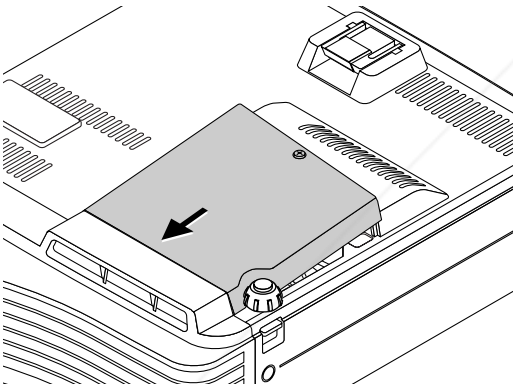

### 7 Reset the Lamp Timer.

Connect the power cable, switch on the power, and then reset.

Select [Info.] → [Lamp Timer Reset] on the menu and press the ENTER button. There is a change to the initialization verification display. Press the ENTER button again. See "Lamp Timer Reset" on Page E-59.



**Discount-Merchant.com (800) 281-8860**  
**THE TRUSTED SOURCE FOR PROJECTOR LAMPS AND ACCESSORIES**

**Note:**

After reaching the lamp service life, if the lamp is used for more than another 100 hours, it will not be possible to switch on the power. Should this happen, while the projector is in the standby mode, simultaneously holding down the projector's SOURCE button and AUTO button for more than 5 seconds will clear the lamp timer. Checking that the STATUS indicator is out will show that the lamp timer has been cleared. Contact a store that sells the U5-632h/U5-732h/U5-532h/U5-512h for a replacement lamp. Indicate you need a U5-201 replacement lamp for the U5-632h/U5-732h/U5-532h/U5-512h (order code 28-030).

# Specifications

**Model** U5-632h

## Optical

Method of projection : DLP™ (single DLP™ chip)  
DLP™ chip 0.7 inches 1024×768 dots  
Lamp 200 W high pressure mercury lamp  
Projection lens : Manual zoom (×1.2), Manual focus F = 2.6 – 2.9, f = 18.4 – 22.1 mm (f = 0.72 – 0.87 inch)  
Image size Minimum: 38.4 inch (at projection distance of 1.2m(3.9 feet) telephoto)  
Maximum: 300 inch (at projection distance of 8.0m(26.2 feet) wide)  
Light Output Standard mode: 2300 lumens (in the “Dynamic” mode)  
B/W mode: 3000 lumens (in the “Dynamic” mode)  
Contrast Ratio 2000:1 (Full on/off)

## Electrical

Inputs Video (NTSC3.58/NTSC4.43/PAL/PAL-N/PAL-M/PAL60/SECAM/YCbCr(NTSC, PAL)/YPbPr(480p, 576p, 1080i, 720p)): (automatic or manual switching)  
RGB (Horizontal: 15 to 80 kHz, Vertical: 50 to 85 Hz)  
Color Reproduction Full color (16,770,000 colors)  
Resolution VGA (640×480) expansion/true, S-VGA (800×600) expansion/true  
XGA (1024×768) true, S-XGA (1280×1024) compression  
Input Current 2.8/1.4 A  
Power Requirement 100 – 120/220 – 240 V AC, 50/60 Hz  
Power Consumption 280 watts (250 watts in eco mode)

## Mechanical

Dimensions Excluding Stand 216 mm (W)×60 mm (H)×252 mm (D) (not including protrusion)  
8.5 in.(W)×2.4 in.(H)×10.3 in.(D) (not including protrusion)  
Weight Approximately 2.0 kg / 4.4 lbs  
Operational Temperatures Data projector: 5° to 35°C (41° to 95°F), 30 to 85% humidity

- Specifications and design are subject to change without notice.



**Discount-Merchant.com (800) 281-8860**  
**THE TRUSTED SOURCE FOR PROJECTOR LAMPS AND ACCESSORIES**

## Specifications

---

**Model** U5-732h

### Optical

Method of projection : DLP™ (single DLP™ chip)  
DLP™ chip 0.7 inches 1024×768 dots  
Lamp 200 W high pressure mercury lamp  
Projection lens : Manual zoom (×1.2), Manual focus F = 2.4 – 2.6, f = 26.5 – 31.8 mm (f = 1.04 – 1.25 inch)  
Image size Minimum: 27 inch (at projection distance of 1.2 m (3.9 feet) telephoto)  
Maximum: 300 inch (at projection distance of 11.5 m (37.7 feet) wide)  
Light Output 2500 lumens (in the “Dynamic” mode)  
Contrast Ratio 2000:1 (Full on/off)

### Electrical

Inputs Video (NTSC3.58/NTSC4.43/PAL/PAL-N/PAL-M/PAL60/SECAM/YCbCr(NTSC, PAL)/YPbPr(480p, 576p, 1080i, 720p)): (automatic or manual switching)  
RGB (Horizontal: 15 to 80 kHz, Vertical: 50 to 85 Hz)  
Color Reproduction Full color (16,770,000 colors)  
Resolution VGA (640×480) expansion/true, S-VGA (800×600) expansion/true  
XGA (1024×768) true, S-XGA (1280×1024) compression  
Input Current 2.8/1.4 A  
Power Requirement 100 – 120/220 – 240 V AC, 50/60 Hz  
Power Consumption 280 watts (250 watts in eco mode)

### Mechanical

Dimensions Excluding Stand 216 mm (W)×60 mm (H)×260 mm (D) (not including protrusion)  
8.5 in.(W)×2.4 in.(H)×10.2 in.(D) (not including protrusion)  
Weight Approximately 2.1 kg / 4.6 lbs  
Operational Temperatures Data projector: 5° to 35°C (41° to 95°F), 30 to 85% humidity

- Specifications and design are subject to change without notice.



**Discount-Merchant.com (800) 281-8860**  
**THE TRUSTED SOURCE FOR PROJECTOR LAMPS AND ACCESSORIES**

## Specifications

---

**Model** U5-532h

### Optical

Method of projection : DLP™ (single DLP™ chip)  
DLP™ chip 0.55 inches 1024 × 768 dots  
Lamp 200 W high pressure mercury lamp  
Projection lens : Manual zoom (× 1.2), Manual focus F = 2.6 – 2.9, f = 20.0 – 24.0 mm (f = 0.79 – 0.94 inch)  
Image size Minimum: 27.6 inch (at projection distance of 1.2m(3.9 feet) telephoto)  
Maximum: 300 inch (at projection distance of 11.1m(36.4 feet) wide)  
Light Output Standard mode: 2000 lumens (in the “Dynamic” mode)  
B/W mode: 3000 lumens (in the “Dynamic” mode)  
Contrast Ratio 2000:1 (Full on/off)

### Electrical

Inputs Video (NTSC3.58/NTSC4.43/PAL/PAL-N/PAL-M/PAL60/SECAM/YCbCr(NTSC, PAL)/YPbPr(480p, 576p, 1080i, 720p)): (automatic or manual switching)  
RGB (Horizontal: 15 to 80 kHz, Vertical: 50 to 85 Hz)  
Color Reproduction Full color (16,770,000 colors)  
Resolution VGA (640 × 480) expansion/true, S-VGA (800 × 600) expansion/true  
XGA (1024 × 768) true, S-XGA (1280 × 1024) compression  
Input Current 2.8/1.4 A  
Power Requirement 100 – 120/220 – 240 V AC, 50/60 Hz  
Power Consumption 280 watts (250 watts in eco mode)

### Mechanical

Dimensions Excluding Stand 216 mm (W) × 60 mm (H) × 240 mm (D) (not including protrusion)  
8.5 in.(W) × 2.4 in.(H) × 10.3 in.(D) (not including protrusion)  
Weight Approximately 2.0 kg / 4.4 lbs  
Operational Temperatures Data projector: 5° to 35°C (41° to 95°F), 30 to 85% humidity

- Specifications and design are subject to change without notice.



**Discount-Merchant.com (800) 281-8860**  
**THE TRUSTED SOURCE FOR PROJECTOR LAMPS AND ACCESSORIES**

## Specifications

---

**Model** U5-512h

### Optical

Method of projection : DLP™ (single DLP™ chip)  
DLP™ chip 0.55 inches 800 × 600 dots  
Lamp 200 W high pressure mercury lamp  
Projection lens : Manual zoom (× 1.2), Manual focus F = 2.6 – 2.9, f = 20.0 – 24.0 mm (f = 0.79 – 0.94 inch)  
Image size Minimum: 27.6 inch (at projection distance of 1.2m(3.9 feet) telephoto)  
Maximum: 300 inch (at projection distance of 11.1m(36.4 feet) wide)  
Light Output Standard mode: 2000 lumens (in the “Dynamic” mode)  
Contrast Ratio 2000:1 (Full on/off)

### Electrical

Inputs Video (NTSC3.58/NTSC4.43/PAL/PAL-N/PAL-M/PAL60/SECAM/YCbCr(NTSC, PAL)/YPbPr(480p, 576p, 1080i, 720p)): (automatic or manual switching)  
RGB (Horizontal: 15 to 80 kHz, Vertical: 50 to 85 Hz)  
Color Reproduction Full color (16,770,000 colors)  
Resolution VGA (640 × 480) expansion/true, S-VGA (800 × 600) true  
XGA (1024 × 768) compression  
Input Current 2.8/1.4 A  
Power Requirement 100 – 120/220 – 240 V AC, 50/60 Hz  
Power Consumption 280 watts (250 watts in eco mode)

### Mechanical

Dimensions Excluding Stand 216 mm (W) × 60 mm (H) × 240 mm (D) (not including protrusion)  
8.5 in.(W) × 2.4 in.(H) × 10.3 in.(D) (not including protrusion)  
Weight Approximately 1.9 kg / 4.2 lbs  
Operational Temperatures Data projector: 5° to 35°C (41° to 95°F), 30 to 85% humidity

- Specifications and design are subject to change without notice.



**Discount-Merchant.com (800) 281-8860**  
**THE TRUSTED SOURCE FOR PROJECTOR LAMPS AND ACCESSORIES**

# Table of Supported Frequency

The projector automatically identifies the signal input from the computer and selects the optimum resolution as shown on the table below.

Manual adjustments may be required for some input signals. See "Picture Adj. / Fine Picture / H Position / V Position" on page E-47, 48.

Signal	Resolution	Frequency		Video	Component	Digital	Analog
		Horizontal (kHz)	Vertical (Hz)				
VIDEO(NTSC)	—	15.734	60.0	○	○	—	—
VIDEO(PAL/SECAM)	—	15.625	50.0	○	○	—	—
PC/AT	640 × 350	31.5	70.1	—	—	—	○
	640 × 400	31.5	70.1	—	—	—	○
	720 × 350	31.5	70.0	—	—	—	○
	720 × 400	31.5	70.0	—	—	—	○
VESA	640 × 350	37.9	85.1	—	—	—	○
	640 × 400	37.9	85.1	—	—	—	○
	720 × 400	37.9	85.0	—	—	—	○
	640 × 480	31.5	60.0	—	—	—	○
	640 × 480	37.9	72.8	—	—	—	○
	640 × 480	37.5	75.0	—	—	—	○
	640 × 480	43.3	85.0	—	—	—	○
	800 × 600	35.2	56.3	—	—	—	○
	800 × 600	37.9	60.3	—	—	—	○
	800 × 600	46.9	75.0	—	—	—	○
	800 × 600	48.1	72.2	—	—	—	○
	800 × 600	53.7	85.1	—	—	—	○
	1024 × 768	48.4	60.0	—	—	—	○
	1024 × 768	56.5	70.1	—	—	—	○
	1024 × 768	60.0	75.0	—	—	—	○
	1024 × 768	68.7	85.0	—	—	—	○
1280 × 1024	64.0	60.0	—	—	—	○	
Apple Macintosh	640 × 480	35.0	66.7	—	—	—	○
	823 × 624	49.7	74.5	—	—	—	○
	1024 × 768	60.2	74.9	—	—	—	○
	1152 × 870	68.7	75.1	—	—	—	○
HDTV (1080i)	1920 × 1080	33.8	60.0	—	○	—	—
	1920 × 1080	28.1	50.0	—	○	—	—
(720p)	1280 × 720	45.0	60.0	—	○	—	—
EDTV (576p)	720 × 576	31.3	50.0	—	○	—	—
	(480p)	720 × 480	31.5	60.0	—	○	—
SDTV (576i)	720 × 576	31.3	50.0	—	○	—	—
	(480i)	720 × 480	31.5	60.0	—	○	—

\* The model name for XGA is U5-632h/U5-732h/U5-532h and SVGA U5-512h.

\* The projector does not support the ADC connector on Apple Macintosh.

○ : Supported frequency

— : Not supported frequency

## U5-632h/U5-732h/U5-532h

The display resolution is 1024 × 768 dots. When displaying a signal with resolutions other than 1024 × 768 dots such as 1280 × 1024, sizes of characters or lines may be uneven.

## U5-512h

The display resolution is 800 × 600 dots. When displaying a signal with resolutions other than 800 × 600 dots such as 1024 × 768, sizes of characters or lines may be uneven.

**THE TRUSTED SOURCE FOR PROJECTOR LAMPS AND ACCESSORIES**



# Cabinet Dimensions

Applicable Projector:  
U5-632h

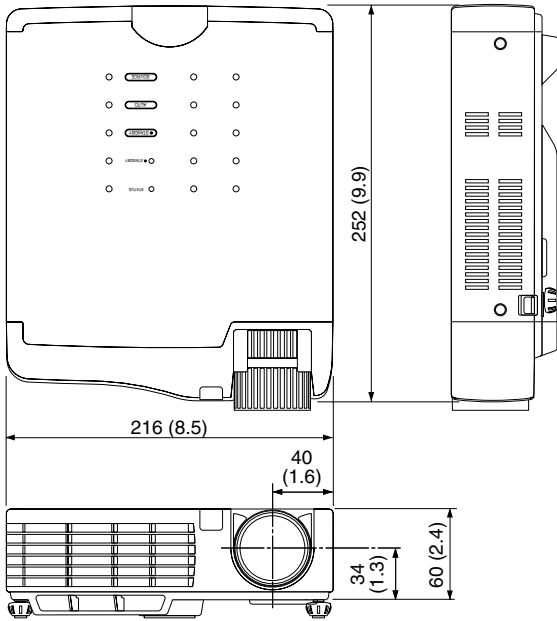

Applicable Projector:  
U5-732h

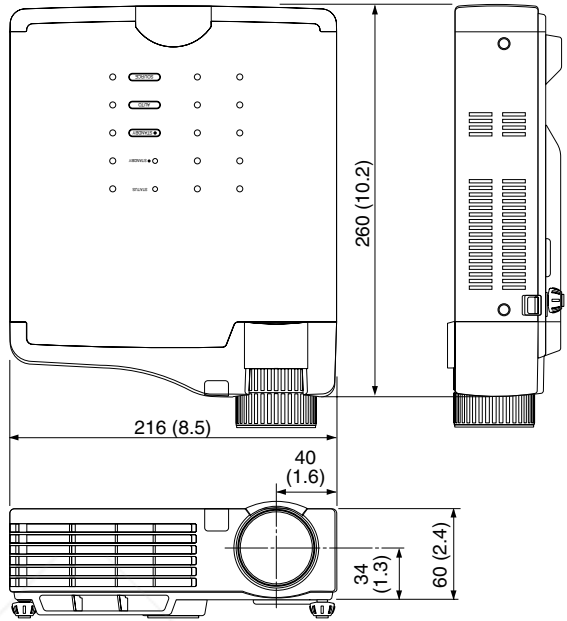

Applicable Projector:  
U5-532h/U5-512h

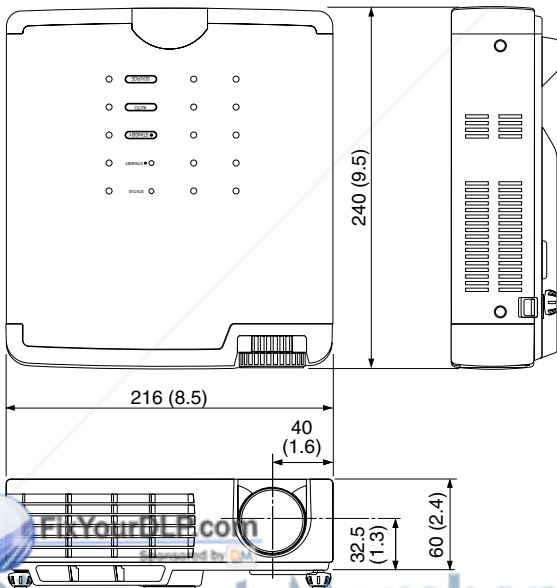

Unit: mm (inch)

Discount-Merchant.com (800) 281-8860  
THE TRUSTED SOURCE FOR PROJECTOR LAMPS AND ACCESSORIES

# PLUS Vision Corp.

Higashi-ikebukuro Center Bldg., 41-24, Higashi-ikebukuro 4-chome,  
Toshima-ku, Tokyo 170-0013 JAPAN

[www.plus-vision.com](http://www.plus-vision.com)

email: [plusvision@plus.co.jp](mailto:plusvision@plus.co.jp)



**Discount-Merchant.com (800) 281-8860**

**THE TRUSTED SOURCE FOR PROJECTOR LAMPS AND ACCESSORIES**



PLUS Vision Corp. has  
ISO 9001 certification.  
Certificate No. 12 100 17398 TMS



PLUS Vision Corp. has  
ISO 14001 certification.  
Certificate No. NQE-0210118A



# Disclaimer

This user manual is provided as a free service by FixYourDLP.com. FixYourDLP is in no way responsible for the content of this manual, nor do we guarantee its accuracy. FixYourDLP does not make any claim of copyright and all copyrights remain the property of their respective owners.

About FixYourDLP.com

FixYourDLP.com (<http://www.fixyourdpl.com>) is the World's #1 resource for media product news, reviews, do-it-yourself guides, and manuals.

Informational Blog: <http://www.fixyourdpl.com>

Video Guides: <http://www.fixyourdpl.com/guides>

User Forums: <http://www.fixyourdpl.com/forum>

FixYourDLP's Fight Against Counterfeit Lamps:

<http://www.fixyourdpl.com/counterfeits>

## Sponsors:

RecycleYourLamp.org – Free lamp recycling services for used lamps:

<http://www.recycleyourlamp.org>

Lamp Research - The trusted 3rd party lamp research company:

<http://www.lampresearch.com>

Discount-Merchant.com – The worlds largest lamp distributor:

<http://www.discount-merchant.com>



**FixYourDLP.com**

Sponsored by 