



Disclaimer

This user manual is provided as a free service by FixYourDLP.com. FixYourDLP is in no way responsible for the content of this manual, nor do we guarantee its accuracy. FixYourDLP does not make any claim of copyright and all copyrights remain the property of their respective owners.

About FixYourDLP.com

FixYourDLP.com (<http://www.fixyourdpl.com>) is the World's #1 resource for media product news, reviews, do-it-yourself guides, and manuals.

Informational Blog: <http://www.fixyourdpl.com>

Video Guides: <http://www.fixyourdpl.com/guides>

User Forums: <http://www.fixyourdpl.com/forum>

FixYourDLP's Fight Against Counterfeit Lamps:

<http://www.fixyourdpl.com/counterfeits>

Sponsors:

RecycleYourLamp.org – Free lamp recycling services for used lamps:

<http://www.recycleyourlamp.org>

Lamp Research - The trusted 3rd party lamp research company:

<http://www.lampresearch.com>

Discount-Merchant.com – The worlds largest lamp distributor:

<http://www.discount-merchant.com>



FixYourDLP.com

Sponsored by 

Table of Contents

Table of Contents	1
Usage Notice.....	2
Safety Information	2
Precautions.....	3
Eye Safety Warnings	5
Introduction.....	6
Product Features	6
Package Overview.....	7
Product Overview	8
Main Unit.....	8
Control Panel	9
Connection Ports	10
Remote Control.....	11
Installation	12
Connecting the Projector.....	12
Powering On/Off the Projector.....	13
Powering On the Projector.....	13
Powering Off the projector	14
Warning Indicator.....	14
Adjusting the Projected Image.....	15
Adjusting the Projector's Height.....	15
Adjusting the Projector's Zoom / Focus	16
Adjusting Projected Image Size	16
User Controls	17
Control Panel & Remote Control	17
On-screen Display Menus	20
How to operate	20
Menu Tree.....	21
Image	22
Display	28
Setup.....	31
Options.....	35
Appendices.....	38
Troubleshooting.....	38
Image Problems	38
Intermission Problems	41
Projector Status Indication	41
Remote Control Problems	43
Replacing the Lamp.....	44
Compatibility Modes	46
RS232 Commands.....	48
Ceiling Mount Installation	51
Optoma Global Offices	52
Regulation & Safety notices	54



FixYourDLP.com



Sponsored by

Discover the merchant.com (800) 281-8860

THE TRIPLET SOURCE FOR PROJECTOR LAMPS AND ACCESSORIES

Usage Notice

Safety Informations

	The lightning flash with arrow head within an equilateral triangle is intended to alert the user to the presence of uninsulated "dangerous voltage" within the product's enclosure that may be of sufficient magnitude to constitute a risk of electric shock to persons.
	The exclamation point within an equilateral triangle is intended to alert the user to the presence of important operating and maintenance (servicing) instructions in the literature accompanying the appliance.

WARNING: TO REDUCE THE RISK OF FIRE OR ELECTRIC SHOCK, DO NOT EXPOSE THE PROJECTOR TO RAIN OR MOISTURE. DANGEROUS HIGH VOLTAGES ARE PRESENT INSIDE THE ENCLOSURE. DO NOT OPEN THE CABINET. REFER SERVICING TO QUALIFIED PERSONNEL ONLY.

Class B emissions limits

This Class B digital apparatus meets all requirements of the Canadian Interference-Causing Equipment Regulations.

Important Safety Instruction

1. Read these instructions -before using this projector.
2. Keep these instructions -for future reference.
3. Follow all instructions.
4. Install in accordance with the manufacturer's instructions :
 - A. Do not block any ventilation openings.** To ensure reliable operation of the projector and to protect it from overheating, put the projector in a position and location that will not interfere with its proper ventilation. For example, do not place the projector on a bed, sofa, carpet, or similar surface that may block the ventilation openings. Do not put it in an enclosure, such as a bookcase or a cabinet that may keep air from flowing through its ventilation openings.
 - B. Do not use this projector near water or moisture.** To reduce the risk of fire or electric shock, do not expose the projector to rain or moisture.
 - C. Do not install near any heat sources,** such as radiators, heaters, stoves or other apparatus (including amplifiers) that produce heat.
5. Clean only with a dry cloth.
6. Only use attachments/accessories specified by the manufacturer.
7. Refer all servicing to qualified service personnel. Servicing is required when the projector has been damaged in any way, such as:
 - Power supply cord or plug is damaged.
 - Liquids have spilled or objects have fallen into the apparatus.
 - The projector has been exposed to rain or moisture, does not operate normally, or has been dropped.
- Do not attempt to service this projector yourself. Opening or removing covers may expose you to dangerous voltages or other hazards. Please call Optoma to be referred to an authorized service center near you.
8. Do not let objects or liquids enter the projector as they may touch dangerous voltage points or short-out parts that could result in a fire or electric shock.
9. See projector enclosure for safety related markings.
10. The projector should not be adjusted or repaired by anyone except properly qualified service personnel.

Precautions



Please follow all warnings, precautions and maintenance as recommended in this user's guide.

- Warning- Do not look into the projector's lens when the lamp is on. The bright light may damage your eyes.
- Warning- To reduce the risk of fire or electric shock, do not expose this projector to rain or moisture.
- Warning- Please do not open or disassemble the projector as this may cause electric shock.
- Warning- When replacing the lamp, please allow unit to cool down, and follow all replacement instructions. See pages 44-45.
- Warning- This projector will detect the life of the lamp itself. Please be sure to change the lamp when it shows warning messages.
- Warning- Use the "Lamp Reset" function from the on-screen display "Options | Lamp Settings" menu after replacing the lamp module (refer to page 37).
- Warning- When switching the projector off, please ensure the cooling cycle has been completed before disconnecting the power. Allow 90 seconds for the projector to cool down.
- Warning- Do not use the lens cap when projector is in operation.
- Warning- When the lamp is approaching to the end of its life, the message "Lamp Warning: Lamp life exceeded." will show on the screen. Please contact your local reseller or service center to change the lamp as soon as possible.
- Warning- To reduce the risk of injury to the eyes, do not look directly into the laser beam on the remote control and do not point the laser beam into anyone's eyes. This remote control is equipped with a Class II laser that emits radiation.

NOTE

- ❖ When the lamp reaches the end of its life, the projector will not turn back on until the lamp module has been replaced. To replace the lamp, follow the procedures listed under "Replacing the Lamp" section on pages 44-45.



FixYourDLP.com

Discount-Merchants.com (800) 360-3660
THE TRUSTED SOURCE FOR PROJECTOR LAMPS AND ACCESSORIES

Usage Notice

Do:

- ❖ Turn off the product before cleaning.
- ❖ Use a soft cloth moistened with a mild detergent to clean the display housing.
- ❖ Disconnect the power plug from the AC outlet if the product is not being used for a long period of time.

Don't:

- ❖ Do not block the ventilation slots and openings on the unit.
- ❖ Do not use abrasive cleaners, waxes or solvents to clean the unit.
- ❖ Do not use under the following conditions:
 - In extremely hot, cold or humid environments.
 - ▶ Ensure that the ambient room temperature is within 5 - 35°C
 - ▶ Relative Humidity is 5 - 35°C, 80% (Max.), non-condensing
 - In areas susceptible to excessive dust and dirt.
 - Near any appliance that generates a strong magnetic field.
 - In direct sunlight.



Discount-Merchant.com (800) 281-8860
THE TRUSTED SOURCE FOR PROJECTOR LAMPS AND ACCESSORIES

Eye Safety Warnings



- Avoid staring directly into the projector's beam of light at all times.
- Minimize standing facing into the beam. Keep your back to the beam as much as possible.
- Using a stick or laser pointer is recommended to avoid the need for the presenter to enter the beam.
- Ensure that projectors are located out of the line of sight from the screen to the audience; this ensures that, when presenters look at the audience, they do not also have to stare at the projector lamp. The best way to achieve this is by ceiling-mounting the projector rather than placing it on floor or table top.
- When projector is used in a classroom, adequately supervise students when they are asked to point out something on the screen.
- In order to minimize the lamp power needed, use room blinds to reduce ambient light levels.



Discount-Merchant.com (800) 281-8860
THE TRUSTED SOURCE FOR PROJECTOR LAMPS AND ACCESSORIES

Introduction

Product Features

*This product is a 720p single chip 0.62" DLP® projector.
Outstanding features include:*

- ◆ Native 16:9 720p DLP® Technology
- ◆ HDMI & component support.
- ◆ Computer Compatibility:
Apple Macintosh, iMac, and VESA Standards:
UXGA, SXGA+, SXGA, XGA, SVGA, VGA
- ◆ Video Compatibility:
 - NTSC M/J, NTSC4.43
 - PAL B/D/I/G/H, PAL M, PAL N
 - SECAM B/D/G/K/L
 - SDTV compatible (480i/p, 576i/p)
 - HDTV compatible (720p, 1080i, 1080p)
- ◆ Auto source detection with user definable settings
- ◆ Full function IR remote control with back light
- ◆ User friendly multilingual On Screen Menu
- ◆ One build-in 2 Watt speaker
- ◆ Three discrete audio inputs
- ◆ Advanced digital keystone correction and high quality full screen image re-scaling
- ◆ User friendly control panel
- ◆ Macintosh and PC compatible
- ◆ DVI-D support (HDCP compliant)
- ◆ TrueVivid™ Image Technology



❖ HDMI supports
HDCP function.

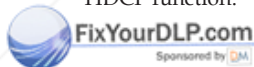

Discount-Merchants.com (800) 281-8860

THE TRUSTED SOURCE FOR PROJECTOR LAMPS AND ACCESSORIES

Introduction

Package Overview

This projector comes with all the items shown below. Check to make sure your unit is complete. Contact your dealer immediately if anything is missing.



Projector with lens cap



Power Cord



RCA Component Cable
for YPbPr



S-Video Cable
(Available in EMEA and
Asia only)



VGA Cable
(Available in EMEA only)



Composite Video Cable
(Available in Asia and US
only)



❖ Due to the difference in applications for each country, some regions may have different accessories.



SCART RGB/S-Video
Adapter
(Available in EMEA only)



IR Remote Control



2 x AAA Batteries



Discount-Merchant.com (800) 281-8860
THE TRUSTED SOURCE FOR PROJECTOR LAMPS AND ACCESSORIES

Documentation :

- User's Manual
- Warranty Card
- Quick Start Card

Introduction

Product Overview

Main Unit

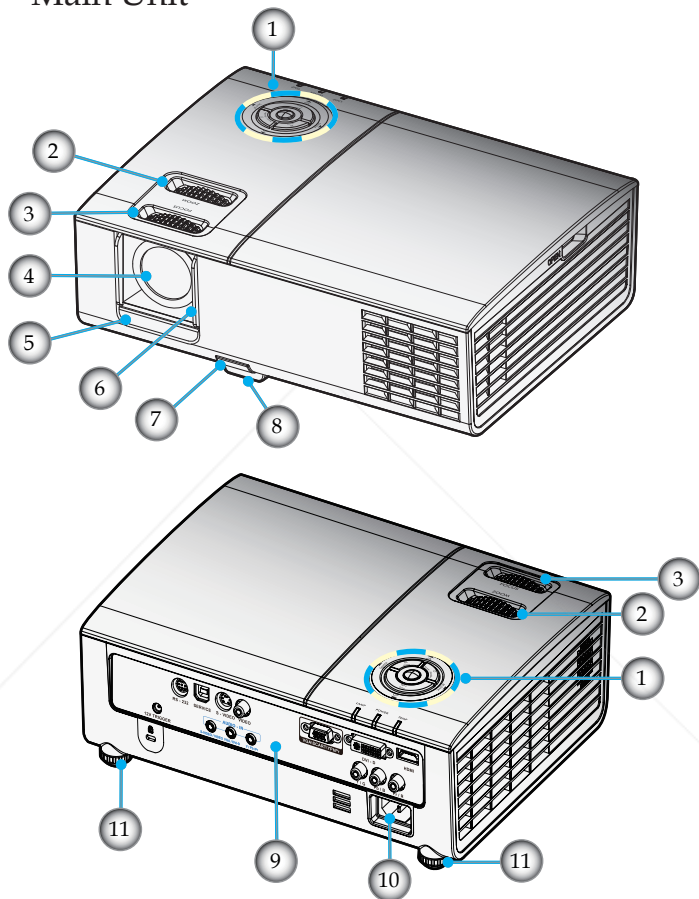

1. Control Panel
2. Zoom
3. Focus
4. Zoom Lens
5. IR Receivers
6. Lens Door

7. Elevator Button
8. Elevator Foot
9. Connection Ports
10. Power Socket
11. Tilt-Adjustment Foot

Discount-Merchant.com (500) 821-8860

THE TRUSTED SOURCE FOR PROJECTOR LAMP AND ACCESSORIES

Introduction

Control Panel

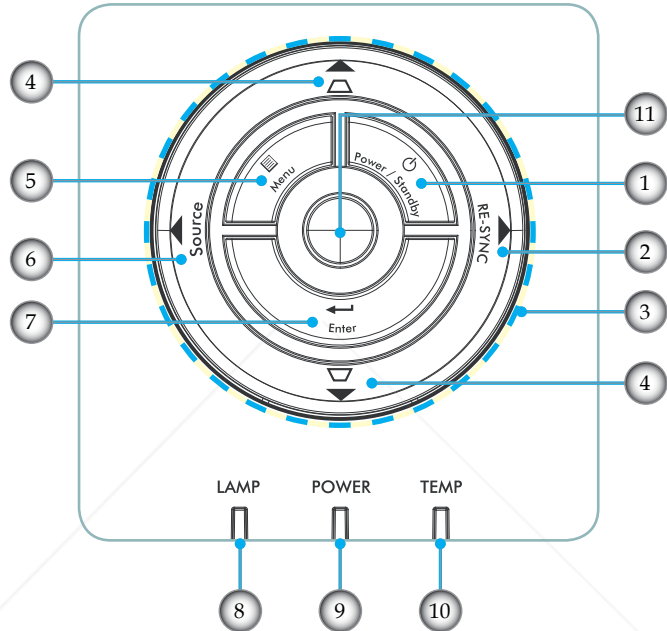

1. Power/Standby
2. Re-Sync
3. Four Directional Select Keys
4. Keystone Correction
5. Menu
6. Source
7. Enter
8. Lamp LED
9. Power LED
10. Temp LED
11. IR Receiver

Introduction

Connection Ports

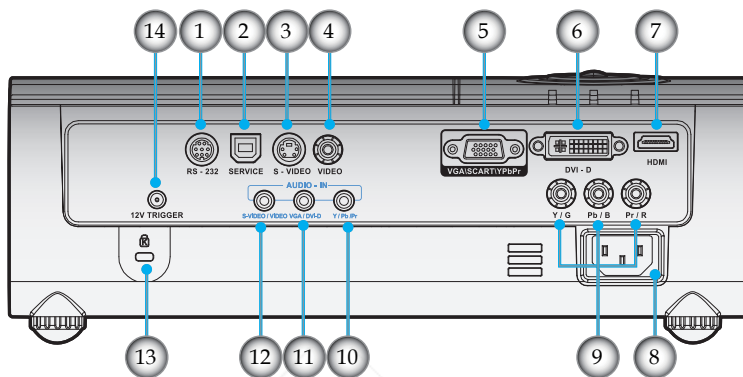

1. RS232 Connector
2. USB Service Port (Factory Use Only)
3. S-Video Input Connector
4. Composite Video Input Connector
5. VGA Input Connector
6. DVI-D Input Connector (PC Digital and HDCP)
7. HDMI Connector
8. Power Socket
9. Component Video Input Connector
10. Audio-In (for Component Connector)
11. Audio-In (for VGA/DVI-D Connector)
12. Audio-In (for S-Video/Video Connector)
13. Kensington™ Lock Port
14. +12V Trigger Relay Connector

Introduction

Remote Control

1. Power On/Off
2. Mode
3. 16:9
4. Native
5. Contrast
6. Menu Format
7. Enter
8. Four Directional Select Keys
9. Re-Sync
10. VGA Source
11. Video Source
12. Component Source
13. HDMI Source
14. Source
15. EdgeMask
16. Brightness
17. LBX
18. 4:3
19. Overscan
20. V-Keystone
21. S-Video Source
22. DVI Source

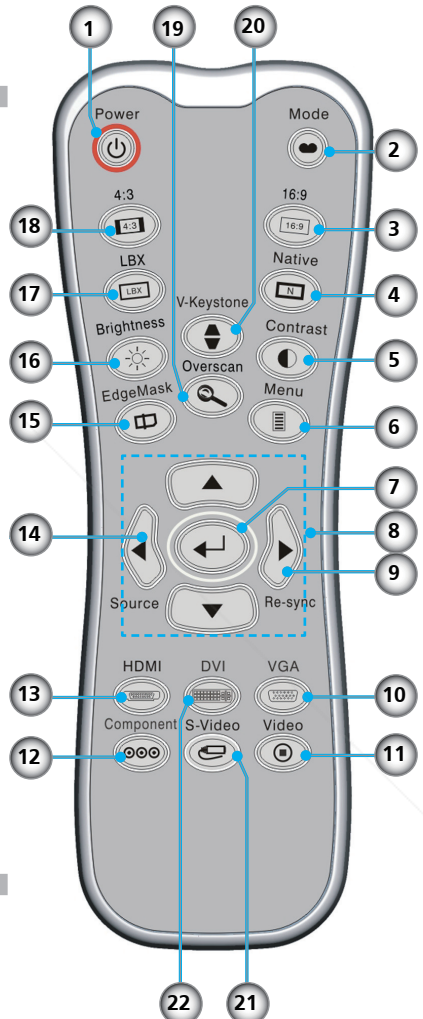

Installation

Connecting the Projector

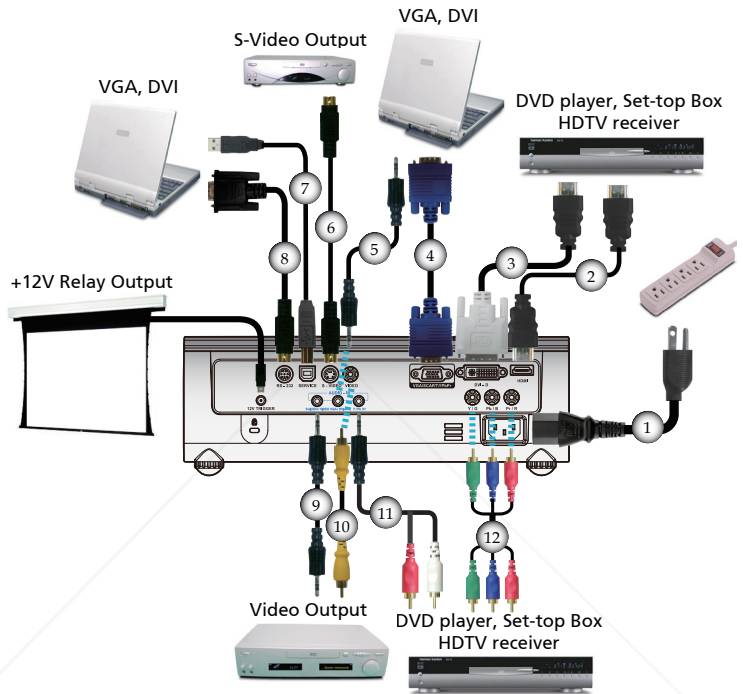

❖ Due to the difference in applications for each country, some regions may have different accessories.

- | | |
|---------|-------------------------------|
| 1..... | Power Cord |
| 2..... | HDMI Cable |
| 3..... | DVI-D Cable |
| 4..... | VGA Cable |
| 5..... | Audio Input Cable |
| 6..... | S-Video Cable |
| 7..... | USB Cable |
| 8..... | RS232 Cable |
| 9..... | Audio Input Cable |
| 10..... | Composite Video Cable |
| 11..... | Audio Input Cable |
| 12..... | RCA Component Cable for YPbPr |



Discount-Merchant.com (800) 888-8560
 THE TRUSTED SOURCE FOR PROJECTOR LAMPS AND ACCESSORIES

Installation

Powering On/Off the Projector

Powering On the Projector

1. Open the lens door. ❶
2. Ensure that the power cord and signal cable are securely connected. ❷ The Power LED will be Amber.
3. Turn on the lamp by pressing “Power/Standby” button either on the top of the projector or pressing “Power” button on the remote. The Power LED will flash green.

The startup screen will display in approximately 10 seconds. The first time you use the projector, you can select your preferred language from quick menu after the startup screen display.

4. Turn on your source (computer, notebook, video player, etc.). The projector will detect your source automatically.
- ❖ If the screen displays “No Signal”, please make sure the signal cables are securely connected.
 - ❖ If you connect multiple sources at the same time, press the “Source” button on the control panel or direct source key on the remote control to switch between inputs.

❷ Power/Standby

❶ Lens Door

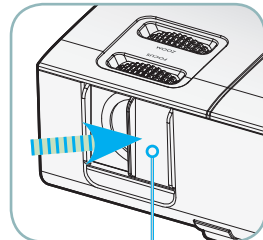
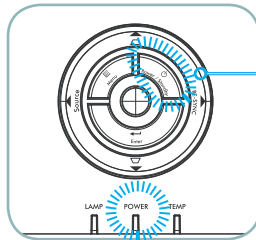

NOTE

- ❖ Turn on the projector first and then select the signal sources.

FixYourDLP.com

Sponsored by

Power LED

Discount-Merchant.com (800) 221-8860
THE TRUSTED SOURCE FOR PROJECTOR LAMPS AND ACCESSORIES

Installation

Powering Off the Projector

1. Press the “Power/Standby” button to turn off the projector lamp, you will see a message displayed on the projector’s screen.

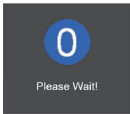
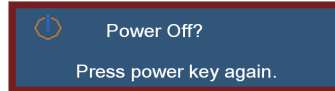

2. Press the “Power/Standby” button again to confirm, otherwise the message will disappear after 15 seconds. When you press “Power/Standby” button second, the system will show the timing countdown on the screen.
3. The cooling fans continue to operate for about 10 seconds for cooling cycle. When the Power LED turn Amber, the projector has entered standby mode.
 - ❖ *If you wish to turn the projector back on, you must wait until the projector has completed the cooling cycle and has entered standby mode. Once in standby mode, simply press “Power/Standby” button to restart the projector.*
4. Disconnect the power cord from the electrical outlet and the projector.
5. Do not turn on the projector immediately following a power off procedure.

Warning Indicator

- ❖ When the “LAMP” indicator lights red, it indicates problem with the lamp and the projector will automatically shut down by itself. Please contact your local reseller or service center. See pages 52-53.
- ❖ When the “TEMP” indicator lights red, it indicates the projector has overheated. The projector will automatically shut itself down.

Under normal conditions, the projector can be switched on again after it has cooled down. If the problem persists, you should contact your local dealer or our service center. See pages 52-53.
- ❖ When the “LAMP” indicator flashes red, it indicates the fan has failed. Please contact your local dealer or our service center. See pages 52-53.

Installation

Adjusting the Projected Image

Adjusting the Projector's Height

The projector is equipped with elevator foot for adjusting the image height.

To raise the image:

1. Press the elevator button **1**.
2. Raise the image to the desired height angle **2**, then release the button to lock the elevator foot into position.
3. Use screw in foot **3** to fine-tune the display angle.

To lower the image:

1. Press the elevator button.
2. Lower the image, then release the button to lock the elevator feet into position.
3. Use screw in foot **3** to fine-tune the display angle.

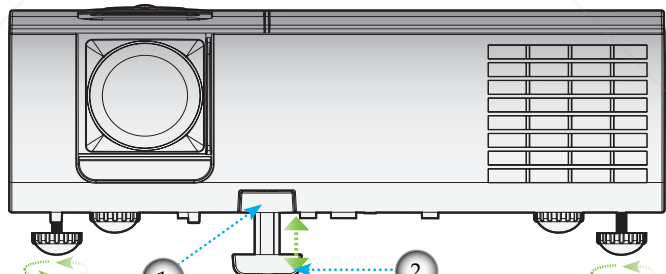

Installation

Adjusting the Projector's Zoom / Focus

You may turn the zoom lever to zoom in or out. To focus the image, rotate the focus ring until the image is clear. The projector will focus at distances from 4.9 to 33.8 feet (1.5 to 10.3 meters).

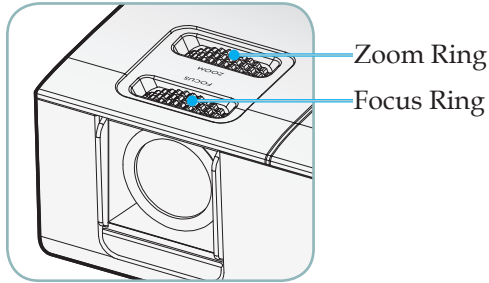

Adjusting Projection Image Size

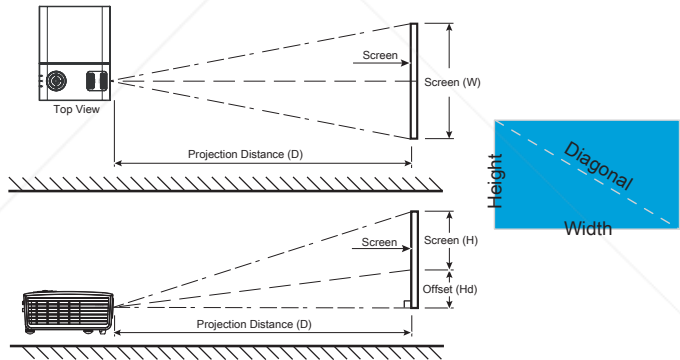

Diagonal length (inch) size of 16:9 Screen	Screen Size W X H (16:9)				Projection distance (D)				Offset (Hd)	
					(m)		(feet)			
	(m)	(feet)	wide	tele	wide	tele	(m)	(feet)		
40	0.89	0.50	2.91	1.63	-	1.50	-	4.92	0.09	0.31
50	1.11	0.62	3.63	2.04	1.72	1.89	5.63	6.19	0.12	0.39
60	1.33	0.75	4.36	2.45	2.06	2.26	6.75	7.43	0.14	0.47
70	1.55	0.87	5.08	2.86	2.40	2.64	7.88	8.67	0.17	0.55
80	1.77	1.00	5.81	3.27	2.75	3.02	9.01	9.91	0.19	0.63
90	1.99	1.12	6.54	3.68	3.09	3.40	10.13	11.15	0.22	0.71
100	2.21	1.25	7.26	4.09	3.43	3.77	11.26	12.38	0.24	0.79
120	2.66	1.49	8.72	4.90	4.12	4.53	13.51	14.86	0.29	0.95
150	3.32	1.87	10.89	6.13	5.15	5.66	16.89	18.58	0.36	1.18
200	4.43	2.49	14.53	8.17	6.86	7.55	22.52	24.77	0.48	1.58
300	6.64	3.74	21.79	12.26	10.29	11.32	33.77	37.15	0.72	2.37

❖ This graph is for user's reference only.

User Controls

Control Panel & Remote Control

There are two ways for you to control the functions: Control Panel and Remote Control.

Control Panel

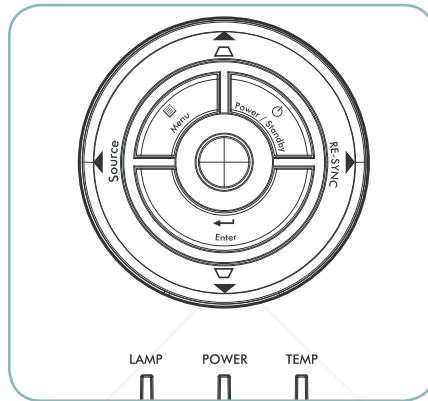

Using the Control Panel

Power	Refer to the “Power On/Off the Projector” section on pages 13-14.
Menu	Press “Menu” to launch the on-screen display (OSD) menu. To exit OSD, Press “Menu” again.
Enter	Confirm your item selection.
Source	Press “Source” to select the input signal source.
Re-Sync	Automatically synchronize the projector to the input source.
Keystone ▽/△	Adjust image distortion caused by tilting the projector (±16 degrees)
Four Directional Select Keys	Use ▲▼◀▶ to select items or make adjustments to your selection.
Power LED	Indicate the projector’s status.
Lamp LED	Indicate the projector’s lamp status.
Temp LED	Indicate the projector’s temperature status.



FixYourDLP.com

Sponsored by

Discount Merchants.com (800) 281-8860













THE TRUSTED SOURCE FOR PROJECTOR REPAIRS AND ACCESSORIES

User Controls

Remote Control



Using the Remote Control

Power		Refer to the "Power On/Off the Projector" section on pages 13-14.
Mode		Select the display mode from Cinema, Bright, TV, Photo and User.
16:9		Scale the image at a 16:9 aspect ratio.
Native		The input source will be displayed without scaling.
Contrast		Control the degree of difference between the lightest and darkest parts of the picture.
Menu		Press "Menu" to launch the on-screen display (OSD) menu. To exit OSD, Press "Menu" again.
Re-Sync		Automatically synchronize the projector to the input source.
VGA		Press "VGA" to choose VGA D-Sub (15 pins) connector source.
Video		Press "Video" to choose Composite video source.
DVI		Press "DVI" to choose DVI source.
S-Video		Press "S-Video" to choose S-Video source.
Component		Press "Component" to choose Component video source.
HDMI		Press "HDMI" to choose source from HDMI connector.
Source		Press "Source" to select the input signal source at the next terminal.

User Controls

Remote Control





EdgeMask  Mask off a few pixels on each edge of the image to be displayed. Use this function to adjust if image source happens to have noise near any edge of the display image.

Brightness  Adjust the brightness of the image.

Letter-Box  Enable the viewing of the letterboxed non-anamorphically enhanced movie at full screen width. Part of the original image will be lost if the image aspect ratio is less than 1.78:1.

4:3  Scale the image at a 4:3 aspect ratio.

Overscan  Zoom the projector display in or out.

V. Keystone  Adjust image distortion vertically and makes a squarer image.

Four Directional Select Keys  Use     to select items or make adjustments to your selection.

Enter  Confirm your item selection.

On-screen Display Menu

The Projector has multilingual On-screen Display menus that allow you to make image adjustments and change a variety of settings. The projector will automatically detect the source.

How to operate

1. To open the OSD menu, press “Menu” on the Remote Control or Projector Keypad.
2. When OSD is displayed, use ◀▶ keys to select any item in the main menu. While making a selection on a particular page, press ▼ or “Enter” key to enter sub menu.
3. Use ▲▼ keys to select the desired item and adjust the settings by ◀▶ key.
4. Select the next item to be adjusted in the sub menu and adjust as described above.
5. Press “Enter” to confirm, and the screen will return to the main menu.
6. To exit, press “Menu” again. The OSD menu will close and the projector will automatically save the new settings.

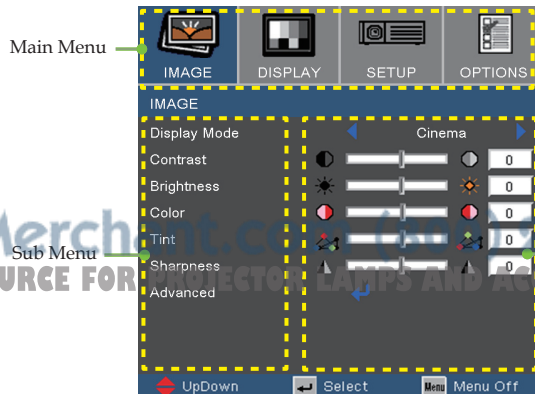

User Controls

Menu Tree

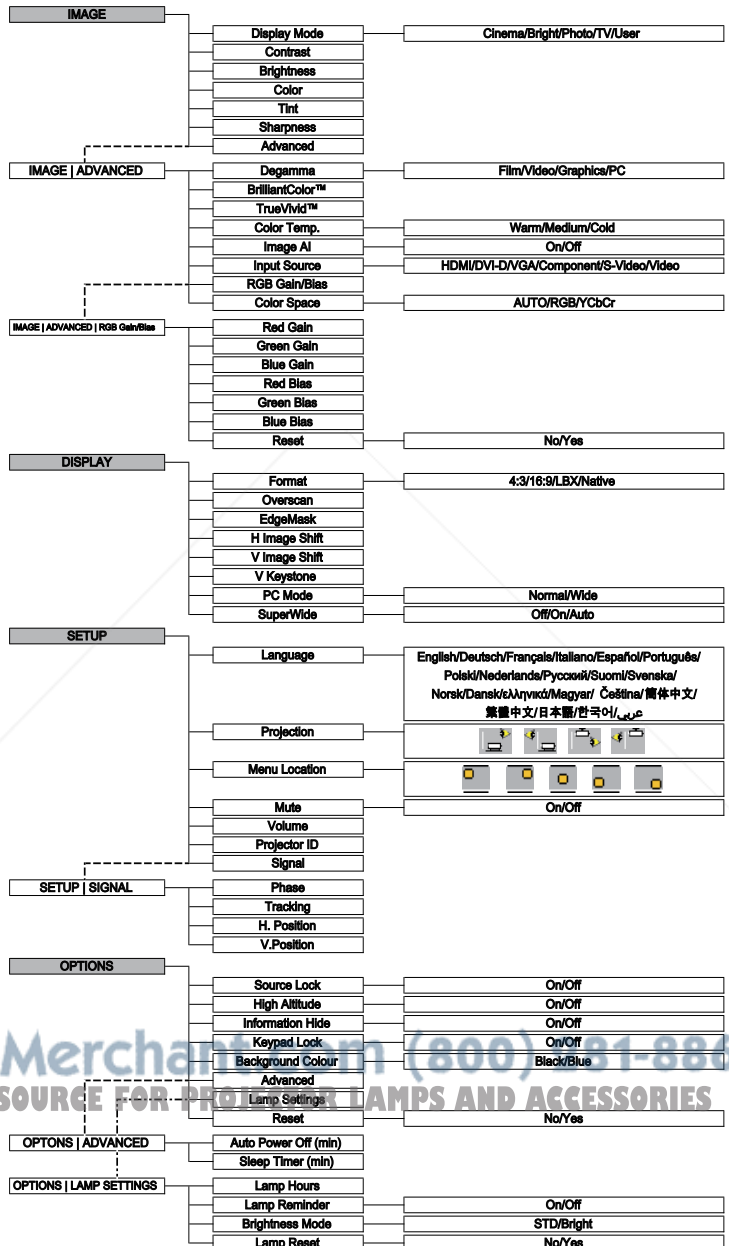

Image

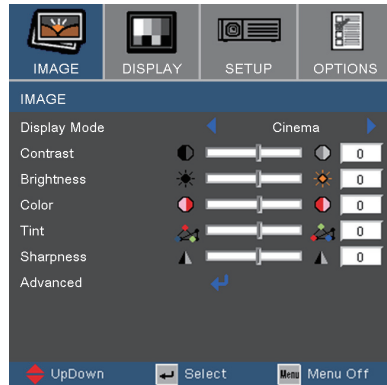

Display Mode

There are many factory presets optimized for various types of images.



❖ "Image mode-->TV" will support automatically "Over-scan" with step "2" as default.

- ▶ Cinema: For home theater.
- ▶ Bright: Maximum brightness from PC input.
- ▶ Photo: Best color reproduction.
- ▶ TV: For TV.
- ▶ User: Memorize user's own settings.

Contrast

The contrast controls the degree of difference between the lightest and darkest parts of the picture. Adjusting the contrast changes the amount of black and white in the image.

- ▶ Press the ◀ to decrease the contrast.
- ▶ Press the ▶ to increase the contrast.

Brightness

Adjust the brightness of the image.

- ▶ Press the ◀ to darken image.
- ▶ Press the ▶ to lighten the image.

Image

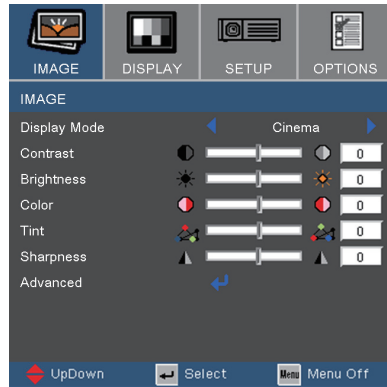

- ❖ “Saturation” and “Tint” functions are only supported under video source.

Color

Adjust a video image from black and white to fully saturated color.

- ▶ Press the ◀ to decrease the amount of color in the image.
- ▶ Press the ▶ to increase the amount of color in the image.

Tint

Adjust the color balance of red and green.

- ▶ Press the ◀ to increase the amount of green in the image.
- ▶ Press the ▶ to increase the amount of red in the image.

Sharpness

Adjust the sharpness of the image.

- ▶ Press the ◀ to decrease the sharpness.
- ▶ Press the ▶ to increase the sharpness.

Image | Advanced

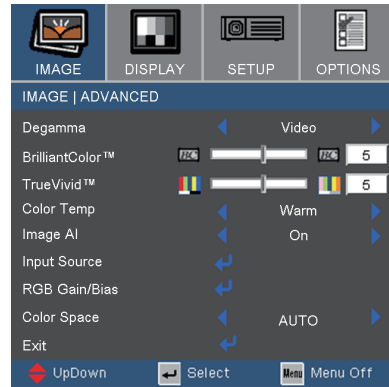

Degamma

This allows you to choose a degamma table that has been fine-tuned to bring out the best image quality for the input.

- ▶ Film: for home theater.
- ▶ Video: for video or TV source.
- ▶ Graphics: for image source.
- ▶ PC: for PC or computer source.

Brilliant Color™

This adjustable item utilizes a new color-processing algorithm and system level enhancements to enable higher brightness while providing true, more vibrant colors in picture. The range is from "0" to "10". If you prefer a stronger enhanced image, adjust toward the maximum setting. For a smoother, more natural image, adjust toward the minimum setting.

TrueVivid™

This adjustable item utilizes a new color-processing algorithm and enhancements to enable the picture's vividness to be significantly increased.

Color Temp.

Adjust the color temperature. With cold temperature, the screen looks colder; with Warm temperature, the screen looks warmer.

Image | Advanced

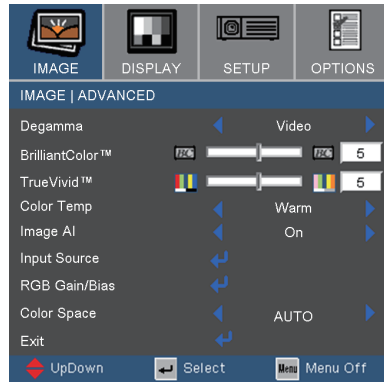
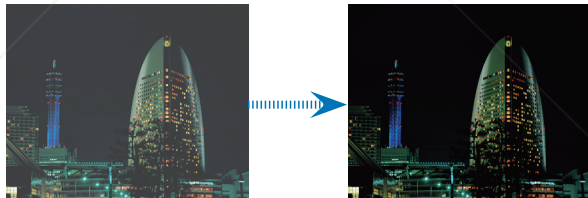

Image AI

Image AI improves the contrast of the picture by optimizing the brightness of the lamp according to the picture content.

- ▶ On: The dynamic image performance manager is active in making sure your greatest pleasure from seeing a movie dynamically with the most dark details revealed, vivid and bright image performed all the way.





- ▶ Off: The dynamic image performance manager is on standby.

User Controls

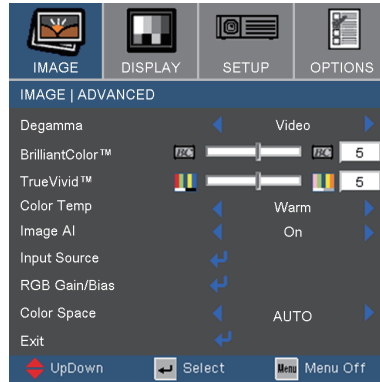
Image | Advanced



Input Source

Enable input sources. Press  into the next menu as below and then use  or  to select. Press "Enter" to finalize the selection. The projector will not search inputs that are de-selected.

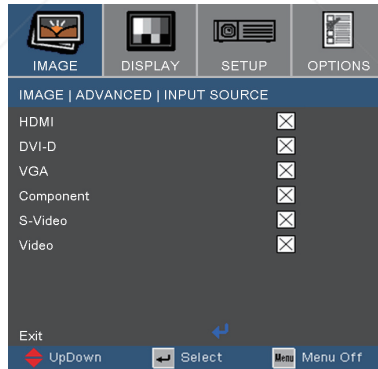
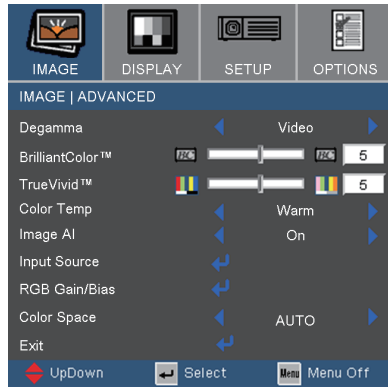
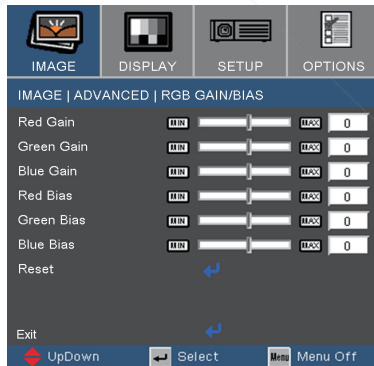

Image | Advanced



RGB Gain/Bias

Press **←** into the next menu as below and then use **▲** or **▼** to select item. Use **◀** or **▶** to select Red, Green, or Blue for brightness (Gain) and contrast (Bias).



Color Space

Select an appropriate color matrix type from RGB or YPbPr.

User Controls

Display

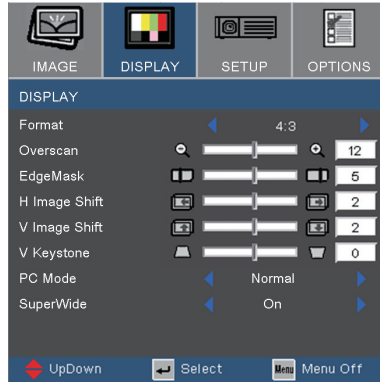

Format

Use this function to choose your desired aspect ratio.

- ▶ 4:3: This format is for 4x3 input sources not enhanced for Wide screen TV.
- ▶ 16:9: This format is for 16x9 input sources, like HDTV and DVD enhanced for Wide screen TV.
- ▶ LBX: This format is for non-16x9, letterbox source and for users who use external 16x9 lens to display 2.35:1 aspect ratio using full resolution.
- ▶ Native: This format displays the original image without any scaling.

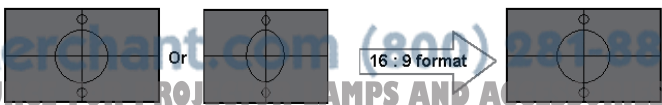
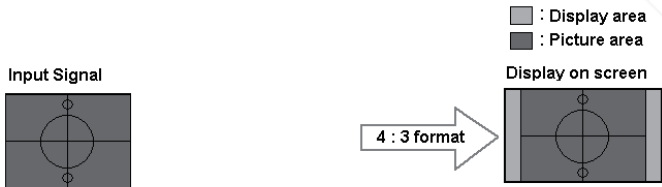

Display

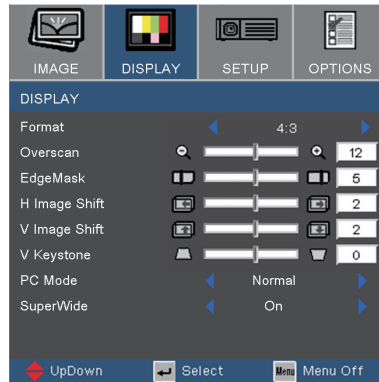

Detail informations about LBX mode :

1. Some Letter-Box DVD contents are not enhanced for 16x9 TV, then image will not look right in 16:9 display. One can use 4:3 mode to view the correct info. But if the content itself is not 4:3, it will have black bars around the image in a 16:9 display. For this kind of content, you can use LBX mode to fill the image in the 16x9 display as much as possible.
2. If you use an external 16x9 lens, this LBX mode also allows you to watch a 2.35:1 content (include Anamorphic DVD and HDTV film source) that support anamorphic wide is enhanced for 16x9 Display in a wide 2.35:1 image.

In this case, there are no black bars, the full lamp power and vertical resolution is fully utilized for maximum viewing effects.

Other than these two occasions, one should stay with 16:9 and 4:3 modes for most viewing experiences.

Overscan

Overscan function removes the noise in a video image. Overscan the image to remove video encoding noise on the edge of video source.

EdgeMask

- ▶ Press the ◀ to reduce the size of an image.
- ▶ Press the ▶ to magnify an image on the projection screen.

H Image Shift

Shift the projected image position horizontally.

Display

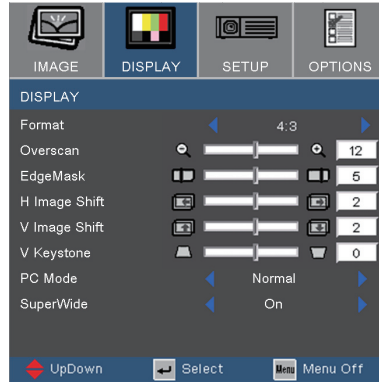

V Image Shift

Shift the projected image position vertically.

V Keystone

Press the ◀ or ▶ to adjust image distortion vertically and makes a squarer image.

PC Mode

This Mode is only for use when using this projector unit with a PC signal, either Analogue connector.



- ❖ “SuperWide” is “Off” as default.
- ❖ How to use “SuperWide”
 1. Use a 2.0:1 screen that buy from Optoma
 2. Enable SuperWide feature to Auto
 3. Use zoom ring in top of projector to fit the image width to the screen width

- ▶ **Wide:** If your PC output is a wide screen format resolution, you must select this setting.

Examples of Wide screen resolutions are: 1280 x 720 / 1920 x 1080.

- ▶ **Normal:** If your PC output is a Normal (4:3) resolution you must select this setting.

Examples of Normal resolutions are: 640 x 480 / 800 x 600 / 1024 x 768 / 1152 x 864 / 1280 x 1024 / 1400 x 1050.

* All supported resolutions are listed on pages 46-47.

SuperWide

Off: The format can be chosen your desired aspect ratio including 4:3, 16:9, LBX and Native.

- ▶ **On:** The format only can be chosen 4:3 and 16:9.
- ▶ **Auto:** To solve the differences of the film formats, the option can keep the format in the same ratio.

User Controls

Setup

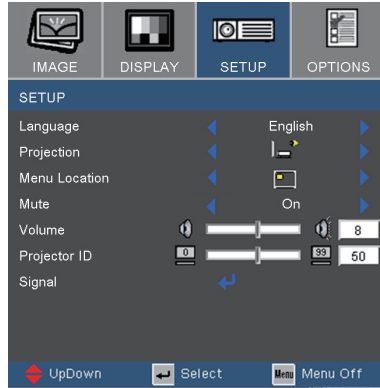

Language





Choose the multilingual OSD menu. Press ◀ or ▶ into the sub menu and then use the ▲ or ▼ key to select your preferred language. Press “Enter” to finalize the selection.

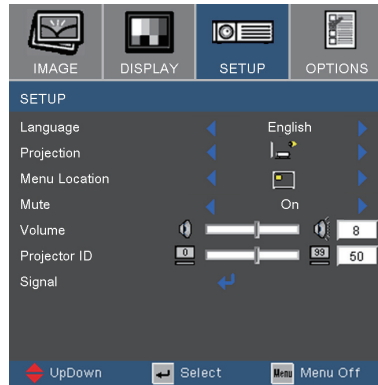

Setup



Projection

- ▶  **Front-Desktop**
The factory default setting.
- ▶  **Rear-Desktop**
When you select this function, the projector reverses the image so you can project behind a translucent screen.
- ▶  **Front-Ceiling**
When you select this function, the projector turns the image upside down for ceiling-mounted projection.
- ▶  **Rear-Ceiling**
When you select this function, the projector reverses and turns the image upside down at same time. You can project from behind a translucent screen with ceiling mounted projection.

Menu Location

Choose the menu location on the display screen.

Mute

- ▶ Choose "On" to turn mute on.
- ▶ Choose "Off" to turn mute off.

Setup

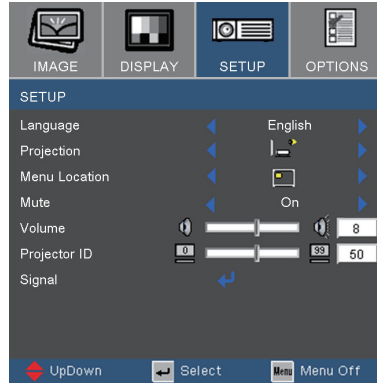

Volume

- ▶ Press the ◀ to decrease the volume.
- ▶ Press the ▶ to increase the volume.

Projection ID

Allow RS232 control of an individual projector. Range 01-99.

Setup | Signal

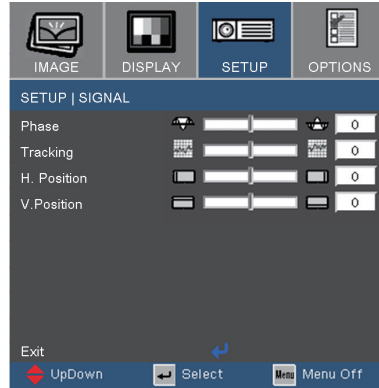

- ❖ “Signal” only supports in VGA(RGB) and component signal.
- ❖ When component signal is 480i or 576i, “Phase” and “Tracking” won’t support.

Phase

Change the display data frequency to match the frequency of your computer’s graphic card. When you experience a vertical flickering bar, use this function to make an adjustment.

Tracking

Synchronize the signal timing of the display with the graphic card. If you experience an unstable or flickering image, use this function to correct it.

H. Position

- ▶ Press the ◀ to move the image left.
- ▶ Press the ▶ to move the image right.

V. Position

- ▶ Press the ◀ to move the image down.
- ▶ Press the ▶ to move the image up.



Discount-Merchant.com (800) 281-8860
THE TRUSTED SOURCE FOR PROJECTOR LAMPS AND ACCESSORIES

Options

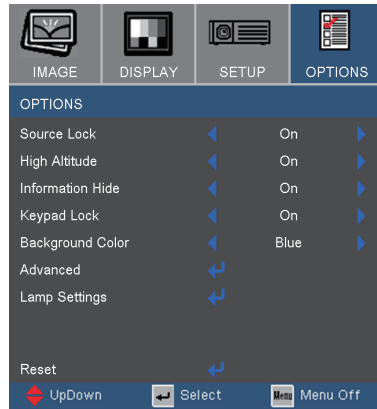

Source Lock

- ▶ On: The projector will search specified connection port.
- ▶ Off: The projector will search for other signals if the current input signal is lost.

High Altitude

Choose "On" to turn on High Altitude mode. Operates the fans at full speed continuously to allow for proper high altitude cooling of the projector.

Information Hide

- ▶ On: Choose "On" to hide the searching message.
- ▶ Off: Choose "Off" to show the searching message.

Keypad Lock

When the keypad lock function is on, the control panel will be locked, but the projector can still be operated by the remote control. If canceling this function, use the remote control or press the "Enter" key on the control panel for 7 seconds to turn it off.

Background Colour

Use this feature to display a "Blue" or "Black" screen when no signal is available.

Reset

Press  to the next menu then choose "Yes" to return the display parameters on all menus to the factory default settings.

Options | Advanced

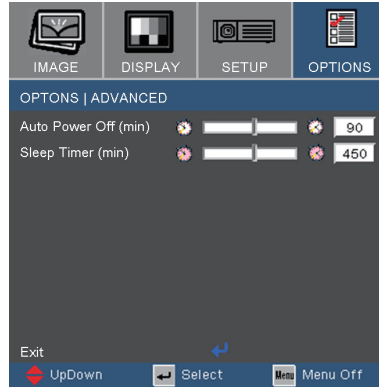

Auto Power Off (min)

Set the countdown timer interval. The countdown timer will start, when there is no signal being sent to the projector. Then projector will automatically power off when the countdown has finished (in minutes).

Sleep Timer (min)

Set the countdown timer interval. The timer will begin, with or without a signal input. Then the projector will automatically power off then the sleep timer countdown has finished.

Options | Lamp Settings

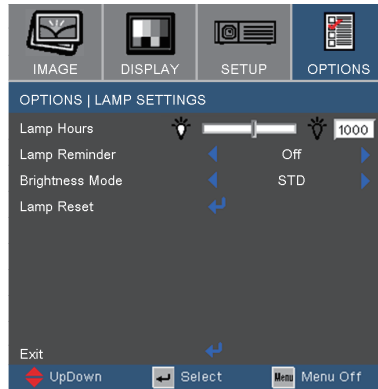

Lamp Hours

Display the projection time.

Lamp Reminder

Choose this function to show or to hide the warning message when the changing lamp message is displayed. The message will appear 30 hours before suggested replacement of lamp.

Brightness Mode

- ▶ STD: Choose “STD” to dim the projector lamp which will lower power consumption and extend the lamp life by up to 130%.
- ▶ BRIGHT: Choose “BRIGHT” to increase the brightness.

Lamp Reset

Reset the lamp life hour after replacing the lamp.

Troubleshooting

*If you experience a problem with your projector, please refer to the following information. If a problem persists, please contact your local reseller or service center.
(See pages 52-53 for details)*

Image Problems

[?] No image appears on-screen

- ▶ Ensure all the cables and power connections are correctly and securely connected as described in the “Installation” section.
- ▶ Ensure all the pins of connectors are not bent or broken.
- ▶ Check if the projection lamp has been securely installed. Please refer to the “Replacing the lamp” section.
- ▶ Make sure you have removed the lens cap and the projector is switched on.

[?] Partial, scrolling or incorrectly displayed image

- ▶ Press “Re-Sync” on the remote.
- ▶ If you are using a PC:

For Windows 95, 98, 2000, XP:

1. Open the “My Computer” icon, the “Control Panel” folder, and then double click on the “Display” icon.
2. Select the “Settings” tab.
3. Verify that your display resolution setting is lower than or equal to UXGA (1600 x 1200).
4. Click on the “Advanced Properties” button.

If the projector is still not projecting the whole image, you will also need to change the monitor display you are using. Refer to the following steps.

5. Verify the resolution setting is lower than or equal to UXGA (1600 x 1200).

Appendices

6. Select the “Change” button under the “Monitor” tab.
 7. Click on “Show all devices”. Next, select “Standard monitor types” under the SP box; choose the resolution mode you need under the “Models” box.
 8. Verify that the resolution setting of the monitor display is lower than or equal to UXGA (1600 x 1200). (*)
- ▶ If you are using a Notebook:
1. First, follow the steps above to adjust resolution of the computer.
 2. Press the toggle output settings. Example: [Fn]+[F4]

Compaq ⇒	[Fn]+[F4]	Hewlett	⇒	[Fn]+[F4]
Dell ⇒	[Fn]+[F8]	Packard	⇒	[Fn]+[F4]
Gateway ⇒	[Fn]+[F4]	NEC ⇒	[Fn]+[F3]	
IBM ⇒	[Fn]+[F7]	Toshiba ⇒	[Fn]+[F5]	

Mac Apple:
System Preference ⇒ Display ⇒ Arrangement ⇒ Mirror display

- ▶ If you experience difficulty changing resolutions or your monitor freezes, restart all equipment including the projector.

? The screen of the Notebook or PowerBook computer is not displaying your presentation

- ▶ If you are using a Notebook PC
Some Notebook PCs may deactivate their own screens when a second display device is in use. Each has a different way to be reactivated. Refer to your computer’s manual for detailed information.

? Image is unstable or flickering

- ▶ Use “Tracking” to correct it. See page 34 for more information.
Change the monitor color setting on your computer.

? Image has vertical flickering bar

- ▶ Use “Phase” to make an adjustment. See page 34 for more information.
- ▶ Check and reconfigure the display mode of your graphic card to make it compatible with the projector.

Appendices

[?] Image is out of focus

- ▶ Make sure the lens cap is removed.
- ▶ Adjust the Focus Ring on the projector lens.
- ▶ Make sure the projection screen is between the required distance 4.9 to 33.8 feet (1.5 to 10.3 meters) from the projector. See page 16.

[?] The image is stretched when displaying 16:9 DVD title

When you play anamorphic DVD or 16:9 DVD, the projector will show the best image in 16:9 format on projector side.

If you play 4:3 format DVD title, please change the format as 4:3 in projector OSD.

If the image is still stretched, you will also need to adjust the aspect ratio by referring to the following:

- ▶ Please setup the display format as 16:9 (wide) aspect ratio type on your DVD player.

[?] Image is too small or too large

- ▶ Adjust the Zoom Ring on the top of the projector.
- ▶ Move the projector closer to or further from the screen.
- ▶ Press [Menu] button on the remote control or projector panel, go to "Display → Format" and try the different settings.

[?] Image has slanted sides

- ▶ If possible, reposition the projector so that it is centered on the screen and below the bottom of the screen.
- ▶ Press [Keystone +/-] button until the sides are vertical on the remote control.

[?] Image is reversed

- ▶ Select "Setup → Projection" from the OSD and adjust the projection direction.



FixYourDLP.com
Use of Keystone is not recommended.

Discount-Merchant.com (800) 281-8860
THE TRUSTED SOURCE FOR PROJECTOR LAMPS AND ACCESSORIES

Intermission Problems

- [?] The projector stops responding to all controls**
 - ▶ If possible, turn off the projector, then unplug the power cord and wait at least 60 seconds before reconnecting power.
- [?] Lamp burns out or makes a popping sound**
 - ▶ When the lamp reaches its end of life, it will burn out and may make a loud popping sound. If this happens, the projector will not turn on until the lamp module has been replaced. To replace the lamp, follow the procedures in the “Replacing the Lamp” section on pages 52-53.

Projector Status Indication

- [?] LED lighting message**

Message	Power / Standby LED	Temp LED	Lamp LED
	(Green/Amber)	(Red)	(Red)
Standby State (Input power cord)	Amber	○	○
Power on (Warming)	Flashing Green	○	○
Lamp lighting	Green	○	○
Error (Over Temp.)	○	☀	○
Error (Fan fail)	○	○	Flashing (1 sec on, 1 sec off)
Error (Lamp fail)	○	○	☀



Steady light → ☀

No light → ○

Appendices

Message Reminders

▶ Fan failed:

Warning! FAN LOCKED

The projector will switch off automatically.

Please contact a service centre for repair.

▶ Temperature warning:

Warning! TEMPERATURE TOO HIGH

Please:

1. Make sure air in and outlets are not blocked.

2. Make sure the environment temperature is under 35 degree C.

If the problem persists in spite of the above.

Please contact a service centre for repair.

▶ Replacing the lamp:



Lamp Warning

Lamp life exceeded.

▶ Out of display range:



Video

Out of display range.

Remote Control Problems

- ?** If the remote control does not work
- ▶ Check the operating angle for the remote control is approximately $\pm 22.5^\circ$.
 - ▶ Make sure there are no obstructions between the remote control and the projector. Move to within 6 m (20 ft) of the projector.
 - ▶ Make sure the batteries are inserted correctly.
 - ▶ Make sure batteries are exhausted. If so, replace weak batteries in the remote control.



Discount-Merchant.com (800) 281-8860
THE TRUSTED SOURCE FOR PROJECTOR LAMPS AND ACCESSORIES

Replacing the lamp

The projector automatically detects the lamp life. When the lamp life is nearing the end of use, you will receive a warning message.



Lamp Warning

Lamp life exceeded.

When you see this message, please contact your local reseller or service center to change the lamp as soon as possible. Make sure the projector has been cooled down for at least 30 minutes before changing the lamp.

! Caution !

If ceiling mounted, use caution when opening lamp panel - Please see user manual for details

 **Warning:** If ceiling mounted, please use caution when opening the lamp access panel. It is recommended to wear safety glasses if changing the bulb when ceiling mounted. "Caution must be used to prevent any loose parts from falling out of projector."

 **Warning:** Lamp compartment may be hot! Allow it to cool down before changing the lamp!

 **Warning:** To reduce the risk of personal injury, do not drop the lamp module or touch the lamp bulb. The bulb may shatter and cause injury if it is dropped.



FixYourDLP.com
Sponsored by 

Discount-Merchant.com (800) 281-8860

THE TRUSTED SOURCE FOR PROJECTOR LAMPS AND ACCESSORIES

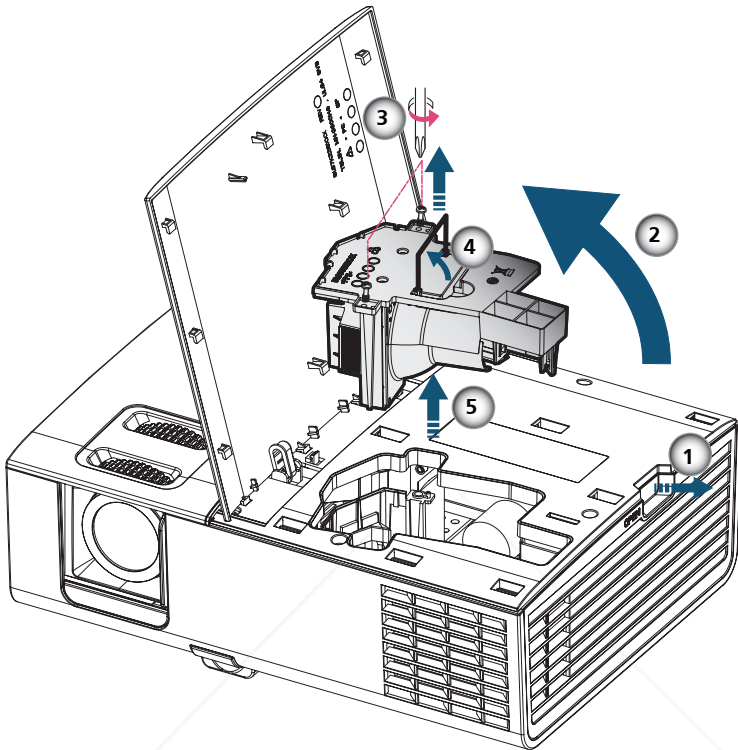

○ Lamp Replacement Procedure: ○

1. Switch off the power to the projector by pressing the "Power/Standby" button.
 2. Allow the projector to cool down for at least 30 minutes.
 3. Disconnect the power cord.
 4. Pull the cover carefully. ❶
 5. Open the top cover. ❷
 6. Use a screwdriver to unscrew the 2 screws from the lamp module. ❸
 7. Pull up the lamp handle carefully. ❹
 8. Pull out and remove the lamp module. ❺
- To replace the lamp module, reverse the previous steps.
9. Turn on the projector and use "Lamp Reset" after the lamp module is replaced.

Lamp Reset: (i) Press "Menu" → (ii) Select "Options" → (iii) Select "Lamp settings" → (iv) Select "Lamp Reset" → (v) Select "Yes".



FixYourDLP.com

Discount-Merchant.com (800) 281-8860
THE TRUSTED SOURCE FOR PROJECTOR LAMPS AND ACCESSORIES

Appendices

Compatibility Modes

Modes	Resolution	V.Frequency (Hz)	Analog	Digital
VGA	640 x 350	70	✓	×
	640 x 350	85	✓	×
	640 x 400	85	✓	×
	640 x 480	60	✓	✓
	640 x 480	72	✓	✓
	640 x 480	75	✓	✓
	640 x 480	85	✓	✓
	720 x 400	70	✓	✓
	720 x 400	85	✓	×
SVGA	800 x 600	56	✓	×
	800 x 600	60	✓	✓
	800 x 600	72	✓	✓
	800 x 600	75	✓	✓
	800 x 600	85	✓	×
XGA	1024 x 768	60	✓	✓
	1024 x 768	70	✓	✓
	1024 x 768	75	✓	✓
	1024 x 768	85	✓	×
SXGA	1152 x 864	70	✓	×
	1152 x 864	75	✓	×
	1152 x 864	85	✓	×
	1280 x 1024	60	✓	✓
	1280 x 1024	75	✓	✓
	1280 x 1024	85	✓	×
SXGA+	1400 x 1050	60	✓	✓
UXGA	1600 x 1200	60	✓	✓
Wide	1280 x 720	60	✓	✓
	1280 x 720	50	×	✓
	1920 x 1080	60	×	✓
	1920 x 1080	24	×	✓
	1920 x 1080	50	×	✓

Appendices

Compatibility Modes

Modes	Resolution	V.Frequency (Hz)	Analog	Digital
Power Book G4	640 x 480	60	✓	×
	640 x 480	72	✓	×
	640 x 480	75	✓	×
	640 x 480	85	✓	×
	800 x 600	60	✓	×
	800 x 600	75	✓	×
	800 x 600	85	✓	×
	1024 x 768	60	✓	×
	1024 x 768	70	✓	×
	1024 x 768	75	✓	×
	1024 x 768	85	✓	×
	1280 x 768	60	✓	×
	1280 x 768	70	✓	×
	1280 x 720	60	✓	×
	1280 x 1024	60	✓	×
	1280 x 1024	75	✓	×
	Power G4	1400 x 1050	60	✓
1600 x 1200		60	✓	×
640 x 480		72	✓	×
640 x 480		75	✓	×
640 x 480		85	✓	×
800 x 600		60	✓	×
800 x 600		75	✓	×
800 x 600		85	✓	×
1024 x 768		60	✓	×
1024 x 768		70	✓	×
iMAC	1024 x 768	75	✓	×
	1024 x 768	85	✓	×
	1280 x 768	60	✓	×
	1280 x 1024	60	✓	×
	1280 x 1024	75	✓	×
	1600 x 1200	60	✓	×
	1024 x 768	60	✓	×

Appendices

RS232 Commands

RS232 Connector

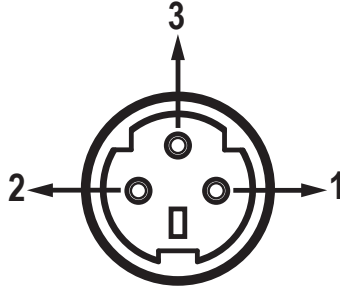

Pin no.	Name	I/O (From Projector Side)
1	TXD	OUT
2	RXD	IN
3	GND	—

VGA-In Connector

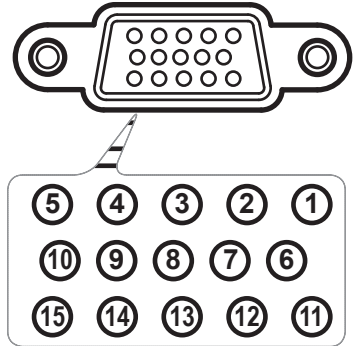

Pin no.	Spec.
1	R(RED)/Cr
2	G(GREEN)/Y
3	B(BLUE)/Cb
4	GND
5	GND
6	GND
7	GND
8	GND
9	DDC 5V
10	GND
11	GND
12	DDC Data
13	HD/CS
14	VD
15	DDC Clock

Appendices

Information from Projector Automations:								
Serial	Serial Mode		400		000			
	Warning on		401		000			
	Serial Mode		402		000			
	Out of Range		403		000			
Information from projector								
	Information		404		000			
	Power State	On/Off	405		000			
	Power State	On/Off	406		000			
	Input Source Commands	None	407		000			
		None	408		000			
		VGA1	409		000			
		VGA2	410		000			
		Video	411		000			
		RGB	412		000			
		RGB	413		000			
		RGB	414		000			
		RGB	415		000			
		RGB	416		000			
		RGB	417		000			
		RGB	418		000			
		RGB	419		000			
		RGB	420		000			
	Primary Version	0000	421		000			
	Display Mode	Projection	422		000			
		Slide	423		000			
		Slide	424		000			
		Slide	425		000			
		User1)	426		000			
		User2)	427		000			
		User3)	428		000			
		User4)	429		000			
	Model Name	000000	430		000			
	Serial	000000	431		000			
	Serial	000000	432		000			
	Serial	000000	433		000			
	Serial	000000	434		000			
	Serial	000000	435		000			
	Serial	000000	436		000			
	Serial	000000	437		000			
	Serial	000000	438		000			
	Serial	000000	439		000			
	Serial	000000	440		000			
	Serial	000000	441		000			
	Serial	000000	442		000			
	Serial	000000	443		000			
	Serial	000000	444		000			
	Serial	000000	445		000			
	Serial	000000	446		000			
	Serial	000000	447		000			
	Serial	000000	448		000			
	Serial	000000	449		000			
	Serial	000000	450		000			
	Serial	000000	451		000			
	Serial	000000	452		000			
	Serial	000000	453		000			
	Serial	000000	454		000			
	Serial	000000	455		000			
	Serial	000000	456		000			
	Serial	000000	457		000			
	Serial	000000	458		000			
	Serial	000000	459		000			
	Serial	000000	460		000			
	Serial	000000	461		000			
	Serial	000000	462		000			
	Serial	000000	463		000			
	Serial	000000	464		000			
	Serial	000000	465		000			
	Serial	000000	466		000			
	Serial	000000	467		000			
	Serial	000000	468		000			
	Serial	000000	469		000			
	Serial	000000	470		000			
	Serial	000000	471		000			
	Serial	000000	472		000			
	Serial	000000	473		000			
	Serial	000000	474		000			
	Serial	000000	475		000			
	Serial	000000	476		000			
	Serial	000000	477		000			
	Serial	000000	478		000			
	Serial	000000	479		000			
	Serial	000000	480		000			
	Serial	000000	481		000			
	Serial	000000	482		000			
	Serial	000000	483		000			
	Serial	000000	484		000			
	Serial	000000	485		000			
	Serial	000000	486		000			
	Serial	000000	487		000			
	Serial	000000	488		000			
	Serial	000000	489		000			
	Serial	000000	490		000			
	Serial	000000	491		000			
	Serial	000000	492		000			
	Serial	000000	493		000			
	Serial	000000	494		000			
	Serial	000000	495		000			
	Serial	000000	496		000			
	Serial	000000	497		000			
	Serial	000000	498		000			
	Serial	000000	499		000			
	Serial	000000	500		000			



Discount-Merchant.com (800) 281-8860
THE TRUSTED SOURCE FOR PROJECTOR LAMPS AND ACCESSORIES

Ceiling Mount Installation

1. To prevent damaging your projector, please use the Optoma's recommended mount package for installation.
2. If you wish to use a third party ceiling mount kit, please ensure the screws used to attached a mount to the projector met the following specifications:

- ▶ Screw type: M3
- ▶ Maximum screw length: 10mm
- ▶ Minimum screw length: 7.5mm



❖ Please note that damage resulting from incorrect installation will invalidate the warranty.



⚠ Warning:

1. If you buy the ceiling mount from other company, please ensure that there is at least 10cm distance between the bottom cover of the projector and the ceiling.
2. Avoid placing the projector near sources of heat such as air-conditioning units and heaters, otherwise, it may overheat and shut down automatically.

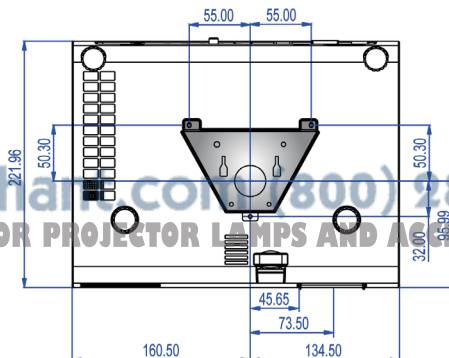
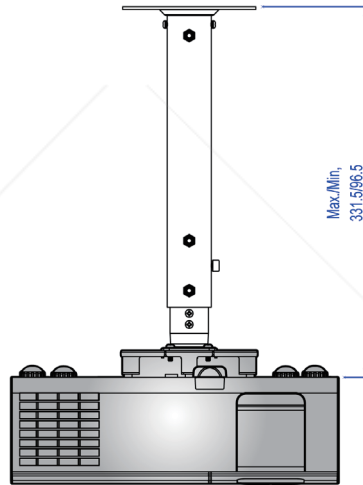

Discount-Merchandise.com (800) 231-8860
THE TRUSTED SOURCE FOR PROJECTOR LAMPS AND ACCESSORIES

Appendices

Optoma Global Offices

For service or support please contact your local office.

USA

715 Sycamore Drive
Milpitas, CA 95035, USA
www.optomausa.com

Tel : 408-383-3700
Fax : 408-383-3702
Service : services@optoma.com

Canada

5630 Kennedy Road, Mississauga,
ON, L4Z 2A9, Canada
www.optoma.ca

Tel : 905-361-2582
Fax : 905-361-2581

Europe

42 Caxton Way, The Watford Business Park
Watford, Hertfordshire,
WD18 8QZ, UK
www.optoma.eu
Service Tel : +44 (0)1923 691865

Tel : +44 (0) 1923 691 800
Fax : +44 (0) 1923 691 888
Service : service@tsc-europe.com

France

Bâtiment E
81-83 avenue Edouard Vaillant
92100 Boulogne Billancourt, France

Tel.: +33 1 41 46 12 20
Fax : +33 1 41 46 94 35
Service : savoptoma@optoma.fr

Spain

Paseo de la Castellana
135 7 Planta
Madrid, Spain

Tel.: +34 91 790 67 01
+34 91 790 67 02
Fax : + 34 91 790 68 69

Deutschland

Werftstrasse 25
D40549 Düsseldorf,
Germany

Tel : +49 (0) 211 506 6670
Fax : +49 (0) 211 506 66799
Service : info@optoma.de

Scandinavia

Grev Wedels Plass 2
3015 Drammen
Norway

Tel : +47 32 26 89 90
Fax : +47 32 83 78 98
Service : info@optoma.no

Latin America

715 Sycamore Drive
Milpitas, CA 95035, USA
www.optoma.com.br

Tel : 408-383-3700
Fax : 408-383-3702
www.optoma.com.mx



Discount www.discount-projector.com (800) 281-8860
THE TRUSTED SOURCE FOR PROJECTOR LAMPS AND ACCESSORIES

Korean

WOOMI TECH.CO.,LTD.

4F,Minu Bldg.33-14, Kangnam-Ku, Seoul,135-815, KOREA

Tel : +82+2+34430004
Fax : +82+2+34430005

Japanese

東京都足立区綾瀬3-25-18

オーエス本社ビル

サポートセンター:0120-46-5040

E-mail : info@osscreen.com

www.os-worldwide.com

Taiwan

5F., No. 108, Minchiuan Rd.

Shindian City,

Taipei Taiwan 231, R.O.C.

www.optoma.com.tw

Tel : +886-2-2218-2360

Fax : +886-2-2218-2313

Service : services@optoma.com.tw
asia.optoma.com

Hong Kong

Unit A, 27/F Dragon Centre,

79 Wing Hong Street,

Cheung Sha Wan,

Kowloon, Hong Kong

Tel : +852-2396-8968

Fax : +852-2370-1222

www.optoma.com.hk

China

5F, No. 1205, Kaixuan Rd.,

Changning District

Shanghai, 200052, China

Tel : +86-21-62947376

Fax : +86-21-62947375

www.optoma.com.cn



Discount-Merchant.com (800) 281-8860
THE TRUSTED SOURCE FOR PROJECTOR LAMPS AND ACCESSORIES

Regulation & Safety notices

This appendix lists the general notices of your projector.

FCC notice

This device has been tested and found to comply with the limits for a Class B digital device pursuant to Part 15 of the FCC rules. These limits are designed to provide reasonable protection against harmful interference in a residential installation. This device generates, uses, and can radiate radio frequency energy and, if not installed and used in accordance with the instructions, may cause harmful interference to radio communications.

However, there is no guarantee that interference will not occur in a particular installation. If this device does cause harmful interference to radio or television reception, which can be determined by turning the device off and on, the user is encouraged to try to correct the interference by one or more of the following measures:

- Reorient or relocate the receiving antenna.
- Increase the separation between the device and receiver.
- Connect the device into an outlet on a circuit different from that to which the receiver is connected.
- Consult the dealer or an experienced radio/television technician for help.

Notice: Shielded cables

All connections to other computing devices must be made using shielded cables to maintain compliance with FCC regulations.

Caution

Changes or modifications not expressly approved by the manufacturer could void the user's authority, which is granted by the Federal Communications Commission, to operate this computer.

Operation conditions

This device complies with Part 15 of the FCC Rules. Operation is subject to the following two conditions:

1. This device may not cause harmful interference, and
2. This device must accept any interference received, including interference that may cause undesired operation.

Notice: Canadian users

This Class B digital apparatus complies with Canadian ICES-003.

Remarque à l'intention des utilisateurs canadiens

Cet appareil numérique de la classe B est conforme à la norme NMB-003 du Canada.

Declaration of Conformity for EU countries

- EMC Directive 89/336/EEC (including amendments)
- Low Voltage Directive 73/23/EEC (amended by 93/68/EEC)
- R & TTE Directive 1999/EC (if product has RF function)

Disposal instructions



Do not throw this electronic device into the trash when discarding. To minimize pollution and ensure utmost protection of the global environment, please recycle it.



Disclaimer

This user manual is provided as a free service by FixYourDLP.com. FixYourDLP is in no way responsible for the content of this manual, nor do we guarantee its accuracy. FixYourDLP does not make any claim of copyright and all copyrights remain the property of their respective owners.

About FixYourDLP.com

FixYourDLP.com (<http://www.fixyourdpl.com>) is the World's #1 resource for media product news, reviews, do-it-yourself guides, and manuals.

Informational Blog: <http://www.fixyourdpl.com>

Video Guides: <http://www.fixyourdpl.com/guides>

User Forums: <http://www.fixyourdpl.com/forum>

FixYourDLP's Fight Against Counterfeit Lamps:

<http://www.fixyourdpl.com/counterfeits>

Sponsors:

RecycleYourLamp.org – Free lamp recycling services for used lamps:

<http://www.recycleyourlamp.org>

Lamp Research - The trusted 3rd party lamp research company:

<http://www.lampresearch.com>

Discount-Merchant.com – The worlds largest lamp distributor:

<http://www.discount-merchant.com>



FixYourDLP.com

Sponsored by 