



# Disclaimer

This user manual is provided as a free service by FixYourDLP.com. FixYourDLP is in no way responsible for the content of this manual, nor do we guarantee its accuracy. FixYourDLP does not make any claim of copyright and all copyrights remain the property of their respective owners.

About FixYourDLP.com

FixYourDLP.com (<http://www.fixyourdpl.com>) is the World's #1 resource for media product news, reviews, do-it-yourself guides, and manuals.

Informational Blog: <http://www.fixyourdpl.com>

Video Guides: <http://www.fixyourdpl.com/guides>

User Forums: <http://www.fixyourdpl.com/forum>

FixYourDLP's Fight Against Counterfeit Lamps:

<http://www.fixyourdpl.com/counterfeits>

## Sponsors:

RecycleYourLamp.org – Free lamp recycling services for used lamps:

<http://www.recycleyourlamp.org>

Lamp Research - The trusted 3rd party lamp research company:

<http://www.lampresearch.com>

Discount-Merchant.com – The worlds largest lamp distributor:

<http://www.discount-merchant.com>



**FixYourDLP.com**

Sponsored by 



# SHARP®

## OPERATION MANUAL MODEL XG-MB70X



Introduction

Quick Start

Setup

Connections

Basic Operation

Useful Features

Appendix

### MULTIMEDIA PROJECTOR

# Notevision

FixYourDLP.com  
Sponsored by DLP



Discount Merchant.com (800) 211-8860  
THE TRULYSOURCE FOR PROJECTOR LAMPS AND ACCESSORIES

香港電器安全規格  
(國際電工委員會規格適合)



## IMPORTANT

For your assistance in reporting the loss or theft of your Projector, please record the Serial Number located on the bottom of the projector and retain this information. Before recycling the packaging, please ensure that you have checked the contents of the carton thoroughly against the list of "Supplied accessories" on page 10.

**Model No.: XG-MB70X**

**Serial No.:**

This apparatus complies with the requirements of Council Directives 89/336/EEC and 73/23/EEC as amended by Council Directive 93/68/EEC.

Dieses Gerät entspricht den Anforderungen der EG-Richtlinien 89/336/EWG und 73/23/EWG mit Änderung 93/68/EWG.

Ce matériel répond aux exigences contenues dans les directives 89/336/CEE et 73/23/CEE modifiées par la directive 93/68/CEE.

Dit apparaat voldoet aan de eisen van de richtlijnen 89/336/EEG en 73/23/EEG, gewijzigd door 93/68/EEG.

Denne udstyr overholder kravene i direktiv nr. 89/336/EEC og 73/23/EEC med tillæg nr. 93/68/EEC.

Quest' apparecchio è conforme ai requisiti delle direttive 89/336/EEC e 73/23/EEC, come emendata dalla direttiva 93/68/EEC.

Αυτή η συσκευή συμμορφώνεται με τις απαιτήσεις των οδηγιών του Συμβουλίου 89/336/EOK και 73/23/EOK όπως τροποποιήθηκαν από την οδηγία του Συμβουλίου 93/68/EOK.

Este equipamento obedece às exigências das directivas 89/336/CEE e 73/23/CEE, na sua versão corrigida pela directiva 93/68/CEE.

Este aparato satisface las exigencias de las Directivas 89/336/CEE y 73/23/CEE, modificadas por medio de la 93/68/CEE.

Denna utrustning uppfyller kraven enligt riktlinjerna 89/336/EEC och 73/23/EEC så som kompletteras av 93/68/EEC.

Dette produktet oppfyller betingelsene i direktivene 89/336/EEC og 73/23/EEC i endringen 93/68/EEC.

Tämä laite täyttää direktiivien 89/336/EEC ja 73/23/EEC vaatimukset, joita on muutettu direktiivillä 93/68/EEC.

Bu cihaz Konsey Direktifi 93/68/EEC tarafından düzeltilen 89/336/EEC ve 73/23/EEC Konsey Direktiflerinin gerekliliklerine uygundur.

Tento přístroj je v souladu s požadavky směrnic rady 89/336/EEC a 73/23/EEC, tak jak byly upraveny směrnicí rady 93/68/EEC.

See seade on vastavuses Nõukogu Direktiivis nr 89/336/EEC ja 73/23/EEC esitatud nõuetega, vastavalt Nõukogu Direktiivis nr 93/68/EEC esitatud parandustele

Ez a készülék megfelel a Tanács által kiadott, 89/336/EGK és 73/23/EGK Irányelveknek és az utóbbi módosító 93/68/EGK Irányelvnek

Ši ierice atbilst tehniskam prasibam pec 89/336/EEC un 73/23/EEC direktivam papildinats ar direktivu 93/68/EEC.

Šis prietaisas atitinka ES Tarybos direktyvu 89/336/EEC ir 73/23/EEC patikslintos direktyvos 93/68/EEC reikalavimus.



To urządzenie spełnia wymagania dyrektyw 89/336/EEC i 73/23/EEC wraz z poprawkami dyrektywy 93/68/EEC.

Tento přístroj je v súlade s požiadavkami smerníc rady 89/336/EEC a 73/23/EEC tak ako boli upravené smernicou rady 93/68/EEC.

Ta aparat je v skladu z zahtevami Direktiv Sveta 89/336/EEC in 73/23/EEC kot je navedeno v dopolnilu k Direktivi Sveta 93/68/EEC.



**SPECIAL NOTE FOR USERS IN THE U.K.**

The mains lead of this product is fitted with a non-rewireable (moulded) plug incorporating a 5A fuse. Should the fuse need to be replaced, a BSI or ASTA approved BS 1362 fuse marked  or  and of the same rating as above, which is also indicated on the pin face of the plug, must be used.

Always refit the fuse cover after replacing the fuse. Never use the plug without the fuse cover fitted.

In the unlikely event of the socket outlet in your home not being compatible with the plug supplied, cut off the mains plug and fit an appropriate type.

**DANGER:**

The fuse from the cut-off plug should be removed and the cut-off plug destroyed immediately and disposed of in a safe manner.

Under no circumstances should the cut-off plug be inserted elsewhere into a 5A socket outlet, as a serious electric shock may occur.

To fit an appropriate plug to the mains lead, follow the instructions below:

**WARNING:**

THIS APPARATUS MUST BE EARTHED.

**IMPORTANT:**

The wires in this mains lead are coloured in accordance with the following code:

Green-and-yellow : Earth  
Blue : Neutral  
Brown : Live

As the colours of the wires in the mains lead of this apparatus may not correspond with the coloured markings identifying the terminals in your plug proceed as follows:

- The wire which is coloured green-and-yellow must be connected to the terminal in the plug which is marked by the letter E or by the safety earth symbol  or coloured green or green-and-yellow.
- The wire which is coloured blue must be connected to the terminal which is marked with the letter N or coloured black.
- The wire which is coloured brown must be connected to the terminal which is marked with the letter L or coloured red.

IF YOU HAVE ANY DOUBT, CONSULT A QUALIFIED ELECTRICIAN.



The supplied CD-ROM contains operation instructions in English, German, French, Swedish, Spanish, Italian, Dutch, Portuguese, Chinese (Traditional Chinese and Simplified Chinese), Korean and Japanese. Carefully read through the operation instructions before operating the projector.

Die mitgelieferte CD-ROM enthält Bedienungsanleitungen in Englisch, Deutsch, Französisch, Schwedisch, Spanisch, Italienisch, Niederländisch, Portugiesisch, Chinesisch (Traditionelles Chinesisch und einfaches Chinesisch) und Koreanisch. Bitte lesen Sie die Bedienungsanleitung vor der Verwendung des Projektors sorgfältig durch.

Le CD-ROM fourni contient les instructions de fonctionnement en anglais, allemand, français, suédois, espagnol, italien, néerlandais, portugais, chinois (chinois traditionnel et chinois simplifié) et coréen. Veuillez lire attentivement ces instructions avant de faire fonctionner le projecteur.

Den medföljande CD-ROM-skivan innehåller bruksanvisningar på engelska, tyska, franska, svenska, spanska, italienska, holländska, portugisiska, kinesiska (traditionell kinesiska och förenklad kinesiska) och koreanska. Läs noga igenom bruksanvisningen innan projektorn tas i bruk.

El CD-ROM suministrado contiene instrucciones de operación en inglés, alemán, francés, sueco, español, italiano, holandés, portugués, chino (chino tradicional y chino simplificado) y coreano. Lea cuidadosamente las instrucciones de operación antes de utilizar el proyector.

Il CD-ROM in dotazione contiene istruzioni per l'uso in inglese, tedesco, francese, svedese, spagnolo, italiano, olandese, portoghese, cinese (cinese tradizionale e cinese semplificato) e coreano. Leggere attentamente le istruzioni per l'uso prima di usare il proiettore.

De meegeleverde CD-ROM bevat handleidingen in het Engels, Duits, Frans, Zweeds, Spaans, Italiaans, Nederlands, Portugees, Chinees (Traditioneel Chinees en Vereenvoudigd Chinees) en Koreaans. Lees de handleiding zorgvuldig door voor u de projector in gebruik neemt.

O CD-ROM fornecido contém instruções de operação em Inglês, Alemão, Francês, Sueco, Espanhol, Italiano, Holandês, Português, Chinês, (Chinês Tradicional e Chinês Simplificado) e Coreano. Leia cuidadosamente todas as instruções de operação antes de operar o projetor.

附送之CD-ROM光碟中，有用英文、德文、法文、瑞典文、西班牙文、意大利文、荷蘭文、葡萄牙文、中文（繁體中文和簡體中文）和韓國文所寫的使用說明書。在操作本投影機之前，請務必仔細閱讀整本使用說明書。

附送之CD-ROM光碟中，有用英文、德文、法文、瑞典文、西班牙文、意大利文、荷兰文、葡萄牙文、中文（繁体中文和简体中文）和韩国文所写的使用说明书。在操作本投影机之前，请务必仔细阅读整本使用说明书。

제공된 CD-ROM에는 영어, 독일어, 프랑스어, 스웨덴어, 스페인어, 이탈리아어, 네덜란드어, 포르투갈어, 중국어(번체자와 간체자), 그리고 한국어로 작성된 조작 설명서가 포함되어 있습니다. 프로젝터를 조작하기 전에 조작 지침을 상세하게 숙지하십시오.



**Discount-Merchant.com (800) 281-8860**  
**THE TRUSTED SOURCE FOR PROJECTOR LAMPS AND ACCESSORIES**



Before using the projector, please read this operation manual carefully.

# Introduction

ENGLISH

There are two important reasons for prompt warranty registration of your new SHARP Projector, using the REGISTRATION CARD packed with the projector.

### 1. WARRANTY

This is to assure that you immediately receive the full benefit of the parts, service and labor warranty applicable to your purchase.

### 2. CONSUMER PRODUCT SAFETY ACT

To ensure that you will promptly receive any safety notification of inspection, modification, or recall that SHARP may be required to give under the 1972 Consumer Product Safety Act, PLEASE READ CAREFULLY THE IMPORTANT "LIMITED WARRANTY" CLAUSE. U.S.A. ONLY

**WARNING:** High brightness light source. Do not stare into the beam of light, or view directly. Be especially careful that children do not stare directly into the beam of light.

**WARNING:** To reduce the risk of fire or electric shock, do not expose this product to rain or moisture.

See bottom of projector.

|  |  |  |
|--|--|--|
|  | <b>CAUTION</b><br>RISK OF ELECTRIC SHOCK.<br>DO NOT REMOVE SCREWS<br>EXCEPT SPECIFIED USER<br>SERVICE SCREW. |  |
| <b>CAUTION: TO REDUCE THE RISK OF ELECTRIC SHOCK,<br/>DO NOT REMOVE COVER.<br/>NO USER-SERVICEABLE PARTS EXCEPT LAMP UNIT.<br/>REFER SERVICING TO QUALIFIED SERVICE<br/>PERSONNEL.</b> |  |  |



The lightning flash with arrowhead symbol, within an equilateral triangle, is intended to alert the user to the presence of uninsulated "dangerous voltage" within the product's enclosure that may be of sufficient magnitude to constitute a risk or electric shock to persons.



The exclamation point within a triangle is intended to alert the user to the presence of important operating and maintenance (servicing) instructions in the literature accompanying the product.

**WARNING:** FCC Regulations state that any unauthorized changes or modifications to this equipment not expressly approved by the manufacturer could void the user's authority to operate this equipment. U.S.A. ONLY

### INFORMATION

This equipment has been tested and found to comply with the limits for a Class A digital device, pursuant to Part 15 of the FCC Rules. These limits are designed to provide reasonable protection against harmful interference when the equipment is operated in a commercial environment. This equipment generates, uses, and can radiate radio frequency energy and, if not installed and used in accordance with the operation manual, may cause harmful interference to radio communications. Operation of this equipment in a residential area is likely to cause harmful interference, in which case the user will be required to correct the interference at his own expense. U.S.A. ONLY

The enclosed computer cable must be used with the device. The cable is provided to ensure that the device complies with FCC Class A verification. U.S.A. ONLY

**WARNING:** This is a Class A product. In a domestic environment this product may cause radio interference in which case the user may be required to take adequate measures.

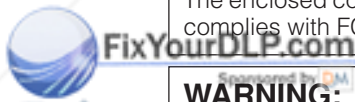

Disc... Member... (800) 281-8860

**THE TRUSTED SOURCE FOR PROJECTOR LAMPS AND ACCESSORIES**



### WARNING:

The cooling fan in this projector continues to run for about 90 seconds after the projector enters the standby mode. During normal operation, when putting the projector into standby mode always use the STANDBY button on the projector or on the remote control. Ensure the cooling fan has stopped before disconnecting the power cord. DURING NORMAL OPERATION, NEVER TURN THE PROJECTOR OFF BY DISCONNECTING THE POWER CORD. FAILURE TO OBSERVE THIS WILL RESULT IN PREMATURE LAMP FAILURE.

### PRODUCT DISPOSAL

This projector utilizes tin-lead solder, and a pressurized lamp containing a small amount of mercury. Disposal of these materials may be regulated due to environmental considerations. For disposal or recycling information, please contact your local authorities or, if you are located in the United States of America, the Electronic Industries Alliance: [www.eiae.org](http://www.eiae.org).

### Caution Concerning Lamp Replacement

See "Replacing the Lamp" on page 66.

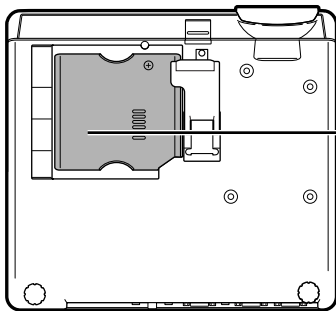

#### ⚠ LAMP REPLACEMENT WARNING :

TURN OFF THE LAMP AND DISCONNECT POWER CORD BEFORE OPENING THIS COVER. HOT SURFACE INSIDE. ALLOW 1 HOUR TO COOL BEFORE REPLACING THE LAMP. REPLACE WITH SAME SHARP LAMP UNIT MODEL AN-MB70LP ONLY.

HIGH PRESSURE LAMP : RISK OF EXPLOSION. POTENTIAL HAZARD OF GLASS PARTICLES IF LAMP HAS RUPTURED. HANDLE WITH CARE. SEE OPERATION MANUAL.

SERVICEMAN-WARNING : USE RADIATION EYE AND SKIN PROTECTION DURING SERVICING.

#### ⚠ AVERTISSEMENT CONCERNANT LE REMPLACEMENT DE LA LAMPE :

ETEINDRE LA LAMPE ET DEBRANCHER LE CORDON D'ALIMENTATION AVANT D'OUVRIR LE COUVERCLE. L'INTERIEUR DU BOITIER ETANT EXTREMEMENT CHAUD, ATTENDRE 1 HEURE AVANT DE PROCEDER AU REMPLACEMENT DE LA LAMPE. NE REMPLACER QUE PAR UNE LAMPE SHARP DE MODELE AN-MB70LP.

LAMPE A HAUTE PRESSION : RISQUE D'EXPLOSION. DANGER POTENTIEL DE PARTICULES DE VERRE EN CAS D'ECLATEMENT DE LA LAMPE. A MANIPULER AVEC PRECAUTION. SE REPORTER AU MODE D'EMPLOI.

AVERTISSEMENT - REPARATEUR : SE PROTEGER LES YEUX ET LA PEAU DES RADIATIONS LORS DES REPARATIONS.

This SHARP projector uses a DMD panel. This very sophisticated panel contains 786,432 pixels micromirrors. As with any high technology electronic equipment such as large screen TVs, video systems and video cameras, there are certain acceptable tolerances that the equipment must conform to. This unit has some inactive pixels within acceptable tolerances which may result in inactive dots on the picture screen. This will not affect the picture quality or the life expectancy of the unit.

- DLP™ (Digital Light Processing) and DMD™ (Digital Micromirror Device) are trademarks of Texas Instruments, Inc.
- Microsoft® and Windows® are registered trademarks of Microsoft Corporation in the United States and/or other countries.
- PC/AT is a registered trademark of International Business Machines Corporation in the United States.
- Adobe® Reader® is a trademark of Adobe Systems Incorporated.
- Macintosh® is a registered trademark of Apple Computer, Inc. in the United States and/or other countries.
- All other company or product names are trademarks or registered trademarks of their respective companies.

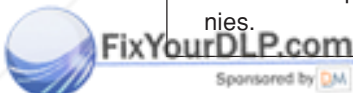

**Discount-Merchant.com (800) 281-8860**  
**THE TRUSTED SOURCE FOR PROJECTOR LAMPS AND ACCESSORIES**



# How to Read this Operation Manual

- In this operation manual, the illustrations and on-screen displays are simplified for explanation. This may differ from the actual on-screen display.

### Using the Menu Screen

The menu can be operated to achieve two functions, adjustments and settings. (For setting the menu items, see pages 42 and 43.)

Buttons used in this operation

Buttons used in this operation

---

### Menu Selections (Adjustments)

**Example: Adjusting "Bright"**  
 • This operation can also be performed by using the buttons on the projector.

**1 Press .**  
 • The "Picture" menu screen for the selected input mode is displayed.

**2 Press or to display the other menu screens.**  
 • The menu icon for the selected menu screen is highlighted.

| Menu icon | Menu screen |
|-----------|-------------|
|           | Picture     |
|           | Fine Sync   |
|           | Options1    |
|           | Options2    |
|           | Language    |

**Note**  
 • The "Fine Sync" menu is not available for selecting INPUT 3 or INPUT 4.

**Example: "Picture" screen menu for INPUT 1 (RGB) mode**

On-screen display

**Info** .....Indicates safeguards when using the projector.

**Note** .....Indicates additional information for setting up and operating the projector.

## For Future Reference

Maintenance

Troubleshooting

Index

➔ Page 63

➔ Pages 70 and 71

➔ Page 75

Discount Merchants.com (800) 251-8860  
 THE TRUSTED SOURCE FOR PROJECTOR LAMPS AND ACCESSORIES





# Contents

## Preparing

### Introduction

|   |    |
|---|----|
| How to Read this Operation Manual .....     | 3  |
| Contents .....                              | 4  |
| IMPORTANT SAFEGUARDS .....                  | 6  |
| How to Access the PDF Operation Manuals ... | 9  |
| Accessories .....                           | 10 |
| Part Names and Functions .....              | 11 |
| Using the Remote Control .....              | 15 |
| Usable Range .....                          | 15 |
| Inserting the Batteries .....               | 15 |

### Quick Start

|                   |    |
|-------------------|----|
| Quick Start ..... | 16 |
|-------------------|----|

### Setup

|                                   |    |
|-----------------------------------|----|
| Storing the Projector .....       | 18 |
| How to Use the Storage Case ..... | 18 |

|                                   |    |
|-----------------------------------|----|
| Setting up the Projector .....    | 19 |
| Setting up the Projector .....    | 19 |
| Projecting a Reversed Image ..... | 20 |

### Connections

|   |    |
|---|----|
| Connections .....                           | 21 |
| INPUT/OUTPUT Terminals and Connectable      |    |
| Main Equipment .....                        | 21 |
| Samples of Cables for Connection .....      | 22 |
| Connecting to a Computer .....              | 23 |
| Using the Remote Control as the Wireless    |    |
| Computer Mouse .....                        | 24 |
| Connecting to Video Equipment .....         | 25 |
| Controlling the Projector by a Computer ... | 27 |
| Connecting to a Monitor with RGB            |    |
| Input Terminal .....                        | 28 |
| Connecting to an Amplifier or Other         |    |
| Audio Equipment .....                       | 28 |

## Using

### Basic Operation

|  |    |
|--|----|
| Turning the Projector On/Off .....               | 29 |
| Image Projection .....                           | 30 |
| Using the Adjustment Feet .....                  | 30 |
| Correcting Trapezoidal Distortion .....          | 31 |
| Adjusting the Focus .....                        | 32 |
| Adjusting the Projected Image Size .....         | 32 |
| Switching the INPUT Mode .....                   | 33 |
| Adjusting the Volume .....                       | 33 |
| Displaying the Black Screen and Turning          |    |
| off the Sound Temporarily .....                  | 34 |
| Displaying an Enlarged Portion of an Image ..... | 34 |
| Freezing a Moving Image .....                    | 35 |
| Selecting the Picture Mode .....                 | 35 |
| Using the High Brightness/High Contrast          |    |
| Mode .....                                       | 35 |
| Resize Mode .....                                | 36 |

### Useful Features

|   |    |
|---|----|
| Menu Items .....                                  | 38 |
| Using the Menu Screen .....                       | 40 |
| Menu Selections (Adjustments) .....               | 40 |
| Menu Selections (Settings) .....                  | 42 |
| Picture Adjustment (“Picture” menu) .....         | 44 |
| Selecting the Picture mode .....                  | 44 |
| Adjusting the Image .....                         | 44 |
| Emphasizing the Contrast .....                    | 45 |
| Adjusting the Color Temperature .....             | 45 |
| sRGB Setting .....                                | 46 |
| Switching the High Brightness/High Contrast ..... | 46 |
| Signal Type Setting .....                         | 47 |

### Computer Image Adjustment

|                                    |    |
|------------------------------------|----|
| (“Fine Sync” menu) .....           | 48 |
| Adjusting the Computer Image ..... | 48 |
| Special Modes Setting .....        | 48 |
| Auto Sync Adjustment .....         | 49 |
| Checking the Input Signal .....    | 49 |

### Using the “Options1” Menu

|  |    |
|--|----|
| Checking the Lamp Life Status .....            | 50 |
| Setting the Resize Mode .....                  | 50 |
| Setting On-screen Display .....                | 51 |
| Setting the Video System .....                 | 51 |
| Selecting a Startup and Background Image ..... | 52 |
| Eco Mode .....                                 | 52 |
| Auto Power Off Function .....                  | 53 |
| Selecting the Menu Screen Position .....       | 53 |
| System Lock Function .....                     | 54 |
| Keylock Function .....                         | 55 |

### Helpful Functions Set during Installation

|  |    |
|--|----|
| (“Options2” menu) .....                          | 56 |
| Setting a Password .....                         | 56 |
| If You Forget Your Password .....                | 56 |
| Auto Focus Setting .....                         | 57 |
| Auto Keystone Setting .....                      | 57 |
| Speaker Setting .....                            | 58 |
| Setting the Audio Output Type .....              | 58 |
| Reverting/Inverting Projected Images .....       | 59 |
| Selecting the Transmission Speed (RS-232C) ..... | 59 |
| Monitor Output Settings .....                    | 60 |
| LAN/RS232C Setting .....                         | 60 |
| Confirming the Network Information for the       |    |
| Projector .....                                  | 61 |
| Returning to the Default Settings .....          | 61 |
| Using the “Language” Menu .....                  | 62 |
| Selecting the On-screen Display Language .....   | 62 |

FixYourDLP.com  
Sponsor for  
Discount Electronics (UK) Ltd  
THE TRUSTED SOURCE FOR PROJECTOR LAMPS AND ACCESSORIES  
291-8860



## Reference

### Appendix

|   |           |
|---|-----------|
| <b>Maintenance</b> .....                    | <b>63</b> |
| <b>Maintenance Indicators</b> .....         | <b>64</b> |
| <b>Regarding the Lamp</b> .....             | <b>66</b> |
| Lamp .....                                  | 66        |
| Caution Concerning the Lamp .....           | 66        |
| Replacing the Lamp .....                    | 66        |
| Removing and Installing the Lamp Unit ..... | 67        |
| Resetting the Lamp Timer .....              | 68        |

|   |           |
|---|-----------|
| <b>Computer Compatibility Chart</b> ..... | <b>69</b> |
| <b>Troubleshooting</b> .....              | <b>70</b> |
| <b>For SHARP Assistance</b> .....         | <b>72</b> |
| <b>Specifications</b> .....               | <b>73</b> |
| <b>Glossary</b> .....                     | <b>74</b> |
| <b>Index</b> .....                        | <b>75</b> |



**Discount-Merchant.com (800) 281-8860**  
**THE TRUSTED SOURCE FOR PROJECTOR LAMPS AND ACCESSORIES**



# IMPORTANT SAFEGUARDS

**CAUTION:** Please read all of these instructions before you operate this product and save these instructions for later use.

Electrical energy can perform many useful functions. This product has been engineered and manufactured to assure your personal safety. BUT IMPROPER USE CAN RESULT IN POTENTIAL ELECTRICAL SHOCK OR FIRE HAZARDS. In order not to defeat the safeguards incorporated in this product, observe the following basic rules for its installation, use and servicing.

## 1. Read Instructions

All the safety and operating instructions should be read before the product is operated.

## 2. Retain Instructions

The safety and operating instructions should be retained for future reference.

## 3. Heed Warnings

All warnings on the product and in the operating instructions should be adhered to.

## 4. Follow Instructions

All operating and use instructions should be followed.

## 5. Cleaning

Unplug this product from the wall outlet before cleaning. Do not use liquid cleaners or aerosol cleaners. Use a damp cloth for cleaning.

## 6. Attachments

Do not use attachments not recommended by the product manufacturer as they may cause hazards.

## 7. Water and Moisture

Do not use this product near water—for example, near a bath tub, wash bowl, kitchen sink, or laundry tub; in a wet basement; or near a swimming pool; and the like.

## 8. Accessories

Do not place this product on an unstable cart, stand, tripod, bracket, or table. The product may fall, causing serious injury to a child or adult, and serious damage to the product. Use only with a cart, stand, tripod, bracket, or table recommended by the manufacturer, or sold with the product. Any mounting of the product should follow the manufacturer's instructions, and should use a mounting accessory recommended by the manufacturer.

## 9. Transportation

A product and cart combination should be moved with care. Quick stops, excessive force, and uneven surfaces may cause the product and cart combination to overturn.



## 10. Ventilation

Slots and openings in the cabinet are provided for ventilation to ensure reliable operation of the product and to protect it from overheating, and these openings must not be blocked or covered. The openings should never be blocked by placing the product on a bed, sofa, rug, or other similar surface. This product should not be placed in a built-in installation such as a bookcase or rack unless proper ventilation is provided or the manufacturer's instructions have been adhered to.

## 11. Power Sources

This product should be operated only from the type of power source indicated on the marking label. If you are not sure of the type of power supply to your home, consult your product dealer or local power company. For products intended to operate from battery power, or other sources, refer to the operating instructions.

## 12. Grounding or Polarization

This product is provided with one of the following types of plugs. If the plug should fail to fit into the power outlet, please contact your electrician.

- a. Two-wire type (mains) plug.
- b. Three-wire grounding type (mains) plug with a grounding terminal.  
This plug will only fit into a grounding type power outlet.

## 13. Power-Cord Protection

Power-supply cords should be routed so that they are not likely to be walked on or pinched by items placed upon or against them, paying particular attention to cords at plugs, convenience receptacles, and the point where they exit from the product.

## 14. Lightning

For added protection for this product during a lightning storm, or when it is left unattended and unused for long periods of time, unplug it from the wall outlet and disconnect the cable system. This will prevent damage to the product due to lightning and power-line surges.

## 15. Overloading

Do not overload wall outlets, extension cords, or integral convenience receptacles as this can result in a risk of fire or electric shock.

## 16. Object and Liquid Entry

Never push objects of any kind into this product through openings as they may touch dangerous voltage points or short-out parts that could result in a fire or electric shock. Never spill liquid of any kind on the product.

## 17. Servicing

Do not attempt to service this product yourself as opening or removing covers may expose you to dangerous voltage or other hazards. Refer all servicing to qualified service personnel.

## 18. Damage Requiring Service

Unplug this product from the wall outlet and refer servicing to qualified service personnel under the following conditions:

- a. When the power-supply cord or plug is damaged.
- b. If liquid has been spilled, or objects have fallen into the product.
- c. If the product has been exposed to rain or water.
- d. If the product does not operate normally by following the operating instructions. Adjust only those controls that are covered by the operating instructions, as an improper adjustment of other controls may result in damage and will often require extensive work by a qualified technician to restore the product to normal operation.
- e. If the product has been dropped or damaged in any way.
- f. When the product exhibits a distinct change in performance, this indicates a need for service.

## 19. Replacement Parts

When replacement parts are required, ensure that the service technician has used replacement parts specified by the manufacturer or have the same characteristics as the original part. Unauthorized substitutions may result in fire, electric shock, or other hazards.

## 20. Safety Check

Upon completion of any service or repairs to this product, ask the service technician to perform safety checks to determine that the product is in proper operating condition.

## 21. Wall or Ceiling Mounting

This product should be mounted to a wall or ceiling only as recommended by the manufacturer.

## 22. Heat

This product should be situated away from heat sources such as radiators, heat registers, stoves, or other products (including amplifiers) that produce heat.

FixYourEFP.com  
Discover the world's largest marketplace for projectors, lamps and accessories  
281-8860



## Ensure that you read the following safeguards when setting up your projector.

### Caution concerning the lamp unit

- Potential hazard of glass particles if lamp ruptures. In case of lamp rupture, contact your nearest Sharp Authorized Projector Dealer or Service Center for a replacement. See "Replacing the Lamp" on page 66.

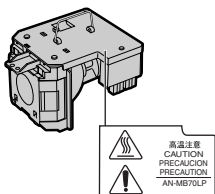

### Caution concerning the setup of the projector

- For minimal servicing and to maintain high image quality, SHARP recommends that this projector be installed in an area free from humidity, dust and cigarette smoke. When the projector is subjected to these environments, the vents and lens must be cleaned more often. As long as the projector is regularly cleaned, use in these environments will not reduce the overall operation life of the unit. Internal cleaning should only be performed by a Sharp Authorized Projector Dealer or Service Center.

### Do not set up the projector in places exposed to direct sunlight or bright light.

- Position the screen so that it is not in direct sunlight or room light. Light falling directly on the screen washes out the colors, making viewing difficult. Close the curtains and dim the lights when setting up the screen in a sunny or bright room.

### The projector may be safely tilted to a maximum angle of 12 degrees.

- Placement should be within  $\pm 12$  degrees of horizontal.



### Do not use the projector upside down.

- This can cause personal injury due to rise in internal temperature.

### Warning about placing the projector in a high position

- When placing the projector in a high position, ensure to secure it carefully to avoid personal injury caused by the projector falling down.

### Do not subject the projector to hard impact and/or vibration.

- Take care with the lens so as not to hit or damage the surface of the lens.

### Rest your eyes occasionally.

- Continuously watching the screen for long hours will cause eye strain. Ensure to occasionally rest your eyes.

### Avoid locations with extremes of temperature.

- The operating temperature of the projector is from 41°F to 104°F (+5°C to +40°C).
- The storage temperature of the projector is from -4°F to 140°F (-20°C to +60°C).

### Do not block the exhaust and intake vents.

- Allow at least  $7 \frac{7}{8}$  inches (20 cm) of space between the exhaust vent and the nearest wall or obstruction.
- Ensure that the intake vent and the exhaust vent are not obstructed.
- If the cooling fan becomes obstructed, a protection circuit will automatically put the projector into standby mode to prevent overheat damage. This does not indicate a malfunction (See pages 64 and 65.). Remove the projector power cord from the wall outlet and wait at least 10 minutes. Place the projector where the intake and exhaust vents are not blocked, plug the power cord back in and turn on the projector. This will return the projector to the normal operating condition.

Discount Merchant.com (800) 281-8860 THE TRUSTED SOURCE FOR PROJECTOR LAMPS AND ACCESSORIES



## IMPORTANT SAFEGUARDS

### Caution regarding usage of the projector

- When using the projector, ensure not to subject it to hard impact and/or vibration, as this can result in damage. Take extra care with the lens. If you are not to use the projector for a long time, be sure to unplug the power cord from the wall outlet, and disconnect any other cables connected to it.
- Do not use the projector by holding the lens.
- When storing the projector, ensure to attach the lens cap to the projector. (See page 11.)
- Do not expose the storage case or projector to direct sunlight or near heat sources. The storage case or projector may change color or become deformed.



### Info

- The cooling fan regulates the internal temperature, and its performance is automatically controlled. The sound of the fan may change during projector operation due to changes in the fan speed. This does not indicate malfunction.
- Do not unplug the power cord during projection or cooling fan operation. This can cause damage due to rise in internal temperature, as the cooling fan also stops.

### Other connected equipment

- When connecting a computer or other audio-visual equipment to the projector, make the connections AFTER unplugging the power cord of the projector from the AC outlet and turning off the equipment to be connected.
- Please read the operation manuals of the projector and the equipment to be connected for instructions on how to make the connections.

### Using the projector in other countries

- The power supply voltage and the shape of the plug may vary depending on the region or country you are using the projector in. When using the projector overseas, ensure to use an appropriate power cord for the country you are in.

### Temperature monitor function

- If the projector starts to over-heat due to setup problems or blockage of the air vents, "X" and "TEMP." will illuminate in the lower left corner of the picture. If the temperature continues to rise, the lamp will turn off, the temperature warning indicator on the projector will blink, and after a 90-second cooling-off period the projector will enter the standby mode. Refer to "Maintenance Indicators" on page 64 for details.





# How to Access the PDF Operation Manuals

PDF operation manuals in several languages are included in the CD-ROM, so that you can work with the projector. To utilize these manuals, you need to install Adobe® Reader® on your computer (Windows® or Macintosh®).

Please download Adobe® Reader® from the Internet (<http://www.adobe.com>).

## Accessing the PDF Manuals

### For Windows®:

- ① Insert the CD-ROM in the CD-ROM drive.
- ② Double click the "My Computer" icon.
- ③ Double click the "CD-ROM" drive.
- ④ **When you want to view the operation manual**
  - 1) Double click the "MANUALS" folder.
  - 2) Double click the language (name of the folder) that you want to view.
  - 3) Double click the "MB70" pdf file to access the projector manuals.

### **When you want to view the setup guide**

- 1) Double click the "SETUP" folder.
- 2) Double click the language (name of the folder) that you want to view.
- 3) Double click the "SE\_MB7" pdf file to access the setup guide.

### For Macintosh®:

- ① Insert the CD-ROM in the CD-ROM drive.
- ② Double click the "CD-ROM" icon.
- ③ **When you want to view the operation manual**
  - 1) Double click the "MANUALS" folder.
  - 2) Double click the language (name of the folder) that you want to view.
  - 3) Double click the "MB70" pdf file to access the projector manuals.

### **When you want to view the setup guide**

- 1) Double click the "SETUP" folder.
- 2) Double click the language (name of the folder) that you want to view.
- 3) Double click the "SE\_MB7" pdf file to access the setup guide.



### Info

- If the desired pdf file cannot be opened by double clicking the mouse, start Adobe® Reader® first, then specify the desired file using the "File", "Open" menu.

## SETUP GUIDE

Refer to the "SETUP GUIDE" contained on the supplied CD-ROM for details.

|   |    |                                 |    |
|---|----|---------------------------------|----|
| Screen Size and Projection Distance ..... | 2  | Setting the Projector Using     |    |
| Connecting Pin Assignments .....          | 3  | RS-232C or Telnet .....         | 17 |
| RS-232C Specifications and Commands ..... | 4  | Controlling the Projector Using |    |
| Setting up the Projector Network          |    | RS-232C or Telnet .....         | 20 |
| Environment .....                         | 6  | Troubleshooting .....           | 27 |
| Controlling the Projector via LAN .....   | 12 | Dimensions .....                | 30 |



**Discount-Merchant.com (800) 281-8860**  
THE TRUSTED SOURCE FOR PROJECTOR LAMPS AND ACCESSORIES

# Accessories

## Supplied accessories



Remote control  
RRMCGA313WJSA



Two R-03 batteries  
("AAA" size, UM/SUM-4, HP-16 or similar)

### Power cord\*

(1)

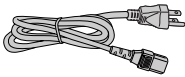

For U.S., Canada, etc.  
(6' (1.8 m))  
QACCD A010WJPZ

(2)

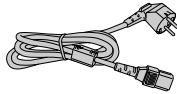

For Europe, except U.K.  
(6' (1.8 m))  
QACCV A011WJPZ

(3)

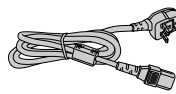

For U.K., Hong Kong  
and Singapore  
(6' (1.8 m))  
QACCB A036WJPZ

(4)

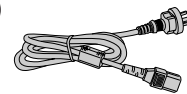

For Australia, New  
Zealand and Oceania  
(6' (1.8 m))  
QACCL A018WJPZ

\* Use the power cord that corresponds to the wall outlet in your country.

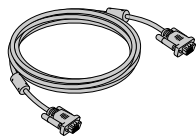

RGB cable  
(9'10" (3.0 m))  
QCNWGA045WJPZ

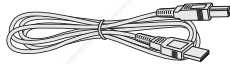

USB cable  
(9'10" (3.0 m))  
QCNWGA014WJPZ



Storage case  
GCASNA014WJSA

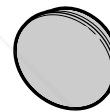

Lens cap (attached)  
RCAPHA021WJSA

Projector manual and  
technical reference  
CD-ROM  
UDSKAA052WJZZ

"QUICK GUIDE" label  
TLABZA717WJZZ

Operation manual  
(this manual)  
TINS-B416WJZZ

## Optional accessories

- 3 RCA to 15-pin D-sub cable (9'10" (3.0 m)) AN-C3CP
- DIN-D-sub RS-232C adaptor (5 57/64" (15 cm)) AN-A1RS
- Lamp unit AN-MB70LP

FixYourDLP.com  
Sponsored by

Discount-Merchant.com (800) 281-8860

THE TRUTH ABOUT PROJECTOR LAMPS AND ACCESSORIES



# Part Names and Functions

Numbers in **[ ]** refer to the main pages in this operation manual where the topic is explained.

## Projector

### Top View

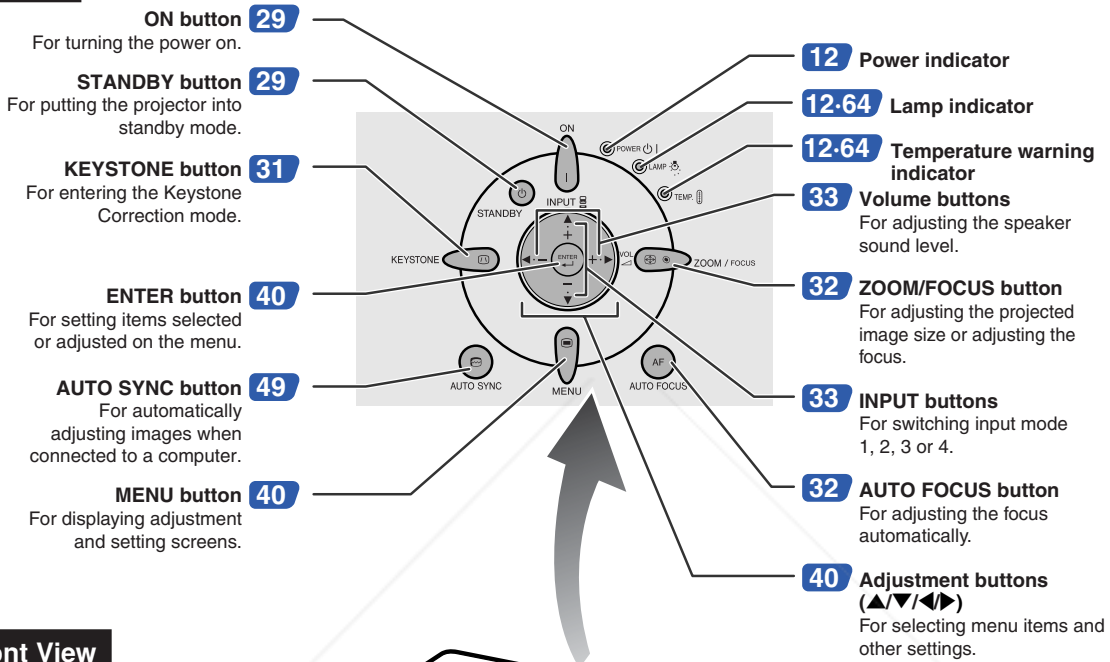

### Front View

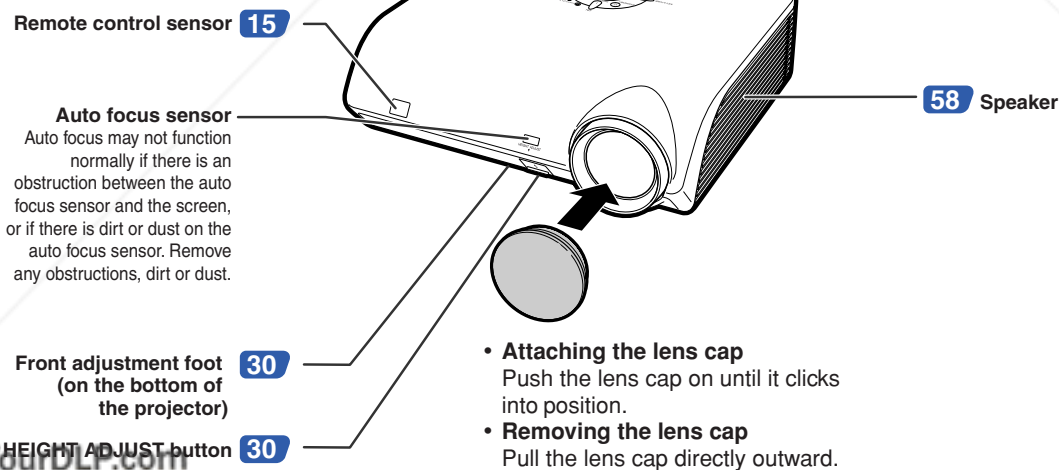

# Discount-Merchant.com (800) 281-8860

THE TRUSTED SOURCE FOR PROJECTOR LAMPS AND ACCESSORIES



## Part Names and Functions

### About the Indicators on the Projector

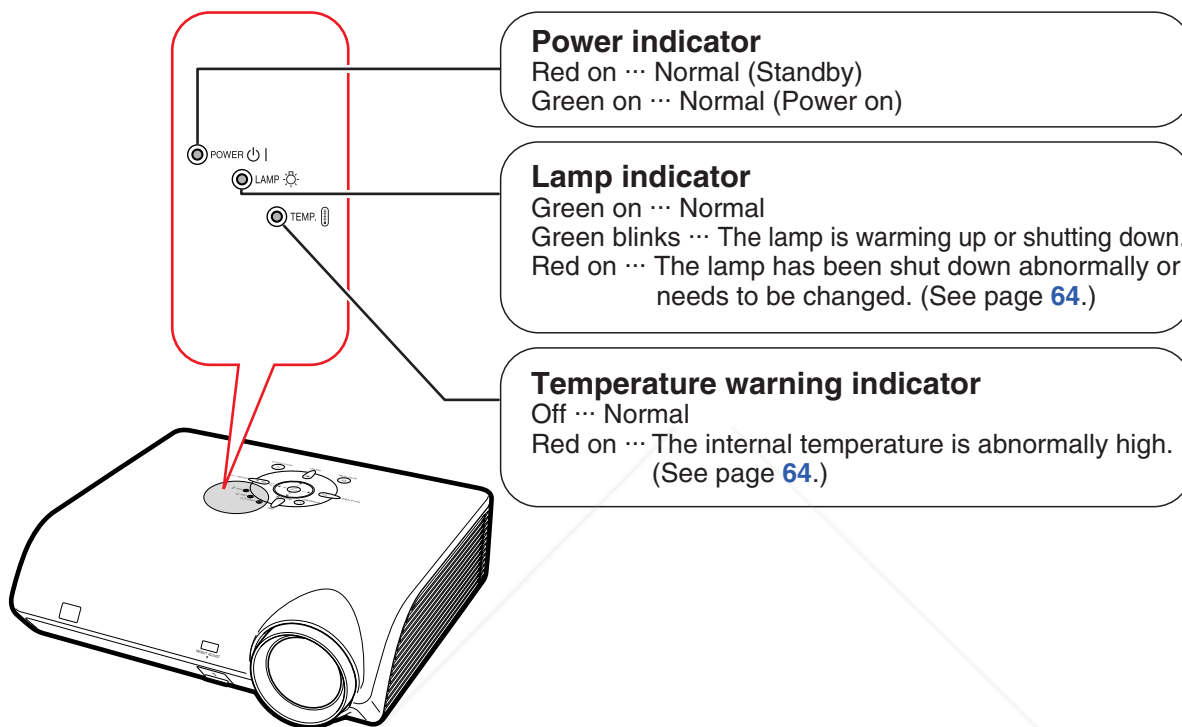

#### When Attaching the “QUICK GUIDE” Label

Attaching the “QUICK GUIDE” Label (supplied) on the projector will help you check the setup procedure. Ensure to attach the “QUICK GUIDE” Label on the top cabinet of the projector as shown in the drawing on the right. Do not attach the “QUICK GUIDE” label anywhere else to avoid blocking an air intake or exhaust vent.

“QUICK GUIDE”  
Label

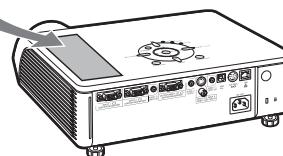



Numbers in **28** refer to the main pages in this operation manual where the topic is explained.

## Projector (Rear View)

**Terminals** Refer to "INPUT/OUTPUT Terminals and Connectable Main Equipment" on page 21.

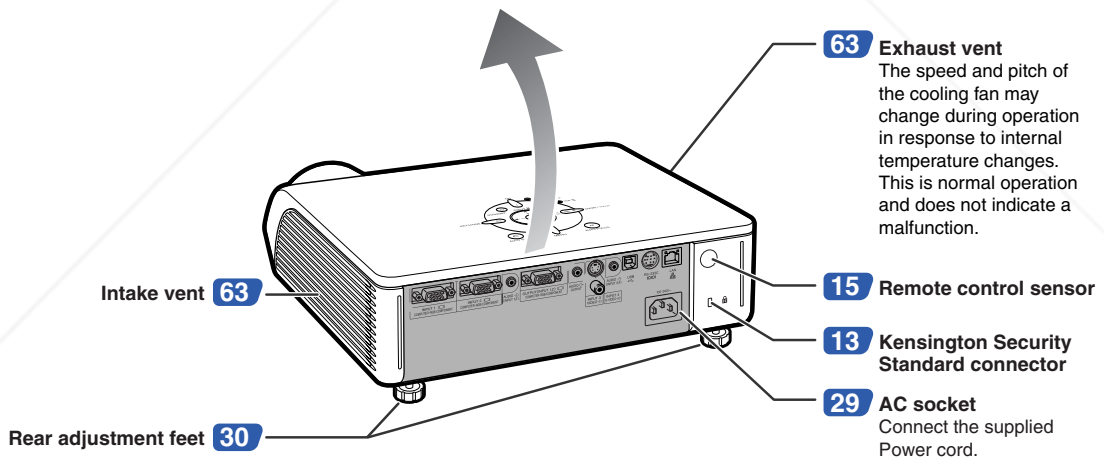
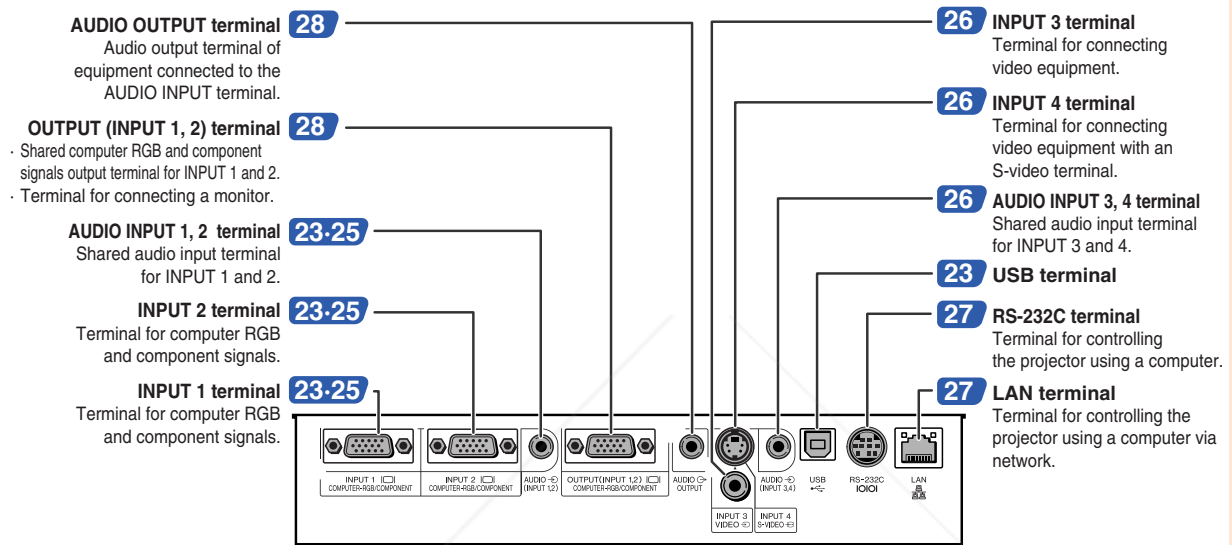

### Using the Kensington Lock

- This projector has a Kensington Security Standard connector for use with a Kensington MicroSaver Security System. Refer to the information that came with the system for instructions on how to use it to secure the projector.

## Part Names and Functions

Numbers in **[ ]** refer to the main pages in this operation manual where the topic is explained.

### Remote Control

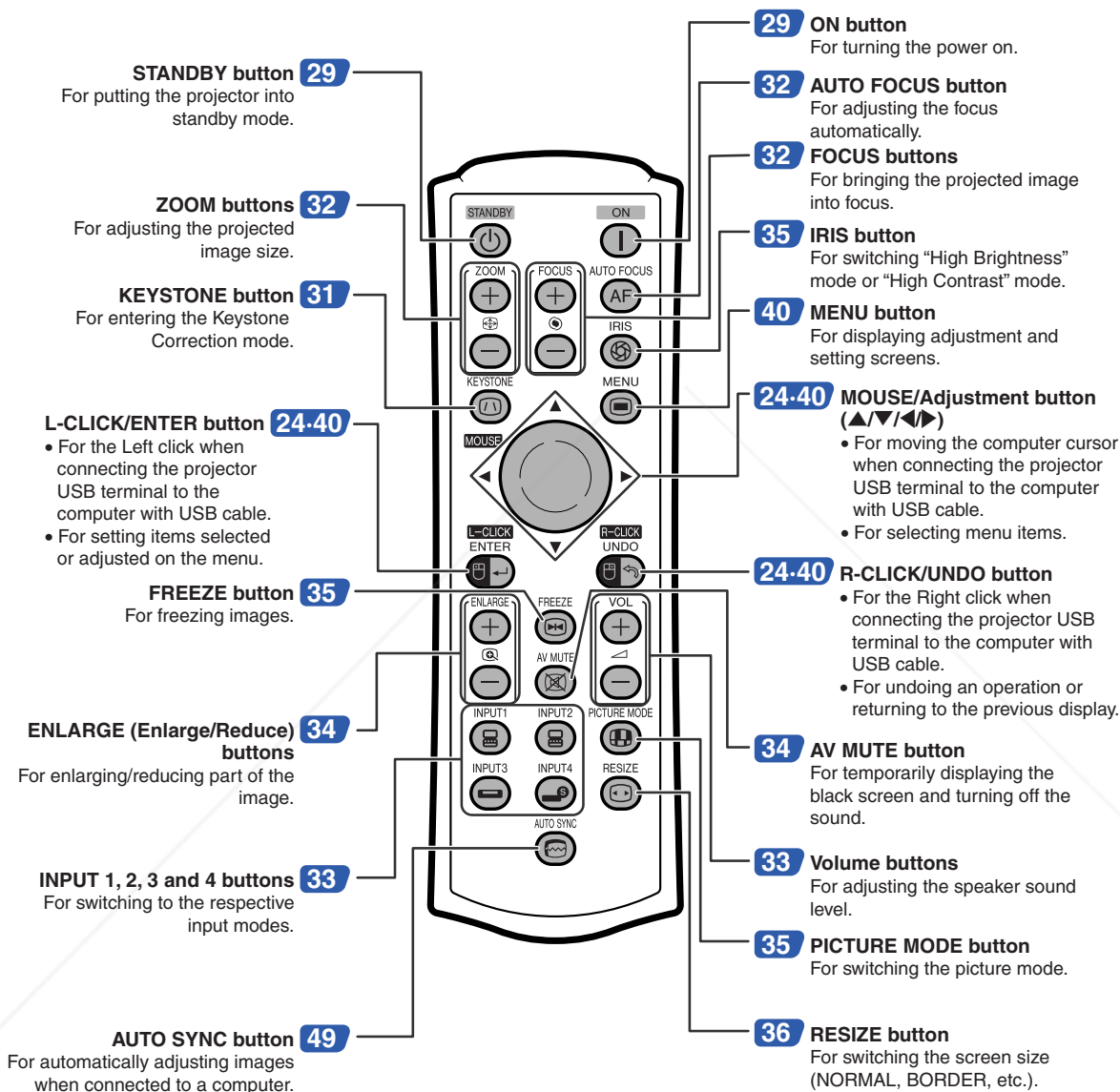

# Using the Remote Control

## Usable Range

The remote control can be used to control the projector within the ranges shown in the illustration.

### Note

- The signal from the remote control can be reflected off a screen for easy operation. However, the effective distance of the signal may differ depending on the screen material.

### When using the remote control:

- Ensure not to drop, expose to moisture or high temperature.
- The remote control may malfunction under a fluorescent lamp. In this case, move the projector away from the fluorescent lamp.

## Inserting the Batteries

The batteries (two R-03 batteries ("AAA" size, UM/SUM-4, HP-16 or similar)) are supplied in the package.

**1** Press the ▲ mark on the cover and slide it in the direction of the arrow.

**2** Insert the batteries.

- Insert the batteries making sure the polarities correctly match the ⊕ and ⊖ marks inside the battery compartment.

**3** Attach the cover and slide it until it clicks into place.

### Front View

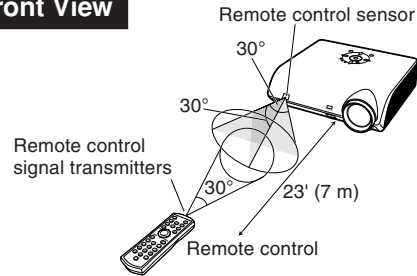

### Rear View

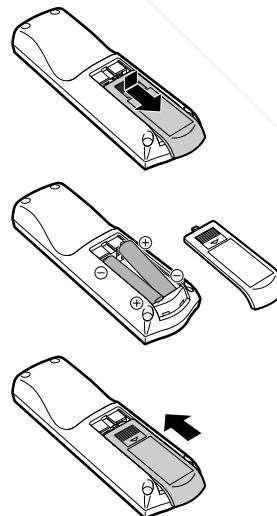
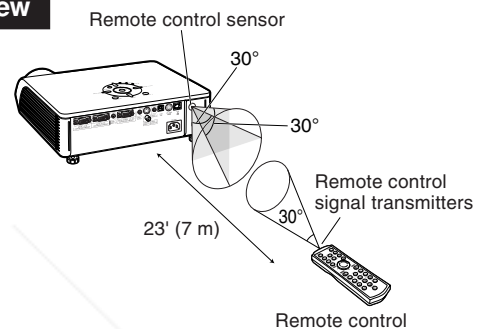

**Incorrect use of the batteries may cause them to leak or explode. Please follow the precautions below.**

### Caution

- Insert the batteries making sure the polarities correctly match the ⊕ and ⊖ marks inside the battery compartment.

Batteries of different types have different properties, therefore do not mix batteries of different types.

- Do not mix new and old batteries.

This may shorten the life of new batteries or may cause old batteries to leak.

- Remove the batteries from the remote control once they have run out, as leaving them in can cause them to leak.

Battery fluid from leaked batteries is harmful to skin, therefore ensure to first wipe them and then remove them using a cloth.

- The batteries included with this projector may run down in a short period, depending on how they are kept. Ensure to replace them as soon as possible with new batteries.
- Remove the batteries from the remote control if you will not be using the remote control for a long time.

# Quick Start

This section shows the basic operation (projector connecting with the computer). For details, see the page described below for each step.

## Setup and Projection

In this section, connection of the projector and the computer is explained using one example.

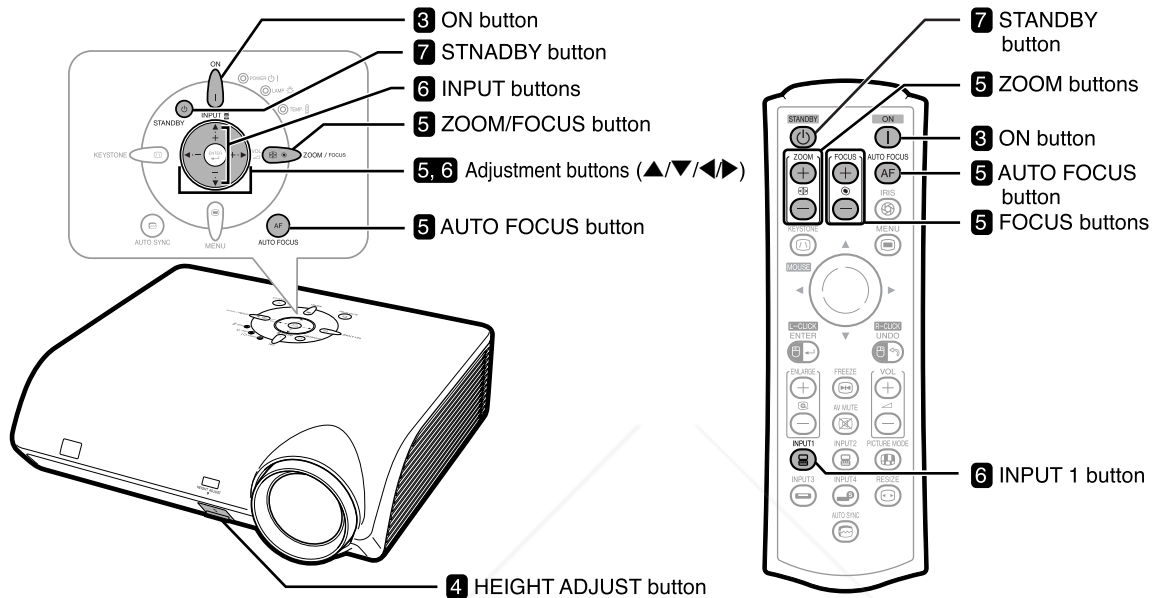

### 1. Place the projector facing a screen

→ Page 19

### 2. Connect the projector to the computer and plug the power cord into the AC socket of the projector

When connecting equipment other than the computer, see pages 25 and 26.

→ Pages 23, 29

### 3. Remove the lens cap and turn the projector on

On the projector: ON button

On the remote control: ON button

→ Page 29



## 4. Adjust the angle

Adjust the projector angle

- Adjust the projector angle using the HEIGHT ADJUST button.

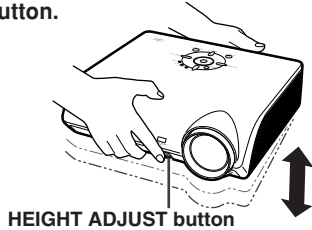

- This projector is equipped with an "Auto Keystone Correction" function that automatically corrects any trapezoidal distortion within the projected image. The correction is made automatically provided the vertical incline or decline is within 12 degrees.

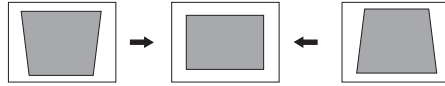

➔ Page 30

Quick Start

## 5. Adjust the focus and the zoom

### ① Bring the projected image into focus

- When the projector is turned on, the focus function automatically displays a focus pattern and performs Auto Focus once.



- To perform Auto Focus again, press the AUTO FOCUS button.

On the projector



On the remote control



- The focus pattern is displayed, the focus is automatically adjusted, and then the focus pattern disappears.

### ② Adjust the projected image size

- Adjust the projected image size by adjusting zoom.

On the projector

- Press ZOOM / FOCUS.
- Adjust by pressing or .

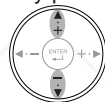

On the remote control  
Adjust by pressing the ZOOM buttons.

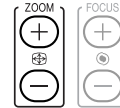

- If the image is out of focus or you want to finely adjust the focus, adjust the focus manually.

On the projector

- Press ZOOM / FOCUS.
- Adjust by pressing or .

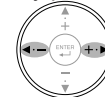

On the remote control  
Adjust by pressing the FOCUS buttons.

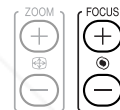

➔ Page 32

## 6. Select the INPUT mode

Select the "INPUT 1" using the INPUT buttons on the projector or the INPUT 1 button on the remote control.

On the projector

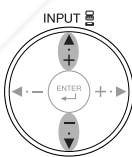

On the remote control



▼ On-screen Display (RGB)



- When pressing / on the projector, input mode switches in order of :

INPUT 1 ↔ INPUT 2 ↔ INPUT 3 ↔ INPUT 4

- When using the remote control, press to switch the INPUT mode.

➔ Page 33

## 7. Turn the Power off

Press the STANDBY button, then press that button again while the confirmation message is displayed, to put the projector into standby mode.

On the projector



On the remote control



▼ On-screen Display

Enter STANDBY mode?  
Yes: Press Again. No: Please Wait.

- Unplug the power cord from the AC outlet after the cooling fan stops.

➔ Page 29

GB-17

# Storing the Projector

## How to Use the Storage Case

When storing the projector, attach the lens cap to the lens, and place it in the supplied storage case.

**1** Open the cover of the storage case.

**2** Place the projector into the storage case.

### Info

- Ensure the projector has cooled down sufficiently before placing it in the case.
- Ensure the lens cap is attached to the lens for protection.
- **Place the projector into the storage case with the lens facing the handle.**
- Ensure the projector is held in place by using the fixing band.

**3** Close the cover of the storage case.

**4** Place the accessories in the front pocket of the storage case.

### Info

- This storage case is only for storing the projector.

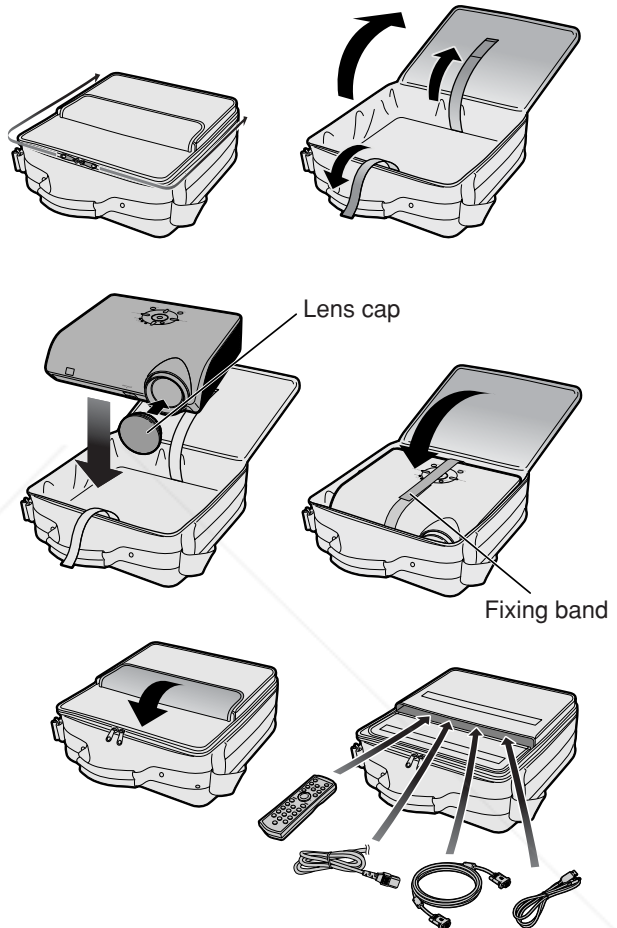



# Setting up the Projector

## Setting up the Projector

Position the projector perpendicular to the screen with the projector's feet flat and level to achieve an optimal image.

### Note

- The projector lens should be centered in the middle of the screen. If the horizontal line passing through the lens center is not perpendicular to the screen, the image will be distorted, making viewing difficult.
- For an optimal image, position the screen so that it is not in direct sunlight or room light. Light falling directly on the screen washes out the colors, making viewing difficult. Close the curtains and dim the lights when setting up the projector in a sunny or bright room.

## Standard Setup (Front Projection)

- Place the projector at the required distance from the screen according to the desired picture size. (For details, refer to page 2 of the "SETUP GUIDE" contained on the supplied CD-ROM.)

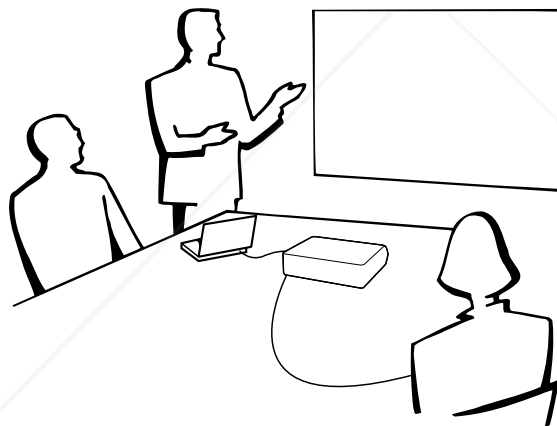

### Indication of the Projection Image Size and Projection Distance

For details, refer to page 2 of the "SETUP GUIDE" contained on the supplied CD-ROM.  
Example : NORMAL Mode (4:3)

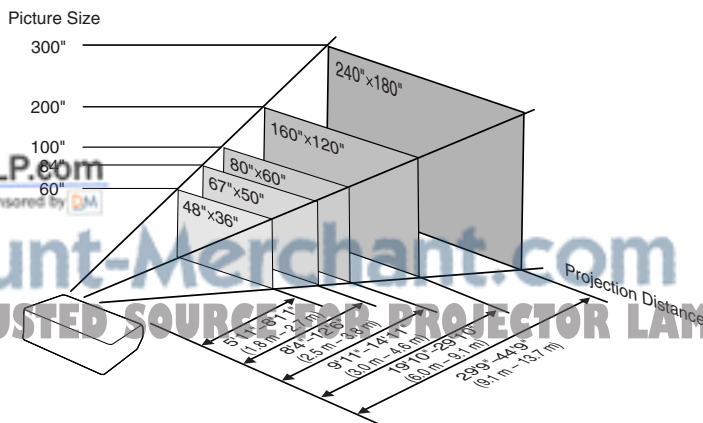

Setup





## Setting up the Projector

### Projecting a Reversed Image

#### Projection from behind the Screen

- Place a translucent screen between the projector and the audience.
- Reverse the image by setting “Rear” in the “PRJ Mode” menu. (See page 59.)

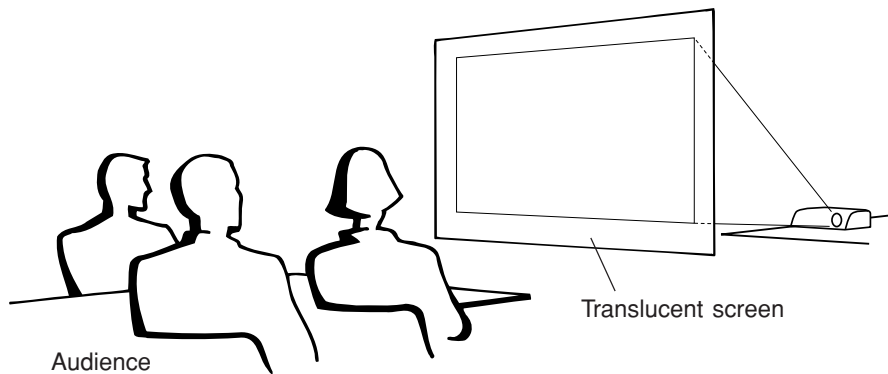

#### Projection Using a Mirror

- Place a mirror (normal flat type) in front of the lens.
- When the translucent screen is placed between the mirror and audience, set to “Front” in the “PRJ Mode” menu. (See page 59.)
- When the mirror is placed on the audience side, set to “Rear” in the “PRJ Mode” menu. (See page 59.)

##### Set to “Front”

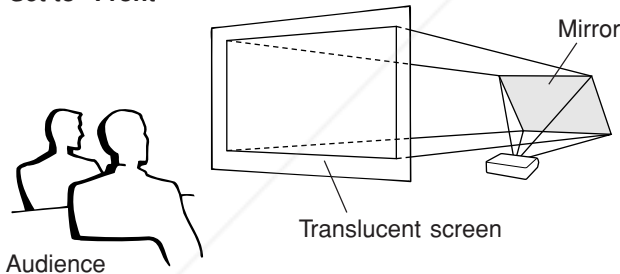

##### Set to “Rear”

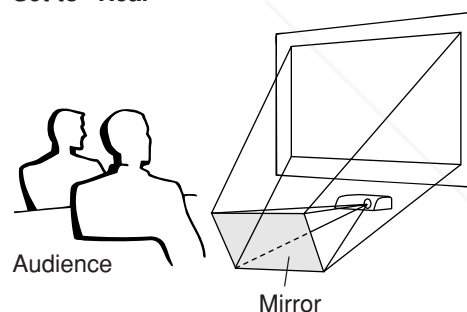

#### Info

- When using a mirror, ensure that both the projector and the mirror are carefully placed so the projected light does not shine into the eyes of the audience.

### Ceiling-mount Setup

- It is recommended that you use the optional Sharp ceiling-mount bracket for this installation.

Before mounting the projector, contact your nearest Sharp Authorized Projector Dealer or Service Center to obtain the recommended ceiling-mount bracket (sold separately).

- AN-MBCM10 ceiling-mount bracket, its AN-EP101B extension tube and AN-JT200 universal bracket, adaptor for non-level ceiling installation (for U.S.A.).
- AN-60KT ceiling-mount bracket, its AN-TK201 and AN-TK202 extension tubes (for countries other than the U.S.A.).

- Invert the image by setting “Ceiling + Front” in “PRJ Mode”. See page 59 for use of this function.

GB-20

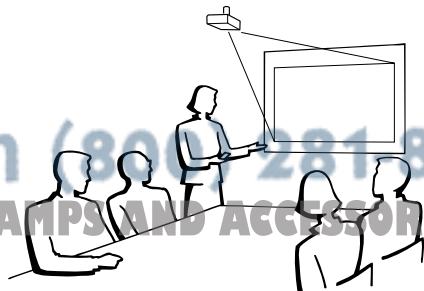





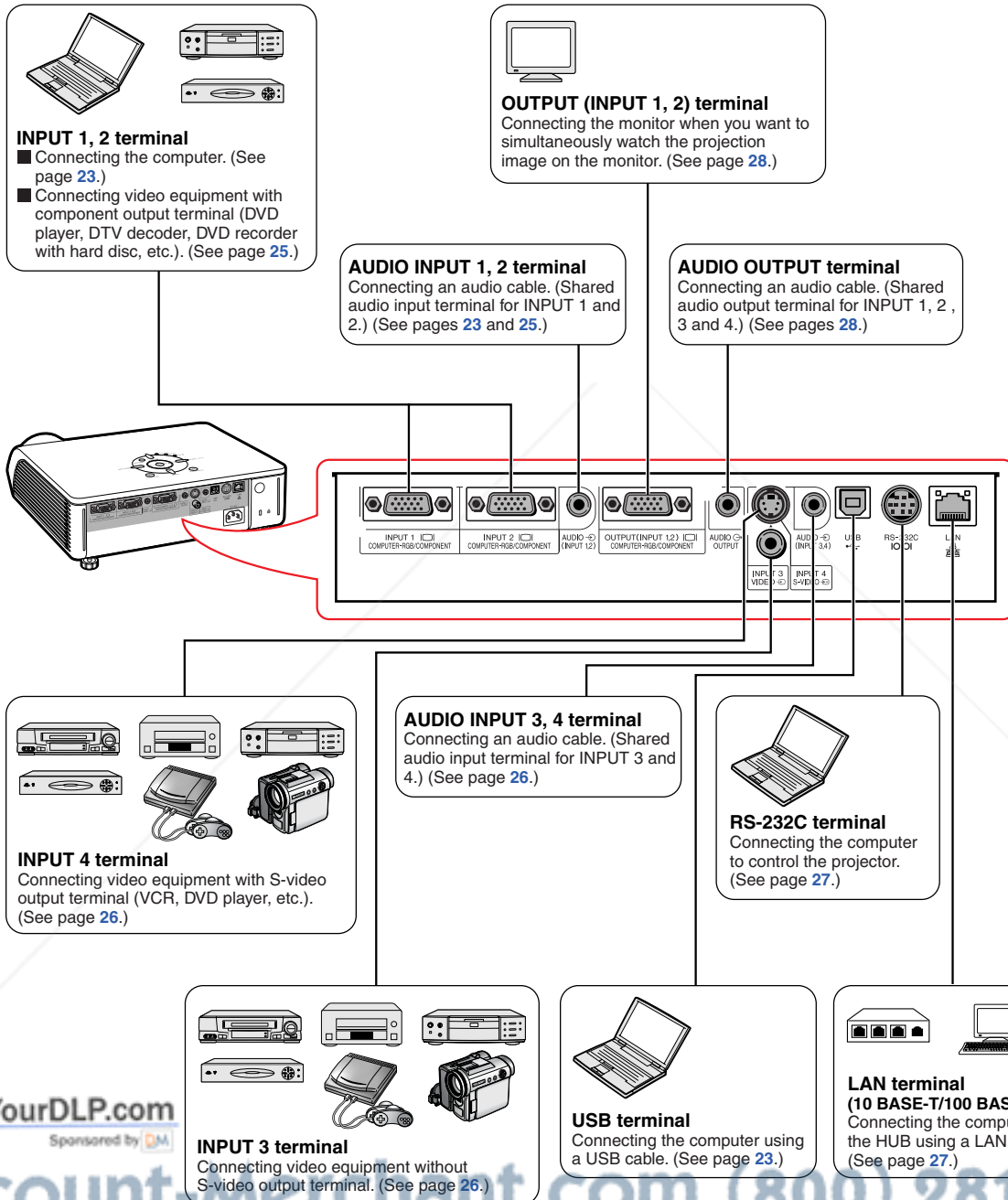





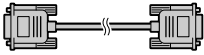
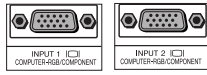
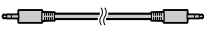

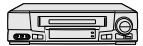

# Connections

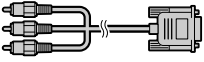
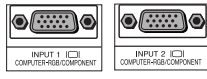
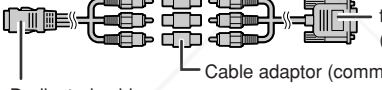
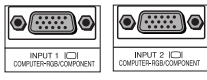
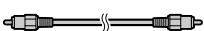
## INPUT/OUTPUT Terminals and Connectable Main Equipment

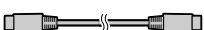
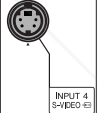
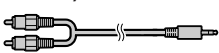
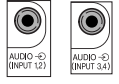
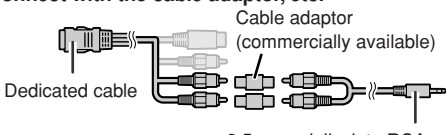
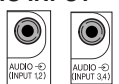
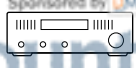

# Samples of Cables for Connection

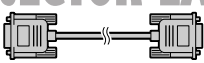
- For more details of connection and cables, refer to the operation manual of the connecting equipment.
- You may need other cables or connectors not listed below.

| Equipment  | Terminal on connected equipment               | Cable  | Terminal on the projector  |
|--|---|--|--|
|   | <b>RGB output terminal</b>                    | <b>RGB cable (supplied)</b><br>   | <b>INPUT 1, 2</b><br>     |
|  | <b>Audio output terminal</b>                  | <b>ø3.5 mm stereo audio cable (commercially available)</b><br>  | <b>AUDIO INPUT</b><br>    |
| <b>Audio-visual equipment</b><br>     | <b>Component video output terminal</b>        | <b>3 RCA (Component) to 15-pin D-sub cable (optional: AN-C3CP)</b><br>  | <b>INPUT 1, 2</b><br>     |
|  | <b>Terminal for using the dedicated cable</b> | <b>Connect with the cable adaptor, etc.</b><br><br>Dedicated cable      Cable adaptor (commercially available)   | <b>INPUT 1, 2</b><br>    |
|  | <b>Video output terminal</b>                  | <b>Video cable (commercially available)</b><br>   | <b>INPUT3</b><br>       |
|  | <b>S-video output terminal</b>                | <b>S-video cable (commercially available)</b><br>   | <b>INPUT4</b><br>       |
|  | <b>Audio output terminal</b>                  | <b>ø3.5 mm minijack to RCA audio cable (commercially available)</b><br>   | <b>AUDIO INPUT</b><br>  |
|  | <b>Terminal for using the dedicated cable</b> | <b>Connect with the cable adaptor, etc.</b><br><br>Dedicated cable      Cable adaptor (commercially available) | <b>AUDIO INPUT</b><br>  |
| <b>Amplifier</b><br>  | <b>Audio input terminal</b>                   | <b>ø3.5 mm minijack to RCA audio cable (commercially available)</b><br>   | <b>AUDIO OUTPUT</b><br> |
| <b>Monitor</b><br>  | <b>RGB input terminal</b>                     | <b>RGB cable (commercially available)</b><br>   | <b>OUTPUT</b><br>       |

# Connecting to a Computer

Before connecting, ensure the power cord of the projector from the AC outlet is unplugged, and that the devices to be connected are turned off. After making all connections, turn on the projector and then the other devices. When connecting a computer, ensure that it is the last device to be turned on after all the connections are made.

Ensure the operation manuals of the devices to be connected have been read before making connections.

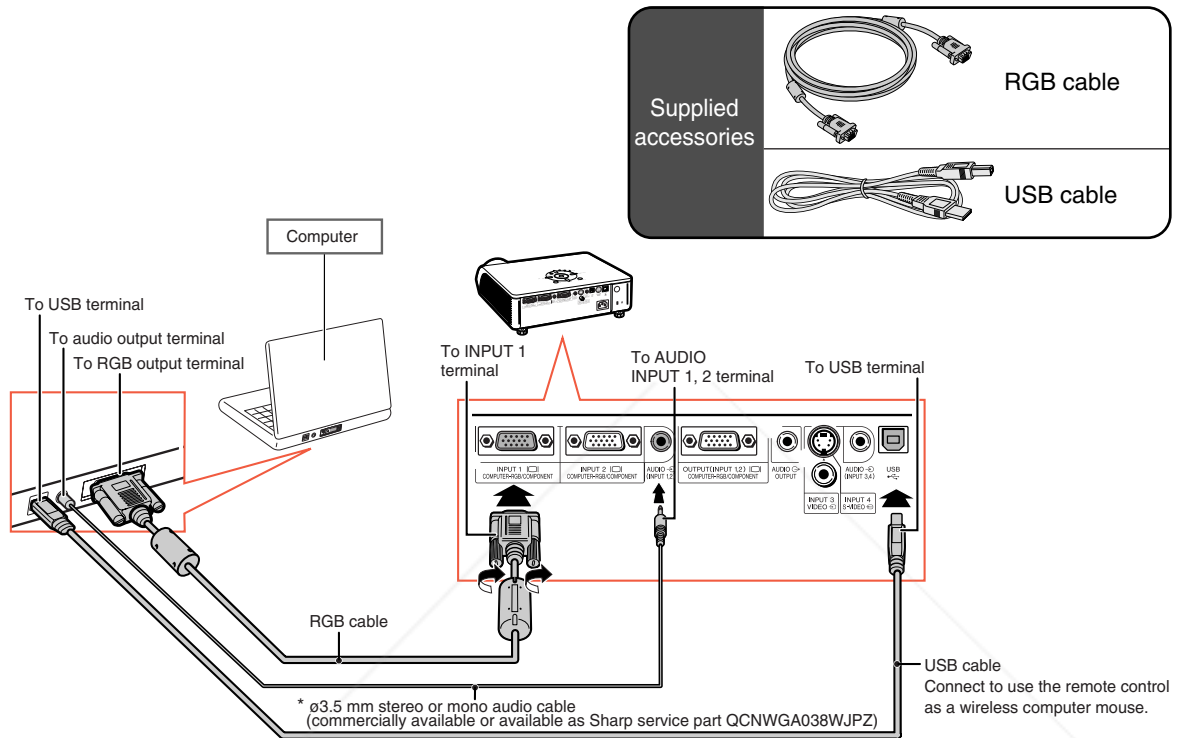

\* When using the ø3.5 mm mono audio cable, the volume level will be half of when using the ø3.5 mm stereo audio cable.

### Note

- When connecting with USB cable, you can use the remote control as a mouse for controlling the cursor. See page 24.
- See page 69 "Computer Compatibility Chart" for a list of computer signals compatible with the projector. Use with computer signals other than those listed may cause some of the functions to not work.
- A Macintosh adaptor may be required for use with some Macintosh computers. Contact your nearest Macintosh Dealer.
- **Depending on the computer you are using, an image may not be projected unless the signal output setting of the computer is switched to the external output.** Refer to the computer operation manual for switching the computer signal output settings.

### "Plug and Play" function (when connecting to a 15-pin terminal)

- This projector is compatible with VESA-standard DDC 1/DDC 2B. The projector and a VESA DDC compatible computer will communicate their setting requirements, allowing for quick and easy setup.
- Before using the "Plug and Play" function, **be sure to turn on the projector first and the connected computer last.**

### Note

- The DDC "Plug and Play" function of this projector operates only when used in conjunction with a VESA DDC compatible computer.

## Connecting to a Computer

### Using the Remote Control as the Wireless Computer Mouse

When connecting the projector and the computer with the supplied RGB cable and USB cable (see page 23), you can use the remote control as the computer mouse.

The mouse pointer can be operated in the following way after it is connected.

#### ■ When moving the cursor

Press MOUSE/Adjustment button (▲/▼/◀/▶).

#### ■ When left-clicking

Press .

#### ■ When right-clicking

Press .

#### ■ When your computer supports only a one-click mouse (such as Macintosh)

Press  or .

 L-CLICK and  R-CLICK have common function.

#### Note

- You cannot use this function when displaying the menu screen.
- Confirm that the computer recognizes the USB connection.
- If "Resize" is displayed when signals having a higher resolution than XGA are being input and you have set "Dot By Dot" as the screen size, you cannot operate the mouse function.

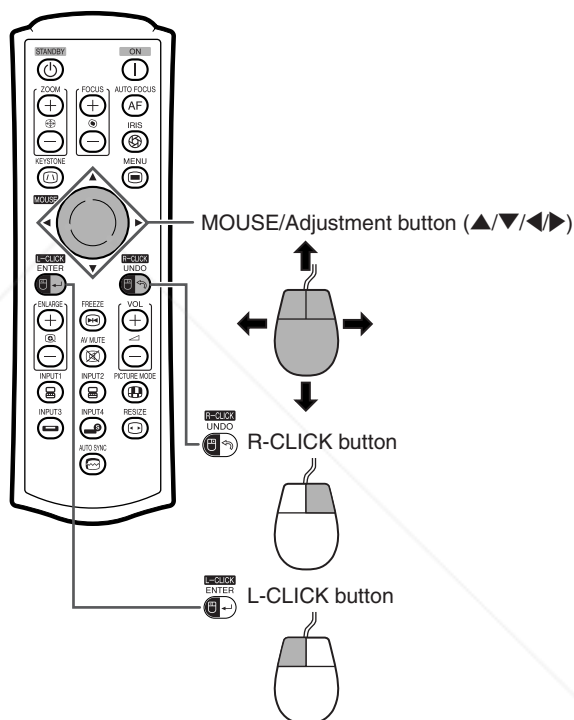

## Connecting to Video Equipment

The projector has a COMPUTER/COMPONENT terminal, an S-VIDEO terminal and a VIDEO terminal for video input. See the illustration below to connect with the audio-visual equipment.

The image quality is highest in order of the component signal, the S-video signal and the video signal. If your audio-visual equipment has a component output terminal, use the COMPUTER-RGB/COMPONENT terminal (INPUT 1 or INPUT 2) on the projector for video connection.

**When connecting video equipment with component video output terminal**  
(When connecting to INPUT 1)

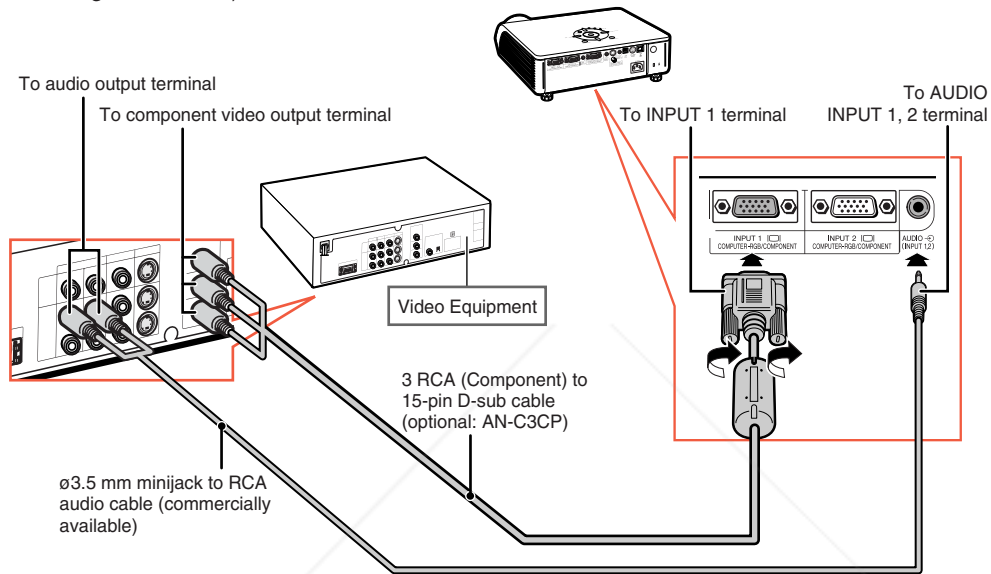

### Note

- ø3.5 mm minijack to RCA audio cable (commercially available) is required for audio input.

## Connecting to Video Equipment

### When connecting video equipment with video output terminal

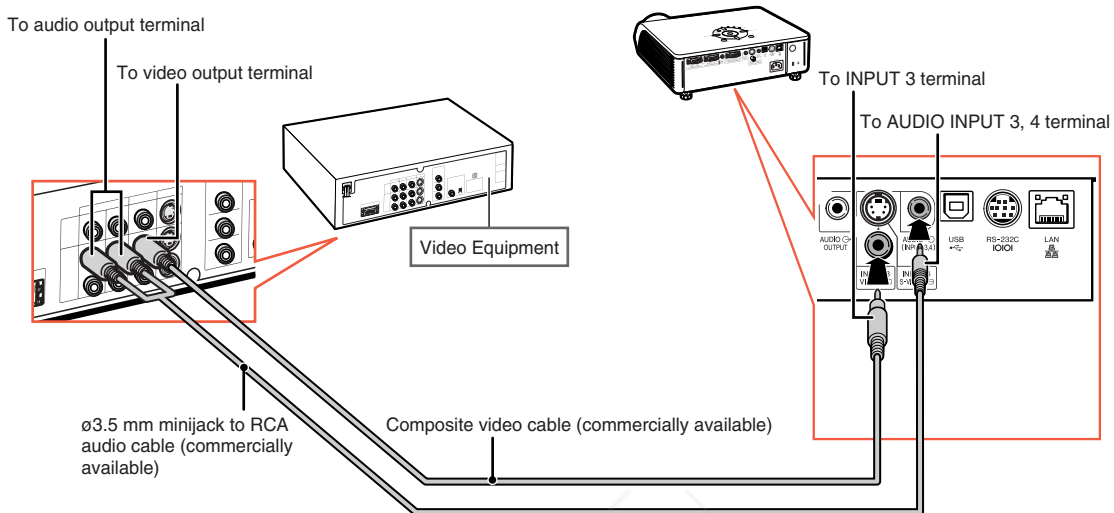

### When connecting video equipment with S-video output terminal

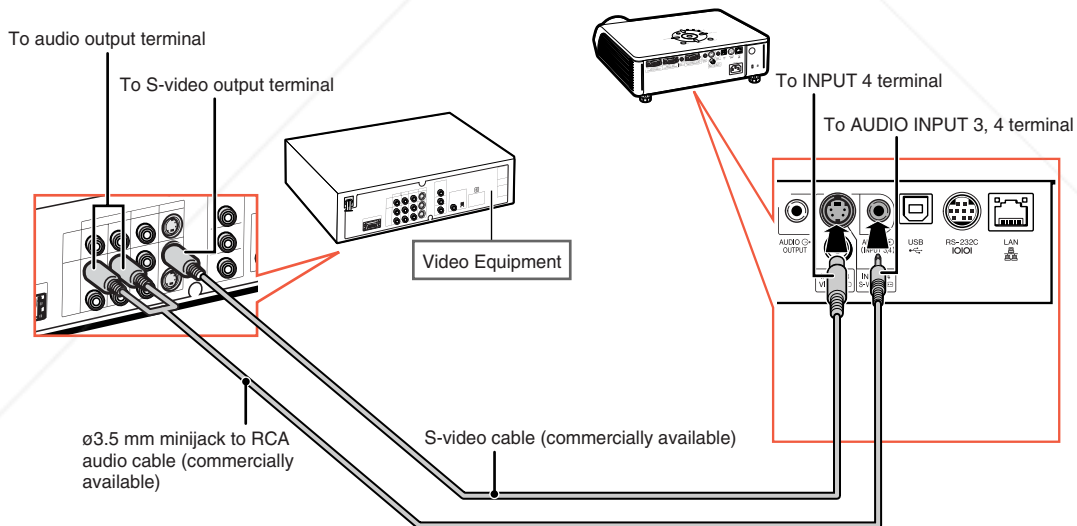

# Controlling the Projector by a Computer

When the RS-232C terminal on the projector is connected to a computer with a DIN-D-sub RS-232C adaptor (optional: AN-A1RS) and an RS-232C serial control cable (cross type, commercially available), the computer can be used to control the projector and check the status of the projector. Refer to the "SETUP GUIDE" contained on the supplied CD-ROM for details.

## When connecting to a computer using an RS-232C serial control cable and a DIN-D-sub RS-232C adaptor

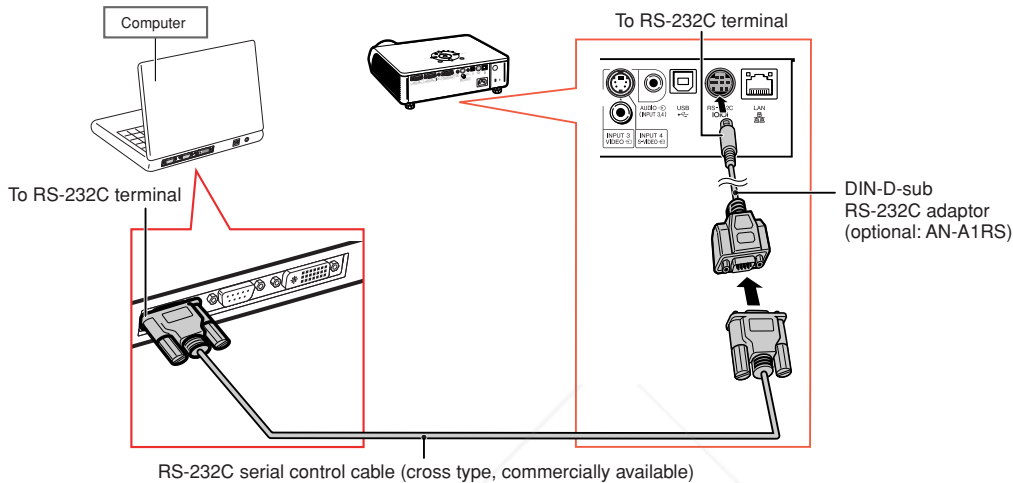

### Note

- The RS-232C function may not operate if your computer terminal is not correctly set up. Refer to the operation manual of the computer for details.
- Refer to the "SETUP GUIDE" contained on the supplied CD-ROM for "RS-232C Specifications and Commands".

### Info

- Do not connect the RS-232C cable to a port other than the RS-232C terminal on the computer. This may damage your computer or projector.
- Do not connect or disconnect an RS-232C serial control cable to or from the computer while it is on. This may damage your computer.

## When connecting to the LAN terminal using a LAN cable

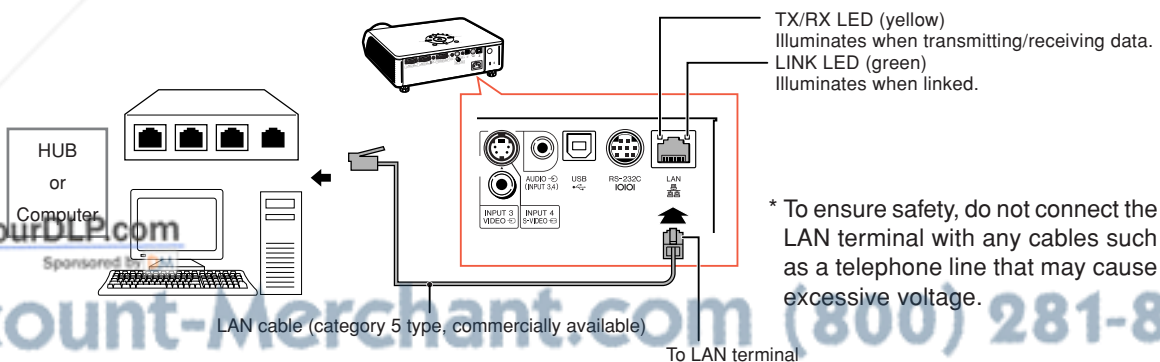

\* To ensure safety, do not connect the LAN terminal with any cables such as a telephone line that may cause excessive voltage.

### Note

- When connecting to hub, use straight-through category 5 (CAT.5) type cable (commercially available).
- When connecting to computer, use cross-over category 5 (CAT.5) type cable (commercially available).





## Connecting to a Monitor with RGB input terminal

You can display computer images on both the projector and a separate monitor using two sets of RGB cables.

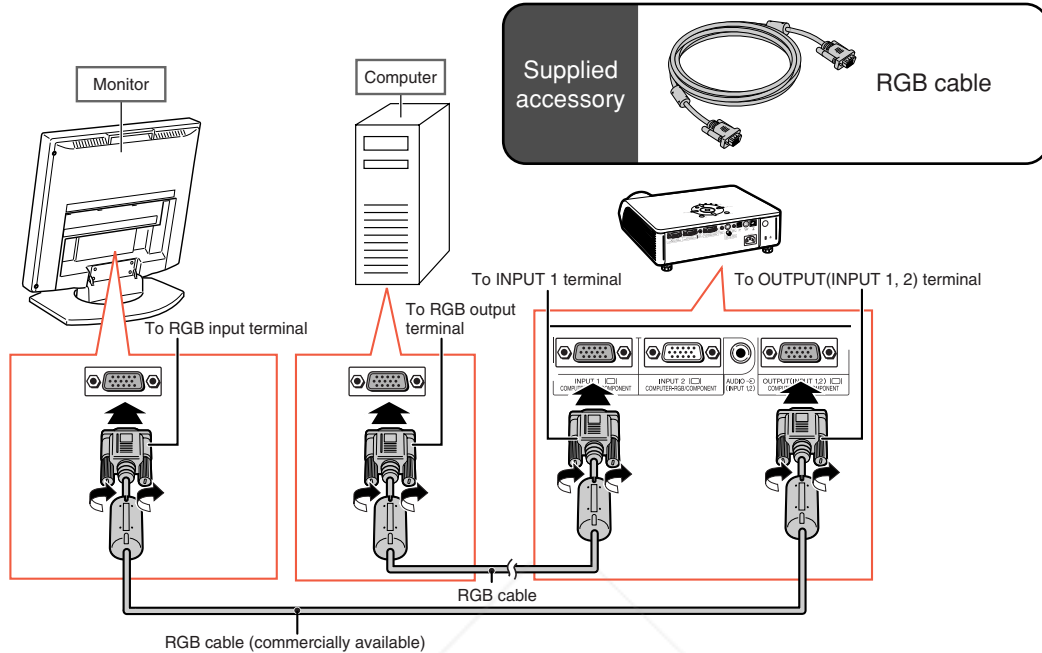

### Note

- RGB signals and Component signals can be output to the monitor.
- For this connection, another RGB cable (commercially available) is required.

## Connecting to an Amplifier or Other Audio Equipment

Audio signals input from equipment connected to each audio input terminal of the projector can be output to audio equipment.

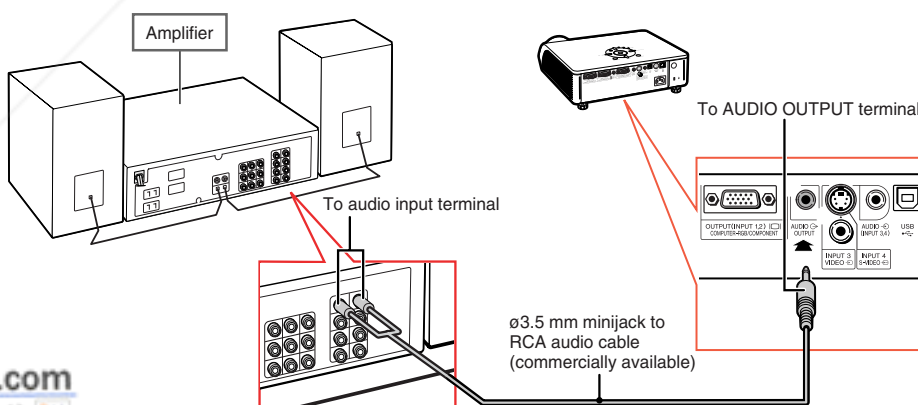

### Note

- ø3.5 mm minijack to RCA audio cable (commercially available) is required for audio input.
- Turn off the power of both the projector and audio equipment when connecting.
- When turning off the power in the case of connecting an amplifier or other audio equipment, first turn off the power of the amplifier and then turn off the power of the projector.
- By using external audio components, the volume can be amplified for better sound.
- For details on Variable Audio Output (VAO) and Fixed Audio Output (FAO), see page 58.

GB-28

# Turning the Projector On/Off

## Connecting the Power Cord

Plug the supplied power cord into the AC socket on the rear of the projector.

Supplied accessory

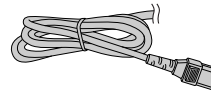

Power cord

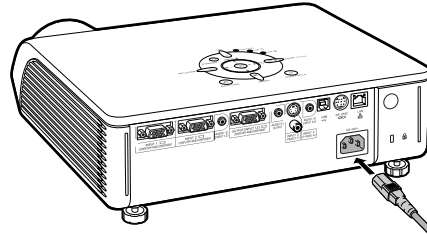

## Turning the Projector on

Before performing the steps in this section, connect any equipment that you use with the projector. (See pages 23-28.)

Remove the lens cap and press **ON** on the projector or **ON** on the remote control.

- The power indicator illuminates green.
- After the lamp indicator illuminates, the projector is ready to start operation.
- When System Lock is set, the keycode input screen appears. Enter the right keycode to start projection. See page 54 for details.

### Info

- English is the factory preset language. If you want to change the on-screen display to another language, change the language according to the procedure on page 62.

### Note

- The lamp indicator illuminates or blinks, indicating the status of the lamp.
  - Green:** The lamp is ready.
  - Blinking green:** The lamp is warming up or shutting down.
  - Red:** The lamp is shut down abnormally or the lamp should be replaced.
- When switching on the projector, a slight flickering of the image may be experienced within the first minute after the lamp has been illuminated. This is normal operation as the lamp's control circuitry is stabilizing the lamp output characteristics. This does not indicate malfunction.
- If the projector is put into standby mode and immediately turned on again, the lamp may take some time to illuminate.

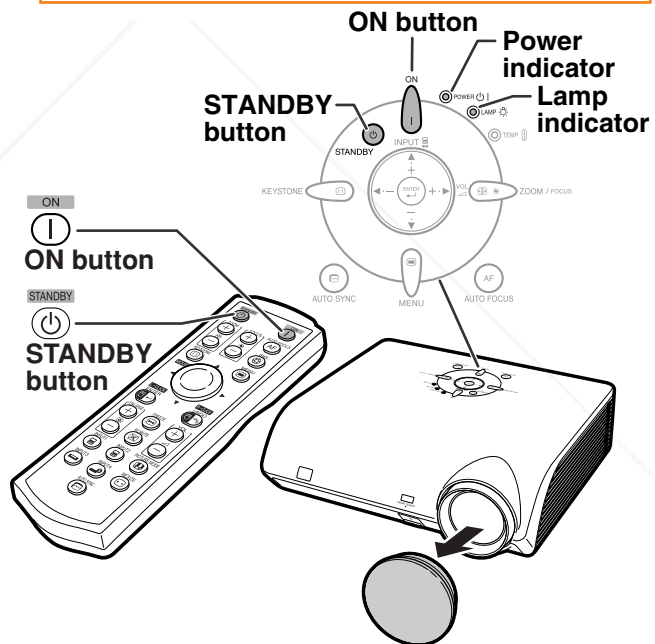

## Turning the Power off (Putting the Projector into Standby Mode)

1 Press **ON** on the projector or **ON** on the remote control, then press that button again while the confirmation message is displayed, to put the projector into standby mode.

2 Unplug the power cord from the AC outlet after the cooling fan stops.

### On-screen Display

Enter STANDBY mode?  
Yes: Press Again. No: Please Wait.

Shutting Down. Please Wait.

### Info

- Do not unplug the power cord during projection or cooling fan operation. The cooling fan in this projector continues to run for about 90 seconds after the projector enters the standby mode. This can cause damage due to rise in internal temperature, as the cooling fan also stops.

# Image Projection

## Using the Adjustment Feet

The height of the projector can be adjusted using the adjustment feet at the front and rear of the projector when the screen is located higher than the projector, the screen is inclined or when the installation site is slightly inclined. Install the projector so that it is as perpendicular to the screen as possible.

**1 Press the HEIGHT ADJUST button.**  
• The front adjustment foot comes out.

**2 Lift the projector to adjust its height while pressing the HEIGHT ADJUST button.**

- The projector is adjustable up to approximately 12 degrees (7 steps).
- When lowering the projector, it may be difficult to move the front adjustment foot because the installation surface is difficult to slide. In this case, pull the projector back slightly and adjust its height.

**3 Remove your hands from the HEIGHT ADJUST button of the projector after its height has been finely adjusted.**

**4 Finely adjust the height and inclination by turning the rear adjustment feet.**

- When adjusting the height of the projector, trapezoidal distortion occurs. When "Auto Keystone" of the "Options2" menu is set to "ON" (see page 57), keystone correction functions automatically to correct trapezoidal distortion. When you want to adjust the automatically corrected image, use the manual keystone correction. (See page 31.)

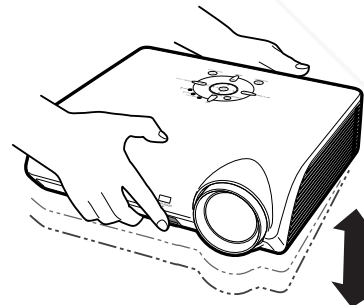
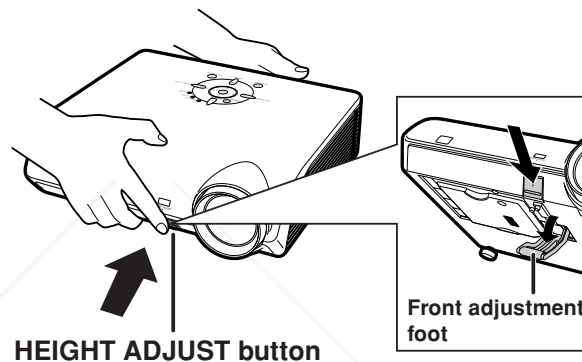
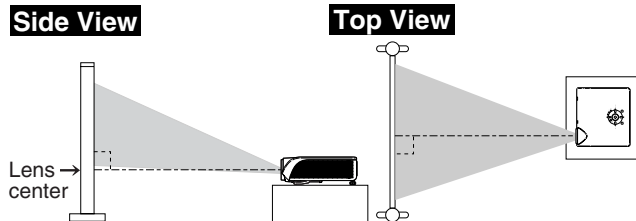

FixYourDLP.com

- Do not press the HEIGHT ADJUST button when the front adjustment foot comes out without firmly holding the projector.
- Do not hold the lens when lifting or lowering the projector.
- When lowering the projector, be careful not to get your fingers caught in the area between the adjustment foot and the projector.

## Correcting Trapezoidal Distortion

### Auto Keystone Correction

When the image is projected either from the top or from the bottom towards the screen at an angle, the image becomes distorted trapezoidally. The function for correcting trapezoidal distortion is called Keystone Correction.

This projector is equipped with an "Auto Keystone Correction" function that automatically corrects any trapezoidal distortion within the projected image. The correction is made automatically provided the vertical incline or decline is within 12 degrees.

#### Note





- When not using the Auto Keystone Correction function, set "Auto Keystone" on the "Options2" menu to "OFF".





### Manual Keystone Correction

When you want to make fine adjustments after the Auto Keystone Correction function has been activated, or when you want to make corrections without using the Auto Keystone Correction function, you can make corrections manually using the following procedure.

**1** Press  on the remote control to enter the Keystone Correction mode.

- You can also use  on the projector.

**2** Press ,  or ,  on the remote control to adjust the Keystone Correction.

- You can also adjust the Keystone Correction using the ,  or ,  buttons on the projector.

#### Note

- Press  to return to the default setting.
- Straight lines or the edges of images may appear jagged while adjusting the image.

**3** Press .

- The on-screen display of the Keystone Correction mode will disappear.
- You can also use  on the projector.

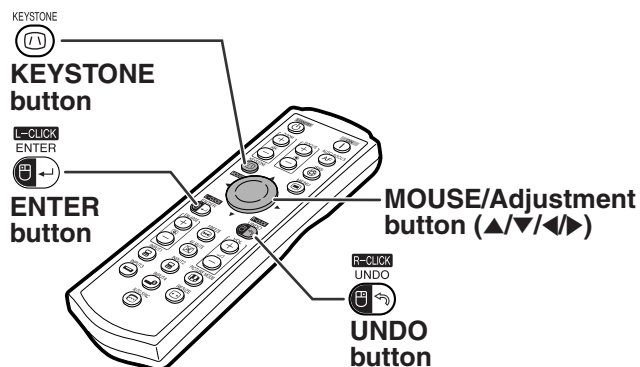

### ▼ On-screen Display (Keystone Correction mode)

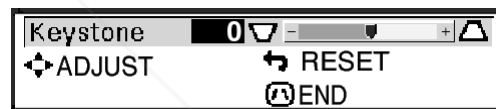

Compresses upper side.

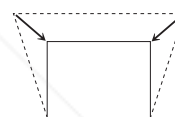
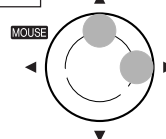

Compresses lower side.

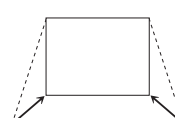
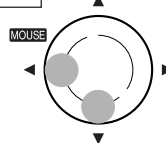

#### Note

- The Manual Keystone Correction can be adjusted up to an angle of approximately  $\pm 35$  degrees and the screen can also be set up to an angle of approximately  $\pm 35$  degrees (when the resize mode is set to "NORMAL" (see page 36)).
- The screen can also be installed by inclining to that angle.
- The Keystone Correction cannot be adjusted in the lateral direction.
- You can use the same settings used in NORMAL mode 4:3 for 16:9.

## Image Projection

### Adjusting the Focus

This projector is equipped with an “Auto Focus” function that adjusts the focus automatically when it is turned on. When you want to readjust the focus after the Auto Focus function has been activated, you can operate the Auto Focus function using the following procedure.

Press  on the projector or  on the remote control.

- The focus is adjusted automatically after which the focus pattern is displayed, and the focus pattern disappears from the screen.

#### Note

- Auto Focus can be performed over a range of 40 to 100 inches.
- The ability to adjust the focus automatically depends on the screen conditions and the surrounding brightness.
- Adjust the focus manually when the focus is not adjusted with Auto Focus or when you want to make fine adjustments.

#### When adjusting the focus using the buttons

- |   |  |
|---|--|
| <p><b>on the projector</b></p> <p>① Press  ZOOM / FOCUS.</p> <p>② Adjust by pressing  or .</p> | <p><b>on the remote control</b></p> <p>Adjust by pressing the FOCUS buttons.</p> |
|---|--|

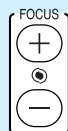
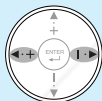

- When not using the Auto Focus function, set “Auto Focus” on the “Options2” menu to “OFF”.

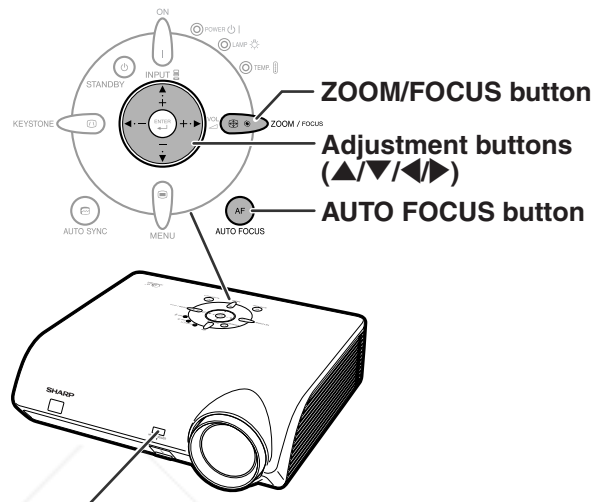

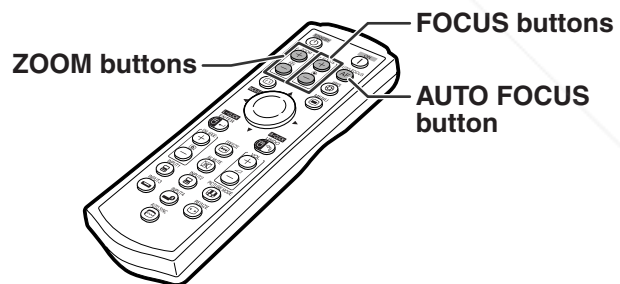

#### Auto focus sensor

Auto focus may not function normally if there is an obstruction between the auto focus sensor and the screen, or if there is dirt or dust on the auto focus sensor. Remove any obstructions, dirt or dust.



### Adjusting the Projected Image Size

#### When adjusting zoom using the buttons

- |   |   |
|---|---|
| <p><b>on the projector</b></p> <p>① Press  ZOOM.</p> <p>② Adjust by pressing  or .</p> | <p><b>on the remote control</b></p> <p>Adjust by pressing the ZOOM buttons.</p> |
|---|---|



#### Note

- **Manually adjusting the focus or zoom**  
After you have pressed the FOCUS buttons or ZOOM buttons on the remote control, or after you have pressed the ZOOM/FOCUS button on the projector, you can display the test pattern by pressing the ENTER button. The test pattern is useful for making more accurate adjustments.



## Switching the INPUT Mode

Select the appropriate input mode for the connected equipment.

Press , , or on the remote control to select the input mode.

• When pressing or on the projector, input mode switches in order of :

→ INPUT 1 ↔ INPUT 2 ↔ INPUT 3 ↔ INPUT 4 ←

### Note

- When no signal is received, "NO SIGNAL" will be displayed. When a signal that the projector is not preset to receive is received, "NOT REG." will be displayed.
- The INPUT mode is not displayed when "OSD Display" of the "Options1" menu is set to "OFF". (See page 51.)

### About the INPUT mode

|  |  |
|--|--|
| INPUT 1/<br>INPUT 2<br>(RGB/<br>Component) | Used for projecting images from equipment that sends RGB signals or component signals connected to the RGB input terminal. |
| INPUT 3<br>(Video)                         | Used for projecting images from equipment connected to the VIDEO input terminal.   |
| INPUT 4<br>(S-Video)                       | Used for projecting images from equipment connected to the S-VIDEO input terminal.   |

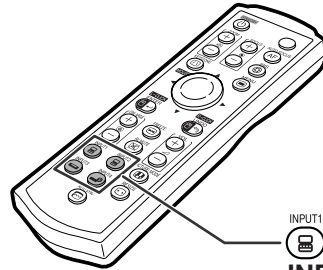

INPUT1 INPUT2 INPUT3 INPUT4  
INPUT buttons

### ▼ On-screen Display of INPUT Mode (Example)

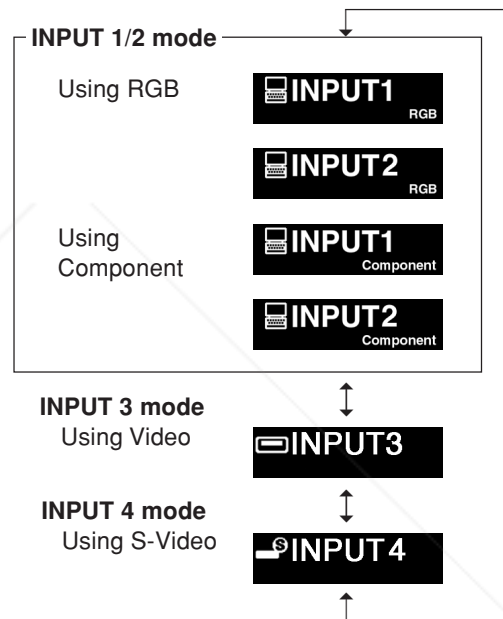

## Adjusting the Volume

Press or on the projector or VOL / on the remote control to adjust the volume.

### Note

- Pressing or will lower the volume.
- Pressing or will raise the volume.

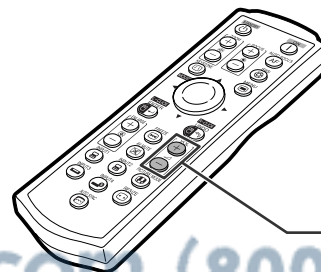

VOL  
+  
-  
Volume buttons

### ▼ On-screen Display



## Image Projection

### Displaying the Black Screen and Turning off the Sound Temporarily

Press  on the remote control to temporarily display a black screen and turn off the sound.

#### Note

- Pressing  again will turn the projected image and sound back on.

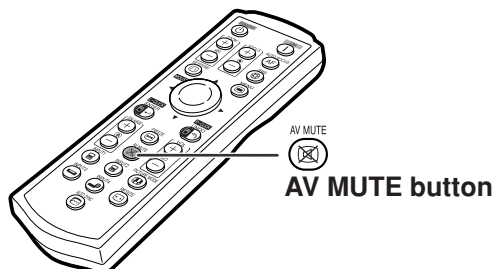

#### ▼ On-screen Display



**AV MUTE**

### Displaying an Enlarged Portion of an Image





Graphs, tables and other portions of projected images can be enlarged. This is helpful when providing more detailed explanations.

#### 1 Press on the remote control.

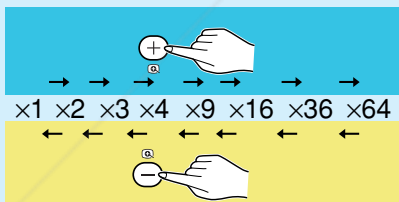
- Enlarges the image.
- Pressing  or  enlarges or reduces the projected image.

#### Note





- You can change the location of the enlarged image using , ,  and .

#### 2 Press on the remote control to cancel the operation.

- The magnification then returns to  $\times 1$ .

#### FixYourDL.com

In the following cases, the image will return to the normal size ( $\times 1$ ).

- When switching the INPUT mode.
- When  has been pressed.
- When the input signal is changed.
- When the input signal resolution and refresh rate (vertical frequency) change.
- When  has been pressed.

#### MOUSE/Adjustment button ()

#### ENLARGE (Enlarge/Reduce) buttons

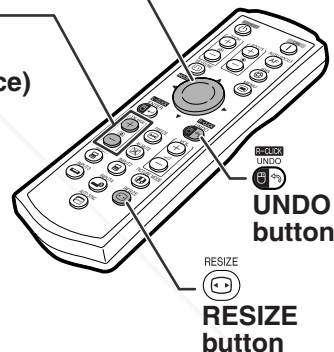



## Freezing a Moving Image

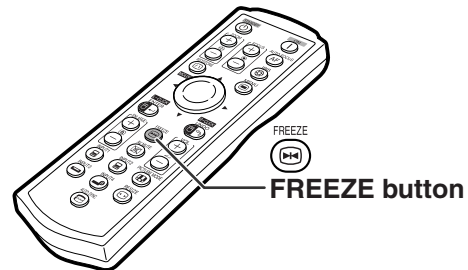

- 1 Press  on the remote control.
  - The projected image is frozen.

- 2 Press  again to return to the moving image from the currently connected equipment.



## Selecting the Picture Mode

You can select the suitable picture mode for the projected image, such as movie or video game.

- Press  on the remote control.
- When pressing , the picture mode changes in order of
- Standard → Presentation → Cinema → Game →

### Note

- Press  to return to the “Standard” mode.
- This function can also be accessed from the OSD menu (see page 44).

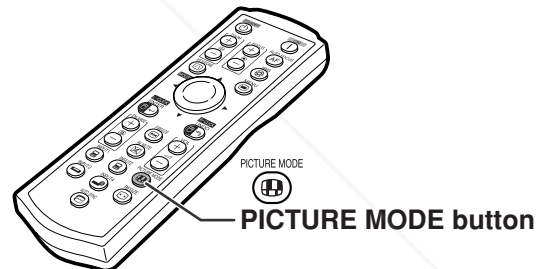

## Switching the High Brightness / High Contrast Mode

This function controls the quantity of the projected light and the contrast of the image.

- Press  on the remote control.
- The mode is switched between “High Brightness” mode and “High Contrast” mode.

### Note

- This function can also be accessed from the OSD menu (see page 46).

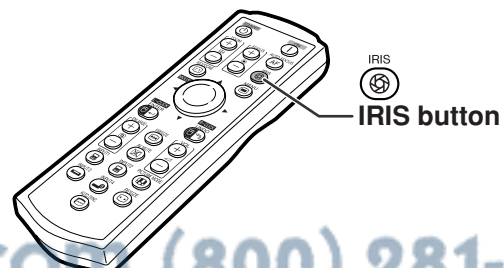







## Image Projection

This function allows you to modify or customize the resize mode to enhance the input image. Depending on the input signal, you can choose “NORMAL”, “DOT BY DOT”, “BORDER” or “STRETCH” image.

### Resize Mode

Press  on the remote control.

- Pressing  changes the display as shown on pages 36 and 37.
- To return to the standard image, press  while “RESIZE” is displayed on the screen.
- This function can also be accessed from the OSD menu (see page 50).

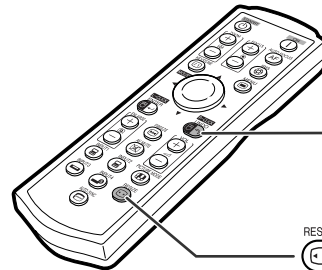



 UNDO button

 RESIZE button

### COMPUTER

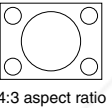
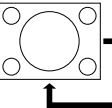
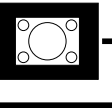
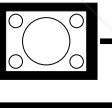
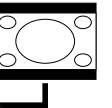
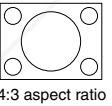
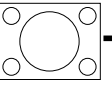
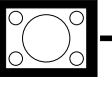
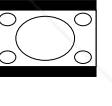
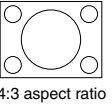
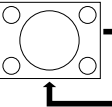
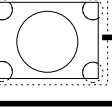
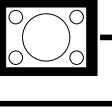
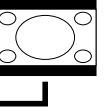
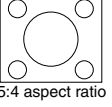
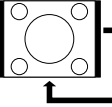
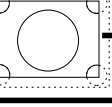
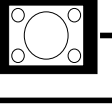
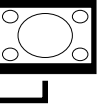
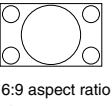
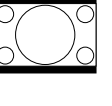
|                     |                     | NORMAL     | DOT BY DOT  | BORDER    | STRETCH    |
|---------------------|---------------------|------------|-------------|-----------|------------|
| 4:3 aspect ratio    | SVGA (800 × 600)    | 1024 × 768 | 800 × 600   | 768 × 576 | 1024 × 576 |
|                     | XGA (1024 × 768)    |            | —           |           |            |
|                     | SXGA (1280 × 960)   |            | 1280 × 960  |           |            |
|                     | SXGA+ (1400 × 1050) |            | 1400 × 1050 |           |            |
| Other aspect ratios | SXGA (1280 × 1024)  | 960 × 768  | 1280 × 1024 | 720 × 576 | 960 × 576  |
|                     | 1280 × 720          | —          | —           | —         | 1024 × 576 |

| Input Signal               |  | Output screen image   |   |   |   |
|----------------------------|--|---|---|---|---|
| Computer                   | Image type   | NORMAL  | DOT BY DOT  | BORDER  | STRETCH   |
| Resolution lower than XGA  | <br>4:3 aspect ratio  | *  | *  | *  |    |
| XGA                        | <br>4:3 aspect ratio  | *  | —   | *  |    |
| Resolution higher than XGA | <br>4:3 aspect ratio  | *  |    | *  |    |
| SXGA (1280 × 1024)         | <br>5:4 aspect ratio  | *  |    | *  |    |
| 1280 × 720                 | <br>16:9 aspect ratio | —   | —   | —   | *  |

\* Mode for projecting an image with the original aspect ratio without cutting any portions.  : Cutout area on which images cannot be projected.  : Area where the signals are off screen.

**THE TRUSTED SOURCE FOR PROJECTOR LAMPS AND ACCESSORIES**

• If “Resize” is displayed when you have set “DOT BY DOT” and signals having a higher resolution than XGA are being input, you can move the image so that it appears entirely within the panel by using the adjustment buttons (▲/▼/◀/▶) on the remote control. (However, this does not apply when you have set “Resize” from the OSD menu.)



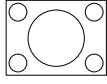
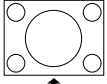
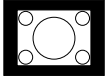
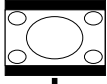
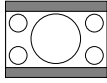
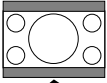
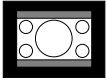
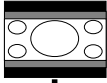
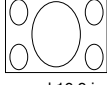
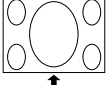
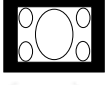
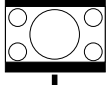
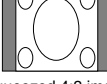
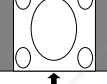
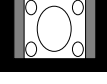
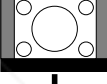
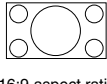
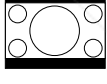
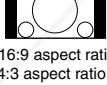
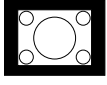

## VIDEO

• "STRETCH" is fixed when 540P, 720P or 1080I signals are entered.

| Input Signal                    |  | Output screen image   |   |   |
|---------------------------------|--|---|---|---|
| DVD / Video                     | Image type   | NORMAL  | BORDER  | STRETCH   |
| 480I, 480P,<br>NTSC, PAL, SECAM | <br>4:3 aspect ratio  | *  | *  |      |
|                                 | <br>Letter box  | *  | *  |      |
|                                 | <br>Squeezed 16:9 image   |    |    | *    |
|                                 | <br>Squeezed 4:3 image   |   |   | *   |
| 540P, 720P,<br>1080I (16:9)     | <br>16:9 aspect ratio   | —   | —   | *  |
|                                 | <br>16:9 aspect ratio<br>(4:3 aspect ratio in<br>16:9 screen) | —   | —   | *  |

\* Mode for projecting an image with the original aspect ratio without cutting any portions.

 : Cutout area on which images cannot be projected.

 : Area on which the image is not included in the original signals.



# Menu Items

The following shows the items that can be set in the projector.

## “Picture” menu

### INPUT 1 (RGB) / INPUT 2 (RGB)

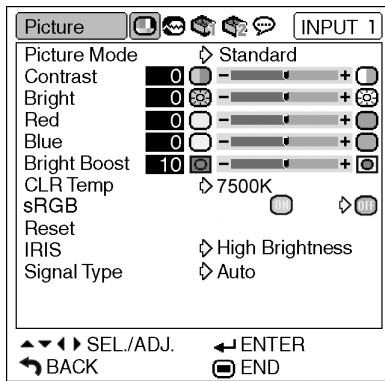

### INPUT 1 (Component) / INPUT 2 (Component) INPUT 3 / INPUT 4

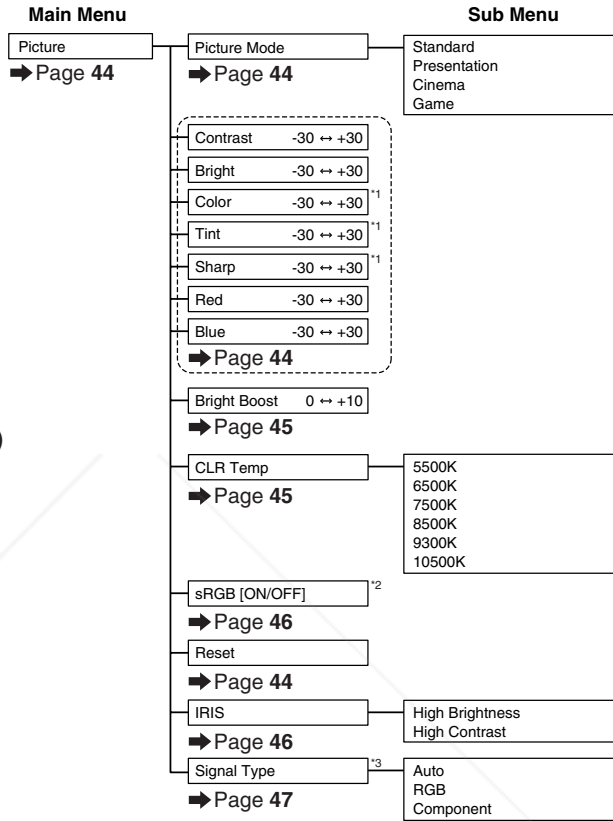
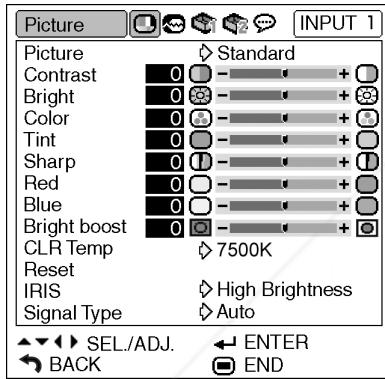

\*1 Items when inputting component signal through INPUT 1 or INPUT 2, or when selecting INPUT 3 or INPUT 4

\*2 Item when inputting RGB signal through INPUT 1 or INPUT 2

\*3 Item when selecting INPUT 1 or INPUT 2

## “Fine Sync” menu

### INPUT 1 / INPUT 2

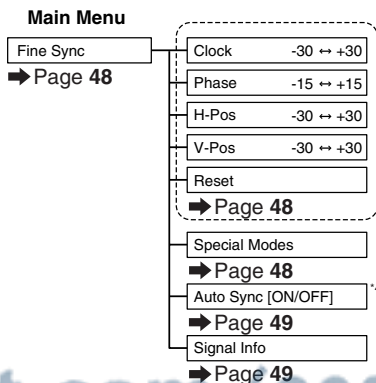
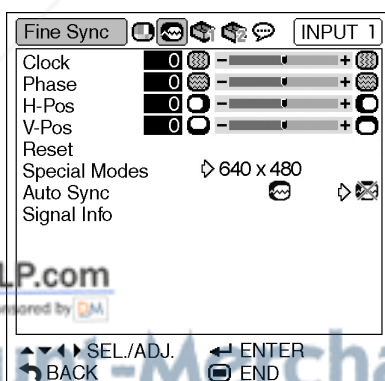

\*4 Item when inputting RGB signal through INPUT 1 or INPUT 2



Discount-Merchant.com (800) 281-8860

THE TRUSTED SOURCE FOR PROJECTOR LAMPS AND ACCESSORIES



**When using the INPUT 1 or INPUT 2 mode:**

- “Fine Sync” menu is only displayed when the projector input is INPUT 1 or INPUT 2.





### “Options1” menu

Example: INPUT 3/INPUT 4

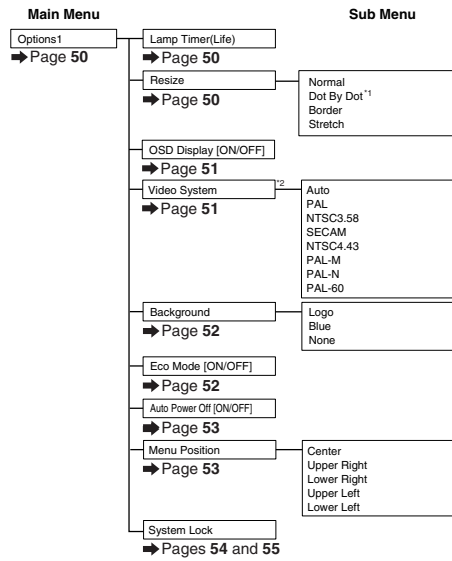
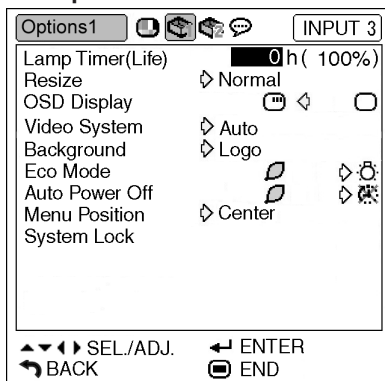

\*1 Item when inputting RGB signal through INPUT 1 or INPUT 2  
 \*2 Item when selecting INPUT 3 or INPUT 4

### “Options2” menu

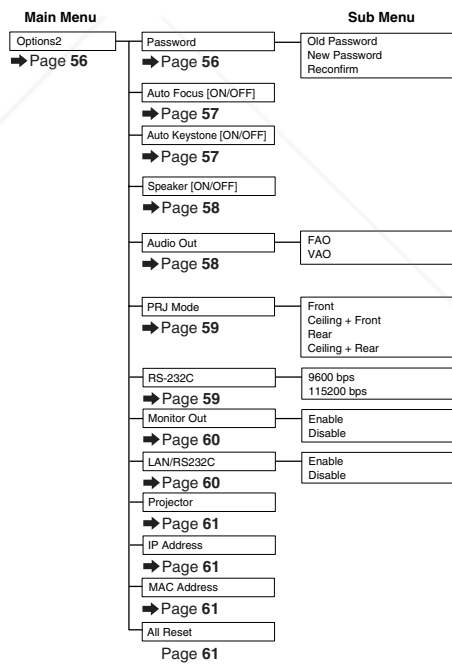
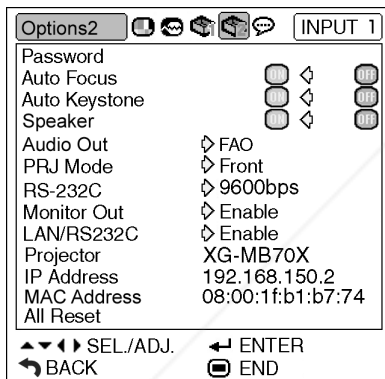

### “Language” menu

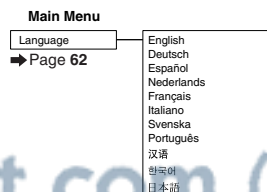
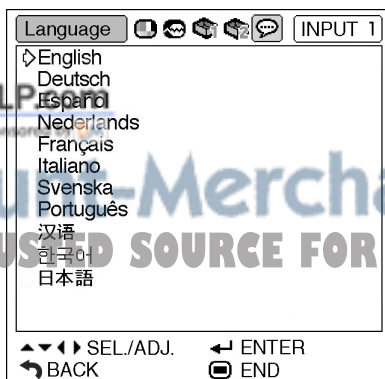

Useful Features

FixYourDLP.com  
 Discount-Merchant.com (800) 281-8860  
 THE TRUSTED SOURCE FOR PROJECTOR LAMPS AND ACCESSORIES

# Using the Menu Screen

The menu can be operated to achieve two functions, adjustments and settings. (For setting the menu items, see pages 42 and 43.)

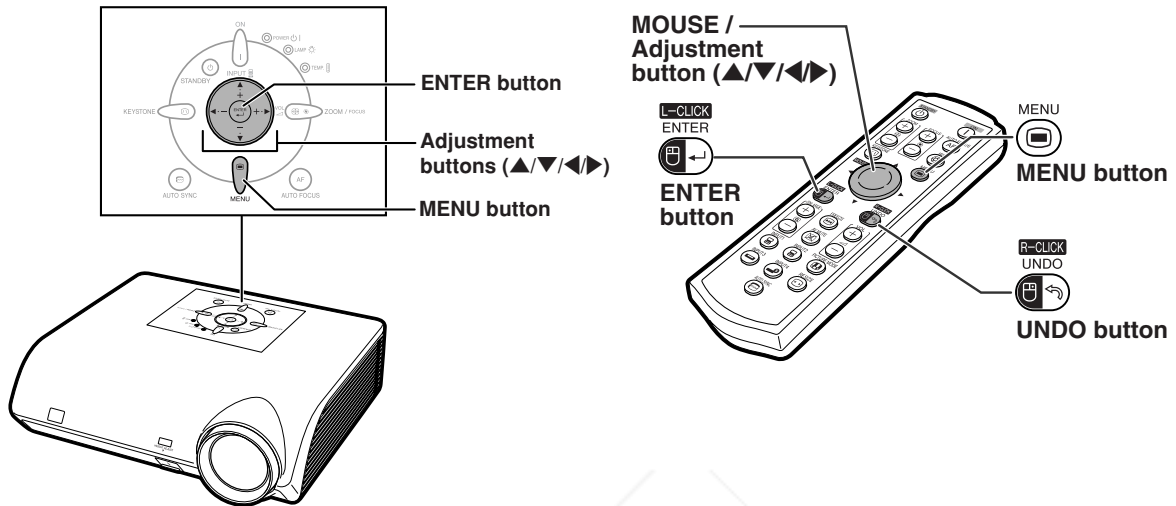

## Menu Selections (Adjustments)

### Example: Adjusting “Bright”

This operation can also be performed by using the buttons on the projector.

- 1 Press .
  - The “Picture” menu screen for the selected input mode is displayed.

### Example: “Picture” screen menu for INPUT 1 (RGB) mode

- 2 Press or to display the other menu screens.
  - The menu icon for the selected menu screen is highlighted.

| Menu icon | Menu screen |
|-----------|-------------|
|           | Picture     |
|           | Fine Sync   |
|           | Options1    |
|           | Options2    |
|           | Language    |

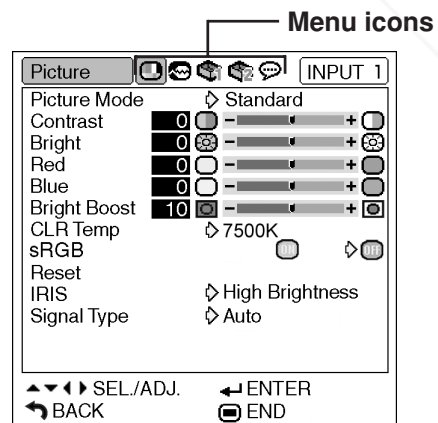

#### Note

- The “Fine Sync” menu is not available for selecting INPUT 3 or INPUT 4.



### 3 Press ▲ or ▼ to select the item you want to adjust.

- The selected item is highlighted.

### To adjust the projected image while viewing it

Press .

- The selected single adjustment item (e.g. "Bright") appears instead of the menu.
- When pressing ▲ or ▼, the following item ("Red" after "Bright") will be displayed.



#### Note

- Press  to return to the previous screen.

### 4 Press ◀ or ▶ to adjust the item selected.

- The adjustment is stored.

### 5 Press .

- The menu screen will disappear.

Single adjustment items

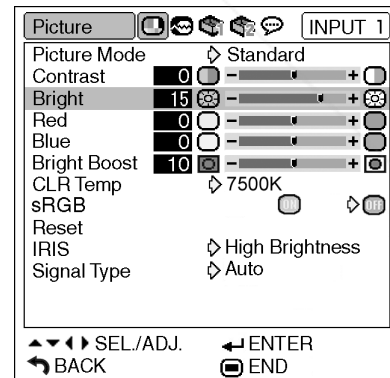
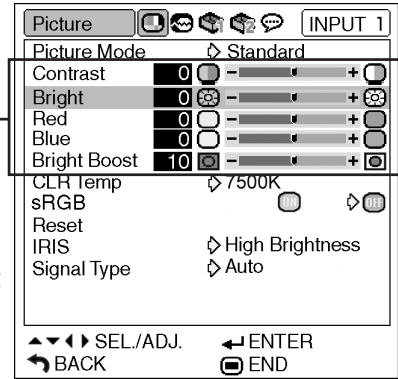



## Using the Menu Screen

The menu can be operated to achieve two functions, adjustments and settings. (For adjusting the menu items, see pages 40 and 41.)

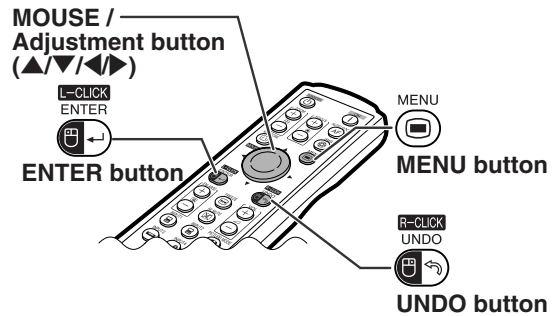

## Menu Selections (Settings)

### Example: Setting "Menu Position"

• This operation can also be performed by using the buttons on the projector.

**1** Press .



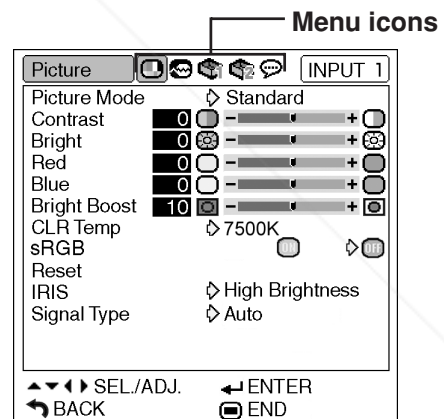

- The "Picture" menu screen for the selected input mode is displayed.

### Example: "Picture" screen menu for INPUT 1 (RGB) mode



**2** Press  or  to display the other menu screens.

- The menu icon for the selected menu screen is highlighted.

| Menu icon   | Menu screen |
|---|-------------|
|  | Picture     |
|  | Fine Sync   |
|  | Options1    |
|  | Options2    |
|  | Language    |

### Example: "Options1" screen menu

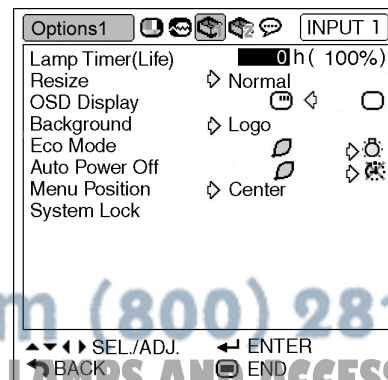

 **Note**

- The "Fine Sync" menu is not available for selecting INPUT 3 or INPUT 4.



**3** Press ▲ or ▼ to select the item you want to set, and then press ► to display the sub menu.

- The selected item is highlighted.
- When you select “System Lock” on the “Options1” menu or “Password” on the “Options2” menu, press .

**Note**

- Press or ◀ to return to the previous screen.
- For some items, press ◀ or ▶ to select the icon using “◄”.

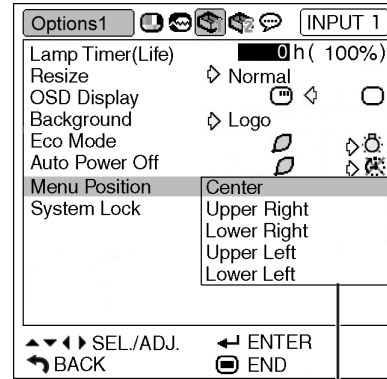

Sub menu

**4** Press ▲ or ▼ to select the setting of the item displayed in the sub menu.

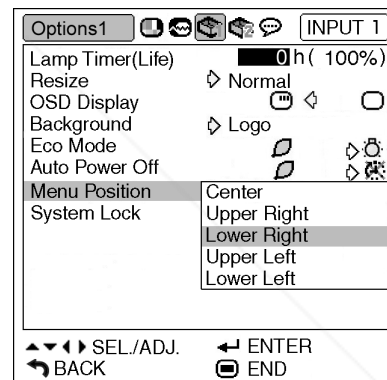

**5** Press .

- The selected item is set.

**6** Press .

- The menu screen will disappear.

Useful Features



# Picture Adjustment (“Picture” menu)

You can adjust the projector’s picture to your preferences using the “Picture” menu.

## Selecting the Picture Mode

This function allows you to select the picture mode in accordance with brightness of the room or content of the image to be projected. In all picture modes, items on the “Picture” menu can be adjusted and saved.

Menu operation ➔ Page 42

Example: “Picture” screen menu for INPUT 1 (RGB) mode

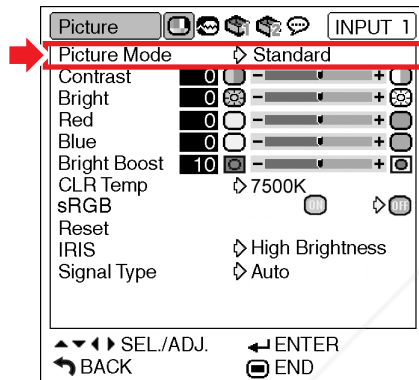

### Description of Picture Modes

| Selectable items | Description   |
|------------------|---|
| Standard         | For standard image  |
| Presentation     | Brightens darker portions of image for more enhanced presentations.                     |
| Cinema           | Gives greater depth to darker portions of image for a more exciting theater experience. |
| Game             | For natural color gradation for playing a game, etc.                                    |

#### Note

- You can also press  on the remote control to select the picture mode. (See page 35.)

## Adjusting the Image

Select a picture mode before adjusting the image.

Menu operation ➔ Page 40

Example: “Picture” screen menu for INPUT 1 (RGB) mode

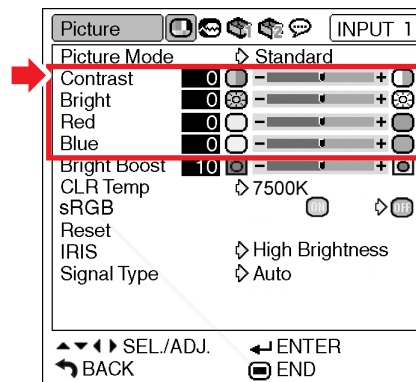

### Description of Adjustment Items

| Selectable items   | Press ◀                        | Press ▶                        |
|--------------------|--------------------------------|--------------------------------|
| Contrast           | For less contrast              | For more contrast              |
| Bright             | For less brightness            | For more brightness            |
| Color <sup>1</sup> | For less color intensity       | For more color intensity       |
| Tint <sup>1</sup>  | For making skin tones purplish | For making skin tones greenish |
| Sharp <sup>1</sup> | For less sharpness             | For more sharpness             |
| Red <sup>2</sup>   | For weaker red                 | For stronger red               |
| Blue <sup>2</sup>  | For weaker blue                | For stronger blue              |

<sup>1</sup> “Color”, “Tint” and “Sharp” are not displayed when selecting INPUT 1/INPUT 2 and setting the “Signal Type” to “RGB” or setting the “Signal Type” to “Auto” and the input signal is recognized as an RGB signal.

<sup>2</sup> “Red” and “Blue” cannot be adjusted when “sRGB” is set to  (ON).

#### Note

- “Sharp” can be adjusted when 480I, 480P, 540P, 576I, 576P, 720P, 1035I or 1080I signals are detected while “Signal Type” for INPUT 1 or INPUT 2 is set to “Component” or set to “Auto” and the input signal is recognized as a component signal.
- To reset all adjustment items, select “Reset” and press .



## Emphasizing the Contrast

This function emphasizes the bright portions of images to obtain a higher contrast image.

Menu operation ➔ Page 40

Example: "Picture" screen menu for INPUT 1 (RGB) mode

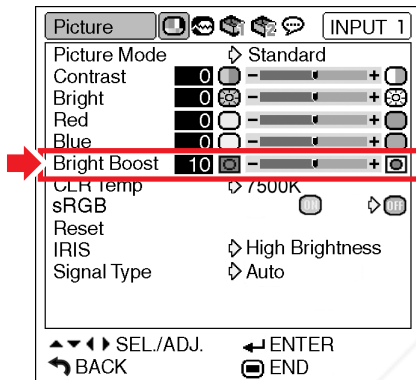

### Description of Bright Boost Setting

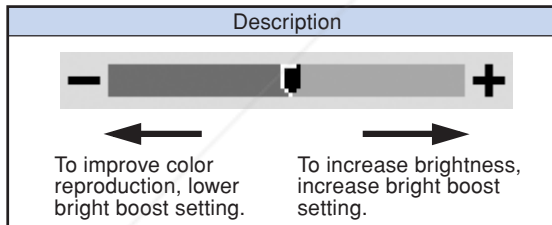

#### Note

- "Bright Boost" cannot be set when "sRGB" is set to "ON" (ON).

## Adjusting the Color Temperature

Menu operation ➔ Page 42

Example: "Picture" screen menu for INPUT 1 (RGB) mode

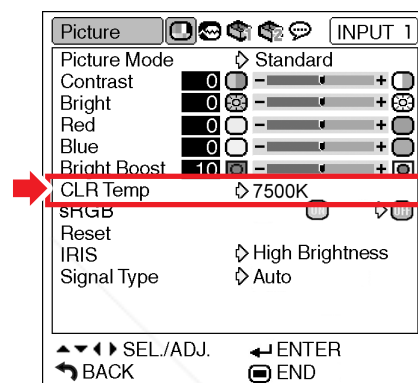

### Description of Color Temperature Settings

| Selectable items | Description   |
|------------------|---|
| 5500K            | For lower color temperature for warmer, reddish incandescent-like images. |
| 6500K            |   |
| 7500K            |   |
| 8500K            | For higher color temperature for cooler, bluish, fluorescent-like images. |
| 9300K            |   |
| 10500K           |   |

#### Note

- Values on "CLR Temp" are only for general standard purposes.
- "CLR Temp" cannot be set when "sRGB" is set to "ON" (ON).

## Picture Adjustment (“Picture” menu)

### sRGB Setting



When you want to display the image in a natural tint based on an original image from the computer, select “sRGB” and set it to “” (ON).

Menu operation ➔ Page 42

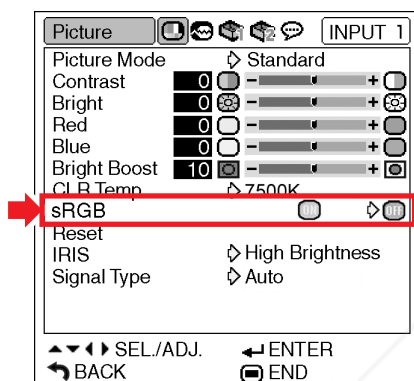
Example: “Picture” screen menu for INPUT 1 (RGB) mode



#### Note

- An international standard of color reproduction regulated by the IEC (International Electrotechnical Commission). As the fixed color area has been decided by the IEC, the images are displayed in a natural tint based on an original image, when “sRGB” is set to “” (ON).
- You cannot set the items, “Red”, “Blue”, “CLR Temp”, “Bright Boost” on the “Picture” menu, when “sRGB” is set to “” (ON).
- For additional information about the sRGB function, visit “<http://www.srgb.com/>”.

#### Info

When “sRGB” is set to “” (ON), the projected image may become dark, but this does not indicate a malfunction.

### Switching the High Brightness/High Contrast Mode

This function changes the brightness and contrast of the projected image. It can be operated using the IRIS button on the remote control.

Menu operation ➔ Page 42

Example: “Picture” screen menu for INPUT 1 (RGB) mode

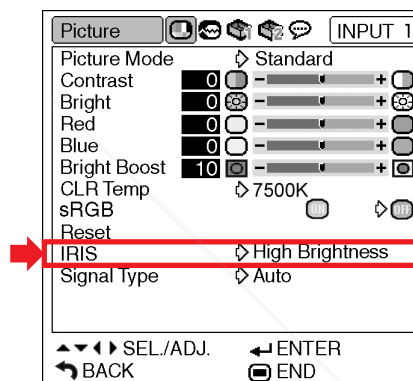

#### Description of IRIS Settings

| Selectable items | Description   |
|------------------|---|
| High Brightness  | High brightness is given priority over high contrast. |
| High Contrast    | High contrast is given priority over high brightness. |

## Signal Type Setting

This function allows you to select the input signal type RGB or Component for INPUT 1 or INPUT 2.

Menu operation ➔ Page 42

Example: "Picture" screen menu for INPUT 1 (RGB) mode

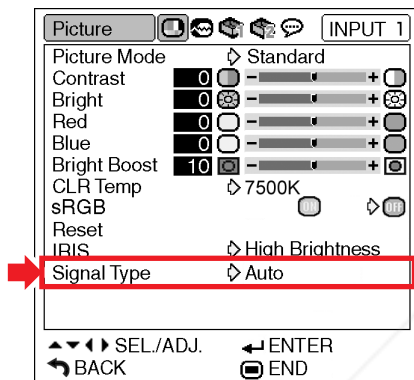

### Description of Signal Type Settings

| Selectable items | Description   |
|------------------|---|
| Auto             | Input signals are automatically recognized as RGB or Component. |
| RGB              | Set when RGB signals are received.                              |
| Component        | Set when Component signals are received.                        |

# Computer Image Adjustment (“Fine Sync” menu)

You can adjust the computer image, match the computer display mode, and confirm the input signal using the “Fine Sync” menu.

## Adjusting the Computer Image

Use the Fine Sync function in case of irregularities such as vertical stripes or flickering in portions of the screen.

Menu operation ➔ Page 40

Example: “Fine Sync” screen menu for INPUT 1 (RGB) mode

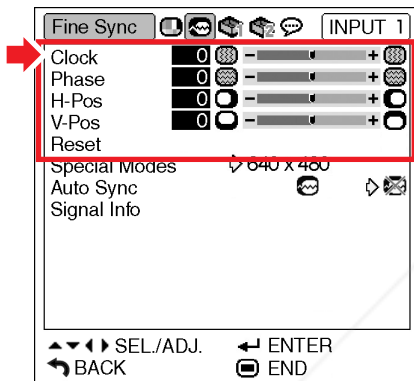

### Description of Adjustment Items

| Selectable items | Description  |
|------------------|--|
| Clock            | Adjusts vertical noise.  |
| Phase            | Adjusts horizontal noise (similar to tracking on your VCR).    |
| H-Pos            | Centers the on-screen image by moving it to the left or right. |
| V-Pos            | Centers the on-screen image by moving it up or down.           |

#### Note

- You can automatically adjust the computer image by setting “Auto Sync” on the “Fine Sync” menu to (ON) or pressing on the projector or on the remote control. See next page for details.
- To reset all adjustment items, select “Reset” and press .

## Special Modes Setting

Ordinarily, the type of input signal is detected and the correct resolution mode is automatically selected. However, for some signals, the optimal resolution mode in “Special Modes” on the “Fine Sync” menu may need to be selected to match the computer display mode.

Menu operation ➔ Page 42

Example: “Fine Sync” screen menu for INPUT 1 (RGB) mode

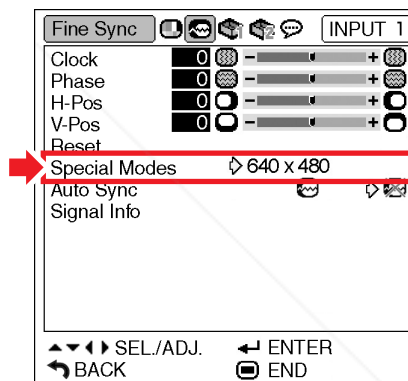

#### Note

- If your computer displays patterns which repeat every other line (horizontal stripes), flickering may occur which makes the image hard to see.
- See “Checking the Input Signal” on the next page for information on the currently selected input signal.

## Auto Sync Adjustment

Used to automatically adjust a computer image.

Menu operation ➔ Page 42

Example: “Fine Sync” screen menu for INPUT 1 (RGB) mode

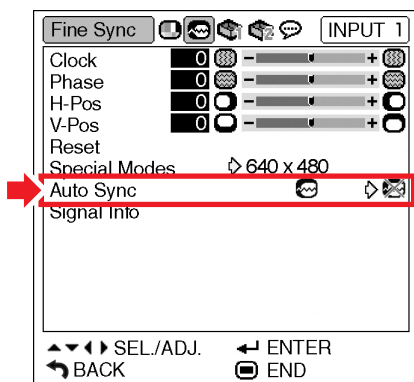

### Description of Auto Sync Adjustment

| Selectable items | Description   |
|------------------|---|
| (ON)             | Auto Sync adjustment will occur when the projector is turned on or when the input signals are switched, when connected to a computer. |
| (OFF)            | Auto Sync adjustment is not automatically performed.  |

#### Note

- Auto Sync adjustment is also performed by pressing on the projector or on the remote control.
- The Auto Sync adjustment may take some time to complete, depending on the image of the computer connected to the projector.
- When the optimum image cannot be achieved with Auto Sync adjustment, use manual adjustments. (See page 31.)

## Checking the Input Signal

Menu operation ➔ Page 42

Example: “Fine Sync” screen menu for INPUT 1 (RGB) mode

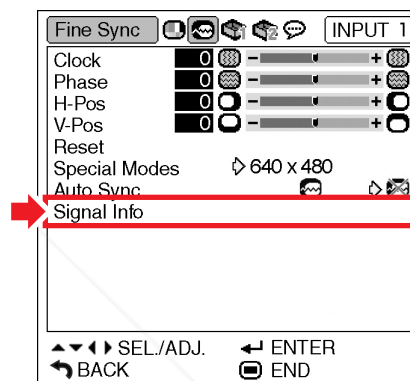

#### Note

- The projector will display the number of scanned lines available from audio-visual equipment such as a DVD player or Digital Video.
- The projector will display the resolution when connecting the computer.

# Using the “Options1” Menu

You can use the “Options1” menu to enhance the usage for the projector.

## Checking the Lamp Life Status

You can confirm the cumulative lamp usage time and the remaining lamp life (percentage).

Menu operation ➡ Page 42

Example: “Options1” screen menu for INPUT 1 (RGB) mode

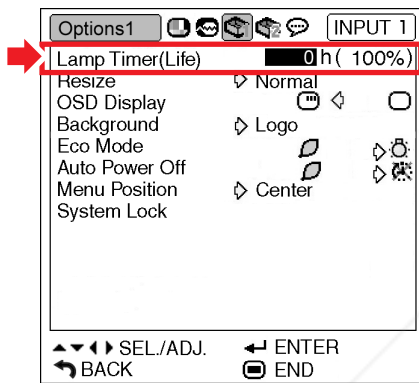

### Description of Lamp Life

| Lamp usage condition                                  | Remaining lamp life |                   |
|---|---------------------|-------------------|
|   | “Life”              | “Life”            |
|   | 100%                | 5%                |
| Operated exclusively in Eco mode (Eco icon)           | Approx. 3,000 hours | Approx. 150 hours |
| Operated exclusively in Standard mode (Standard icon) | Approx. 2,000 hours | Approx. 100 hours |

#### Note

- It is recommended that the lamp be changed when the remaining lamp life becomes 5%.
- The table above indicates rough estimates in the case of using only in each mode shown.
- Remaining lamp life changes within the range of the values shown depending on the frequency at which the “Eco Mode” is switched to “Eco mode” and “Standard mode”. (See page 52.)
- The lamp life may vary depending on the usage condition.

## Setting the Resize Mode

Depending on the input signal, you can select the screen image.

Menu operation ➡ Page 42

Example: “Options1” screen menu for INPUT 1 (RGB) mode

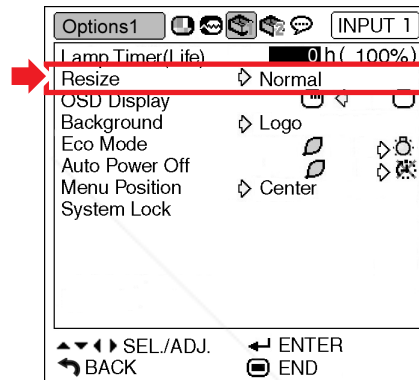

### Selectable items of Resize Modes

- Normal
- Dot By Dot\*
- Border
- Stretch

\*Item when inputting RGB signal through INPUT 1 or INPUT 2

#### Note

- For details of the Resize mode, see pages 36 and 37.
- You can also press  on the remote control to set the resize mode. (See page 36.)



## Setting On-screen Display

This function allows you to turn the on-screen messages on or off.

Menu operation ➔ Page 42

Example: “Options1” screen menu for INPUT 1 (RGB) mode

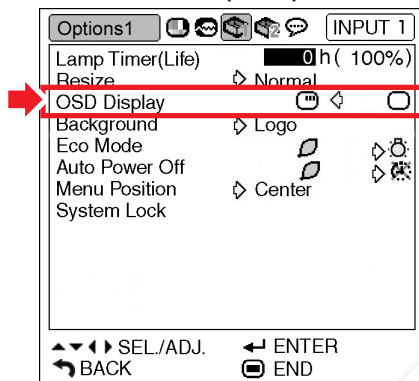

### Description of “OSD Display” Settings

| Selectable items                         | Description   |
|--|---|
| <input checked="" type="checkbox"/> (ON) | All On-screen Displays are displayed.   |
| <input type="checkbox"/> (OFF)           | <ul style="list-style-type: none"> <li>INPUT/VOLUME/AV MUTE/FREEZE/AUTO SYNC/ENLARGE/ “An invalid button has been pressed.” are not displayed.</li> <li>“All buttons on Projector are locked.” is displayed when the STANDBY button is pressed while the Keylock function is active.</li> </ul> |

## Setting the Video System

The video input system mode is factory preset to “Auto”; however, a clear picture from the connected audio-visual equipment may not be received, depending on the video signal difference. In that case, switch the video signal.

Menu operation ➔ Page 42

Example: “Options1” screen menu for INPUT 3 (Video) mode

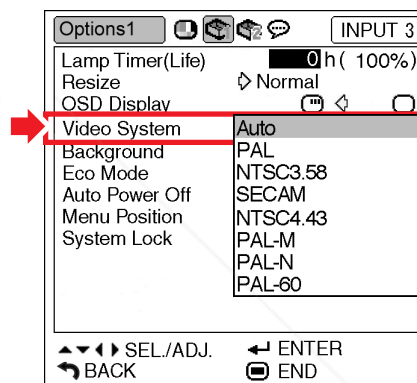

### Description of Video Systems

| Selectable items | Description   |
|------------------|---|
| PAL              | When connected to PAL video equipment.                |
| SECAM            | When connected to SECAM video equipment.              |
| NTSC4.43         | When reproducing NTSC signals in PAL video equipment. |
| NTSC3.58         | When connected to NTSC video equipment.               |

### Note

- The video signal can only be set in INPUT 3 or INPUT 4 mode.
- When the system mode is set to “Auto”, you may not receive a clear picture due to signal differences. Should this occur, switch to the video system of the source signal.



## Using the “Options1” Menu

### Selecting a Startup and Background Image

Menu operation ➔ Page 42

Example: “Options1” screen menu for INPUT 1 (RGB) mode

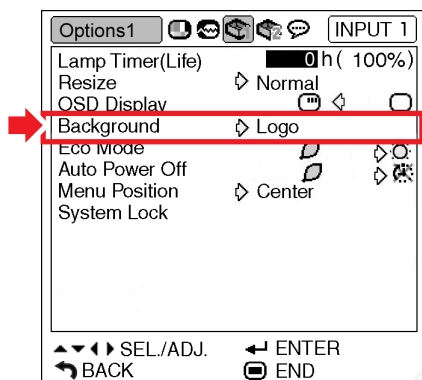

#### Description of Background Images

| Selectable items | Description         |
|------------------|---------------------|
| Logo             | SHARP default image |
| Blue             | Blue screen         |
| None             | Black screen*       |

#### Note

\* If the input signal has interference, the screen will be displayed during interference.

### Eco Mode

Menu operation ➔ Page 42

Example: “Options1” screen menu for INPUT 1 (RGB) mode

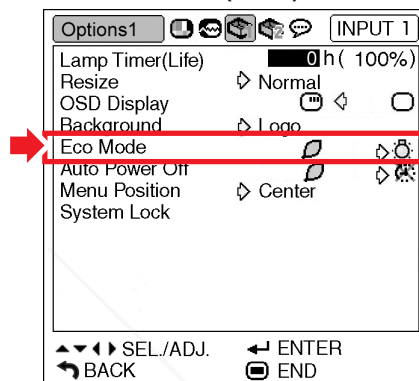

#### Description of Eco Mode

| Selectable items | Brightness | Power consumption (When using AC 100V) | Lamp life           |
|------------------|------------|--|---------------------|
| (Eco mode)       | 87%        | 320 W                                  | Approx. 3,000 hours |
| (Standard mode)  | 100%       | 370 W                                  | Approx. 2,000 hours |

#### Note

• When “Eco Mode” is set to “” (ON), the power consumption will decrease and the lamp life will extend. (Projection brightness decreases 13%.)

## Auto Power Off Function

Menu operation ➔ Page 42

Example: “Options1” screen menu for INPUT 1 (RGB) mode

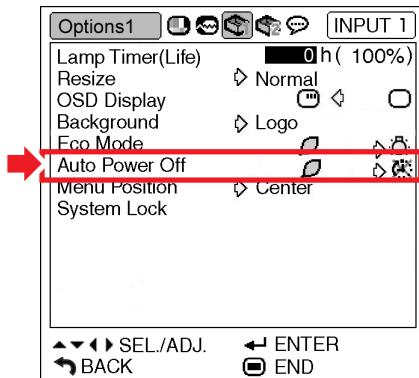

### Description of Auto Power Off

| Selectable items | Description  |
|------------------|--|
| (ON)             | The projector automatically enters the standby mode when no input signal is detected for 15 minutes or longer. |
| (OFF)            | The Auto Power Off function will be disabled.  |

#### Note

- When the Auto Power Off function is set to “” (ON), 5 minutes before the projector enters the standby mode, the message “Enter STANDBY mode in X min.” will appear on the screen to indicate the remaining minutes.

## Selecting the Menu Screen Position

Select “Menu Position” on the “Options1” menu and the desired position for the menu screen.

Menu operation ➔ Page 42

Example: “Options1” screen menu for INPUT 1 (RGB) mode

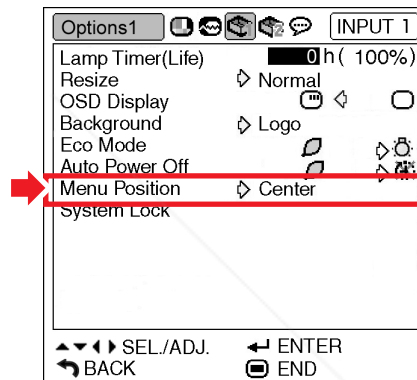

### Description of Menu Positions

| Selectable items | Description                                |
|------------------|--|
| Center           | Displayed on the center of the image.      |
| Upper Right      | Displayed on the upper right of the image. |
| Lower Right      | Displayed on the lower right of the image. |
| Upper Left       | Displayed on the upper left of the image.  |
| Lower Left       | Displayed on the lower left of the image.  |

## Using the “Options1” Menu

### System Lock Function

This function prevents unauthorized use of the projector. Once this function is activated, users must enter the correct keycode each time the projector is turned on. We suggest you record the keycode in a safe place where only authorized users have access.

#### Info

- If you lose or forget your keycode, contact your nearest Sharp Authorized Projector Dealer or Service Center (see page 72). Even if the product warranty is valid, the keycode reset will incur a charge.

Menu operation ➔ Page 42

Example: “Options1” screen menu for INPUT 1 (RGB) mode

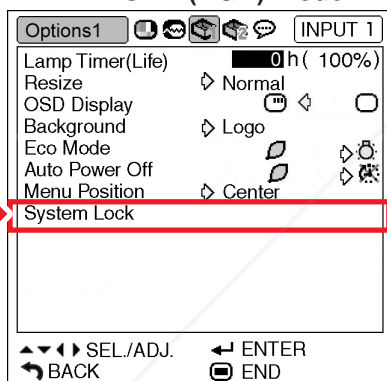

### Setting the keycode

**1** Select “System Lock” on the “Options1” menu, then press .

- A message is displayed.
- Read this message, and press .

**2** Press the 4 buttons on the remote control or on the projector to enter the preset keycode in “Old Code”.

- When setting the keycode for the first time, press ▼ on the projector for four times.
- ▼ On-screen Display

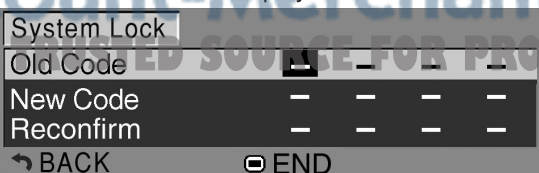

#### Note

- If you input a wrong keycode, the cursor returns to the first point of the “Old Code”.
- The preset keycode is 4 ▼ buttons on the projector. If this keycode is set, the keycode input screen does not appear when turning the power on.

**3** Press the 4 buttons on the remote control or on the projector to enter the new keycode in “New Code”.

#### Note

- You cannot use the following buttons for keycode:
  - ON button
  - STANDBY button
  - L-CLICK/ENTER button
  - R-CLICK/UNDO button
  - MENU button
  - AUTO FOCUS button
  - ZOOM/FOCUS button
  - ZOOM buttons
  - FOCUS buttons
- System Lock function recognizes each button on the remote control or on the projector as an individual button, even if they share the same button name. If you set the keycode with the buttons on the projector, use only those buttons on the projector. If you set the keycode with the buttons on the remote control, use only those buttons on the remote control.**

**4** Enter the same keycode in “Reconfirm”.

#### Note

**Not displaying the keycode input screen when turning the projector on**

- Press ▼ on the projector for four times in steps 2 and 3 above.

**When the System Lock is set**

- When System Lock is set, the keycode input screen appears after the power is turned on. When it appears, enter the right keycode to start projection. Failure to enter the keycode will cause images not to be projected even when signals are entered to the projector.

GB-54



## Changing the keycode

|             |   |       |   |   |
|-------------|---|-------|---|---|
| System Lock |   |       |   |   |
| Old Code    | - | -     | - | - |
| New Code    | - | -     | - | - |
| Reconfirm   | - | -     | - | - |
| ← BACK      |   | END → |   |   |

**1** Press the buttons on the remote control or on the projector to enter the preset keycode in “Old Code”.

**2** Press the 4 buttons on the remote control or on the projector to enter the new keycode in “New code”.

**3** Enter the same keycode in “Reconfirm”.

### Note

- If you do not want to set a keycode, leave the keycode field blank in steps 2 and 3 and press



## When System Lock is set



If you have set the system lock, enter the keycode and follow the procedure below to release the system lock.

▼Input screen for keycode

|             |   |   |   |   |
|-------------|---|---|---|---|
| System Lock | - | - | - | - |
|-------------|---|---|---|---|

### Note

- When System Lock is set, the keycode input screen appears after the power is turned on.
- If no keycode is entered, the image will not be displayed, even if the projector receives the input signal.

**1** Press  on the remote control or  on the projector to turn on the projector.

**2** When the keycode input screen appears, enter the right keycode to start projection.

### Note

- System Lock function recognizes each button on the remote control or on the projector as an individual button, even if they share the same button name. If you set the keycode with the buttons on the projector, use only those buttons on the projector. If you set the keycode with the buttons on the remote control, use only those buttons on the remote control.

## Keylock Function

Use this function to lock the operation buttons on the projector.

### ■ Locking the Operation Buttons

Hold down  on the projector for about 3 seconds while the projector is being turned on.

### ▼On-screen Display

Keylock function ON

- The keylock function does not affect the operation with the remote control buttons.
- You cannot use the keylock function while the projector is warming up.

### ■ Taking the Keylock off

Hold down  on the projector for about 3 seconds.

### ▼On-screen Display

Keylock function OFF

- When the projector is in standby mode, you can release the keylock by holding down  on the projector for about 3 seconds.

# Helpful Functions Set during Installation (“Options2” menu)

## Setting a Password

- There is no factory preset for the password, so the "Options2" menu is enabled.
- If you do not want others to operate the "Options2" menu, set a password.

Menu operation ➔ Page 42

Example: “Options2” screen menu

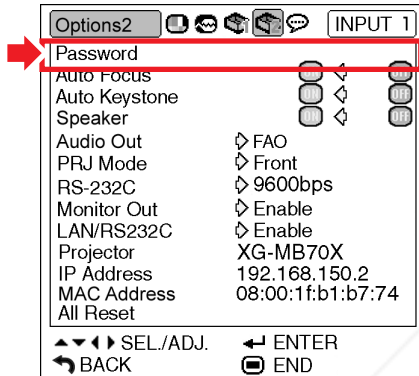

**1** Select "Password" from the "Options2" menu, and press . The screen for entering the password is displayed.

**2** Press or to set the first digit in "New Password" and then press .

**3** Enter the remaining 3 digits and press .

**4** Enter the same password in "Reconfirm" and press .

### Note

- The password must be entered to use the "Options2" menu when a password has been set.

## Changing the Password



**1** Press , and to enter the password in "Old Password" and press .

**2** Press , and to set the new password in "New Password" and press .

**3** Enter the same 4-digit password in "Reconfirm" and press .

### Note

- If you do not want to set a password, leave the fields blank in steps 2 and 3 and press .
- To cancel the password settings, press .

## If You Forget Your Password

If you forget the password, delete it using the following procedure and set a new password.

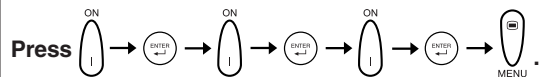

### Note

- If is held down for more than 3 seconds, the operation buttons on the projector will be locked. (See page 55.)
- You can only use the buttons on the projector to delete the password.

## Auto Focus Setting

When the projector is turned on, the focus pattern is displayed automatically and the focus is adjusted automatically.

Menu operation ➔ Page 42

Example: "Options2" screen menu

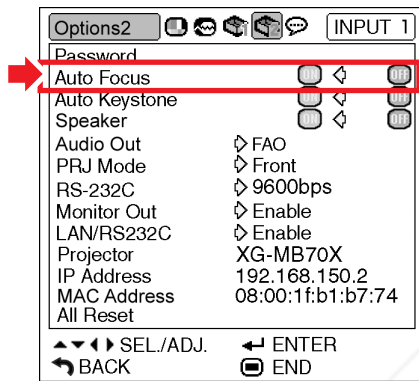



### Description of Auto Focus

| Selectable items                      | Description  |
|---------------------------------------|--|
| <input checked="" type="radio"/> (ON) | Focus is adjusted automatically when the power is turned on.     |
| <input type="radio"/> (OFF)           | Focus is not adjusted automatically when the power is turned on. |

#### Note

- Auto Focus can be performed over a range of 40 to 100 inches.
- The ability to adjust the focus automatically depends on the status of the screen and the surrounding brightness.
- When the distance between the projector and the screen does not change (fixing installation), it is recommended that "Auto Focus" is set to "OFF".

• The Auto Focus function can be used with  on the projector or with  on the remote control.

Adjust the focus manually when the focus is not adjusted with Auto Focus or when you want to make fine adjustments.

## Auto Keystone Setting

When the image is projected either from the top or from the bottom towards the screen at an angle, the image becomes distorted trapezoidally. This trapezoidal distortion is corrected automatically.

Menu operation ➔ Page 42

Example: "Options2" screen menu

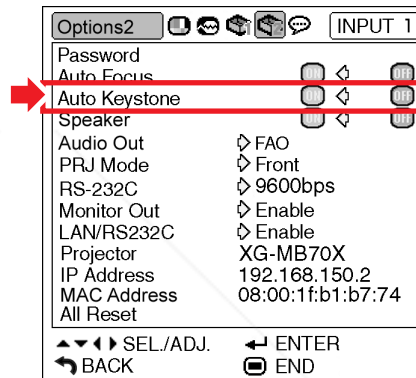

### Description of Auto Keystone

| Selectable items                      | Description  |
|---------------------------------------|--|
| <input checked="" type="radio"/> (ON) | The projected image is corrected trapezoidal distortion automatically.     |
| <input type="radio"/> (OFF)           | The projected image is not corrected trapezoidal distortion automatically. |

#### Note

- Trapezoidal distortion can be corrected with the Auto Keystone Correction function for angles up to about 12 degrees vertically with respect to the screen.
- When the screen is slanting or the image is deteriorated, set "Auto Keystone" to "OFF".
- You can make corrections manually when you want to make fine adjustments after the Auto Keystone Correction function has been activated. (See page 31.)

## Helpful Functions Set during Installation (“Options2” menu)

### Speaker Setting

This function allows you to set the audio output of the internal speaker to “ON” or “OFF” such as when the projector is connected to an external amplifier.

Menu operation ➔ Page 42

Example: “Options2” screen menu

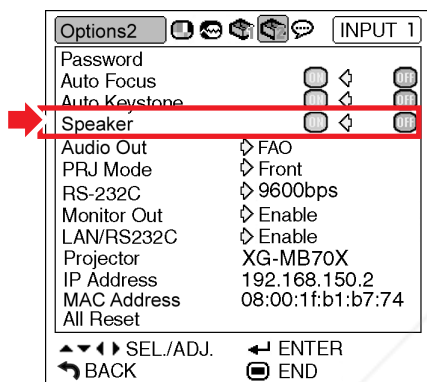

#### Description of Speaker Settings

| Selectable items            | Description   |
|-----------------------------|---|
| <input type="radio"/> (ON)  | The audio signal is output from the internal speaker.     |
| <input type="radio"/> (OFF) | The audio signal is not output from the internal speaker. |

### Setting the Audio Output Type

This function determines whether the audio level output from the AUDIO OUTPUT terminal is fixed or variable by linking with VOLUME.

Menu operation ➔ Page 42

Example: “Options2” screen menu

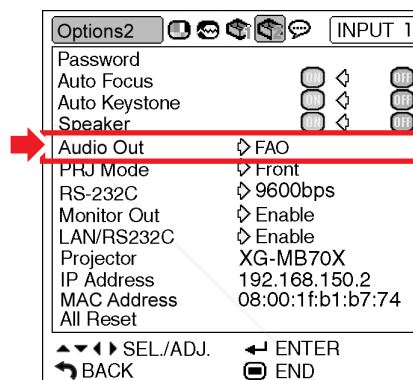

#### Description of Audio Out Settings

| Selectable items            | Description  |
|-----------------------------|--|
| FAO (Fixed Audio Output)    | Audio output that does not vary in strength with the volume level of the source projector. |
| VAO (Variable Audio Output) | Audio output that varies in strength with the volume level of the source projector.        |

#### Info

- When “Audio Out” has been set to “VAO”, first make sure to lower the volume of the projector before turning the power on or off and when switching the input.

## Reversing/Inverting Projected Images

This projector is equipped with a reverse/invert image function that allows you to reverse or invert the projected image for various applications.

Menu operation ➔ Page 42

### Example: "Options2" screen menu

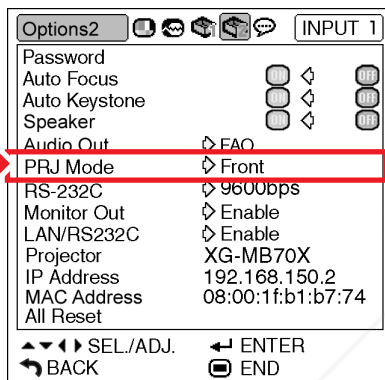

### Description of PRJ Modes

| Selectable items | Description                 |
|------------------|-----------------------------|
| Front            | Normal image                |
| Ceiling + Front  | Inverted image              |
| Rear             | Reversed image              |
| Ceiling + Rear   | Reversed and inverted image |

#### Note

- This function is used for the reversed image and ceiling-mount setups. (See page 20.)

## Selecting the Transmission Speed (RS-232C)

Make sure that both the projector and computer are set for the same baud rate.

Menu operation ➔ Page 42

### Example: "Options2" screen menu

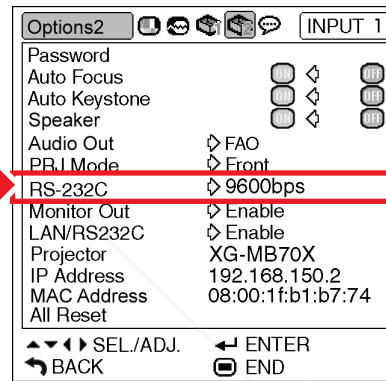

### Description of RS-232C

| Selectable items | Description                  |
|------------------|------------------------------|
| 9600 bps         | Transmission speed is slow.  |
| 115200 bps       | Transmission speed is rapid. |

#### Note

- Refer to the "SETUP GUIDE" contained on the supplied CD-ROM for RS-232C Specifications and Command Settings.
- Refer to the computer's operation manual for instructions for setting the computer's baud rate.



## Helpful Functions Set during Installation (“Options2” menu)

### Monitor Output Settings

When the Monitor Out has been set to “Enable”, the monitor output is activated and power is consumed even in the standby mode. It is recommended that the Monitor Out be set to “Disable” when it is not connected. This reduces power consumption when the projector is in the standby mode.

Menu operation ➔ Page 42

Example: “Options2” screen menu

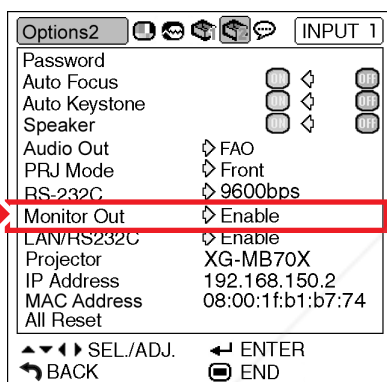

#### Description of Monitor Out

| Selectable items | Description  |
|------------------|--|
| Enable           | The monitor output function is activated even if the projector is in standby mode. |
| Disable          | The monitor output function is switched off when the projector is in standby mode. |

### LAN/RS232C Setting

When the LAN/RS232C has been set to “Enable”, the LAN/RS232C is activated and power is consumed even in the standby mode. It is recommended that the LAN/RS232C be set to “Disable” when it is not connected. This reduces power consumption when the projector is in the standby mode.

Menu operation ➔ Page 42

Example: “Options2” screen menu

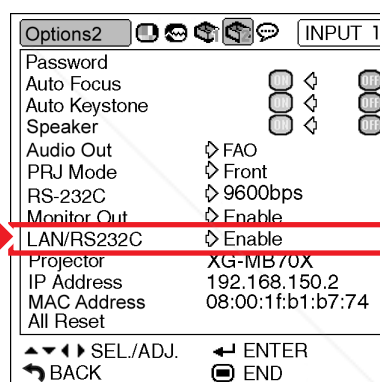

#### Description of LAN/RS232C

| Selectable items | Description  |
|------------------|--|
| Enable           | The LAN/RS232C function is activated even if the projector is in standby mode. |
| Disable          | The LAN/RS232C function is switched off when the projector is in standby mode. |

#### Note

- When you want to control the projector using the LAN/RS-232C function, set “Enable.”

## Confirming the Network Information for the Projector

You can confirm the projector name, IP address and MAC address.

Menu operation ➔ Page 42

Example: “Options2” screen menu

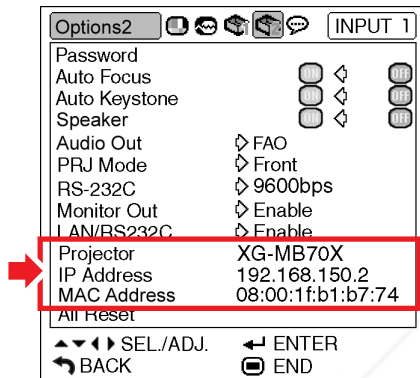

### Description of Network Information

| Displayed items | Description   |
|-----------------|---|
| Projector       | The projector name is displayed.<br>(Factory preset : XG-MB70X)                       |
| IP Address      | The IP address set for the projector is displayed.<br>(Factory preset :192.168.150.2) |
| MAC Address     | The MAC address of the projector is displayed.  |

#### Note

- For information on how to change the projector name and IP address, see “SETUP GUIDE” contained in the supplied CD-ROM.

## Returning to the Default Settings

This function allows you to initialize the settings you have made in the projector.

Menu operation ➔ Page 42

Example: “Options2” screen menu

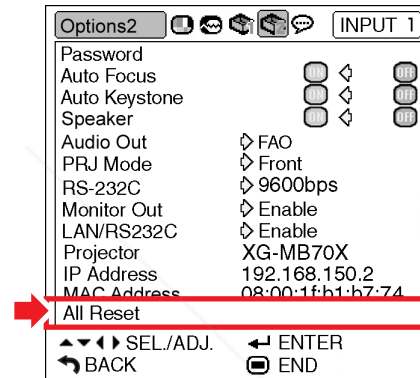

#### Note

About the network settings

- “Projector” and “IP Address” on the “Options2” menu and the network setting items described on the “SETUP GUIDE” are initialized.

The following items or menu cannot be initialized.

- Special Modes (“Fine Sync” menu)
- Lamp Timer (Life), System Lock (“Options1” menu)
- “Language” menu





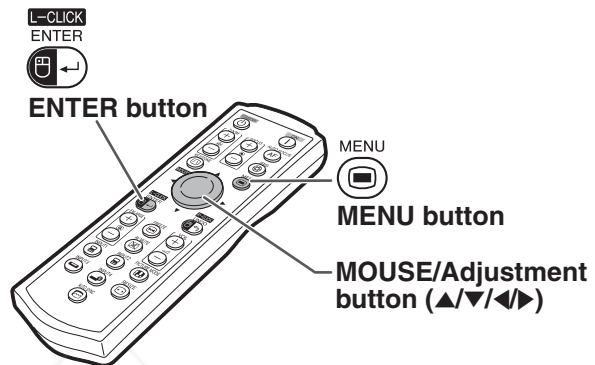

# Using the “Language” Menu

## Selecting the On-screen Display Language

The projector can switch the on-screen display language among 11 languages: English, German, Spanish, Dutch, French, Italian, Swedish, Portuguese, Chinese, Korean or Japanese.

Example: “Language” screen menu for INPUT 1 (RGB) mode



- 1** Press  on the remote control.
  - The “Picture” menu will be displayed.
- 2** Press  or  to select the “Language” menu icon ().
  - The “Language” menu will be displayed.
- 3** Press  or  to select the desired language, and then press .
  - The language you selected will be set as the on-screen display.

- 4** Press .
  - The “Language” menu will disappear.

### Note

This procedure can also be performed by using the buttons on the projector.

# Maintenance

## Cleaning the projector

- Ensure the power cord is unplugged before cleaning the projector.
- The cabinet as well as the operation panel is made of plastic. Avoid using benzene or thinner, as these can damage the finish on the cabinet.
- Do not use volatile agents such as insecticides on the projector.

Do not attach rubber or plastic items to the projector for long periods.

The effects of some of the agents in the plastic may cause damage to the quality or finish of the projector.

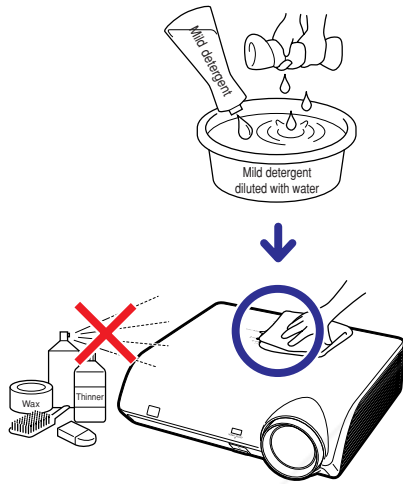

- Wipe off dirt gently with a soft flannel cloth.
- When the dirt is hard to remove, soak a cloth in a mild detergent diluted with water, wring the cloth well and then wipe the projector. Strong cleaning detergents may discolor, warp or damage the coating on the projector. Make sure to test on a small, inconspicuous area on the projector before use.

## Cleaning the lens

- Use a commercially available blower or lens cleaning paper (for glasses and camera lenses) for cleaning the lens. Do not use any liquid type cleaning agents, as they may wear off the coating film on the surface of the lens.
- As the surface of the lens can easily get damaged, ensure not to scrape or hit the lens.

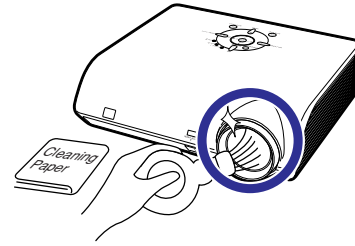

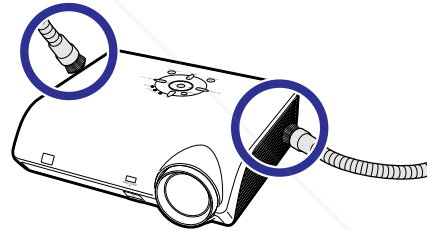

## Cleaning the exhaust and intake vents

- Use a vacuum cleaner to clean dust from the exhaust vent and the intake vent.



### Info

- If you want to clean the air vents during projector operation, ensure to press  on the projector or  on the remote control and put the projector into standby mode. After the cooling fan has stopped, unplug the power cord from the AC socket and clean the vents.

# Maintenance Indicators

- The warning lights on the projector indicate problems inside the projector.
- If a problem occurs, either the temperature indicator or the lamp indicator will illuminate red, and the projector will enter the standby mode. After the projector has entered the standby mode, follow the procedures given below.

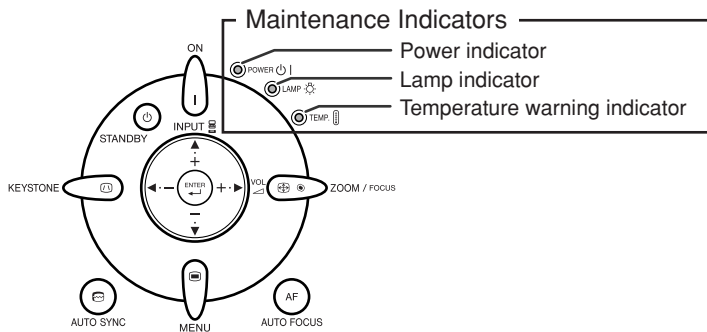

## About the temperature warning indicator



If the temperature inside the projector increases, due to blockage of the air vents, or the setting location, "TEMP." will illuminate in the lower left corner of the picture. If the temperature keeps on rising, the lamp will turn off and the temperature warning indicator will blink, the cooling fan will run for a further 90 seconds, and then the projector will enter the standby mode. After "TEMP." appears, ensure to perform the measures described on page 65.

## About the lamp indicator



- When the remaining lamp life becomes 5% or less, "Change The Lamp." (yellow) and "Change The Lamp." will be displayed on the screen. When the percentage becomes 0%, it will change to "Change The Lamp." (red), the lamp will automatically turn off and then the projector will automatically enter the standby mode. At this time, the lamp indicator will illuminate in red.
- If you try to turn on the projector a fourth time without replacing the lamp, the projector will not turn on.



| Maintenance indicator         |  |                  | Problem                                      | Cause   | Possible solution  |
|-------------------------------|--|------------------|--|---|--|
| Normal                        | Abnormal   |                  |  |   |  |
| Temperature warning indicator | Off  | Red on (Standby) | The internal temperature is abnormally high. | • Blocked air intake  | • Relocate the projector to an area with proper ventilation (see page 7).  |
|                               |  |                  |  | • Cooling fan breakdown<br>• Internal circuit failure<br>• Clogged air intake | • Take the projector to your nearest Sharp Authorized Projector Dealer or Service Center (see page 72) for repair.<br>• Clean the exhaust and intake vents. (See page 63.) |
| Lamp indicator                | Green on<br>Green blinks when the lamp is warming up or shutting down. | Red on           | The lamp does not illuminate.                | • The lamp is shut down abnormally.   | • Disconnect the power cord from the AC outlet, and then connect it again.   |
|                               |  |                  | Time to change the lamp.                     | • Remaining lamp life becomes 5% or less.                                     | • Carefully replace the lamp. (See page 67.)<br>• Take the projector to your nearest Sharp Authorized Projector Dealer or Service Center (see page 72) for repair.         |
|                               |  | Red on (Standby) | The lamp does not illuminate.                | • Burnt-out lamp<br>• Lamp circuit failure                                    | • Please exercise care when replacing the lamp.  |

### Info

- If the temperature warning indicator illuminates and the projector enters the standby mode, check whether any of the ventilation holes are blocked (page 7) and then try turning the power back on. Wait until the projector has cooled down completely before plugging in the power cord and turning the power back on. (At least 10 minutes.)
- If the power is turned off for a brief moment due to power outage or some other cause while using the projector, and the power supply recovers immediately after that, the lamp indicator will illuminate in red and the lamp may not be lit. In this case, unplug the power cord from the AC outlet, replace the power cord in the AC outlet and then turn the power on again.
- Do not unplug the power cord after the projector has entered the standby mode and while the cooling fan is running. The cooling fan runs for about 90 seconds.



## Regarding the Lamp

### Lamp

- It is recommended that the lamp (optional: AN-MB70LP) be replaced when the remaining lamp life becomes 5% or less, or when you notice a significant deterioration in the picture and color quality. The lamp life (percentage) can be checked with the on-screen display. See page 50.
- Purchase a replacement lamp of type AN-MB70LP from your place of purchase, nearest Sharp Authorized Projector Dealer or Service Center.

#### IMPORTANT NOTE TO U.S. CUSTOMERS:

The lamp included with this projector is backed by a 90-day parts and labor limited warranty. All service of this projector under warranty, including lamp replacement, must be obtained through a Sharp Authorized Projector Dealer or Service Center. For the name of the nearest Sharp Authorized Projector Dealer or Service Center, please call toll-free: 1-888-GO-SHARP (1-888-467-4277).

Hg LAMP CONTAINS MERCURY For State Lamp Disposal Information  
[www.lamprecycle.org](http://www.lamprecycle.org) or 1-800-BE-SHARP

U.S.A. ONLY

### Caution Concerning the Lamp

- This projector utilizes a pressurized mercury lamp. A loud sound may indicate lamp failure. Lamp failure can be attributed to numerous sources such as: excessive shock, improper cooling, surface scratches or deterioration of the lamp due to a lapse of usage time. The period of time up to failure largely varies depending on the individual lamp and/or the condition and the frequency of use. It is important to note that failure can often result in the bulb cracking.
- When the lamp replacement indicator and on-screen display icon are illuminated, it is recommended that the lamp be replaced with a new one immediately, even if the lamp appears to be operating normally.
- Should the lamp break, the glass particles may spread inside the lamp cage or gas contained in the lamp may be vented into the room from the exhaust vent. Because the gas in this lamp includes mercury, ventilate the room well if the lamp breaks and avoid all exposure to the released gas. In case of exposure to the gas, consult a doctor as soon as possible.
- Should the lamp break, there is also a possibility that glass particles may spread inside of the projector. In such a case, it is recommended you contact your nearest Sharp Authorized Projector Dealer or Service Center to assure safe operation.

### Replacing the Lamp

#### Caution

- Do not remove the lamp unit from the projector right after use. The lamp will be very hot and may cause burn or injury.
- Wait at least one hour after the power cord is disconnected to allow the surface of the lamp unit to fully cool before removing the lamp unit.
- Carefully change the lamp by following the instructions described in this section. \*If you wish, you may have the lamp replaced at your nearest Sharp Authorized Projector Dealer or Service Center.

\* If the new lamp does not illuminate after replacement, take your projector to the nearest Sharp Authorized Projector Dealer or Service Center for repair.



**Discount-Merchant.com (800) 281-8860**  
**THE TRUSTED SOURCE FOR PROJECTOR LAMPS AND ACCESSORIES**



## Removing and Installing the Lamp Unit

### Info

- Ensure the lamp unit is removed using the handle. Ensure the glass surface of the lamp unit or the inside of the projector are not touched.
- To avoid injury to yourself and damage to the lamp, ensure to carefully follow the steps below.
- Do not loosen other screws except for the lamp unit cover and lamp unit.

- 1 Press  on the projector or  on the remote control to put the projector into standby mode.

- Wait until the cooling fan stops.

### Warning!

- Do not remove the lamp unit from the projector right after use. The lamp and parts around the lamp will be very hot and may cause burn or injury.

- 2 Disconnect the power cord.
  - Unplug the power cord from the AC socket.
  - Leave the lamp until it has fully cooled down (about 1 hour).

- 3 Remove the lamp unit cover.
  - Turn the projector over. Loosen the user service screw (①) that secures the lamp unit cover. Pressing the tab, remove the lamp unit cover (②).

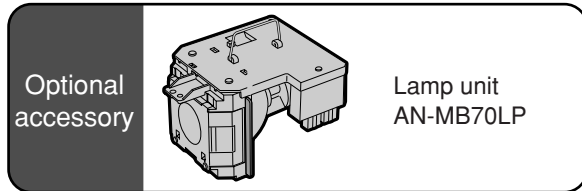

### STANDBY button

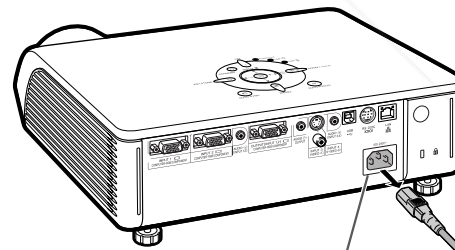
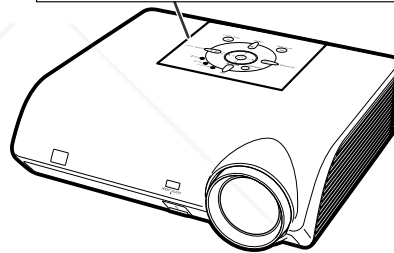
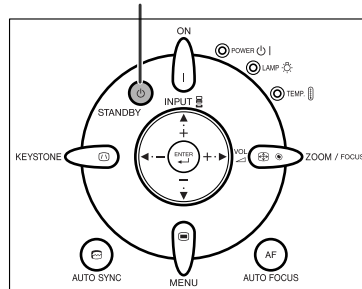

AC socket

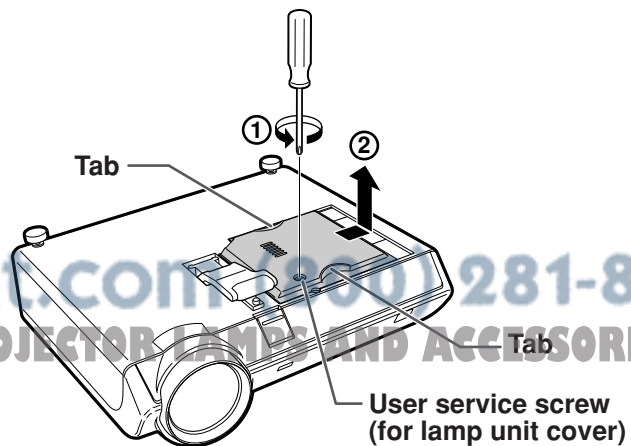



## Regarding the Lamp

### 4 Remove the lamp unit.

- Loosen the securing screws from the lamp unit. Hold the lamp unit by the handle and pull it in the direction of the arrow. At this time, keep the lamp unit horizontal and do not tilt it.

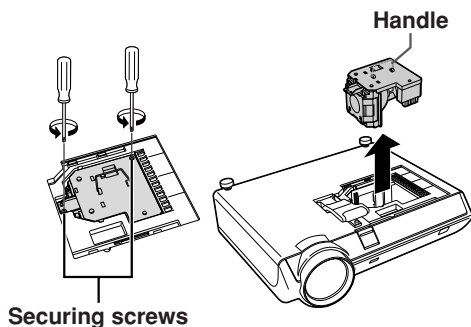

### 5 Insert the new lamp unit.

- Press the lamp unit firmly into the lamp unit compartment. Fasten the securing screws.

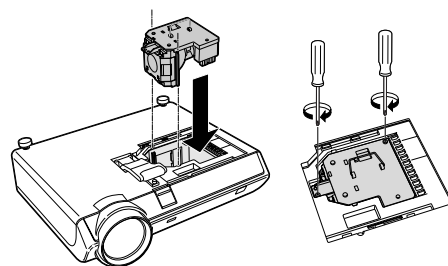

### 6 Replace the lamp unit cover.

- Align the lamp unit cover and slide it to close. Then tighten the user service screw to secure the lamp unit cover.

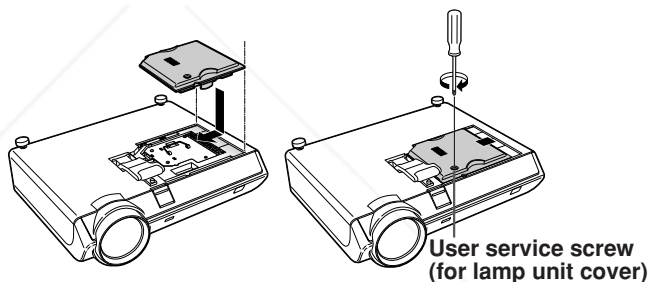

#### Info

- If the lamp unit and lamp unit cover are not correctly installed, the power will not turn on, even if the power cord is connected to the projector.

## Resetting the Lamp Timer

Reset the lamp timer after replacing the lamp.

#### Info

- Make sure to reset the lamp timer only when replacing the lamp. If you reset the lamp timer and continue to use the same lamp, this may cause the lamp to become damaged or explode.

### 1 Connect the power cord.

- Plug the power cord into the AC socket of the projector.

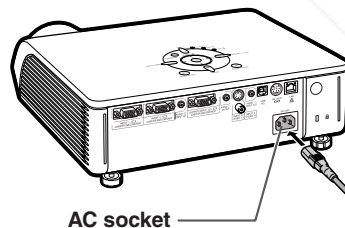

### 2 Reset the lamp timer.

- While simultaneously holding down **ENTER** and **▼** on the projector, press **ON** on the projector.

- "LAMP 0000H" is displayed, indicating that the lamp timer is reset.

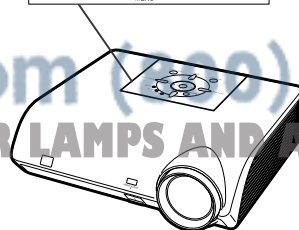
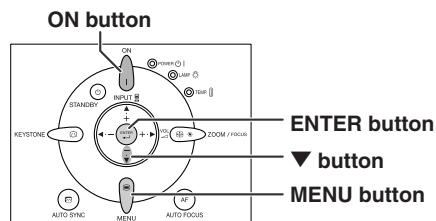

# Computer Compatibility Chart

The table below lists signal codes that are compatible with the projector. When the images are distorted or cannot be projected, adjust the output signal of your computer and so forth while referring to the table below.

## Computer

- Multiple signal support  
Horizontal Frequency: 15–70 kHz,  
Vertical Frequency: 43–85 Hz,  
Pixel Clock: 12–108 MHz  
Sync signal: Compatible with TTL level
- Compatible with sync on green signal
- SXGA+ and SXGA compatible in [intelligent compression](#)
- Intelligent Compression and Expansion System resizing technology

The following is a list of modes that conform to VESA. However, this projector supports other signals that are not VESA standards.

| PC/MAC/WS | Resolution    | Horizontal Frequency (kHz) | Vertical Frequency (Hz) | VESA Standard | Display                 |         |
|-----------|---------------|----------------------------|-------------------------|---------------|-------------------------|---------|
| PC        | VGA           | 640 × 350                  | 27.0                    | 60            |                         | Upscale |
|           |               |                            | 31.5                    | 70            |                         |         |
|           |               |                            | 37.5                    | 85            | ✓                       |         |
|           |               | 640 × 400                  | 27.0                    | 60            |                         |         |
|           |               |                            | 31.5                    | 70            |                         |         |
|           |               |                            | 37.9                    | 85            | ✓                       |         |
|           | 720 × 350     | 27.0                       | 60                      |               |                         |         |
|           |               | 31.5                       | 70                      |               |                         |         |
|           | 720 × 400     | 27.0                       | 60                      |               |                         |         |
|           |               | 31.5                       | 70                      |               |                         |         |
|           |               | 37.9                       | 85                      | ✓             |                         |         |
|           | 640 × 480     | 26.2                       | 50                      |               |                         |         |
|           |               | 31.5                       | 60                      | ✓             |                         |         |
|           |               | 34.7                       | 70                      |               |                         |         |
|           |               | 37.9                       | 72                      | ✓             |                         |         |
|           |               | 37.5                       | 75                      | ✓             |                         |         |
|           |               | 43.3                       | 85                      | ✓             |                         |         |
|           | SVGA          | 800 × 600                  | 31.4                    | 50            |                         |         |
|           |               |                            | 35.1                    | 56            | ✓                       |         |
|           |               |                            | 37.9                    | 60            | ✓                       |         |
|           |               |                            | 46.6                    | 70            |                         |         |
|           |               |                            | 48.1                    | 72            | ✓                       |         |
|           |               |                            | 46.9                    | 75            | ✓                       |         |
|           | XGA           | 1,024 × 768                | 53.7                    | 85            | ✓                       |         |
|           |               |                            | 35.5                    | 43            |                         |         |
|           |               |                            | 40.3                    | 50            |                         |         |
|           |               |                            | 48.4                    | 60            | ✓                       |         |
|           |               |                            | 56.5                    | 70            | ✓                       |         |
|           |               |                            | 60.0                    | 75            | ✓                       |         |
|           | SXGA          | 1,152 × 864                | 68.7                    | 85            | ✓                       |         |
| 55.0      |               |                            | 60                      |               |                         |         |
| 66.2      |               |                            | 70                      |               |                         |         |
| SXGA+     | 1,280 × 1,024 | 67.5                       | 75                      | ✓             |                         |         |
|           | 1,400 × 1,050 | 64.0                       | 60                      | ✓             |                         |         |
| MAC 13"   | VGA           | 640 × 480                  | 34.9                    | 67            | Upscale                 |         |
| MAC 16"   | SVGA          | 800 × 600                  | 37.8                    | 60            |                         |         |
| MAC 19"   | SVGA          | 832 × 624                  | 49.7                    | 75            | True                    |         |
| MAC 21"   | XGA           | 1,024 × 768                | 60.2                    | 75            |                         |         |
| MAC 21"   | SXGA          | 1,152 × 870                | 68.7                    | 75            | Intelligent Compression |         |





## Note

- This projector may not be able to display images from notebook computers in simultaneous (CRT/LCD) mode. Should this occur, turn off the LCD display on the notebook computer and output the display data in "CRT only" mode. Details on how to change display modes can be found in your notebook computer's operation manual.
- When this projector receives 640 × 350 VESA format VGA signals, "640 × 400" appears on the screen.
- When projecting the RGB interlace signal using INPUT 1/2 with "Signal Type" set to "Auto" or "RGB", the image may not be projected as desired. In this case, select either INPUT 3 (Video) or INPUT 4 (S-Video).

## DTV

| Signal | Horizontal Frequency (kHz) | Vertical Frequency (Hz) |
|--------|----------------------------|-------------------------|
| 480I   | 15.7                       | 60                      |
| 480P   | 31.5                       | 60                      |
| 540P   | 33.8                       | 60                      |
| 576I   | 15.6                       | 50                      |
| 576P   | 31.3                       | 50                      |
| 720P   | 45.0                       | 60                      |
| 1035I  | 28.1                       | 50                      |
| 1035I  | 33.8                       | 60                      |
| 1080I  | 28.1                       | 50                      |
| 1080I  | 33.8                       | 60                      |

# Troubleshooting

| Problem   | Check  | Page     |
|---|--|----------|
|  <p>No picture and no sound or projector does not start.</p> | • Projector power cord is not plugged into the wall outlet.  | 29       |
|   | • Power to the external connected devices is off.  | —        |
|   | • The selected input mode is wrong.  | 33       |
|   | • The AV MUTE function is working.   | 34       |
|   | • Cables incorrectly connected to rear panel of the projector.   | 23,25-28 |
|   | • Remote control batteries have run out.   | 15       |
|   | • External output has not been set when connecting notebook computer.  | 69       |
|   | • The lamp unit cover is not installed correctly.  | 67,68    |
|  <p>Sound is heard but no picture appears.</p>               | • Cables incorrectly connected to the rear panel of the projector.   | 23,25-28 |
|   | • “Bright” is set to minimum position.   | 44       |
|  <p>Color is faded or poor.</p>                             | • Image adjustments are incorrectly set.   | 44       |
|   | (Video Input only)<br>• Video input system is incorrectly set.   | 51       |
|   | (INPUT 1, INPUT 2 only)<br>• Input signal type (RGB/Component) is incorrectly set.   | 47       |
|  <p>Picture is blurred; noise appears.</p>                 | • Adjust the focus.  | 32       |
|   | • The projection distance exceeds the focus range.   | 19       |
|   | (Computer Input only)<br>• Perform “Fine Sync” Adjustments. (“Clock” Adjustment)   | 48       |
|   | • Perform “Fine Sync” Adjustments. (“Phase” Adjustment)  | 48       |
|  <p>Picture appears but no sound is heard.</p>             | • Cables incorrectly connected to rear panel of the projector.   | 23,25-28 |
|   | • Volume is set to minimum.  | 33       |
| An unusual sound is occasionally heard from the cabinet.  | • If the picture is normal, the sound is due to cabinet shrinkage caused by room temperature changes. This will not affect operation or performance. | —        |
| Maintenance indicator illuminates or blinks in red.   | • See “Maintenance Indicators”.  | 64       |
| The projector cannot be turned on or put into the standby mode using the ON or STANDBY button on the projector.                               | • The keylock is set.<br>If the keylock is set to ON, all the buttons are locked.  | 55       |



| Problem   | Check   | Page     |
|---|---|----------|
| Picture is green on INPUT 1 (COMPONENT)/ INPUT 2 (COMPONENT). | <ul style="list-style-type: none"> <li>Change the input signal type setting.</li> </ul>   | 47       |
| Picture is pink (no green) on INPUT 1 (RGB)/ INPUT 2 (RGB).   |   |          |
| Picture is too bright and whitish.                            | <ul style="list-style-type: none"> <li>Image adjustments are incorrectly set.</li> </ul>  | 44       |
| The cooling fan becomes noisy.                                | <ul style="list-style-type: none"> <li>When temperature inside the projector increases, the cooling fan runs faster.</li> </ul>   | —        |
| The lamp does not light up even after the projector turns on. | <ul style="list-style-type: none"> <li>The lamp indicator is illuminating in red. Replace the lamp.</li> </ul>  | 64       |
| The lamp suddenly turns off during projection.                |   |          |
| The image sometimes flickers.                                 | <ul style="list-style-type: none"> <li>Cables incorrectly connected to the projector or the connected equipment works improperly.</li> <li>If this happens frequently, replace the lamp.</li> </ul> | 23,25-28 |
| The lamp takes a long time to turn on.                        |   | 67       |
| Picture is dark.  | <ul style="list-style-type: none"> <li>The lamp will eventually need to be changed. The lamp has reached the end of its life. Replace the lamp.</li> </ul>  | 67       |

This projector is equipped with a microprocessor. Its performance could be adversely affected by incorrect operation or interference. If this should happen, unplug the projector and plug it in again after more than 30 seconds.



## For SHARP Assistance

If you encounter any problems during setup or operation of this projector, first refer to the “Troubleshooting” section on pages 70 and 71. If this operation manual does not answer your question, please contact the SHARP Service departments listed below.

|                      |   |                    |  |
|----------------------|---|--------------------|--|
| <b>U.S.A.</b>        | <b>Sharp Electronics Corporation</b><br>1-888-GO-SHARP (1-888-467-4277)<br>lcdsupport@sharpsec.com<br>http://www.sharplcd.com       | <b>Benelux</b>     | <b>SHARP Electronics Benelux BV</b><br>0900-SHARPC (0900-7427723)<br>Nederland<br>9900-0159 Belgium<br>http://www.sharp.nl<br>http://www.sharp.be<br>http://www.sharp.lu |
| <b>Canada</b>        | <b>Sharp Electronics of Canada Ltd.</b><br>(905) 568-7140<br>http://www.sharp.ca  | <b>Australia</b>   | <b>Sharp Corporation of Australia Pty. Ltd.</b><br>1300-135-022<br>http://www.sharp.net.au   |
| <b>Mexico</b>        | <b>Sharp Electronics Corporation Mexico Branch</b><br>(525) 716-9000<br>http://www.sharp.com.mx                                     | <b>New Zealand</b> | <b>Sharp Corporation of New Zealand</b><br>(09) 634-2059, (09) 636-6972<br>http://www.sharpnz.co.nz  |
| <b>Latin America</b> | <b>Sharp Electronics Corp. Latin American Group</b><br>(305) 264-2277<br>www.servicio@sharpsec.com<br>http://www.siempresharp.com   | <b>Singapore</b>   | <b>Sharp-Roxy Sales (S) Pte. Ltd.</b><br>65-226-6556<br>ckng@srs.global.sharp.co.jp<br>http://www.sharp.com.sg   |
| <b>Germany</b>       | <b>Sharp Electronics (Europe) GMBH</b><br>01805-234675<br>http://www.sharp.de   | <b>Hong Kong</b>   | <b>Sharp-Roxy (HK) Ltd.</b><br>(852) 2410-2623<br>dcmktg@srh.global.sharp.co.jp<br>http://www.sharp.com.hk   |
| <b>U.K.</b>          | <b>Sharp Electronics (U.K.) Ltd.</b><br>0161-205-2333<br>cic@sharp-uk.co.uk<br>http://www.sharp.co.uk                               | <b>Taiwan</b>      | <b>Sharp Corporation (Taiwan)</b><br>0800-025111<br>http://www.sharp-scot.com.tw   |
| <b>Italy</b>         | <b>Sharp Electronics (Italy) S.P.A.</b><br>(39) 02-89595-1<br>http://www.sharp.it   | <b>Malaysia</b>    | <b>Sharp-Roxy Sales &amp; Service Co.</b><br>(60) 3-5125678  |
| <b>France</b>        | <b>Sharp Electronics France</b><br>01 49 90 35 40<br>hotlinecd@sef.sharp-eu.com<br>http://www.sharp.fr                              | <b>U.A.E.</b>      | <b>Sharp Middle East Fze</b><br>971-4-81-5311<br>helpdesk@smef.global.sharp.co.jp  |
| <b>Spain</b>         | <b>Sharp Electronica Espana, S.A.</b><br>93 5819700<br>sharplcd@sees.sharp-eu.com<br>http://www.sharp.es                            | <b>Thailand</b>    | <b>Sharp Thebnakorn Co. Ltd.</b><br>02-236-0170<br>svc@stcl.global.sharp.co.jp<br>http://www.sharp-th.com  |
| <b>Switzerland</b>   | <b>Sharp Electronics (Schweiz) AG</b><br>0041 1 846 63 11<br>cattaneo@sez.sharp-eu.com<br>http://www.sharp.ch                       | <b>Korea</b>       | <b>Sharp Electronics Incorporated of Korea</b><br>(82) 2-3660-2002<br>lcd@sharp-korea.co.kr<br>http://www.sharpkorea.co.kr   |
| <b>Sweden</b>        | <b>Sharp Electronics (Nordic) AB</b><br>(46) 8 6343600<br>vision.support@sen.sharp-eu.com<br>http://www.sharp.se                    | <b>India</b>       | <b>Sharp Business Systems (India) Limited</b><br>(91) 11- 6431313<br>service@sharp-oa.com  |
| <b>Austria</b>       | <b>Sharp Electronics (Europe) GMBH Branch Office Austria</b><br>0043 1 727 19 123<br>pogats@sea.sharp-eu.com<br>http://www.sharp.at |                    |  |



Discount Merchant.com (800) 281-8860

THE TRUSTED SOURCE FOR PROJECTOR LAMPS AND ACCESSORIES

# Specifications

|   |  |
|---|--|
| Product type  | Multimedia Projector   |
| Model   | XG-MB70X   |
| Video system  | NTSC3.58/NTSC4.43/PAL/PAL-M/PAL-N/PAL-60/SECAM/<br>DTV480I/DTV480P/DTV540P/DTV576I/DTV576P/DTV720P/DTV1035I/DTV1080I   |
| Display method  | Single Chip Digital Micromirror Device™ (DMD™) by Texas Instruments  |
| DMD panel   | Panel size: 0.7"<br>No. of dots: 786,432 dots (1,024 [H] × 768 [V])  |
| Lens  | 1.5 × electric zoom/focus lens, F2.0–2.5, f = 21.3–31.6 mm   |
| Projection lamp   | 275 W DC lamp  |
| Component input (INPUT 1/2)/<br>output (OUTPUT) signal    | 15-pin mini D-sub connector<br>Y: 1.0 Vp-p, sync negative, 75 Ω terminated<br>P <sub>B</sub> : 0.7 Vp-p, 75 Ω terminated<br>P <sub>R</sub> : 0.7 Vp-p, 75 Ω terminated   |
| Horizontal resolution                                     | 750 TV lines (DTV720P)   |
| Computer RGB input (INPUT 1/2)/<br>output (OUTPUT) signal | 15-pin mini D-sub connector<br>RGB separate/sync on green type analog input: 0–0.7 Vp-p, positive, 75 Ω terminated<br>HORIZONTAL SYNC. SIGNAL: TTL level (positive/negative)<br>VERTICAL SYNC. SIGNAL: Same as above   |
| Video input signal<br>(INPUT 3)                           | RCA connector: VIDEO, composite video, 1.0 Vp-p, sync negative, 75 Ω terminated  |
| S-video input signal<br>(INPUT 4)                         | 4-pin mini DIN connector<br>Y (luminance signal): 1.0 Vp-p, sync negative, 75 Ω terminated<br>C (chrominance signal): Burst 0.286 Vp-p, 75 Ω terminated  |
| Audio input signal  | ø3.5 mm minijack: AUDIO, 0.5 Vrms, more than 22 kΩ (stereo)  |
| USB terminal  | 4-pin B-type USB female connector  |
| RS-232C terminal  | 9-pin mini DIN connector   |
| LAN terminal  | 8-pin RJ-45 modular connector  |
| Pixel clock   | 12–108 MHz   |
| Vertical frequency  | 43–85 Hz   |
| Horizontal frequency                                      | 15–70 kHz  |
| Audio output  | 2.0 W (monaural)   |
| Speaker system  | 4.0 cm × 2.85 cm oval × 1  |
| Rated voltage   | AC 100–240 V   |
| Input current   | 3.9 A  |
| Rated frequency   | 50/60 Hz   |
| Power consumption   | 370 W (Standard mode)/320 W (Eco mode) with AC 100 V<br>350 W (Standard mode)/300 W (Eco mode) with AC 240 V   |
| Power consumption (standby)                               | 6 W (AC 100 V) – 8 W (AC 240 V)  |
| Heat dissipation  | 1,390 BTU/hour (Standard mode)/1,200 BTU/hour (Eco mode) with AC 100 V<br>1,315 BTU/hour (Standard mode)/1,130 BTU/hour (Eco mode) with AC 240 V   |
| Operating temperature                                     | 41°F to 104°F (+5°C to +40°C)  |
| Storage temperature                                       | –4°F to 140°F (–20°C to +60°C)   |
| Cabinet   | Plastic  |
| I/R carrier frequency                                     | 38 kHz   |
| Dimensions (approx.)                                      | 12 7/32" × 11 7/64" × 3 33/64" (310 (W) × 282 (H) × 89 (D) mm) (main body only)<br>12 7/32" × 11 5/16" × 4 7/64" (310 (W) × 287 (H) × 104 (D) mm) (including adjustment foot<br>and projecting parts)  |
| Weight (approx.)  | 9.1 lbs. (4.1 kg)  |
| Replacement parts   | Lamp unit (Lamp/cage module) (AN-MB70LP), Remote control (RRMCGA313WJSA), Power cord for U.S., Canada, etc. (QACCCA010WJPZ), Power cord for Europe, except U.K. (QACCA011WJPZ), Power cord for U.K., Hong Kong and Singapore (QACCA036WJPZ), Power cord for Australia, New Zealand and Oceania (QACCLA018WJPZ), RGB cable (QCNWGA045WJPZ), USB cable (QCNWGA014WJPZ), Storage case (GCASNA014WJSA), Lens cap (RCAPHA021WJSA), Projector manual and technical reference CD-ROM (UDSKAA052WJZZ), "QUICK GUIDE" label (TLABZA717WJZZ), Operation manual (TINS-B416WJZZ) |

As a part of policy of continuous improvement, SHARP reserves the right to make design and specification changes for product improvement without prior notice. The performance specification figures indicated are nominal values of production units. There may be some deviations from these values in individual units.

Discount-Merchant.com (800) 281-8850  
THE TRUSTED SOURCE FOR PROJECTOR LAMPS AND ACCESSORIES

Appendix



# Glossary

## Aspect Ratio

Width and height ratio of an image. The normal aspect ratio of a computer and video image is 4:3. There are also wide images with an aspect ratio of 16:9 and 21:9.

## Auto Sync

Optimizes projected computer images by automatically adjusting certain characteristics.

## Background

Initial setting image projected when no signal is being output.

## Border

Projects a 4:3 image fully within a 16:9 screen by keeping the aspect ratio at 4:3.

## Clock

Clock adjustment is used to adjust vertical noise when clock level is incorrect.

## CLR Temp (Color temperature)

Function that can be used to adjust the color temperature to suit the type of image input to the projector. Decrease the color temperature to create warmer, reddish images for natural flesh tones, or increase to create cooler, bluish images for a brighter picture.

## Dot by dot

Mode that projects images in their native resolution.

## Intelligent compression

High quality resizing of lower and higher resolution images to fit the projector's native resolution.

## Keylock

Mode that can lock the operation of projector buttons to prevent unauthorized adjustment.

## Keystone Correction

Function to digitally correct a distorted image when the projector is set up at an angle, smoothens out jaggies on keystone images and compresses the image not only horizontally but vertically keeping the 4:3 aspect ratio.

## Phase

Phase shift is a timing shift between isomorphic signals with the same resolution. When phase level is incorrect, the projected image typically displays horizontal flicker.

## Picture Mode

Image quality enhancement function that offers a richer image by brightening the darker portions of the image without altering the brightness of the brighter portions. You can select four different modes: STANDARD, PRESENTATION, CINEMA and GAME.

## Resize

Allows you to modify or customize the picture display mode to enhance the input image. You can select four different modes: NORMAL, DOT BY DOT, BORDER and STRETCH.

## sRGB

An international standard of color reproduction regulated by the IEC (International Electrotechnical Commission). As the fixed color area has been decided by the IEC, the color changes according to DLP features, so that the images are displayed in a natural tint based on an original image, when "sRGB" is set to "ON".

## Stretch

Mode that stretches the 4:3 image horizontally to display it fully on a 16:9 screen.

## System Lock

If the "Keycode" set in the projector is not correctly entered, the projector will not operate even if signals are entered.

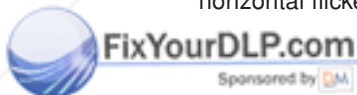

**Discount-Merchant.com (800) 281-8860**  
**THE TRUSTED SOURCE FOR PROJECTOR LAMPS AND ACCESSORIES**



# Index

|  |         |                                     |       |
|--|---------|-------------------------------------|-------|
| AC socket .....                              | 29      | MAC Address .....                   | 61    |
| Adjustment buttons .....                     | 40      | MENU button .....                   | 40    |
| Aspect ratio .....                           | 36,37   | Menu Position .....                 | 53    |
| AUDIO INPUT terminal .....                   | 23      | MOUSE / Adjustment button .....     | 24,40 |
| AUDIO OUTPUT terminal .....                  | 28      | Normal .....                        | 36,50 |
| Auto Focus .....                             | 32,57   | ON button .....                     | 29    |
| AUTO FOCUS button .....                      | 32      | Optional accessories .....          | 10    |
| Auto Keystone .....                          | 57      | Options1 .....                      | 39,50 |
| Auto Power Off .....                         | 53      | Options2 .....                      | 39,56 |
| Auto Sync (Auto Sync adjustment) .....       | 49      | OSD Display .....                   | 51    |
| AUTO SYNC button .....                       | 49      | OUTPUT (INPUT 1, 2) terminal .....  | 28    |
| AV MUTE button .....                         | 34      | Password .....                      | 56    |
| Background .....                             | 52      | PDF .....                           | 9     |
| Blue .....                                   | 44      | Phase .....                         | 48    |
| Border .....                                 | 36,50   | Picture .....                       | 38,44 |
| Bright .....                                 | 44      | Picture Mode .....                  | 44    |
| Clock .....                                  | 48      | PICTURE MODE button .....           | 35    |
| CLR Temp (Color Temperature) .....           | 45      | Power cord .....                    | 29    |
| Color .....                                  | 44      | Power indicator .....               | 12    |
| Contrast .....                               | 44      | PRJ mode .....                      | 59    |
| DIN-D-sub RS-232C adaptor .....              | 27      | R-CLICK/UNDO button .....           | 24,40 |
| Dot By Dot .....                             | 36,50   | Rear adjustment feet .....          | 30    |
| Eco Mode .....                               | 52      | Red .....                           | 44    |
| ENLARGE buttons .....                        | 34      | Remote control .....                | 14    |
| ENTER button .....                           | 40      | Remote control sensor .....         | 15    |
| Exhaust vent .....                           | 7,13,63 | Replacing the lamp .....            | 67    |
| Fine Sync .....                              | 38,48   | RESIZE button .....                 | 36    |
| Focus buttons .....                          | 32      | RGB cable .....                     | 23    |
| FREEZE button .....                          | 35      | RS-232C terminal .....              | 27    |
| Front adjustment foot .....                  | 30      | Sharp .....                         | 44    |
| H-Pos .....                                  | 48      | Signal Info .....                   | 49    |
| HEIGHT ADJUST button .....                   | 30      | Signal Type .....                   | 47    |
| INPUT 1 terminal .....                       | 23,25   | Special Modes .....                 | 48    |
| INPUT 1 – 4 modes .....                      | 33      | sRGB .....                          | 46    |
| INPUT 2 terminal .....                       | 23,25   | STANDBY button .....                | 29    |
| INPUT 3 terminal .....                       | 26      | Storage case .....                  | 18    |
| INPUT 4 terminal .....                       | 26      | Stretch .....                       | 36,50 |
| INPUT buttons .....                          | 33      | Supplied accessories .....          | 10    |
| Intake vent .....                            | 7,63    | Temperature warning indicator ..... | 64    |
| IP Address .....                             | 61      | Tint .....                          | 44    |
| IRIS .....                                   | 46      | USB terminal .....                  | 23    |
| IRIS button .....                            | 35      | Video System .....                  | 51    |
| Kensington Security Standard connector ..... | 13      | Volume buttons .....                | 33    |
| Keycode .....                                | 54      | V-Pos .....                         | 48    |
| Keylock .....                                | 55      | ZOOM/FOCUS button .....             | 32    |
| KEYSTONE button .....                        | 31      |                                     |       |
| Keystone Correction .....                    | 31      |                                     |       |
| Lamp .....                                   | 66      |                                     |       |
| Lamp indicator .....                         | 64      |                                     |       |
| Lamp Timer (Life) .....                      | 50      |                                     |       |
| LAN terminal .....                           | 27      |                                     |       |
| Language (on-screen display language) .....  | 39,62   |                                     |       |
| LAN/RS232C .....                             | 60      |                                     |       |
| L-CLICK/ENTER button .....                   | 24,40   |                                     |       |
| Lens cap .....                               | 11      |                                     |       |



Discount-Merchant.com (800) 281-8860  
 THE #1 SOURCE FOR PROJECTOR LAMPS AND ACCESSORIES

Appendix





# SHARP®

## SHARP CORPORATION



**Discount-Merchant.com (800) 281-8860**  
**THE TRUSTED SOURCE FOR PROJECTOR LAMPS AND ACCESSORIES**



# Disclaimer

This user manual is provided as a free service by FixYourDLP.com. FixYourDLP is in no way responsible for the content of this manual, nor do we guarantee its accuracy. FixYourDLP does not make any claim of copyright and all copyrights remain the property of their respective owners.

About FixYourDLP.com

FixYourDLP.com (<http://www.fixyourdlp.com>) is the World's #1 resource for media product news, reviews, do-it-yourself guides, and manuals.

Informational Blog: <http://www.fixyourdlp.com>

Video Guides: <http://www.fixyourdlp.com/guides>

User Forums: <http://www.fixyourdlp.com/forum>

FixYourDLP's Fight Against Counterfeit Lamps:

<http://www.fixyourdlp.com/counterfeits>

## Sponsors:

RecycleYourLamp.org – Free lamp recycling services for used lamps:

<http://www.recycleyourlamp.org>

Lamp Research - The trusted 3rd party lamp research company:

<http://www.lampresearch.com>

Discount-Merchant.com – The worlds largest lamp distributor:

<http://www.discount-merchant.com>



**FixYourDLP.com**

Sponsored by 