



Disclaimer

This user manual is provided as a free service by FixYourDLP.com. FixYourDLP is in no way responsible for the content of this manual, nor do we guarantee its accuracy. FixYourDLP does not make any claim of copyright and all copyrights remain the property of their respective owners.

About FixYourDLP.com

FixYourDLP.com (<http://www.fixyourdlp.com>) is the World's #1 resource for media product news, reviews, do-it-yourself guides, and manuals.

Informational Blog: <http://www.fixyourdlp.com>

Video Guides: <http://www.fixyourdlp.com/guides>

User Forums: <http://www.fixyourdlp.com/forum>

FixYourDLP's Fight Against Counterfeit Lamps:

<http://www.fixyourdlp.com/counterfeits>

Sponsors:

RecycleYourLamp.org – Free lamp recycling services for used lamps:

<http://www.recycleyourlamp.org>

Lamp Research - The trusted 3rd party lamp research company:

<http://www.lampresearch.com>

Discount-Merchant.com – The worlds largest lamp distributor:

<http://www.discount-merchant.com>



FixYourDLP.com

Sponsored by 

SHARP®

DATA PROJECTOR

MODEL

PG-F255W

OPERATION MANUAL

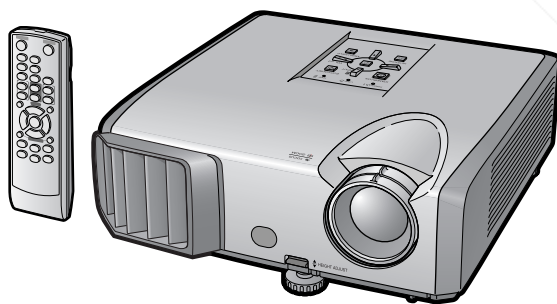

 FixYourDLP.com
Sponsored by 

PICTURE BY
DLP
TEXAS INSTRUMENTS

Discount-Merchant.com (800) 281-8860

THE #1 USED SOURCE FOR PROJECTOR LAMPS AND ACCESSORIES

PJLink

Introduction

Quick Start

Setup

Connections

Basic
Operation

Useful
Features

Appendix

IMPORTANT

- For your assistance in reporting the loss or theft of your Projector, please record the Model and Serial Number located on the bottom of the projector and retain this information.
- Before recycling the packaging, please ensure that you have checked the contents of the carton thoroughly against the list of “Supplied accessories” on page **11**.



Model No.:

Serial No.:



Discount-Merchant.com (800) 281-8860
THE TRUSTED SOURCE FOR PROJECTOR LAMPS AND ACCESSORIES

SPECIAL NOTE FOR USERS IN THE U.K.

The mains lead of this product is fitted with a non-rewireable (moulded) plug incorporating a 10A fuse. Should the fuse need to be replaced, a BSI or ASTA approved BS 1362 fuse marked  or  and of the same rating as above, which is also indicated on the pin face of the plug, must be used.

Always refit the fuse cover after replacing the fuse. Never use the plug without the fuse cover fitted.

In the unlikely event of the socket outlet in your home not being compatible with the plug supplied, cut off the mains plug and fit an appropriate type.

DANGER:

The fuse from the cut-off plug should be removed and the cut-off plug destroyed immediately and disposed of in a safe manner.

Under no circumstances should the cut-off plug be inserted elsewhere into a 13A socket outlet, as a serious electric shock may occur.

To fit an appropriate plug to the mains lead, follow the instructions below:

WARNING:

THIS APPARATUS MUST BE EARTHED.

IMPORTANT:

The wires in this mains lead are coloured in accordance with the following code:

Green-and-yellow	: Earth
Blue	: Neutral
Brown	: Live

As the colours of the wires in the mains lead of this apparatus may not correspond with the coloured markings identifying the terminals in your plug proceed as follows:

- The wire which is coloured green-and-yellow must be connected to the terminal in the plug which is marked by the letter E or by the safety earth symbol  or coloured green or green-and-yellow.
- The wire which is coloured blue must be connected to the terminal which is marked with the letter N or coloured black.
- The wire which is coloured brown must be connected to the terminal which is marked with the letter L or coloured red.

IF YOU HAVE ANY DOUBT, CONSULT A QUALIFIED ELECTRICIAN.



Discount-Merchant.com (800) 281-8860
THE TRUSTED SOURCE FOR PROJECTOR LAMPS AND ACCESSORIES

The supplied CD-ROM contains operation instructions in English, German, French, Spanish, Italian, Dutch, Swedish, Portuguese and Chinese. Carefully read through the operation instructions before operating the projector.

Die mitgelieferte CD-ROM enthält Bedienungsanleitungen in Englisch, Deutsch, Französisch, Spanisch, Italienisch, Niederländisch, Schwedisch, Portugiesisch und Chinesisch. Bitte lesen Sie die Bedienungsanleitung vor der Verwendung des Projektors sorgfältig durch.

Le CD-ROM fourni contient les instructions de fonctionnement en anglais, allemand, français, espagnol, italien, néerlandais, suédois, portugais et chinois. Veuillez lire attentivement ces instructions avant de faire fonctionner le projecteur.

El CD-ROM suministrado contiene instrucciones de operación en inglés, alemán, francés, español, italiano, holandés, sueco, portugués y chino. Lea cuidadosamente las instrucciones de operación antes de utilizar el proyector.

Il CD-ROM in dotazione contiene istruzioni per l'uso in inglese, tedesco, francese, spagnolo, italiano, olandese, svedese, portoghese e cinese. Leggere attentamente le istruzioni per l'uso prima di usare il proiettore.

De meegeleverde CD-ROM bevat handleidingen in het Engels, Duits, Frans, Spaans, Italiaans, Nederlands, Zweeds, Portugees en Chinees. Lees de handleiding zorgvuldig door voor u de projector in gebruik neemt.

Den medföljande CD-ROM-skivan innehåller bruksanvisningar på engelska, tyska, franska, spanska, italienska, holländska, svenska, portugisiska och kinesiska. Läs noga igenom bruksanvisningen innan projektorn tas i bruk.

O CD-ROM fornecido contém instruções de operação em Inglês, Alemão, Francês, Espanhol, Italiano, Holandês, Sueco, Português e Chinês. Leia cuidadosamente todas as instruções de operação antes de operar o projetor.

附送之CD-ROM光碟中，有用英文、德文、法文、西班牙文、意大利文、荷蘭文、瑞典文、葡萄牙文和中文所寫的使用說明書。在操作本投影機之前，請務必仔細閱讀整本使用說明書。



Discount-Merchant.com (800) 281-8860
THE TRUSTED SOURCE FOR PROJECTOR LAMPS AND ACCESSORIES

Before using the projector, please read this operation manual carefully.

Introduction

ENGLISH

There are two important reasons for prompt warranty registration of your new SHARP Projector, using the REGISTRATION CARD packed with the projector.

1. WARRANTY

This is to assure that you immediately receive the full benefit of the parts, service and labor warranty applicable to your purchase.

2. CONSUMER PRODUCT SAFETY ACT

To ensure that you will promptly receive any safety notification of inspection, modification, or recall that SHARP may be required to give under the 1972 Consumer Product Safety Act, PLEASE READ CAREFULLY THE IMPORTANT "LIMITED WARRANTY" CLAUSE.



U.S.A. ONLY

WARNING: High brightness light source. Do not stare into the beam of light, or view directly. Be especially careful that children do not stare directly into the beam of light.



WARNING: To reduce the risk of fire or electric shock, do not expose this product to rain or moisture.

See bottom of projector.

	CAUTION RISK OF ELECTRIC SHOCK. DO NOT REMOVE SCREWS EXCEPT SPECIFIED USER SERVICE SCREW.	
CAUTION: TO REDUCE THE RISK OF ELECTRIC SHOCK, DO NOT REMOVE COVER. NO USER-SERVICEABLE PARTS EXCEPT LAMP UNIT. REFER SERVICING TO QUALIFIED SERVICE PERSONNEL.		



The lightning flash with arrowhead symbol, within an equilateral triangle, is intended to alert the user to the presence of uninsulated "dangerous voltage" within the product's enclosure that may be of sufficient magnitude to constitute a risk or electric shock to persons.



The exclamation point within a triangle is intended to alert the user to the presence of important operating and maintenance (servicing) instructions in the literature accompanying the product.

WARNING: FCC Regulations state that any unauthorized changes or modifications to this equipment not expressly approved by the manufacturer could void the user's authority to operate this equipment.

U.S.A. ONLY



Discount-Merchant.com (800) 281-8860
THE TRUSTED SOURCE FOR PROJECTOR LAMPS AND ACCESSORIES

INFORMATION

This equipment has been tested and found to comply with the limits for a Class A digital device, pursuant to Part 15 of the FCC Rules. These limits are designed to provide reasonable protection against harmful interference when the equipment is operated in a commercial environment. This equipment generates, uses, and can radiate radio frequency energy and, if not installed and used in accordance with the operation manual, may cause harmful interference to radio communications. Operation of this equipment in a residential area is likely to cause harmful interference, in which case the user will be required to correct the interference at his own expense.

U.S.A. ONLY

The enclosed computer cable must be used with the device. The cable is provided to ensure that the device complies with FCC Class A verification.

U.S.A. ONLY

WARNING:

This is a Class A product. In a domestic environment this product may cause radio interference in which case the user may be required to take adequate measures.

PRODUCT DISPOSAL

This product utilizes tin-lead solder, and lamp containing a small amount of mercury. Disposal of these materials may be regulated due to environmental considerations. For disposal or recycling information, please contact your local authorities, the Electronics Industries Alliance: www.eiae.org, the lamp recycling organization www.lamprecycle.org, or Sharp at 1-800-BE-SHARP.

U.S.A. ONLY

Caution Concerning Lamp Replacement

See "Replacing the Lamp" on page 55.

This SHARP projector uses a DLP® chip. This very sophisticated panel contains 1,024,000 pixels (micromirrors). As with any high technology electronic equipment such as large screen TVs, video systems and video cameras, there are certain acceptable tolerances that the equipment must conform to.

This unit has some inactive pixels within acceptable tolerances which may result in inactive dots on the picture screen. This will not affect the picture quality or the life expectancy of the unit.

Authorized representative responsible for the European Union Community Market

SHARP ELECTRONICS (Europe) GmbH
SonninstraÙe 3, D-20097 Hamburg

E.U. ONLY

How to Read this Operation Manual

- The specifications are slightly different, depending on the model. However, you can connect and operate all models in the same manner.
- In this operation manual, the illustration and the screen display are simplified for explanation, and may differ slightly from the actual display.

Using the Menu Screen

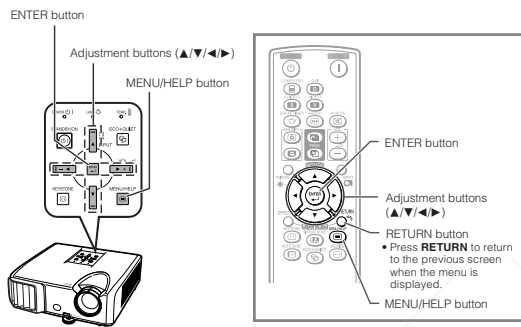

Buttons used in this operation

Menu Selections (Adjustments)

Example: Adjusting "Bright".
• This operation can also be performed by using the buttons on the projector.

- 1 Press **MENU/HELP**.
• The "Picture" menu screen for the selected input mode is displayed.
- 2 Press **▶** or **◀** and select "Picture" to adjust.

Example: "Picture" screen menu for COMPUTER (RGB) input

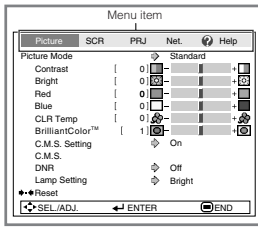

Button used in this step

On-screen display



..... Indicates safeguards for using the projector.



..... Indicates additional information for setting up and operating the projector.

Discount Merchant.com (800) 281-8860

THE TRUSTED SOURCE FOR PROJECTOR LAMPS AND ACCESSORIES For Future Reference

Maintenance

Troubleshooting

Index

➔ P. 52

➔ PP. 60 and 61

➔ P. 65

Contents

Preparing

Introduction

How to Read this Operation Manual	3
Contents	4
IMPORTANT SAFEGUARDS	6
How to Access the PDF Operation Manuals	10
Accessories	11
Part Names and Functions	12
Projector	12
Rear View	13
Inserting the Batteries	15
Usable Range	15

Quick Start

Quick Start	16
Setup and Projection	16

Setup

Setting up the Projector	18
Setting up the Projector	18
Standard Setup (Front Projection)	18
Ceiling-mount Setup	18
Projection (PRJ) Mode	19
Screen Size and Projection Distance	20

Connections

Connecting the Projector to Other Equipment	21
Controlling the Projector by a Computer	24
Connecting the Power Cord	25

Using

Basic Operation

Turning the Projector On/Off	26
Turning the Projector on	26
Turning the Power off (Putting the Projector into Standby Mode)	26
Image Projection	27
About the Setup Guide	27
Adjusting the Projected Image	27
Correcting Trapezoidal Distortion	29
Switching the Input Mode	30
Adjusting the Volume	30
Displaying the Black Screen and Turning off the Sound Temporarily	30
Resize Mode	31

Useful Features

Operating with the Remote Control	33
Displaying and Setting the Break Timer	33
Displaying the Pointer	33
Using the Spot Function	33
Switching the Eco+Quiet Mode	33
Auto Sync (Auto Sync Adjustment)	34
Freezing a Moving Image	34
Selecting the Picture Mode	34
Displaying an Enlarged Portion of an Image	34
Using the Remote Control as the Wireless Computer Mouse	35
Menu Items	36
Using the Menu Screen	39
Menu Selections (Adjustments)	39
Picture Adjustment ("Picture" Menu)	41
Selecting the Picture Mode	41
Adjusting the Image	42
Adjusting the Color Temperature	42
Adjusting the Colors	42
Progressive	43
Reducing Image Noise (DNR)	43
Lamp Setting	43
Adjusting the Projected Image ("SCR - ADJ" Menu)	44
Setting the Resize Mode	44
Adjusting the Image Position	44
Keystone Correction	44
Setting the On-screen Display	44
Selecting the Background Image	45
Selecting the Setup Guide	45
Reversing/Inverting Projected Images	45
Selecting the On-screen Display Language	45
Adjusting the Projector Function ("PRJ - ADJ" Menu)	46
Auto Sync (Auto Sync Adjustment)	46
Auto Power Off Function	46
Auto Restart Function	46
STANDBY Mode	46
Setting the Confirmation Sound (System Sound)	46
Speaker Setting	46
Audio Input	47
Selecting the Transmission Speed (RS-232C)	47
Fan Mode Setting	47
System Lock Function	47
Checking the Lamp Life Status	48
Keylock Function	48

Setting up the Projector Network Environment (“Network” menu)	49
Setting a Password	49
DHCP Client Setting	50
TCP/IP Setting	50
Confirming the Projector Information ...	50
Troubleshooting with the “Help” Menu	51
Utilizing the “Help” Menu Functions	51

Reference

Appendix

Maintenance	52
Maintenance Indicators	53
Regarding the Lamp	55
Lamp	55
Caution Concerning the Lamp	55
Replacing the Lamp	55
Removing and Installing the Lamp Unit	56
Resetting the Lamp Timer	57
Storing the Projector	58
How to Use the Storage Case	58
Computer Compatibility Chart	59
Troubleshooting	60
For SHARP Assistance	62
Specifications	63
Dimensions	64
Index	65



Discount-Merchant.com (800) 281-8860
THE TRUSTED SOURCE FOR PROJECTOR LAMPS AND ACCESSORIES

IMPORTANT SAFEGUARDS

CAUTION: Please read all of these instructions before you operate this product and save these instructions for later use.

Electrical energy can perform many useful functions. This product has been engineered and manufactured to assure your personal safety. BUT IMPROPER USE CAN RESULT IN POTENTIAL ELECTRICAL SHOCK OR FIRE HAZARDS. In order not to defeat the safeguards incorporated in this product, observe the following basic rules for its installation, use and servicing.

1. Read Instructions

All the safety and operating instructions should be read before the product is operated.

2. Retain Instructions

The safety and operating instructions should be retained for future reference.

3. Heed Warnings

All warnings on the product and in the operating instructions should be adhered to.

4. Follow Instructions

All operating and use instructions should be followed.

5. Cleaning

Unplug this product from the wall outlet before cleaning. Do not use liquid cleaners or aerosol cleaners. Use a damp cloth for cleaning.

6. Attachments

Do not use attachments not recommended by the product manufacturer as they may cause hazards.

7. Water and Moisture

Do not use this product near water—for example, near a bath tub, wash bowl, kitchen sink, or laundry tub; in a wet basement; or near a swimming pool; and the like.

8. Accessories

Do not place this product on an unstable cart, stand, tripod, bracket, or table. The product may fall, causing serious injury to a child or adult, and serious damage to the product. Use only with a cart, stand, tripod, bracket, or table recommended by the manufacturer, or sold with the product. Any mounting of the product should follow the manufacturer's instructions, and should use a mounting accessory recommended by the manufacturer.

9. Transportation

A product and cart combination should be moved with care. Quick stops, excessive force, and uneven surfaces may cause the product and cart combination to overturn.



10. Ventilation

Slots and openings in the cabinet are provided for ventilation to ensure reliable operation of the product and to protect it from overheating, and these openings must not be blocked or covered. The openings should never be blocked by placing the product on a bed, sofa, rug, or other similar surface. This product should not be placed in a built-in installation such as a bookcase or rack unless proper ventilation is provided or the manufacturer's instructions have been adhered to.

11. Power Sources

This product should be operated only from the type of power source indicated on the marking label. If you are not sure of the type of power supply to your home, consult your product dealer or local power company. For products intended to operate from battery power, or other sources, refer to the operating instructions.

12. Grounding or Polarization

This product is provided with one of the following types of plugs. If the plug should fail to fit into the power outlet, please contact your electrician. Do not defeat the safety purpose of the plug.

- Two-wire type (mains) plug.
- Three-wire grounding type (mains) plug with a grounding terminal.

This plug will only fit into a grounding type power outlet.

13. Power-Cord Protection

Power-supply cords should be routed so that they are not likely to be walked on or pinched by items placed upon or against them, paying particular attention to cords at plugs, convenience receptacles, and the point where they exit from the product.

14. Lightning

For added protection for this product during a lightning storm, or when it is left unattended and unused for long periods of time, unplug it from the wall outlet and disconnect the cable system. This will prevent damage to the product due to lightning and power-line surges.

15. Overloading

Do not overload wall outlets, extension cords, or integral convenience receptacles as this can result in a risk of fire or electric shock.

16. Object and Liquid Entry

Never push objects of any kind into this product through openings as they may touch dangerous voltage points or short-out parts that could result in a fire or electric shock. Never spill liquid of any kind on the product.

17. Servicing

Do not attempt to service this product yourself as opening or removing covers may expose you to dangerous voltage or other hazards. Refer all servicing to qualified service personnel.

18. Damage Requiring Service

Unplug this product from the wall outlet and refer servicing to qualified service personnel under the following conditions:

- a. When the power-supply cord or plug is damaged.
- b. If liquid has been spilled, or objects have fallen into the product.
- c. If the product has been exposed to rain or water.
- d. If the product does not operate normally by following the operating instructions. Adjust only those controls that are covered by the operating instructions, as an improper adjustment of other controls may result in damage and will often require extensive work by a qualified technician to restore the product to normal operation.
- e. If the product has been dropped or damaged in any way.
- f. When the product exhibits a distinct change in performance, this indicates a need for service.

19. Replacement Parts

When replacement parts are required, be sure the service technician has used replacement parts specified by the manufacturer or have the same characteristics as the original part. Unauthorized substitutions may result in fire, electric shock, or other hazards.

20. Safety Check

Upon completion of any service or repairs to this product, ask the service technician to perform safety checks to determine that the product is in proper operating condition.

21. Wall or Ceiling Mounting

This product should be mounted to a wall or ceiling only as recommended by the manufacturer.

22. Heat

This product should be situated away from heat sources such as radiators, heat registers, stoves, or other products (including amplifiers) that produce heat.

- DLP® and the DLP logo are registered trademarks of Texas Instruments and BrilliantColor™ is a trademark of Texas Instruments.
- Microsoft® and Windows® are registered trademarks of Microsoft Corporation in the United States and/or other countries.
- PC/AT is a registered trademark of International Business Machines Corporation in the United States.
- Adobe® Reader® is a trademark of Adobe Systems Incorporated.
- Macintosh® is a registered trademark of Apple Computer, Inc. in the United States and/or other countries.
- PJLink is a registered trademark or an application trademark in Japan, the United States and/or other countries/regions.
- All other company or product names are trademarks or registered trademarks of their respective companies.
- Some IC chips in this product include confidential and/or trade secret property belonging to Texas Instruments. Therefore you may not copy, modify, adapt, translate, distribute, reverse engineer, reverse assemble or discompile the contents thereof.

Observe the following safeguards when setting up your projector.

Caution concerning the lamp unit

- Potential hazard of glass particles if lamp ruptures. In case of lamp rupture, contact your nearest Sharp Authorized Projector Dealer or Service Center for replacement. See “Regarding the Lamp” on page 55.

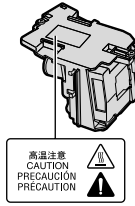

Caution concerning the setup of the projector

- For minimal servicing and to maintain high image quality, SHARP recommends that this projector be installed in an area free from humidity, dust and cigarette smoke. When the projector is subjected to these environments, the vents and lens must be cleaned more often. As long as the projector is regularly cleaned, use in these environments will not reduce the overall operation life of the unit. Internal cleaning should only be performed by a Sharp Authorized Projector Dealer or Service Center.

Do not set up the projector in places exposed to direct sunlight or bright light.

- Position the screen so that it is not in direct sunlight or room light. Light falling directly on the screen washes out the colors, making viewing difficult. Close the curtains and dim the lights when setting up the screen in a sunny or bright room.

Caution regarding placing of the projector

- Place the projector on a level site within the adjustment range (9 degrees) of the adjustment foot.



- After the projector is purchased, a faint smell from the vent may appear when the power is first turned on. This is normal and is not a malfunction. It will disappear after the projector is used for a while.

When using the projector in high-altitude areas such as mountains (at altitudes of approximately 1,500 meters (4,900 feet) or more)

- When you use the projector in high-altitude areas with thin air, set “Fan Mode” to “High”. Neglecting this can affect the longevity of the optical system.

Warning about placing the projector in a high position

- When placing the projector in a high position, make certain it is carefully secure to avoid personal injury caused by the projector falling down.

Do not subject the projector to hard impact and/or vibration.

- Protect the lens so as not to hit or damage the surface of the lens.

Rest your eyes occasionally.

- Continuously watching the screen for long hours will cause eye strain. Take regular breaks to rest your eyes.

Avoid locations with extremes of temperature.

- The operating temperature of the projector is from 41°F to 95°F (+5°C to +35°C).
- The storage temperature of the projector is from -4°F to 140°F (-20°C to +60°C).

Do not block the exhaust and intake vents.

- Allow at least 11 ¹³/₁₆ inches (30 cm) of space between the exhaust vent and the nearest wall or obstruction.
- Ensure that the intake vent and the exhaust vent are not obstructed.
- If the cooling fan becomes obstructed, a protection circuit will automatically put the projector into standby mode to prevent overheating damage. This does not indicate a malfunction. (See pages 53 and 54.) Remove the projector power cord from the wall outlet and wait at least 10 minutes. Place the projector where the intake and exhaust vents are not blocked, plug the power cord back in and turn on the projector. This will return the projector to the normal operating condition.

Caution regarding usage of the projector

- If you are not to use the projector for a long time or before moving the projector, make certain you unplug the power cord from the wall outlet, and disconnect any other cables connected to it.
- If the power cord is unplugged while the cooling fan is running, some parts of the projector may still be hot. Use caution when handling the projector.
- Do not carry the projector by holding the lens.
- When storing the projector, ensure you attach the lens cap to the projector. (See page 12.)
- Do not expose the projector to direct sunlight or place next to heat sources. Doing so may affect the cabinet color or cause deformation of the plastic cover.

Other connected equipment

- When connecting a computer or other audio-visual equipment to the projector, make the connections AFTER unplugging the power cord of the projector from the AC outlet and turning off the equipment to be connected.
- Please read the operation manuals of the projector and the equipment to be connected for instructions on how to make the connections.

Using the projector in other countries

- The power supply voltage and the shape of the plug may vary depending on the region or country you are using the projector in. When using the projector overseas, make sure you use an appropriate power cord for the country you are in.

Temperature monitor function



- If the projector starts to overheat due to setup problems or blockage of the air vents, “” and “TEMP.” will illuminate in the lower left corner of the picture. If the temperature continues to rise, the lamp will turn off, the temperature warning indicator on the projector will blink, and after a 60-second cooling-off period the projector will enter standby mode. Refer to “Maintenance Indicators” on page 53 for details.

Info

- The cooling fan regulates the internal temperature, and its performance is automatically controlled. The sound of the fan may change during projector operation due to changes in the fan speed. This does not indicate malfunction.



How to Access the PDF Operation Manuals

PDF operation manuals in several languages are included in the CD-ROM. To utilize these manuals, you need to install Adobe® Reader® on your computer (Windows® or Macintosh®).

Please download Adobe® Reader® from the Internet (<http://www.adobe.com>).

Accessing the PDF Manuals

For Windows®:

- ① Insert the CD-ROM in the CD-ROM drive.
- ② Double click the “My Computer” icon.
- ③ Double click the “CD-ROM” drive.
- ④ **When you want to view the operation manual**
 - 1) Double click the “MANUALS” folder.
 - 2) Double click the language (name of the folder) that you want to view.
 - 3) Double click the pdf file to access the projector manuals.

When you want to view the SETUP MANUAL

- 1) Double click the “SETUP” folder.
- 2) Double click the language (name of the folder) that you want to view.
- 3) Double click the pdf file to access the SETUP MANUAL.

For Macintosh®:

- ① Insert the CD-ROM in the CD-ROM drive.
- ② Double click the “CD-ROM” icon.
- ③ **When you want to view the operation manual**
 - 1) Double click the “MANUALS” folder.
 - 2) Double click the language (name of the folder) that you want to view.
 - 3) Double click the pdf file to access the projector manuals.

When you want to view the SETUP MANUAL

- 1) Double click the “SETUP” folder.
- 2) Double click the language (name of the folder) that you want to view.
- 3) Double click the pdf file to access the SETUP MANUAL.



Note

- If the desired pdf file cannot be opened by double clicking the mouse, start Adobe® Reader® first, then specify the desired file using the “File”, “Open” menu.

SETUP MANUAL

Refer to the “SETUP MANUAL” contained on the supplied CD-ROM for details.

Connecting Pin Assignments	2
RS-232C Specifications and Commands	4
Setting up the Projector Network Environment	9
Controlling the Projector via LAN	15
Setting up the Projector Using RS-232C or Telnet	20
Resetting the Lamp Timer of the Projector via LAN	30
Troubleshooting	32



Discount-Merchant.com (800) 281-8860

THE TRUSTED SOURCE FOR PROJECTOR LAMPS AND ACCESSORIES

Accessories

Supplied accessories

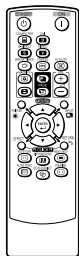

Remote control
<RRMCGA662WJSA>



Two R-6 batteries
("AA" size, UM/SUM-3,
HP-7 or similar)

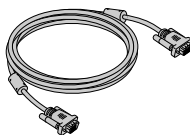

RGB cable
(10' (3.0 m))
<QCNWGA045WJPZ>



Lens cap (attached)
<CCAPHA027WJSA>

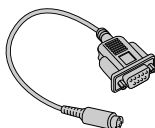

DIN-D-sub RS-232C adaptor
(5 ⁵⁷/₆₄" (15 cm))
<QCNWGA091WJPZ>



Storage case
<GCASNA022WJSA>

Power cord*
(1)

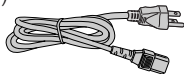

For U.S. and
Canada, etc.
(6' (1.8 m))
<QACCDAA007WJPZ>

(2)

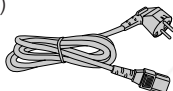

For Europe,
except U.K.
(6' (1.8 m))
<QACCVAA011WJPZ>

(3)

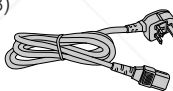

For U.K. and
Singapore
(6' (1.8 m))
<QACCBAA036WJPZ>

(4)

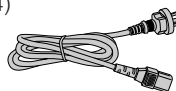

For Australia, New
Zealand and Oceania
(6' (1.8 m))
<QACCLA018WJPZ>

* Use the power cord that corresponds to the wall outlet in your country.

• Operation manual (this manual <TINS-D875WJZZ> and CD-ROM <UDSKAA109WJZZ>)



Note

- Codes in "< >" are Replacement parts codes.

Optional accessories

- Lamp unit
- Ceiling-mount adaptor
- Ceiling-mount unit

FixYourDLP.com
Sponsored by D.M.

- Remote receiver
- 3 RCA to mini D-sub 15 pin cable (10' (3.0 m))

AN-F212LP
AN-60KT
AN-XRCM30 (for U.S.A. only)
AN-TK201 <for AN-60KT>
AN-TK202 <for AN-60KT>
AN-EP101B <for AN-XRCM30>
(for U.S.A. only)
AN-MR2
AN-C3CP2



Note

- Some of the optional accessories may not be available depending on the region. Please check with your nearest Sharp Authorized Projector Dealer or Service Center.

Part Names and Functions

Numbers in **[]** refer to the main pages in this operation manual where the topic is explained.

Projector

Top View

Power indicator **26, 53**

STANDBY/ON button **26**

For turning the power on and putting the projector into standby mode.

ENTER button **39**

For setting items selected or adjusted on the menu.

KEYSTONE button **29**

For entering the Keystone Correction mode.

26, 53 Lamp indicator

53 Temperature warning indicator

33 ECO+QUIET button
For lowering the noise of the cooling fan and extending the lamp life.

30 VOL (Volume) buttons (-◀/▶+)
For adjusting the speaker sound level.

30 INPUT buttons (▲/▼)
For switching input mode.

39, 51 MENU/HELP button
For displaying adjustment and setting screens, and help screen.

39 Adjustment buttons (▲/▼/◀/▶)
For selecting menu items.

Front View

Zoom ring **27**
For enlarging/reducing the picture.

Remote control sensor **15**

Exhaust vent **52**

52 Intake vent

46 Speaker

27 Focus ring
For adjusting the focus.

HEIGHT ADJUST lever **28**

Push both sides of the lens cap to attach or remove.

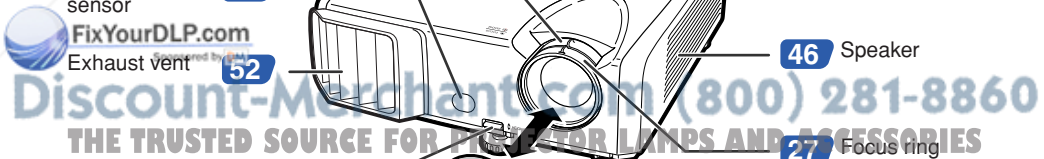

Numbers in refer to the main pages in this operation manual where the topic is explained.

Rear View

Terminals

AUDIO 1 input terminal 23

COMPUTER/
COMPONENT input terminal 21
22
Terminal for computer RGB and component signals.

DVI-I input terminal 21
22
Terminal for DVI digital, computer RGB and component signals.

AUDIO OUT terminal 23
Audio output terminal of equipment connected to the audio input terminal.

LAN terminal 25
Terminal for controlling the projector using a computer via network.

23 MONITOR OUT terminal
(Output terminal for computer RGB, component and DVI analog signals. Shared for COMPUTER/COMPONENT and DVI-I)
Terminal for connecting a monitor.

22 S-VIDEO input terminal
Terminal for connecting video equipment with an S-video terminal.

24 RS-232C terminal
Terminal for controlling the projector using a computer.

35 USB terminal
Terminal connecting with the USB terminal on the computer for using the supplied remote control as the computer mouse.

23 AUDIO 2 input terminal

22 VIDEO input terminal
Terminal for connecting video equipment.

25 AC socket
Connect the supplied power cord.

Rear adjustment foot 28

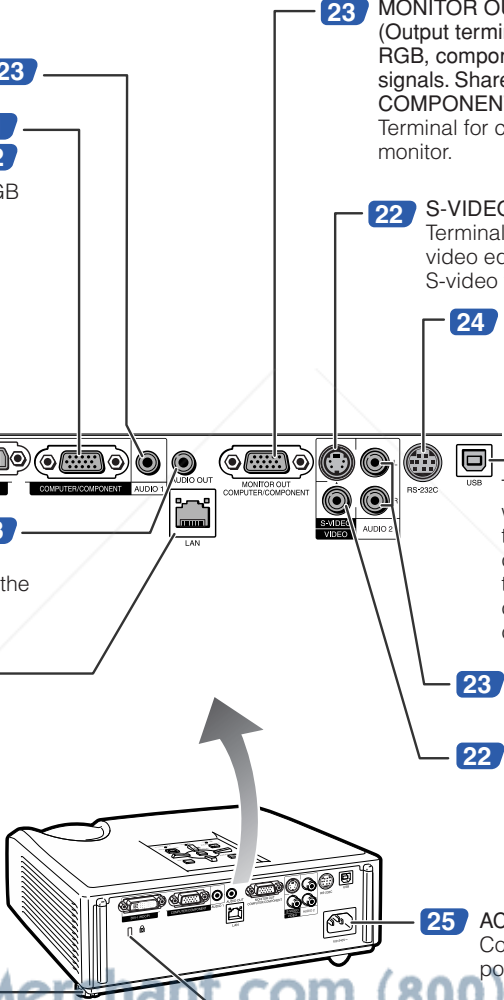

DiscountMerchant.com (800) 281-8860

THE TRUSTED SOURCE FOR PROJECTOR LAMPS AND ACCESSORIES

Kensington Security Standard connector

Using the Kensington Lock

- This projector has a Kensington Security Standard connector for use with a Kensington MicroSaver Security System. Refer to the information that came with the system for instructions on how to use it to secure the projector.

Part Names and Functions (Continued)

STANDBY button

For putting the projector into the standby mode.

26

COMPUTER, DVI, S-VIDEO, VIDEO buttons

For switching to the respective input modes.

30

BREAK TIMER button

For displaying the break time.

33

MAGNIFY buttons

For enlarging/reducing part of the image.

34

PAGE UP/PAGE DOWN buttons

Same as the [Page Down] and [Page Up] keys on a computer keyboard, when with the USB connection (using a USB cable or the optional remote receiver).

35

POINTER button

For displaying the pointer.

33

MOUSE/Adjustment buttons

- For moving the computer cursor when with the USB connection (using a USB cable or the optional remote receiver).
- For selecting and adjusting menu items.

35

39

L-CLICK/EFFECT button

- For the Left click when with the USB connection (using a USB cable or the optional remote receiver).
- For changing the pointer or spot area.

35

33

KEYSTONE button

For entering the Keystone Correction mode.

29

AUTO SYNC button

For automatically adjusting images when connected to a computer.

34

ECO+QUIET button

For lowering the noise of the cooling fan and extending the lamp life.

33

ON button

For turning the power on.

26

FREEZE button

For freezing images.

34

AV MUTE button

For temporarily displaying a black screen and turning off the sound.

30

VOL +/- (Volume) buttons

For adjusting the speaker sound level.

30

SPOT button

For displaying the spotlight.

33

ENTER button

For setting items selected or adjusted on the menu.

39

R-CLICK/RETURN button

- For the Right click when with the USB connection (using a USB cable or the optional remote receiver).
- For returning to the previous menu screen during menu operations.

35

39

MENU/HELP button

For displaying adjustment and setting screens, and help screen.

39

51

RESIZE button

For switching the picture size (NORMAL, STRETCH, etc.)

31

PICTURE MODE button

For selecting the appropriate picture.

34

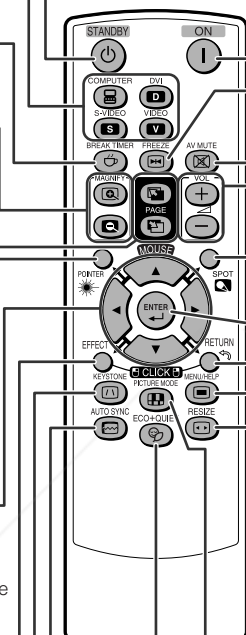

Discount-Merchant.com (800) 41-8860
 THE TRUSTED SOURCE FOR PROJECTOR LAMPS AND ACCESSORIES

Inserting the Batteries

1 Pull down the tab on the cover and remove the cover towards the direction of the arrow.

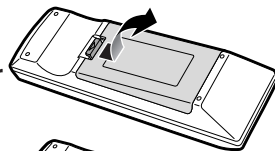

2 Insert the batteries.

- Insert the batteries making sure the polarities correctly match the \oplus and \ominus marks inside the battery compartment.

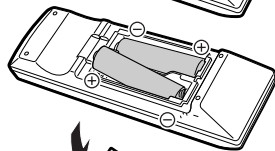

3 Insert the lower tab of the cover into the opening, and lower the cover until it clicks in place.

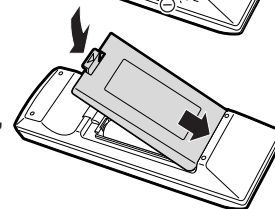

Incorrect use of the batteries may cause them to leak or explode. Please follow the precautions below.



Caution

- Danger of explosion if battery is incorrectly replaced. Replace only with alkaline or manganese batteries.
- Insert the batteries correctly making sure the polarities correctly match the \oplus and \ominus marks inside the battery compartment.
- Batteries of different types have different properties, therefore do not mix batteries of different types.
- Do not mix new and old batteries.
- This may shorten the life of new batteries or may cause old batteries to leak.
- Remove the batteries from the remote control once they have run out, as leaving them in can cause them to leak.
- Battery fluid from leaked batteries is harmful to skin, therefore ensure you wipe them first and then remove them using a cloth.
- The batteries included with this projector may run down in a short period, depending on how they are kept. Be sure to replace them as soon as possible with new batteries.
- Remove the batteries from the remote control if you will not be using the remote control for a long time.
- Comply with the rules (ordinance) of each local government when disposing of worn-out batteries.

Usable Range

The remote control can be used to control the projector within the ranges shown in the illustration.



Note

The signal from the remote control can be reflected off a screen for easy operation. However, the effective distance of the signal may differ depending on the screen material.

When using the remote control

- Ensure that you do not drop it or expose it to moisture or high temperature.
- The remote control may malfunction under a fluorescent lamp. In this case, move the projector away from the fluorescent lamp.

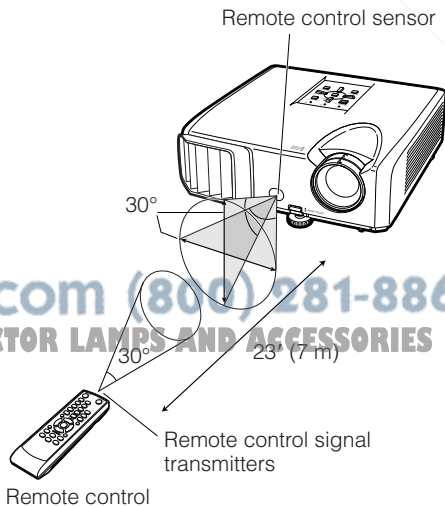

Quick Start

This section shows the basic operation (projector connecting with the computer). For details, see the page described below for each step.

Setup and Projection

In this section, connection of the projector and the computer is explained using one example.

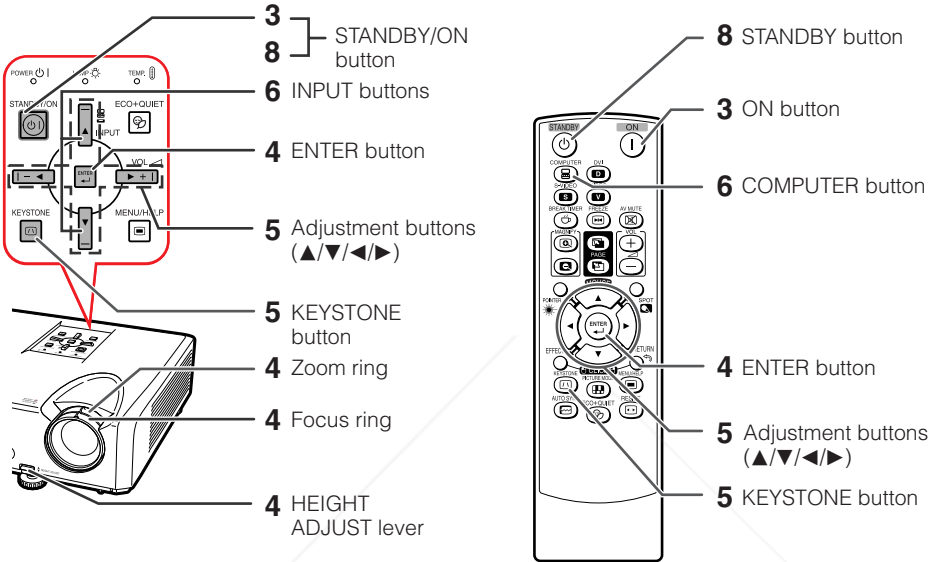

1. Place the projector facing a wall or a screen → P. 18

2. Connect the projector to the computer and plug the power cord into the AC socket of the projector

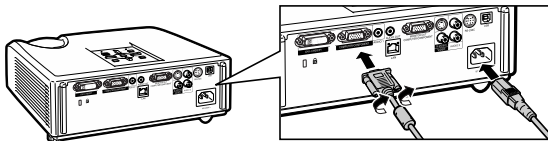

When connecting equipment other than a computer, see pages **22** and **23**.

→ PP. 21, 24, 25

3. Remove the lens cap and turn the projector on

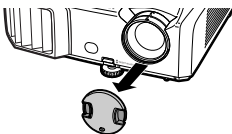

On the projector On the remote control



→ P. 26

4. Adjust the projected image with the Setup Guide

- 1 After the projector turns on, the Setup Guide appears.
(When "Setup Guide" is set to "On". See page 45.)
- 2 Follow the steps in the Setup Guide and adjust the focus, height (angle) and picture size.
- 3 After adjusting the focus, height (angle) and picture size, press **ENTER** to finish the Setup Guide.

➔ P. 27, 28

5. Correct trapezoidal distortion

Correcting trapezoidal distortion using Keystone Correction.

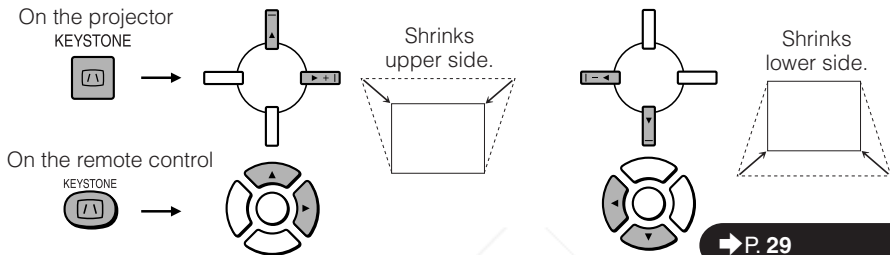

➔ P. 29

6. Select the INPUT mode

Select the "COMPUTER" using **INPUT** on the projector or **COMPUTER** on the remote control.

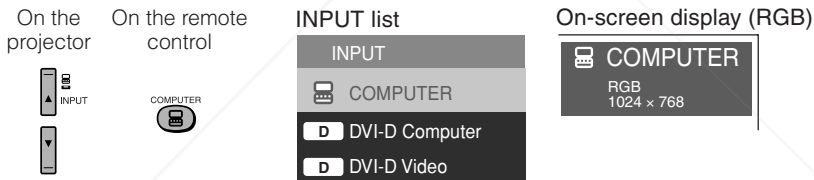

- When you press **INPUT** on the projector, the INPUT list appears. Press **▲/▼** to switch the INPUT mode.

➔ P. 30

7. Turn the computer on

8. Turn the power off

Press **STANDBY/ON** on the projector or **STANDBY** on the remote control, and then press the button again while the confirmation message is displayed to put the projector into standby mode.

Sponsored by DM



➔ P. 26

Setting up the Projector

Setting up the Projector

For optimal image quality, position the projector perpendicular to the screen with the projector's feet flat and level. Doing so will eliminate the need for Keystone correction and provide the best image quality. (See page 29.)

Standard Setup (Front Projection)

- Place the projector at the required distance from the screen according to the desired picture size. (See page 20.)

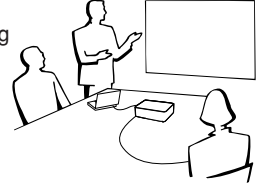

Example of standard setup

Side View

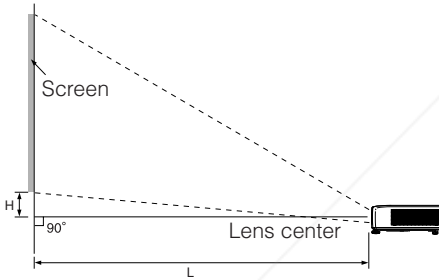

Note

- Refer to page 20 for additional information concerning "Screen Size and Projection Distance".

Ceiling-mount Setup

- It is recommended that you use the optional Sharp ceiling-mount adaptor and unit for this installation. Before mounting the projector, contact your nearest Sharp Authorized Projector Dealer or Service Center to obtain the recommended ceiling-mount adaptor and unit (sold separately).

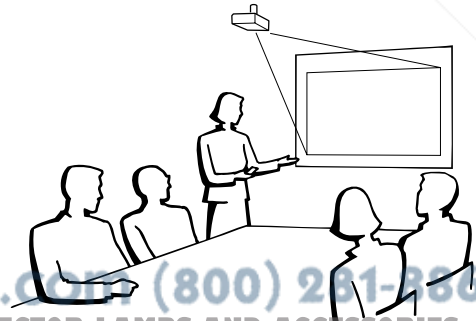

FIXED PRICE PROGRAM

Sponsored by 

Discount-Merchant.com (800) 261-8600

THE TRUSTED SOURCE FOR PROJECTOR LAMPS AND ACCESSORIES

Projection (PRJ) Mode

The projector can use any of the 4 projection modes shown in the diagram below. Select the mode most appropriate for the projection setting in use. (You can set the PRJ mode in "SCR-ADJ" menu. See page 45.)

- Table mounted, front projection
[Menu item → "Front"]

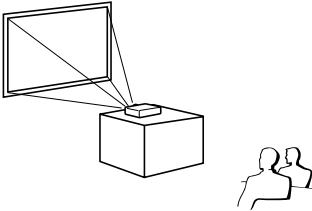

- Ceiling mounted, front projection
[Menu item → "Ceiling + Front"]

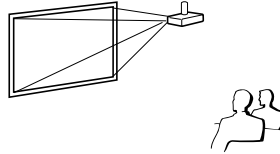

- Table mounted, rear projection (with a translucent screen)
[Menu item → "Rear"]

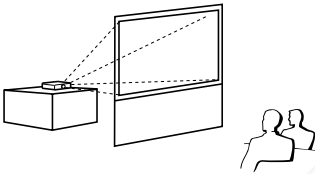

- Ceiling mounted, rear projection (with a translucent screen)
[Menu item → "Ceiling + Rear"]

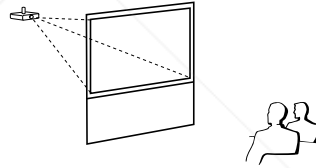

Indication of the Projection Image Size and Projection Distance

Example: 16:10 Signal Input (Normal Mode)

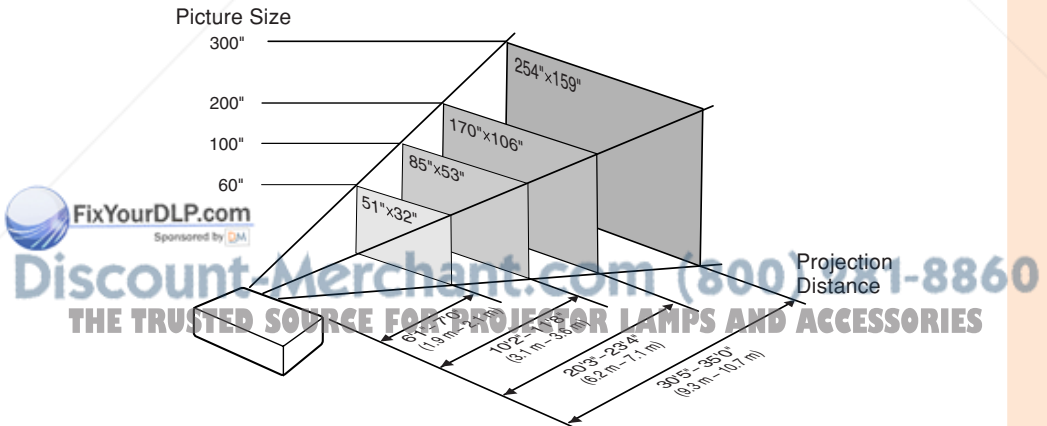

Setting up the Projector (Continued)

Screen Size and Projection Distance

16:10 Signal Input (Normal Mode)

Picture (Screen) size			Projection distance [L]		Distance from the lens center to the bottom of the image [H]
Diag. [X]	Width	Height	Minimum [L1]	Maximum [L2]	
300" (762 cm)	646 cm (254")	404 cm (159")	9.3 m (30' 5")	10.7 m (35' 0")	7 cm (2 ^{53/64} ")
250" (635 cm)	538 cm (212")	337 cm (132")	7.7 m (25' 4")	8.9 m (29' 2")	6 cm (2 ^{23/64} ")
200" (508 cm)	431 cm (170")	269 cm (106")	6.2 m (20' 3")	7.1 m (23' 4")	5 cm (1 ^{57/64} ")
150" (381 cm)	323 cm (127")	202 cm (79")	4.6 m (15' 2")	5.3 m (17' 6")	4 cm (1 ^{27/64} ")
120" (305 cm)	258 cm (102")	162 cm (64")	3.7 m (12' 2")	4.3 m (14' 0")	3 cm (1 ^{9/64} ")
100" (254 cm)	215 cm (85")	135 cm (53")	3.1 m (10' 2")	3.6 m (11' 8")	2 cm (1 ^{5/16} ")
80" (203 cm)	172 cm (68")	108 cm (42")	2.5 m (8' 1")	2.8 m (9' 4")	2 cm (3/4")
60" (152 cm)	129 cm (51")	81 cm (32")	1.9 m (6' 1")	2.1 m (7' 0")	1 cm (9/16")
40" (102 cm)	86 cm (34")	54 cm (21")	1.2 m (4' 1")	1.4 m (4' 8")	1 cm (3/8")

X: Picture size (diag.) (in/cm)

L: Projection distance (m/ft)

L1: Minimum projection distance (m/ft)

L2: Maximum projection distance (m/ft)

H: Distance from the lens center to the bottom of the image (cm/in)

The formula for picture size and projection distance

[m/cm]

L1 (m) = 0.0309X

L2 (m) = 0.0356X

H (cm) = 0.024X

[Feet/inches]

L1 (ft) = 0.0309X / 0.3048

L2 (ft) = 0.0356X / 0.3048

H (in) = 0.024X / 2.54

4:3 Signal Input (Normal Mode)

Picture (Screen) size			Projection distance [L]		Distance from the lens center to the bottom of the image [H]
Diag. [X]	Width	Height	Minimum [L1]	Maximum [L2]	
300" (762 cm)	610 cm (240")	457 cm (180")	10.5 m (34' 5")	–	8 cm (3 ^{13/64} ")
250" (635 cm)	508 cm (200")	381 cm (150")	8.7 m (28' 8")	10.1 m (33' 1")	7 cm (2 ^{43/64} ")
200" (508 cm)	406 cm (160")	305 cm (120")	7.0 m (22' 11")	8.1 m (26' 5")	5 cm (2 ^{9/64} ")
150" (381 cm)	305 cm (120")	229 cm (90")	5.2 m (17' 3")	6.0 m (19' 10")	4 cm (1 ^{39/64} ")
120" (305 cm)	244 cm (96")	183 cm (72")	4.2 m (13' 9")	4.8 m (15' 10")	3 cm (1 ^{9/32} ")
100" (254 cm)	203 cm (80")	152 cm (60")	3.5 m (11' 6")	4.0 m (13' 3")	3 cm (1 ^{1/16} ")
80" (203 cm)	163 cm (64")	122 cm (48")	2.8 m (9' 2")	3.2 m (10' 7")	2 cm (5/64")
70" (178 cm)	142 cm (56")	107 cm (42")	2.4 m (8' 0")	2.8 m (9' 3")	2 cm (3/4")
60" (152 cm)	122 cm (48")	91 cm (36")	2.1 m (6' 11")	2.4 m (7' 11")	2 cm (41/64")
40" (102 cm)	81 cm (32")	61 cm (24")	1.4 m (4' 7")	1.6 m (5' 3")	1 cm (27/64")

X: Picture size (diag.) (in/cm)

L: Projection distance (m/ft)

L1: Minimum projection distance (m/ft)

L2: Maximum projection distance (m/ft)

H: Distance from the lens center to the bottom of the image (cm/in)

The formula for picture size and projection distance

[m/cm]

L1 (m) = 0.03498X

L2 (m) = 0.0403X

H (cm) = 0.02717X

[Feet/inches]

L1 (ft) = 0.03498X / 0.3048

L2 (ft) = 0.0403X / 0.3048

H (in) = 0.02717X / 2.54

Note

- Refer to page 18 concerning "Projection distance [L]" and "Distance from the lens center to the bottom of the image [H]".
- Allow a margin of error in the values in the diagrams above.

Discount-Merchant.com (800) 281-8860
THE TRUSTED SOURCE FOR PROJECTOR LAMPS AND ACCESSORIES

Connecting the Projector to Other Equipment

Before connecting, ensure that the power cord of the projector is unplugged from the AC outlet and turn off the equipment to be connected. After making all connections, turn on the projector and then the other pieces of equipment. When connecting a computer, ensure that it is the last equipment to be turned on after all the connections are made.







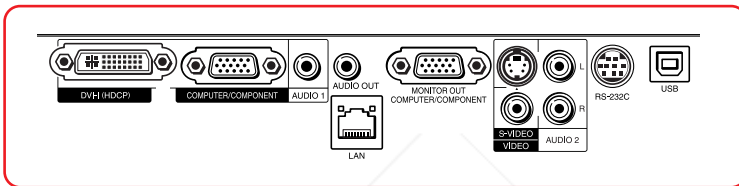

IMPORTANT:

Ensure that the appropriate input mode has been selected on the projector before you turn on the connected equipment.

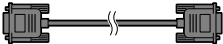
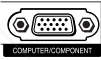
- For more details of connection and cables, refer to the operation manual of the connecting equipment.
- You may need other cables or connectors not listed below.

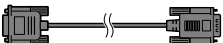
Terminals on the Projector

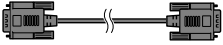













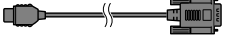

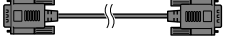

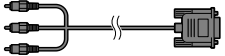
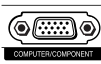

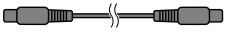
Equipment	Terminal on connected equipment	Cable	Terminal on the projector
	RGB output terminal 	RGB cable (supplied) 	COMPUTER/COMPONENT 
	RGB output terminal 	mini D-sub 15 pin to DVI cable (commercially available) 	DVI-I 
	DVI digital output terminal 	DVI Digital cable (commercially available) 	DVH (HDCP) 

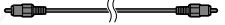
FixYourDLP.com
Sponsored by D.M.

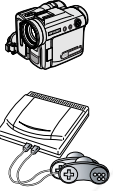
Note



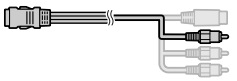





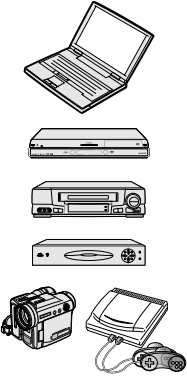

- See page 59, "Computer Compatibility Chart" for a list of computer signals compatible with the projector. Use with computer signals other than those listed may cause some of the functions to not work.
- A Macintosh adaptor may be required for use with some Macintosh computers. Contact your nearest Macintosh Dealer.
- **Depending on the computer you are using, an image may not be projected unless the computer's external output port is switched on (e.g. Press "Fn" and "F5" keys simultaneously when using a SHARP notebook computer). Refer to the specific instructions in your computer's operation manual to enable your computer's external output port.**

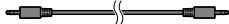
Connecting the Projector to Other Equipment (Continued)

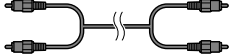
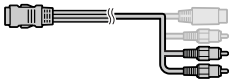
Equipment	Terminal on connected equipment	Cable	Terminal on the projector
	HDMI output terminal 	HDMI to DVI cable (commercially available) 	DVI-I 
	DVI digital output terminal 	DVI Digital cable (commercially available) 	
	Component video output terminal 	3 RCA to mini D-sub 15 pin cable (optional, AN-C3CP2) 	COMPUTER/COMPONENT 
	S-video output terminal 	S-video cable (commercially available) 	S-VIDEO 
	Video output terminal 	Video cable (commercially available) 	VIDEO 
	Component video output terminal	Cables for a camera or a video game/3 RCA to mini D-sub 15 pin cable (optional, AN-C3CP2)  RCA adaptor plug (commercially available)	COMPUTER/COMPONENT 
	S-video output terminal	Cables for a camera or a video game 	S-VIDEO 
	Video output terminal	Cables for a camera or a video game 	VIDEO 

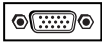
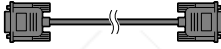

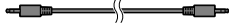
- While the projector is connected to video equipment that has an HDMI output terminal, only the video signal can be input to the projector. (Connect the AUDIO input terminal for audio input.)
- Depending on specifications of video equipment or HDMI to DVI digital cable, the signal transmission may not work properly. (The HDMI specification does not support all connections to video equipment that has HDMI digital output terminal using HDMI to DVI digital cable.)
- For details on compatibility for connection, see support information on DVI connection provided by the video equipment manufacturer.
- When you connect video equipment with a 21-pin RGB output (Euro-scart) to the projector, use a commercially available cable that fits in the projector terminal you want to connect.
- The projector does not support RGBC signals via the Euro-scart.

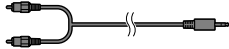
Equipment	Terminal on connected equipment	Cable	Terminal on the projector	
	ø3.5 mm audio output terminal 	ø3.5 mm stereo or mono audio cable (commercially available or available as Sharp service part QCNWGA038WJPZ) 	AUDIO 1 	
	RCA audio output terminal 	RCA audio cable (commercially available) 	Cables for a camera or a video game 	AUDIO 2 
	Audio output terminal			
Monitor 	RGB input terminal 	RGB cable (supplied or commercially available) 	MONITOR OUT 	
Amplifier 	ø3.5 mm audio input terminal	ø3.5 mm stereo or mono audio cable (commercially available or available as Sharp service part QCNWGA038WJPZ) 	AUDIO OUT 	
	RCA audio input terminal	ø3.5 mm stereo minijack to RCA audio cable (commercially available) 		

 **Note**

- When using the ø3.5 mm mono audio cable, the volume level will be half of when using the ø3.5 mm stereo audio cable.
- You can select "Audio 1" or "Audio 2" for "Audio Input" in the "PRJ-ADJ" menu. (See page 47.)
- RGB signals and Component signals can be output to the monitor.



Discount-Merchant.com (800) 281-8860
THE TRUSTED SOURCE FOR PROJECTOR LAMPS AND ACCESSORIES

Controlling the Projector by a Computer

When the RS-232C terminal on the projector is connected to a computer with a DIN-D-sub RS-232C adaptor and an RS-232C serial control cable (cross type, commercially available), the computer can be used to control the projector and check the status of the projector. Refer to the "SETUP MANUAL" contained on the supplied CD-ROM for "RS-232C Specifications and Commands".

When connecting to a computer using an RS-232C serial control cable and a DIN-D-sub RS-232C adaptor

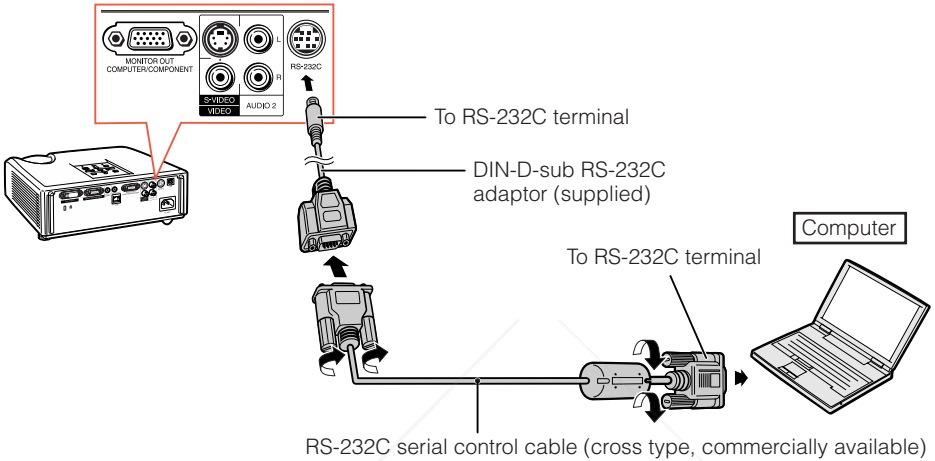

Note

- The RS-232C function may not operate if your computer terminal is not correctly set up. Refer to the operation manual of the computer for details.
- Refer to pages 2 to 8 of the "SETUP MANUAL" contained on the supplied CD-ROM for "Connecting Pin Assignments" and "RS-232C Specifications and Commands".

Info

- Do not connect the RS-232C cable to a port other than the RS-232C terminal on the computer. This may damage your computer or projector.
- Do not connect or disconnect an RS-232C serial control cable to or from the computer while it is on. This may damage your computer.

When connecting to the LAN terminal using a LAN cable

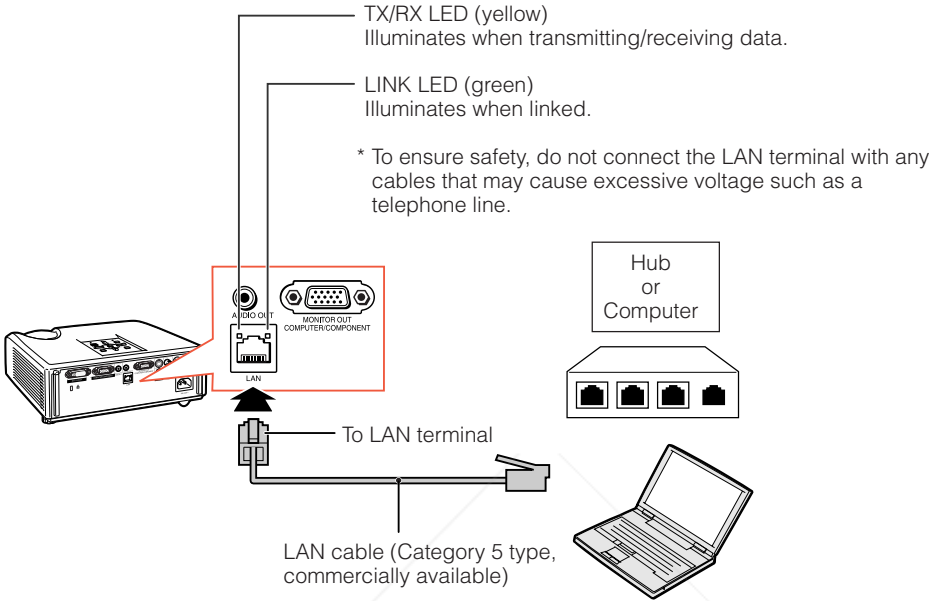

Note

- When connecting to a hub, use a straight-through Category 5 (CAT.5) type cable (commercially available).
- When connecting to a computer, use a cross-over Category 5 (CAT.5) type cable (commercially available).

Connecting the Power Cord

FixYourDLP.com
 Plug the supplied power cord into the AC socket on the rear of the projector.
 Then plug into AC outlet.
 DiscountMerchant.com (800) 831-8860
 THE TRUSTED SOURCE FOR PROJECTOR LAMPS AND ACCESSORIES

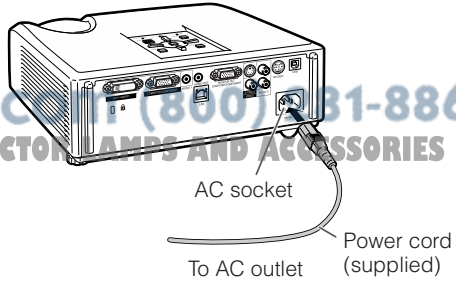

Turning the Projector On/Off

Turning the Projector on

Note that the connections to external equipment and power outlet should be done before performing the operations written below. (See pages 21 to 25.)

Remove the lens cap and press **STANDBY/ON on the projector or **ON** on the remote control.**

- The power indicator illuminates green.
- After the lamp indicator illuminates, the projector is ready to start operation.

Note

• About the Lamp Indicator

The lamp indicator illuminates to indicate the status of the lamp.

Green: The lamp is on.

Blinking in green: The lamp is warming up.

Red: The lamp is shut down abnormally or the lamp should be replaced.

- When switching on the projector, a slight flickering of the image may be experienced within the first minute after the lamp has been illuminated. This is normal operation as the lamp's control circuitry is stabilising the lamp output characteristics. It should not be regarded as faulty operation.
- If the projector is put into standby mode and immediately turned on again, the lamp may take some time to start projection.
- When System Lock is set, the keycode input box appears. To cancel the keycode setting, input the keycode that you have already set. See page 47 for details.

Info

• When “Auto Restart” is set to “On”:

- If the power cord is unplugged from the outlet or the breaker switch is turned off when the projector is on, then the projector automatically turns on when the power cord is plugged into the AC outlet or the breaker switch is turned on. (See page 46.)
- English is the factory default language. If you want to change the on-screen display to another language, change the language according to the procedure on page 45.

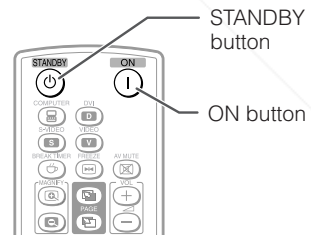
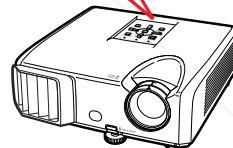
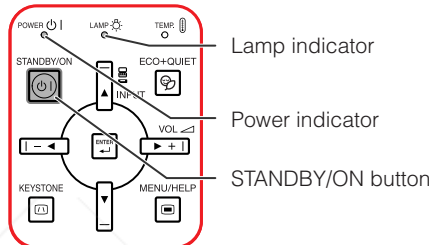

On-screen display (confirmation message)



Info

• Direct Power Off function:

- You can unplug the power cord from the AC outlet even if the cooling fan is still running.

Image Projection

About the Setup Guide

After turning on the projector, the Setup Guide screen appears to assist you with projector setup.

- Guidance items
- 1 FOCUS
- 2 HEIGHT ADJUST
- 3 ZOOM

Press **ENTER** to exit the Setup Guide screen.

Setup Guide screen

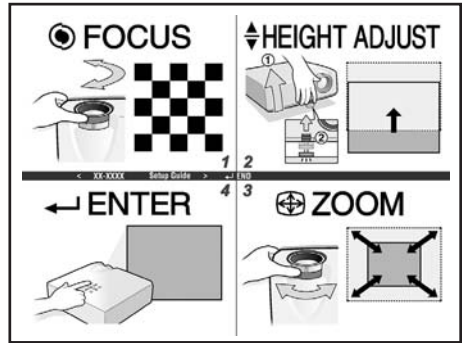

Note

- The Setup Guide screen automatically highlights the items in the following order:

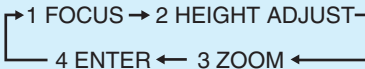

However, you can adjust the focus, height (angle), or zoom regardless of the highlighted item.

- If you do not want to display the Setup Guide for the next time, set "Menu" - "SCR - ADJ" - "Setup Guide" to "Off". (See page 45.)

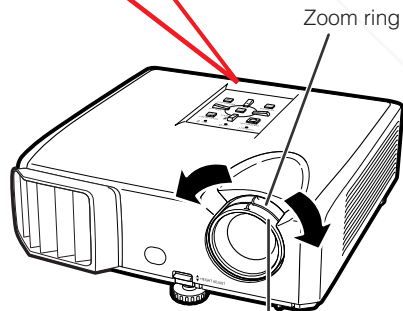
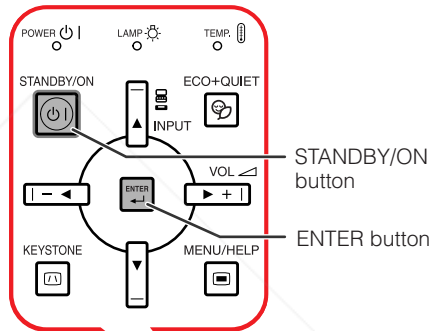

Adjusting the Projected Image

1 Adjusting the Focus

You can adjust the focus with the focus ring on the projector.

Rotate the focus ring to adjust the focus while watching the projected image.

2 Adjusting the Picture Size

You can adjust the picture size using the zoom ring on the projector.

Rotate the zoom ring to enlarge or shrink the picture size.

Image Projection (Continued)

3 Adjusting the Height

The height of the projector can be adjusted using the adjustment feet at the front and rear of the projector.

When the screen is above the projector, the projection image can be made higher by adjusting the projector.

1 Lift the projector to adjust its height while lifting the HEIGHT ADJUST lever.

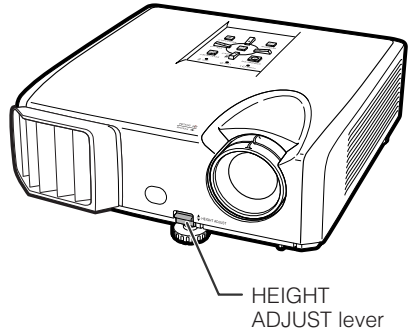

2 Remove your hands from the HEIGHT ADJUST lever of the projector after its height has been finely adjusted.

- The angle of projection is adjustable up to 9 degrees from the surface on which the projector is placed.

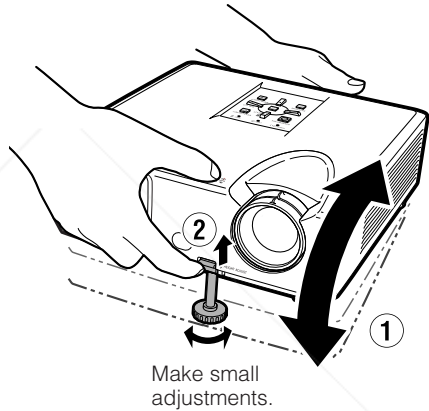

3 Use the rear adjustment foot to make the projector level.

- The projector is adjustable ± 2 degrees from the standard position.

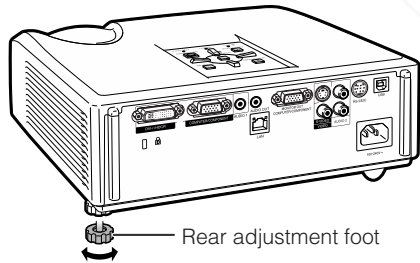

Note

- When adjusting the height of the projector, trapezoidal distortion occurs. Follow the procedures in Keystone Correction to correct the distortion. (See pages 29 and 44.)

FixYourDLP.com

Sponsored by D.M.

Info

- Do not apply too much pressure on the projector when the front adjustment foot comes out.
- When lowering the projector, be careful not to get your fingers caught in the area between the adjustment foot and the projector.
- Hold the projector firmly while lifting or carrying.
- Do not hold by the lens area.

Discount-Merchant.com (800) 281-8860
THE TRUSTED SOURCE FOR PROJECTOR LAMPS AND ACCESSORIES

Correcting Trapezoidal Distortion

When the image is projected either from the top or from the bottom towards the screen at an angle, the image becomes distorted trapezoidally. The function for correcting trapezoidal distortion is called **Keystone Correction**.

Note

- The Keystone Correction can be adjusted up to an angle of approximately ± 40 degrees and the screen can also be set up to an angle of approximately ± 40 degrees (when the resize mode is set to "NORMAL" (see page 31)).

1 Press **KEYSTONE** to enter the Keystone Correction mode.

- You can also display the on-screen display of the Keystone Correction mode with **KEYSTONE** on the projector.

2 Press **▲/▶** or **◀/▼** to adjust the Keystone Correction.

- You can also adjust the Keystone Correction using the adjustment buttons on the projector.

Note

- To return to the default setting, press **RETURN** while the on-screen display of the Keystone Correction mode is on the screen.

3 Press **KEYSTONE**.

- The on-screen display of the Keystone Correction mode will disappear.
- You can also use **KEYSTONE** on the projector.

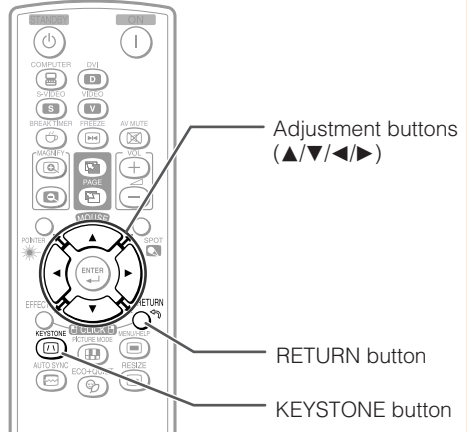

On-screen display (Keystone Correction mode)

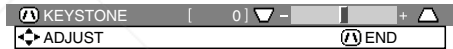

Shrinks upper side.
(Move the slide bar in the + direction.)

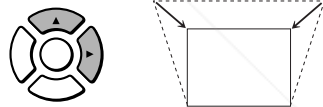

Shrinks lower side.
(Move the slide bar in the - direction.)

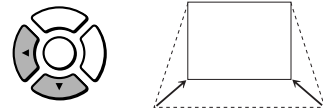

Info

- While adjusting the image using Keystone Correction, straight lines and the edges of the image may appear jagged.

Image Projection (Continued)

Switching the Input Mode

Select the appropriate input mode for the connected equipment.

Press **COMPUTER**, **DVI**, **S-VIDEO** or **VIDEO** on the remote control to select the input mode.

- When you press **INPUT** on the projector or **DVI** on the remote control, the INPUT list appears. Press **▲/▼** to switch the INPUT mode.

Adjusting the Volume

Press **VOL +/-** on the remote control or **-◀/▶+** on the projector to adjust the volume.

Note

- Pressing **VOL-/-◀** will lower the volume.
- Pressing **VOL+/-▶+** will raise the volume.
- When the projector is connected to external equipment, the volume level of the external equipment changes in accordance with the volume level of the projector. Set the projector's volume to the lowest level when turning the projector on/off or when changing the input signal.
- When you do not want to output the sound from the projector's speaker while the projector is connected to external equipment, set "Speaker" in "PRJ-ADJ" menu to "Off". (See page 46.)

Displaying the Black Screen and Turning off the Sound Temporarily

Press **AV MUTE** on the remote control to temporarily display a black screen and turn off the sound.

Note

- Pressing **AV MUTE** again will turn the projected image back on.

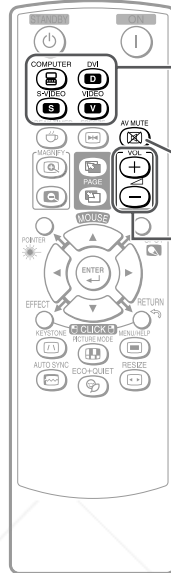

COMPUTER, DVI, S-VIDEO, VIDEO buttons

AV MUTE button

VOL +/- (Volume) buttons

On-screen display



On-screen display



Resize Mode

This function allows you to modify or customize the resize mode to enhance the input image. Depending on the input signal, you can choose a desired image.





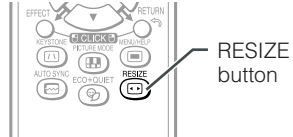





















Press RESIZE.

- See page 44 for setting on menu screen.



COMPUTER

		NORMAL	FULL	DOT BY DOT	STRETCH
4:3 aspect ratio	SVGA (800 × 600)	1068 × 800	1280 × 800	800 × 600	1280 × 720
	XGA (1024 × 768)			1024 × 768	
	SXGA (1152 × 864)			1152 × 864	
	SXGA+ (1400 × 1050)			1400 × 1050	
Other aspect ratios	SXGA (1280 × 1024)	1000 × 800	1280 × 800	1280 × 1024	—
	1280 × 720	1280 × 720		—	
	1360 × 768	1280 × 722		1360 × 768	
	1366 × 768	1280 × 720		1366 × 768	
	1280 × 768	1280 × 768		—	
	1280 × 800	1280 × 800		—	1280 × 720

Input signal		Output screen image			
Computer	Image Type	NORMAL	FULL	DOT BY DOT	STRETCH
Resolution XGA and below	 4:3 aspect ratio				 *1
				 *3	
SXGA (1280 × 1024)	 5:4 aspect ratio				 *1
1280 × 720	 16:9 aspect ratio	 *1		— *2	— *2
1360 × 768 1366 × 768	 16:9 aspect ratio				
1280 × 768	 15:9 aspect ratio	 *1			 *1
1280 × 800	 16:10 aspect ratio		— *2		 *1

■ : Cutout area on which images cannot be projected

⋯ : Area where the signals are off screen

























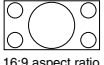



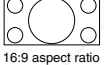

*1 The Image Shift function can be used for these images.

*2 Same as NORMAL mode.

*3 In case SXGA+ input.

Image Projection (Continued)

VIDEO/DTV

Input signal		Output screen image			
Video/DTV	Image Type	NORMAL	AREA ZOOM	V-STRETCH	STRETCH
480I, 480P, 576I, 576P, NTSC, PAL, SECAM	 4:3 aspect ratio				 *1
	 Squeeze				 *1
	 Letter box				 *1
720P, 1035I, 1080I, 1080P	 16:9 aspect ratio	 *1			— *2
	 16:9 aspect ratio	 *1			
540P	 16:9 aspect ratio	 *1			— *2
	 16:9 aspect ratio (4:3 aspect ratio in 16:9)	 *1			

 : Cutout area on which images cannot be projected

 : Area on which the image is not included in the original signals

*1 The Image Shift function can be used for these images.

*2 Same as NORMAL mode.

About Copyrights

When using the RESIZE function to select an image size with a different aspect ratio to a TV program or video image, the image will look different from its original appearance. Keep this in mind while choosing an image size.

- The use of the Resize or Keystone Correction function to compress or stretch the image for commercial purposes/public displays in a café, hotel, etc. may be an infringement of copyright protected by law for copyright holders. Please use caution.

Operating with the Remote Control

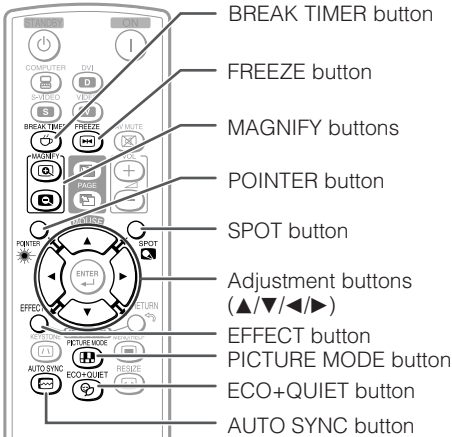

Displaying the Pointer

1 Press **POINTER** and press ▲/▼/◀/▶ on the remote control to move the pointer.

- Press **EFFECT** to change the pointer icon (5 types).

Star	Finger1	Finger2	Heart	Underline

2 Press **POINTER** again.

- The pointer will disappear.

Displaying and Setting the Break Timer

1 Press **BREAK TIMER**.

- The timer starts to count down from 5 minutes.

On-screen display



2 Press ▲/▼/◀/▶ to adjust the length of the break time.

- **Increases with ▲ or ▶**
5 minutes → 6 minutes → 60 minutes
- **Shortens with ◀ or ▼**
4 minutes → 3 minutes → 1 minute
- The break time can be set in units of one minute (up to 60 minutes).

FixYourDL.com
Canceling the break timer display function

Press **BREAK TIMER**.



Note

- Break Timer does not function while the projector is operating the "Auto Sync", "FREEZE" or "AV MUTE" functions.

Using the Spot Function

1 Press **SPOT** and press ▲/▼/◀/▶ on the remote control to move the spot area.

- Press **EFFECT** to change the spot area size (3 types).

1/9	1/25	1/8

2 Press **SPOT** again.

- The spot area will disappear.

Switching the Eco+Quiet Mode

Press **ECO+QUIET** to switch the Eco+Quiet mode between on and off.

- When the Eco+Quiet Mode is set to "ON", the sound of the cooling fan will turn down, the power consumption will decrease, and the lamp life will extend.



Note

- Refer to "Lamp Setting" on page 43 for details of the Eco+Quiet mode.

Operating with the Remote Control (Continued)

Auto Sync (Auto Sync Adjustment)

Auto Sync function works when detecting input signal after the projector turns on.

Press **AUTO SYNC** to manually adjust with Auto Sync function.



Note

- When the optimum image cannot be achieved with Auto Sync adjustment, use the help menu for manual adjustments. (See page 51.)

Freezing a Moving Image

1 Press **FREEZE**.

- The projected image is frozen.

2 Press **FREEZE** again to return to the moving image from the currently connected device.

Selecting the Picture Mode

You can select the appropriate picture mode for the projected image, such as movie or video game.

Press **PICTURE MODE**.

- When pressing **PICTURE MODE**, the picture mode changes in the following order:

[STANDARD → PRESENTATION → MOVIE → GAME → sRGB]*



Note

- See page 41 for details on the picture mode.

* "sRGB" is displayed only when RGB signal is input.

Displaying an Enlarged Portion of an Image

Graphs, tables and other portions of projected images can be enlarged. This is helpful when providing more detailed explanations.

1 Press **MAGNIFY** on the remote control.

- Enlarges the image.
- Pressing **MAGNIFY** or **MAGNIFY** enlarges or reduces the projected image.



Note

Press **MAGNIFY**.

x1 x2 x3 x4

Press **MAGNIFY**.

- You can change the location of the enlarged image using **▲**, **▼**, **◀** and **▶**.

2 Press **RETURN** on the remote control to cancel the operation.

- The magnification then returns to x1.



Note

- The selectable magnifications differ depending on the input signal.
- In the following cases, the image will return to the normal size (x1).
 - When switching the INPUT mode.
 - When **RETURN** has been pressed.
 - When the input signal is changed.
 - When the input signal resolution and refresh rate (vertical frequency) change.
 - When the Resize mode is changed.
 - When the Picture mode is changed.
 - When the Progressive mode is changed.

Using the Remote Control as the Wireless Computer Mouse

When connecting the projector and the computer with a USB cable, you can use the remote control as the computer mouse.

If the computer is placed too far away from the projector to be connected via the USB cable, the remote receiver (optional, AN-MR2) makes it possible to operate the projector with the remote control. For details, see the operation manual of the receiver.

Connecting with a USB cable

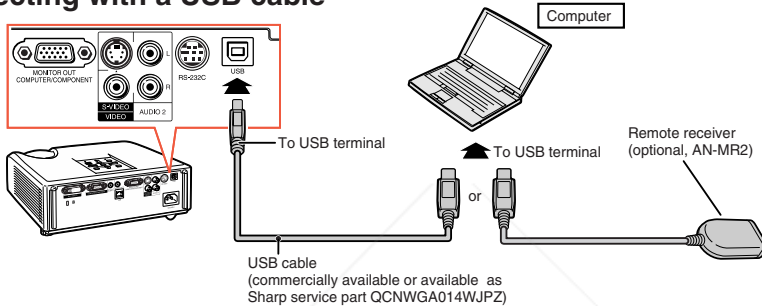

The mouse pointer can be operated in the following way after it is connected.

- **When moving the cursor**
Press MOUSE/Adjustment buttons (▲/▼/◀/▶).
- **When left-clicking**
Press **L-CLICK**.
- **When right-clicking**
Press **R-CLICK**.
- **When your computer supports only a one-click mouse (such as Macintosh)**
Press **L-CLICK** or **R-CLICK**.
L-CLICK and **R-CLICK** have common function.

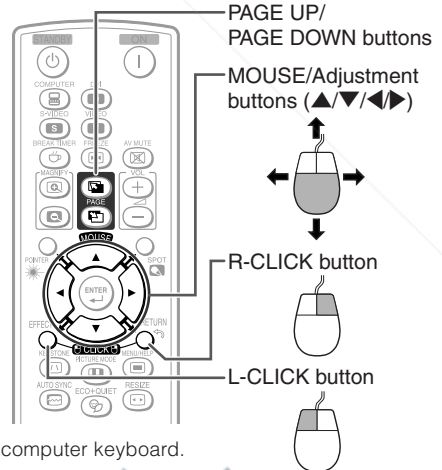

- **When using [Page Up] or [Page Down]**
Same as the [Page Up] and [Page Down] keys on a computer keyboard.
Press **PAGE UP** or **PAGE DOWN**.

Note

- This function only works with the Microsoft® Windows® OS and Mac OS®. However, this function does not work with the following operation systems that do not support USB.
 - Versions earlier than Windows® 95
 - Versions earlier than Windows® NT4.0
 - Versions earlier than Mac OS® 8.5
- You cannot use this function when displaying the menu screen.
- Confirm that the computer recognizes the USB connection.

Menu Items

The following shows the items that can be set in the projector.

“Picture” menu

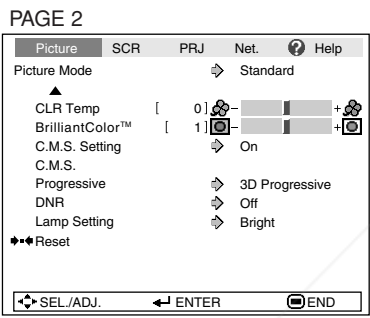
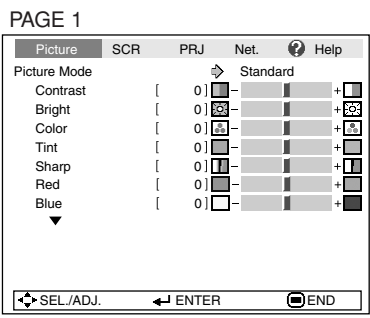

“C.M.S.”

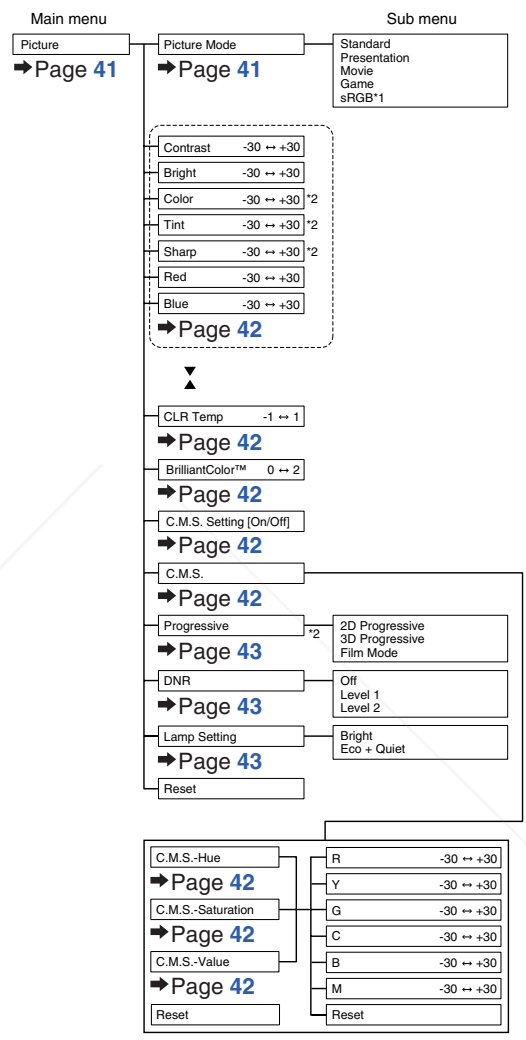
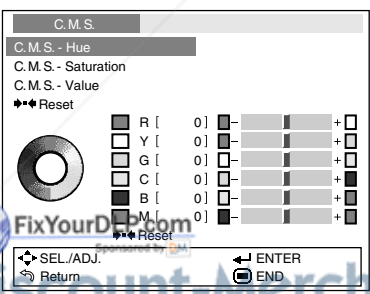

*1 Items when inputting RGB signal through COMPUTER or DVI.

*2 Items when inputting component signal through COMPUTER or DVI, or when selecting S-VIDEO or VIDEO.

“Screen adjustment (SCR-ADJ)” menu

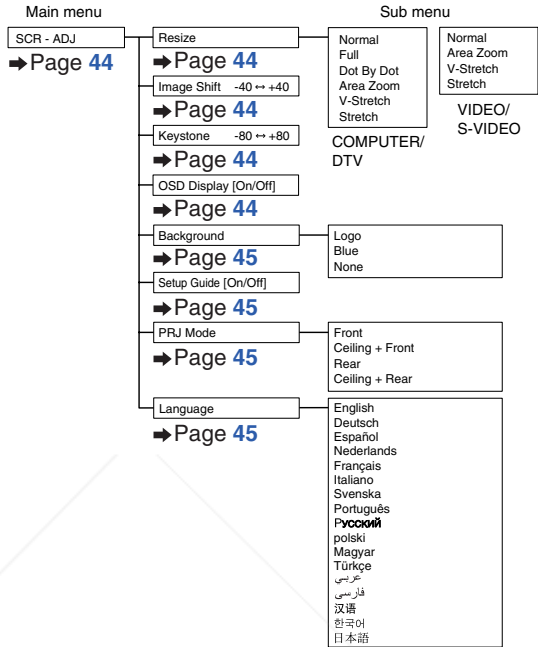
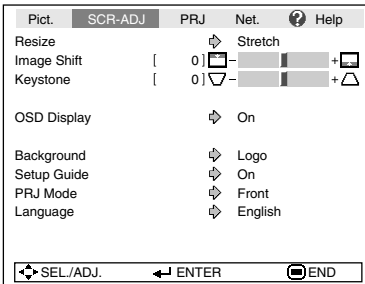

“Projector adjustment (PRJ-ADJ)” menu

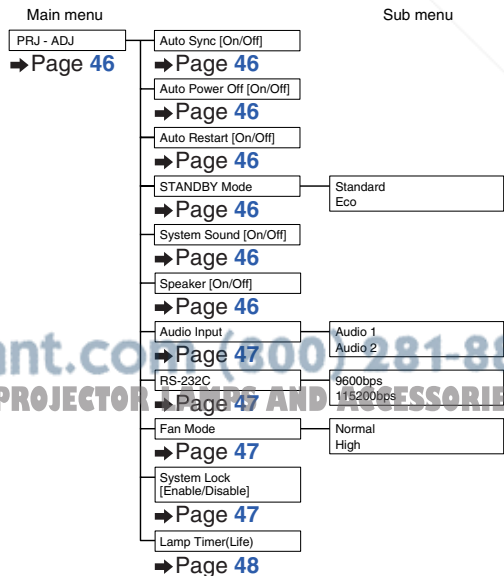
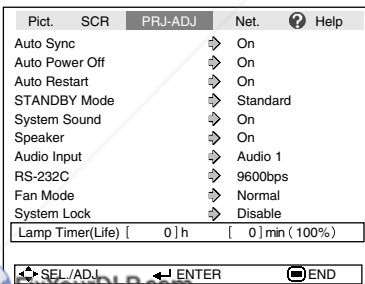

Discount-Merchant.com (200) 281-8860
 THE TRUSTED SOURCE FOR PROJECTOR PARTS AND ACCESSORIES

Useful Features

Menu Items (Continued)

“Network” menu

Pict.	SCR	PRJ	Network	? Help
Password			Disable	
DHCP Client			Off	
TCP/IP				
MAC Address	XX	: XX	: XX	: XX : XX : XX
Projector	XX	-XXXX		
↕ SEL./ADJ. ← ENTER END				

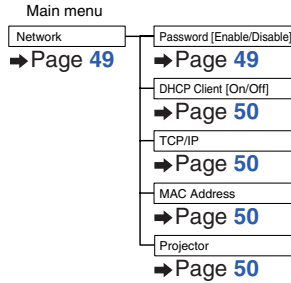

“Help” menu

Pict.	SCR	PRJ	Net.	? Help
<ul style="list-style-type: none"> • There is no picture or audio • Vertical stripes or flickering image appear • Data image is not centered • Color is faded or poor • Picture is dark • The image is distorted • Reset all adjustments to default settings 				
↕ SEL. ← ENTER END				

The items you can set with the “Help” menu

“Help” menu → Page 51

- Vertical stripes or flickering image appear
 - Auto Sync
 - Clock
 - Phase
 - Data image is not centered
 - Auto Sync
 - H-Pos
 - V-Pos
 - Color is faded or poor
 - COMPUTER/COMPONENT or DVI input
 - Signal type: Auto/RGB/Component
 - S-VIDEO or VIDEO input
 - Video System: Auto/PAL/SECAM/NTSC3.58/NTSC4.43/PAL-M/PAL-N/PAL-60
 - DVI (Digital) input
 - Dynamic range: Auto/Standard/Enhanced
- * The selectable items vary depending on the input signal and the selected input mode.



Discount-Merchant.com (800) 281-8860
THE TRUSTED SOURCE FOR PROJECTOR LAMPS AND ACCESSORIES

Using the Menu Screen

ENTER button

Adjustment buttons (▲/▼/◀/▶)

MENU/HELP button

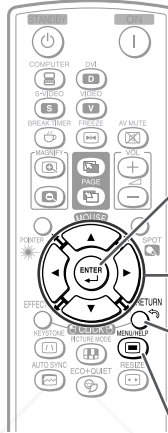
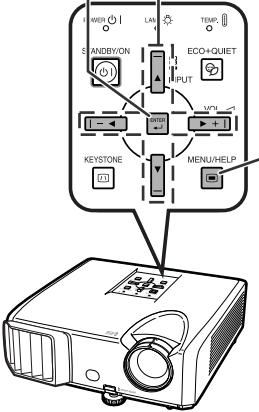

ENTER button

Adjustment buttons (▲/▼/◀/▶)

RETURN button
 • Press **RETURN** to return to the previous screen when the menu is displayed.

MENU/HELP button

Menu Selections (Adjustments)

Example: Adjusting “Bright”.

- This operation can also be performed by using the buttons on the projector.

1 Press MENU/HELP.
 • The “Picture” menu screen for the selected input mode is displayed.

2 Press ▶ or ◀ and select “Picture” to adjust.

Example: “Picture” screen menu for COMPUTER (RGB) input

Menu item

Picture	SCR	PRJ	Net.	Help
Picture Mode			Standard	
Contrast	[0]			
Bright	[0]			
Red	[0]			
Blue	[0]			
CLR Temp	[0]			
BrilliantColor™	[1]			
C.M.S. Setting			On	
C.M.S.			Off	
DNR			Bright	
Lamp Setting				
◆◆Reset				
◀◆SEL./ADJ.			↵ENTER	END



Discount-Merchant.com (800) 281-8150
 THE TRUSTED SOURCE FOR PROJECTOR LAMPS AND ACCESSORIES

Useful Features

Using the Menu Screen (Continued)

3 Press ▲ or ▼ and select “Bright” to adjust.

- The selected item is highlighted.

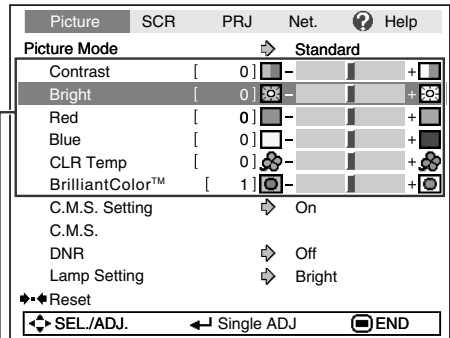

To adjust the projected image while watching it Press ENTER.

- The selected item (e.g. “Bright”) is displayed by itself at the bottom of the screen.
- When pressing ▲ or ▼, the following item (“Red” after “Bright”) will be displayed.

Note

- Press **ENTER** again to return to the previous screen.

Items to be adjusted

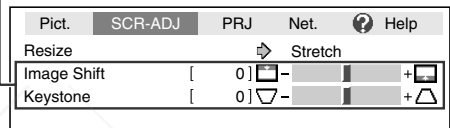

↑↓ Press ENTER.

The item displayed by itself



4 Press ◀ or ▶ to adjust the item selected.

- The adjustment is stored.

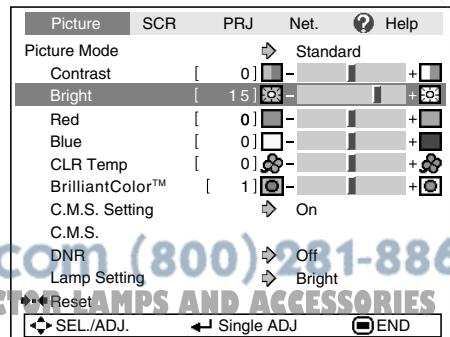

5 Press MENU/HELP

- The menu screen will disappear.

Note

- Menu buttons do not function while the projector is operating the “Auto Sync”, “Break Timer”, “FREEZE”, or “AV MUTE” functions.

Picture Adjustment (“Picture” Menu)

Menu operation → Page 39

▶ PAGE1

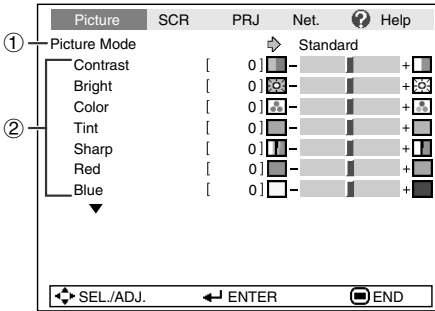

▶ PAGE2

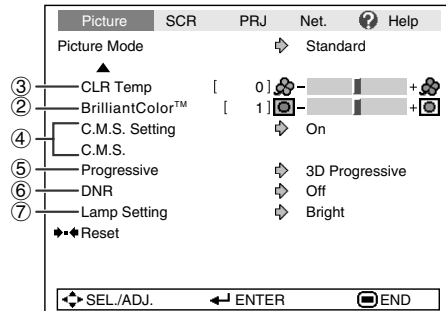

① Selecting the Picture Mode

Selectable items	Description	The default settings of each item when selecting Picture Mode		
		CLR Temp	BrilliantColor™	Lamp Setting
Standard	For standard image	0	1	Bright
Presentation	Brightens portions of image for more enhanced presentations.	0	2	Bright
Movie	Gives natural tint to the projected image.	-1	0	Eco + Quiet
Game	Gives sharpness to the projected image.	0	1	Bright
*sRGB	For high fidelity reproduction of images from a computer.	-	-	Bright

- “sRGB” is displayed only when RGB signal is input.
- You can set or adjust each item in the “Picture” menu to your preference. Any changes you make are retained in memory.

Note

- You can also press **PICTURE MODE** on the remote control to select the picture mode. (See page 34.)
 - *sRGB is an international standard of color reproduction regulated by the IEC (International Electrotechnical Commission). As the fixed color area has been decided by the IEC, the images are displayed in a natural tint based on an original image, when “sRGB” is selected. For additional information about the sRGB function, visit “<http://www.srgb.com/>”.
- You can also set the items, “Red”, “Blue”, “CLR Temp”, “BrilliantColor™”, when “sRGB” is selected.

Info

- When “sRGB” is selected, the projected image may become dark, but this does not indicate a malfunction.

Picture Adjustment (“Picture” Menu) (Continued)

Menu operation → Page 39

② Adjusting the Image

Adjustment items	◀ button	▶ button
Contrast	For less contrast.	For more contrast.
Bright	For less brightness.	For more brightness.
Color*1	For less color intensity.	For more color intensity.
Tint*1	For making skin tones purplish.	For making skin tones greenish.
Sharp*1	For less sharpness.	For more sharpness.
Red*2	For weaker red.	For stronger red.
Blue*2	For weaker blue.	For stronger blue.
BrilliantColor™*2 *3	For making the effect weaker.	For making the effect stronger.

*1 Not displayed in the RGB input mode.

*2 Not adjustable/selectable when selecting “sRGB”.

*3 BrilliantColor™ uses Texas Instruments’ BrilliantColor™ technology. As the BrilliantColor™ level is increased, the image becomes brighter while the color reproduction is kept at a high level.

Note

- “Red”, “Blue”, “BrilliantColor™” and “CLR Temp” cannot be set when “sRGB” is selected.
- To reset all adjustment items, select “Reset” and press **ENTER**.

③ Adjusting the Color Temperature

Selectable items	Description
-1	For lower color temperature for warmer, reddish incandescent-like images.
1	For higher color temperature for cooler, bluish, fluorescent-like images.

Note

- Values on “CLR Temp” are only for general standard purposes.

④ Adjusting the Colors

This function adjusts each of the six main colors that comprise the color wheel, altering their “Hue”, “Saturation”, or “Value”.

Selectable items	Description
C.M.S.-Hue	Sets the hue of the main colors.
C.M.S.-Saturation	Sets the saturation of the main colors.
C.M.S.-Value	Sets the brightness of the main colors.
Reset	The adjustments of “Hue”, “Saturation” and “Value” of all colors are reset to the default setting.

Adjusting “Hue”, “Saturation”, or “Value”.

- 1 Select “On” for “C.M.S. Setting” in the “Picture” menu and then press **ENTER**.
- 2 Select “C.M.S.” in the “Picture” menu and then press **ENTER**.
- 3 Press ▲ or ▼ to select either “Hue”, “Saturation”, or “Value” and then press **ENTER**.
- 4 Select the color to be adjusted with ▲ or ▼ and adjust it with ◀ or ▶.

Example of adjusting the “Hue”

Main colors	◀ button	▶ button
R (Red)	Closer to magenta	Closer to yellow
Y (Yellow)	Closer to red	Closer to green
G (Green)	Closer to yellow	Closer to cyan
C (Cyan)	Closer to green	Closer to blue
B (Blue)	Closer to cyan	Closer to magenta
M (Magenta)	Closer to blue	Closer to red

- When “Saturation” is selected, the selected color becomes
◀: lighter. ▶: thicker.
- When “Value” is selected, the selected color becomes
◀: darker. ▶: brighter.
- To reset the adjustment values of each color to the default settings, select “Reset” and press **ENTER**.

THE TRUSTED SOURCE FOR PROJECTOR LAMPS AND ACCESSORIES

⑤ Progressive

Selectable items	Description
2D Progressive	Useful to display fast-moving images such as sports.
3D Progressive	Useful to display relatively slow-moving images such as drama and documentary more clearly.
Film Mode	Reproduces the image of film source* clearly. Displays the optimized image of film transformed with three-two pull down (NTSC and PAL60Hz) or two-two pull down (PAL50Hz and SECAM) enhancement to progressive mode images.

* The film source is a digital video recording with the original encoded as is at 24 frames/second. The projector can convert this film source to progressive video at 60 frames/second with NTSC and PAL60Hz or at 50 frames/second with PAL50Hz and SECAM to play back a high-definition image.

Note

- In NTSC or PAL60Hz, even if the 3D Progressive mode has been set, the three-two pull down enhancement will be enabled automatically when the film source has been entered.
- When the image is blurred or noisy, switch to the optimal mode.

Info

- This function is available for 480I and 576I signals using COMPUTER/COMPONENT or DVI input.
- This function is available for all signals with S-VIDEO and VIDEO input.

⑥ Reducing Image Noise (DNR)

Video digital noise reduction (DNR) provides high quality images with minimal dot crawl and cross color noise.

Selectable items	Description
Off	The DNR function is not activated.
Level 1	Sets the DNR level for viewing a clearer picture.
Level 2	

Note

Set "DNR" to "Off" in the following cases:

- When the image is blurry.
- When the contours and colors of moving images drag.
- When TV broadcasts with weak signals are projected.

⑦ Lamp Setting

Selectable items	Brightness and Power consumption
Eco + Quiet	Approx. 80%
Bright	100%

Note

- In the Eco + Quiet mode, the fan sound and power consumption are lower than those in the Bright mode. (Projection brightness decreases as shown in the chart.)

Adjusting the Projected Image (“SCR - ADJ” Menu)

Menu operation → Page 39

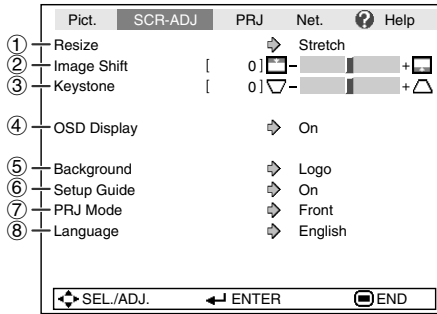

① Setting the Resize Mode

Note

- For details of the Resize mode, see pages 31 and 32.
- You can also press **RESIZE** on the remote control to set the resize mode. (See page 31.)

② Adjusting the Image Position

You can move the projected image vertically.

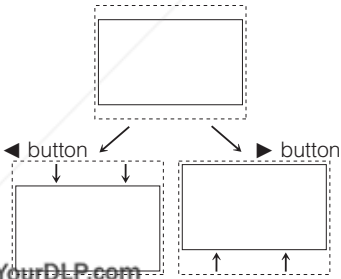

③ Keystone Correction

When the image is projected either from the top or from the bottom towards the screen at an angle, the image becomes distorted trapezoidally. The function for correcting trapezoidal distortion is called Keystone Correction.

Select “Keystone” on the “SCR-ADJ” menu and adjust with the slide bar.

See page 29 for details of Keystone Correction.

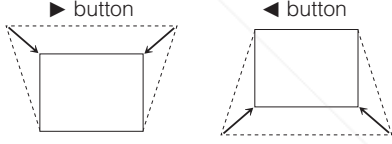

Note

- The Keystone Correction can be adjusted up to an angle of approximately ± 40 degrees (when “Resize” is set to “Normal”).
- You can also press **KEYSTONE** on the remote control or on the projector to adjust Keystone Correction.

④ Setting the On-screen Display

Selectable items	Description
On	All on-screen displays are displayed.
Off	INPUT/VOLUME/AV MUTE/FREEZE/AUTO SYNC/RESIZE/PICTURE MODE/ECO+QUIET/MAGNIFY/ “An invalid button has been pressed.” are not displayed.

Note

- This function only works in some RESIZE modes. (See pages 31 and 32.)

⑤ Selecting the Background Image

Selectable items	Description
Logo	Sharp logo screen
Blue	Blue screen
None	—

⑥ Selecting the Setup Guide

Selectable items	Description
On	Displaying the Setup Guide when turning the projector on.
Off	Not displaying the Setup Guide.

⑦ Reversing/Inverting Projected Images

Selectable items	Description
Front	Normal image (Projected from the front of the screen)
Ceiling + Front	Inverted image (Projected from the front of the screen with an inverted projector)
Rear	Reversed image (Projected from the rear of the screen or with a mirror)
Ceiling + Rear	Reversed and inverted image (Projected with a mirror)

See page 19 for details of Projection (PRJ) Mode.

⑧ Selecting the On-screen Display Language

The projector can switch the on-screen display language among 17 languages.

English
Deutsch
Español
Nederlands
Français
Italiano
Svenska
Português
Русский
polski
Magyar

▲
Türkçe
عربي
فارسی
汉语
한국어
日本語

Adjusting the Projector Function (“PRJ - ADJ” Menu)

Menu operation → Page 39

	Pict.	SCR	PRJ-ADJ	Net.	Help
①			Auto Sync	↔ On	
②			Auto Power Off	↔ On	
③			Auto Restart	↔ On	
④			STANDBY Mode	↔ Standard	
⑤			System Sound	↔ On	
⑥			Speaker	↔ On	
⑦			Audio Input	↔ Audio 1	
⑧			RS-232C	↔ 9600bps	
⑨			Fan Mode	↔ Normal	
⑩			System Lock	↔ Disable	
⑪			Lamp Timer(Life)	[0]h [0]min (100%)	

SEL/ADJ.
 ENTER
 END

① Auto Sync (Auto Sync Adjustment)

Selectable items	Description
On	Auto Sync adjustment will occur when the projector is turned on or when the input signals are switched, when connected to a computer.
Off	Auto Sync adjustment is not automatically performed.

Note

- Auto Sync adjustment is also performed by pressing **AUTO SYNC** on the remote control.
- The Auto Sync adjustment may take some time to complete, depending on the image of the computer connected to the projector.
- When the optimum image cannot be achieved with Auto Sync adjustment, use manual adjustments. (See page 51.)

② Auto Power Off Function

Selectable items	Description
On	When no input signal is detected for more than 15 minutes, the projector will automatically enter standby mode.
Off	The Auto Power Off function will be disabled.

Note

- When the Auto Power Off function is set to “On”, 5 minutes before the projector enters standby mode, the message “Enter STANDBY mode in X min.” will appear on the screen to indicate the remaining minutes.

③ Auto Restart Function

Selectable items	Description
On	If the power cord is unplugged from the outlet or the breaker switch is turned off when the projector is on, then the projector automatically turns on when the power cord is plugged into the AC outlet or the breaker switch is turned on.
Off	The projector does not turn on automatically when the power cord is plugged into the AC outlet or the breaker switch is turned on.

④ STANDBY Mode

When set to “Eco”, power consumption is reduced in standby mode.

Selectable items	Description
Eco	The monitor output, RS-232C and Network functions are switched off in standby mode.
Standard	The monitor output, RS-232C and Network functions are activated even if the projector is in standby mode.

⑤ Setting the Confirmation Sound (System Sound)

Selectable items	Description
On	A confirmation sound is made when the projector turns on/off.
Off	No confirmation sound is made.

⑥ Speaker Setting

Selectable items	Description
On	The audio signal is output from the internal speaker.
Off	The audio signal is not output from the internal speaker.

⑦ Audio Input

This function allows you to select an appropriate combination of audio input terminals for each input mode.

Selectable items	Description
Audio 1	The AUDIO 1 input terminal is used as an audio input terminal.
Audio 2	The AUDIO 2 input terminal is used as an audio input terminal.

⑧ Selecting the Transmission Speed (RS-232C)

Make sure that both the projector and computer are set for the same baud rate.

Selectable items	Description
9600bps	Transmission speed is slow.
	↑↓
115200bps	Transmission speed is rapid.

⑨ Fan Mode Setting

This function changes the fan rotation speed.

Selectable items	Description
Normal	Suitable for normal environments.
High	Select this when using the projector at altitudes of approximately 1,500 meters (4,900 feet) or more.

When “Fan Mode” is set to “High”, the fan rotation speeds up, and the fan noise becomes louder.

⑩ System Lock Function

This function prevents unauthorized use of the projector. Once this function is activated, users must enter the correct keycode each time the projector is turned on. **We suggest you record the keycode in a safe place where only authorized users have access.**

Info

- If you lose or forget your keycode, contact your nearest Sharp Authorized Projector Dealer or Service Center (see page 62). Even if the product warranty is valid, the keycode reset will incur a charge.

■ Setting/Changing the keycode

- Select “System Lock”, then press **ENTER** or ►.
- Select “Next”, then press **ENTER**.
 - The screen for entering the keycode appears.
- Press the 4 buttons on the remote control or on the projector to enter the preset keycode in “Old Code”.
 - When setting the keycode for the first time, press ▼ on the projector for four times.

Note

- If you input a wrong keycode, the cursor returns to the first point of the “Old Code”.
- The preset keycode is 4 ▼ buttons on the projector. When you press the ▼ button four times, the keycord input screen disappears.

- Press the 4 buttons on the remote control or on the projector to enter the new keycode in “New Code”.

Note

- You cannot use the following buttons for keycode: **STANDBY/ON, ON, STANDBY, ENTER, L-CLICK, R-CLICK/RETURN and MENU/HELP**
- System lock function recognizes each button on the remote control or on the projector as an individual button, even if they share the same button name. If you used the buttons on the projector in setting your keycode, the keycode cannot be canceled with the remote control.**

Adjusting the Projector Function (“PRJ - ADJ” Menu) (Continued)

5 Enter the same keycode in “Re-confirm”.

 **Note**

To cancel the keycode that you have already set

- Press ▼ on the projector for four times in steps 4 and 5 above.

When the System Lock is set

- When System Lock is set, the keycode input screen appears after the power is turned on. When it appears, enter the right keycode to start projection.

Input screen for keycode



11 Checking the Lamp Life Status

You can confirm the cumulative lamp usage time and the remaining lamp life (percentage).

Lamp usage condition	Remaining lamp life		
	"Life"	100%	5%
Operated exclusively with Lamp Setting set to "Eco +Quiet"	Approx. 4,000 hours	Approx. 200 hours	Approx. 200 hours
Operated exclusively with Lamp Setting set to "Bright"	Approx. 2,000 hours	Approx. 100 hours	Approx. 100 hours

 **Note**

- It is recommended that the lamp be changed when the remaining lamp life becomes 5%.
- The lamp life may vary depending on the usage condition.

Keylock Function

Locking the Operation Buttons on the Projector

Use this function to lock the operation buttons on the projector.

■ Locking the Operation Buttons

Hold down **ENTER** on the projector for about 5 seconds while the projector is being turned on.

On-screen display



- The keylock function does not affect the operation with the remote control buttons.
- You cannot use the keylock function while the projector is warming up.

■ Taking the Keylock off

Hold down **ENTER** on the projector for about 5 seconds.

On-screen display



- When the projector is in standby mode, you can release the keylock by holding down **ENTER** and **STANDBY/ON** on the projector simultaneously for about 5 seconds.

 **Info**

- Keylock cannot be set while the projector is: displaying the "Setup Guide" or "Menu" screens, in standby mode, warming up, changing input signals, operating "Auto Sync" function, in "FREEZE" mode or on the "System Lock" screen during warming up.

Setting up the Projector Network Environment (“Network” menu)

Menu operation → Page 39

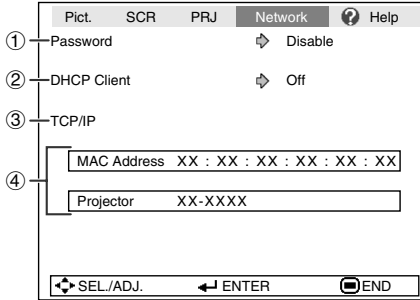

1 Setting a Password

If you do not want others to change the setting for the “Network” menu, set a password.

Setting a Password

1 Select “Password”, then press **ENTER** or **▶**.

- The screen for entering the password appears.

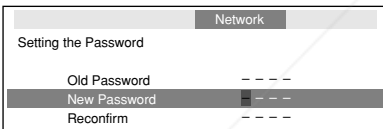

2 Press **▲** or **▼** to set the first digit in “New Password”, then press **▶**.

3 Enter the remaining 3 digits, then press **ENTER**.

- To return to the previous digit, press **◀**.

4 Enter the same password in “Reconfirm”, then press **ENTER**.

- The status for “Password” changes to “Enable”.

2 Enter the password in “Old Password” using **▲**, **▼**, **▶** and **◀**, then press **ENTER**.

3 Enter the password in “New Password” using **▲**, **▼**, **▶** and **◀**, then press **ENTER**.

4 Enter the same password again in “Reconfirm” using **▲**, **▼**, **▶** and **◀**, then press **ENTER**.

Note

- If you do not need the password protection for the “Network” menu settings anymore, press **ENTER** without entering new password in steps 3 and 4.
- To cancel the password settings, press **RETURN**.

If you forget the password

If you forget the password, perform the following procedure to delete it, then set a new password.

On the projector, press



Note

- If **ENTER** is held down for more than 5 seconds, the operation buttons on the projector will be locked. (See page 48.)
- You cannot use the buttons on the remote control to delete the password.

YourDLP.com
Note sponsored by DM

- Once after the password is set, you must enter the password to change the “Network” menu settings.

Changing the Password

1 Select “Password”, then press **ENTER** or **▶**.

- The screen for entering the password appears.

Setting up the Projector Network Environment (“Network” menu) (Continued)

Menu operation → Page 39

② DHCP Client Setting

Connect the LAN cable before turning the projector on. If not, the DHCP Client function does not work.

Selectable items	Description
On	Obtains configuration parameters for TCP/IP network automatically.
Off	Sets the TCP/IP manually.

Select “On” for “DHCP Client”. “Obtaining IP Address...” appears, then the menu screen appears. Confirm the parameters of IP Address, Subnet Mask and Gateway on the TCP/IP screen.

If the DHCP server is not available, “Could not obtain IP Address.” appears.

In this case, set the TCP/IP manually. (See the item ③.)

③ TCP/IP Setting

Set the TCP/IP manually.

1 Select “Off” for “DHCP Client”, then press **ENTER**.

2 Select “TCP/IP”, then press **ENTER**.

3 Enter “IP Address” using **▲, ▼, ►** and **◀**, then press **ENTER**.

Network	
Setting the TCP/IP	
IP Address	1 9 2 . 1 6 8 . 1 5 0 . 0 0 2
Subnet Mask	2 5 5 . 2 5 5 . 2 5 5 . 0 0 0
Gateway	0 0 0 . 0 0 0 . 0 0 0 . 0 0 0

4 Enter “Subnet Mask” using **▲, ▼, ►** and **◀**, then press **ENTER**.

5 Enter “Gateway” using **▲, ▼, ►** and **◀**, then press **ENTER**.

Selectable items	Description
IP Address	Factory default setting: 192.168.150.002 Enter an IP address appropriate for the network.
Subnet Mask	Factory default setting: 255.255.255.000 Set the subnet mask to the same as that of the computer and equipment on the network.
Gateway	Factory default setting: 000.000.000.000 * When not in use, set to “000.000.000.000”.

Note

- Confirm the existing network’s segment (IP address group) to avoid setting an IP address that duplicates the IP addresses of other network equipment or computers. If “192.168.150.002” is not used in a network with an IP address of “192.168.150.XXX”, you don’t have to change the projector IP address.
- For details about each setting, consult your network administrator.

④ Confirming the Projector Information

You can confirm the MAC address and projector name.

Displayed items	Description
MAC Address	The MAC address of the projector is displayed.
Projector	The projector name is displayed.

Note

- For information on how to change the projector name, see “SETUP MANUAL” contained in the supplied CD-ROM.

Troubleshooting with the “Help” Menu

This function advises you to solve the problems during usage.

Utilizing the “Help” Menu Functions

Example: When image flickering appears
Operation to solve image flickering when projecting the computer RGB signal.

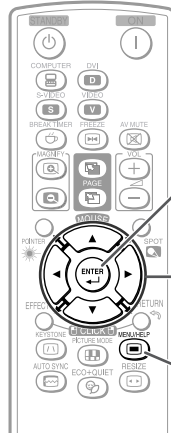

ENTER button

Adjustment buttons
(▲/▼/◀/▶)

MENU/HELP
button

1 Press **MENU/HELP**.

2 Press **◀** or **▶** to select “Help”, then press **ENTER**.

3 Press **▲** or **▼** to select “Vertical stripes or flickering image appears” on Help menu, then press **ENTER**.

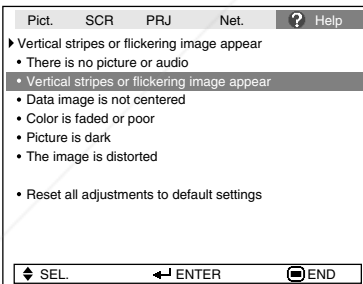

Press **ENTER**.

4 Select “Initiate “Auto Sync” Adjustments”, then press **ENTER**.

5 If the image is not improved, select “Adjust horizontal noise”, then press **ENTER**.

6 Press **◀** or **▶** to adjust.

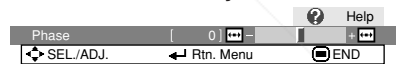

Note

- You can adjust the items with check marks (✓).
- The items in the “Help” menu change, depending on the input signal or setting that you have selected.
- If the problem is not solved, refer to “Troubleshooting” (see pages 60 and 61).
- When selecting “sRGB” in “Picture Mode”, the item “Color is faded or poor” is not displayed. This means you cannot change input signal types.

Maintenance

Cleaning the projector

- Ensure that you have unplugged the power cord before cleaning the projector.
- The cabinet as well as the operation panel is made of plastic. Avoid using benzene or thinner, as these can damage the finish on the cabinet.
- Do not use volatile agents such as insecticides on the projector.
Do not attach rubber or plastic items to the projector for long periods.
The effects of some of the agents in the plastic may cause damage to the quality or finish of the projector.
- Wipe off dirt gently with a soft flannel cloth.
- When the dirt is hard to remove, soak a cloth in a mild detergent diluted with water, wring the cloth well and then wipe the projector. Strong cleaning detergents may discolor, warp or damage the coating on the projector. Make sure to test on a small, inconspicuous area on the projector before use.

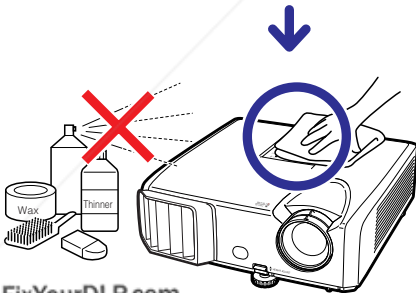

Cleaning the lens

- Use a commercially available blower or lens cleaning paper (for glasses and camera lenses) for cleaning the lens. Do not use any liquid type cleaning agents, as they may wear off the coating film on the surface of the lens.
- As the surface of the lens can easily get damaged, be careful not to scrape or hit the lens.

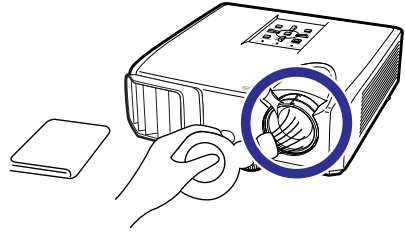

Cleaning the exhaust and intake vents

- Use a vacuum cleaner to clean dust from the exhaust vent and the intake vent.

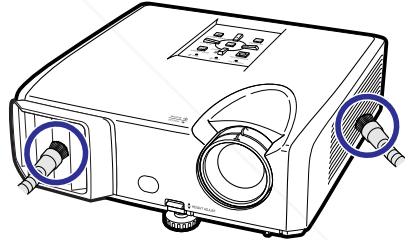

Info

- If you want to clean the air vents during projector operation, ensure you press **STANDBY/ON** on the projector or **STANDBY** on the remote control and put the projector into standby mode. After the cooling fan has stopped, clean the vents.

Maintenance Indicators

- The warning lights (power indicator, lamp indicator and temperature warning indicator) on the projector indicate problems inside the projector.
- If a problem occurs, either the temperature warning indicator or the lamp indicator will illuminate red, and the projector will enter standby mode. After the projector has entered standby mode, follow the procedures given below.

Top View

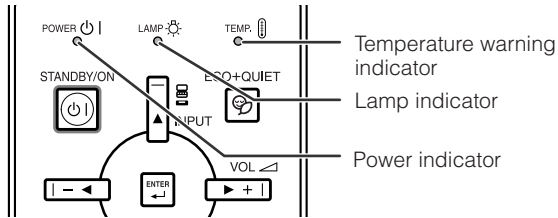

About the temperature warning indicator



If the temperature inside the projector increases, due to blockage of the air vents, or the setting location, "TEMP." will illuminate in the lower left corner of the picture. If the temperature keeps on rising, the lamp will turn off and the temperature warning indicator will blink, the cooling fan will run, and then the projector will enter standby mode. After "TEMP." appears, ensure you perform the measures described on page 54.

About the lamp indicator



- When the remaining lamp life becomes 5% or less, (yellow) and "Change The Lamp" will be displayed on the screen. When the percentage becomes 0%, it will change to (red), the lamp will automatically turn off and then the projector will automatically enter standby mode. At this time, the lamp indicator will illuminate in red.
- **If you try to turn on the projector a fourth time without replacing the lamp, the projector will not turn on.**

Indicators on the Projector

Power indicator	Red on	Normal (Standby)
	Green on	Normal (Power on)
	Red blinks	Abnormal (See page 54.)
Lamp indicator	Green blinks	Normal (Cooling)
	Green on	Normal
	Green blinks	The lamp is warming up.
Temperature warning indicator	Red on	The lamp is shut down abnormally or requires to be changed. (See page 54.)
	Off	Normal
Temperature warning indicator	Red on	The internal temperature is abnormally high. (See page 54.)
	Off	Normal

Maintenance Indicators (Continued)

	Maintenance indicator		Problem	Cause	Possible Solution
	Normal	Abnormal			
Temperature warning indicator	Off	Red on (Standby)	The internal temperature is abnormally high.	<ul style="list-style-type: none"> Blocked air intake 	<ul style="list-style-type: none"> Relocate the projector to an area with proper ventilation. (See page 8.)
				<ul style="list-style-type: none"> Cooling fan breakdown Internal circuit failure Clogged air intake 	<ul style="list-style-type: none"> Take the projector to your nearest Sharp Authorized Projector Dealer or Service Center (see page 62) for repair.
Lamp indicator	Green on (Green blinks when the lamp is warming up or turning off.)	Red on (Standby)	The lamp does not illuminate.	<ul style="list-style-type: none"> The lamp is shut down abnormally. 	<ul style="list-style-type: none"> Disconnect the power cord from the AC outlet, and then connect it again.
			Time to change the lamp.	<ul style="list-style-type: none"> Remaining lamp life becomes 5% or less. 	<ul style="list-style-type: none"> Carefully replace the lamp. (See page 55.) Take the projector to your nearest Sharp Authorized Projector Dealer or Service Center (see page 62) for repair. Please exercise care when replacing the lamp. Securely install the cover.
			The lamp does not illuminate.	<ul style="list-style-type: none"> Burnt-out lamp Lamp circuit failure 	
Power indicator	Green on/ Red on Green blinks (Cooling)	Red blinks	The power indicator blinks in red when the projector is on.	<ul style="list-style-type: none"> The lamp unit cover is open. 	<ul style="list-style-type: none"> If the power indicator blinks in red even when the lamp unit cover are securely installed, contact your nearest Sharp Authorized Projector Dealer or Service Center (see page 62) for advice.

Info

- If the temperature warning indicator illuminates, and the projector enters standby mode, follow the possible solutions above and then wait until the projector has cooled down completely before plugging in the power cord and turning the power back on. (At least 10 minutes.)
- If the power is turned off for a brief moment due to power outage or some other cause while using the projector, and the power supply recovers immediately after that, the lamp indicator will illuminate in red and the lamp may not be lit. In this case, unplug the power cord from the AC outlet, replace the power cord in the AC outlet and then turn the power on again.
- The cooling fan keeps the internal temperature of the projector constant and this function is controlled automatically. The sound of the cooling fan may change during operation because the fan speed may change and this is not a malfunction.



FixYourDLP.com

Sponsored by DM

Discount-Merchant.com (800) 281-8860
THE TRUSTED SOURCE FOR PROJECTOR LAMPS AND ACCESSORIES

Regarding the Lamp

Lamp

- It is recommended that the lamp (sold separately) be replaced when the remaining lamp life becomes 5% or less, or when you notice a significant deterioration in the picture and color quality. The lamp life (percentage) can be checked with the on-screen display. (See page 48.)
- Purchase a replacement lamp of type AN-F212LP from your place of purchase, nearest Sharp Authorized Projector Dealer or Service Center.

IMPORTANT NOTE TO U.S. CUSTOMERS:

The lamp included with this projector is backed by a 90-day parts and labor limited warranty. All service of this projector under warranty, including lamp replacement, must be obtained through a Sharp Authorized Projector Dealer or Service Center. For the name of the nearest Sharp Authorized Projector Dealer or Service Center, please call toll-free: 1-888-GO-SHARP (1-888-467-4277).

Hg LAMP CONTAINS MERCURY For State Lamp Disposal Information

www.lamprecycle.org or 1-800-BE-SHARP

U.S.A. ONLY

Caution Concerning the Lamp

- This projector utilizes a pressurized mercury lamp. A loud sound may indicate lamp failure. Lamp failure can be attributed to numerous sources such as: excessive shock, improper cooling, surface scratches or deterioration of the lamp due to a lapse of usage time.
The period of time up to failure largely varies depending on the individual lamp and/or the condition and the frequency of use. It is important to note that failure can often result in the bulb cracking.
- When the lamp replacement indicator and on-screen display icon are illuminated, it is recommended that the lamp be replaced with a new one immediately, even if the lamp appears to be operating normally.
- Should the lamp break, there is also a possibility that glass particles may spread inside of the projector. In such a case, it is recommended you contact your nearest Sharp Authorized Projector Dealer or Service Center to assure safe operation.
- Should the lamp break, the glass particles may spread inside the lamp cage or gas contained in the lamp may be vented into the room from the exhaust vent. Because the gas in this lamp includes mercury, ventilate the room well if the lamp breaks and avoid all exposure to the released gas. In case of exposure to the gas, consult a doctor as soon as possible.

Replacing the Lamp

Caution

- Do not remove the lamp unit from the projector right after use. The lamp will be very hot and may cause burns or injury.
Wait at least one hour after the power cord is disconnected to allow the surface of the lamp unit to fully cool before removing the lamp unit.
- Carefully change the lamp by following the instructions described in this section. * If you wish, you may have the lamp replaced at your nearest Sharp Authorized Projector Dealer or Service Center.

* If the new lamp does not light after replacement, take your projector to the nearest Sharp Authorized Projector Dealer or Service Center for repair.

Regarding the Lamp (Continued)

Removing and Installing the Lamp Unit

Warning!

- Do not remove the lamp unit from the projector right after use. The lamp and parts around the lamp will be very hot and may cause burns or injury.

Info

- Do not touch the glass surface of the lamp unit or the inside of the projector.
- To avoid injury to yourself and damage to the lamp, make sure you carefully follow the steps below.
- Do not loosen other screws except for the lamp unit cover and lamp unit.

Optional
accessory

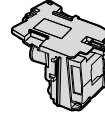

Lamp unit
AN-F212LP

STANDBY/ON button

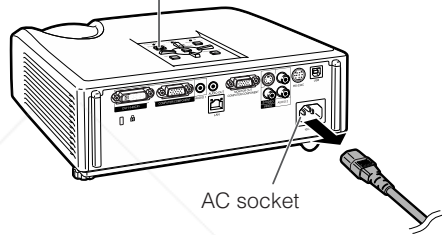

AC socket

- 1 Press **STANDBY/ON** on the projector or **STANDBY** on the remote control to put the projector into standby mode.**

- Wait until the cooling fan stops.

- 2 Disconnect the power cord.**

- Unplug the power cord from the AC socket.
- Leave the lamp until it has fully cooled down (about 1 hour).

- 3 Remove the lamp unit cover.**

- Turn the projector over. Loosen the user service screw (1) that secures the lamp unit cover. Remove the lamp unit cover (2).

User service screw
(for lamp unit cover)

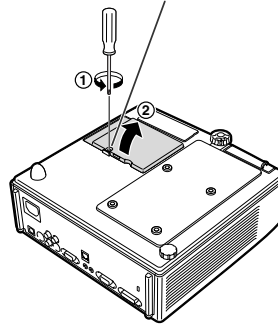

4 Remove the lamp unit.

- Loosen the securing screws from the lamp unit. Hold the lamp unit and pull it in the direction of the arrow. At this time, keep the lamp unit horizontal and do not tilt it.

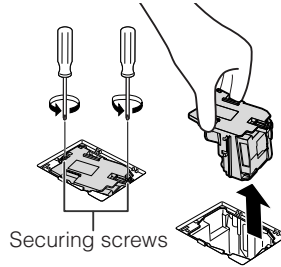

5 Insert the new lamp unit.

- Press the lamp unit firmly into the lamp unit compartment. Fasten the securing screws.

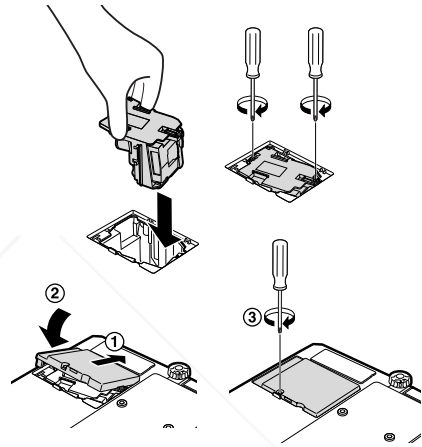

6 Replace the lamp unit cover.

- Align the tab on the lamp unit cover (1) and place it while pressing the tab (2) to close it. Then tighten the user service screw (3) to secure the lamp unit cover.

Info

- If the lamp unit and lamp unit cover are not correctly installed, the power will not turn on, even if the power cord is connected to the projector.

Resetting the Lamp Timer

Reset the lamp timer after replacing the lamp.

Info

- Make sure to reset the lamp timer only when replacing the lamp. If you reset the lamp timer and continue to use the same lamp, this may cause the lamp to become damaged or explode.

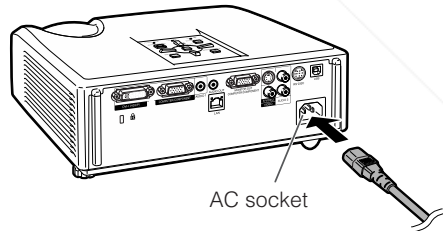

1 Connect the power cord.

- Plug the power cord into the AC socket of the projector.

2 Reset the lamp timer.

- While simultaneously holding down **MENU/HELP**, **ENTER** and **▼** on the projector, press **STANDBY/ON** on the projector.
- "LAMP 0000H" is displayed, indicating that the lamp timer is reset.

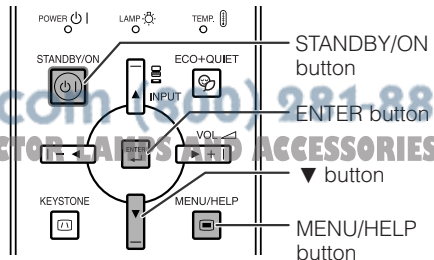

Storing the Projector

How to Use the Storage Case

When storing the projector, attach the lens cap to the lens, and place it in the supplied storage case.

1 Open the cover of the storage case.

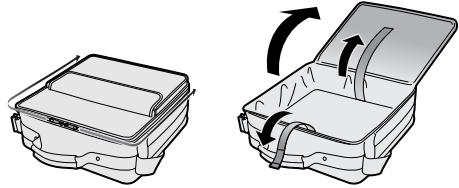

2 Place the projector into the storage case.

Info

- Ensure the projector has cooled down sufficiently before placing it in the case.
- When you place the projector into the storage case, make sure that the cooling fan has stopped.
- Ensure the lens cap is attached to the lens for protection.
- **Place the projector into the storage case with the lens facing the handle.**
- Ensure the projector is held in place by using the fixing band.
- Do not expose the storage case to direct sunlight or near heat sources. The storage case may change color or become deformed.

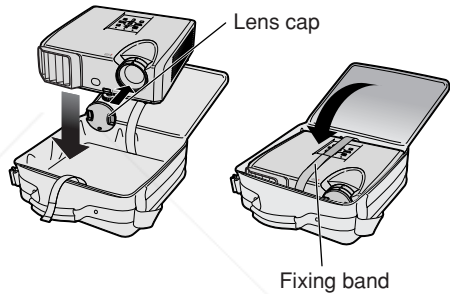

3 Close the cover of the storage case.

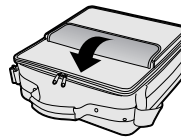

4 Place the accessories in the front pocket of the storage case.



Supplied accessories
(Remote control, etc.)

Computer Compatibility Chart

Computer

- Multiple signal support
- Horizontal Frequency: 15-110 kHz,
- Vertical Frequency: 45-85 Hz,
- Pixel Clock: 12-170 MHz
- Sync signal: Compatible with TTL level
- Compatible with sync on green signal

The following is a list of modes that conform to VESA. However, this projector supports other signals that are not VESA standards.

PC/MAC	Resolution	Horizontal Frequency (kHz)	Vertical Frequency (Hz)	VESA Standard	DVI-D Support	Display	
PC	VGA	640 × 350	27.0	60		✓	Upscale
			31.5	70			
			37.5	85	✓		
		640 × 400	27.0	60			
			31.5	70			
			37.9	85	✓		
		720 × 350	27.0	60			
			31.5	70			
			27.0	60			
		720 × 400	31.5	70			
			37.9	85	✓		
			26.2	50	✓		
	640 × 480	31.5	60	✓			
			34.7	70			
			37.9	72	✓		
		37.5	75	✓			
			43.3	85	✓		
			31.4	50	✓		
		35.2	56	✓			
			37.9	60	✓		
			46.6	70	✓		
		800 × 600	48.1	72	✓		
			46.9	75	✓		
			53.7	85	✓		
	XGA	1024 × 768	40.3	50	✓		
			48.4	60	✓		
			56.5	70	✓		
		60.0	75	✓			
			68.7	85	✓		
			45.0	60	✓		
		1280 × 720	47.8	60	✓		
			49.7	60	✓		
			62.8	75	✓		
		1280 × 800	47.7	60	✓		
			47.8	60	✓		
			55.0	70	✓		
	1280 × 768	66.2	70				
		67.5	75	✓			
		64.0	60	✓			
	1280 × 1024	80.0	75	✓			
		64.0	60	✓			
		65.3	60	✓			
	1400 × 1050	60	60	✓			
		640 × 1200	60	60	✓		
		640 × 480	34.9	60	✓		
MAC 13"	SVGA	832 × 624	49.7	75			
MAC 16"	XGA	1024 × 768	60.2	75		Upscale	
MAC 19"	XGA	1024 × 768	60.2	75			
MAC 21"	SXGA	1152 × 870	68.7	75		Intelligent Compression	





Note

- When this projector receives 640×350 VESA format VGA signals, "640 × 400" appears on the screen.
 - Optimum image quality will be achieved by matching your computer's output resolution to the resolution that corresponds to "True" in the "Display" column shown above.
 - When "Screen resolution" of the computer is different from the resolution displayed on the projected image, follow the procedures shown below.
 - Refer to "Select the resolution" for "Data image is not centered" on the Help menu and select the same resolution as the resolution in "Screen resolution" of the computer.
- Depending on the computer you are using, the output signal may not be faithful to the "Screen resolution" adjustment. Check the settings of the computer's signal output. If the settings cannot be changed, it is recommended that the resolution be set to the one that corresponds to "True" in the "Display" column.

DTV TRUSTED SOURCE FOR PROJECTOR LAMPS AND ACCESSORIES

Signal	Horizontal Frequency (kHz)	Vertical Frequency (Hz)	DVI-D Support (Compatible with HDCP)	Signal	Horizontal Frequency (kHz)	Vertical Frequency (Hz)	DVI-D Support (Compatible with HDCP)
480I	15.7	60		720P	45.0	60	✓
480P	31.5	60	✓	1035I	33.8	60	✓
540P	33.8	60		1080I	28.1	50	✓
576I	15.6	50		1080I	33.8	60	✓
576P	31.3	50	✓	1080P	56.3	50	✓
720P	37.5	50	✓	1080P	67.5	60	✓

Troubleshooting

Problem	Check	Page
 <p>No picture and no sound or projector does not start.</p>	<ul style="list-style-type: none"> Projector power cord is not plugged into the wall outlet. 	25
	<ul style="list-style-type: none"> Power to the external connected devices is off. 	–
	<ul style="list-style-type: none"> The selected input mode is wrong. 	30
	<ul style="list-style-type: none"> Cables are incorrectly connected to the projector. 	21–25
	<ul style="list-style-type: none"> Remote control battery has run out. 	15
	<ul style="list-style-type: none"> External output has not been set when connecting notebook computer. 	21
 <p>Sound is heard but no picture appears (or picture is dark).</p>	<ul style="list-style-type: none"> The lamp unit cover is not installed correctly. 	56, 57
	<ul style="list-style-type: none"> If the connected DVI digital equipment is turned on before the “DVI-D” input mode is selected on the projector, the image may not be projected properly or may not be displayed at all. Ensure that the appropriate input mode has been selected on the projector before you turn on the connected equipment. 	21
	<ul style="list-style-type: none"> Cables are incorrectly connected to the projector. “Bright” is set to minimum position. 	21–25 42
 <p>Color is faded or poor.</p>	<ul style="list-style-type: none"> Image adjustments are incorrectly set. Make adjustments of “Color” and “Tint” in “Picture Mode” and lower the “BrilliantColor™” value. 	42
	(Video Input only) <ul style="list-style-type: none"> Video input system is incorrectly set. 	51
 <p>Picture is blurred; noise appears.</p>	<ul style="list-style-type: none"> Adjust the focus. 	27
	<ul style="list-style-type: none"> The projection distance exceeds the focus range. 	20
	<ul style="list-style-type: none"> There is fog on the lens. If the projector is carried from a cold room into a warm room, or if it is suddenly heated, condensation may form on the surface of the lens and the image will become blurred. Set up the projector at least one hour before it is to be used. If condensation should form, remove the power cord from the wall outlet and wait for it to clear. 	–
 <p>Picture appears but no sound is heard.</p>	(Computer Input only) <ul style="list-style-type: none"> Perform Synchronization Adjustments (“Clock” and “Phase” Adjustment) Noise may appear depending on the computer. 	51 –
	<ul style="list-style-type: none"> Cables are incorrectly connected to the projector. 	21–25
Data image is not centered.	<ul style="list-style-type: none"> Volume is set to minimum. When the projector is connected to an external device and the volume is set to minimum, the sound is not output even if you turn up the volume of the external device. 	30
	<ul style="list-style-type: none"> “Speaker” is set to “Off” 	46
Data image is not centered.	<ul style="list-style-type: none"> Select “Data image is not centered” in the “Help” menu and make the necessary adjustments. 	51
	<ul style="list-style-type: none"> Depending on the computer you are using, the output resolution signal may be different from the one you have set. For details, refer to the operation manual of the computer. 	–

Problem	Check	Page
An unusual sound is occasionally heard from the cabinet.	<ul style="list-style-type: none"> If the picture is normal, the sound is due to cabinet shrinkage caused by room temperature changes. This will not affect operation or performance. 	–
Maintenance indicator on the projector illuminates or blinks in red.	<ul style="list-style-type: none"> See "Maintenance Indicators". 	53
The projector cannot be turned on or put into the standby mode using STANDBY/ON on the projector.	<ul style="list-style-type: none"> The keylock is set. If the keylock is set to "ON", all the buttons are locked. 	48
Picture is green on COMPUTER (Component)/ DVI (Component).	<ul style="list-style-type: none"> Change the input signal type setting. When you cannot select an input signal type, select "Color is faded or poor" in the "Help" menu, after selecting an item other than "sRGB" in "Picture Mode", and then select an input signal type. 	51 41, 51
Picture is pink (no green) on COMPUTER (RGB)/ DVI (RGB).		
Picture is too bright and whitish.	<ul style="list-style-type: none"> Image adjustments are incorrectly set. 	42
The cooling fan becomes noisy.	<ul style="list-style-type: none"> When temperature inside the projector increases, the cooling fan runs faster. 	8, 9 52, 53, 54
The lamp does not light up even after the projector turns on.	<ul style="list-style-type: none"> The lamp indicator is illuminating in red. Replace the lamp. 	53, 56
The lamp suddenly turns off during projection.		
The image sometimes flickers.	<ul style="list-style-type: none"> Cables are incorrectly connected to the projector or the connected equipment works improperly. Select "Vertical stripes or flickering image appear" in the "Help" menu and make the necessary adjustments. If this happens frequently, replace the lamp. 	21–25 51 56
The lamp needs much time to turn on.	<ul style="list-style-type: none"> The lamp will eventually need to be changed. While the remaining lamp life draws to a close, replace the lamp. 	56
Picture is dark.		
The remote control cannot be used.	<ul style="list-style-type: none"> Operate the remote control while pointing it at the projector's remote control sensor. The remote control may be too far away from the projector. If direct sunlight or a strong fluorescent lamp is shining on the projector's remote control sensor, place the projector where it will not be affected by strong light. 	15
		<ul style="list-style-type: none"> The batteries may be depleted or inserted incorrectly. Make sure the batteries are inserted correctly or insert new ones.

 **FixYourDLP.com**
 This unit is equipped with a microprocessor. Its performance could be adversely affected by incorrect operation or interference. If this should happen, unplug the Unit and plug it in again after more than 5 minutes.

Discount-Merchant.com (800) 281-8860
THE TRUSTED SOURCE FOR PROJECTOR LAMPS AND ACCESSORIES

For SHARP Assistance

If you encounter any problems during setup or operation of this projector, first refer to the “Troubleshooting” section on pages 60 and 61. If this operation manual does not answer your question, please contact the SHARP Service departments listed below.

U.S.A.	Sharp Electronics Corporation 1-888-GO-SHARP (1-888-467-4277) lcdsupport@sharpsec.com http://www.sharppusa.com	Benelux	SHARP Electronics Benelux BV 0900-SHARPCE (0900-7427723) Nederland 9900-0159 Belgium http://www.sharp.nl http://www.sharp.be http://www.sharp.lu
Canada	Sharp Electronics of Canada Ltd. (905) 568-7140 http://www.sharp.ca	Australia	Sharp Corporation of Australia Pty. Ltd. 1300-135-022 http://www.sharp.net.au
Mexico	Sharp Electronics Corporation Mexico Branch (525) 716-9000 http://www.sharp.com.mx	New Zealand	Sharp Corporation of New Zealand Phone: (09) 573-0111 Fax: (09) 573-0112 http://www.sharp.net.nz
Latin America	Sharp Electronics Corp. Latin American Group (305) 264-2277 www.servicio@sharpsec.com http://www.siempresharp.com	Singapore	Sharp-Roxy Sales (S) Pte. Ltd. 65-226-6556 ckng@srs.global.sharp.co.jp http://www.sharp.com.sg
Germany	Sharp Electronics (Europe) GMBH 01805-234675 http://www.sharp.de	Hong Kong	Sharp-Roxy (HK) Ltd. (852) 2410-2623 dcmktg@srh.global.sharp.co.jp http://www.sharp.com.hk
U.K.	Sharp Electronics (U.K.) Ltd. 08705 274277 http://www.sharp.co.uk/customersupport	Taiwan	Sharp Corporation (Taiwan) 0800-025111 http://www.sharp-scot.com.tw
Italy	Sharp Electronics (Italy) S.P.A. (39) 02-89595-1 http://www.sharp.it	Malaysia	Sharp-Roxy Sales & Service Co. (60) 3-5125678
France	Sharp Electronics France 01 49 90 35 40 hotlineced@sef.sharp-eu.com http://www.sharp.fr	U.A.E.	Sharp Middle East Fze 971-4-81-5311 helpdesk@smef.global.sharp.co.jp
Spain	Sharp Electronica Espana, S.A. 93 5819700 sharpplcd@sees.sharp-eu.com http://www.sharp.es	Thailand	Sharp Thebnakorn Co. Ltd. 02-236-0170 svc@stcl.global.sharp.co.jp http://www.sharp-th.com
Switzerland	Sharp Electronics (Schweiz) AG 0041 1 846 63 11 cattaneo@sez.sharp-eu.com http://www.sharp.ch	Korea	Sharp Electronics Incorporated of Korea (82) 2-3660-2002 lcd@sharp-korea.co.kr http://www.sharpkorea.co.kr
Sweden	Sharp Electronics (Nordic) AB (46) 8 6343600 vision.support@sen.sharp-eu.com http://www.sharp.se	India	Sharp Business Systems (India) Limited (91) 11- 6431313 service@sharp-oa.com
Austria	Sharp Electronics (Europe) GMBH Branch Office Austria 0043 1 727 19 123 pogats@sea.sharp-eu.com http://www.sharp.at		

FixYourDLP.com
 Sponsor of **DiscountMerchant.com (800) 281-8860**
THE TRUSTED SOURCE FOR PROJECTOR LAMP AND ACCESSORIES

Specifications

Model		PG-F255W
Display devices		0.65" DLP® Chip
Resolution		WXGA (1280 × 800)
Lens	F number	F 2.5 – 2.6
	Zoom	Manual, ×1.15 (f = 20.4 – 23.5 mm)
	Focus	Manual
Input terminals	DVI-I (Compatible with HDCP)	×1
	Computer/Component (mini D-sub 15 pin)	×1
	S-Video (mini DIN 4 pin)	×1
	Video (RCA)	×1
	Audio (ø3.5 mm stereo minijack)	×1
	Audio (RCA)	×1 (L/R)
Output terminals	Computer/Component (mini D-sub 15 pin)	×1
	Audio (ø3.5 mm stereo minijack)	×1 (variable audio output)
Control and communication terminals	LAN (RJ-45)	×1
	USB (Type B)	×1
	RS-232C (mini DIN 9 pin)	×1
Speakers		2 W (Mono)
Projection lamp		200 W
Rated voltage		AC 100 – 240 V
Rated frequency		50/60 Hz
Input current		2.9 A
Power consumption (Standby*)		267 W (10.5 W) with AC 100 V 259 W (11.0 W) with AC 240 V
Operation temperature		41°F to 95°F (+5°C to +35°C)
Cabinet		Plastic
Dimensions (main body only) [W × H × D]		10 41/64" × 3 33/64" × 10 7/16" (270 × 89 × 265 mm)
Weight (approx.)		6.4 lbs. (2.9 kg)

*Standby Mode: Standard

As a part of policy of continuous improvement, SHARP reserves the right to make design and specification changes for product improvement without prior notice. The performance specification figures indicated are nominal values of production units. There may be some deviations from these values in individual units.



Discount-Merchant.com (800) 281-8860
THE TRUSTED SOURCE FOR PROJECTOR LAMPS AND ACCESSORIES



Dimensions

Units: inches (mm)

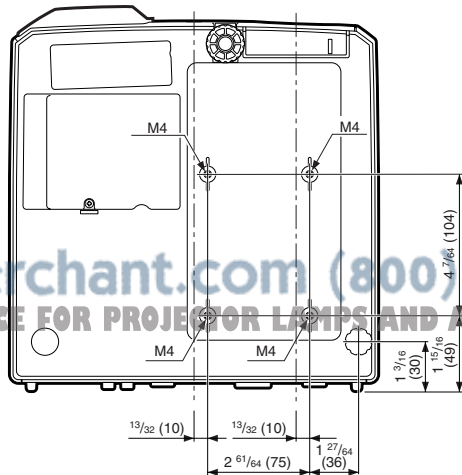
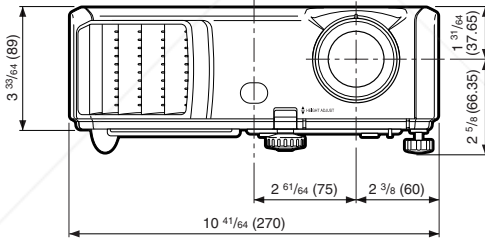
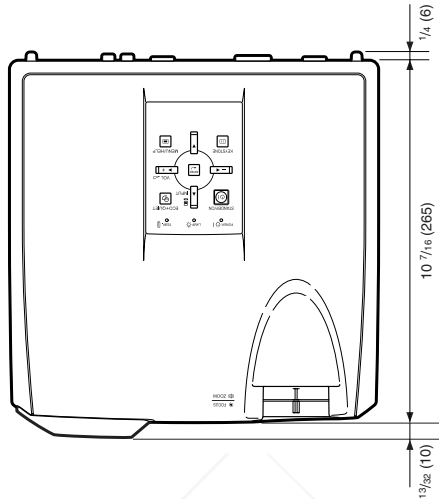

Discount-Merchant.com (800) 281-8860
THE TRUSTED SOURCE FOR PROJECTOR LAMPS AND ACCESSORIES

Index

Accessories	11	MAC Address	50
AC socket	25	MAGNIFY buttons	34
Adjustment buttons	39	MENU/HELP button	39, 51
AREA ZOOM	32	MONITOR OUT terminal	23
Aspect ratio	31	MOUSE/Adjustment buttons	35, 39
Audio Input	47	Network	49
AUDIO 1, 2 terminal	23	NORMAL	31, 32
AUDIO OUT terminal	23	ON button	26
Auto Power Off	46	Optional accessories	11
Auto Restart	46	OSD Display	44
Auto Sync (Auto Sync adjustment)	34, 38, 46, 51	PAGE DOWN button	35
AUTO SYNC button	34	PAGE UP button	35
AV MUTE button	30	Password	49
Background	45	PDF	10
Batteries	15	Picture Adjustment	41
Blue	42	Picture Mode	34, 41
BREAK TIMER button	33	PICTURE MODE button	34
Bright	42	POINTER button	33
BrilliantColor™	42	Power cord	25
CLR Temp (Color Temperature)	42	Power indicator	53
C.M.S.	42	PRJ - ADJ	46
Color	42	PRJ Mode	19, 45
COMPUTER button	30	Progressive	43
COMPUTER/COMPONENT input terminal	21, 22	R-CLICK/RETURN button	35, 39
Contrast	42	Rear adjustment foot	28
DHCP Client	50	Red	42
DIN-D-sub RS-232C adaptor	24	Remote control	14
DNR	43	Remote control sensor	15
DOT BY DOT	31	Replacing the lamp	55, 56
DVI button	30	Resize	31, 44
DVI-I input terminal	21, 22	RESIZE button	31
ECO+QUIET button	33	RGB cable	21
ENTER button	39	RS-232C terminal	24
Exhaust vent	12, 52	SCR - ADJ	44
Fan Mode	47	Screen Size and Projection Distance	20
Focus ring	27	Setup Guide	27, 45
FREEZE button	34	Sharp	42
Front adjustment foot	28	Speaker	46
FULL	31	SPOT button	33
HEIGHT ADJUST lever	28	STANDBY button	26
Help	51	STANDBY Mode	46
H-Pos	38, 51	STANDBY/ON button	26
Image shift	44	Storage case	58
INPUT modes	30	STRETCH	31, 32
Intake vent	12, 52	Supplied accessories	11
Kensington Security Standard connector	13	S-VIDEO button	30
Keycode	47	S-VIDEO terminal	22
Keypad	48	System Lock	47
KEYSTONE button	29	System Sound	46
Keystone Correction	29, 44	TCP/IP	50
Lamp	55	Temperature warning indicator	53
Lamp indicator	53	Tint	42
Lamp Setting	48	USB terminal	35
Lamp Timer (Life)	48	VIDEO button	30
Lamp unit	56	VIDEO terminal	22
Language (on-screen display language)	45	VOL (Volume) buttons	30
LAN terminal	25	V-Pos	38, 51
L-CLICK/EFFECT button	33, 35	V-STRETCH	32
Lens Cap	12	Zoom ring	27

SHARP®

SHARP CORPORATION



Discount-Merchant.com (800) 281-8860

THE TRUSTED SOURCE FOR PROJECTOR LAMPS AND ACCESSORIES



Disclaimer

This user manual is provided as a free service by FixYourDLP.com. FixYourDLP is in no way responsible for the content of this manual, nor do we guarantee its accuracy. FixYourDLP does not make any claim of copyright and all copyrights remain the property of their respective owners.

About FixYourDLP.com

FixYourDLP.com (<http://www.fixyourdpl.com>) is the World's #1 resource for media product news, reviews, do-it-yourself guides, and manuals.

Informational Blog: <http://www.fixyourdpl.com>

Video Guides: <http://www.fixyourdpl.com/guides>

User Forums: <http://www.fixyourdpl.com/forum>

FixYourDLP's Fight Against Counterfeit Lamps:

<http://www.fixyourdpl.com/counterfeits>

Sponsors:

RecycleYourLamp.org – Free lamp recycling services for used lamps:

<http://www.recycleyourlamp.org>

Lamp Research - The trusted 3rd party lamp research company:

<http://www.lampresearch.com>

Discount-Merchant.com – The worlds largest lamp distributor:

<http://www.discount-merchant.com>



FixYourDLP.com

Sponsored by 