



Disclaimer

This user manual is provided as a free service by FixYourDLP.com. FixYourDLP is in no way responsible for the content of this manual, nor do we guarantee its accuracy. FixYourDLP does not make any claim of copyright and all copyrights remain the property of their respective owners.

About FixYourDLP.com

FixYourDLP.com (<http://www.fixyourdpl.com>) is the World's #1 resource for media product news, reviews, do-it-yourself guides, and manuals.

Informational Blog: <http://www.fixyourdpl.com>

Video Guides: <http://www.fixyourdpl.com/guides>

User Forums: <http://www.fixyourdpl.com/forum>

FixYourDLP's Fight Against Counterfeit Lamps:

<http://www.fixyourdpl.com/counterfeits>

Sponsors:

RecycleYourLamp.org – Free lamp recycling services for used lamps:

<http://www.recycleyourlamp.org>

Lamp Research - The trusted 3rd party lamp research company:

<http://www.lampresearch.com>

Discount-Merchant.com – The worlds largest lamp distributor:

<http://www.discount-merchant.com>



FixYourDLP.com

Sponsored by 

SHARP®

MULTIMEDIA PROJECTOR

MODEL

XR-20X/XR-20S

XR-10X/XR-10S

OPERATION MANUAL

Introduction

Quick Start

Setup

Connections

Basic
Operation

Useful
Features

Appendix

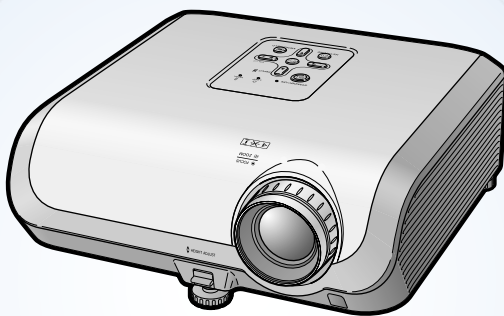

Direct-Merchant.com (800) 281-8860
BEST SOURCE FOR PROJECTOR LAMPS AND ACCESSORIES



IMPORTANT

- For your assistance in reporting the loss or theft of your Projector, please record the Model and Serial Number located on the bottom of the projector and retain this information.
- Before recycling the packaging, please ensure that you have checked the contents of the carton thoroughly against the list of "Supplied accessories" on page 10.

Model No.:

Serial No.:

SPECIAL NOTE FOR USERS IN THE U.K.

The mains lead of this product is fitted with a non-rewireable (moulded) plug incorporating a 10A fuse. Should the fuse need to be replaced, a BSI or ASTA approved BS 1362 fuse marked  or  and of the same rating as above, which is also indicated on the pin face of the plug, must be used.

Always refit the fuse cover after replacing the fuse. Never use the plug without the fuse cover fitted.

In the unlikely event of the socket outlet in your home not being compatible with the plug supplied, cut off the mains plug and fit an appropriate type.

DANGER:

The fuse from the cut-off plug should be removed and the cut-off plug destroyed immediately and disposed of in a safe manner.

Under no circumstances should the cut-off plug be inserted elsewhere into a 13A socket outlet, as a serious electric shock may occur.

To fit an appropriate plug to the mains lead, follow the instructions below:

WARNING:

THIS APPARATUS MUST BE EARTHED.

IMPORTANT:

The wires in this mains lead are coloured in accordance with the following code:

| | |
|------------------|-----------|
| Green-and-yellow | : Earth |
| Blue | : Neutral |
| Brown | : Live |

As the colours of the wires in the mains lead of this apparatus may not correspond with the coloured markings identifying the terminals in your plug proceed as follows:

- The wire which is coloured green-and-yellow must be connected to the terminal in the plug which is marked by the letter E or by the safety earth symbol  or coloured green or green-and-yellow.
- The wire which is coloured blue must be connected to the terminal which is marked with the letter N or coloured black.
- The wire which is coloured brown must be connected to the terminal which is marked with the letter L or coloured red.

IF YOU HAVE ANY DOUBT, CONSULT A QUALIFIED ELECTRICIAN.

THE TRUSTED SOURCE FOR PROJECTOR LAMPS AND ACCESSORIES

This apparatus complies with the requirements of Council Directives 89/336/EEC and 73/23/EEC as amended by Council Directive 93/68/EEC.

Dieses Gerät entspricht den Anforderungen der EG-Richtlinien 89/336/EWG und 73/23/EWG mit Änderung 93/68/EWG.

Ce matériel répond aux exigences contenues dans les directives 89/336/CEE et 73/23/CEE modifiées par la directive 93/68/CEE.

Dit apparaat voldoet aan de eisen van de richtlijnen 89/336/EEG en 73/23/EEG, gewijzigd door 93/68/EEG.

Dette udstyr overholder kravene i direktiv nr. 89/336/EEC og 73/23/EEC med tillæg nr. 93/68/EEC.

Quest' apparecchio è conforme ai requisiti delle direttive 89/336/EEC e 73/23/EEC, come emendata dalla direttiva 93/68/EEC.

Αυτή η συσκευή συμμορφώνεται με τις απαιτήσεις των οδηγιών του Συμβουλίου 89/336/ΕΟΚ και 73/23/ΕΟΚ όπως τροποποιήθηκαν από την οδηγία του Συμβουλίου 93/68/ΕΟΚ.

Este equipamento obedece às exigências das directivas 89/336/CEE e 73/23/CEE, na sua versão corrigida pela directiva 93/68/CEE.

Este aparato satisface las exigencias de las Directivas 89/336/CEE y 73/23/CEE, modificadas por medio de la 93/68/CEE.

Denna utrustning uppfyller kraven enligt riktlinjerna 89/336/EEC och 73/23/EEC så som kompletteras av 93/68/EEC.

Dette produktet oppfyller betingelsene i direktivene 89/336/EEC og 73/23/EEC i endringen 93/68/EEC.

Tämä laite täyttää direktiivien 89/336/EEC ja 73/23/EEC vaatimukset, joita on muutettu direktiivillä 93/68/EEC.

Bu cihaz Konsey Direktifi 93/68/EEC tarafından düzeltilen 89/336/EEC ve 73/23/EEC Konsey Direktiflerinin gerekliliklerine uygundur.

Tento přístroj je v souladu s požadavky směrnic rady 89/336/EEC a 73/23/EEC, tak jak byly upraveny směrnicí rady 93/68/EEC.

See seade on vastavuses Nõukogu Direktiivis nr 89/336/EEC ja 73/23/EEC esitatud nõuetega, vastavalt Nõukogu Direktiivis nr 93/68/EEC esitatud parandustele

Ez a készülék megfelel a Tanács által kiadott, 89/336/EGK és 73/23/EGK Irányelveknek és az utóbbi módosító 93/68/EGK Irányelvnek

Ši ierice atbilst tehnikam prasibam pec 89/336/EEC un 73/23/EEC direktivam papildinats ar direktivu 93/68/EEC.

Šis prietais atitinka ES Tarybos direktyvu 89/336/EEC ir 73/23/EEC patikslintos direktyvos 93/68/EEC reikalavimus.

To urzadzenie spelnia wymagania dyrektyw 89/336/EEC i 73/23/EEC wraz z poprawkami dyrektywy 93/68/EEC.

Tento prístroj je v súlade s požiadavkami smerníc rady 89/336/EEC a 73/23/EEC tak ako boli upravené smernicou rady 93/68/EEC.

Ta aparat je v skladu z zahtevami Direktiv Sveta 89/336/EEC in 73/23/EEC kot je navedeno v dopolnilu k Direktivi Sveta 93/68/EEC.

The supplied CD-ROM contains operation instructions in English, German, French, Swedish, Spanish, Italian, Dutch, Portuguese, Chinese (Traditional Chinese and Simplified Chinese) and Korean. Carefully read through the operation instructions before operating the projector.

Die mitgelieferte CD-ROM enthält Bedienungsanleitungen in Englisch, Deutsch, Französisch, Schwedisch, Spanisch, Italienisch, Niederländisch, Portugiesisch, Chinesisch (Traditionelles Chinesisch und einfaches Chinesisch) und Koreanisch. Bitte lesen Sie die Bedienungsanleitung vor der Verwendung des Projektors sorgfältig durch.

Le CD-ROM fourni contient les instructions de fonctionnement en anglais, allemand, français, suédois, espagnol, italien, néerlandais, portugais, chinois (chinois traditionnel et chinois simplifié) et coréen. Veuillez lire attentivement ces instructions avant de faire fonctionner le projecteur.

Den medföljande CD-ROM-skivan innehåller bruksanvisningar på engelska, tyska, franska, svenska, spanska, italienska, holländska, portugisiska, kinesiska (traditionell kinesiska och förenklad kinesiska) och koreanska. Läs noga igenom bruksanvisningen innan projektorn tas i bruk.

El CD-ROM suministrado contiene instrucciones de operación en inglés, alemán, francés, sueco, español, italiano, holandés, portugués, chino (chino tradicional y chino simplificado) y coreano. Lea cuidadosamente las instrucciones de operación antes de utilizar el proyector.

Il CD-ROM in dotazione contiene istruzioni per l'uso in inglese, tedesco, francese, svedese, spagnolo, italiano, olandese, portoghese, cinese (cinese tradizionale e cinese semplificato) e coreano. Leggere attentamente le istruzioni per l'uso prima di usare il proiettore.

De meegeleverde CD-ROM bevat handleidingen in het Engels, Duits, Frans, Zweeds, Spaans, Italiaans, Nederlands, Portugees, Chinees (Traditioneel Chinees en Vereenvoudigd Chinees) en Koreaans. Lees de handleiding zorgvuldig door voor u de projector in gebruik neemt.

O CD-ROM fornecido contém instruções de operação em Inglês, Alemão, Francês, Sueco, Espanhol, Italiano, Holandês, Português, Chinês, (Chinês Tradicional e Chinês Simplificado) e Coreano. Leia cuidadosamente todas as instruções de operação antes de operar o projetor.

附送之CD-ROM光碟中，有用英文、德文、法文、瑞典文、西班牙文、意大利文、荷蘭文、葡萄牙文、中文（繁體中文和簡體中文）和韓國文所寫的使用說明書。在操作本投影機之前，請務必仔細閱讀整本使用說明書。

附送之CD-ROM光碟中，有用英文、德文、法文、瑞典文、西班牙文、意大利文、荷蘭文、葡萄牙文、中文（繁体中文和简体中文）和韩国文所写的使用说明书。在操作本投影机之前，请务必仔细阅读整本使用说明书。

제공된 CD-ROM에는 영어, 독일어, 프랑스어, 스웨덴어, 스페인어, 이탈리아어, 네덜란드어, 포르투갈어, 중국어(번체자와 간체자), 그리고 한국어로 작성된 조작 설명서가 포함되어 있습니다. 프로젝터를 조작하기 전에 조작 지침을 상세하게 숙지하십시오.

Before using the projector, please read this operation manual carefully.

Introduction

ENGLISH

There are two important reasons for prompt warranty registration of your new SHARP Projector, using the REGISTRATION CARD packed with the projector.

1. WARRANTY

This is to assure that you immediately receive the full benefit of the parts, service and labor warranty applicable to your purchase.

2. CONSUMER PRODUCT SAFETY ACT

To ensure that you will promptly receive any safety notification of inspection, modification, or recall that SHARP may be required to give under the 1972 Consumer Product Safety Act, PLEASE READ CAREFULLY THE IMPORTANT "LIMITED WARRANTY" CLAUSE.



U.S.A. ONLY

WARNING: High brightness light source. Do not stare into the beam of light, or view directly. Be especially careful that children do not stare directly into the beam of light.



WARNING: To reduce the risk of fire or electric shock, do not expose this product to rain or moisture.

See bottom of projector.

| | | |
|---|--|---|
|  | CAUTION RISK OF ELECTRIC SHOCK. DO NOT REMOVE SCREWS EXCEPT SPECIFIED USER SERVICE SCREW. |  |
| CAUTION: TO REDUCE THE RISK OF ELECTRIC SHOCK, DO NOT REMOVE COVER. NO USER-SERVICEABLE PARTS EXCEPT LAMP UNIT. REFER SERVICING TO QUALIFIED SERVICE PERSONNEL. | | |



The lightning flash with arrowhead symbol, within an equilateral triangle, is intended to alert the user to the presence of uninsulated "dangerous voltage" within the product's enclosure that may be of sufficient magnitude to constitute a risk or electric shock to persons.



The exclamation point within a triangle is intended to alert the user to the presence of important operating and maintenance (servicing) instructions in the literature accompanying the product.

WARNING: FCC Regulations state that any unauthorized changes or modifications to this equipment not expressly approved by the manufacturer could void the user's authority to operate this equipment.

U.S.A. ONLY

FixYourDLP.com

WARNING:

The cooling fan in this projector continues to run for about 90 seconds after the projector enters standby mode. During normal operation, when putting the projector into standby mode always use the STANDBY/ON button on the projector or the STANDBY button on the remote control. Ensure the cooling fan has stopped before disconnecting the power cord.

DURING NORMAL OPERATION, NEVER TURN THE PROJECTOR OFF BY DISCONNECTING THE POWER CORD. FAILURE TO OBSERVE THIS WILL RESULT IN PREMATURE LAMP FAILURE.

INFORMATION

This equipment has been tested and found to comply with the limits for a Class B digital device, pursuant to Part 15 of the FCC Rules. These limits are designed to provide reasonable protection against harmful interference in a residential installation. This equipment generates, uses, and can radiate radio frequency energy and, if not installed and used in accordance with the operation manual, may cause harmful interference to radio communications. However, there is no guarantee that interference will not occur in a particular installation. If this equipment does cause harmful interference to radio or television reception, which can be determined by turning the equipment off and on, the user is encouraged to try to correct the interference by one or more of the following measures:

- Reorient or relocate the receiving antenna.
- Increase the separation between the equipment and the receiver.
- Connect the equipment into an outlet on a circuit different from that to which the receiver is connected.
- Consult the dealer or an experienced radio/TV technician for help.

U.S.A. ONLY

Declaration of conformity

SHARP PROJECTOR, MODEL XR-20X/XR-20S/XR-10X/XR-10S

This device complies with Part 15 of the FCC rules. Operation is subject to the following conditions: (1) This device may not cause harmful interference, and (2) this device must accept any interference received, including interference that may cause undesired operation.

Responsible Party:

SHARP ELECTRONICS CORPORATION
Sharp Plaza, Mahwah, New Jersey 07430-2135
TEL: 1-800-BE-SHARP (1-800-237-4277)

U.S.A. ONLY

PRODUCT DISPOSAL

This projector utilizes tin-lead solder, and a pressurized lamp containing a small amount of mercury. Disposal of these materials may be regulated due to environmental considerations. For disposal or recycling information, please contact your local authorities or, if you are located in the United States of America, the Electronic Industries Alliance: www.eiae.org.

Caution Concerning Lamp Replacement

See "Replacing the Lamp" on page 50.

This SHARP projector uses a DMD panel. This very sophisticated panel contains 786,432 (XR-20X/XR-10X) / 480,000 (XR-20S/XR-10S) pixels (micromirrors). As with any high technology electronic equipment such as large screen TVs, video systems and video cameras, there are certain acceptable tolerances that the equipment must conform to.

This unit has some inactive pixels within acceptable tolerances which may result in inactive dots on the picture screen. This will not affect the picture quality or the life expectancy of the unit.

How to Read this Operation Manual

- The specifications are slightly different, depending on the model. However, you can connect and operate all models in the same manner.
- In this operation manual, the illustration and the screen display are simplified for explanation, and may differ slightly from the actual display.

Using the Menu Screen

Buttons used in this operation

Button used in this step

On-screen display

Useful Features

37



Info Indicates safeguards for using the projector.

Note Indicates additional information for setting up and operating the projector.

DiscountMerchant.com (800) 281-8860

For Future Reference

Maintenance

➔ P. 47

Troubleshooting

➔ PP. 59 and 60

Index

➔ P. 64

Contents

Preparing

Introduction

| | |
|--|----|
| How to Read this Operation Manual | 3 |
| Contents | 4 |
| IMPORTANT SAFEGUARDS | 6 |
| How to Access the PDF Operation Manuals | 9 |
| Accessories | 10 |
| Part Names and Functions | 11 |
| Inserting the Batteries | 14 |
| Usable Range | 15 |

Quick Start

| | |
|-------------------|----|
| Quick Start | 16 |
|-------------------|----|

Setup

| | |
|---|----|
| Setting up the Projector | 18 |
| Setting up the Projector | 18 |
| Standard Setup (Front Projection) | 18 |
| Ceiling-mount Setup | 18 |
| Projection (PRJ) Mode | 19 |
| Screen Size and Projection Distance .. | 20 |

Connections

| | |
|--|----|
| Connections | 21 |
| Samples of Cables for Connection | 22 |
| Connecting to a Computer | 23 |
| Connecting to Video Equipment | 24 |
| Connecting to a Monitor with RGB Input Terminal | 25 |
| Controlling the Projector by a Computer | 26 |
| Connecting the Power Cord | 26 |

Using

Basic Operation

| | |
|--|----|
| Turning the Projector On/Off | 27 |
| Turning the Projector on | 27 |
| Turning the Power off (Putting the Projector into Standby Mode) | 27 |
| Image Projection | 28 |
| About the Setup Guide | 28 |
| Adjusting the Projected Image | 28 |
| Switching the Input Mode | 30 |
| Adjusting the Volume | 30 |
| Displaying the Black Screen and Turning off the Sound Temporarily | 30 |
| Correcting Trapezoidal Distortion | 31 |
| Resize Mode | 32 |

Useful Features

| | |
|---|----|
| Operating with the Remote Control | 34 |
| Displaying and Setting the Break Timer | 34 |
| Auto Sync (Auto Sync Adjustment) | 34 |
| Freezing a Moving Image | 34 |
| Selecting the Picture Mode | 34 |
| Menu Items | 35 |
| Using the Menu Screen | 37 |
| Menu Selections (Adjustments) | 37 |
| Picture Adjustment ("Picture" menu) .. | 39 |
| Selecting the Picture Mode | 39 |
| Adjusting the Image | 40 |
| Adjusting the Color Temperature | 40 |

| | |
|--|----|
| Progressive | 40 |
| Lamp Setting | 40 |
| Adjusting the Projected Image ("SCR - ADJ" menu) | 41 |
| Setting the Resize Mode | 41 |
| Adjusting the Image Position | 41 |
| Keystone Correction | 41 |
| Setting On-screen Display | 42 |
| Selecting the Background Image | 42 |
| Selecting the Setup Guide | 42 |
| Reversing/Inverting Projected Images | 42 |
| Selecting the On-screen Display Language | 42 |
| Adjusting the Projector Function ("PRJ - ADJ" menu) | 43 |
| Auto Search Function | 43 |
| Auto Sync (Auto Sync Adjustment) | 43 |
| Auto Power Off Function | 43 |
| Setting the Confirmation Sound (System Sound) | 43 |
| Speaker Setting | 43 |
| Selecting the Transmission Speed (RS-232C) | 43 |
| Fan Mode Setting | 44 |
| Checking the Lamp Life Status | 44 |
| System Lock Function | 44 |
| Locking the Operation Buttons on the Projector (Keylock Function) | 45 |
| Troubleshooting with "Help" menu | 46 |
| Utilizing "Help" menu functions | 46 |



FixYourDLP.com

Sponsored by

Discount Merchant.com (800) 231-8360
THE TOP SOURCE FOR PROJECTOR (LAMP) AND ACCESSORIES

Reference

Appendix

| | |
|--|----|
| Maintenance | 47 |
| Maintenance Indicators | 48 |
| Regarding the Lamp | 50 |
| Lamp | 50 |
| Caution Concerning the Lamp | 50 |
| Replacing the Lamp | 50 |
| Removing and Installing the Lamp Unit | 51 |
| Resetting the Lamp Timer | 52 |

| | |
|--|----|
| Connecting Pin Assignments | 53 |
| RS-232C Specifications and Command Settings | 54 |
| Computer Compatibility Chart | 58 |
| Troubleshooting | 59 |
| For SHARP Assistance | 61 |
| Specifications | 62 |
| Dimensions | 63 |
| Index | 64 |



Discount-Merchant.com (800) 281-8860
THE TRUSTED SOURCE FOR PROJECTOR LAMPS AND ACCESSORIES

IMPORTANT SAFEGUARDS

CAUTION: Please read all of these instructions before you operate this product and save these instructions for later use.

Electrical energy can perform many useful functions. This product has been engineered and manufactured to assure your personal safety. BUT IMPROPER USE CAN RESULT IN POTENTIAL ELECTRICAL SHOCK OR FIRE HAZARDS. In order not to defeat the safeguards incorporated in this product, observe the following basic rules for its installation, use and servicing.

1. Read Instructions

All the safety and operating instructions should be read before the product is operated.

2. Retain Instructions

The safety and operating instructions should be retained for future reference.

3. Heed Warnings

All warnings on the product and in the operating instructions should be adhered to.

4. Follow Instructions

All operating and use instructions should be followed.

5. Cleaning

Unplug this product from the wall outlet before cleaning. Do not use liquid cleaners or aerosol cleaners. Use a damp cloth for cleaning.

6. Attachments

Do not use attachments not recommended by the product manufacturer as they may cause hazards.

7. Water and Moisture

Do not use this product near water—for example, near a bath tub, wash bowl, kitchen sink, or laundry tub; in a wet basement; or near a swimming pool; and the like.

8. Accessories

Do not place this product on an unstable cart, stand, tripod, bracket, or table. The product may fall, causing serious injury to a child or adult, and serious damage to the product. Use only with a cart, stand, tripod, bracket, or table recommended by the manufacturer, or sold with the product. Any mounting of the product should follow the manufacturer's instructions, and should use a mounting accessory recommended by the manufacturer.

9. Transportation

A product and cart combination should be moved with care. Quick stops, excessive force, and uneven surfaces may cause the product and cart combination to overturn.



10. Ventilation

Slots and openings in the cabinet are provided for ventilation to ensure reliable operation of the product and to protect it from overheating, and these openings must not be blocked or covered. The openings should never be blocked by placing the product on a bed, sofa, rug, or other similar surface. This product should not be placed in a built-in installation such as a bookcase or rack unless proper ventilation is provided or the manufacturer's instructions have been adhered to.

11. Power Sources

This product should be operated only from the type of power source indicated on the marking label. If you are not sure of the type of power supply to your home, consult your product dealer or local power company. For products intended to operate from battery power, or other sources, refer to the operating instructions.

12. Grounding or Polarization

This product is provided with one of the following types of plugs. If the plug should fail to fit into the power outlet, please contact your electrician.

Do not defeat the safety purpose of the plug.

- Two-wire type (mains) plug.
- Three-wire grounding type (mains) plug with a grounding terminal.

This plug will only fit into a grounding type power outlet.

13. Power-Cord Protection

Power-supply cords should be routed so that they are not likely to be walked on or pinched by items placed upon or against them, paying particular attention to cords at plugs, convenience receptacles, and the point where they exit from the product.

14. Lightning

For added protection for this product during a lightning storm, or when it is left unattended and unused for long periods of time, unplug it from the wall outlet and disconnect the cable system. This will prevent damage to the product due to lightning and power-line surges.

15. Overloading

Do not overload wall outlets, extension cords, or integral convenience receptacles as this can result in a risk of fire or electric shock.

16. Object and Liquid Entry

Never push objects of any kind into this product through openings as they may touch dangerous voltage points or short-out parts that could result in a fire or electric shock. Never spill liquid of any kind on the product.

17. Servicing

Do not attempt to service this product yourself as opening or removing covers may expose you to dangerous voltage or other hazards. Refer all servicing to qualified service personnel.

18. Damage Requiring Service

Unplug this product from the wall outlet and refer servicing to qualified service personnel under the following conditions:

- a. When the power-supply cord or plug is damaged.
- b. If liquid has been spilled, or objects have fallen into the product.
- c. If the product has been exposed to rain or water.
- d. If the product does not operate normally by following the operating instructions. Adjust only those controls that are covered by the operating instructions, as an improper adjustment of other controls may result in damage and will often require extensive work by a qualified technician to restore the product to normal operation.
- e. If the product has been dropped or damaged in any way.
- f. When the product exhibits a distinct change in performance, this indicates a need for service.

19. Replacement Parts

When replacement parts are required, be sure the service technician has used replacement parts specified by the manufacturer or have the same characteristics as the original part. Unauthorized substitutions may result in fire, electric shock, or other hazards.

20. Safety Check

Upon completion of any service or repairs to this product, ask the service technician to perform safety checks to determine that the product is in proper operating condition.

21. Wall or Ceiling Mounting

This product should be mounted to a wall or ceiling only as recommended by the manufacturer.

22. Heat

This product should be situated away from heat sources such as radiators, heat registers, stoves, or other products (including amplifiers) that produce heat.

- DLP™ (Digital Light Processing) and DMD™ (Digital Micromirror Device) are trademarks of Texas Instruments, Inc.
- Microsoft® and Windows® are registered trademarks of Microsoft Corporation in the United States and/or other countries.
- PC/AT is a registered trademark of International Business Machines Corporation in the United States.
- Adobe® Reader® is a trademark of Adobe Systems Incorporated.
- Macintosh® is a registered trademark of Apple Computer, Inc. in the United States and/or other countries.
- All other company or product names are trademarks or registered trademarks of their respective companies.
- Some IC chips in this product include confidential and/or trade secret property belonging to Texas Instruments. Therefore you may not copy, modify, adapt, translate, distribute, reverse engineer, reverse assemble or discompile the contents thereof.

Observe the following safeguards when setting up your projector.

Caution concerning the lamp unit

- Potential hazard of glass particles if lamp ruptures. In case of lamp rupture, contact your nearest Sharp Authorized Projector Dealer or Service Center for replacement. See “Replacing the Lamp” on page 50.

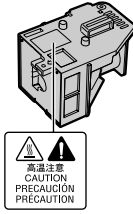

Caution concerning the setup of the projector

- For minimal servicing and to maintain high image quality, SHARP recommends that this projector be installed in an area free from humidity, dust and cigarette smoke. When the projector is subjected to these environments, the vents and lens must be cleaned more often. As long as the projector is regularly cleaned, use in these environments will not reduce the overall operation life of the unit. Internal cleaning should only be performed by a Sharp Authorized Projector Dealer or Service Center.

Do not set up the projector in places exposed to direct sunlight or bright light.

- Position the screen so that it is not in direct sunlight or room light. Light falling directly on the screen washes out the colors, making viewing difficult. Close the curtains and dim the lights when setting up the screen in a sunny or bright room.

Caution regarding placing of the projector

- Place the projector on a level site within the adjustment range (8 degrees) of the adjustment foot.



When using the projector in high-altitude areas such as mountains (at altitudes of approximately 1,500 meters (4,900 feet) or more)

- When you use the projector in high-altitude areas with thin air, set “Fan Mode” to “High”. Neglecting this can affect the longevity of the optical system.

Warning about placing the projector in a high position

- When placing the projector in a high position, ensure that it is secured carefully to avoid personal injury caused by the projector falling down.

Do not subject the projector to hard impact and/or vibration.

- Protect the lens so as not to hit or damage the surface of the lens.

Rest your eyes occasionally.

- Continuously watching the screen for long hours will cause eye strain. Be sure to occasionally rest your eyes.

Avoid locations with extremes of temperature.

- The operating temperature of the projector is from 41°F to 95°F (+5°C to +35°C).
- The storage temperature of the projector is from -4°F to 140°F (-20°C to +60°C).

Do not block the exhaust and intake vents.

- Allow at least 11 ¹³/₁₆ inches (30 cm) of space between the exhaust vent and the nearest wall or obstruction.
- Be sure that the intake vent and the exhaust vent are not obstructed.
- If the cooling fan becomes obstructed, a protection circuit will automatically put the projector into standby mode to prevent overheating damage. This does not indicate a malfunction. (See pages 48 and 49.) Remove the projector power cord from the wall outlet and wait at least 10 minutes. Place the projector where the intake and exhaust vents are not blocked, plug the power cord back in and turn on the projector. This will return the projector to the normal operating condition.

- When turning off the projector, the cooling fan runs to decrease the internal temperature for a while. Unplug the power cord after the cooling fan stops. The period the cooling fan runs will vary, depending on the circumstances and the internal temperature.

Caution regarding usage of the projector

- When using the projector, be sure not to subject it to hard impact and/or vibration, as this can result in damage. Take extra care with the lens. Before moving the projector, be sure to unplug the power cord from the wall outlet, and disconnect any other cables connected to it.
- Do not carry the projector by holding the lens.
- When storing the projector, re-attach the lens cap. (See page 11).
- Do not expose the projector to direct sunlight or place next to heat sources. Doing so may affect the cabinet color or cause deformation of the plastic cover.

Other connected equipment

- When connecting a computer or other audio-visual equipment to the projector, make the connections AFTER unplugging the power cord of the projector from the AC outlet and turning off the equipment to be connected.
- Please read the operation manuals of the projector and the equipment to be connected for instructions on how to make the connections.

Using the projector in other countries

- The power supply voltage and the shape of the plug may vary depending on the region or country you are using the projector in. When using the projector overseas, be sure to use an appropriate power cord for the country you are in.

Temperature monitor function

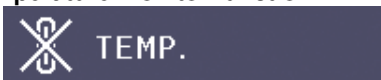

- If the projector starts to overheat due to setup problems or blockage of the air vents, "X" and "TEMP." will illuminate in the lower left corner of the picture. If the temperature continues to rise, the lamp will turn off, the temperature warning indicator on the projector will blink, and after a 90-second cooling-off period the projector will enter standby mode. Refer to "Maintenance Indicators" on page 48 for details.

Info

- The cooling fan regulates the internal temperature, and its performance is automatically controlled. The sound of the fan may change during projector operation due to changes in the fan speed. This does not indicate malfunction.
- Do not unplug the power cord during projection or cooling fan operation. This can cause damage due to rise in internal temperature, as the cooling fan also stops.

How to Access the PDF Operation Manuals

PDF operation manuals in several languages are included in the CD-ROM, so that you can work with the projector, even if you do not have this manual. To utilize these manuals, you need to install Adobe® Reader® on your computer (Windows® or Macintosh®).

Please download Adobe® Reader® from the Internet (<http://www.adobe.com>).

Accessing the PDF Manuals for Windows® (For Macintosh®, skip step ②).

- ① Insert the CD-ROM in the CD-ROM drive.
- ② Double click the "My Computer" icon.
- ③ Double click the "CD-ROM" drive.
- ④ Double click the language (name of the folder) that you want to view.
- ⑤ Double click the "10_20_" pdf file to access the projector manuals.

Note

- If the desired pdf file cannot be opened by double clicking the mouse, start Adobe® Reader® first, then specify the desired file using the "File", "Open" menu.

Accessories

Supplied accessories



Remote control
RRMCGA398WJSA



Two R-6 batteries
("AA" size, UM/SUM-3,
HP-7 or similar)

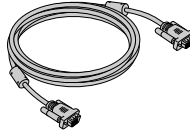

RGB cable
(9' 10" (3.0 m))
QCNWGA045WJPZ

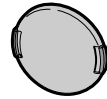

Lens cap (attached)
CCAPHA024WJSA

- Operation manual (this manual (TINS-B851WJZZ) and CD-ROM (UDSKAA062WJZZ))

Power cord*

(1)

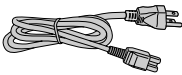

For U.S. and
Canada, etc.
(6' (1.8 m))
QACCDAA007WJPZ

(2)

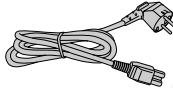

For Europe,
except U.K.
(6' (1.8 m))
QACCAVA011WJPZ

(3)

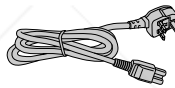

For U.K. and
Singapore
(6' (1.8 m))
QACCBAA036WJPZ

(4)

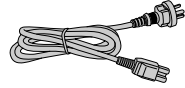

For Australia, New
Zealand and Oceania
(6' (1.8 m))
QACCLA018WJPZ

* Use the power cord that corresponds to the wall outlet in your country.

Optional accessories

- | | |
|---|--|
| ■ 3 RCA to 15-pin D-sub cable (9' 10" (3.0 m)) | AN-C3CP2 |
| ■ DIN-D-sub RS-232C adaptor (5 ⁵⁷ / ₆₄ " (15 cm)) | AN-A1RS |
| ■ Remote receiver | AN-MR2 |
| ■ Lamp unit | AN-XR20LP (for XR-20X/XR-20S) AN-XR10LP (for XR-10X/XR-10S) |



Note sponsored by D.M.

- Some of the optional accessories may not be available depending on the region. Please check with your nearest Sharp Authorized Projector Dealer or Service Center.

THE TRUSTED SOURCE FOR PROJECTOR LAMPS AND ACCESSORIES

Part Names and Functions

Numbers in refer to the main pages in this operation manual where the topic is explained.

Projector

Top View

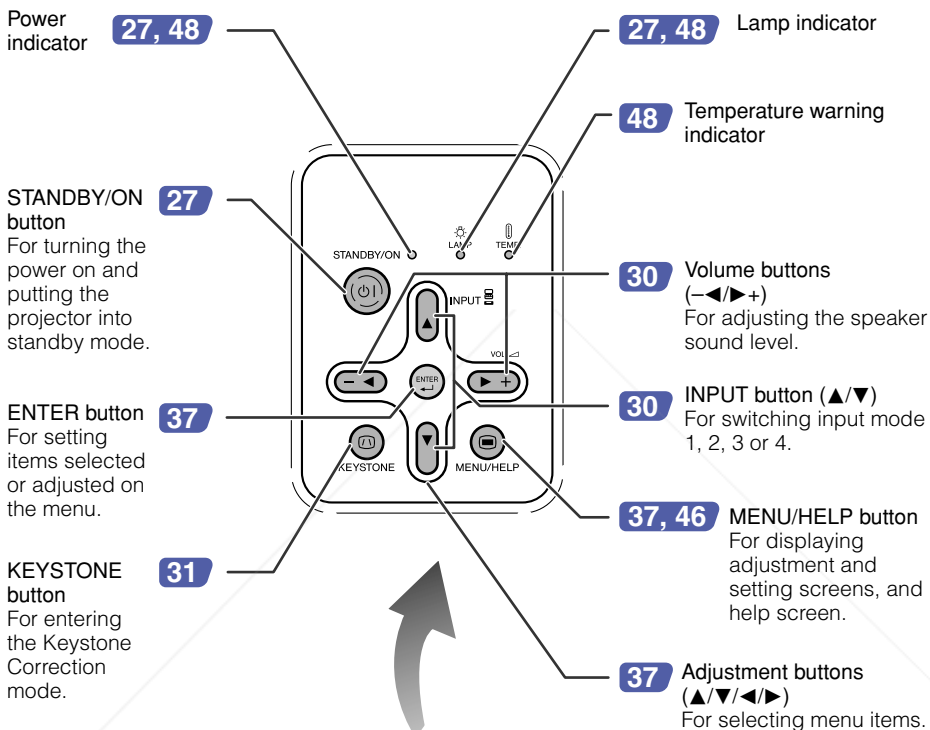

Front View

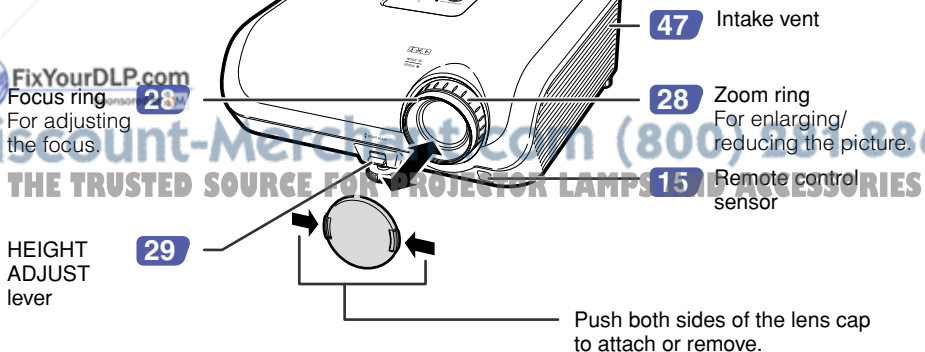

Part Names and Functions (Continued)

Numbers in refer to the main pages in this operation manual where the topic is explained.

Rear View

Terminals Refer to "INPUT Terminals and Connectable Main Equipment" on page 21.

AUDIO (INPUT 1, 2) terminal (Shared for INPUT 1 and 2)

INPUT 1 and INPUT 2 terminals
Terminals for computer RGB and component signals.

AUDIO OUTPUT terminal
Audio output terminal of equipment connected to the AUDIO INPUT terminal.

OUTPUT (INPUT 1, 2) terminal
(Shared computer RGB and component signals output terminal for INPUT 1 and 2)
Terminal for connecting a monitor.

INPUT 3 terminal
Terminal for connecting video equipment with an S-video terminal.

RS-232C terminal
Terminal for controlling the projector using a computer.

AUDIO (INPUT 3, 4) terminal (Shared for INPUT 3 and 4)

INPUT 4 terminal
Terminal for connecting video equipment.

Exhaust vent

Speaker

AC socket
Connect the supplied Power cord.

Kensington Security Standard connector

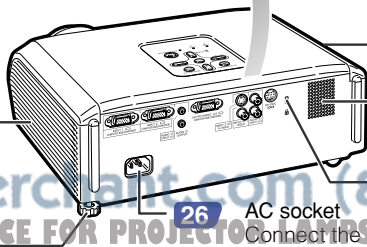
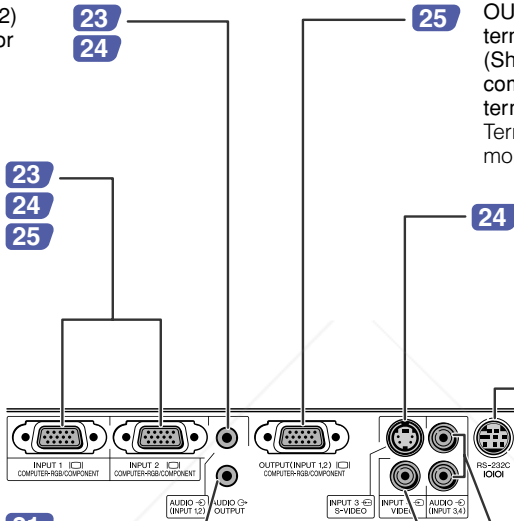

Intake vent 27

Rear adjustment foot 29

 28

 29

 30

 31

 32

Using the Kensington Lock

- This projector has a Kensington Security Standard connector for use with a Kensington MicroSaver Security System. Refer to the information that came with the system for instructions on how to use it to secure the projector.

Numbers in **[]** refer to the main pages in this operation manual where the topic is explained.

STANDBY button

For putting the projector into the standby mode.

27

KEystone button

For entering the Keystone Correction mode.

31

RETURN button

For returning to the previous menu screen during menu operations.

37

FORWARD/BACK buttons

Same function as the [Page Down] and [Page Up] keys on a computer keyboard when using the optional Remote Receiver (AN-MR2).

37

BREAK TIMER button

For displaying the break time.

34

AV MUTE button

For temporarily displaying the black screen and turning off the sound.

30

PICTURE MODE button

For selecting the appropriate picture.

34

ON button

For turning the power on.

27

MENU/HELP button

For displaying adjustment and setting screens, and help screen.

37

46

Adjustment buttons

(▲/▼/◀/▶)

- For selecting menu items.
- For adjusting the Keystone Correction when in the Keystone Correction mode.

37

ENTER button

For setting items selected or adjusted on the menu.

37

FREEZE button

For freezing images.

34

Volume buttons

For adjusting the speaker sound level.

30

AUTO SYNC button

For automatically adjusting images when connected to a computer.

34

RESIZE button

For switching the screen size (NORMAL, BORDER, etc.).

32

INPUT 1, 2, 3 and 4 buttons

For switching to the respective input modes.

30



Discount-Merchant.com (800) 291-8860
THE TRUSTED SOURCE FOR PROJECTOR LAMPS AND ACCESSORIES

Part Names and Functions (Continued)

Inserting the Batteries

- 1 Press the ▲ mark on the cover and slide it in the direction of the arrow.

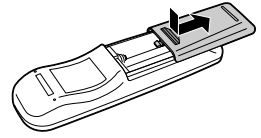

- 2 Insert the batteries.
 - Insert the batteries making sure the polarities correctly match the ⊕ and ⊖ marks inside the battery compartment.

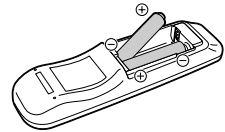

- 3 Attach the cover and slide it until it clicks into place.

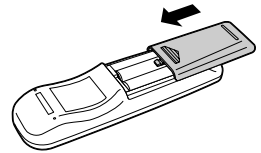

Incorrect use of the batteries may cause them to leak or explode. Please follow the precautions below.

Caution

- Danger of explosion if battery is incorrectly replaced. Replace only with the same or equivalent type.
 - Insert the batteries making sure the polarities correctly match the ⊕ and ⊖ marks inside the battery compartment.
 - Batteries of different types have different properties, therefore do not mix batteries of different types.
 - Do not mix new and old batteries.
This may shorten the life of new batteries or may cause old batteries to leak.
 - Remove the batteries from the remote control once they have run out, as leaving them in can cause them to leak.
Battery fluid from leaked batteries is harmful to skin, therefore ensure that you first wipe them and then remove them using a cloth.
-
- The batteries included with this projector may run down in a short period, depending on how they are kept. Be sure to replace them as soon as possible with new batteries.
 - Remove the batteries from the remote control if you will not be using the remote control for a long time.
 - Comply with the rules (ordinance) of each local government when disposing of worn-out batteries.

Usable Range

The remote control can be used to control the projector within the ranges shown in the illustration.

Note

- The signal from the remote control can be reflected off a screen for easy operation. However, the effective distance of the signal may differ depending on the screen material.

When using the remote control

- Ensure that you do not drop, expose to moisture or high temperature.
- The remote control may malfunction under a fluorescent lamp. In this case, move the projector away from the fluorescent lamp.

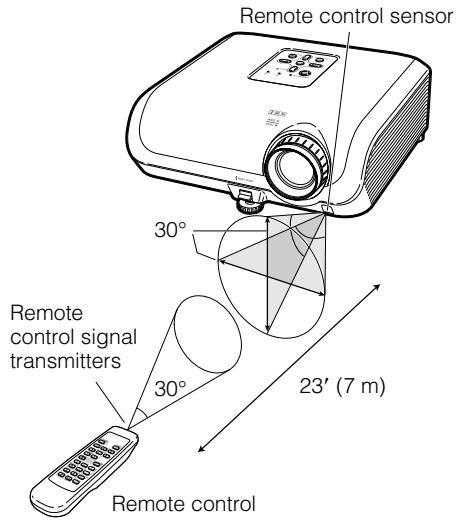

Quick Start

This section shows the basic operation (projector connecting with the computer). For details, see the page described below for each step.

Setup and Projection

In this section, connection of the projector and the computer is explained using one example.

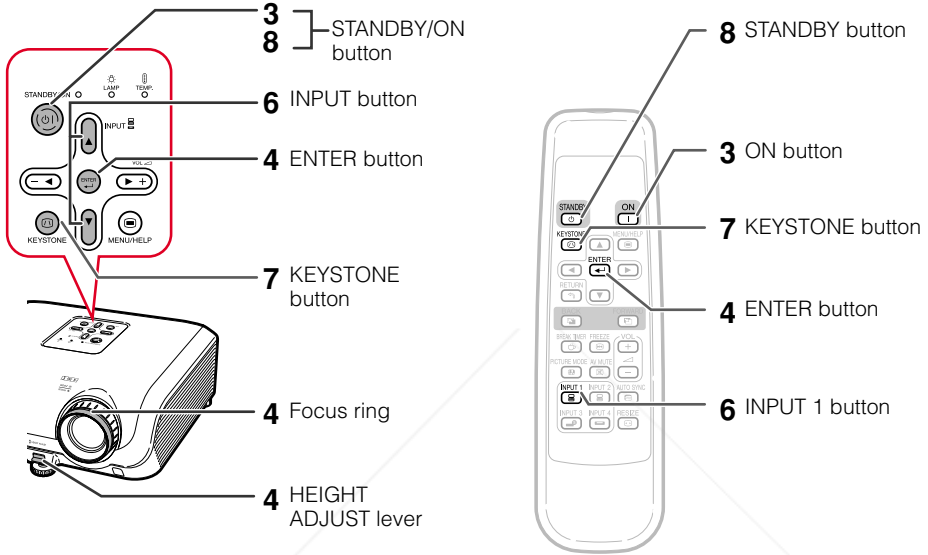

1. Place the projector facing a wall or a screen → P. 18

2. Connect the projector to the computer and plug the power cord into the AC socket of the projector

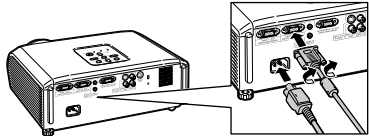

When connecting equipment other than the computer, see pages 24 and 25.

→ PP. 21–26

3. Remove the lens cap and turn the projector on



On the projector



On the remote control



→ P. 27

4. Adjust the projected image with the Setup Guide

- 1 After the projector turns on, the Setup Guide appears. (When "Setup Guide" is set to "On". → page 42)
- 2 Follow the steps in the Setup Guide and adjust the focus, screen size, and height (angle).
- 3 After adjusting the focus, height (angle) and screen size, press ENTER to finish the Setup Guide.

→ P. 28

5. Turn the computer on

6. Select the INPUT mode

Select the "INPUT 1" using the INPUT button on the projector or INPUT 1 on the remote control.

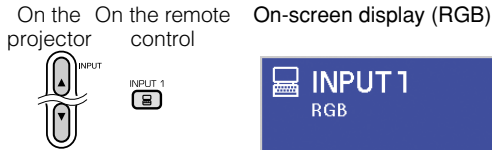

- When pressing the INPUT button on the projector, input mode switches in the following order: INPUT 1 INPUT 2 INPUT 3 INPUT 4
- When using the remote control, press the INPUT 1 / INPUT 2 / INPUT 3 / INPUT 4 button to switch the INPUT mode.

→ P. 30

7. Correct trapezoidal distortion

Correcting trapezoidal distortion using the Keystone Correction. (Keystone Correction functions automatically on XR-20X.)

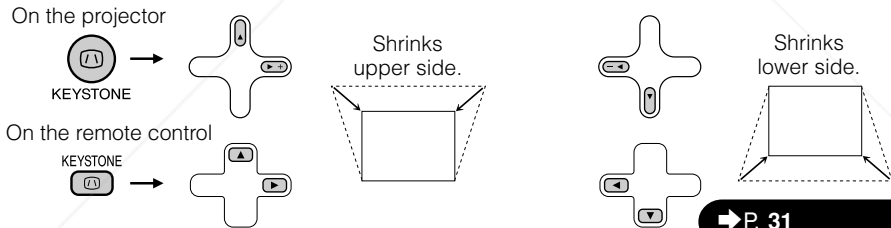

→ P. 31

8. Turn the Power off

Press the STANDBY/ON button on the projector or the STANDBY button on the remote control, and then Press the button again while the confirmation message is displayed, to put the projector into standby mode.



- Unplug the power cord from the AC outlet after the cooling fan stops.

→ P. 27

Discount-Merchant.com (800) 281-8860
 THE TRUSTED SOURCE FOR PROJECTOR PARTS AND ACCESSORIES

Setting up the Projector

Setting up the Projector

For optimal image quality, position the projector perpendicular to the screen with the projector's feet flat and level. Doing so will eliminate the need for Keystone correction and provide the best image quality. (See page 31.)

Standard Setup (Front Projection)

- Place the projector at the required distance from the screen according to the desired picture size. (See page 20.)



Example of standard setup

Side View

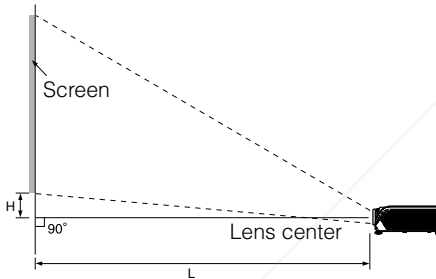

Note

- Refer to page 20 for additional information concerning "Screen Size and Projection Distance".

Ceiling-mount Setup

- It is recommended that you use the optional Sharp ceiling-mount bracket for this installation. Before mounting the projector, contact your nearest Sharp Authorized Projector Dealer or Service Center to obtain the recommended ceiling-mount bracket (sold separately).
 - AN-XRCM30 ceiling-mount bracket (for U.S.A.).
 - AN-60KT ceiling-mount bracket, its AN-TK201 and AN-TK202 extension tubes (for countries other than the U.S.A.).
- Invert the image by setting "Ceiling + Front" in "PRJ Mode". See page 42 for use of this function.

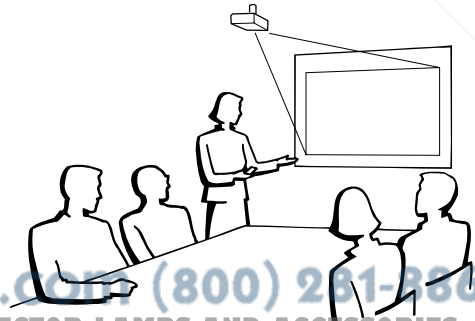

Projection (PRJ) Mode

The projector can use any of the 4 projection modes, shown in the diagram below. Select the mode most appropriate for the projection setting in use. (You can set the PRJ mode in "SCR-ADJ" menu. See page 42.)

■ Table mounted, front projection

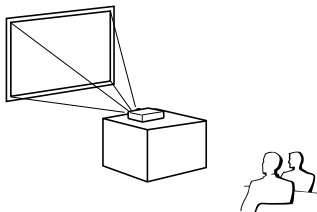

■ Ceiling mounted, front projection

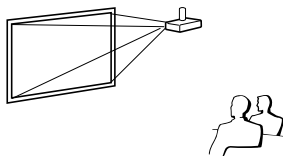

Menu item → "Front"

Menu item → "Ceiling + Front"

■ Table mounted, rear projection (with a translucent screen)

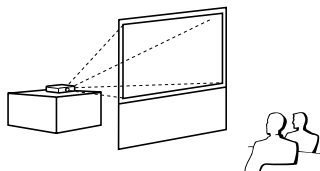

■ Ceiling mounted, rear projection (with a translucent screen)

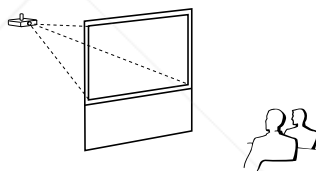

Menu item → "Rear"

Menu item → "Ceiling + Rear"

Indication of the Projection Image Size and Projection Distance

Example: NORMAL Mode (4:3)

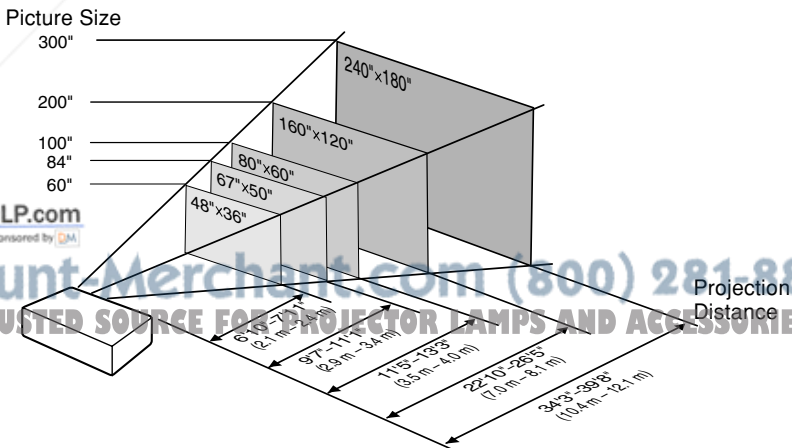

Discount-Merchant.com (800) 281-8860
 THE TRUSTED SOURCE FOR PROJECTOR LAMPS AND ACCESSORIES

Setting up the Projector (Continued)

Screen Size and Projection Distance

NORMAL Mode (4:3)

| Picture (Screen) size | | | Projection distance [L] | | Distance from the lens center to the bottom of the image [H] |
|-----------------------|---------------|---------------|-------------------------|-----------------|--|
| Diag. [X] | Width | Height | Minimum [L1] | Maximum [L2] | |
| 300" (762 cm) | 610 cm (240") | 457 cm (180") | 10.4 m (34' 3") | 12.1 m (39' 8") | - 48 cm (- 19 ⁵ / ₆₄ " |
| 270" (686 cm) | 549 cm (216") | 411 cm (162") | 9.4 m (30' 10") | 10.9 m (35' 8") | - 44 cm (- 17 ¹¹ / ₆₄ " |
| 250" (635 cm) | 508 cm (200") | 381 cm (150") | 8.7 m (28' 7") | 10.1 m (33' 1") | - 40 cm (- 15 ⁵⁷ / ₆₄ " |
| 200" (508 cm) | 406 cm (160") | 305 cm (120") | 7.0 m (22' 10") | 8.1 m (26' 5") | - 32 cm (- 12 ²³ / ₃₂ " |
| 150" (381 cm) | 305 cm (120") | 229 cm (90") | 5.2 m (17' 2") | 6.0 m (19' 10") | - 24 cm (- 9 ¹⁷ / ₃₂ " |
| 100" (254 cm) | 203 cm (80") | 152 cm (60") | 3.5 m (11' 5") | 4.0 m (13' 3") | - 16 cm (- 6 ²³ / ₆₄ " |
| 84" (213 cm) | 171 cm (67") | 128 cm (50") | 2.9 m (9' 7") | 3.4 m (11' 1") | - 14 cm (- 5 ¹¹ / ₃₂ " |
| 72" (183 cm) | 146 cm (58") | 110 cm (43") | 2.5 m (8' 3") | 2.9 m (9' 6") | - 12 cm (- 4 ³⁷ / ₆₄ " |
| 60" (152 cm) | 122 cm (48") | 91 cm (36") | 2.1 m (6' 10") | 2.4 m (7' 11") | - 10 cm (- 3 ¹³ / ₁₆ " |
| 40" (102 cm) | 81 cm (32") | 61 cm (24") | 1.4 m (4' 7") | 1.6 m (5' 3") | - 6 cm (- 2 ³⁵ / ₆₄ " |

X: Picture size (diag.) (in/cm)

L: Projection distance (m/ft)

L1: Minimum projection distance (m/ft)

L2: Maximum projection distance (m/ft)

H: Distance from the lens center to the bottom of the image (cm/in)

The formula for picture size and projection distance

[m/cm]

L1 (m) = 0.03482X

L2 (m) = 0.04029X

H (cm) = - 0.16151X

[Feet/inches]

L1 (ft) = 0.03482X / 0.3048

L2 (ft) = 0.04029X / 0.3048

H (in) = - 0.16151X / 2.54

STRETCH Mode (16:9)

| Picture (Screen) size | | | Projection distance [L] | | Distance from the lens center to the bottom of the image [H] | Adjustable range of image position [S] |
|-----------------------|---------------|---------------|-------------------------|-----------------|--|---|
| Diag. [X] | Width | Height | Minimum [L1] | Maximum [L2] | | |
| 250" (635 cm) | 553 cm (218") | 311 cm (123") | 9.5 m (31' 1") | 11.0 m (36' 0") | - 96 cm (- 37 ³ / ₄ " | ± 52 cm (± 20 ²⁷ / ₆₄ " |
| 225" (572 cm) | 498 cm (196") | 280 cm (110") | 8.5 m (28' 0") | 9.9 m (32' 5") | - 86 cm (- 33 ³¹ / ₃₂ " | ± 47 cm (± 18 ²⁵ / ₆₄ " |
| 200" (508 cm) | 443 cm (174") | 249 cm (98") | 7.6 m (24' 11") | 8.8 m (28' 10") | - 77 cm (- 30 ¹³ / ₆₄ " | ± 42 cm (± 16 ¹¹ / ₃₂ " |
| 150" (381 cm) | 332 cm (131") | 187 cm (74") | 5.7 m (18' 8") | 6.6 m (21' 7") | - 58 cm (- 22 ⁴¹ / ₆₄ " | ± 31 cm (± 12 ¹ / ₄ " |
| 133" (338 cm) | 294 cm (116") | 166 cm (65") | 5.0 m (16' 7") | 5.8 m (19' 2") | - 51 cm (- 20 ⁵ / ₆₄ " | ± 28 cm (± 10 ⁷ / ₈ " |
| 106" (269 cm) | 235 cm (92") | 132 cm (52") | 4.0 m (13' 2") | 4.7 m (15' 3") | - 41 cm (- 16") | ± 22 cm (± 8 ²¹ / ₃₂ " |
| 100" (254 cm) | 221 cm (87") | 125 cm (49") | 3.8 m (12' 5") | 4.4 m (14' 5") | - 38 cm (- 15 ³ / ₃₂ " | ± 21 cm (± 8 ¹¹ / ₆₄ " |
| 92" (234 cm) | 204 cm (80") | 115 cm (45") | 3.5 m (11' 5") | 4.0 m (13' 3") | - 35 cm (- 13 ⁵⁷ / ₆₄ " | ± 19 cm (± 7 ³³ / ₆₄ " |
| 84" (213 cm) | 186 cm (73") | 105 cm (41") | 3.2 m (10' 5") | 3.7 m (12' 1") | - 32 cm (- 12 ¹¹ / ₁₆ " | ± 17 cm (± 6 ⁵⁵ / ₆₄ " |
| 72" (183 cm) | 159 cm (63") | 90 cm (35") | 2.7 m (9' 0") | 3.2 m (10' 4") | - 28 cm (- 10 ⁷ / ₈ " | ± 15 cm (± 5 ⁵⁷ / ₆₄ " |
| 60" (152 cm) | 133 cm (52") | 75 cm (29") | 2.3 m (7' 6") | 2.6 m (8' 8") | - 23 cm (- 9 ¹ / ₁₆ " | ± 12 cm (± 4 ²⁹ / ₃₂ " |
| 40" (102 cm) | 89 cm (35") | 50 cm (20") | 1.5 m (5' 0") | 1.8 m (5' 9") | - 15 cm (- 6 ³ / ₆₄ " | ± 8 cm (± 3 ¹⁷ / ₆₄ " |

X: Picture size (diag.) (in/cm)

L: Projection distance (m/ft)

L1: Minimum projection distance (m/ft)

L2: Maximum projection distance (m/ft)

H: Distance from the lens center to the bottom of the image (cm/in)

S: Adjustable range of image position (cm/in) See page 41.

The formula for picture size and projection distance

[m/cm]

L1 (m) = 0.03794X

L2 (m) = 0.04389X

H (cm) = - 0.3835X

S (cm) = ± 0.20754X

[Feet/inches]

L1 (ft) = 0.03794X / 0.3048

L2 (ft) = 0.04389X / 0.3048

H (in) = - 0.3835X / 2.54

S (in) = ± 0.20754X / 2.54

Note

- Refer to page 18 concerning "Projection distance (L)" and "Distance from the lens center to the bottom of the image (H)".
- There are some errors in the values in the diagrams above.
- Values with a minus (-) sign indicate the distance from the lens center below the bottom of the image.

Connections

INPUT Terminals and Connectable Main Equipment

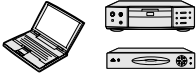

INPUT 1, 2 terminal

- Connecting the computer. (See page 23.)
- Connecting video equipment with component output terminal (DVD player, DTV decoder, DVD recorder with hard disc, etc.). (See page 24.)

AUDIO (INPUT 1, 2) terminal

Connecting an audio cable (Shared audio input terminal for INPUT 1 and 2). (See pages 23 and 24.)



COMPUTER-RGB/COMPONENT OUTPUT terminal

Connecting the monitor when you want to simultaneously watch the projection image on the monitor. (See page 25.)

AUDIO (INPUT 3, 4) terminal

Connecting an audio cable (Shared audio input terminal for INPUT 3 and 4). (See pages 24 and 25.)

Rear View

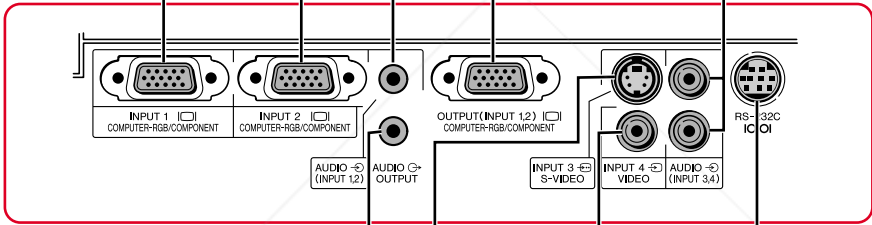

INPUT 3 terminal

Connecting video equipment with S-video output terminal (VCR, DVD player, etc.). (See page 24.)



RS-232C terminal

Connecting the computer to control the projector. (See page 26.)

AUDIO OUTPUT terminal

Connecting to an amplifier or other audio equipment with an audio cable (commercially available) (Shared audio output terminal for INPUT 1, 2, 3 and 4).

Use an audio cable with ø3.5 mm minijack plug to connect to this terminal.











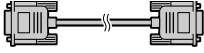
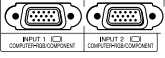
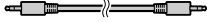

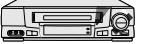

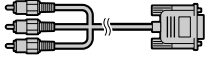
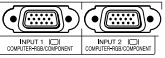
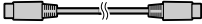

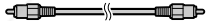
INPUT 4 terminal

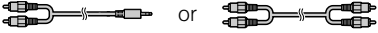
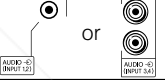
Connecting video equipment without S-video output terminal. (See page 25.)

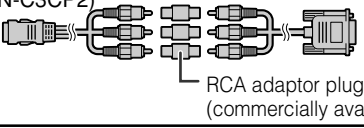
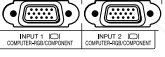
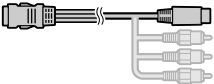
Samples of Cables for Connection

- For more details of connection and cables, refer to the operation manual of the connecting equipment.
- You may need other cables or connectors not listed below.

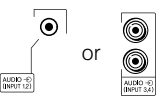
| Equipment | Input Signal | Cable | Terminal on the projector |
|---|-----------------|---|---|
|  | RGB video | RGB cable (supplied)  | INPUT1, 2  |
| | Computer audio | ø3.5 mm stereo audio cable (commercially available or available as Sharp service part QCNWGA038WJPZ)  | AUDIO INPUT  |
|    | Component video | 3 RCA (Component) to 15-pin D-sub cable (optional, AN-C3CP2)  | INPUT1, 2  |
| | S-video | S-video cable (commercially available)  | INPUT3  |
| | Video | Video cable (commercially available)  | INPUT4  |
| | Audio | ø3.5 mm minijack to RCA audio cable (commercially available)  | AUDIO INPUT  |
|   | Component video | Cables for a camera or a video game/3 RCA (Component) to 15-pin D-sub cable (optional, AN-C3CP2)  RCA adaptor plug (commercially available) | INPUT1, 2  |
| | S-video | Cables for a camera or a video game  | INPUT3  |
| | Video | Cables for a camera or a video game  | INPUT4  |
| | Audio | Cables for a camera or a video game/ø3.5 mm minijack to RCA audio cable (commercially available) RCA adaptor plug (commercially available)  or connect directly to AUDIO (INPUT 3, 4). | AUDIO INPUT  |

FixYourDLP.com
Sponsored by DLP

Discount-Merchant.com (800) 281-0860
THE TRUSTED SOURCE FOR PROJECTOR LAMPS AND ACCESSORIES

Connecting to a Computer

Before connecting, ensure that the power cord of the projector is unplugged from the AC outlet and turn off the devices to be connected. After making all connections, turn on the projector and then the other devices. When connecting a computer, ensure that it is the last device to be turned on after all the connections are made.

Ensure that you have read the operation manuals of the devices to be connected before making connections.

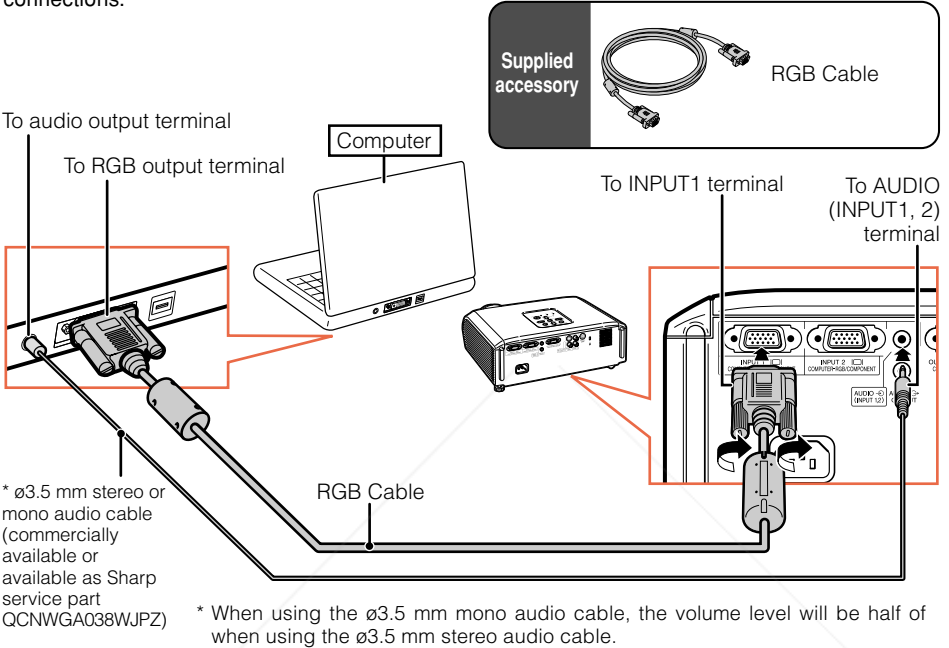

Note

- See page 58 "Computer Compatibility Chart" for a list of computer signals compatible with the projector. Use with computer signals other than those listed may cause some of the functions to not work.
- A Macintosh adaptor may be required for use with some Macintosh computers. Contact your nearest Macintosh Dealer.
- **Depending on the computer you are using, an image may not be projected unless the computer's external output port is switched on. (e.g. Press "Fn" and "F5" keys simultaneously when using a SHARP notebook computer).** Refer to the specific instructions in your computer's operation manual to enable your computer's external output port.

FixYourDLP.com
Sponsored by DM

Discount-Merchant.com (800) 281-8860
THE TRUSTED SOURCE FOR PROJECTOR LAMPS AND ACCESSORIES

Connecting to Video Equipment

The projector is equipped with input terminals that support component, S-video, and video signals. See the illustration below to connect with the audio-visual equipment. The image quality is highest in the order of the component signal, the S-video signal and the video signal. If your audio-visual equipment has a component output terminal, use the COMPUTER/COMPONENT terminal (INPUT1 or INPUT 2) on the projector for video connection.

When using a 3 RCA (Component) to 15-pin D-sub cable (INPUT1 or INPUT2)

To audio output terminal

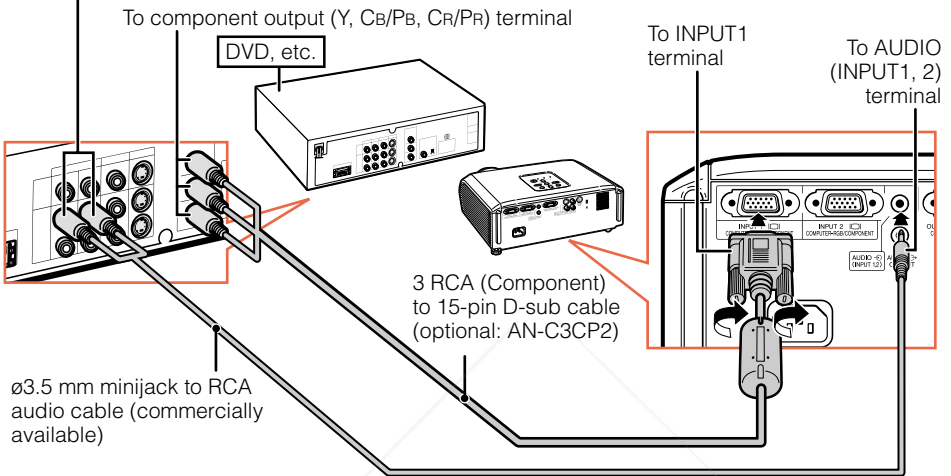

When using an S-video cable (INPUT3)

To audio output terminal

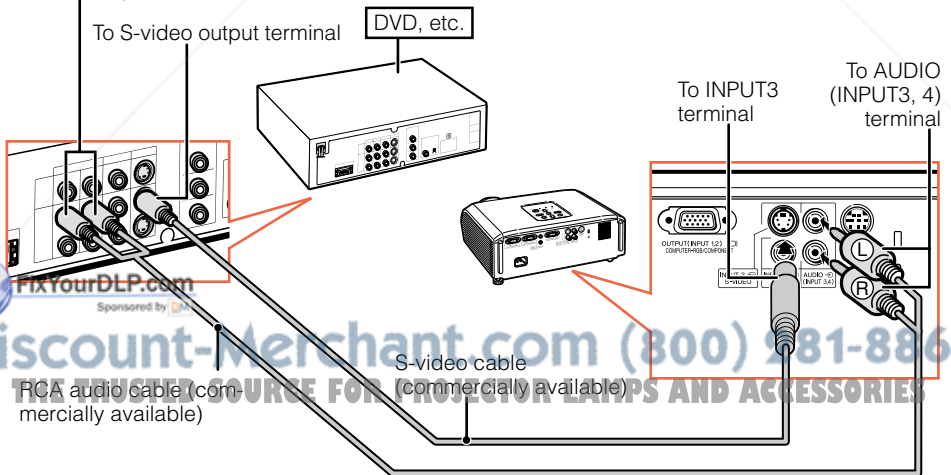

When using a composite video cable (INPUT4)

To audio output terminal

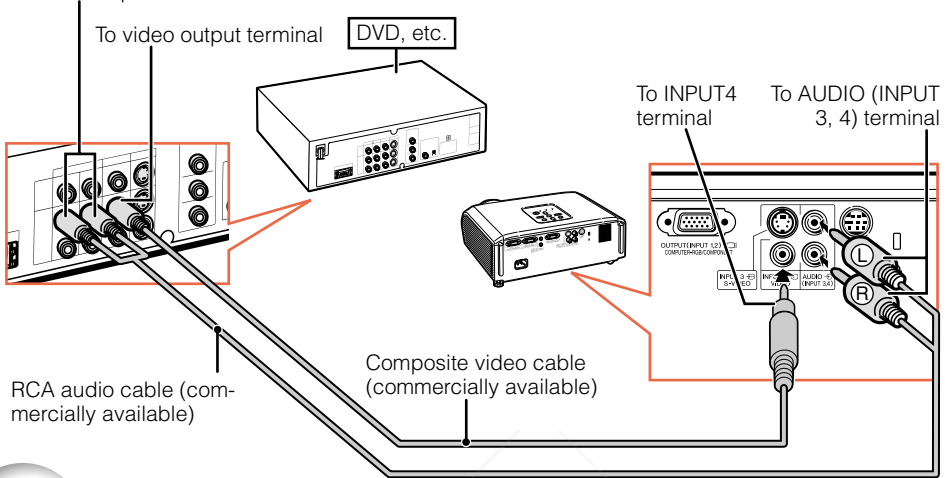

Connecting to a Monitor with RGB Input Terminal

You can display computer images on both the projector and a separate monitor using two sets of RGB cables.

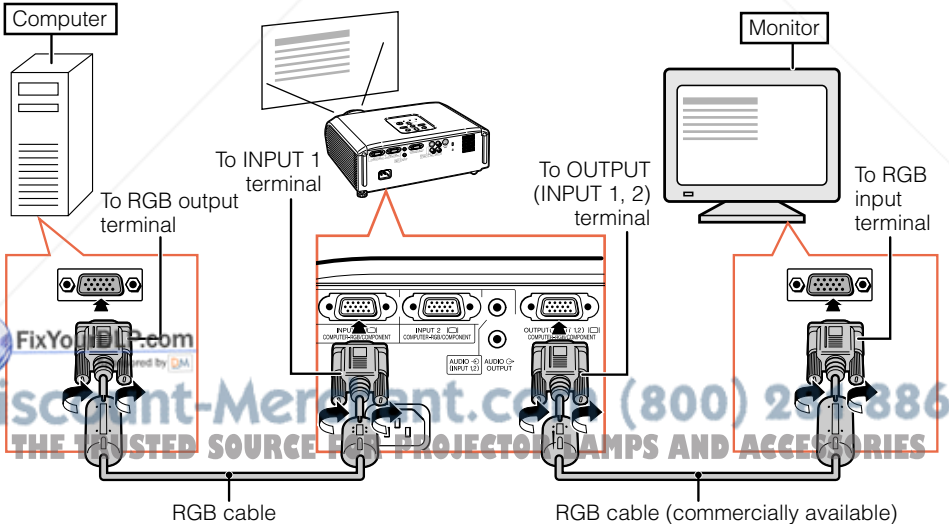

Note

- RGB signals and Component signals can be output to the monitor.
- For this connection, another RGB cable (commercially available) is required.

Controlling the Projector by a Computer

When the RS-232C terminal on the projector is connected to a computer with a DIN-D-sub RS-232C adaptor (optional: AN-A1RS) and an RS-232C serial control cable (cross type, commercially available), the computer can be used to control the projector and check the status of the projector. See page 54 for detail.

When connecting to a computer using an RS-232C serial control cable and a DIN-D-sub RS-232C adaptor

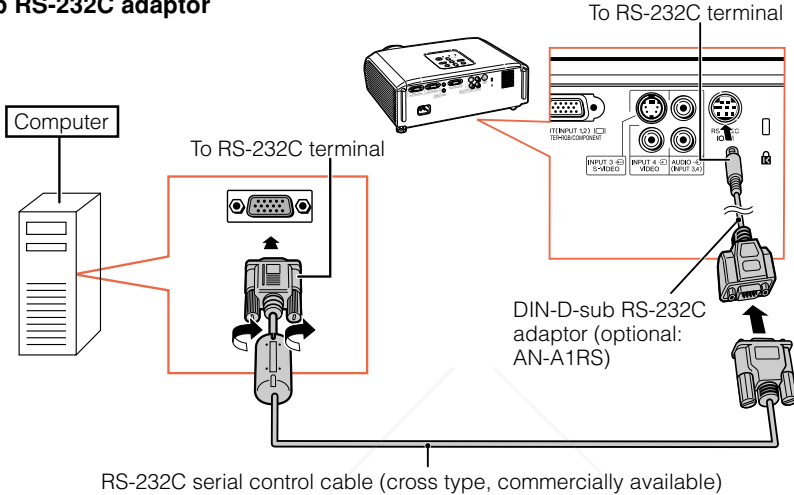

Note

- The RS-232C function may not operate if your computer terminal is not correctly set up. Refer to the operation manual of the computer for details.
- See page 53 for connection of an RS-232C serial control cable.

Info

- Do not connect the RS-232C cable to a port other than the RS-232C terminal on the computer. This may damage your computer or projector.
- Do not connect or disconnect an RS-232C serial control cable to or from the computer while it is on. This may damage your computer.

Connecting the Power Cord

Plug the supplied power cord into the AC socket on the rear of the projector.

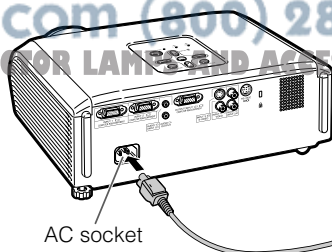
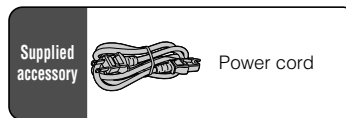

Turning the Projector On/Off

Turning the Projector on

Note that the connections to external equipment and power outlet should be done before performing the operations written below. (See pages 23 to 26.)

Remove the lens cap and press  STANDBY/ON on the projector or  ON on the remote control.

- When System Lock is set, the keycode input box appears. To cancel the keycode setting, input the keycode that you have already set. See page 44 for details.

Note

About the Lamp Indicator

The lamp indicator illuminates to indicate the status of the lamp.

Green: The lamp is on.

Blinking in green: The lamp is warming up or shutting down.

Red: The lamp is shut down abnormally or the lamp should be replaced.

- When switching on the projector, a slight flickering of the image may be experienced within the first minute after the lamp has been illuminated. This is normal operation as the lamp's control circuitry is stabilising the lamp output characteristics. It should not be regarded as faulty operation.
- If the projector is put into standby mode and immediately turned on again, the lamp may take some time to start projection.

Info

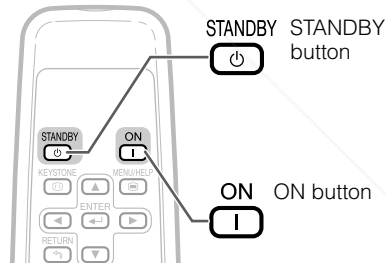
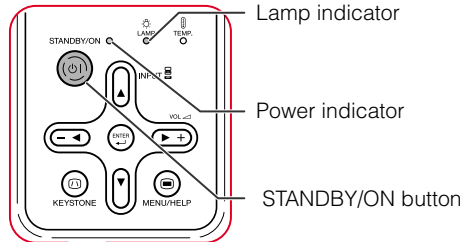

- English is the factory default language. If you want to change the on-screen display to another language, change the language according to the procedure on page 42.

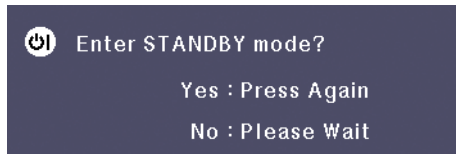

On-screen Display (confirmation message)



Turning the Power off (Putting the Projector into Standby Mode)

1 Press  STANDBY/ON on the projector or  STANDBY on the remote control, then press that button again while the confirmation message is displayed, to put the projector into standby mode.

2 Unplug the power cord from the AC outlet after the cooling fan stops.

- The power indicator on the projector blinks in green while cooling.
- The power indicator changes to red when the projector finishes cooling.

Info

- Do not unplug the power cord during projection or cooling fan operation. This can cause damage due to rise in internal temperature, as the cooling fan also stops.

Image Projection

About the Setup Guide

After turning on the projector, the Setup Guide screen appears to assist you with projector setup.

- Guidance items
- 1 FOCUS
 - 2 HEIGHT ADJUST
 - 3 ZOOM
 - 4 ENTER

Press **ENTER** to exit the Setup Guide screen.

Note

- The Setup Guide screen automatically highlights the items in the following order:

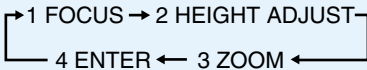

However, you can adjust the focus, height (angle), or zoom regardless of the highlighted item.

- If you do not want to display the Setup Guide for the next time, set "Menu" - "SCR - ADJ" - "Setup Guide" to "Off". (See page 42.)

Setup Guide screen

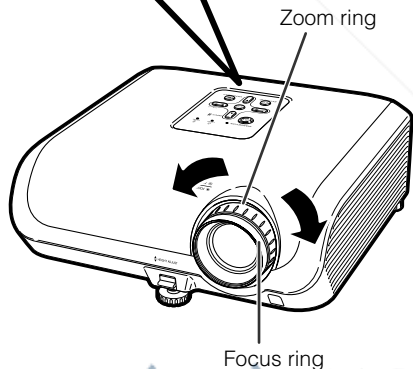
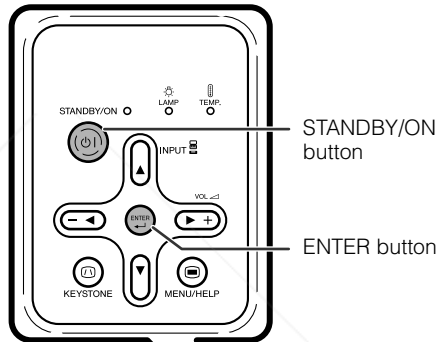
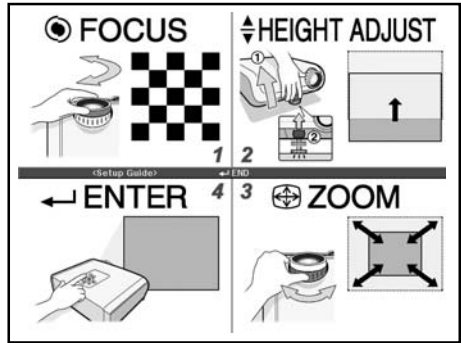

Adjusting the Projected Image

1 Adjusting the Focus

You can adjust the focus with the focus ring on the projector.

Rotate the focus ring to adjust the focus while watching the projected image.

2 Adjusting the Screen Size

You can adjust the screen size using the zoom ring on the projector.

Rotate the zoom ring to enlarge or shrink the screen size.

3 Adjusting the Height

The height of the projector can be adjusted using the adjustment feet at the front and rear of the projector.

When the screen is above the projector, the projection image can be made higher by adjusting the projector.

1 Lift the projector to adjust its height while lifting the HEIGHT ADJUST lever.

2 Remove your hands from the HEIGHT ADJUST lever of the projector after its height has been finely adjusted.

- The angle of projection is adjustable up to 8 degrees from the surface on which the projector is placed.

3 Use the rear adjustment foot to make the projector level.

- The projector is adjustable ± 1 degree from the standard position.

Note

- When adjusting the height of the projector, trapezoidal distortion occurs. Follow the procedures in Keystone Correction to correct the distortion. (See pages 31 and 41.)

Info

- Do not apply too much pressure on the projector when the front adjustment foot comes out.
- When lowering the projector, be careful not to get your fingers caught in the area between the adjustment foot and the projector.
- Hold the projector firmly while lifting or carrying.
- Do not hold by the lens area.

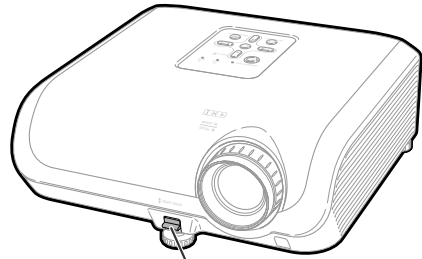

HEIGHT ADJUST lever

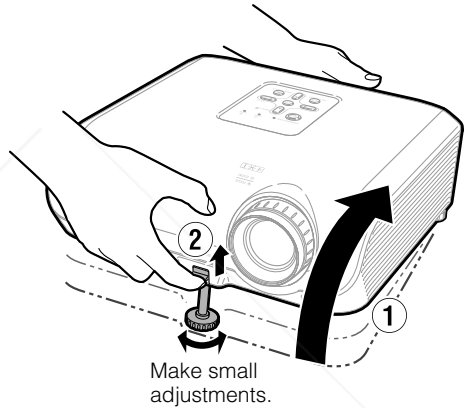

Make small adjustments.

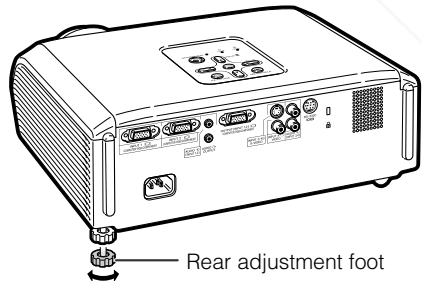

Rear adjustment foot

Image Projection (Continued)

Switching the Input Mode

Select the appropriate input mode for the connected equipment.

Press **INPUT 1**, **INPUT 2**, **INPUT 3** or **INPUT 4** on the remote control to select the input mode.

- When pressing INPUT (▲/▼) on the projector, input mode switches in the following order:
INPUT1 ↔ INPUT2 ↔ INPUT3 ↔ INPUT4
- When "Auto Search" is set to "On", INPUT (▲/▼) on the projector functions as the Auto Search buttons. (See page 43.)

Adjusting the Volume

Press **[-]/[+]** on the remote control or **[-] / [▶] +** on the projector to adjust the volume.

Note

- Pressing **[-]/[-]** will lower the volume.
- Pressing **[+]/[▶] +** will raise the volume.
- When the projector is connected to external equipment, the volume level of the external equipment changes in accordance with the volume level of the projector. Set the projector's volume to the lowest level when turning the projector on/off or changing the input signal.
- When you do not want to output the sound from the projector's speaker while the projector is connected to external equipment, set "Speaker" in "PRJ-ADJ" menu to "Off". (See page 43.)

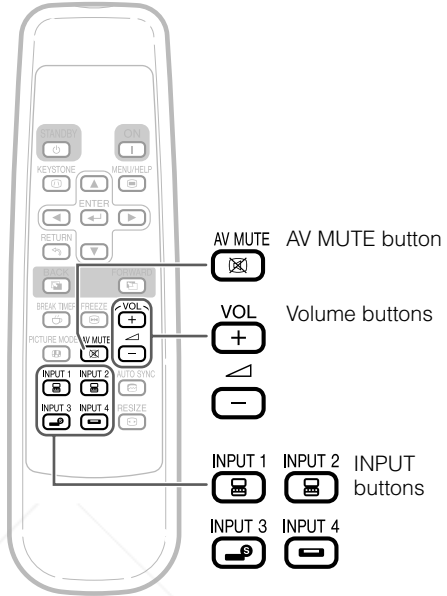

On-screen Display



Displaying the Black Screen and Turning off the Sound Temporarily

Press **AV MUTE** on the remote control to temporarily display a black screen and turn off the sound.

Note

- Pressing **AV MUTE** again will turn the projected image back on.

On-screen Display



Correcting Trapezoidal Distortion

When the image is projected either from the top or from the bottom towards the screen at an angle, the image becomes distorted trapezoidally. The function for correcting trapezoidal distortion is called **Keystone Correction**.

Note

- The Keystone Correction can be adjusted up to an angle of approximately ± 13 degrees and the screen can also be set up to an angle of approximately ± 13 degrees (when the resize mode is set to "NORMAL" (see page 32)).

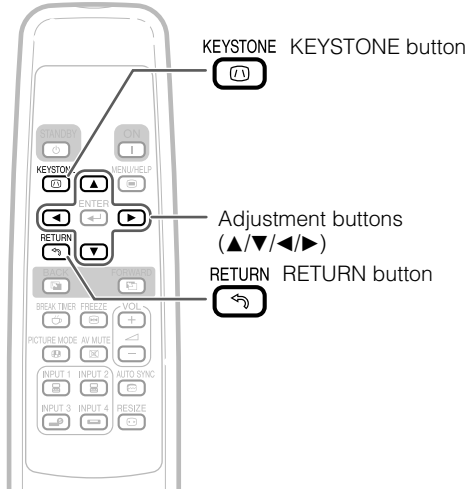

1 Press **KEYSTONE** to enter the Keystone Correction mode.

- You can also display the on-screen display of the Keystone Correction mode with **KEYSTONE** on the projector.

2 Press **▲/▶** or **◀/▼** to adjust the Keystone Correction.

- You can also adjust the Keystone Correction using the adjustment buttons on the projector.

Note

- Press **RETURN** while the on-screen display of the Keystone Correction mode is on the screen to return to the default setting.

3 Press **KEYSTONE**.

- The on-screen display of the Keystone Correction mode will disappear.
- You can also use **KEYSTONE** on the projector.

When using XR-20X

- The projector automatically detects tilt and the **AUTO KEYSTONE** feature automatically corrects trapezoidal distortion.

On-screen display (Keystone Correction mode)

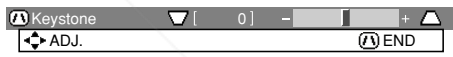

Shrinks upper side.
(Move the slide bar in the + direction.)

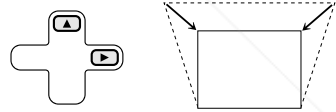

Shrinks lower side.
(Move the slide bar in the - direction.)

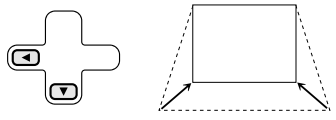

Info

- While adjusting the image using Keystone Correction, straight lines and the edges of the image may appear jagged.

Note

- Automatic Keystone Correction may not work well in some cases, such as when the screen is leaning, temperature is extremely high or low, or zoom is at maximum or minimum. In these cases, fine adjust the Keystone Correction following steps 1 to 3.
- You can select "On" or "Off" for the Auto Keystone Correction mode. (See page 41.)

Image Projection (Continued)

Resize Mode

This function allows you to modify or customize the resize mode to enhance the input image. Depending on the input signal, you can choose “NORMAL”, “BORDER” or “STRETCH” image.



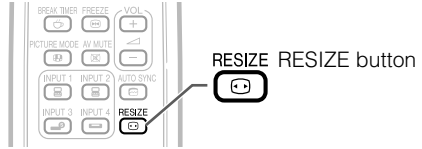

Press  **RESIZE**.

- See page 41 for setting on menu screen.

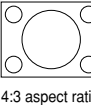
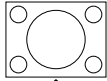
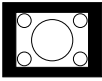
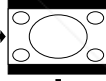

Computer

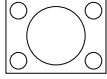
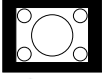
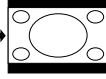
| | | NORMAL | | BORDER | | STRETCH | |
|---------------------|----------------------|------------|------------|------------|------------|------------|------------|
| | | XR-20X/10X | XR-20S/10S | XR-20X/10X | XR-20S/10S | XR-20X/10X | XR-20S/10S |
| 4:3 aspect ratio | SVGA (800 × 600) | | | | | | |
| | XGA (1024 × 768) | 1024 × 768 | 800 × 600 | 768 × 576 | 600 × 450 | 1024 × 576 | 800 × 450 |
| | SXGA (1280 × 960) | | | | | | |
| | SXGA + (1400 × 1050) | | | | | | |
| Other aspect ratios | SXGA (1280 × 1024) | 1024 × 768 | 800 × 600 | 768 × 576 | 600 × 450 | 1024 × 576 | 800 × 450 |
| | 1280 × 720 | — | — | — | — | 1024 × 576 | 800 × 450 |





| Input Signal | | Image type | Output screen image | | |
|----------------------------|-----------------------------|--|---|---|---|
| Computer | | | NORMAL | BORDER | STRETCH |
| XR-20X/10X | XR-20S/10S | | | | |
| Resolution lower than XGA | Resolution lower than SVGA | | | | |
| XGA | SVGA |  4:3 aspect ratio |  |  |  |
| Resolution higher than XGA | Resolution higher than SVGA | | | | |
| SXGA (1280 × 1024) | |  5:4 aspect ratio |  |  |  |
| | 1280 × 720 |  16:9 aspect ratio | | |  |

* Mode for projecting an image with the original aspect ratio without cutting any portions.

 : Cutout area on which images cannot be projected.

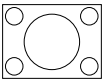
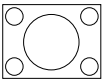
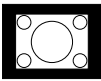
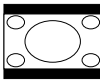
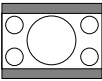
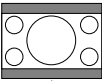
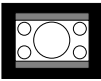
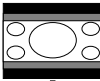
VIDEO

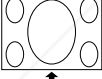
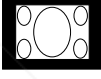
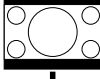
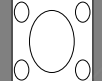
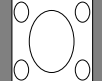
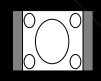
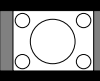
• “STRETCH” is fixed when 540P, 720P or 1080I signals are entered.

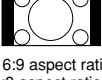
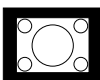
| Input Signal | | Output screen image | | |
|--|--|---|---|---|
| DVD / Video | Image type | NORMAL | BORDER | STRETCH |
| 480I, 480P, 576I, 576P, NTSC, PAL, SECAM |  4:3 aspect ratio | *  | *  |  |
| |  Letter box | *  | *  |  |
| |  Squeezed 16:9 image |  |  | *  |
| |  Squeezed 4:3 image |  |  | *  |
| 540P, 720P, 1080I |  16:9 aspect ratio | — | — | *  |
| |  16:9 aspect ratio (4:3 aspect ratio in 16:9 screen) | — | — | *  |

* Mode for projecting an image with the original aspect ratio without cutting any portions.

— : Cutout area on which images cannot be projected.

* : Area on which the image is not included in the original signals.



Discount-Merchant.com (800) 281-8860
THE TRUSTED SOURCE FOR PROJECTOR LAMPS AND ACCESSORIES

Operating with the Remote Control

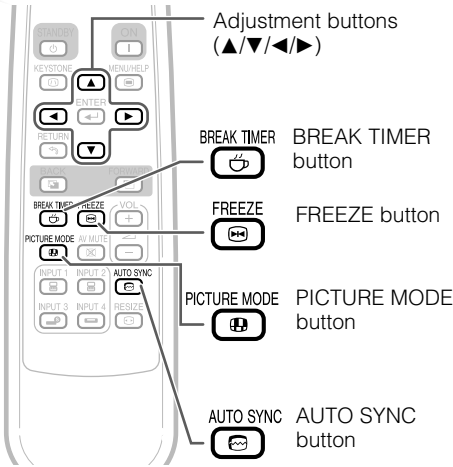

Auto Sync (Auto Sync Adjustment)

Auto Sync function works when detecting input signal after the projector turns on.

Press **⏸** AUTO SYNC to manually adjust with Auto Sync function.

Note

- When the optimum image cannot be achieved with Auto Sync adjustment, use the help menu for manual adjustments. (See page 46.)

Displaying and Setting the Break Timer

- Press **⏸** BREAK TIMER.
 - The timer starts to count down from 5 minutes.
 - ▼On-screen display



- Press **▲/▼/◀/▶** to adjust the length of the break time.
 - Increases with **▲** or **▶**
5 minutes → 6 minutes → 60 minutes
 - Shortens with **◀** or **▼**
4 minutes → 3 minutes → 1 minute
 - The break time can be set in units of one minute (up to 60 minutes).

Canceling the break time display function

Press **⏸** BREAK TIMER.

Note

- Break Timer does not function while the projector is operating the "Auto Sync", "FREEZE" or "AV MUTE" functions.

Freezing a Moving Image

- Press **⏸** FREEZE.
 - The projected image is frozen.
- Press **⏸** FREEZE again to return to the moving image from the currently connected device.

Selecting the Picture Mode

You can select the appropriate picture mode for the projected image, such as movie or video game.

Press **Ⓜ** PICTURE MODE.

- When pressing **Ⓜ** PICTURE MODE, the picture mode changes in the following order:
Standard → Presentation → Movie → Game → sRGB*

Note

- See page 39 for details on the picture mode.

* "sRGB" is displayed only when RGB signal is input.

Menu Items

The following shows the items that can be set in the projector.

“Picture” menu

INPUT 1 (RGB)/INPUT2 (RGB)

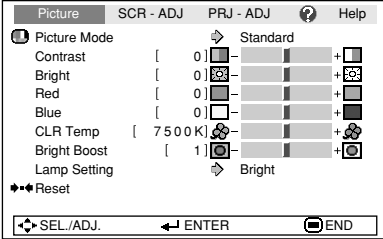

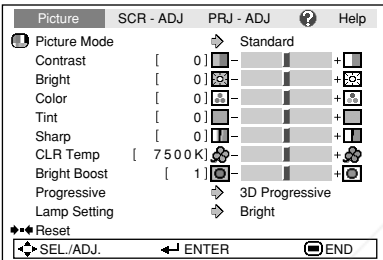

INPUT 1 (Component)/INPUT 2 (Component)/INPUT 3/INPUT 4

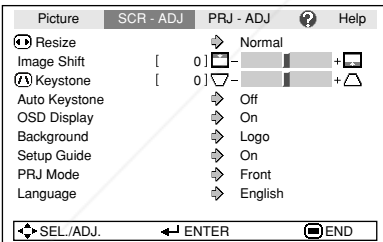

“Screen adjustment (SCR-ADJ)” menu



- You can adjust the menu items with icons (), (), and () using the respective buttons on the remote control.

*1 Items when inputting RGB signal through INPUT 1 or INPUT 2.

*2 Items when inputting component signal through INPUT 1 or INPUT 2, or when selecting INPUT 3 or INPUT 4.

*3 Adjustment range for XR-20X/XR-10X

*4 Adjustment range for XR-20S/XR-10S.

*5 An item which appears in the menu when using XR-20X.

*6 “Tone” will appear on the menu screen only when PAL or SECAM signals are input (including when forcibly changed to those input signals). There is basically no need to adjust “Tone”, but you can adjust the picture tone with this adjustment when inputting PAL or SECAM signals.

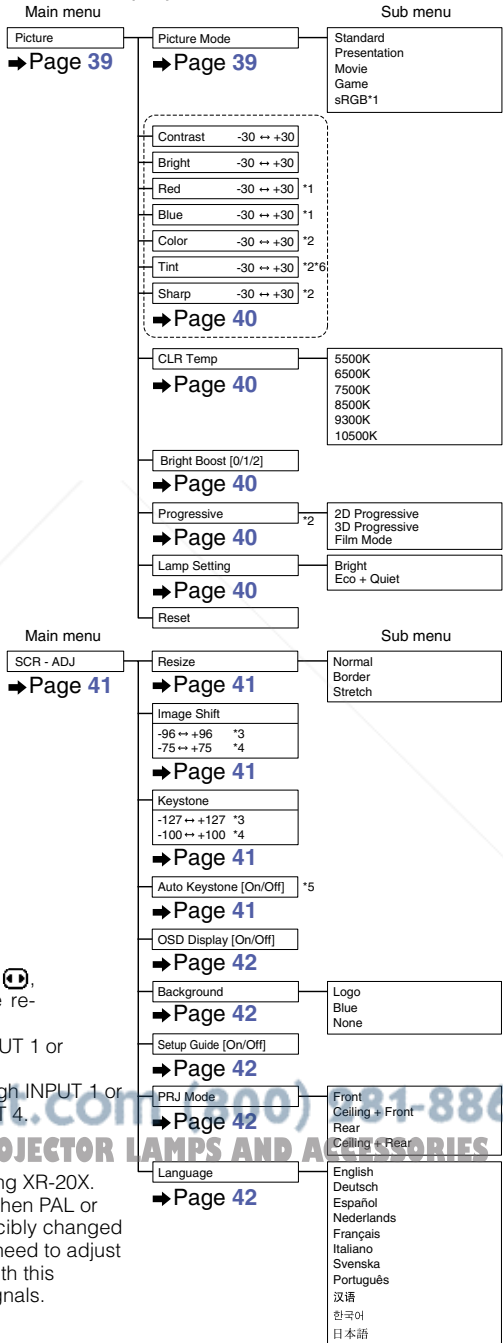

Menu Items (Continued)

“Projection adjustment (PRJ-ADJ)” menu

| Picture | SCR - ADJ | PRJ - ADJ | ? | Help |
|----------------|-----------|-----------|---|------|
| Auto Search | ⇒ | On | | |
| Auto Sync | ⇒ | On | | |
| Auto Power Off | ⇒ | On | | |
| System Sound | ⇒ | On | | |
| Speaker | ⇒ | On | | |
| RS-232C | ⇒ | 9600 bps | | |
| Fan Mode | ⇒ | Normal | | |
| System Lock | | | | |

Lamp Timer(Life) [0] h (100%)

⇐SEL./ADJ. ↵ENTER ⏻END

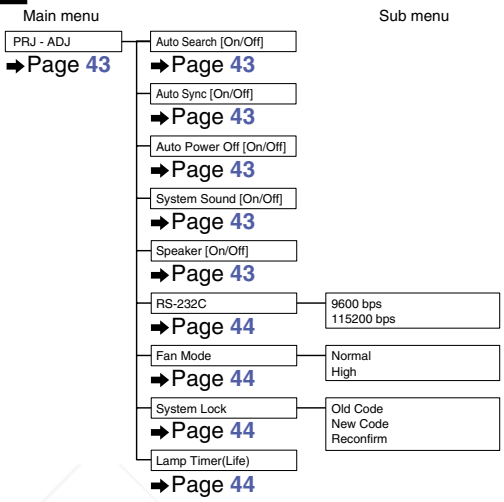

“Help” menu

| Picture | SCR - ADJ | PRJ - ADJ | ? | Help |
|---|-----------|-----------|---|------|
| <ul style="list-style-type: none"> • There is no picture or audio • Vertical stripes or flickering image appear • Data image is not centered • Color is faded or poor • Picture is dark • The image is distorted • Reset all adjustments to default settings | | | | |

⇐SEL. ↵ENTER ⏻END

Sponsored by DM

The items you can set with “Help” menu

- “Help” menu → Page 46
- Vertical stripes or flickering image appear
 - Auto Sync
 - Adjust vertical noise
 - Adjust horizontal noise
 - Data image is not centered
 - Auto Sync
 - H-Pos
 - V-Pos
 - Color is faded or poor
 - INPUT 1 or INPUT 2
 - Signal type: Auto/RGB/Component
 - INPUT 3 or INPUT 4
 - Video System: Auto / PAL / SECAM / NTSC3.58/NTSC4.43/PAL M/PAL-N/PAL-60

* The selectable items vary depending on the input signal and the selected input mode.

Using the Menu Screen

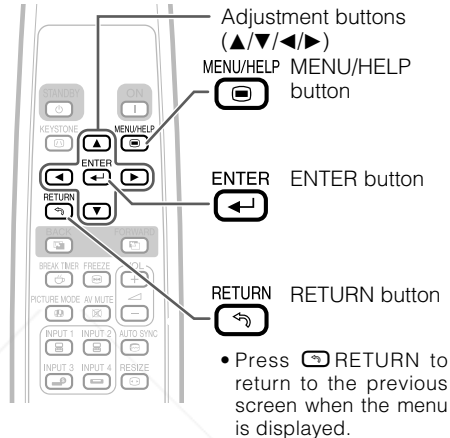
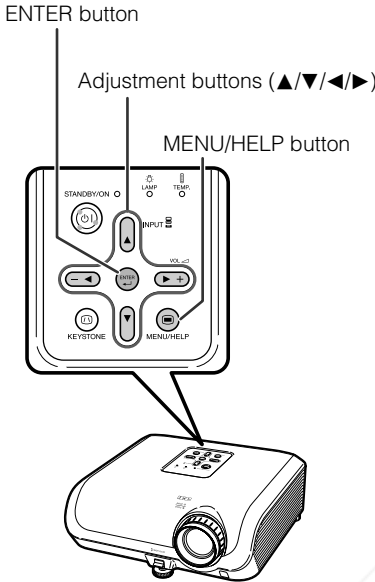

Menu Selections (Adjustments)

Example: Adjusting "Bright".

- This operation can also be performed by using the buttons on the projector.

1 Press **MENU**.

- The "Picture" menu screen for the selected input mode is displayed.

2 Press **▶** or **◀** and select "Picture" to adjust.

Example: "Picture" screen menu for INPUT 1 (RGB) mode

Menu item

| Picture | SCR - ADJ | PRJ - ADJ | ? | Help |
|---------------|-----------|-----------|---|------|
| Picture Mode | | Standard | | |
| Contrast | [0] | [-] [] | | |
| Bright | [0] | [] [] | | |
| Red | [0] | [-] [] | | |
| Blue | [0] | [-] [] | | |
| CLR Temp | [7500K] | [] [] | | |
| Bright Boost | [1] | [-] [] | | |
| Lamp Setting | | Bright | | |
| ◆◆◆ Reset | | | | |
| ◆◆◆ SEL./ADJ. | | ENTER | | END |



Discount-Merchant.com (800) 251-8860
 THE TRUSTED SOURCE FOR PROJECTOR LAMPS AND ACCESSORIES

Useful Features

Using the Menu Screen (Continued)

3 Press ▲ or ▼ and select “Bright” to adjust.

- The selected item is highlighted.

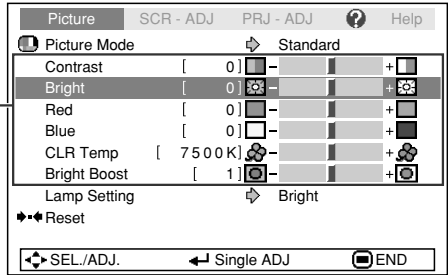

Items to be adjusted

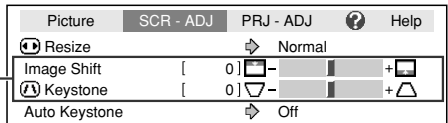

To adjust the projected image while watching it

Press ENTER.

- The selected item (e.g. “Bright”) is displayed by itself at the bottom of the screen.
- When pressing ▲ or ▼, the following item (“Red” after “Bright”) will be displayed.

The item displayed by itself

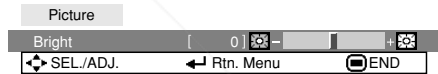

Note

- Press ENTER again to return to the previous screen.

4 Press ◀ or ▶ to adjust the item selected.

- The adjustment is stored.

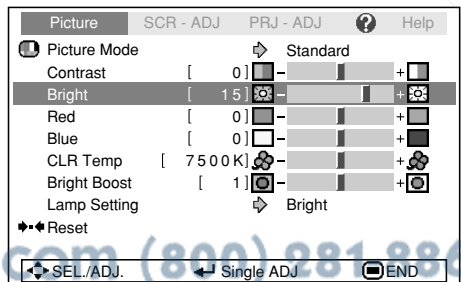

5 Press MENU/HELP.

- The menu screen will disappear.

Note

- Menu buttons do not function while the projector is operating the “Auto Sync”, “Break Time”, “FREEZE”, or “AV MUTE” functions.

FixYourDLP.com
Sponsored by DM

Discount-Merchant.com (800) 281-8860

THE TRUSTED SOURCE FOR PROJECTOR LAMPS AND ACCESSORIES

Picture Adjustment (“Picture” menu)

Menu operation → Page 37

▶ Example: “Picture” screen menu for INPUT 1 (RGB) mode

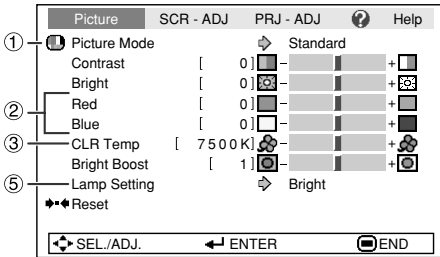

▶ Example: “Picture” screen menu for INPUT 3 mode

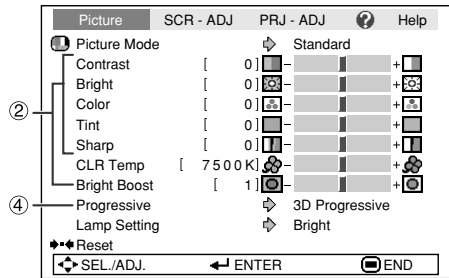

① Selecting the Picture Mode

| Selectable items | Description | The default settings of each item when selecting Picture Mode | | |
|------------------|--|---|--------------|--------------|
| | | CLR Temp | Bright Boost | Lamp Setting |
| Standard | For standard image | 7500K | 1 | Bright |
| Presentation | Brightens portions of image for more enhanced presentations. | 7500K | 2 | Bright |
| Movie | Gives natural tint to the projected image. | 6500K | 0 | Eco + Quiet |
| Game | Gives sharpness to the projected image. | 7500K | 2 | Bright |
| *sRGB | For high fidelity reproduction of images from a computer. | - | - | Bright |

- “sRGB” is displayed only when RGB signal is input.
- You can set or adjust each item in the “Picture” menu to your preference. Any changes you make are retained in memory.

Note

- You can also press **PICTURE MODE** on the remote control to select the picture mode. (See page 34.)
- *sRGB is an international standard of color reproduction regulated by the IEC (International Electrotechnical Commission). As the fixed color area has been decided by the IEC, the images are displayed in a natural tint based on an original image, when “sRGB” is selected. For additional information about the sRGB function, visit “<http://www.srgb.com/>”. You cannot set the items, “Red”, “Blue”, “CLR Temp”, “Bright Boost”, when “sRGB” is selected.

FixYourDLP.com

Sponsored by



- When “sRGB” is selected, the projected image may become dark, but this does not indicate a malfunction.

Picture Adjustment (“Picture” menu) (Continued)

Menu operation → Page 37

② Adjusting the Image

| Adjustment Items | ◀ button | ▶ button |
|------------------|---------------------------------------|---------------------------------|
| Contrast | For less contrast. | For more contrast. |
| Bright | For less brightness. | For more brightness. |
| Red*1 | For weaker red. | For stronger red. |
| Blue*1 | For weaker blue. | For stronger blue. |
| Color*2 | For less color intensity. | For more color intensity. |
| Tint*2*3 | For making skin tones purplish. | For making skin tones greenish. |
| Sharp*2 | For less sharpness. | For more sharpness. |
| Bright Boost*1 | For high fidelity color reproduction. | For more vividness. |

*1 Not adjustable/selectable when selecting “sRGB”.

*2 Not displayed in the RGB input mode.

*3 “Tone” will appear on the menu screen only when PAL or SECAM signals are input (including when forcibly changed to those input signals). There is basically no need to adjust “Tone”, but you can adjust the picture tone with this adjustment when inputting PAL or SECAM signals.

Note

- “Bright Boost” and “CLR Temp” cannot be set when “sRGB” is selected.
- To reset all adjustment items, select “Reset” and press ENTER.

③ Adjusting the Color Temperature

| Selectable Items | Description |
|---|---|
| 5500K 6500K 7500K 8500K 9300K 10500K | For lower color temperature for warmer, reddish incandescent-like images. ↑ For higher color temperature for cooler, bluish, fluorescent-like images. |

Note

- Values on “CLR Temp” are only for general standard purposes.

④ Progressive

| Selectable items | Description |
|------------------|---|
| 2D Progressive | Useful to display fast-moving images such as sports. |
| 3D Progressive | Useful to display relatively slow-moving images such as drama and documentary more clearly. |
| Film Mode | Reproduces the image of film source* clearly. Displays the optimized image of film transformed with three-two pull down (NTSC and PAL60Hz) or two-two pull down (PAL50Hz and SECAM) enhancement to progressive mode images. |

* The film source is a digital video recording with the original encoded as is at 24 frames/second. The projector can convert this film source to progressive video at 60 frames/second with NTSC and PAL60Hz or at 50 frames/second with PAL50Hz and SECAM to play back a high-definition image.

Note

- In NTSC or PAL60Hz, even if the 3D Progressive mode has been set, the three-two pull down enhancement will be enabled automatically when the film source has been entered.
- When the image is blurred or noisy, switch to the optimal mode.
- When using progressive inputs, inputs are directly displayed so that 2D Progressive, 3D Progressive and Film Mode cannot be selected.

⑤ Lamp Setting

| Selectable items | Brightness | Fan sound | Power consumption (When using AC 100V) | Lamp Life |
|------------------|-------------|-----------|--|---------------------|
| Eco + Quiet | Approx. 87% | Low | 305W | Approx. 3,000 hours |
| Bright | 100% | Normal | 350W | Approx. 2,000 hours |

Note

- When “Lamp Setting” is set to “Eco+Quiet”, the power consumption will decrease and the lamp life will extend. (Projection brightness decreases approximately 13%.)

Adjusting the Projected Image (“SCR - ADJ” menu)

Menu operation → Page 37

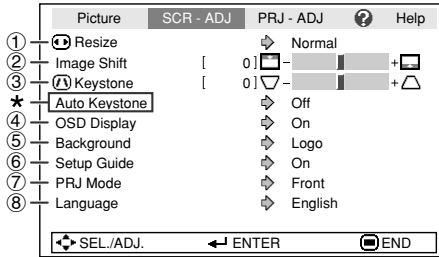

*“Auto Keystone” can be operated only when using XR-20X.

① Setting the Resize Mode

Note

- For details of the Resize mode, see pages 32 and 33.
- You can also press **RESIZE** on the remote control to set the resize mode. (See page 32.)

② Adjusting the Image Position

You can move the projected image vertically.

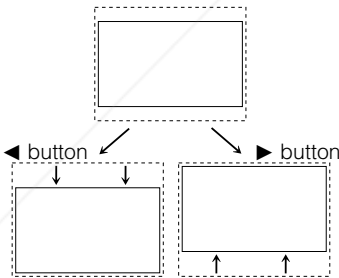

③ Keystone Correction

When the image is projected either from the top or from the bottom towards the screen at an angle, the image becomes distorted trapezoidally. The function for correcting trapezoidal distortion is called Keystone Correction.

■ When using XR-20X

For Auto Keystone Correction

Set “Auto Keystone” on the “SCR - ADJ” menu to “On”.

For Manual Keystone Correction

Set “Auto Keystone” on the “SCR - ADJ” menu to “Off”, select “Keystone”, and then adjust with the slide bar.

Manual Correction

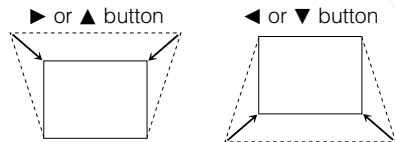

■ When using XR-20S, XR-10X or XR-10S
Select “Keystone” on the “SCR-ADJ” menu and adjust with the slide bar.

See page 31 for details of Keystone Correction.

Note

- You cannot set this item when “Resize” is set to “Normal”.

Note

- The Keystone Correction can be adjusted up to an angle of approximately ± 13 degrees with the “Auto Keystone” and up to an angle of approximately ± 13 degrees with the manual “Keystone” (when “Resize” is set to “Normal”).

Adjusting the Projected Image (“SCR - ADJ” menu) (Continued)

Menu operation → Page 37

④ Setting On-screen Display

| Selectable items | Description |
|------------------|--|
| On | All On-screen Displays are displayed. |
| Off | INPUT/VOLUME/AV MUTE/FREEZE/AUTO SYNC/RESIZE/PICTURE MODE/“An invalid button has been pressed.” are not displayed. |

⑦ Reversing/Inverting Projected Images

| Selectable items | Description |
|------------------|--|
| Front | Normal image (Projected from the front of the screen) |
| Ceiling + Front | Inverted image (Projected from the front of the screen with an inverted projector) |
| Rear | Reversed image (Projected from the rear of the screen or with a mirror) |
| Ceiling + Rear | Reversed and inverted image (Projected with a mirror) |

See page 19 for details of Projection (PRJ) Mode.

⑤ Selecting the Background Image

| Selectable items | Description |
|------------------|-------------------|
| Logo | Sharp logo screen |
| Blue | Blue screen |
| None | — |

⑧ Selecting the On-screen Display Language

The projector can switch the on-screen display language among 11 languages.

- English
- Deutsch
- Español
- Nederlands
- Français
- Italiano
- Svenska
- Português
- 汉语
- 한국어
- 日本語

⑥ Selecting the Setup Guide

| Selectable items | Description |
|------------------|---|
| On | Displaying the Setup Guide when turning the projector on. |
| Off | Not displaying the Setup Guide. |



Discount-Merchant.com (800) 281-8860
THE TRUSTED SOURCE FOR PROJECTOR LAMPS AND ACCESSORIES

Adjusting the Projector Function (“PRJ - ADJ” menu)

Menu operation → Page 37

| | Picture | SCR - ADJ | PRJ - ADJ | ? | Help |
|---|---------------------------------|-----------|------------|---|------|
| ① | Auto Search | | ⇒ On | | |
| ② | Auto Sync | | ⇒ On | | |
| ③ | Auto Power Off | | ⇒ On | | |
| ④ | System Sound | | ⇒ On | | |
| ⑤ | Speaker | | ⇒ On | | |
| ⑥ | RS-232C | | ⇒ 9600 bps | | |
| ⑦ | Fan Mode | | ⇒ Normal | | |
| ⑧ | System Lock | | | | |
| ⑨ | Lamp Timer(Life) [0] h (100%) | | | | |
| <div style="display: flex; justify-content: space-between;"> ← SEL/ADJ. ← ENTER END → </div> | | | | | |

① Auto Search Function

This function automatically searches for and switches to the input mode in which signals are being received, when the projector is turned on, or when the INPUT button is pressed.



Note

When “Auto Search” is set to “On”

- If two or more input signals are found, the projector selects the input source in the order of INPUT 1 → INPUT 2 → INPUT 3 → INPUT 4 when you press INPUT (▲/▼) on the projector.
- While “Auto Search” is set to “On”, press INPUT 1, INPUT 2, INPUT 3 or INPUT 4 on the remote control to select an input mode other than the input mode selected by the projector.

③ Auto Power Off Function

| Selectable items | Description |
|------------------|---|
| On | When no input signal is detected for more than 15 minutes, the projector will automatically enter standby mode. |
| Off | The Auto Power Off function will be disabled. |



Note

- When the Auto Power Off function is set to “On”, 5 minutes before the projector enters standby mode, the message “Enter STANDBY mode in X min.” will appear on the screen to indicate the remaining minutes.

② Auto Sync (Auto Sync Adjustment)

| Selectable items | Description |
|------------------|---|
| On | Auto Sync adjustment will occur when the projector is turned on or when the input signals are switched, when connected to a computer. |
| Off | Auto Sync adjustment is not automatically performed. |



Note

- Auto Sync adjustment is also performed by pressing AUTO SYNC on the remote control.
- The Auto Sync adjustment may take some time to complete, depending on the image of the computer connected to the projector.
- When the optimum image cannot be achieved with Auto Sync adjustment, use manual adjustments. (See page 46.)

④ Setting the Confirmation Sound (System Sound)

| Selectable items | Description |
|------------------|---|
| On | A confirmation sound is made when the projector turns on/off. |
| Off | No confirmation sound is made. |

⑤ Speaker Setting

| Selectable items | Description |
|------------------|---|
| On | The audio signal is output from the internal speaker. |
| Off | The audio signal is not output from the internal speaker. |

Adjusting the Projector Function (“PRJ - ADJ” menu) (Continued)

Menu operation → Page 37

⑥ Selecting the Transmission Speed (RS-232C)

Make sure that both the projector and computer are set for the same baud rate.

| Selectable items | Description |
|------------------|---|
| 9600bps | Transmission speed is slow. |
| |  |
| 115200bps | Transmission speed is rapid. |

⑦ Fan Mode Setting

This function changes the fan rotation speed.

| Selectable items | Description |
|------------------|---|
| Normal | Suitable for normal environments. |
| High | Select this when using the projector at altitudes of approximately 1,500 meters (4,900 feet) or more. |

When “Fan Mode” is set to “High”, the fan rotation speeds up, and the fan noise becomes louder.

⑨ Checking the Lamp Life Status

You can confirm the cumulative lamp usage time and the remaining lamp life (percentage).

| Lamp usage condition | Remaining lamp life | | |
|--|---------------------|-------------------|-------------------|
| | “Life” | 100% | 5% |
| Operated exclusively with Lamp Setting set to “Eco +Quiet” | Approx. 3,000 hours | Approx. 150 hours | Approx. 150 hours |
| Operated exclusively with Lamp Setting set to “Bright” | Approx. 2,000 hours | Approx. 100 hours | Approx. 100 hours |

⑧ System Lock Function

This function prevents unauthorized use of the projector. Once this function is activated, users must enter the correct keycode each time the projector is turned on. **We suggest you record the keycode in a safe place where only authorized users have access.**

Info

- If you lose or forget your keycode, contact your nearest Sharp Authorized Projector Dealer or Service Center (see page 61). Even if the product warranty is valid, the keycode reset will incur a charge.

■ Setting/Changing the keycode

1 Press the 4 buttons on the remote control or on the projector to enter the preset keycode in “Old Code”.

- When setting the keycode for the first time, press ▼ on the projector for four times.

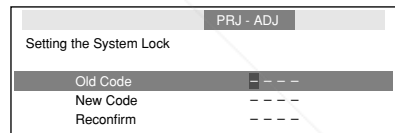

Note

- If you input a wrong keycode, the cursor returns to the first point of the “Old Code”.
- The preset keycode is 4 ▼ buttons on the projector. When you press the ▼ button four times, the keycord input screen disappears.

Note

- It is recommended that the lamp be changed when the remaining lamp life becomes 5%.
- The lamp life may vary depending on the usage condition.

2 Press the 4 buttons on the remote control or on the projector to enter the new keycode in “New Code”.

 **Note**

- You can not use the following buttons for keycode:
 - ON
 - STANDBY
 - ENTER
 - RETURN
 - MENU/HELP
- System lock function recognizes each button on the remote control or on the projector as an individual button, even if they share the same button name. If you used the buttons on the projector in setting your keycode, the keycode cannot be canceled with the remote control.**

| PRJ - ADJ | |
|-------------------------|---------|
| Setting the System Lock | |
| Old Code | * * * * |
| New Code | - - - - |
| Reconfirm | - - - - |

3 Enter the same keycode in “Reconfirm”.

 **Note**

To cancel the keycode that you have already set

- Press ▼ on the projector for four times in steps 2 and 3 above.

When the System Lock is set

- When System Lock is set, the keycode input screen appears after the power is turned on. When it appears, enter the right keycode to start projection.

Input screen for keycode

| | |
|-------------|---------|
| System Lock | - - - - |
|-------------|---------|

Locking the Operation Buttons on the Projector (Keylock Function)

Use this function to lock the operation buttons on the projector.

Locking the Operation Buttons

Hold down ⏻ ENTER on the projector for about 5 seconds while the projector is being turned on.

▼ On-screen Display

Keylock function ON

- The keylock function does not affect the operation with the remote control buttons.
- You cannot use the keylock function while the projector is warming up.

Taking the Keylock off

Hold down ⏻ ENTER on the projector for about 5 seconds.

▼ On-screen Display

Keylock function OFF

- When the projector is in standby mode, you can release the keylock by holding down ⏻ ENTER and ⏻ STANDBY/ON on the projector simultaneously for about 5 seconds.

Info

- Keylock does not function while the projector is: displaying the “Setup Guide” or “Menu” screens, in standby mode, warming up, changing input signals, operating “Auto Sync” function, in “FREEZE” mode or on the “System Lock” screen during warming up.

Troubleshooting with “Help” menu

This function advises you to solve the problems during usage.

Utilizing “Help” menu functions

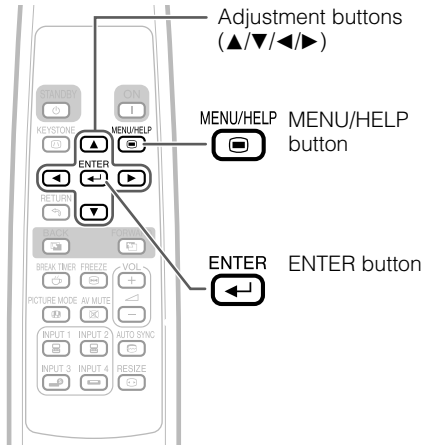

Example: When image flickering appears

Operation to solve image flickering when projecting the computer RGB signal.

1 Press **MENU/HELP**.

2 Press **◀** or **▶** to select “Help”, then press **ENTER**.

3 Press **▲** or **▼** to select “Vertical stripes or flickering image appears” on Help menu, then press **ENTER**.

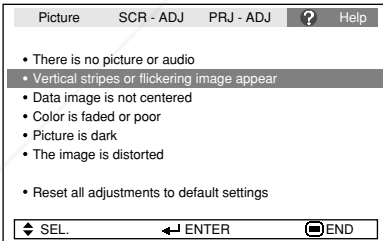

4 Select “Initiate “Auto Sync” Adjustments”, then press **ENTER**.

5 If the image is not improved, select “Adjust horizontal noise.”, then press **ENTER**.

6 Press **◀** or **▶** to adjust.

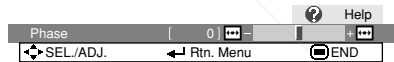

Note

- You can adjust the items with check marks (✓).
- The items in the “Help” menu change, depending on the input signal or setting that you have selected.
- If the problem is not solved, refer to “Troubleshooting”. (see pages 59 and 60)
- When selecting “sRGB” in “Picture Mode”, the item “Color is faded or poor” is not displayed. This means you cannot change input signal types.



FixYourDLP.com
Sponsored by DLP

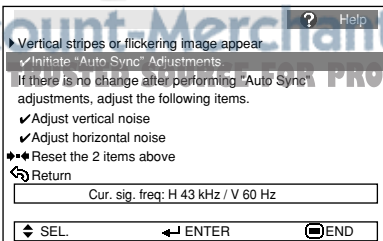

Maintenance

Cleaning the projector

- Ensure that you have unplugged the power cord before cleaning the projector.
- The cabinet as well as the operation panel is made of plastic. Avoid using benzene or thinner, as these can damage the finish on the cabinet.
- Do not use volatile agents such as insecticides on the projector.
Do not attach rubber or plastic items to the projector for long periods.
The effects of some of the agents in the plastic may cause damage to the quality or finish of the projector.
- Wipe off dirt gently with a soft flannel cloth.
- When the dirt is hard to remove, soak a cloth in a mild detergent diluted with water, wring the cloth well and then wipe the projector. Strong cleaning detergents may discolor, warp or damage the coating on the surface of the projector. Make sure to test on a small, inconspicuous area on the projector before use.

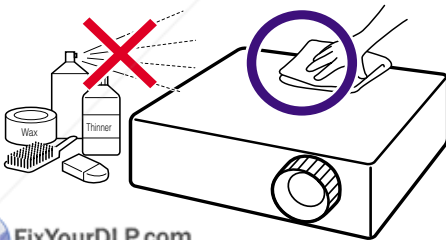

Cleaning the lens

- Use a commercially available blower or lens cleaning paper (for glasses and camera lenses) for cleaning the lens. Do not use any liquid type cleaning agents, as they may wear off the coating film on the surface of the lens.
- As the surface of the lens can easily get damaged, be sure not to scrape or hit the lens.

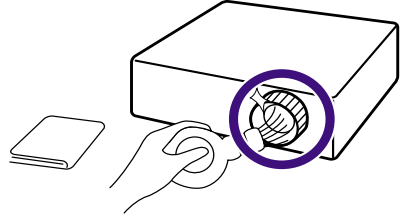

Cleaning the exhaust and intake vents

- Use a vacuum cleaner to clean dust from the exhaust vent and the intake vent.

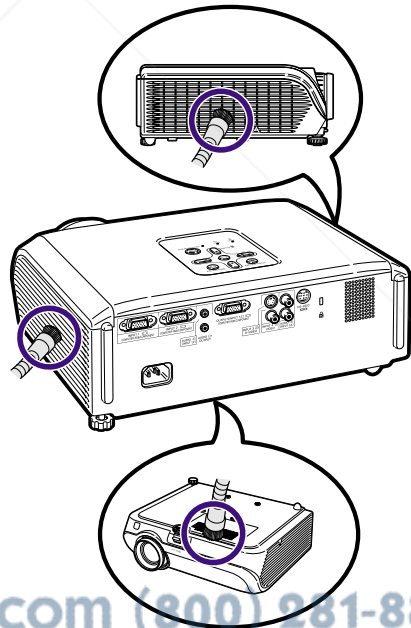

Info

- If you want to clean the air vents during projector operation, be sure to press **STANDBY/ON** on the projector or **STANDBY** on the remote control and put the projector into standby mode. After the cooling fan has stopped, clean the vents.

Maintenance Indicators

- The warning lights (power indicator, lamp indicator and temperature warning indicator) on the projector indicate problems inside the projector.
- If a problem occurs, either the temperature warning indicator or the lamp indicator will illuminate red, and the projector will enter standby mode. After the projector has entered standby mode, follow the procedures given below.

Top View

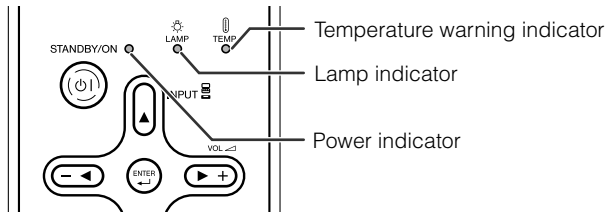

About the temperature warning indicator



If the temperature inside the projector increases, due to blockage of the air vents, or the setting location, "TEMP." will illuminate in the lower left corner of the picture. If the temperature keeps on rising, the lamp will turn off and the temperature warning indicator will blink, the cooling fan will run, and then the projector will enter standby mode. After "TEMP." appears, be sure to perform the measures described on page 49.

About the lamp indicator



■ When the remaining lamp life becomes 5% or less, (yellow) and "Change The Lamp" will be displayed on the screen. When the percentage becomes 0%, it will change to (red), the lamp will automatically turn off and then the projector will automatically enter standby mode. At this time, the lamp indicator will illuminate in red.

■ **If you try to turn on the projector a fourth time without replacing the lamp, the projector will not turn on.**

Indicators on the Projector

| | | |
|-------------------------------|--------------|--|
| Power indicator | Red on | Normal (Standby) |
| | Green on | Normal (Power on) |
| | Red blinks | Abnormal (See page 49.) |
| | Green blinks | Normal (Cooling) |
| Lamp indicator | Green on | Normal |
| | Green blinks | The lamp is warming up or shutting down. |
| | Red on | The lamp is shut down abnormally or requires to be changed. (See page 49.) |
| Temperature warning indicator | Off | Normal |
| | Red on | The internal temperature is abnormally high. (See page 49.) |

| Maintenance indicator | Maintenance indicator | | Problem | Cause | Possible Solution |
|-------------------------------|---|------------------|---|---|--|
| | Normal | Abnormal | | | |
| Temperature warning indicator | Off | Red on (Standby) | The internal temperature is abnormally high. | <ul style="list-style-type: none"> Blocked air intake | <ul style="list-style-type: none"> Relocate the projector to an area with proper ventilation. (see page 8) |
| | | | | <ul style="list-style-type: none"> Cooling fan breakdown Internal circuit failure Clogged air intake | <ul style="list-style-type: none"> Take the projector to your nearest Sharp Authorized Projector Dealer or Service Center (see page 61) for repair. |
| Lamp indicator | Green on (Green blinks when the lamp is warming up or turning off.) | Red on (Standby) | The lamp does not illuminate. | <ul style="list-style-type: none"> The lamp is shut down abnormally. | <ul style="list-style-type: none"> Disconnect the power cord from the AC outlet, and then connect it again. |
| | | | Time to change the lamp. | <ul style="list-style-type: none"> Remaining lamp life becomes 5% or less. | <ul style="list-style-type: none"> Carefully replace the lamp. (See page 51.) Take the projector to your nearest Sharp Authorized Projector Dealer or Service Center (see page 61) for repair. Please exercise care when replacing the lamp. Securely install the cover. |
| Power indicator | Green on/ Red on Green blinks (Cooling) | Red blinks | The power indicator blinks in red when the projector is on. | <ul style="list-style-type: none"> The lamp unit cover is open. | <ul style="list-style-type: none"> If the power indicator blinks in red even when the lamp unit cover is securely installed, contact your nearest Sharp Authorized Projector Dealer or Service Center (see page 61) for advice. |

Info

- If the temperature warning indicator illuminates, and the projector enters standby mode, follow the possible solutions above and then wait until the projector has cooled down completely before plugging in the power cord and turning the power back on. (At least 10 minutes.)
- If the power is turned off for a brief moment due to power outage or some other cause while using the projector, and the power supply recovers immediately after that, the lamp indicator will illuminate in red and the lamp may not be lit. In this case, unplug the power cord from the AC outlet, replace the power cord in the AC outlet and then turn the power on again.
- The cooling fan keeps the internal temperature of the projector constant and this function is controlled automatically. The sound of the cooling fan may change during operation because the fan speed may change and this is not a malfunction.
- Do not unplug the power cord after the projector has entered standby mode and while the cooling fan is running. The cooling fan runs for about 90 seconds.

Discount-Merchant.com (800) 281-8860
THE TRUSTED SOURCE FOR PROJECTOR LAMPS AND ACCESSORIES

Regarding the Lamp

Lamp

- It is recommended that the lamp (sold separately) be replaced when the remaining lamp life becomes 5% or less, or when you notice a significant deterioration in the picture and color quality. The lamp life (percentage) can be checked with the on-screen display. (see page 44)
- Purchase a replacement lamp of type AN-XR20LP/AN-XR10LP from your place of purchase, nearest Sharp Authorized Projector Dealer or Service Center.

IMPORTANT NOTE TO U.S. CUSTOMERS:

The lamp included with this projector is backed by a 90-day parts and labor limited warranty. All service of this projector under warranty, including lamp replacement, must be obtained through a Sharp Authorized Projector Dealer or Service Center. For the name of the nearest Sharp Authorized Projector Dealer or Service Center, please call toll-free: 1-888-GO-SHARP (1-888-467-4277).

Hg LAMP CONTAINS MERCURY For State Lamp Disposal Information

www.lamprecycle.org or 1-800-BE-SHARP

U.S.A. ONLY

Caution Concerning the Lamp

- This projector utilizes a pressurized mercury lamp. A loud sound may indicate lamp failure. Lamp failure can be attributed to numerous sources such as: excessive shock, improper cooling, surface scratches or deterioration of the lamp due to a lapse of usage time.
The period of time up to failure largely varies depending on the individual lamp and/or the condition and the frequency of use. It is important to note that failure can often result in the bulb cracking.
- When the lamp replacement indicator and on-screen display icon are illuminated, it is recommended that the lamp be replaced with a new one immediately, even if the lamp appears to be operating normally.
- Should the lamp break, there is also a possibility that glass particles may spread inside of the projector. In such a case, it is recommended you contact your nearest Sharp Authorized Projector Dealer or Service Center to assure safe operation.
- Should the lamp break, the glass particles may spread inside the lamp cage or gas contained in the lamp may be vented into the room from the exhaust vent. Because the gas in this lamp includes mercury, ventilate the room well if the lamp breaks and avoid all exposure to the released gas. In case of exposure to the gas, consult a doctor as soon as possible.

Replacing the Lamp

- Do not remove the lamp unit from the projector right after use. The lamp will be very hot and may cause burn or injury.
- **Carefully change the lamp by following the instructions described in this section. * If you wish, you may have the lamp replaced at your nearest Sharp Authorized Projector Dealer or Service Center.**

If the new lamp does not light after replacement, take your projector to the nearest Sharp Authorized Projector Dealer or Service Center for repair.

FixYourDLP.com
Discount-Merchant.com (800) 281-8860
THE TRUSTED SOURCE FOR PROJECTOR LAMPS AND ACCESSORIES



Removing and Installing the Lamp Unit

Warning!

- Do not remove the lamp unit from the projector right after use. The lamp and parts around the lamp will be very hot and may cause burns or injury.

Info

- Make sure that you remove the lamp unit by the handle. Do not touch the glass surface of the lamp unit or the inside of the projector.
- To avoid injury to yourself and damage to the lamp, be sure to carefully follow the steps below.
- Do not loosen other screws except for the lamp unit cover and lamp unit.



1 Press  **STANDBY/ON** on the projector or  **STANDBY** on the remote control to put the projector into standby mode.

- Wait until the cooling fan stops.

2 **Disconnect the power cord.**

- Unplug the power cord from the AC socket.
- Leave the lamp until it has fully cooled down (about 1 hour).

3 **Remove the lamp unit cover.**

- Turn the projector over. Loosen the user service screw  (1) that secures the lamp unit cover. Remove the lamp unit cover  (2).

Optional accessory

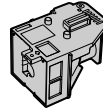

Lamp unit
AN-XR20LP
(for XR-20X/XR-20S)
AN-XR10LP
(for XR-10X/XR-10S)

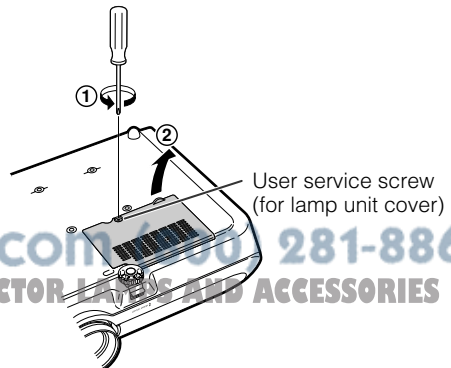
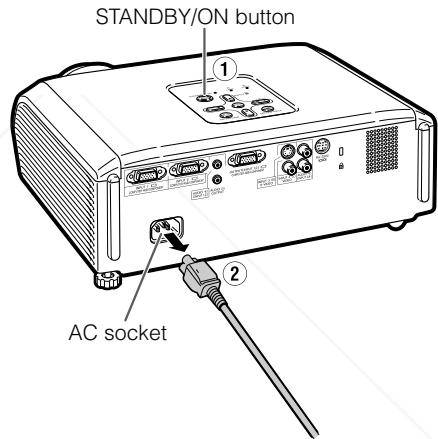

FixYourDIY.com
Discount-Merchant.com 1-800-368-281-8860
THE TRUSTED SOURCE FOR PROJECTOR LAMP AND ACCESSORIES

Regarding the Lamp (Continued)

4 Remove the lamp unit.

- Loosen the securing screws from the lamp unit. Hold the lamp unit by the handle and pull it in the direction of the arrow. At this time, keep the lamp unit horizontal and do not tilt it.

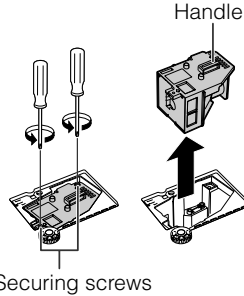

5 Insert the new lamp unit.

- Press the lamp unit firmly into the lamp unit compartment. Fasten the securing screws.

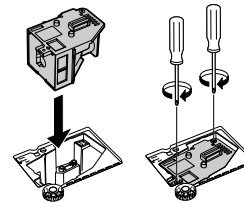

6 Replace the lamp unit cover.

- Align the tab on the lamp unit cover (1) and place it while pressing the tab (2) to close it. Then tighten the user service screw to secure the lamp unit cover.

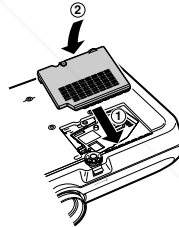

Info

- If the lamp unit and lamp unit cover are not correctly installed, the power will not turn on, even if the power cord is connected to the projector.

Resetting the Lamp Timer

Reset the lamp timer after replacing the lamp.

Info

- Make sure to reset the lamp timer only when replacing the lamp. If you reset the lamp timer and continue to use the same lamp, this may cause the lamp to become damaged or explode.

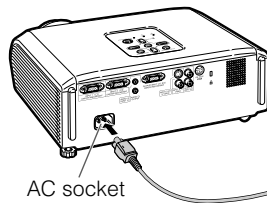

1 Connect the power cord.

- Plug the power cord into the AC socket of the projector.

2 Reset the lamp timer.

- While simultaneously holding down **MENU/HELP**, **ENTER** and **▼** on the projector, press **STANDBY/ON** on the projector.
- "LAMP 0000H" is displayed, indicating that the lamp timer is reset.

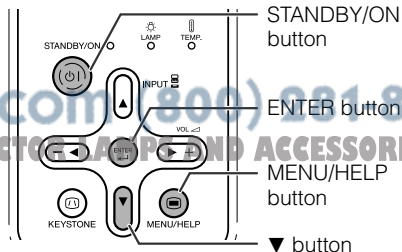

STANDBY/ON button

ENTER button

MENU/HELP button

▼ button

Connecting Pin Assignments

COMPUTER-RGB/COMPONENT INPUT1, 2 and COMPUTER-RGB/COMPONENT OUTPUT Terminals: 15-pin Mini D-sub female connector

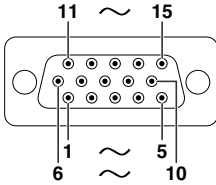

COMPUTER-RGB Input/Output

1. Video input (red)
2. Video input (green/sync on green)
3. Video input (blue)
4. Not connected
5. Not connected
6. Earth (red)
7. Earth (green/sync on green)
8. Earth (blue)
9. Not connected
10. GND
11. Not connected
12. Bi-directional data
13. Horizontal sync signal: TTL level
14. Vertical sync signal: TTL level
15. Data clock

Component Input/Output

1. PR (CR)
2. Y
3. PB (CB)
4. Not connected
5. Not connected
6. Earth (PR)
7. Earth (Y)
8. Earth (PB)
9. Not connected
10. Not connected
11. Not connected
12. Not connected
13. Not connected
14. Not connected
15. Not connected

RS-232C Terminal: 9-pin Mini DIN female connector

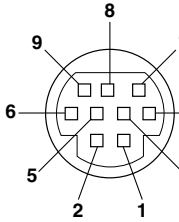

| Pin No. | Signal | Name | I/O | Reference |
|---------|--------|-----------------|--------|-------------------------------------|
| 1. | | | | Not connected |
| 2. | RD | Receive Data | Input | Connected to internal circuit |
| 3. | SD | Send Data | Output | Connected to internal circuit |
| 4. | | | | Not connected |
| 5. | SG | Signal Ground | | Connected to internal circuit |
| 6. | | | | Not connected |
| 7. | RS | Request to Send | | Connected to CS in internal circuit |
| 8. | CS | Clear to Send | | Connected to RS in internal circuit |
| 9. | | | | Not connected |

RS-232C Terminal: 9-pin D-sub male connector of the DIN-D-sub RS-232C adaptor (optional accessory: AN-A1RS)

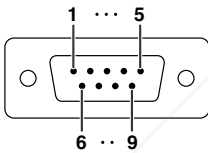

| Pin No. | Signal | Name | I/O | Reference |
|---------|--------|-----------------|--------|-------------------------------------|
| 1. | | | | Not connected |
| 2. | RD | Receive Data | Input | Connected to internal circuit |
| 3. | SD | Send Data | Output | Connected to internal circuit |
| 4. | | | | Not connected |
| 5. | SG | Signal Ground | | Connected to internal circuit |
| 6. | | | | Not connected |
| 7. | RS | Request to Send | | Connected to CS in internal circuit |
| 8. | CS | Clear to Send | | Connected to RS in internal circuit |
| 9. | | | | Not connected |

RS-232C Cable recommended connection: 9-pin D-sub female connector

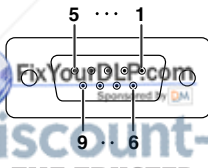

| Pin No. | Signal | Pin No. | Signal |
|---------|--------|---------|--------|
| 1. | CD | 1. | CD |
| 2. | RD | 2. | RD |
| 3. | SD | 3. | SD |
| 4. | ER | 4. | ER |
| 5. | SG | 5. | SG |
| 6. | DR | 6. | DR |
| 7. | RS | 7. | RS |
| 8. | CS | 8. | CS |
| 9. | CI | 9. | CI |

Note

- Depending on the controlling device used, it may be necessary to connect Pin 4 and Pin 6 on the controlling device (e.g. computer).

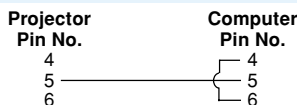

RS-232C Specifications and Command Settings

Computer control

A computer can be used to control the projector by connecting an RS-232C serial control cable (cross type, sold separately) to the projector. (See page 26 for connection.)

Communication conditions

Set the serial port settings of the computer to match that of the table.

Signal format: Conforms to RS-232C standard.

Parity bit: None

Baud rate: * 9,600 bps/115,200 bps

Stop bit: 1 bit

Data length: 8 bits

Flow control: None

* Set the projector's baud rate to the same rate as used by the computer.

Basic format

Commands from the computer are sent in the following order: command, parameter, and return code. After the projector processes the command from the computer, it sends a response code to the computer.

Command format

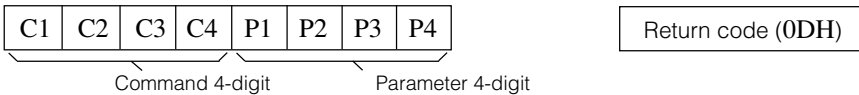

Response code format

Normal response

Problem response (communication error or incorrect command)



Info

- When controlling the projector using RS-232C commands from a computer, wait for at least 30 seconds after the power has been turned on, and then transmit the commands.
- When more than one code is being sent, send each command only after the response code for the previous command from the projector is verified.
- "POWER?????" "TABN ___ 1" "TLPS ___ 1" "TPOW ___ 1" "TLPN ___ 1" "TLTT ___ 1" "TLTL ___ 1" "TNAM ___ 1" "MNRD ___ 1" "PJN0 ___ 1"

When the projector receives a command shown above:

- * The on-screen display will not disappear.
- * The "Auto Power Off" timer will not be reset.



Note

- If an underline (_) appears in the parameter column, enter a space.
- If an asterisk (*) appears in the parameter column, enter a value in the range indicated in brackets under Control Contents.
- *1 For setting the projector name, send the commands in the order of PJN1, PJN2 and PJN3.
- *2 Parameters of CLR Temp settings are as follows.

| CLR temp | Parameter | CLR Temp | Parameter |
|----------|-----------|----------|-----------|
| 5500K | _0 5 5 | 8500K | _0 8 5 |
| 6500K | _0 6 5 | 9300K | _0 9 3 |
| 7500K | _0 7 5 | 10500K | _1 0 5 |

Commands

Example: When turning on the projector, make the following setting.
Computer

Projector

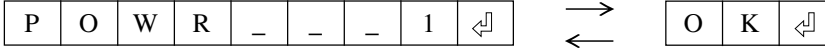

| CONTROL CONTENTS | COMMAND | PARAMETER | RETURN | |
|--|---------|-------------|--|--|
| | | | Power ON | Standby mode (or 40-second startup time) |
| Power Off | P O W R | - - - 0 | OK or ERR | OK |
| Power On | P O W R | - - - 1 | OK | OK or ERR |
| Power Status | P O W R | ? ? ? ? | 1 | 0 |
| Projector Condition | T A B N | - - - 1 | 0 : Normal, 1 : Temp High, 8 : Lamp Life 5% or less, 16 : Lamp Burnt-out, 32 : Lamp Ignition Failure | 0 : Normal, 1 : Temp High, 2 : Fan Error, 4 : Lamp Cover Open, 8 : Lamp Life 5% or less, 16 : Lamp Burnt-out, 32 : Lamp Ignition Failure, 64 : Temp Abnormally High |
| Lamp Status | T L P S | - - - 1 | 0 : Off, 1 : On, 2 : Retry, 3 : Waiting, 4 : Lamp Error | 0 : Off, 4 : Lamp Error |
| Lamp Power Status | T P O W | - - - 1 | 1 : On, 2 : Cooling, 3 : Shutting Down | 0 : Standby |
| Lamp Quantity | T L P N | - - - 1 | 1 | |
| Lamp Usage Time (Hour) | T L T T | - - - 1 | 0 – 9999 (Integer) | |
| Lamp Life (Percentage) | T L T L | - - - 1 | 0% – 100% (Integer) | |
| Model Name Check | T N A M | - - - 1 | XR10S / XR10X /XR20S / XR20X | |
| Model Name Check | M N R D | - - - 1 | XR-10S / XR-10X / XR-20S / XR-20X | |
| Projector Name Setting 1 (First four characters) *1 | P J N 1 | * * * * | OK or ERR | |
| Projector Name Setting 2 (Middle four characters) *1 | P J N 2 | * * * * | OK or ERR | |
| Projector Name Setting 3 (Last four characters) *1 | P J N 3 | * * * * | OK or ERR | |
| Projector Name Check | P J N 0 | - - - 1 | Projector Name | |
| INPUT 1 (RGB1) | I R G B | - - - 1 | OK or ERR | ERR |
| INPUT 2 (RGB2) | I R G B | - - - 2 | OK or ERR | ERR |
| INPUT RGB Check | I R G B | ? ? ? ? | 1 : RGB1 (INPUT1), 2 : RGB2 (INPUT2), ERR | ERR |
| INPUT 3 (Video1) | I V E D | - - - 1 | OK or ERR | ERR |
| INPUT 4 (Video2) | I V E D | - - - 2 | OK or ERR | ERR |
| INPUT Video Check | I V E D | ? ? ? ? | 1 : Video1 (INPUT3), 2 : Video2 (INPUT4), ERR | ERR |
| INPUT Mode Check | I M O D | ? ? ? ? | 1 : RGB, 2 : Video | ERR |
| INPUT Check | I C H K | ? ? ? ? | 1 : INPUT1, 2 : INPUT2, 3 : INPUT3, 4 : INPUT4 | ERR |
| INPUT 1 Adjustment Reset | R A R E | - - - 1 | OK or ERR | ERR |
| INPUT 2 Adjustment Reset | R B R E | - - - 1 | OK or ERR | ERR |
| INPUT 3 Adjustment Reset | V A R E | - - - 1 | OK or ERR | ERR |
| INPUT 4 Adjustment Reset | V B R E | - - - 1 | OK or ERR | ERR |
| All Reset | A L R E | - - - 1 | OK or ERR | ERR |
| Volume (0 – 60) | V O L A | - - - * | OK or ERR | ERR |
| Volume up / down (– 10 – +10) | V O U D | - - - * * * | OK or ERR | ERR |
| Keystone (– 127 – + 127 (XGA) / – 100 – + 100 (SVGA)) | K E Y S | - - - * * * | OK or ERR | ERR |
| AV Mute Off | I M B K | - - - 0 | OK or ERR | ERR |
| AV Mute On | I M B K | - - - 1 | OK or ERR | ERR |
| Freeze Off | F R E Z | - - - 0 | OK or ERR | ERR |
| Freeze On | F R E Z | - - - 1 | OK or ERR | ERR |
| Auto Sync Start | A D J S | - - - 1 | OK or ERR | ERR |
| INPUT 1 Resize : Normal | R A S R | - - - 1 | OK or ERR | ERR |
| INPUT 1 Resize : Stretch | R A S R | - - - 2 | OK or ERR | ERR |
| INPUT 1 Resize : Border | R A S R | - - - 6 | OK or ERR | ERR |
| INPUT 2 Resize : Normal | R B S R | - - - 1 | OK or ERR | ERR |
| INPUT 2 Resize : Stretch | R B S R | - - - 2 | OK or ERR | ERR |
| INPUT 2 Resize : Border | R B S R | - - - 6 | OK or ERR | ERR |
| INPUT 3 Resize : Normal | R A S V | - - - 1 | OK or ERR | ERR |
| INPUT 3 Resize : Stretch | R A S V | - - - 2 | OK or ERR | ERR |
| INPUT 3 Resize : Border | R A S V | - - - 3 | OK or ERR | ERR |
| INPUT 4 Resize : Normal | R B S V | - - - 1 | OK or ERR | ERR |
| INPUT 4 Resize : Stretch | R B S V | - - - 2 | OK or ERR | ERR |
| INPUT 4 Resize : Border | R B S V | - - - 3 | OK or ERR | ERR |
| INPUT 1 Picture Mode : Standard | R A P S | - - - 1 | OK or ERR | ERR |

RS-232C Specifications and Command Settings (Continued)

| CONTROL CONTENTS | COMMAND | PARAMETER | RETURN | |
|-------------------------------------|---------|-----------|-----------|---|
| | | | Power ON | Standby mode (or 40-second startup time) |
| INPUT 1 Picture Mode : Presentation | R A P S | 1 1 | OK or ERR | ERR |
| INPUT 1 Picture Mode : Movie | R A P S | 1 2 | OK or ERR | ERR |
| INPUT 1 Picture Mode : Game | R A P S | 1 3 | OK or ERR | ERR |
| INPUT 1 Picture Mode : sRGB | R A P S | 1 4 | OK or ERR | ERR |
| INPUT 1 Contrast (-30 - +30) | R A P I | * * * | OK or ERR | ERR |
| INPUT 1 Bright (-30 - +30) | R A B R | * * * | OK or ERR | ERR |
| INPUT 1 Color (-30 - +30) | R A C O | * * * | OK or ERR | ERR |
| INPUT 1 Tint (-30 - +30) | R A T I | * * * | OK or ERR | ERR |
| INPUT 1 Red (-30 - +30) | R A R D | * * * | OK or ERR | ERR |
| INPUT 1 Blue (-30 - +30) | R A B E | * * * | OK or ERR | ERR |
| INPUT 1 Sharp (-30 - +30) | R A S H | * * * | OK or ERR | ERR |
| INPUT 1 CLR Temp *2 | R A C T | * * * | OK or ERR | ERR |
| INPUT 1 Bright Boost (0 - 2) | R A W E | * * * | OK or ERR | ERR |
| INPUT 1 Progressive : 2D | R A I P | 0 | OK or ERR | ERR |
| INPUT 1 Progressive : 3D | R A I P | 1 | OK or ERR | ERR |
| INPUT 1 Progressive : Film Mode | R A I P | 2 | OK or ERR | ERR |
| INPUT 1 Signal Type : Auto | I A S I | 0 | OK or ERR | ERR |
| INPUT 1 Signal Type : RGB | I A S I | 1 | OK or ERR | ERR |
| INPUT 1 Signal Type : Component | I A S I | 2 | OK or ERR | ERR |
| INPUT 2 Picture Mode : Standard | R B P S | 1 0 | OK or ERR | ERR |
| INPUT 2 Picture Mode : Presentation | R B P S | 1 1 | OK or ERR | ERR |
| INPUT 2 Picture Mode : Movie | R B P S | 1 2 | OK or ERR | ERR |
| INPUT 2 Picture Mode : Game | R B P S | 1 3 | OK or ERR | ERR |
| INPUT 2 Picture Mode : sRGB | R B P S | 1 4 | OK or ERR | ERR |
| INPUT 2 Contrast (-30 - +30) | R B P I | * * * | OK or ERR | ERR |
| INPUT 2 Bright (-30 - +30) | R B B R | * * * | OK or ERR | ERR |
| INPUT 2 Color (-30 - +30) | R B C O | * * * | OK or ERR | ERR |
| INPUT 2 Tint (-30 - +30) | R B T I | * * * | OK or ERR | ERR |
| INPUT 2 Red (-30 - +30) | R B R D | * * * | OK or ERR | ERR |
| INPUT 2 Blue (-30 - +30) | R B B E | * * * | OK or ERR | ERR |
| INPUT 2 Sharp (-30 - +30) | R B S H | * * * | OK or ERR | ERR |
| INPUT 2 CLR Temp *2 | R B C T | * * * | OK or ERR | ERR |
| INPUT 2 Bright Boost (0 - 2) | R B W E | * * * | OK or ERR | ERR |
| INPUT 2 Progressive : 2D | R B I P | 0 | OK or ERR | ERR |
| INPUT 2 Progressive : 3D | R B I P | 1 | OK or ERR | ERR |
| INPUT 2 Progressive : Film Mode | R B I P | 2 | OK or ERR | ERR |
| INPUT 2 Signal Type : Auto | I B S I | 0 | OK or ERR | ERR |
| INPUT 2 Signal Type : RGB | I B S I | 1 | OK or ERR | ERR |
| INPUT 2 Signal Type : Component | I B S I | 2 | OK or ERR | ERR |
| INPUT 3 Picture Mode : Standard | V A P S | 1 0 | OK or ERR | ERR |
| INPUT 3 Picture Mode : Presentation | V A P S | 1 1 | OK or ERR | ERR |
| INPUT 3 Picture Mode : Movie | V A P S | 1 2 | OK or ERR | ERR |
| INPUT 3 Picture Mode : Game | V A P S | 1 3 | OK or ERR | ERR |
| INPUT 3 Contrast (-30 - +30) | V A P I | * * * | OK or ERR | ERR |
| INPUT 3 Bright (-30 - +30) | V A B R | * * * | OK or ERR | ERR |
| INPUT 3 Color (-30 - +30) | V A C O | * * * | OK or ERR | ERR |
| INPUT 3 Tint (-30 - +30) | V A T I | * * * | OK or ERR | ERR |
| INPUT 3 Red (-30 - +30) | V A S H | * * * | OK or ERR | ERR |
| INPUT 3 CLR Temp *2 | V A C T | * * * | OK or ERR | ERR |
| INPUT 3 Bright Boost (0 - 2) | V A W E | * * * | OK or ERR | ERR |
| INPUT 3 Progressive : 2D | V A I P | 0 | OK or ERR | ERR |
| INPUT 3 Progressive : 3D | V A I P | 1 | OK or ERR | ERR |
| INPUT 3 Progressive : Film Mode | V A I P | 2 | OK or ERR | ERR |
| INPUT 4 Picture Mode : Standard | V B P S | 1 0 | OK or ERR | ERR |
| INPUT 4 Picture Mode : Presentation | V B P S | 1 1 | OK or ERR | ERR |
| INPUT 4 Picture Mode : Movie | V B P S | 1 2 | OK or ERR | ERR |
| INPUT 4 Picture Mode : Game | V B P S | 1 3 | OK or ERR | ERR |
| INPUT 4 Contrast (-30 - +30) | V B P I | * * * | OK or ERR | ERR |
| INPUT 4 Bright (-30 - +30) | V B B R | * * * | OK or ERR | ERR |
| INPUT 4 Color (-30 - +30) | V B C O | * * * | OK or ERR | ERR |
| INPUT 4 Tint (-30 - +30) | V B T I | * * * | OK or ERR | ERR |

| CONTROL CONTENTS | COMMAND | PARAMETER | RETURN | |
|--------------------------------------|---------|-----------|-------------------------------------|---|
| | | | Power ON | Standby mode (or 40-second startup time) |
| INPUT 4 Sharp (-30 - +30) | V B S H | ... * * * | OK or ERR | ERR |
| INPUT 4 CLR Temp *2 | V B C T | ... * * * | OK or ERR | ERR |
| INPUT 4 Bright Boost (0 - 2) | V B W E | ... - - * | OK or ERR | ERR |
| INPUT 4 Progressive : 2D | V B I P | ... - - 0 | OK or ERR | ERR |
| INPUT 4 Progressive : 3D | V B I P | ... - - 1 | OK or ERR | ERR |
| INPUT 4 Progressive : Film Mode | V B I P | ... - - 2 | OK or ERR | ERR |
| Clock (-150 - +150) | I N C L | * * * * | OK or ERR | ERR |
| Phase (-30 - +30) | I N P H | * * * * | OK or ERR | ERR |
| H-Position (-150 - +150) | I A H P | * * * * | OK or ERR | ERR |
| V-Position (-60 - +60) | I A V P | * * * * | OK or ERR | ERR |
| Fine Sync Adjustment Reset | I A R E | - - - 1 | OK or ERR | ERR |
| Auto Sync : Off | A A D J | - - - 0 | OK or ERR | ERR |
| Auto Sync : On | A A D J | - - - 1 | OK or ERR | ERR |
| Internal Speaker : Off | A S P K | - - - 0 | OK or ERR | ERR |
| Internal Speaker : On | A S P K | - - - 1 | OK or ERR | ERR |
| Image Shift | L N D S | - * * * | OK or ERR | ERR |
| (-96 - +96 (XGA) / -75 - +75 (SVGA)) | | | | |
| OSD Display : Off | I M D I | - - - 0 | OK or ERR | ERR |
| OSD Display : On | I M D I | - - - 1 | OK or ERR | ERR |
| Video System Selection : AUTO | M E S Y | - - - 1 | OK or ERR | ERR |
| Video System Selection : PAL | M E S Y | - - - 2 | OK or ERR | ERR |
| Video System Selection : SECAM | M E S Y | - - - 3 | OK or ERR | ERR |
| Video System Selection : NTSC4.43 | M E S Y | - - - 4 | OK or ERR | ERR |
| Video System Selection : NTSC3.58 | M E S Y | - - - 5 | OK or ERR | ERR |
| Video System Selection : PAL_M | M E S Y | - - - 6 | OK or ERR | ERR |
| Video System Selection : PAL_N | M E S Y | - - - 7 | OK or ERR | ERR |
| Video System Selection : PAL-60 | M E S Y | - - - 8 | OK or ERR | ERR |
| Background Selection : Logo | I M B G | - - - 1 | OK or ERR | ERR |
| Background Selection : Blue | I M B G | - - - 3 | OK or ERR | ERR |
| Background Selection : None | I M B G | - - - 4 | OK or ERR | ERR |
| Lamp Setting : Bright | T H M D | - - - 0 | OK or ERR | ERR |
| Lamp Setting : Eco + Quiet | T H M D | - - - 1 | OK or ERR | ERR |
| Auto Search : Off | I N S E | - - - 0 | OK or ERR | ERR |
| Auto Search : On | I N S E | - - - 1 | OK or ERR | ERR |
| Auto Power Off : Off | A P O W | - - - 0 | OK or ERR | ERR |
| Auto Power Off : On | A P O W | - - - 1 | OK or ERR | ERR |
| Auto Keystone : Off (XR-20X only) | A T K S | - - - 0 | OK or ERR | ERR |
| Auto Keystone : On (XR-20X only) | A T K S | - - - 1 | OK or ERR | ERR |
| PRJ Mode : Reverse Off | I M R E | - - - 0 | OK or ERR | ERR |
| PRJ Mode : Reverse On | I M R E | - - - 1 | OK or ERR | ERR |
| PRJ Mode : Invert Off | I M I N | - - - 0 | OK or ERR | ERR |
| PRJ Mode : Invert On | I M I N | - - - 1 | OK or ERR | ERR |
| Language Selection : ENGLISH | M E L A | - - - 1 | OK or ERR | ERR |
| Language Selection : DEUTSCH | M E L A | - - - 2 | OK or ERR | ERR |
| Language Selection : ESPAÑOL | M E L A | - - - 3 | OK or ERR | ERR |
| Language Selection : NEDERLANDS | M E L A | - - - 4 | OK or ERR | ERR |
| Language Selection : FRANÇAIS | M E L A | - - - 5 | OK or ERR | ERR |
| Language Selection : ITALIANO | M E L A | - - - 6 | OK or ERR | ERR |
| Language Selection : SVENSKA | M E L A | - - - 7 | OK or ERR | ERR |
| Language Selection : 日本語 | M E L A | - - - 8 | OK or ERR | ERR |
| Language Selection : PORTUGUES | M E L A | - - - 9 | OK or ERR | ERR |
| Language Selection : 汉语 | M E L A | - - - 10 | OK or ERR | ERR |
| Language Selection : 한국어 | M E L A | - - - 11 | OK or ERR | ERR |
| Setup Guide : Off | S E G U | - - - 0 | OK or ERR | ERR |
| Setup Guide : On | S E G U | - - - 1 | OK or ERR | ERR |
| System Sound : Off | S S N D | - - - 0 | OK or ERR | ERR |
| System Sound : On | S S N D | - - - 1 | OK or ERR | ERR |
| RGB Horizontal Frequency Check | T F R Q | - - - 1 | x10 ¹ kHz (***.* or ERR) | ERR |
| RGB Vertical Frequency Check | T F R Q | - - - 2 | Hz (***.* or ERR) | ERR |
| Fan Mode : Normal | H L M D | - - - 0 | OK or ERR | ERR |
| Fan Mode : High | H L M D | - - - 1 | OK or ERR | ERR |

Computer Compatibility Chart

Computer

- Multiple signal support
Horizontal Frequency: 15-70 kHz,
Vertical Frequency: 45-85 Hz,
Pixel Clock: 12-108 MHz
Sync signal: Compatible with TTL level
- Compatible with sync on green signal
- Compatible with the signals below in intelligent compression
XR-20X/XR-10X: SXGA, SXGA+
XR-20S/XR-10S: XGA, SXGA, SXGA+
- Intelligent Compression and Expansion
System resizing technology

The following is a list of modes that conform to VESA. However, this projector supports other signals that are not VESA standards.

| PC/MAC | Resolution | Horizontal Frequency (kHz) | Vertical Frequency (Hz) | VESA Standard | Display | | | |
|---------|-------------|----------------------------|-------------------------|---------------|------------|-------------------------|-------------------------|---|
| | | | | | XR-20X/10X | XR-20S/10S | | |
| PC | VGA | 640 × 350 | 27.0 | 60 | | Upscale | Upscale | |
| | | | 31.5 | 70 | | | | |
| | | | 37.5 | 85 | ✓ | | | |
| | | 640 × 400 | 27.0 | 60 | | | | |
| | | | 31.5 | 70 | | | | |
| | | | 37.9 | 85 | ✓ | | | |
| | | 720 × 350 | 27.0 | 60 | | | | |
| | | | 31.5 | 70 | | | | |
| | | | 37.9 | 85 | ✓ | | | |
| | | 720 × 400 | 27.0 | 31.5 | 70 | | | |
| | | | | 37.9 | 85 | | | ✓ |
| | | | | 43.3 | 85 | | | ✓ |
| | 640 × 480 | | 26.2 | 50 | | | | |
| | | | 31.5 | 60 | ✓ | | | |
| | | | 34.7 | 70 | ✓ | | | |
| | SVGA | 800 × 600 | 37.9 | 72 | ✓ | | | |
| | | | 37.5 | 75 | ✓ | | | |
| | | | 43.3 | 85 | ✓ | | | |
| | | | 31.4 | 50 | | | | |
| | | | 35.1 | 56 | ✓ | | | |
| | | | 37.9 | 60 | ✓ | | | |
| | | | 46.6 | 70 | ✓ | | | |
| | | | 48.1 | 72 | ✓ | | | |
| | | | 46.9 | 75 | ✓ | | | |
| | | | 53.7 | 85 | ✓ | | | |
| | | | XGA | 1,024 × 768 | 40.3 | 50 | | |
| | | | | | 48.4 | 60 | ✓ | |
| | 56.5 | 70 | | | ✓ | | | |
| 60.0 | 75 | ✓ | | | | | | |
| 68.7 | 85 | ✓ | | | | | | |
| 55.0 | 60 | | | | | | | |
| SXGA | 1,152 × 864 | 66.2 | 70 | | | | | |
| | | 67.5 | 75 | ✓ | | | | |
| | | 64.0 | 60 | ✓ | | | | |
| | | 64.0 | 60 | | | | | |
| MAC 13" | VGA | 640 × 480 | 34.9 | 67 | | | | |
| MAC 16" | SVGA | 800 × 600 | 37.8 | 60 | | Upscale | Upscale | |
| | | 832 × 624 | 49.7 | 75 | | | True | |
| MAC 19" | XGA | 1,024 × 768 | 60.2 | 75 | | True | Intelligent Compression | |
| MAC 21" | SXGA | 1,152 × 870 | 68.7 | 75 | | Intelligent Compression | | |





Note

- When this projector receives 640 × 350 VESA format VGA signals, "640 × 400" appears on the screen.
- Optimum image quality will be achieved by matching your computer's output resolution to the projector's native resolution. (1024 × 768 for the XR-20X and XR-10X models OR 800 × 600 for the XR-20S and XR-10S models).

DTV

| Signal | Horizontal Frequency (kHz) | Vertical Frequency (Hz) |
|--------|----------------------------|-------------------------|
| 480I | 15.7 | 60 |
| 480P | 31.5 | 60 |
| 540P | 33.8 | 60 |
| 576I | 15.6 | 50 |
| 576P | 31.3 | 50 |
| 720P | 45.0 | 60 |
| 1035I | 28.1 | 50 |
| 1035I | 33.8 | 60 |
| 1080I | 28.1 | 50 |
| 1080I | 33.8 | 60 |

Troubleshooting

| Problem | Check | Page |
|--|--|----------|
|  No picture and no sound or projector does not start. | <ul style="list-style-type: none"> Projector power cord is not plugged into the wall outlet. | 26 |
| | <ul style="list-style-type: none"> Power to the external connected devices is off. | – |
| | <ul style="list-style-type: none"> The selected input mode is wrong. | 30 |
| | <ul style="list-style-type: none"> Cables incorrectly connected to the projector. | 23–26 |
| | <ul style="list-style-type: none"> Remote control battery has run out. | 14 |
|  Sound is heard but no picture appears (or picture is dark). | <ul style="list-style-type: none"> External output has not been set when connecting notebook computer. | 23 |
| | <ul style="list-style-type: none"> The lamp unit cover is not installed correctly. | 51, 52 |
| | <ul style="list-style-type: none"> Cables incorrectly connected to the projector. | 23–26 |
| | <ul style="list-style-type: none"> “Bright” is set to minimum position. | 40 |
| | <ul style="list-style-type: none"> Depending on the computer you are using, an image may not be projected unless the signal output setting of the computer is switched to the external output. Refer to the computer’s operation manual for how to switch its signal output settings. | – |
|  Color is faded or poor. | <ul style="list-style-type: none"> Image adjustments are incorrectly set. Make adjustments of “Color” and “Tint” in “Picture Mode” and lower the “Bright Boost” value. | 40 |
| | (Video Input only) <ul style="list-style-type: none"> Video input system is incorrectly set. | 46 |
|  Picture is blurred; noise appears. | <ul style="list-style-type: none"> Adjust the focus. | 28 |
| | <ul style="list-style-type: none"> The projection distance exceeds the focus range. | 20 |
|  Picture appears but no sound is heard. | (Computer Input only) <ul style="list-style-type: none"> Perform “Fine Sync” Adjustments (“Clock” Adjustment) Perform “Fine Sync” Adjustments (“Phase” Adjustment) | 46 46 |
| | <ul style="list-style-type: none"> Noise may appear depending on the computer. | – |
| | <ul style="list-style-type: none"> Cables incorrectly connected to the projector. | 23–26 |
| | <ul style="list-style-type: none"> Volume is set to minimum. When the projector is connected to an external device and the volume is set to minimum, the sound is not output even if you turn up the volume of the external device. | 30 |
| An unusual sound is occasionally heard from the cabinet. | <ul style="list-style-type: none"> “Speaker” is set to “Off”. | 43 |
| | <ul style="list-style-type: none"> If the picture is normal, the sound is due to cabinet shrinkage caused by room temperature changes. This will not affect operation or performance. | – |
| Maintenance indicator on the projector illuminates or blinks in red. | <ul style="list-style-type: none"> See “Maintenance Indicators”. | 49 |
| The projector cannot be turned on or put into the standby mode using the STANDBY/ON button on the projector. | <ul style="list-style-type: none"> The keylock is set. If the keylock is set to “ON”, all the buttons are locked. | 45 |

Troubleshooting (Continued)

| Problem | Check | Page |
|---|--|----------------------------|
| Picture is green on INPUT 1 (COMPONENT)/INPUT 2 (COMPONENT). | <ul style="list-style-type: none"> Change the input signal type setting. When you cannot select an input signal type, select "Color is faded or poor" in the "Help" menu, after selecting an item other than "sRGB" in "Picture Mode", and then select an input signal type. | 46 39, 46 |
| Picture is pink (no green) on INPUT 1 (RGB)/INPUT 2 (RGB). | | |
| Picture is too bright and whitish. | <ul style="list-style-type: none"> Image adjustments are incorrectly set. | 40 |
| The cooling fan becomes noisy. | <ul style="list-style-type: none"> When temperature inside the projector increases, the cooling fan runs faster. | – |
| The lamp does not light up even after the projector turns on. | <ul style="list-style-type: none"> The lamp indicator is illuminating in red. Replace the lamp. | 48, 51 |
| The lamp suddenly turns off during projection. | | |
| The image sometimes flickers. | <ul style="list-style-type: none"> Cables incorrectly connected to the projector or the connected equipment works improperly. Select "Vertical stripes or flickering image appear" in the "Help" menu and make the necessary adjustments. If this happens frequently, replace the lamp. | 23–26 |
| | | 46 |
| | | 51 |
| The lamp needs much time to turn on. | <ul style="list-style-type: none"> The lamp will eventually need to be changed. While the remaining lamp life draws to a close, replace the lamp. | 51 |
| Picture is dark. | | |

This unit is equipped with a microprocessor. Its performance could be adversely affected by incorrect operation or interference. If this should happen, unplug the Unit and plug it in again after more than 5 minutes.



Discount-Merchant.com (800) 281-8860
THE TRUSTED SOURCE FOR PROJECTOR LAMPS AND ACCESSORIES

For SHARP Assistance

If you encounter any problems during setup or operation of this projector, first refer to the “Troubleshooting” section on pages 59 and 60. If this operation manual does not answer your question, please contact the SHARP Service departments listed below.

| | | | |
|----------------------|--|--------------------|---|
| U.S.A. | Sharp Electronics Corporation 1-888-GO-SHARP (1-888-467-4277) lcdsupport@sharpsec.com http://www.sharp-usa.com | Benelux | SHARP Electronics Benelux BV 0900-SHARPCE (0900-7427723) Nederland 9900-0159 Belgium http://www.sharp.nl http://www.sharp.be http://www.sharp.lu |
| Canada | Sharp Electronics of Canada Ltd. (905) 568-7140 http://www.sharp.ca | Australia | Sharp Corporation of Australia Pty. Ltd. 1300-135-022 http://www.sharp.net.au |
| Mexico | Sharp Electronics Corporation Mexico Branch (525) 716-9000 http://www.sharp.com.mx | New Zealand | Sharp Corporation of New Zealand (09) 634-2059, (09) 636-6972 http://www.sharp.net.nz |
| Latin America | Sharp Electronics Corp. Latin American Group (305) 264-2277 www.servicio@sharpsec.com http://www.siempresharp.com | Singapore | Sharp-Roxy Sales (S) Pte. Ltd. 65-226-6556 ckng@srs.global.sharp.co.jp http://www.sharp.com.sg |
| Germany | Sharp Electronics (Europe) GMBH 01805-234675 http://www.sharp.de | Hong Kong | Sharp-Roxy (HK) Ltd. (852) 2410-2623 dcmktg@srh.global.sharp.co.jp http://www.sharp.com.hk |
| U.K. | Sharp Electronics (U.K.) Ltd. 08705 274 277 cic@sharp-uk.co.uk http://www.sharp.co.uk | Taiwan | Sharp Corporation (Taiwan) 0800-025111 http://www.sharp-scot.com.tw |
| Italy | Sharp Electronics (Italy) S.P.A. (39) 02-89595-1 http://www.sharp.it | Malaysia | Sharp-Roxy Sales & Service Co. (60) 3-5125678 |
| France | Sharp Electronics France 01 49 90 35 40 hotlinecd@sef.sharp-eu.com http://www.sharp.fr | U.A.E. | Sharp Middle East Fze 971-4-81-5311 helpdesk@smef.global.sharp.co.jp |
| Spain | Sharp Electronica Espana, S.A. 93 5819700 sharpplcd@sees.sharp-eu.com http://www.sharp.es | Thailand | Sharp Thebnakorn Co. Ltd. 02-236-0170 svc@stcl.global.sharp.co.jp http://www.sharp-th.com |
| Switzerland | Sharp Electronics (Schweiz) AG 0041 1 846 63 11 cattaneo@sez.sharp-eu.com http://www.sharp.ch | Korea | Sharp Electronics Incorporated of Korea (82) 2-3660-2002 lcd@sharp-korea.co.kr http://www.sharpkorea.co.kr |
| Sweden | Sharp Electronics (Nordic) AB (46) 8 6343600 vision.support@sen.sharp-eu.com http://www.sharp.se | India | Sharp Business Systems (India) Limited (91) 11 6431313 service@sharp-oa.com |
| Austria | Sharp Electronics (Europe) GMBH Branch Office Austria 0043 1 727 19 123 pogats@sea.sharp-eu.com http://www.sharp.at | | |



FixYourDLP.com
Sponsored by

Discount Sharp Client.com (800) 881-8860
THE TRUSTED SOURCE FOR PROJECTOR LAMP AND ACCESSORIES

Specifications

| | |
|---|--|
| Product type | Projector |
| Model | XR-20X/XR-20S/XR-10X/XR-10S |
| Video system | NTSC3.58/NTSC4.43/PAL/PAL-M/PAL-N/PAL-60/SECAM/DTV480I/DTV480P/ DTV540P/DTV576I/DTV576P/DTV720P/DTV1035I/DTV1080I/DTV1080I-50 |
| Display method | Single Chip Digital Micromirror Device™ (DMD™) by Texas Instruments |
| DMD panel | Panel size: [XR-20X/XR-10X] 0.55" (14 mm), 1chip XGA DMD [XR-20S/XR-10S] 0.55" (14 mm), 1chip SVGA DMD |
| No. of dots: | [XR-20X/XR-10X] 786,432 dots (1,024 [H] × 768 [V]) [XR-20S/XR-10S] 480,000 dots (800 [H] × 600 [V]) |
| Lens | 1–1.15 × zoom lens, F2.4–2.6, f = 19.0–21.9 mm |
| Projection lamp | 275 W DC lamp |
| Component input signal (INPUT1/2) | 15-pin mini D-sub connector Y: 1.0 Vp-p, sync negative, 75 Ω terminated P _B : 0.7 Vp-p, 75 Ω terminated P _R : 0.7 Vp-p, 75 Ω terminated |
| Horizontal resolution | [XR-20X/XR-10X] 600 TV lines (DTV720P) [XR-20S/XR-10S] 520 TV lines (DTV720P) |
| Computer RGB input (INPUT 1/2)/output (OUTPUT) signal | 15-pin mini D-sub connector RGB separate/sync on green type analog input: 0–0.7 Vp-p, positive, 75 Ω terminated HORIZONTAL SYNC. SIGNAL: TTL level (positive/negative) VERTICAL SYNC. SIGNAL: Same as above |
| S-video input signal (INPUT 3) | 4-pin mini DIN connector Y (luminance signal): 1.0 Vp-p, sync negative, 75 Ω terminated C (chrominance signal): Burst 0.286 Vp-p, 75 Ω terminated |
| Video input signal (INPUT 4) | RCA connector: VIDEO, composite video, 1.0 Vp-p, sync negative, 75 Ω terminated |
| Vertical frequency | 45–85 Hz |
| Horizontal frequency | 15–70 kHz |
| Pixel clock | 12–108 MHz |
| RS-232C terminal | 9-pin mini DIN connector |
| Audio input signal | ø3.5 mm minijack or RCA terminal: 0.5 Vrms, more than 22 kΩ (stereo) |
| Audio output signal (AUDIO OUTPUT 1-4) | ø3.5 mm minijack: 0.5 Vrms, less than 2.2 kΩ |
| Speaker system | 4 cm × 2.85 cm oval × 1 |
| Rated voltage | AC 100–240 V |
| Input current | 3.6 A |
| Rated frequency | 50/60 Hz |
| Power consumption | 350 W (Lamp Setting "Bright")/ 305 W (Lamp Setting "Eco + Quiet") with AC 100 V 330 W (Lamp Setting "Bright")/ 285 W (Lamp Setting "Eco + Quiet") with AC 240 V |
| Power consumption (standby) | 4 W (AC 100 V) – 5 W (AC 240 V) |
| Heat dissipation | 1,315 BTU/hour (Lamp Setting "Bright")/ 1,145 BTU/hour (Lamp Setting "Eco + Quiet") with AC 100 V 1,240 BTU/hour (Lamp Setting "Bright")/ 1,070 BTU/hour (Lamp Setting "Eco + Quiet") with AC 240 V |
| Operating temperature | 41°F to 95°F (+5°C to +35°C) |
| Storage temperature | –4°F to 140°F (–20°C to +60°C) |
| Cabinet | Plastic |
| I/R carrier frequency | 38 kHz |
| Dimensions (approx.) | 12 13/32" × 4 19/64" × 11 1/32" (315 (W) × 109 (H) × 280 (D) mm) (main body only) 12 13/32" × 4 47/64" × 11 37/64" (315 (W) × 120 (H) × 294 (D) mm) (including adjustment foot and projecting parts) |
| Weight (approx.) | 8.6 lbs. (3.9 kg) |
| Replacement parts | Remote control, Power cord for U.S. and Canada, etc., Power cord for Europe, except U.K., Power cord for U.K. and Singapore, Power cord for Australia, New Zealand and Oceania, RGB cable, Operation manual (Printed and CD-ROM) |

As a part of policy of continuous improvement, SHARP reserves the right to make design and specification changes for product improvement without prior notice. The performance specification figures indicated are nominal values of production units. There may be some deviations from these values in individual units.

Dimensions

Units: inches (mm)

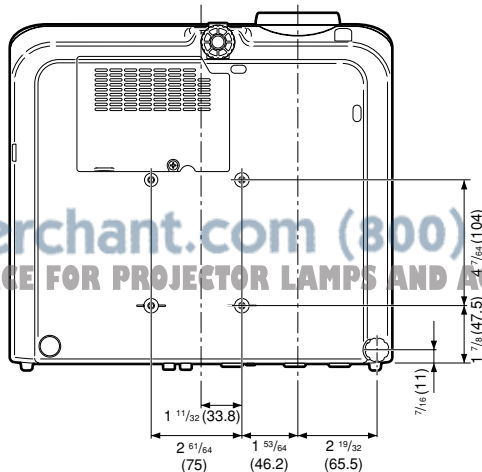
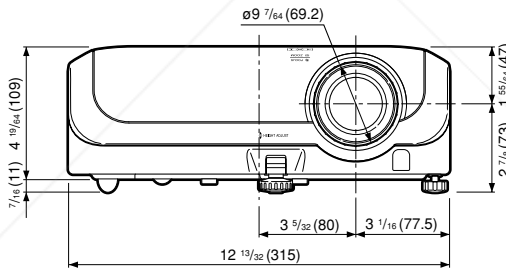
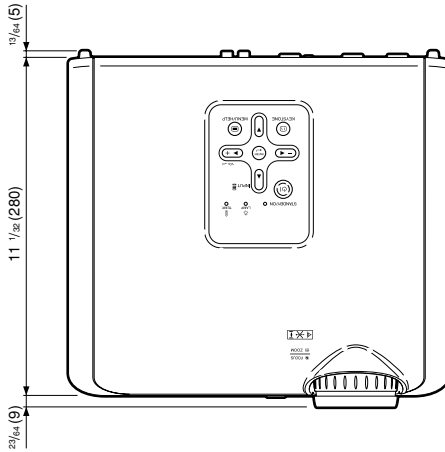

Discount-Merchant.com (800) 281-8860
THE TRUSTED SOURCE FOR PROJECTOR LAMPS AND ACCESSORIES

Index

| | | | |
|------------------------------------|----------------|---|--------|
| AC socket | 26 | Lamp | 10, 50 |
| Accessories | 10 | Lamp indicator | 48 |
| Adjustment buttons | 37 | Lamp Setting | 40 |
| Adjust horizontal noise | 36, 46 | Lamp Timer (Life) | 44 |
| Adjust vertical noise | 36, 46 | Lamp unit | 51 |
| Aspect ratio | 32 | Language (on-screen display language) | 42 |
| AUDIO INPUT terminal | 23, 24, 25 | Lens Cap | 11 |
| AUDIO OUTPUT terminal | 21 | MENU/HELP button | 37, 46 |
| Auto Keystone Correction | 41 | NORMAL | 32, 33 |
| Auto Power Off | 43 | ON button | 27 |
| Auto Search | 43 | Optional accessories | 10 |
| Auto Sync | | OSD Display | 42 |
| (Auto Sync adjustment) | 34, 36, 43, 46 | PDF | 9 |
| AUTO SYNC button | 34 | Phase | 46 |
| AV MUTE button | 30 | Picture Adjustment | 39 |
| BACK button | 13 | Picture Mode | 34, 39 |
| Background | 42 | PICTURE MODE button | 34 |
| Blue | 40 | Power cord | 26 |
| BORDER | 32, 33 | PRJ - ADJ | 43 |
| BREAK TIMER button | 34 | PRJ Mode | 19, 42 |
| Bright | 40 | Progressive | 40 |
| Bright Boost | 40 | R-6 batteries | 14 |
| Clock | 46 | Rear adjustment foot | 29 |
| CLR Temp (Color Temperature) | 40 | Red | 40 |
| Color | 40 | Remote control | 13 |
| Contrast | 40 | Remote control sensor | 15 |
| DIN-D-sub RS-232C adaptor | 26 | Replacing the lamp | 50, 51 |
| ENTER button | 37 | Resize | 32, 41 |
| Exhaust vent | 12, 47 | RESIZE button | 32 |
| Fan Mode | 44 | RETURN button | 37 |
| Fine Sync | 46 | RGB cable | 23 |
| Focus ring | 28 | OUTPUT (INPUT1, 2) terminal | 25 |
| FORWARD button | 13 | RS-232C terminal | 26 |
| FREEZE button | 34 | SCR - ADJ | 41 |
| Front adjustment foot | 29 | Screen Size and Projection Distance | 20 |
| H-Pos | 36, 46 | Setup Guide | 28, 42 |
| HEIGHT ADJUST lever | 29 | Sharp | 40 |
| Help | 46 | Speaker | 43 |
| Image shift | 41 | STANDBY button | 27 |
| INPUT 1 terminal | 23, 24, 25 | STANDBY/ON button | 27 |
| INPUT 1 - 4 modes | 30 | STRETCH | 32, 33 |
| INPUT 2 terminal | 23, 24, 25 | Supplied accessories | 10 |
| INPUT 3 terminal | 24 | System Lock | 44 |
| INPUT 4 terminal | 25 | System Sound | 43 |
| INPUT buttons | 30 | Temperature warning indicator | 48 |
| Intake vent | 11, 12, 47 | Tint | 40 |
| Kensington Security | | Video System | 36 |
| Standard connector | 12 | Volume buttons | 30 |
| Keystore | 44 | V-Pos | 36, 46 |
| Keylock | 45 | Zoom ring | 28 |
| KEystone button | 31 | | |
| Keystone Correction | 41 | | |

SHARP®

SHARP CORPORATION



Discount-Merchant.com (800) 281-8860
THE TRUSTED SOURCE FOR PROJECTOR LAMPS AND ACCESSORIES



Disclaimer

This user manual is provided as a free service by FixYourDLP.com. FixYourDLP is in no way responsible for the content of this manual, nor do we guarantee its accuracy. FixYourDLP does not make any claim of copyright and all copyrights remain the property of their respective owners.

About FixYourDLP.com

FixYourDLP.com (<http://www.fixyourdpl.com>) is the World's #1 resource for media product news, reviews, do-it-yourself guides, and manuals.

Informational Blog: <http://www.fixyourdpl.com>

Video Guides: <http://www.fixyourdpl.com/guides>

User Forums: <http://www.fixyourdpl.com/forum>

FixYourDLP's Fight Against Counterfeit Lamps:

<http://www.fixyourdpl.com/counterfeits>

Sponsors:

RecycleYourLamp.org – Free lamp recycling services for used lamps:

<http://www.recycleyourlamp.org>

Lamp Research - The trusted 3rd party lamp research company:

<http://www.lampresearch.com>

Discount-Merchant.com – The worlds largest lamp distributor:

<http://www.discount-merchant.com>



FixYourDLP.com

Sponsored by 