



Disclaimer

This user manual is provided as a free service by FixYourDLP.com. FixYourDLP is in no way responsible for the content of this manual, nor do we guarantee its accuracy. FixYourDLP does not make any claim of copyright and all copyrights remain the property of their respective owners.

About FixYourDLP.com

FixYourDLP.com (<http://www.fixyourdlp.com>) is the World's #1 resource for media product news, reviews, do-it-yourself guides, and manuals.

Informational Blog: <http://www.fixyourdlp.com>

Video Guides: <http://www.fixyourdlp.com/guides>

User Forums: <http://www.fixyourdlp.com/forum>

FixYourDLP's Fight Against Counterfeit Lamps:

<http://www.fixyourdlp.com/counterfeits>

Sponsors:

RecycleYourLamp.org – Free lamp recycling services for used lamps:

<http://www.recycleyourlamp.org>

Lamp Research - The trusted 3rd party lamp research company:

<http://www.lampresearch.com>

Discount-Merchant.com – The worlds largest lamp distributor:

<http://www.discount-merchant.com>



FixYourDLP.com

Sponsored by 

IN5300 (SERIES)



FixYourDLP.com
Sponsored by 

Discount-Merchant.com (800) 281-8860
THE TRUSTED SOURCE FOR PROJECTOR LAMPS AND ACCESSORIES



Regulatory models: F5300

InFocus

Bright Ideas Made Brilliant

Declaration of Conformity

Manufacturer: InFocus Corporation, 27500 SW Parkway Ave. Wilsonville, Oregon 97070 USA

We declare under our sole responsibility that this projector conforms to the following directives and norms:

EMC Directive 2004/108/EC

EuP Directive 2005/32/EC

EMC: EN 55022

EN 55024

EN 61000-3-2

EN 61000-3-3

Low Voltage Directive 2006/95/EC

Safety: IEC 60950-1:2005, MOD

Trademarks

DisplayLink is a trademark of DisplayLink Corporation. Apple, Macintosh, and PowerBook are trademarks or registered trademarks of Apple Computer, Inc. IBM is a trademark or registered trademark of International Business Machines, Inc. Microsoft, PowerPoint, and Windows are trademarks or registered trademarks of Microsoft Corporation. Adobe and Acrobat are trademarks or registered trademarks of Adobe Systems Incorporated. DLP® and the DLP logo are registered trademarks of Texas Instruments and BrilliantColor™ is a trademark of Texas Instruments. InFocus, In Focus, and INFOCUS (stylized) are either registered trademarks or trademarks of InFocus Corporation in the United States and other countries.

FCC Warning

This device complies with part 15 of the FCC Rules. Operation is subject to the following two conditions: (1) This device may not cause harmful interference, and (2) this device must accept any interference received, including interference that may cause undesired operation.

This equipment has been tested and found to comply with the limits for a Class B digital device, pursuant to part 15 of the FCC Rules. These limits are designed to provide reasonable protection against harmful interference in a residential installation. This equipment generates, uses and can radiate radio frequency energy and, if not installed and used in accordance with the instructions, may cause harmful interference to radio communications. However, there is no guarantee that interference will not occur in a particular installation. If this equipment does cause harmful interference to radio or television reception, which can be determined by turning the equipment off and on, the user is encouraged to try to correct the interference by one or more of the following measures:

--Reorient or relocate the receiving antenna.

--Increase the separation between the equipment and receiver.

--Connect the equipment into an outlet on a circuit different from that to which the receiver is connected.

--Consult the dealer or an experienced radio/TV technician for help.

Changes or modifications not expressly approved by InFocus Corporation may void authority to operate the equipment.

Canada

This Class B digital apparatus complies with Canadian ICES-003. Cet appareil numérique de la classe B est conforme à la norme NMB-003 du Canada.

Agency Approvals

UL, cUL

Other specific Country Approvals may apply. Please see product certification label.

This document applies to regulatory model M5300.

Input ratings: AC 100-240V, 4.8-1.7A, 50-60Hz

InFocus reserves the right to alter product offerings and specifications at any time without notice.

Table of Contents

Introduction	5
Positioning the projector	7
Ceiling Mount	8
Cable management	9
Connecting power	10
Connecting a computer source	10
Optional computer connections	11
Displaying an image	12
Adjusting the image	13
Connecting a video device	14
Video device connections	14
Shutting down the projector	16
Troubleshooting your setup	16
Using the remote control	24
Using the audio	25
Using the keypad buttons	26
Optimizing computer images	26
Presentation features	26
Optimizing video images	27
Customizing the projector	27
Dynamic Messaging	27
Using the menus	28
Basic Picture menu	29
Advanced Picture menu	30
Setup menu	31
Status and Service menu	34
Help	34
Using Network Functions	35
Using LitePort	40
Maintenance	43
Cleaning the lens	43
Replacing the projection lamp	44
Using the security lock	45
Appendix	46
SplitScreen Compatibility	47
RS232 Commands	47
Index	54



Discount-Merchant.com (800) 281-8860
THE TRUSTED SOURCE FOR PROJECTOR LAMPS AND ACCESSORIES

Important Operating Considerations for Safety

- Refer to this guide for proper startup and shutdown procedures.
- Follow all warnings and cautions in this manual and on the projector.
- Place the projector in a horizontal position no greater than 8 degrees off axis.
- Locate the projector at least 4' (1.2m) away from any heating or cooling vents.
- Do not block ventilation openings. Locate the projector in a well-ventilated area without obstructions to intake or exhaust vents. Do not place the projector on a tablecloth or other soft covering that may block the vents.
- Do not place the projector in direct sunlight, humid, greasy or dusty places or in places where the projector may come into contact with smoke or steam.
- Do not look directly into the lens while the projector is being used.
- Do not drop the projector.
- Do not spill liquid on the projector. Spilled liquid may damage the projector.
- Use the power cord provided. Connect the power cord to a receptacle with a protective safety (earth) ground terminal. A surge-protected power strip is recommended.
- Do not overload wall outlets.
- When disconnecting the power cord, hold the plug, not the cord.
- Wash hands after handling the cables supplied with this product.
- The projector remote control uses batteries. Make sure the batteries' polarity (+/-) is aligned correctly. Dispose of used batteries in accordance with local disposal laws.
- Use an InFocus approved ceiling mount kit for proper fitting, ventilation and installation. The warranty does not cover any damage caused by use of non-approved ceiling mount kits or by installing in an improper location.

- When the projector is ceiling mounted, wear protective eyewear to prevent eye injury before opening lamp door.
- The projector must be installed by a qualified professional in order to ensure proper operation and reduce the risk of hazards or injury. It is not recommended you install the projector yourself.
- Refer all service to qualified service personnel. Servicing your own projector can be dangerous to you and will void the warranty.
- Only use replacement parts specified by InFocus. Unauthorized substitutions may result in fire, electrical shock, or injury, and may void the warranty.
- Only genuine InFocus lamps are tested for use in this projector. Use of non InFocus lamps may cause electrical shock and fire, and may void the projector warranty.
- Hg – Lamp contains mercury. Manage in accordance with local disposal laws. See www.lamprecycle.org.
- The projector uses a high-pressure mercury glass lamp. The lamp may fail prematurely, or it may rupture with a popping sound if jolted, scratched, or handled while hot. The risk of lamp failure or rupture also increases as the lamp age increases; please replace the lamp when you see the "Replace Lamp" message.
- In the unlikely event of a lamp rupture, particles may exit through the projector vents. Keep people, food, and drinks out of the "keep out" area under and around the projector, as indicated by the "X" areas below.

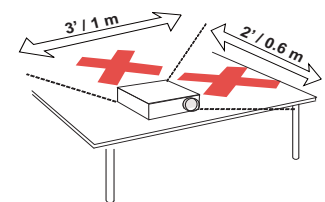
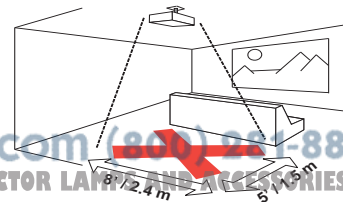

Follow these instructions to help ensure image quality and lamp life over the life of the projector. Failure to follow these instructions may affect the warranty. For complete details of the warranty, see the Warranty Booklet



Discount-Merchant.com (800) 281-8860
THE TRUSTED SOURCE FOR PROJECTOR LAMPS AND ACCESSORIES

Introduction

Your new digital projector is simple to connect, easy to use, and straightforward to maintain. It is a versatile projector that is flexible enough for business presentations and home video viewing, too. The IN5302 has native XGA 1024x768 resolution, and the IN5304 has WXGA 1280x800 resolution. This guide applies to both products. They are compatible with a wide variety of computers and video devices.

Product specifications

To read the latest specifications on your multimedia projector, be sure to visit our support website at www.infocus.com/support, as specifications are subject to change.

Online registration

Register your projector on our website at www.infocus.com/register to activate your warranty and receive product updates, announcements, and registration incentives.

Included Items



Optional Accessories

Optional accessories include optional top covers in a variety of finishes, the Commander-2 remote, ceiling mount, DisplayLink Extender, DisplayLink Wireless Adapter, and LiteShow II. These items and other accessories can be found on our website at www.infocus.com or at your local dealer.

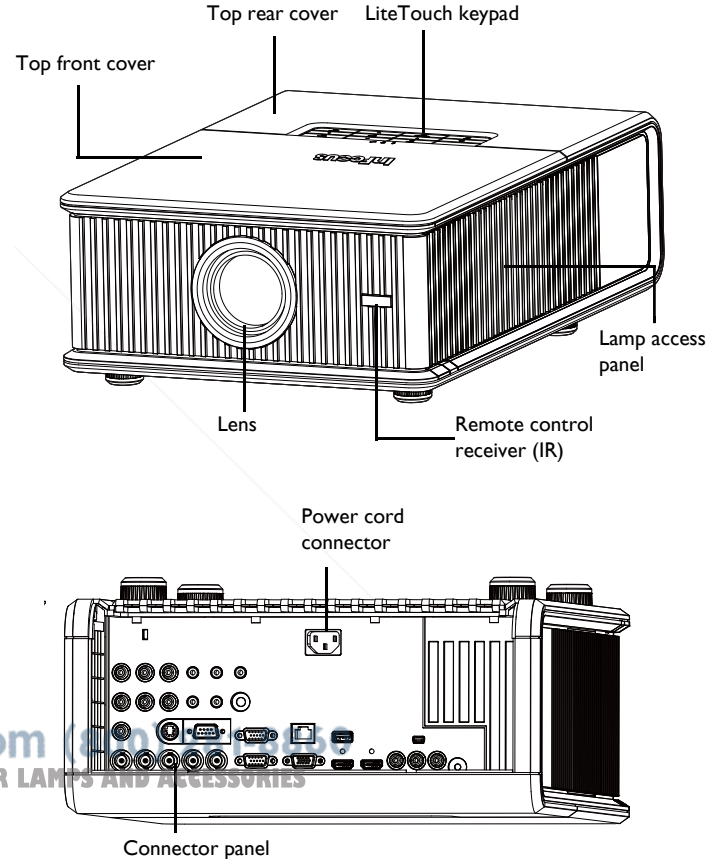

Connector panel

The projector provides both computer and video connection options, including:

- VGA computer (2)
- HDMI (2)
- S-video
- Composite video
- Component video
- BNC RGBHV and YPbPr for RGBHV, EDTV and HDTV
- Separate audio inputs for video and computer
- USB DisplayLink connector, for computer audio/video input. This USB connection also provides power out for the DisplayLink Wireless Adapter.

The projector also provides the following connectors:

- Monitor out, to provide an image on your desktop computer as well as on the projection screen.
- LAN port for network control and web server.
- LitePort, for connecting a USB flash drive containing JPEG images.
- Audio out, to provide sound for external speakers.
- 5 volt DC output
- 12V screen trigger output
- Wired remote jack (for use with optional Commander 2 remote)
- IR repeater jack
- RS-232 connector for serial control. Command control codes are in the Appendix and on our support web www.infocus.com/support.

NOTE: Only VGA video is sent to the **Monitor out** connector.

5 volt DC output

The coaxial 6.4mm x 2.2mm jack provides a constant 5 volt, 2 amp DC output when the projector is on, and will also provide power when the projector is in standby (powered off) if Network and DisplayLink items in

the Always-On Functions submenu are set to Yes. It is designed to provide power to an InFocus LiteShow II wireless device or InFocus DisplayLink Extender device.

12V Screen Trigger output

The 3.5mm mini-jack screen trigger provides a 12 volt, 0.25 amp DC output. It turns on when the lamp is lighted. If you connect your projection screen to this output using the cable that came with your screen, the screen will move down when the lamp is turned on and the screen will return to its storage position, when the lamp is turned off.

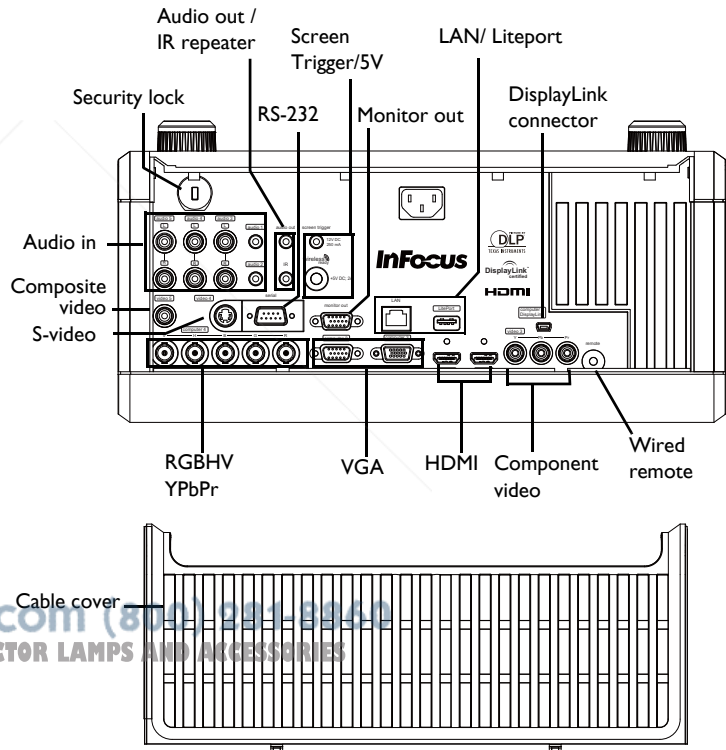

Positioning the projector

To determine where to position the projector, consider the size and shape of your screen, the location of your power outlets, and the distance between the projector and the rest of your equipment. Here are some general guidelines:

- Position the projector on a flat surface at a right angle to the screen. The projector must be at least 4.9' (1.5m) from the projection screen.
- Position the projector within 10' (3m) of your power source and within 6' (1.8m) of your video device (unless you purchase extension cables). To ensure adequate cable access, do not place the projector within 6" (.15m) of a wall or other object.
- Position the projector to the desired distance from the screen. The distance from the lens of the projector to the screen, the zoom setting, and the video format determine the size of the projected image.
- If the image is square but not centered on the screen or viewing area, adjust it by using the lens shift dials. Use the Horizontal dial to shift the lens left or right. Use the Vertical dial to shift the lens up or down.

NOTE: As the lens is shifted away from the lens centerline, the horizontal shift range is reduced. To adjust lens shift efficiently we suggest you follow these steps:

- 1 Use vertical lens shift to move the image closer to the lens centerline than the final vertical position.
- 2 Use horizontal lens shift to determine the center horizontal position, then move image to the center horizontal position.
- 3 Use vertical lens shift to move the image away from the lens centerline to the final vertical position.
- 4 Use horizontal lens shift to move the image to the final horizontal position.
- 5 If lens shift is unable to move the image far enough, move the projector (preferable) or tilt the projector and then use vertical and horizontal key-stone to re-position the image.

- The vertical image offset range is 105%~130% for the IN5302 and 105%~125% for the IN5304 (default for both is 105%). The default horizontal image offset is +/-15%, however at maximum vertical image offset, there is no horizontal lens shift.

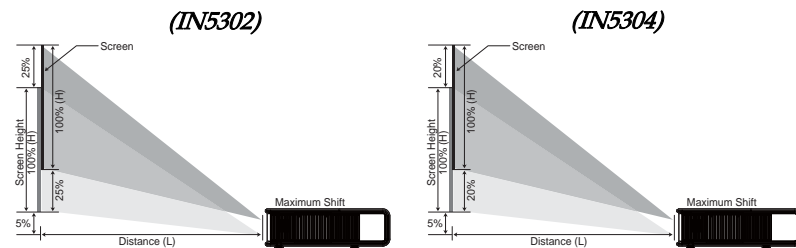

Horizontal Image Offset +/-15%

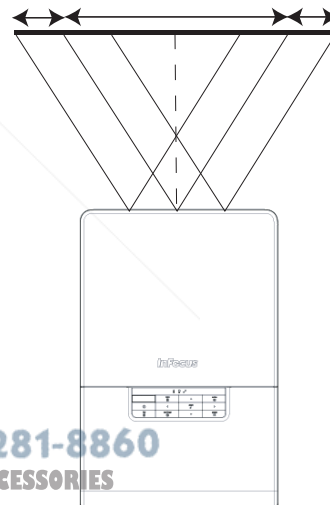

FixYourDLP.com
Sponsored by DLP

Discount-Merchant.com (800) 281-8860
THE TRUSTED SOURCE FOR PROJECTOR LAMPS AND ACCESSORIES

Table 1: IN5302 (XGA)

Range of distance to the screen for a given screen size

Diagonal Screen Size (inches/m)	Distance to screen	
	Minimum distance (feet/m)	Maximum Distance (feet/m)
60/1.524	6.43/1.96	10.63/3.24
80/2.032	8.63/2.63	14.21/4.33
90/2.286	9.71/2.96	16.01/4.88
150/3.810	16.34/4.98	26.77/8.16

Table 2: IN5304 (WXGA)

Range of distance to the screen for a given screen size

Diagonal Screen Size (inches/m)	Distance to screen	
	Minimum distance (feet/m)	Maximum Distance (feet/m)
60/1.524	6.66/2.03	10.20/3.11
80/2.032	8.92/2.72	13.71/4.18
90/2.286	10.07/3.07	15.45/4.71
150/3.810	16.93/5.16	25.85/7.88

Ceiling Mount

If you wish to install the projector on the ceiling:

- The projector must be installed by a qualified professional in order to ensure proper operation and reduce the risk of hazards or injury. It is not recommended you install the projector yourself.
- We strongly recommend using InFocus approved ceiling mounts for proper fitting, ventilation and installation. Refer to the installation guide that comes with the InFocus Ceiling Mount Kit (p/n SP-CEIL-INSTALL) for more information. The warranty does not cover any damage caused by use of non-approved ceiling mount kits or by installing in an improper location.
- The ceiling must be strong enough to support the projector and the installation must be in accordance with any local building codes. Consult your dealer for more information.
- Maximum supported physical pitch is +/-8°.
- Maximum supported physical horizontal roll is +/-8°.
- Keep all adjacent surfaces 3" (76mm) from sides, front and rear and .87" (22mm) from the bottom of projector to preserve required airflow around the projector.

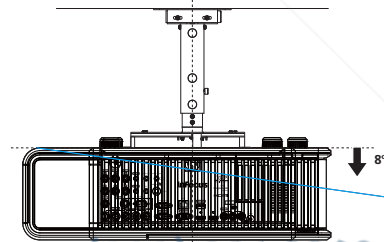

Discount-Merchant.com (800) 281-8860
THE TRUSTED SOURCE FOR PROJECTOR LAMPS AND ACCESSORIES

Cable management

The integrated cable management system allows you to keep the cables organized. To use the cable management system, thread the cables into the slots as shown in the illustration.

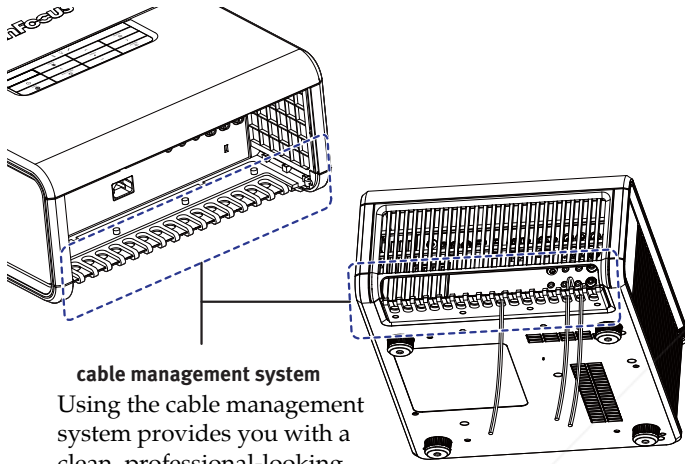

cable management system

Using the cable management system provides you with a clean, professional-looking installation.



Discount-Merchant.com (800) 281-8860
THE TRUSTED SOURCE FOR PROJECTOR LAMPS AND ACCESSORIES

Connecting power

Connect the black power cord to the **Power** connector on the rear of the projector and to your electrical outlet. The Power light on the Status Indicator Panel (page 16) turns amber.

NOTE: Always use the power cord that shipped with the projector.

Connecting a computer source

DisplayLink

If you have a Windows or Macintosh computer, connect the USB cable between your computer's USB port and the projector's **DisplayLink connector***. Then to begin installation of the DisplayLink software:

Windows: Follow the instructions on the screen.

Macintosh: A folder will open containing a file named DisplayLink Installer.pkg. Open that file and follow the instructions on the screen.

* For detailed DisplayLink instructions and troubleshooting, and to download the latest DisplayLink software, go to www.infocus.com/support/displaylink.

VGA connection

Connect one end of the provided computer cable to the **VGA 1** or **VGA 2** connector on the projector and the other to the VGA connector on your computer. If you are using a desktop computer, you will need to disconnect the monitor cable from the computer's video port first (you can connect this monitor cable to the **Monitor Out** connector on the projector, see next page).

HDMI 1.3 connection

HDMI is a standard, uncompressed, all-digital audio/video interface. HDMI provides an interface between sources, such as set-top boxes, DVD players, and receivers and your projector. Plug an HDMI cable into the video out connector on the video device and into either the **HDMI 1** or **HDMI 2** connector on the projector.

To take advantage of HDMI 1.3 Deep Color (30 bit) you must have a 1.3-compatible source.

RGBHV connection

Connect one end of the BNC cable to the computer and the other end of the cable into the BNC connectors on the projector.

Connect power cord

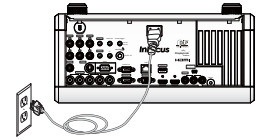

Connect USB cable

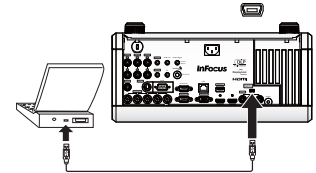

Connect computer cable

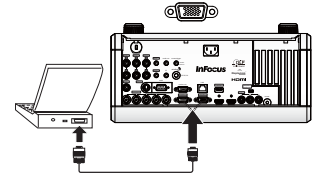

Optional computer connections

To get sound from the projector, connect an audio cable (optional cable, not included) to your computer and to the **Audio 1** (used with VGA 1) or **Audio 2** (used with VGA 2) connector on the projector. You can also assign a your source to a different audio in connector, see page 25 and page 32. You may also need an adapter.

If you are using a desktop computer and want to see the image on your computer screen as well as on the projection screen, connect the computer's monitor cable to the **Monitor Out** connector on the projector.

NOTE: Only VGA video is sent to the **Monitor out** connector.

To display a presentation from a USB flash drive, see the Using LitePort section on page 40. This feature converts presentations to JPEG images and eliminates the need for a computer source. It can also be integrated with common wall plates and conference room input/output panels.

To advance slides in a PowerPoint presentation using the remote control, plug the USB cable between the projector's DisplayLink connector and your computer. Then press the up and down arrow buttons on the remote control to move through your slides.

Connect monitor cable



Connect audio cable

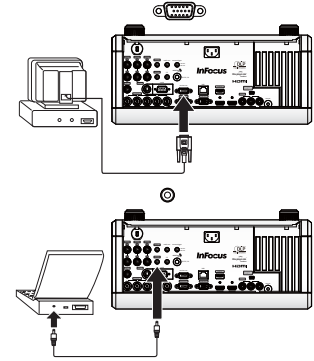

Discount-Merchant.com (800) 281-8860
THE TRUSTED SOURCE FOR PROJECTOR LAMPS AND ACCESSORIES

Displaying an image

Touch the **Power** button on the keypad or the remote.

The Power button blinks green and the fans start to run. When the lamp turns on, the start up screen will display and the Power button will become solid green. It can take a minute for the image to achieve full brightness.

No start up screen? Get help on page 17.

Turn on your computer or video device.

The image should appear on the projection screen. If it doesn't, press the **Source** button on the projector's keypad or remote.

If you are using a VGA cable to connect your computer to the projector (instead of DisplayLink):

If using a laptop, make sure its external video port is active.

Many laptops do not automatically turn on their external video port when a projector is connected. Usually a key combination like Fn + F8 or CRT/LCD key turns the external display on and off. Locate a function key labeled CRT/LCD or a function key with a monitor symbol. Press Fn and the labeled function key simultaneously.

Refer to your laptop's documentation for more information about your laptop's key combination or go to the InFocus website at: <http://www.infocus.com/Support/LaptopActivation.aspx>.

No laptop image? Try pressing the **Auto Image** button on the keypad or remote.

Is your laptop connected to the projector's DisplayLink connector? See the InFocus DisplayLink Software User's Guide (available on the InFocus website at www.infocus.com/displaylink) for troubleshooting information.

Press Power button

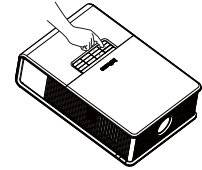

Turn on computer or video device

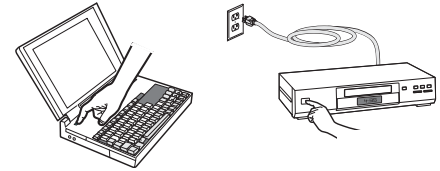

Activate laptop's external port



Monitor key or
LCD/CRT key

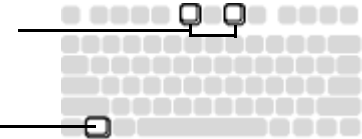

Fn key

Buy Your DLP from
DisplayLink-Merchant.com (800) 281-8860
THE TRUSTED SOURCE FOR PROJECTOR LAMPS AND ACCESSORIES

Adjusting the image

Position the projector to the desired distance from the screen at a 90 degree angle to the screen. See page 8 for a table listing of screen sizes and distances.

Remove the projector top cover

- Slide the tabs on the side toward the rear of the projector to unlock the projector top cover.
- Slide the top toward the front of the projector to unhook it from the projector body.
- Lift off.

Adjust the zoom or focus.

If the image is square but not centered on the screen or viewing area, adjust it by using the lens shift dials. See page 7 for details.

Rotate the elevator feet for granular adjustment of the projector's height. Avoid placing your hands near the hot exhaust vent at the side of the projector.

Adjust the Contrast or Brightness in the Basic Picture menu. See page 29 for help with these menu adjustments.

Adjust distance

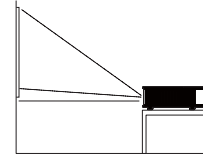

Remove cover

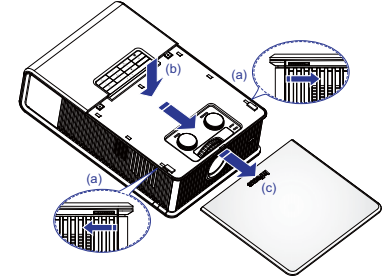

Adjust zoom, focus and lens shift

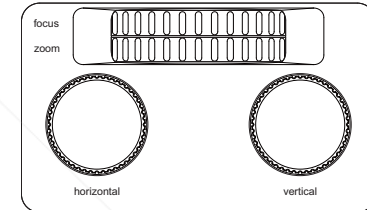

Adjust height

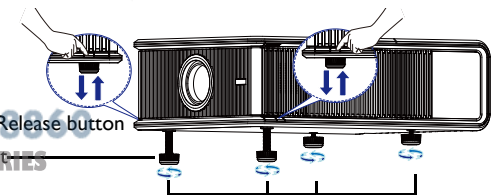

FixYourDLP.com

Discount-Merchant.com (800) 281-3666
THE TRUSTED SOURCE FOR PROJECTOR LAMPS AND ACCESSORIES

Connecting a video device

You can connect video devices such as VCRs, DVD players, camcorders, digital cameras, video game consoles, HDTV receivers, and TV tuners to the projector. You can connect the audio directly to the projector to get sound from the built-in speaker, or you can bypass the projector's audio system and connect the audio directly from your source to a stereo or home theater system.

You can connect the projector to most video devices that can output video. You cannot directly connect the coaxial cable that enters your house from a cable or satellite company; the signal must pass through a tuner first. Examples of tuners are digital cable boxes, VCRs, digital video recorders, and satellite TV boxes. Basically, any device that can change channels is considered a tuner.

Although the aspect ratio is automatically selected by the projector based on the signal input, you can change the aspect ratio, if desired. The projector's Aspect Ratio setting is accessed through the Resize button on the remote or through the projector's Basic Picture Menu. See page 29 for more information.

Video device connections

No video cables are provided with the projector. You can order cables from InFocus or use your own.

Composite video connection

Plug the composite video cable's yellow connector into the video out connector on the video device. Plug the other yellow connector into the yellow **Composite** connector on the projector.

Plug the white connector of a Mini-plug audio Y-cable into the left audio out connector on the video device and plug the red connector into the right audio out connector on the video device. Plug the other end of the cable into the associated audio in connector on the projector.

Keep in mind that video output from composite connections is not as high quality as S-video.

HDMI 1.3 connection

HDMI is a standard, uncompressed, all-digital audio/video interface. HDMI provides an interface between sources, such as set-top boxes, DVD players, and receivers and your projector. Plug an HDMI cable into the video out connector on the video device and into either the **HDMI 1** or **HDMI 2** connector on the projector.

To take advantage of HDMI 1.3 Deep Color (30 bit) you must have a 1.3-compatible source.

S-video connection

If your video device uses a round, four-prong S-video connector, plug an S-video cable into the S-video connector on your video device and into the **S-video** connector on the projector. Use the audio cable as described above.

Keep in mind that S-video delivers higher quality video output than composite.

VGA connection

If your video device has a 15-pin VGA output, plug one end of the included computer cable into the VGA connector on your video source. This connector may be labeled "To Monitor" on the video source. Plug the computer cable into the **VGA 1** or **VGA 2** connector on the projector.

Component video connection

Plug the component cable into the video device. Plug the other end of the component cable into the **Component** connectors (or if using BNC connectors, plug into the **YPbPr** connectors).

In addition, a Component to VGA adapter can be used in conjunction with the VGA connectors. Plug the component cable into the video device. Plug the other end of the component cable into the adapter and plug the adapter into the **VGA 1** or **VGA 2** connector.

Component offers the highest quality analog video output.

What is Aspect Ratio?

Aspect ratio is the ratio of the image width to image height. Standard TV screens and older laptops are 4:3; HDTV and most DVDs are 16:9; and widescreen computers are 16:10. If you are projecting onto a screen, the size/shape of the screen will influence the aspect ratio you decide to use. If you are projecting onto a blank wall, there are no screen size restrictions. What you plan to project will also help you choose between 4:3, 16:9 or 16:10. Many TV shows are 4:3, while most movies are 16:9.

If you have a 16:9 screen then you should select an aspect ratio of 16:9 for widescreen movies or HDTV, and Native for 4:3 content. If you have a 4:3 screen you should still use 16:9 for widescreen movies or HDTV, but you also have the option of using either 4:3 (to fill the screen) or Native (for direct pixel mapping) for 4:3 content. Force Wide can also be enabled to automatically resize less common aspect ratios to 16:10.

4:3 screen

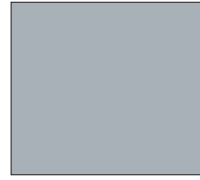

16:9 screen



4:3
mode



16:9
mode



Native
mode

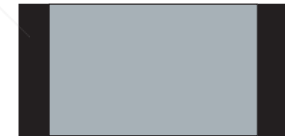

Discount-Merchant.com (800) 281-8860
THE TRUSTED SOURCE FOR PROJECTOR LAMPS AND ACCESSORIES

Shutting down the projector

Screen Save Time

You can make the black screen appear after a preset number of minutes by turning on the Screen Save Time feature in the Setup menu. See page 31.

Auto Off Time

The projector has an Auto Off Time feature that automatically turns the projector off if no active sources are detected and no user interaction with the projector is performed for 30 minutes. By default, this feature is off. You can change the length of time, see page 31.

Turning off the projector

To turn the projector off, press the **Power** button on the remote or keypad. The lamp turns off and the LED blinks amber for 10 seconds while the fans continue to run to cool the lamp. When the lamp has cooled, the LED lights amber and the fans stop. Unplug the power cable to completely power off the projector.

Troubleshooting your setup

The Status Indicator Panel on top of the projector indicates the state of the projector and is a helpful when troubleshooting.

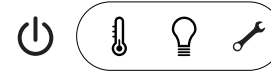



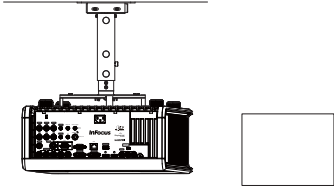
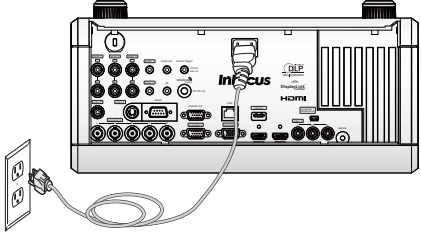
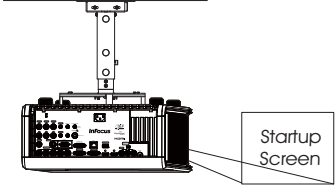
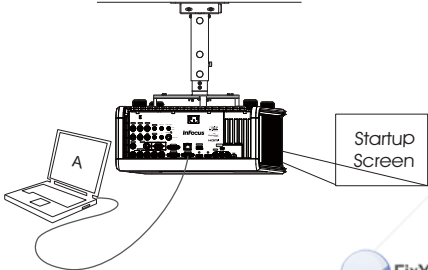

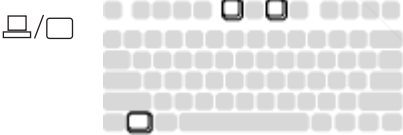

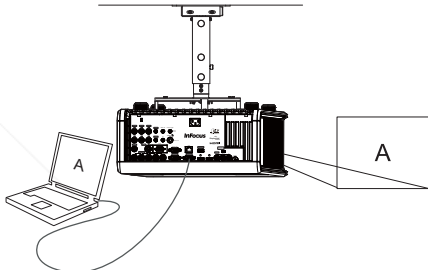

Table 3: Status indicator light behavior and meaning

Icon	Meaning
Power, solid amber 	The projector is plugged in.
Power, blinking green	The power button has been pressed and the software is initializing.
Power, solid green	The projector is on and initialized.
Power, blinking amber	The power button has been pressed to turn the projector off and the fans are running to cool the projector.
Temperature 	The projector is too hot. Make sure the vents aren't blocked (see page 22). Turn the projector off and wait one minute, then turn the projector on again. Contact Technical Support if the problem persists. Visit www.infocus.com/support to contact service.
Lamp 	Turn the projector off and wait one minute, then turn the projector on again. If the lamp light turns on again, replace the lamp and reset the lamp timer (page 45).
Wrench/Service 	Turn the projector off and wait one minute, then turn the projector on again. If the service lamp turns on again, service is required. Visit www.infocus.com/support to contact service.





Discount-Merchant.com (800) 281-8860
 THE TRUSTED SOURCE FOR PROJECTOR LAMPS AND ACCESSORIES

Problem	Solution	Result
<p data-bbox="48 127 244 152">No start up screen</p> 	<p data-bbox="661 127 1065 156">Plug power cord into the projector then</p>  <p data-bbox="661 448 862 474">press power button</p>	<p data-bbox="1182 127 1333 152">Correct image</p> 
<p data-bbox="48 500 340 525">Only start up screen appears</p> 	<p data-bbox="661 489 1156 555">If your computer is using the projector's DisplayLink connector, see the DisplayLink Software User's Guide for troubleshooting information.</p> <p data-bbox="661 578 987 626">Press the Source button  Activate the laptop's external port</p>  <p data-bbox="670 835 808 860">Restart laptop</p> 	<p data-bbox="1182 494 1459 520">Computer image projected</p> 

FixYourDLP.com
Sponsored by

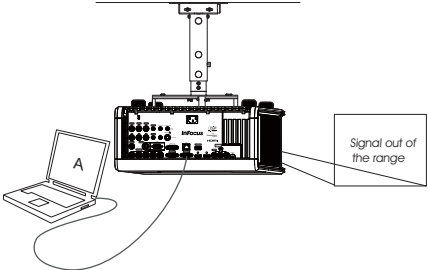
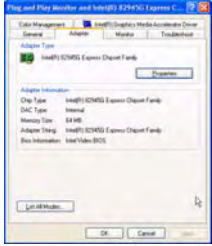
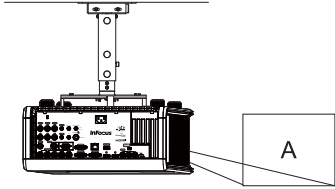
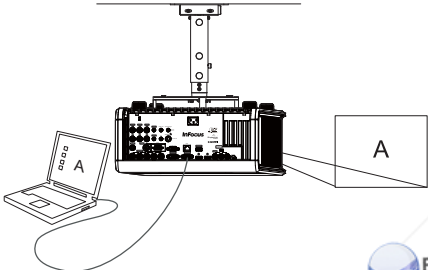

Discount-Merchant.com (800) 281-8860

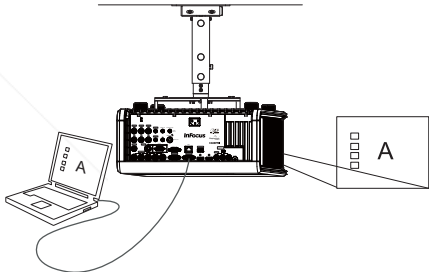
THE TRUSTED SOURCE FOR PROJECTOR LAMPS AND ACCESSORIES

Problem	Solution	Result
<p>No computer image, just the words “Signal out of range”</p> 	<p>Press the Auto Image button on the keypad or remote. To adjust computer refresh rate, go to Control Panel > Display > Settings > Advanced > Adapter (location varies by operating system).</p>  <p>You may also need to set a different resolution on your computer, as shown in the following problem, “image fuzzy or cropped”</p>	<p>Computer image projected</p> 
<p>Only my laptop’s background appears, not the Desktop icons</p> 	<p>DisplayLink - Use DisplayLink software to change the display mode from Extended Desktop to Duplicated Desktop. Windows - Disable “Extend my Windows Desktop” in Control Panel > Display > Settings > Display 2 (location varies by operating system)</p>  <p>Uncheck this option, then click Apply</p>	<p>Background and Desktop projected</p> 

FixYourDLP.com
Sponsored by

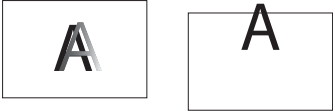
Discount Merchant (800) 281-8860
THE TRUSTED SOURCE FOR PROJECTOR PARTS AND ACCESSORIES

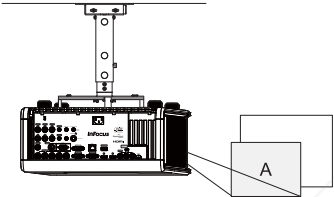
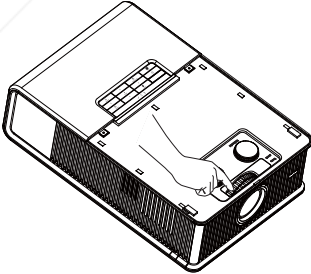
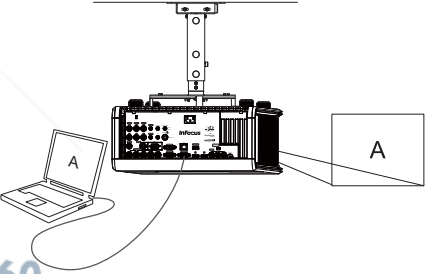
Problem	Solution	Result
<p data-bbox="48 89 284 115">Image fuzzy or cropped</p> 	<p data-bbox="604 89 1142 173">Set your computer's display resolution to the native resolution of the projector (Start > Settings > Control Panel > Display > Settings tab)</p>  <p data-bbox="656 313 817 445">For a laptop, disable laptop monitor or turn-on dual-display mode</p>	<p data-bbox="1182 89 1465 115">Image clear and not cropped</p> 
<p data-bbox="48 540 348 567">Image not centered on screen</p> 	<p data-bbox="604 540 1025 567">Move projector, adjust zoom and lens shift</p> 	<p data-bbox="1182 540 1326 567">Correct image</p> 

FixYourDLP.com
Sponsored by

Discount-Merchant.com (800) 281-8860
THE TRUSTED SOURCE FOR PROJECTOR LAMPS AND ACCESSORIES

Problem	Solution	Result
<p>Image not square</p> 	<p>Adjust Keystone in the Basic Picture menu</p> 	<p>Square image</p> 
<p>Image not sharp</p> 	<p>Adjust Sharpness in the Basic Picture menu</p> 	<p>Correct image</p> 
<p>Image does not fit 4:3 or 16:9 screen</p> 	<p>Change aspect ratio to 4:3 or 16:9 in Basic Picture>Aspect Ratio menu</p> 	<p>Correct image</p> 

Problem	Solution	Result
<p>Image upside down</p> 	<p>Turn off Ceiling Mount in Setup menu</p> 	<p>Correct image</p> 
<p>Image reversed left to right</p> 	<p>Turn off Rear Project in Setup menu</p> 	<p>Correct image</p> 
<p>Projected colors don't match source</p> 	<p>Adjust color, tint, brightness, contrast in the Basic Picture menu and/or color space in the Advanced Picture menu</p> 	<p>Correct image</p> 

FixYourDLP.com
Sponsored by DM

Discount-Merchant.com (800) 281-8860
THE TRUSTED SOURCE FOR PROJECTOR LAMPS AND ACCESSORIES

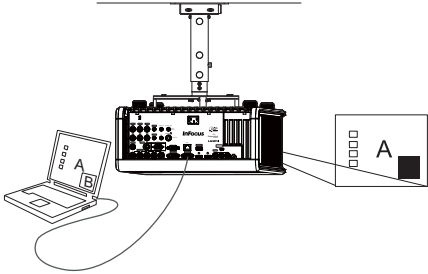
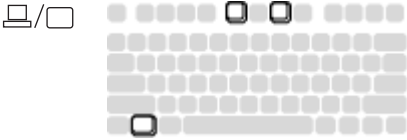
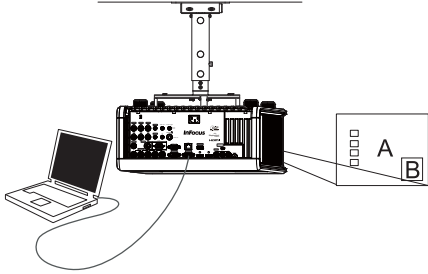
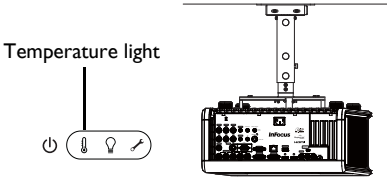
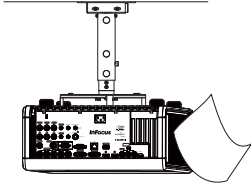
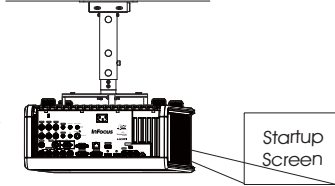
Problem	Solution	Result
<p>The video embedded in my PowerPoint presentation does not play on the screen</p> 	<p>If your computer is using the projector's DisplayLink connector, see the DisplayLink Software User's Guide for video troubleshooting information. Turn off the internal LCD display on your laptop</p> 	<p>Embedded video plays correctly</p> 
<p>Lamp won't turn on, Temperature light is on</p> 	<p>Make sure vents aren't blocked, turn the projector off and allow it to cool for one minute.</p> 	<p>Lamp turns on</p> 

FixYourDLP.com
Sponsored by

Discount-Merchant.com (800) 281-8860
THE TRUSTED SOURCE FOR PROJECTOR LAMPS AND ACCESSORIES

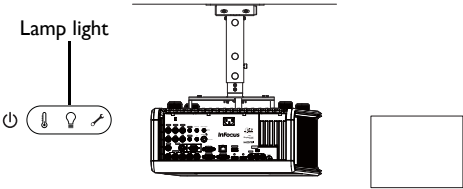
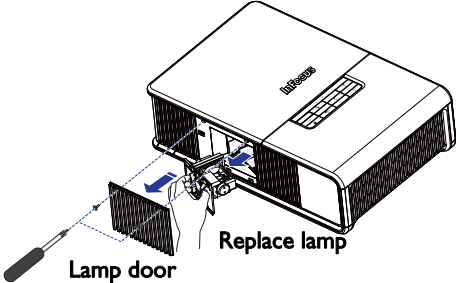
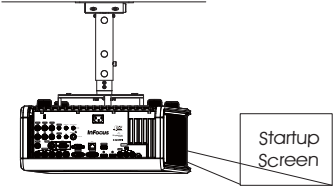
Problem	Solution	Result
<p data-bbox="48 101 531 156">“Replace lamp” message appears at startup, lamp won’t turn on, Lamp light is turned on</p> 	<p data-bbox="604 112 968 138">Lamp must be replaced (see page 44)</p> 	<p data-bbox="1180 92 1326 119">Lamp turns on</p> 

Still need assistance?

If you need assistance, visit our support website at www.infocus.com/support or call us. Check out the How To section for additional information on using this projector for home theater or gaming applications.

This product is backed by a limited warranty. An extended warranty plan may be purchased from your dealer. When sending the projector in for repair, we recommend shipping the unit in its original packing material, or having a professional packaging company pack the unit. Please insure your shipment for its full value.



Discount-Merchant.com (800) 281-8860
THE TRUSTED SOURCE FOR PROJECTOR LAMPS AND ACCESSORIES

Using the remote control

The remote uses two (2) provided AA batteries. You can install the batteries by removing the cover from the remote's back, aligning the + and - ends of the batteries, sliding them into place, and then replacing the cover.

Caution:

- When replacing the batteries, be aware that using batteries other than the type provided with the projector may risk severe damage to the remote. When disposing of the batteries, be sure to do so in an environmentally proper manner.
- If the remote control gets wet, wipe it dry immediately.
- Avoid excessive heat and humidity.
- Ensure the batteries' polarity (+/-) is aligned correctly.
- Do not mix new and old batteries together, or different types of batteries together.
- Replace the batteries as soon as they run out.
- Remove batteries from the remote control when storing or not in use for a prolonged period.

To operate, point the remote at the front of the projector (not at the computer). The range of optimum operation is about 30' (9m).

Press the remote's **Power** button to turn the projector on and off (see page 16 for shutdown information).

Press the remote's **Menu** button to open the projector's menu system. Use the arrow buttons to navigate, and the **Select** button to select features and adjust values in the menus. See page 28 for more information on the menus.

The remote also has:

- **Source** button to switch between sources
- **Volume** buttons to adjust the sound.
- **Custom** button that can be assigned to a special function, like Blank Screen or Freeze (see page 31).
- **Help** button to access the projector's help feature (see page 34).
- **Blank** button to blank the screen.

- **Presets** button to select stored settings (see page 29).
- **Mute** button to silence the audio.
- **Auto Image** button to resynchronize the projector to the source.
- **Resize** button to switch among aspect ratios (see page 29).

Wired Remote Option

If the wireless range of the standard remote is not sufficient, an optional Commander-2 remote can be wired directly into the projector's Wired Remote connector.

Troubleshooting the remote

- Make sure the batteries are installed in the proper orientation and are not dead.
- Make sure you're pointing the remote at the projector or the screen, not the computer, and are within the remote range of 30' (9m). For best results, point the remote at the projector.

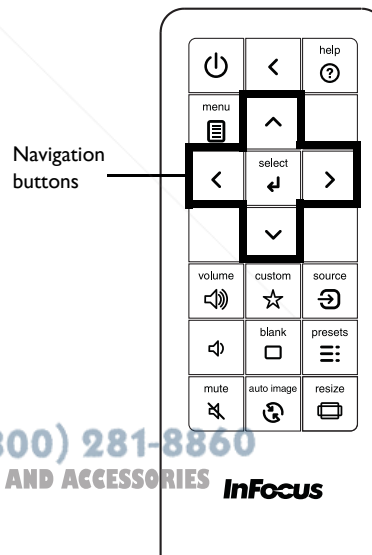

Using the audio

Using the projector's speakers

When the computer is using the DisplayLink or HDMI connectors, both audio and video are sent over the respective cable to the projector and audio will play from the projector's speakers.

For inputs other than DisplayLink and HDMI, connect the audio source to the associated audio connectors in order to use the projector's speakers.

To adjust the volume, press the **Volume** buttons on the keypad or remote.

Troubleshooting Audio

If you aren't hearing the audio, check the following:

- If your computer is using the projector's DisplayLink connector, see the InFocus DisplayLink Software User's Guide on the website at www.infocus.com/displaylink for audio troubleshooting information.
- Make sure the audio cable is connected to the correct audio in connector, Computer or Video.
- Make sure the volume is turned up enough. Press the **Volume** button on the keypad or remote.
- Make sure you are connected to the corresponding audio in for your source. By default, **Audio 1** corresponds to **VGA 1**, **Audio 2** corresponds to **VGA 2**, **Audio 3** corresponds to **Component**, **Audio 4** corresponds to **S-video** and **Composite**, and **Audio 5** corresponds to **RGBHV/YPbPr**. You can change these assignments, see page 32.
- Make sure that you are connected to an audio out connector on the source as opposed to a line in or microphone connector.
- Adjust the audio source.
- If playing a video, make sure the playback has not been paused.

Connecting external speakers

The projector can be attached to external amplified speakers by connecting a 3.5mm stereo audio cable from the **Audio Out** connector on the projector to the amplified speakers. Alternatively, you can bypass the projector's audio

system and connect the audio directly from your source to a stereo or home theater system.

NOTE: DisplayLink and HDMI audio are passed to the Audio Out connector.

Connect audio cable

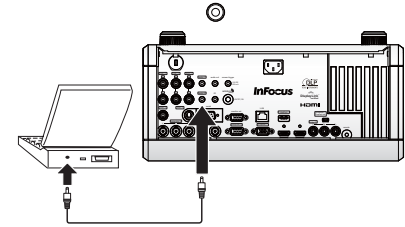

Adjust volume

volume

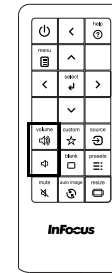

External speakers with own power source

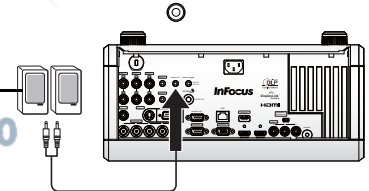

Speaker cable



Discount-Merchant.com (800) 281-8860

THE TRUSTED SOURCE FOR PROJECTOR LAMPS AND ACCESSORIES

Using the keypad buttons

Most buttons are described in detail in other sections, but here is an overview of their functions:

Power—turns the projector on and off (page 10).

Auto Image—resynchronize the projector to the source.

Presets—cycles through the available preset settings (page 29).

Menu—opens the onscreen menus (page 28).

Select—confirms choices made in the menus (page 28).

Up/Down/Left/Right arrows—navigates to and adjusts settings in the menus (page 28).

Source—changes the active source (page 10).

Help—button to access the projector's help feature (page 34)

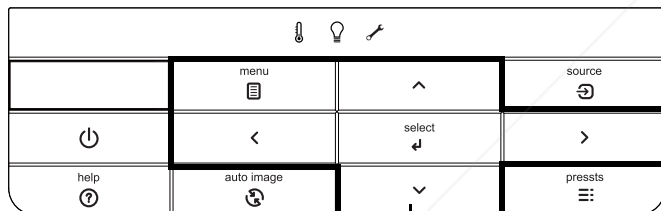

Menu navigation

by
FixYourDLP.com
Sponsored by

Discount-Merchant.com
THE TRUSTED SOURCE FOR PROJECTOR LAMP AND ACCESSORIES

Optimizing computer images

After the projector is running and the image is on the screen, you can optimize the image using the onscreen menus. For general information on using the menus, see page 28.

- Adjust the Keystone, Contrast, or Brightness in the Basic Picture menu (page 29).
- Change the Aspect Ratio. Choose the option that best fits your input source (page 29).
- Adjust the Color Temperature in the Advanced Picture menu (page 30).
- Adjust the Phase, Tracking, or Horizontal or Vertical position in the Advanced Picture menu (page 30).
- Once you have optimized the image for a particular source, you can save the settings using Presets. This allows you to quickly recall these settings later (page 29).
- If your computer is using the projector's DisplayLink connector, see the InFocus DisplayLink Software User's Guide for information about optimizing images.

Presentation features

Several features are provided to make giving presentations easier. Here is an overview, details are found in the menu section.

- The Custom key allows you to assign various features to the button. The default effect is Source Info, which displays information about the projector and current source. See page 31 for details.
- The Search Screen option lets you change the appearance of the blank screen and start up screen (page 32).
- Two options, Auto Off and Screen Save Time, are provided to automatically shut down the projector after several minutes of inactivity or to display a black screen. This helps preserve lamp life (page 31).

Optimizing video images

After your video device is connected properly and the image is on the screen, you can optimize the image using the onscreen menus. For general information on using the menus, see page 28.

- Adjust the Keystone, Contrast, Brightness, Color, Tint or Sharpness in the Basic Picture menu (page 29).
- Change the Aspect Ratio. Choose the option that best fits your input source (page 29).
- Adjust the Color Temperature. Select a listed warmth value (page 30).
- Turn on Overscan to remove noise on the edges of the image (page 30).

Customizing the projector

You can customize the projector for your specific setup and needs. See page 31 to page 32 for details on these features.

- For rear projection, turn Rear Project on in the **Setup** menu.
- For ceiling mounted projection, turn Ceiling Mount on in the **Setup** menu.
- Specify which source the projector checks first for active video during power-up.
- Specify the function of the Custom key on the remote.
- Turn the projector's display messages on and off.
- Turn on power saving features.
- Specify appearance of blank screen and startup screen.
- Specify the language viewed on the menus.

Dynamic Messaging

Using command codes, text messages can be sent for display by the projector (and all other InFocus projectors with the Dynamic Messaging feature) over a network or serial connection. Text is shown on top of whatever else is being displayed, and can be shown in ticker tape format or in a box, with optional beep tone alert. This is a great way to display urgent alert messages to employees, and simply requires a connection to the projector's RS-232 serial control or LAN connector. Command codes for executing Dynamic Messaging are in the Appendix and available on our website at www.infocus.com/support.



Discount-Merchant.com (800) 281-8860
THE TRUSTED SOURCE FOR PROJECTOR LAMPS AND ACCESSORIES

Using the menus

To open the menus, press the **Menu** button on the keypad or remote. (The menus automatically close after 60 seconds if no buttons are pressed.) Use the arrow buttons to move up and down to highlight the desired menu, then press the **Select** button.

To change a menu setting, highlight it, press **Select**, then use the arrow buttons to adjust the value or select an option or turn the feature on or off. Press **Select** to confirm your changes. Use the arrow buttons to navigate to another setting. When your adjustments are complete, press **Menu** to access a different menu; press the **Menu** button at any time to navigate to the higher-level menu and ultimately close the menus.

The menus are grouped by usage:

- The Basic Picture menu provides common image adjustments.
- The Advanced Picture menu provides more complex image adjustments.
- The Setup menu provides set-up type adjustments that are not changed often.
- The Status and Service menu provides information about the projector and source.

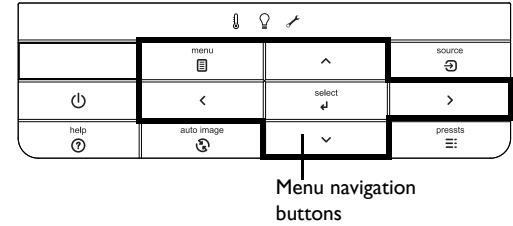

Basic Picture menu



Advanced Picture menu



Setup menu

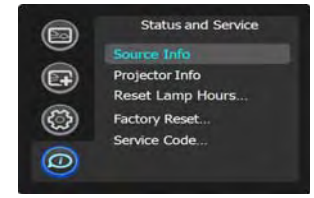

Status and Service menu



Discount-Merchant.com (800) 281-8860
THE TRUSTED SOURCE FOR PROJECTOR LAMP REPLACEMENT ACCESSORIES

Basic Picture menu

To adjust the following settings, highlight the setting, press **Select**, use the arrow buttons to adjust the values, then press **Select** to confirm the changes.

Brightness: Changes the intensity of the image.

Contrast: Controls the degree of difference between the lightest and darkest parts of the picture and changes the amount of black and white in the image.

Sharpness: Changes the clarity of the edges of a video image. Select a sharpness setting.

Color: Adjusts a video image from black and white to fully saturated color. The color setting applies to video sources only.

Tint: Adjusts the red-green color balance in the image of NTSC video images. The tint setting applies to NTSC video sources only.

SplitScreen: Allows two distinct sources to be displayed simultaneously. Switch primary sources, make picture adjustments and choose one of multiple display options: either two side by side horizontal or vertical source regions, or a small secondary source image displayed on top of the primary source in one of four placement options. See page 46 for display options.

Auto Image: Forces the projector to reacquire and lock to the input signal. This is useful when signal quality is marginal.

Aspect Ratio: Aspect ratio is the ratio of the image width to image height. TV screens are usually 4:3. HDTV and most DVDs are 16:9.

Select Auto to have the projector choose the ratio. Choose Native to see the unmodified input with no resizing by the projector. Select 16:9 to watch enhanced widescreen DVDs.

For more information regarding Aspect Ratio, see page 15.

Apply Preset...: Presets are provided that optimize the projector for displaying computer presentations and video images under certain conditions.

There is also a user-definable preset. To set this preset, adjust the image and select Save User in the Presets menu. You can recall these settings in the future by selecting the User preset.

Horz/Vert Keystone: Adjusts the image horizontally or vertically and makes a squarer image.

Digital Zoom: Changes the size of projector's display area. If the display area has been resized by this setting, it can be moved by changing the **Horz Shift** and **Vert Shift** settings.

Horz Shift/Vert Shift: Moves the display area horizontally or vertically if its size has been changed by the **Digital Zoom** setting.



Basic Picture menu



Aspect ratio

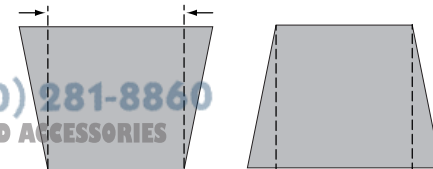

Increasing keystone

Decreasing keystone

Advanced Picture menu

BrilliantColor™ : Produces an expanded onscreen color spectrum that delivers enhanced color saturation for bright, true-to-life images. Choose Normal Look for most video sources and Bright Look for most computer sources.

White Peaking: (video sources only) Increases the brightness of whites that are near 100%.

Color Temperature: Changes the intensity of the colors. Select a listed relative warmth value.

Force Wide: When this is off, the analog locking algorithms choose the standard mode resolution (4:3) as the preferred default resolution. When this is on, the analog locking algorithms choose wide mode resolution (16:10) as the preferred default resolution.

Overscan: Removes noise around the video image.

Phase: Adjusts the horizontal phase of a computer source.

Sync Threshold: (progressive signals only) If a hardware device, such as a DVD player, is not syncing properly with the projector, select this option to help it to sync when connected to the projector.

Tracking: Adjusts the vertical scan of a computer source.

Color Space: This option applies to computer and component video sources. It allows you to select a color space that has been specifically tuned for the input signal. When Auto is selected, the projector automatically determines the standard. To choose a different setting, turn off Auto, then choose RGB for computer sources or choose either REC709 or REC601 for component video sources.

Noise Reduction: Reduces temporal and/or spatial noise in the image.

Flesh Tone Correction: Controls the amount of flesh tone correction applied to the image.

Set Black Level...: Analyzes the current input image and calculates an offset value which is then added to the analog to digital converter black level value. This ensures optimum black level for each analog source.

Detect Film: Controls film mode detection, and determines whether the original source of the input video was film or video.

Gamma: Select the appropriate gamma from among Video, Film, Bright, and CRT.

Color Gamut: Sets the color gamut of the input signal.

Color Gain: Adjusts the gain of the red, green, or blue channel of the image.

Color Offset: Adjusts the offset of the red, green, or blue channel of the image.

Horizontal/Vertical Position: Adjusts the position of a computer source.

Horizontal/Vertical Pincushion: Correct optical pincushion distortion.



Advanced Picture menu

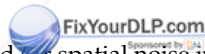

Sponsored by
Discount-Merchant.com (800) 281-8860
THE TRUSTED SOURCE FOR PROJECTOR LAMPS AND ACCESSORIES

Setup menu

Language: Allows you to select a language for the onscreen display.

Network: Allows you to setup network settings. See page 35 for details on network configuration and operation.

- **DHCP:** Turns the DHCP on or off.
- **IP Address:** Assign Network IP Address.
- **Subnet Mask:** Assign Network Subnet Mask.
- **Default Gateway:** Assign Network Default Gateway.
- **WINS Host Name Lookup:** Turns WINS Host Name Lookup on or off.
- **Host Name:** Displays the host name.
- **MAC Address:** Displays network MAC Address value.
- **Show Network Messages:** Turns network messages on or off. Network messages display the projector's IP address (and host name if enabled) when the projector is also displaying source messages.
- **Restart Network...:** Restarts the network.
- **Network Factory Reset...:** Performs factory reset.

Key Click: Turns the key click sound on or off. When this setting is on, pressing keys on the keypad causes the projector's speaker to play a "click" sound.

Custom Key: Allows you to assign a different function to the Custom button, allowing you to quickly and easily use the effect. Highlight an effect and press **Select** to choose a different one.

- **Source Info:** The default action. Shows the Source Info menu.
- **Projector Info:** Shows the Projector Info menu.
- **Aspect Ratio:** Sets the ratio of image width to image height (see page 15 and page 29).
- **Auto Image:** Resynchronizes the projector to the source (page 26).
- **Overscan:** Removes noise around the image.
- **Blank Screen:** Displays an empty screen.
- **Freeze Screen:** Pauses the projected image.
- **Mute:** Turns off all sound.

- **AV Mute:** Enables or disables AV Mute function.
- **Source:** Cycles through available sources.
- **Closed Captions:** Enables or disables Closed Captions.
- **SplitScreen:** Enables or disables SplitScreen. Before using this for the first time, configure SplitScreen sources and layout using the SplitScreen menu (page 29).

Blank Key: Select what to display when the blank key on the remote is pressed: your custom snapshot, a solid color screen (blue, black or white), the factory logo screen, a timer, or test patterns. The timer option is useful for classroom tests or break times during meetings.

Source Key Enable: Enables or disables Source Keys on the optional Commander-2 remote.

AC Power On: When this feature is on, the projector automatically turns on when electrical power is connected. This allows control of ceiling mounted projectors with a wall power switch.

Auto Off Time: Automatically turns the projector off after no signals are detected for a preset number of minutes. If an active signal is received before the projector powers down, the image will be displayed.

Screen Save Time: Automatically blanks the screen with a black color after no signals are detected for a preset number of minutes. The image returns when an active source is detected or a remote or keypad button is pressed.

Sleep Timer: Allows the projector to automatically power off after it has been on for a specified amount of time.

Always-On Functions: Allows you to control which projector functions will work even when the projector is in standby (powered off but connected to AC Power). Press Up or Down to highlight the function you want to change, then press select or left and right to change the function to either Yes or No. Press menu when done. Note that some functions must always have the same value; in this case when you change one value, other values in the submenu may also change automatically.

Lamp Low Power: Toggles between on and off. Turn it on to lower the light output of the lamp. This also lowers the fan speed, making the projector quieter.

Power Sounds: Controls whether the projector makes a sound when powered on and off.

Internal Speakers: Allows the user to turn on and off the internal speakers.

Audio Inputs: Assign an audio input to a specific video/computer source input. (Default settings are as follows: Audio 1 is used with VGA 1; Audio 2 is used with VGA 2; Audio 3 is used with Component; Audio 4 is used with S-video and composite; Audio 5 is used with RGBHV/YPbPr.)

Press up or down to highlight the source you want to change, then press select or the left and right arrow keys to change that source's audio input. Press menu when done changing audio inputs.

Auto Source: When this feature is On, the projector automatically finds the active source, checking the selected Power-up Source first. When this feature is Off, the projector defaults to the source selected in Power-up Source. To display another source, you must manually select one by pressing the **Source** button on the remote or keypad.

Power-up Source: Determines which source the projector checks first for active video during power-up.

Fast Color Refresh: Controls color wheel speed.

Video Standard: When this feature is set to Auto, the projector attempts to automatically pick the video standard based on the input signal it receives. (The video standard options may vary depending on your region of the world.) If the projector is unable to detect the correct standard, the colors may not look right or the image may appear "torn." If this happens, manually select a video standard by selecting NTSC, PAL, or SECAM from the Video Standard menu.

Closed Captions: Controls closed caption display while audio is not muted. If this setting is not off, and audio is not muted, and the source is NTSC and contains captions on the selected channel, when the projector must display caption text overlaid on the image.

Ceiling Mount: Turns the image upside down for ceiling-mounted projection.

Rear Project: Reverses the image so you can project from behind a translucent screen.

Auto Keystone: Automatically adjusts vertical keystoneing.

Prevent PC Screen Saver: Prevents your computer from going into Screen Save mode. The projector must be connected to the PC via a USB cable for this feature to work.

Search Screen: Allows you to display a blank screen instead of the default screen at startup, and when no source is detected. Options include the factory logo screen, a custom Snapshot, or a blue, black or white screen.

Take Snapshot...: Captures the current image and allows it to be used as the search screen image.

Disable Snapshot: Allows the user to disable the snapshot capability.

Show Messages: Displays status messages (such as "Searching") in the lower-left corner of the screen.

Menu Offset: Allows you to change the position of the On Screen Display items.

Menu Transparency: Allows you to change how much of the projected image behind the menu you can see. As the value increases, more of the image behind the menu is visible.

Magnify Controls: Allows you to change the function of the arrow buttons when the menu is not shown. By default, the arrow buttons allow you to advance slides while in PowerPoint's SlideShow mode. To make the arrow buttons also adjust magnify settings, choose Magnify Controls to turn magnify controls on. Now when the menu is not shown, you can press the Select button to switch between the magnification settings (Magnify Level, Magnify Horizontal Position and Magnify Vertical Position), then press Select again to turn off magnify controls and use the arrow buttons to advance slides.

Lens Adjust Enable: When turned on, digital keystone, auto keystone and pincushion adjustments can be made. When the product has been mounted, installers can turn this feature off to prevent changes to keystone and pincushion settings.

Keypad Enable: Enables or disables keypad.

Glow Ring: Controls the brightness level of the glow ring status indicator.

PIN Protect: The PIN (personal identification number) feature allows you to password protect your projector. Once you enable the PIN feature, you must enter the PIN before you can project an image. The default PIN on this projector is **Menu-Up-Down-Select-Source**. Use the navigation buttons on the remote or keypad to enter the correct 5-button press sequence. When all 5 numbers are entered correctly, press the Select button on the remote or keypad to select OK. If the message “Wrong PIN” appears, verify the code and re-enter it. If you mis-enter a number, you must enter 5 numbers and press the Select button in order to access the “Wrong PIN” message and re-enter the code.

To enter the PIN at projector startup:

Power up the projector. The “Enter PIN” dialog box appears after the startup screen. Enter the PIN. Use the navigation buttons on the remote or keypad to enter the correct button press sequence. See the description above for instructions.

To change the PIN:

Select “Change PIN...” in the Setup menu. Enter the existing PIN. Enter the new PIN. You can navigate between OK and Cancel by pressing the arrow buttons on the keypad. Select OK or Cancel by pressing the **Select** button. Verify the new PIN.

If you lose or forget your custom PIN:

Contact InFocus support at www.infocus.com/support.

Serial Port, Baud Rate: Selects the serial port and baud rate.

Serial Port Echo: Controls whether the serial port echoes characters.



Setup menu

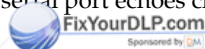

Discount-Merchant.com (800) 281-8860
THE TRUSTED SOURCE FOR PROJECTOR LAMPS AND ACCESSORIES

Status and Service menu

Source Info: Displays current source settings (read-only).

Projector Info: Displays current projector settings (read-only).

Reset Lamp Hours: Resets the lamp hours used counter in the Projector Info menu to zero. Do this only after changing the lamp.

Factory Reset: Restores all settings to their default.

Service Code: Only used by authorized service personnel.

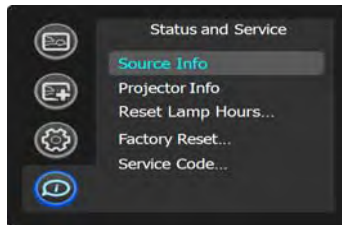

Status and Service menu

Help

Press **Help** (on the keypad or remote) at any time to get interactive help for solving common, picture, sound, and cabling problems.

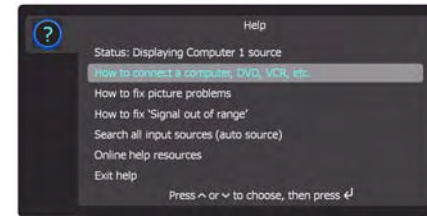

NOTE: The projector can be re-programmed to display a custom (non-interactive) screen when Help is pressed. To do this: Create your custom screen on a computer and display it on the projector, then use the Take Snapshot command in the Setup menu. When you see the Snapshot Successful message, hold down the Help button until the message is removed.

To revert a customized Help screen back to the InFocus default Help screen, a Factory Reset will be needed.



Discount-Merchant.com (800) 281-8860
THE TRUSTED SOURCE FOR PROJECTOR LAMPS AND ACCESSORIES

Using Network Functions

IMPORTANT: To enable network functions at all times (even when the projector is powered off), the Network item in the Always-On Functions submenu in the Setup menu must be set to Yes (not No).

Projector network functions include:

- Configuring and controlling the projector via a web browser.
- Failure and warning alerts via email.
- Projector Management via SNMP.
- Controlling the projector via Scheduling.

NOTE: Projector web pages and emails sent by the projector are always displayed in English language.

Before using the network functions

To use the network functions of the projector, the projector must be configured to suit your network. Consult with your network administrator before connecting the projector to your network; incorrect network configuration of the projector may cause problems on your network.

Connect the Network Cable

Properly connect projector to the network, then configure the following settings.

If Using a Network with DHCP Enabled:

- 1 Use the projector's remote control or keypad to select the Network item in the projector's Setup menu.
- 2 If DHCP is off, select it to turn it on.

If Using a Network that Does Not have DHCP Enabled:

- 1 Use the projector's remote control or keypad to select the Network item in the projector's Setup menu.
- 2 If DHCP is on, select it to turn it off.

NOTE: If you still don't see the IP address, go to the projector's Setup menu, select Network, then turn on Show Network Messages. After exiting the menu press the Source button again.

- 3 Select IP Address. This will highlight the first of the four octets in the IP address. Press **Up** or **Down** to change the value, then press **Select** or **Right** when done to move to the next octet. Repeat until you have changed all four octets in the IP address.
- 4 Repeat the above for Subnet Mask, Default Gateway, and other settings that are in IP address format (to assign or change the Host Name, see **Network Settings Page** below).

Configuring and Controlling the Projector via a Web Browser

You can adjust or control the projector via a network from a web browser on a computer that is connected to the same network as the projector.

NOTES:

- To access the projector's web pages, the projector must be connected to the network and connected to AC power (and if you want to access the web pages even when the projector is powered off, make sure that the Network item in the Always-On Functions submenu is set to Yes).
- JavaScript must be enabled in your browser to use the projector web pages properly. If JavaScript is disabled, see the Help files for your web browser for details on how to enable it.
- If no operations are performed in the web browser for approximately ten minutes, the system will automatically log you off.

Logging in

To log into the projector web pages, follow these steps:

- 1 Make sure the projector is connected to the network and connected to AC power.
- 2 If you don't know the projector's IP address, turn on the projector. After the projector starts up, if its IP address is not shown, press the **Source** button to view the IP address.

IP Address: 192.168.1.10

FixYourDLP.com
Enabled: 

Discount Merchant.com (800) 281-8860
THE TRUSTED SOURCE FOR PROJECTOR LENS AND ACCESSORIES

- 3 Start a web browser on your computer.
- 4 Enter the projector's IP address or host name (preceded by http://) into the web browser's address bar. Example: If the IP address is 192.168.1.10, enter http://192.168.1.10 into the browser's address bar.
- 5 The Log In to Projector Control page will be shown in the browser.
- 6 Select Access type: **Basic User** or **Administrator**.
- 7 Click **Log In**.

Navigating Projector Web Pages

The left side of every page shows a navigation bar. Click the links in the navigation bar to go to different projector web pages.

NOTE: If a Basic User is logged in, no links are shown.

The top of the navigation bar shows the projector name, model, and serial number.

The web pages also include the following options:

- **Log Off:** Logs off and returns to the Log In page (see above).
- **Refresh:** Reloads the page with current status.
- **Defaults:** Displays default (factory settings) values (to save these values click Apply).
- **Apply:** Saves the values that are currently shown on the page.

Projector Controls Page (All users)

This page lets you control the same settings that are available via the projector's main menu and remote control. The Controls tab includes basic remote control functions; other tabs correspond to the projector's menus.

NOTE: If a Basic User is logged in, only the Controls, Basic Picture, and Advanced Picture tabs are shown.

In each tab, the current value of each setting is shown in blue color.

NOTE: Unlike other pages, changes you make to Projector Control settings are applied immediately.

- **To change an on/off setting** (e.g. Power): Click the corresponding **On** or **Off** button.
- **To change a multi-value setting** (e.g. Sharpness): Select a value from the drop-down menu.
- **To change a numeric setting** (e.g. Brightness): Click the corresponding + or - button, or select a value from the drop-down menu.
- **To perform a command** (e.g. Auto Image): Click the corresponding Execute button.

Network Settings Page (administrators only)

This page lets you view and change the projector's network settings. Consult with your network administrator before making any changes on this page; incorrect network configuration of the projector may cause problems on your network.

Projector Name: The name of the projector shown in the projector's web pages.

IP Address: These settings control the projector's network configuration. Enter the appropriate settings required for your specific network.

Advanced Network Settings: Click this link to show advanced settings.

802.1x Authentication: If your network requires 802.1x authentication, enter the user name and password that the projector should use, and select the authentication type.

SNMP: If your network uses SNMP, enter necessary SNMP information here.

Command and Control Pass-Through: This setting allows you to send and receive projector commands over the network. For command codes, see the Appendix or visit the InFocus website at: www.infocus.com/support.

Event Notifications Page (administrators only)

This page lets you configure the projector to automatically send email when specific events occur.

E-Mail Settings tab: In the Account Used... section, enter the information needed for your projector to connect to an email sending (SMTP) server. Then in the Recipient E-Mail Addresses section, enter the email addresses of people who will receive emails, and for each address, select whether that address receives reminders and/or warnings and errors (enter only one address per line). After you have completed this page, click Send Test to make sure that email is correctly set up.

Reminders tab: Select which types of reminders to send. For most reminders, you can adjust the frequency or date/duration associated with the reminder.

Warnings & Errors tab: Select which warnings and errors to send.

Date/Time Settings Page (administrators only)

This page lets you configure the projector to read the time and date from an SNTP server on your network. NOTE: The projector does not have a built-in clock. If the projector is unable to access the SNTP server, or no SNTP server is defined, functions that rely on the time and date may not work correctly.

Current Date and Time: Shows the current date and time read from the SNTP server.

Synchronize the system clock...: Select how often the projector should check the SNTP server to get the time and date. Between checks, the projector will keep track of the amount of time elapsed, allowing it to maintain the correct time and date.

SNTP Server: The address of the time and date server on your network.

Time Zone: The projector's time zone (if you are in a different time zone from the projector, make sure this is the time zone of the region where the projector is located).

Set Now: Click this to immediately set the time and date based on the above information.

Daylight Savings Settings: Click this link to show daylight savings settings:

Start: Select when daylight savings starts.

End: Select when daylight savings ends.

Automatically adjust...: Check this to have the projector automatically update time and date when daylight savings starts and ends.

Scheduled Tasks Page (administrators only)

This page lets you configure the projector to perform tasks automatically on specific days and times. You can set up a maximum of three different scheduled tasks; each tab corresponds to a task. Each scheduled task can perform different commands on different days and times. Each tab contains the following items:

On/Off: Select whether or not this scheduled task will run on the days and times shown.

Description: Explanation of what the task does.

Run Every: Select the days of the week when the scheduled task should run.

At Time(s): Select the times of day when the scheduled task should run (the task will run at the indicated times on every one of the days checked above).

Command Sequence and Available Commands: The Command Sequence list on the left shows commands currently performed by the scheduled task (each task can include up to 20 commands). The Available Commands list on the right shows all commands that can be added to a scheduled task.

<< Add: Adds the command selected in the Available Commands list to the Command Sequence list.

>> Remove: Removes the command selected in the Command Sequence list.

Move Up: Moves up the command selected in the Command Sequence list.

Move Down: Moves down the command selected in the Command Sequence box list.

Clear All: Erases all commands in the Command Sequence list.

Custom: Click this link to show custom command entry options. With custom commands, you can perform additional commands not shown in the Available Commands list. The RS-232 command codes are available in the Appendix and on our website at www.infocus.com/support.

NOTE: Custom commands you enter here should be in write format (do not include '?'), and should use '<' and '>' instead of '(' and ')'. Example: to turn on the ceiling mount setting, use the custom command <CEL1>.

User Access and Security Page (administrators only)

This page lets you configure security options for the projector, including log in passwords and projector access restrictions.

Web Access - Administrator tab: Select whether or not Administrators must enter a password to log into the projector's web pages. If a password is required, click create or change password to update the administrator password.

Web Access - Basic User tab: Select whether or not Basic Users must enter a password to log into the projector's web pages. If a password is required, click create or change password to update the basic user password.

Projector PIN tab: Allows you to turn projector PIN protection on or off, or change the PIN. When PIN protection is on, the current PIN must be entered when the projector is powered on, otherwise the projector will not operate. NOTE: PIN protection only applies to projector operation via the projector's keypad and remote control; it does not affect the projector's web pages.

System Log Page (administrators only)

This page shows a log of the 100 most recent projector events.

Erase Log...: Click this to erase all events in the log.

Network Utilities Page (administrators only)

This page lets you perform various network-related projector tasks.

Save and Load Projector Configuration: These functions save and load all network-related projector settings into/from a file stored on your computer.

This lets you quickly 'clone' network settings from one projector to other projectors.

Upgrade Projector Network Firmware: Upgrades the firmware for the projector's network and LitePort features (this firmware is separate from the regular projector firmware).

Restart Projector Network Subsystem: Restarts the projector network subsystem; does not change any projector settings.

Network Subsystem Factory Reset: Returns all network and LitePort settings to default values and then restarts the projector network subsystem.

Troubleshooting Network Functions

- If network status is shown as **Not Connected** in the projector's Network menu, or the projector does not display its IP address, check the cable or the network configuration.
- If your web browser displays **Page Not Found** or a similar error when you try to access the projector's web pages, verify that the projector is connected to the network (select the Network item in the projector's Setup menu and verify that Network Status shows as Connected); if there is no connection refer to the troubleshooting item above for more help.
- Make sure the Network item in the Always-On Functions submenu in the Setup menu is set to Yes (if it is set to No, the projector web pages will only be available when the projector is powered on).
- If scheduled tasks are not performed, check if the SNTP is set up correctly and is online. Also check if the Command sequence is correct.
- If automatic emails are not sent, check if SMTP is set up correctly and is online.

To manually restart the projector network subsystem: Use the projector's remote control or keypad to select the Network item in the projector's Setup menu. Then scroll down and select either Restart Network (to restart the network subsystem without changing any settings), or Network Factory Reset (to return all network settings back to default values, and then restart the network subsystem). **If the manual restart procedure does not work:** To

force the network subsystem to restart, disconnect the projector from AC power, wait 10 seconds, then reconnect AC power.



Discount-Merchant.com (800) 281-8860
THE TRUSTED SOURCE FOR PROJECTOR LAMPS AND ACCESSORIES

Using LitePort

LitePort displays a slide show of JPEG images stored on a USB flash drive connected to the projector. This can eliminate the need for a computer source.

Image File Types

LitePort displays image files in JPEG format only (file extensions .JPEG and .JPG). Other file types including PDF, BMP, TIFF, PNG, GIF, etc. are ignored.

Viewing a Slide Show

To view your pictures as a slide show, follow these steps:

- 1 Connect a USB flash drive to your computer and copy JPEG files from your computer to the USB flash drive.
- 2 Turn on your projector if needed.
- 3 Remove the USB flash drive from your computer and plug it into the LitePort connector on the rear of the projector.
- 4 The projector will start a slide show of the images found (if you see image thumbnails instead, see To Start the Slide Show section below).
- 5 To go to the next image in the slide show, press the Down or Right arrow button on the projector keypad or remote. To go to the previous image, press the Up or Left arrow button.

Controlling LitePort

When you plug a USB flash drive into the projector's LitePort connector, the projector will scan the drive and then either start a slide show or show image thumbnails.

To stop the slide show and view thumbnails: Press the **Select** button during the slide show. In Thumbnails view, the name of the current folder, the current image number, and the total number of images in that folder are shown at the bottom of the screen. While viewing thumbnails, press the arrow buttons to scroll through the thumbnails, or press **Select** when an image is high-

lighted to start the slide show, or press **Select** when a folder is highlighted to open that folder.

To start the slide show: While viewing thumbnails, press the arrow buttons to highlight a thumbnail, then press the **Select** button to start the slide show at the highlighted image.

To change the image during the slide show: Press the Down or Right button to go to the next image, or press the Up or Left arrow button to go to the previous image (the slide show may also advance automatically depending on the value of the Next Slide setting; see the LitePort Menu section below for details).

To change to a different folder: While viewing thumbnails, press the arrow buttons to highlight the desired folder icon, then press the **Select** button (to go to the higher-level folder, select the folder icon labeled "Up").

To change LitePort settings: Press the **Menu** button during the slide show, or while viewing thumbnails (see the LitePort Menu section below for details).

Using the LitePort Menu

To show the LitePort menu, press the **Menu** button on the keypad or remote during the slide show, or while viewing thumbnails. To highlight a menu item, press arrow buttons. Then to do the action or change the setting, press **Select**. To remove the menu, press the **Menu** button again.

Rotate Picture: Rotates the current image by 90 degrees clockwise (rotation is temporary; the image returns to its original orientation when the USB flash drive is removed from the projector or when the projector is turned off).

Stop/Start Slideshow: Stops the slide show, or starts it at the selected thumbnail (when the menu is not visible, you can also stop or start the slide show by pressing the **Select** button).

Go to Projector Main Menu: Removes the LitePort menu and displays the projector's main menu, where you can adjust the picture or change other projector settings.

(For remaining items below, highlight the setting, then press **Select** one or more times to change the setting value.)

Auto Start: Select On to have the player start the slide show when the USB flash drive is first connected. Select Off to have the player display thumbnails when the USB flash drive is first connected.

Show All Folders: Select On to have the slide show display all images in all folders. Select Off to have the slide show display images only from the current folder.

Fill Screen: Select On to have the slide show expand small images to fill the screen. Select Off to have the slide show display small images at their original size.

Next Slide: Select Manual to disable automatic slide advance in the slide show. Select other values to make the slide show advance to the next image automatically (regardless of this setting, manual advance is always available by pressing the arrow buttons).

Effect: Select Off to have no transition effect when changing between images during the slideshow. Select Random to use a different random effect for each transition. Select other values to use a specific effect.

Show Info: Select On to show the name of the current file and folder, the current image number, and the total number of images in the slide show at the bottom of the screen. Select Off to hide this information.

Displaying PowerPoint Slides

Follow the steps below to display PowerPoint slides using LitePort (these instructions apply to PowerPoint 2007 in Windows; for other presentation programs refer to the program's instructions or help file for the steps needed to save a presentation as separate JPEG files):

- 1 Connect the USB flash drive to your computer.
- 2 Open your PowerPoint document.
- 3 This step is optional but improves image quality: Click the **Design** tab near the top of the PowerPoint document window, then click **Page Setup**. Click the **Slides sized for** drop-down menu and select Custom. Change both Width and Height to double their previous values, then click **OK**.

4 Click the Office button in the upper left corner of the PowerPoint document window.

5 Point to **Save As**, then click **Other Formats**.

6 In the Save As dialog box, click the **Save as type** drop-down menu. Scroll through the menu and select JPEG File Interchange Format.

7 Make sure the contents of your USB flash drive are visible in the Save As dialog box before you continue - to view your USB flash drive in the Save As dialog box, first click My Computer, then double-click the USB flash drive's icon (make sure you do both of these in the Save As dialog box, not on your computer's desktop).

8 Click **Save**. PowerPoint will ask if you want to export every slide or only the current slide; click **Every Slide**. PowerPoint will save each slide in your presentation as a separate JPEG file. These files are saved in a new folder that has the same name as the original document.

9 Remove the USB flash drive from your computer and plug it into the projector's **LitePort** connector.

10 On the projector, navigate to the folder created in step 8 and then start the slide show (for instructions on navigating and controlling the slide show, see the Controlling LitePort section above).

NOTE: PowerPoint embedded videos, transition effects, and animations are not included when saving as JPEG. However, you can select a LitePort slideshow transition effect by changing the Effect in the LitePort menu.



DiscountMerchant.com (800) 281-8860

PROJECTOR LAMPS AND ACCESSORIES

Troubleshooting LitePort

- If images load slowly: Make sure you are using a newer USB 2.0-compatible (high speed) USB flash drive. Larger image file sizes may also slow down the player; to reduce file size, use an image editing program on your computer to resize images smaller; for the best balance between image quality and speed, resize images to be 1024 pixels wide.
- If no images are found, or some images are not shown, or you only see folder thumbnails but no images: Make sure that images are JPEG file type (file extensions .JPEG and .JPG); other file types are not supported and will be ignored.
- If you see a blank screen, or a logo, or the wrong input source (computer, video, etc.) instead of your images: Keep pressing the Source button on the keypad or remote until the LitePort message is displayed (if you still don't see any images, make sure the USB flash drive is correctly and completely plugged into the projector's LitePort connector).
- If nothing happens when you connect your USB flash drive, and you cannot select the LitePort input source as described above: Check the format of your USB storage device. LitePort only supports USB storage devices formatted as FAT32. Devices formatted as NTFS, and non-storage devices (such as cameras) are not supported.
- If images saved by PowerPoint are low quality: Make sure to do step 3 when following the steps in the Displaying PowerPoint Slides section above.



Discount-Merchant.com (800) 281-8860
THE TRUSTED SOURCE FOR PROJECTOR LAMPS AND ACCESSORIES

Maintenance

Cleaning the lens

- 1 Turn the projector off and unplug the power cord.
- 2 Apply a non-abrasive camera lens cleaner to a soft, dry cloth.
 - Avoid using an excessive amount of cleaner, and don't apply the cleaner directly to the lens. Abrasive cleaners, solvents or other harsh chemicals might scratch the lens.
- 3 Lightly wipe the cleaning cloth over the lens in a circular motion.

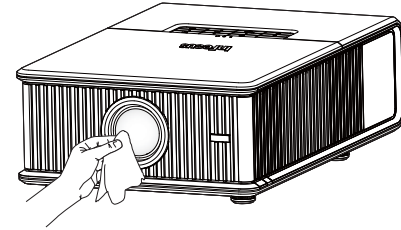

WARNINGS:

- Turn the projector off and unplug power cord before cleaning any part of the projector.
- Do not open any cover on the projector, except the lamp cover or projector top cover.
- Do not attempt to service this product yourself as opening and removing covers may expose you to dangerous voltage and other hazards. Refer all servicing to qualified service personnel.



Discount-Merchant.com (800) 281-8860
THE TRUSTED SOURCE FOR PROJECTOR LAMPS AND ACCESSORIES

Replacing the projection lamp

The Lamp Hours timer in the Projector Info menu counts the number of hours the lamp has been in use. Twenty hours before the lamp life expires, the message “Replace lamp” appears on the screen at startup.

- **NOTE:** Be sure to use the InFocus lamp module designed for this projector. You can order new lamps from www.infocus.com (in select areas), your retailer or your dealer. **Only genuine InFocus lamps are tested for use in this projector.** Use of non InFocus lamps may cause electrical shock and fire, and may void the projector warranty. InFocus is not liable for the performance, safety or certification of any other lamps.

WARNINGS:

- The projector uses a high-pressure mercury glass lamp. The lamp may fail prematurely, or it may rupture with a popping sound if jolted, scratched, or handled while hot. The risk of lamp failure or rupture also increases as the lamp age increases; please replace the lamp when you see the “Replace Lamp” message.
- To avoid burns, allow the projector to cool for at least 60 minutes before you replace the lamp.
- Unplug the power cord before replacing the lamp.
- Do not drop the lamp module. The glass may shatter and cause injury.
- Do not touch the glass surface of the lamp module. Fingerprints can obscure projection sharpness and may cause the glass to shatter.
- Be extremely careful when removing the lamp housing. In the unlikely event that the lamp ruptures, small glass fragments may be generated. The lamp module is designed to contain most of these fragments, but use caution when removing it.
- Before replacing a ruptured lamp, clean the lamp compartment and dispose of cleaning materials. Wash hands after lamp replacement.
- When replacing the lamp while the projector is ceiling-mounted, wear protective eyewear to prevent eye injury.
- Hg – Lamp contains mercury. Manage in accordance with local disposal laws. See www.lamprecycle.org.

- 1 Turn the projector off and unplug the power cord.
- 2 Wait 60 minutes to allow the projector to cool thoroughly.
- 3 Remove the lamp door by removing the screws on the side of the lamp door, and lifting the door off.

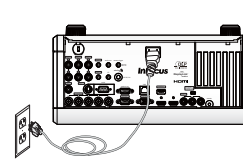

Turn off and
unplug projector

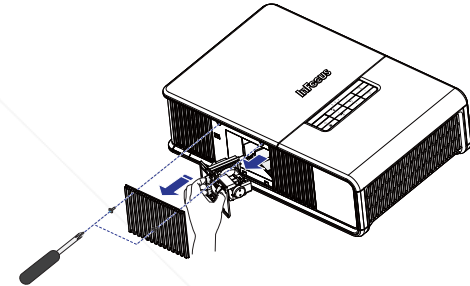
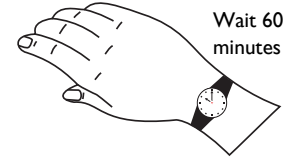

www.FixYourDLP.com

DiscountMerchant.com (800) 281-8860
THE TRUSTED SOURCE FOR PROJECTOR LAMPS AND ACCESSORIES

- 4 Loosen the captive screws that attach the lamp housing to the projector.
- 5 Using the handle, carefully remove the lamp housing. Dispose of the lamp in an environmentally proper manner in accordance with local disposal laws.
- 6 Install the new lamp housing, pressing the lamp into place.
- 7 Tighten the captive screws.
- 8 Replace the lamp door and tighten both screws.
- 9 Plug in the power cord and press the **Power** button to turn the projector back on.
- 10 To reset the lamp hour timer, navigate to the **Status and Service** menu and select **Reset Lamp Hours**. See page 34 for details.

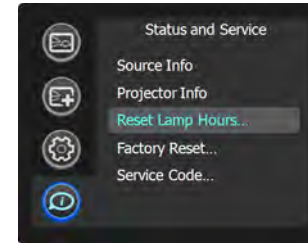

Using the security lock

The projector has a security lock for use with a Cable Lock System. Refer to the information that came with the lock for instructions on how to use it.

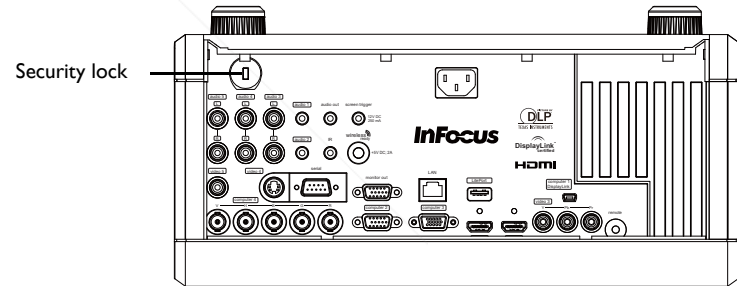

Discount-Merchant.com (800) 281-8860
THE TRUSTED SOURCE FOR PROJECTOR LAMPS AND ACCESSORIES

Appendix

SplitScreen Compatibility

Splitscreen allows two distinct sources to be displayed simultaneously. Switch primary sources, make picture adjustments and choose one of multiple display options: either two side by side horizontal or vertical source regions, or a small secondary source image displayed on top of the primary source in one of four placement options. Lets you show two different sources at the same time. See page 29 for details. The following source combinations are supported:

Table 4:

	HDMI1	HDMI2	VGA1	VGA2	RGBHV	Component	S-video	Composite	DOUSB	LitePort
HDMI1		X		X		X	X	X	X	X
HDMI2	X		X		X					
VGA1		X		X		X	X	X	X	X
VGA2	X		X		X					
BNC		X		X		X	X	X	X	X
Component	X		X		X					
S-video	X		X		X					
Composite	X		X		X					
DOUSB	X		X		X					
LitePort	X		X		X					



Discount-Merchant.com (800) 281-8860
THE TRUSTED SOURCE FOR PROJECTOR LAMPS AND ACCESSORIES

RS-232 commands

IMPORTANT: When formatting commands sent from a control system or computer, enclose commands in parentheses "(" and ")". When entering custom commands into Scheduled Tasks in the projector's web interface, enclose commands in less than/greater than symbols "<" and ">" instead.

Communication Configuration

Visit our website for additional RS-232 settings and information.

To control this projector via RS-232, connect a null modem cable and set the control system serial port settings to match the following communication configuration:

RS-232 Port Settings	
Setting	Value
Bits per second	115,200
Data bits	8
Parity	None
Stop bits	1
Flow control	None
Emulation	VT100

Command Format

All commands consist of 3 alpha characters followed by a request, all enclosed in parentheses. The request can be a read request (indicated by a "?") or a write request (indicated by 1 to 4 ASCII digits).

A read request example:

(AAA?) where
(starts the command
AAA denotes the command
? denotes the read request
) ends the command

A read command returns the range and the current setting, for example:

Read Command Examples		
Function	Command	Response
Brightness	(BRT?)	(96-160,128)
Volume	(VOL?)	(0-32, 0)
Lamp Hours	(LMP?)	(0-32766, 42)

A write request example:

(AAA####) where
(starts the command
AAA denotes the command
denotes the value to be written
(leading zeros not necessary)
) ends the command

Some commands have ranges, while others are absolute. If a number greater than the maximum range is received, it is automatically set to the maximum number for that function. If a command is received that is not understood, a "?" is returned. With absolute settings, "0" is off, 1-9999 is on. The one exception is the Power command, where 0 is off and 1 is on.

To assure the projector can process a command, wait 3 seconds before entering the next command.

Read Command Examples		
Function	Command	Response
Brightness	(BRT I 40)	Sets the brightness to 140
Power	(PWR0)	Turns power on
Power	(PWR1)	Turns power off

Error Conditions

Not all commands are supported for all projectors. If an unsupported command is issued, the command will be ignored. If a command is received that is not understood, a '?' character will be returned indicating the command was not understood.

Limitations

The projector cannot respond to commands coming in at a high-rate. Therefore, a delay must occur between commands to ensure that the command gets properly executed. To assure the projector can process a command, wait 3 seconds before entering the next command.

The Step column refers to increasing or decreasing the menu bar position since the On-screen Display is not an exact match of values. For example, Step 2 changes the data by 2 through the CLI (Command Line Interface). The menu bar is up (or down) by 1.

Function	Command	Min	Max	Default	Step
About (Source Info) 0: n/a 1: enable	ABT at W	0	1	n/a	
Aspect Ratio 0: Native 1: 16:9 2: 4:3	ARZ at RW	0	2	2	
Auto Image 0: n/a 1: enable	AIM at W 0	0	1	n/a	
Auto Power 0: disable 1: enable	APO at RW	0	1	0	
Auto Source 0: disable 1: enable	ASC at RW	0	1	1	
Blank 0: off 1: on	BLK at RW	0	1	0	



Discount-Merchant.com (800) 281-8860
THE TRUSTED SOURCE FOR PROJECTOR LAMPS AND ACCESSORIES

Blank Screen 0: black 1: blue 2: white	BSC at RW	0	2	1	
Blue Gain	BCG at RW	64	192	128	1
Brightness	BRT at RW	96	160	128	1
Ceiling 0: disable 1: enable	CEL at RW	0	1	0	1
Color	CLR at RW	96	160	128	1
Color Space 0: Auto 1: RGB 2: REC709 3: REC601 4: RGB Video	CSM at RW	0	4	0	
Color Temp 0: 9300K 1: 6500K 2: 7200K 3: User	TMP at RW	0	3	2 (computer 2,3) 0 (other)	
Contrast	CON at RW	96	160	128	

Custom Key (Effect) 0: blank 1: mute 2: aspect ratio 3: source 4: auto image 5: freeze 6: zoom 7: Source Info 8: Service Info 15: AV Mute 17: SplitScreen	EFK at RW	0	15	7	
Display Messages 0: disable 1: enable	DMG at RW	0	1	1	
Factory Reset 0: not reset 1: reset	RST at W	0	1	n/a	
Freeze 0: disable 1: enable	FRZ at RW	0	1	0	
Green Gain	GCG at RW	64	192	28	1
Horizontal Keystone	DKH at RW	38	218	128	1
HDMI Noise Cancel	HNC at RW	0	1	1	
Horizontal Position	HPS at RW	def: -128	def:+128	auto	1



Discount-Merchant.com (800) 281-8860
THE TRUSTED SOURCE FOR PROJECTOR LAMPS AND ACCESSORIES

Internal Sound Enable 0: disable 1: enable	INT at RW	0	1	1	
IR Receiver front 0: disable 1: enable	IRF at RW	0	1	1	
IR Receiver rear 0: disable 1: enable	IRR at RW	0	1	1	
IR Receiver top 0: disable 1: enable	IRT at RW	0	1	0	
Language 0: English 1: French 2: German 3: Italian 5: Korean 6: Norwegian 7: Portuguese 8: Russian 9: Simplified Chinese 10: Spanish 11: Traditional Chinese 12: Swedish 13: Dutch 14: Polish 15: Turkish 16: Danish 17: Finnish	LAN at RW	0	17	0	
Lamp Hours	LMP at R	0	32766	0	1

Lamp Lit 0: not lit 1: lit	LML at R	0	1		
Reset Lamp Hours 0: not reset 1: reset	LRT at W	0	1	n/a	
Number of Lamp Resets	LMR at R	0	32766	0	
Lamp Total On Time (All Bulbs)	LMT at R	0	21474 83646	0	
Time In Hours Last Bulb1 Lasted	LB1 at R	0	32766	0	
Time In Hours Last Bulb2 Lasted	LB2 at R	0	32766	0	
Time In Hours Last Bulb3 Lasted	LB3 at R	0	32766	0	
Low Power 0: disable 1: enable	LPE at RW	0	1	0	
Magnify	MAG at RW	0	48	0	1
Magnify Enable 0: disable 1: enable	MGE at RW	0	1	0	
Magnify Position Horizontal	MPH at RW	0	64	32	1
Magnify Position Vertical	MPV at RW	0	64	32	1



Discount-Merchant.com (800) 251-8860
THE TRUSTED SOURCE FOR PROJECTOR LAMPS AND ACCESSORIES

Menu 0: disable 1: enable	MNU at RW	0	1	0	
Menu Navigation 0: up 1: down 4: select	NAV at W	0	4	n/a	
Mute 0: disable 1: enable	MTE at RW	0	1	0	
Network Restart 0: not restart 1: restart	NTR at W	0	1	n/a	
NND (PC Screen Saver Off) 0: disable 1: enable	NND at RW	0	1	1	
Overscan 0: disable 1: enable	OVS at RW	0	1	0	
Phase	MSS at RW	0	31	0	1
Power 0: disable 1: enable	PWR at RW	0	1	0	
Power Save 0: disable 1: enable	PSV at RW	0	1	0	



Discount-Merchant.com (800) 251-8860
 THE TRUSTED SOURCE FOR PROJECTOR LAMPS AND ACCESSORIES

Power-up Source 0: DisplayLink 1: VGA 1 2: VGA 2 3: RGBHV 4: HDMI 1 5: HDMI 2 6: Component 7: S-video 8: Composite	DSC at RW	0	5	1	
Presets 0: user 1 1: user 2 2: user 3 3: Presets Off 5: presentation 7: video 10: bright 11: whiteboard	PST at RW	0	11	computer 2,3:5 computer 1, video:7	
Rear 0: disable 1: enable	REA at RW	0	1	0	
Red Gain	RCG at RW	64	192	128	1
Reset Filter Hours 0: not reset 1: reset	FRT at W	0	1	n/a	
Save User Presets 1 0: not saved 1: saved	US1 at W	0	1	n/a	
Save User Presets 2 0: not saved 1: saved	US2 at W	0	1	n/a	

Save User Presets 3 0: not saved 1: saved	US3 at W	0	1	n/a	
Screen Save 0: 5 minutes 1: 10 minutes 2: 15 minutes 3: 20 minutes 4: 25 minutes 5: 30 minutes	SSV at RW	0	5	0	
Sharpness 5: Sharpest 6: Sharper 7: Standard 8: Softer 9: Softest	SHP at RW	5	9	7 (computer and video 1) 6 (video 2)	
Source 0: DisplayLink 1: VGA 1 2: VGA 2 3: RGBHV 4: HDMI 1 5: HDMI 2 6: Component 7: S-video 8: Composite	SRC at RW	0	5	0	
Source 1 0: DisplayLink 1: VGA 1 2: VGA 2 3: RGBHV 4: HDMI 1 5: HDMI 2 6: Component 7: S-video 8: Composite	SRI at RW Source 2:SR2 Source 3:SR3	0	5	0 1 3	

Audio for Source 0 0: audio 1 1: audio 2 2: audio 3 3: audio 4 4: HDMI Internal	SA0 at RW	0	5	4	
Audio for Source 1 0: audio 1 1: audio 2 2: audio 3 3: audio 4	SA1 at RW Source 2:SA2 Source 3:SA3 Source 4:SA4	0	5	0 1 3 2 2	
SplitScreen Enable 0: off 1: on	SSC at RW	0	1	0	
SplitScreen Second Source 0: off 1: DisplayLink 2: VGA 1 3: VGA 2 4: RGBHV 5: HDMI 1 6: HDMI 2 7: Component 8: S-video 9: Composite	SSL at RW	0	6	0	



Discount-Merchant.com (800) 281-8860
 THE TRUSTED SOURCE FOR PROJECTOR LAMPS AND ACCESSORIES

SplitScreen Second Source Location 0: right 1: bottom 2: left 3: top 4: bottom right 5: bottom left 6: top left 7: top right	SSY at RW	0	7	0	
SplitScreen Second Source Size 0: small 1: medium 2: large	SSZ at RW	0	2	2	
SplitScreen Swap 0: n/a 1: enable	SSS at W	0	1	n/a	
Startup Logo 0: blank screen 1: default 2: captured	SHP at RW	5	9		
Sync on Green 0: Sunc on G off 1: Auto					
Tint	TNT at RW	96	160	128	1
Tracking	MTS at RW	def: -384	def:+384	auto	1
Unit Total Time On	ONL at R	0	0	0	
Vertical Keystone	DKC at RW	38	128	128	

Vertical Position	VPS at RW	if def < 128:0 else: def - 128	def + 128	auto	1
Video Standard 0: Auto 1: NTSC 2: PAL 3. SECAM	VSU at RW	0	3	0	
Volume	VOL at RW	0	32	16	1

FixYourDLP.com
 21474
 83646
Discount-Merchant.com (800) 281-8860
 THE TRUSTED SOURCE FOR PROJECTOR LAMPS AND ACCESSORIES

INDEX

Numerics

16x9 vs 4x3 15

A

Aspect Ratio 15

Audio In Computer connector 11

Audio Out connector 25

C

Cable box 14

Computer In connector 10

Connecting

external speakers 25

Connecting

computer 10

video device 14

Connecting a computer source 10

Contacting InFocus 23

Customer service contact information 23

D

Digital Zoom 29

Displaying an image 12

Dynamic Messaging 27

F

Focus 13

H

HDTV 4

Help 34

K

Keypad buttons 26

Keystone 20

L

Laptop video port activation 12

LitePort

Using LitePort 40

M

Menu usage 28

Monitor Out connector 11

N

Network

Using Network Functions 35

O

Optimizing computer image 26

Optimizing video images 27

P

Position the projector 7

Power connector 10

Power cord 10

Presentation features 26

Projector

keypad buttons 26

menus 28

Projector

connecting computers 10

connecting video devices 14

positioning 7

setting up 7

shutting down 16

troubleshooting problems 16

R

Remote control 24

S

Scheduled Tasks Page 37

Screen Aspect 15

Screen Save 16

Shutting down the projector 16

Speakers, connecting external 25

S-video connector 14

T

Troubleshooting Network Functions 38

TV tuner 14



Discount-Merchant.com 800-281-8880
THE TRUSTED SOURCE FOR PROJECTOR LAMPS AND ACCESSORIES

U

USB 11

User Access and Security Page 38

V

Viewing a Slide Show 40

Volume button 25

W

Warranty 23

Z

Zoom 13



Discount-Merchant.com (800) 281-8860
THE TRUSTED SOURCE FOR PROJECTOR LAMPS AND ACCESSORIES



Disclaimer

This user manual is provided as a free service by FixYourDLP.com. FixYourDLP is in no way responsible for the content of this manual, nor do we guarantee its accuracy. FixYourDLP does not make any claim of copyright and all copyrights remain the property of their respective owners.

About FixYourDLP.com

FixYourDLP.com (<http://www.fixyourdpl.com>) is the World's #1 resource for media product news, reviews, do-it-yourself guides, and manuals.

Informational Blog: <http://www.fixyourdpl.com>

Video Guides: <http://www.fixyourdpl.com/guides>

User Forums: <http://www.fixyourdpl.com/forum>

FixYourDLP's Fight Against Counterfeit Lamps:

<http://www.fixyourdpl.com/counterfeits>

Sponsors:

RecycleYourLamp.org – Free lamp recycling services for used lamps:

<http://www.recycleyourlamp.org>

Lamp Research - The trusted 3rd party lamp research company:

<http://www.lampresearch.com>

Discount-Merchant.com – The worlds largest lamp distributor:

<http://www.discount-merchant.com>



FixYourDLP.com

Sponsored by 