



# Disclaimer

This user manual is provided as a free service by FixYourDLP.com. FixYourDLP is in no way responsible for the content of this manual, nor do we guarantee its accuracy. FixYourDLP does not make any claim of copyright and all copyrights remain the property of their respective owners.

About FixYourDLP.com

FixYourDLP.com (<http://www.fixyourdpl.com>) is the World's #1 resource for media product news, reviews, do-it-yourself guides, and manuals.

Informational Blog: <http://www.fixyourdpl.com>

Video Guides: <http://www.fixyourdpl.com/guides>

User Forums: <http://www.fixyourdpl.com/forum>

FixYourDLP's Fight Against Counterfeit Lamps:

<http://www.fixyourdpl.com/counterfeits>

## Sponsors:

RecycleYourLamp.org – Free lamp recycling services for used lamps:

<http://www.recycleyourlamp.org>

Lamp Research - The trusted 3rd party lamp research company:

<http://www.lampresearch.com>

Discount-Merchant.com – The worlds largest lamp distributor:

<http://www.discount-merchant.com>



**FixYourDLP.com**

Sponsored by 

# IN82



[www.infocus.com/support](http://www.infocus.com/support)

010-0629-01 



**Discount-Merchant.com (800) 281-8860**  
THE TRUSTED SOURCE FOR PROJECTOR LAMPS AND ACCESSORIES



InFocus **IN82** User's Guide

# IN82



**User's Guide**  
**Mode d'emploi**  
**Benutzeranleitung**  
**Manual de Uso**  
**Guidaall'uso**

**Gebruikershandleiding**  
**Guia do usuário**  
**Användarhandbok**  
**사용 설명서**  
**用户指南**

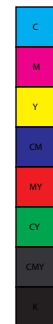

## Declaration of Conformity

Manufacturer: InFocus Corporation, 27500 SW Parkway Ave. Wilsonville, Oregon 97070 USA

European Office: Louis Armstrongweg 110, 1311 RL Almere, The Netherlands

We declare under our sole responsibility that this projector conform to the following directives and norms:

EMC Directive 89/336/EEC, Amended by 93/68/EEC

EMC: EN 55022

EN 55024

EN 61000-3-2

EN 61000-3-3

Low Voltage Directive 73/23/EEC, Amended by 93/68/EEC

Safety: IEC 60950-1: 1<sup>st</sup> Edition

July, 2007

## Trademarks

Adobe and Acrobat are trademarks or registered trademarks of Adobe Systems Incorporated. Digital Light Processing and BrilliantColor are trademarks or registered trademarks of Texas Instruments. ISF is a trademark or registered trademark of Imaging Science Foundation, Inc. Deep Color s a trademark or registered trademark of Pixelworks and DNX are trademarks or registered trademarks of Pixelworks Inc. HDMI, the HDMI logo and High-Definition Multimedia Interface are trademarks or registered trademarks of HDMI Licensing LLC. InFocus, In Focus, and INFOCUS (stylized), ASK and Proxima are either registered trademarks or trademarks of InFocus Corporation in the United States and other countries.

## FCC Warning

Note: This equipment has been tested and found to comply with the limits for a Class B digital device, pursuant to part 15 of the FCC Rules. These limits are designed to provide reasonable protection against harmful interference in a residential installation. This equipment generates, uses and can radiate radio frequency energy and, if not installed and used in accordance with the instructions, may cause harmful interference to radio communications. However, there is no guarantee that interference will not occur in a particular installation. If this equipment does cause harmful interference to radio or television reception, which can be determined by turning the equipment off and on, the user is encouraged to try to correct the interference by one or more of the following measures:

- Reorient or relocate the receiving antenna.
- Increase the separation between the equipment and receiver.
- Connect the equipment into an outlet on a circuit different from that to which the receiver is connected.
- Consult the dealer or an experienced radio/TV technician for help.

Changes or modifications not expressly approved by InFocus Corporation may void authority to operate the equipment.

## Canada

This Class B digital apparatus complies with Canadian ICES-003.

Cet appareil numérique de la classe B est conforme à la norme NMB-003 du Canada.

## Agency Approvals

UL, cUL, TUV, GOST

Other specific Country Approvals may apply. Please see product certification label.

This document applies to models IN82 and P820.

InFocus reserves the right to alter product offerings and specifications at any time without notice.



**Discount-Merchant.com (800) 281-8860**  
**THE TRUSTED SOURCE FOR PROJECTOR LAMPS AND ACCESSORIES**

## Table of Contents

Introduction	3
Positioning the projector	5
Choosing the aspect ratio	6
Connecting a video device	7
Video connectors	7
Digital connections	7
HDMI 1.3 connection	8
DVI connection	8
Component (RCA) connection	8
S-video connection	8
Composite (RCA) video connection	8
Computer connections	8
RS-232 connections	8
Displaying an image	9
Adjusting the image	9
Shutting down the projector	11
Troubleshooting your setup	11
Using the remote control	17
Optimizing video images	18
Customizing the projector	18
Using the menus	19
Picture menu	20
Settings menu	24
Maintenance	27
Replacing the projection lamp	27
Appendix	29
Remote control discrete	29
Projector dimensions for ceiling mount installations	29
RS-232 terminal Product Interface specifications	31

## Important Operating Considerations for Safety

- Place the projector in a horizontal position no greater than 15 degrees off axis.
- Locate the projector in a well-ventilated area without any obstructions to intake or exhaust vents. Do not place the projector on a tablecloth or other soft covering that may block the vents.
- Locate the projector at least 4' (1.2 m) away from any heating or cooling vents.
- Use only InFocus-approved ceiling mounts.
- Use only the power cord provided. A surge-protected power strip is recommended.
- Refer to this guide for proper startup and shutdown procedures.
- Hg – Lamp contains mercury. Manage in accordance with local disposal laws. See [www.lamprecycle.org](http://www.lamprecycle.org).
- In the unlikely event of a lamp rupture, particles may exit through the projector side vents. When the projector is turned on, keep people, food, and drinks out of the "keep out" area under and around the projector, as indicated by the "X" areas below.

Follow these instructions to help ensure image quality and lamp life over the life of the projector. Failure to follow these instructions may affect the warranty. For complete details of the warranty, see the Warranty booklet.

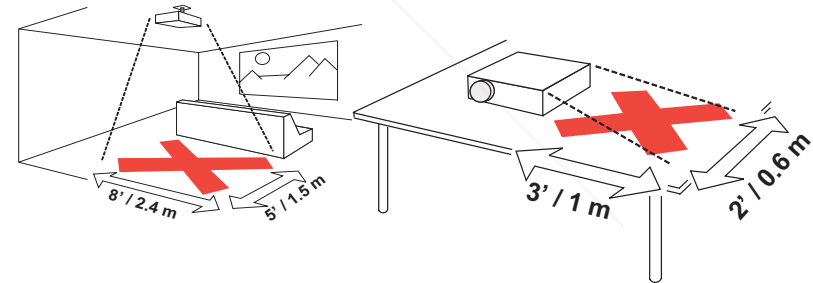

## Introduction

Your new InFocus projector is specifically designed for home theater applications. It sets a high standard using the latest DLP™ technology and new DNX™ video processing from Pixelworks™. The projector has 1920x1080 resolution (1080p). Whether you are watching movies or High Definition broadcasts or playing the latest video game, you will enjoy amazing image quality.

### Product specifications

To read the latest specifications, be sure to visit our website at [www.infocus.com](http://www.infocus.com) as specifications are subject to change.

### Online Registration

Register your projector on our website at [www.infocus.com/register](http://www.infocus.com/register) to activate your warranty and receive product updates, announcements, and registration incentives.

### Included items

- power cord
- HDMI™ cable
- MI-to-HDMI adapter
- remote control
- swivel base (for tabletop use)
- polishing cloth
- cable cover (attached to projector)

Optional accessories can be found on our website at [www.infocus.com](http://www.infocus.com) or at your retailer or dealer.

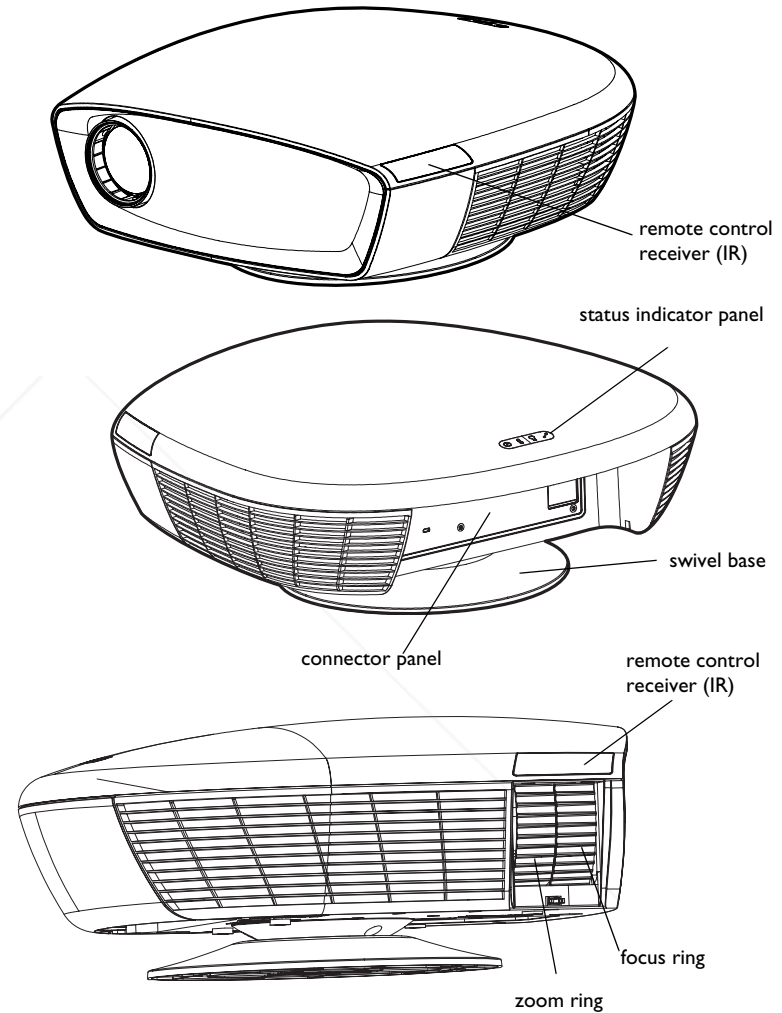

### Connector Panel

Remove the cable cover, if attached, to access the connector panel. Replace the cover after the projector is installed, if desired.

The projector provides the following connection options:

- MI-DA/DVI (Digital Visual Interface)
- HDMI™ (High Definition Multimedia Interface)
- Component (RCA)
- S-video
- Composite video (RCA)

See “Video connectors” on page 7 for details.

The projector also provides the following connectors:

- RS-232 for serial control
- Two 12 volt DC outputs (see below)
- IR input for connection to Nilis/Xantech compatible IR repeater systems

### 12 volt DC outputs

The 3.5mm mini-jack triggers provide a 12 volt, 0.25 amp DC output. They provide a constant output while the projector is on. They are typically used for screen control. For example, if you connect your projection screen to the vertical screen trigger with the cable that came with your screen, when you turn on the projector the screen will move down; when you turn the projector off, the screen will return to the storage position. The horizontal screen trigger output can be used to control curtains or an adjustable aspect ratio screen.

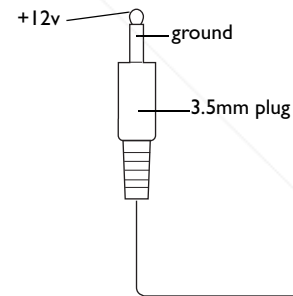
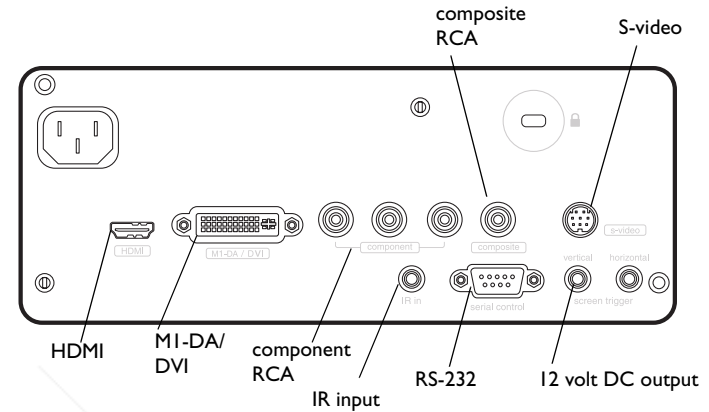

to, for example, screen relay (see screen manufacturer for details)

## Positioning the projector

To determine where to position the projector, consider the size and shape of your screen, the location of your power outlets, and the distance between the projector and the rest of your equipment. Here are some guidelines:

- Position the projector on a flat surface at a right angle to the screen. The projector must be at least 4.9 feet (1.5m) from the projection screen.
- For safety reasons, position the projector within 10 feet (3m) of your power source (running extension cables may introduce a trip hazard). To ensure adequate cable access, do not place the projector within 6 inches (.15m) of a wall or other object.
- If you are installing the projector on the ceiling, refer to the installation guide that comes with the Ceiling Mount Kit for more information. To turn the image upside down, see “Ceiling” on page 24. We recommend using an InFocus authorized ceiling mount.
- Position the projector the desired distance from the screen. The distance from the lens of the projector to the screen, the zoom setting, and the video format determine the size of the projected image.
- The image offset is 136%. This means that if you have an image 10’ high, the bottom of the image will be 3.6’ above the center of the lens.

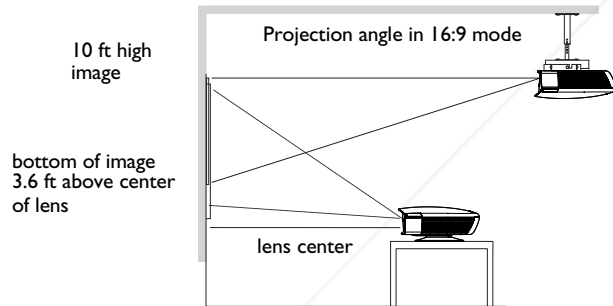

**Table 1:**  
*Range of distance to the screen for a given screen size*

Diagonal Screen Size (inches/m)	Horizontal Screen Size (inches/m)	Distance to screen	
		Maximum distance (feet/m)	Minimum Distance (feet/m)
60/1.5	52.6/1.3	9.7/2.96	8.1/2.47
80/2	69.8/1.8	12.9/3.94	10.8/3.28
92/2.3	80.2/2	14.8/4.52	12.4/3.77
150/3.8	130.9/3.3	24.2/7.38	20.2/6.15

**NOTE:** Visit the Service section of our website at [www.infocus.com/calculator](http://www.infocus.com/calculator) for an interactive image size calculator.

## Choosing the aspect ratio

Aspect ratio is the ratio of the image width to image height. HDTV and most DVDs are 16:9, which is the default for this projector. When in 4:3 mode the projector places black bars on both sides of the image. Native mode centers the image and turns off the internal scaler so that any resolution larger than the native projector resolution is cropped on the edges. Letterbox expands the image to fill the screen.

What you plan to project will also help you choose between 4:3 and 16:9. For example, most TV shows are 4:3, while most movies are 16:9. If you have a 16:9 screen, then you should select an aspect ratio of 16:9 for anamorphic movies and HDTV, and Native for 4:3 content. If you have a 4:3 screen you should still use 16:9 for anamorphic movies or HDTV, but you also have the option of using 4:3, Native, or Natural Wide for 4:3 content. Keep in mind that anamorphic movies only appear correctly if the DVD player is set to output to a 16:9 television. Natural Wide stretches a 4:3 image to fill the entire 16:9 screen. The center two-thirds of the image is unchanged; the edges of the image are stretched.

**NOTE:** If you purchase an optional anamorphic lens, select the Letterbox option to achieve the 2.35:1 aspect ratio.

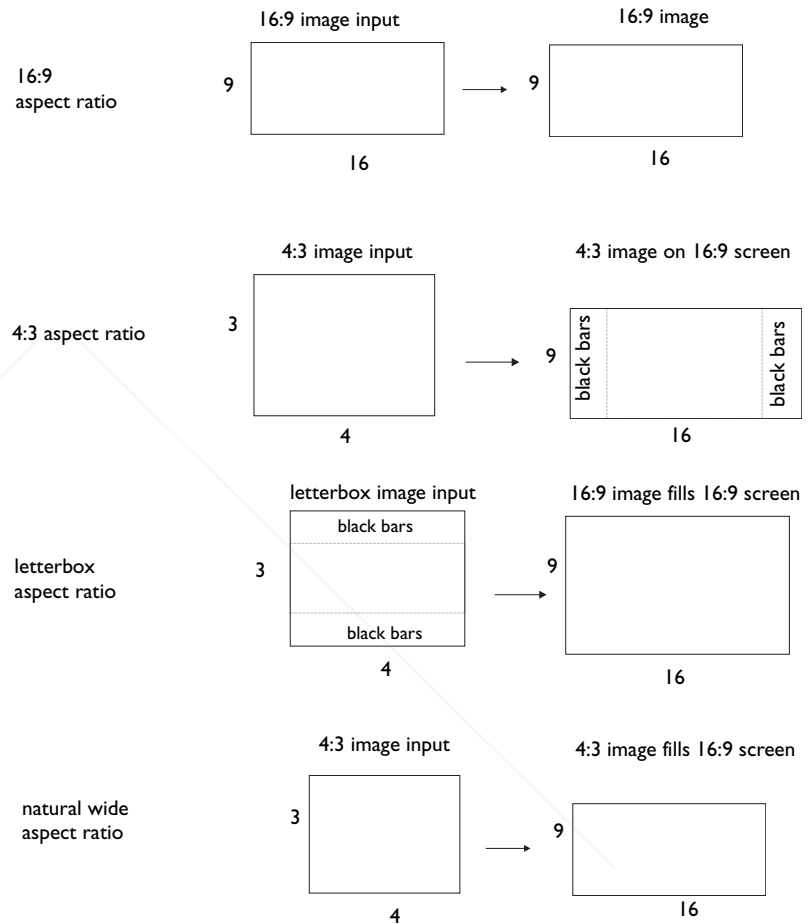



## Connecting a video device

You can connect video devices such as HDTV receivers, HD-DVD players, VCRs, camcorders, digital cameras, video game consoles, and TV tuners to the projector. Connect the audio from your video device to your stereo system to get sound.

You can connect the projector to most video devices that can output video. You cannot directly connect the coaxial cable that enters your house from a cable or satellite company, the signal must pass through a tuner first. Examples of tuners are digital cable boxes, VCRs, digital video recorders, and satellite TV boxes. Basically, any device that can change channels is considered a tuner.

## Video connectors

The first step for connecting video is determining what type of output connectors your video device has. If there is more than one output, select the one with the highest quality. The best quality ranking, with 1 being the highest, is:

- 1 HDMI or MI-DA/DVI (both are digital inputs)
- 2 component RGB video (RCAs)
- 3 S-video
- 4 composite video (RCA)

If your device has a VGA connector, you can use an optional MI-DA/DVI connector for a high quality image. You can use the included MI-DA to HDMI adapter to connect a second HDMI source.

For detailed information on supported video formats, see page 30.

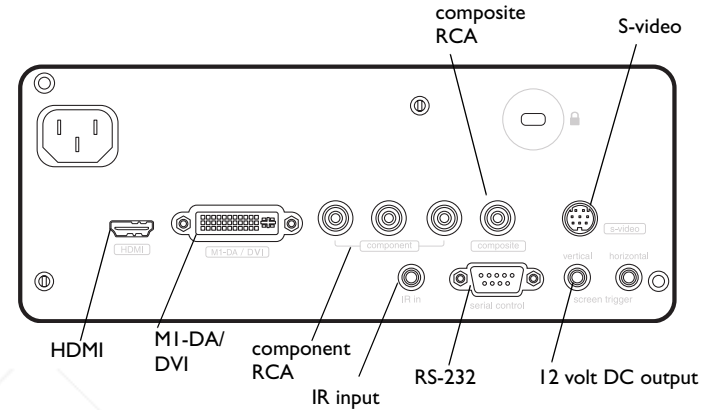

## Digital connections

The MI-DA/DVI and HDMI (High-Definition Multimedia Interface) connectors are digital and yield the highest quality image. It is common for these signals to be encrypted with HDCP (high-bandwidth digital-content protection). Your new projector ships standard with decryption codes so you can enjoy these high quality, all digital images.

This projector features the MI-DA connector, which has the following advantages:

- allows connection to a second DVI source
- allows connection to second component source
- allows connection to an analog computer source (VGA)
- has output pins that can power accessories.

This is an HDTV (High Definition Television) monitor, meaning it has vertical scanning lines of 720 progressive, 1080 interlaced or higher.

## HDMI 1.3 connection

HDMI is a standard, uncompressed, all-digital audio/video interface. HDMI provides an interface between sources, such as set-top boxes, DVD players, and receivers and your projector. Plug an HDMI cable into the video-out connector on the video device and into the **HDMI** connector on the projector.

To take advantage of HDMI 1.3 Deep Color (30 bit) you must have a 1.3-compatible source.

Note that the projector has no audio capabilities, so audio signals transferred through HDMI will not be audible.

## DVI connection

If your video device uses a DVI connector, plug the DVI end of an MI-DA cable into the video-out connector on the video device. This connector may be labeled "To Monitor" on the video device. Plug the MI-DA end of the cable into the **MI-DA/DVI** connector on the projector.

## Component (RCA) connection

If your device uses component connectors, plug a component video cable with red, green, and blue RCA connectors into the source device's component connectors and the **Component** connectors on the projector.

## S-video connection

If your video device uses a round, four-prong S-video connector, plug the S-video cable into the S-video connector on your video device and into the **S-video** connector on the projector.

## Composite (RCA) video connection

Plug the composite video cable's yellow connector into the video-out connector on the video device. Plug the other yellow connector into the yellow **Composite** connector on the projector.

## Computer connections

You can connect a computer's VGA connector to the **MI-DA/DVI** input on the projector using an MI-A cable.

## RS-232 connections

You can control the projector from an LCD control panel or computer by connecting an RS-232 cable to the projector's **Serial control** connector. Specific RS-232 commands can be found in the Service section of our website at [www.info-cus.com/support](http://www.info-cus.com/support).

## Displaying an image

Connect the power cord to the **Power** connector on the back of the projector and to your electrical outlet.

**NOTE:** Always use the power cord that shipped with the projector.

Press the **Power** button on the remote.

The Power light on the Status Indicator Panel blinks green and the fans start to run. When the lamp comes on, the start up screen displays and the Power light is solid green. It can take a minute for the image to achieve full brightness.

**? No start up screen?** Get help on page 12.

Plug in, connect, and turn on your video device.

The video source's image should appear on the projection screen. If it doesn't, press the **Source** button on the remote until the image appears.

**? No image?** Try pressing the **Auto Image** button on the remote. Get help on page 12.

## Adjusting the image

Adjust the height of the image by tilting the projector up or down, either using the base or the ceiling mount.

Position the projector the desired distance from the screen at a 90 degree angle to the screen.

See page 5 for a table listing screen sizes and distances to the screen.

plug in Power cord

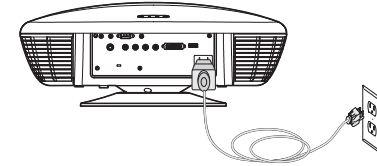

press Power button



turn on video device

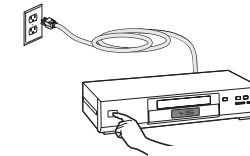

adjust height

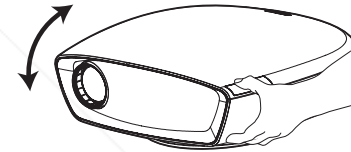

Adjust the zoom and focus.

adjust zoom and focus

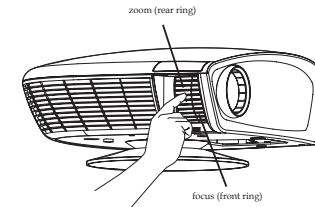

If the image is not square, adjust the keystone using the Picture menu. See page 20 for details.

adjust keystone

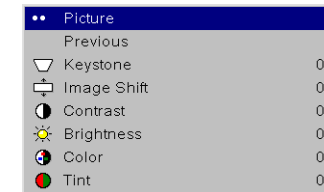
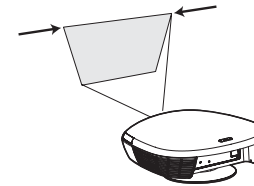

Adjust the volume on your stereo receiver.

adjust volume



Your projector has been factory optimized for very good performance no matter what the source. However, if you wish to make further changes you can optimize the image using onscreen menus. Adjust the Contrast, Brightness, Color, Tint, or Aspect Ratio in the Picture menu. See page 20 for help with the menus and these adjustments.

adjust Picture menu options including Aspect Ratio

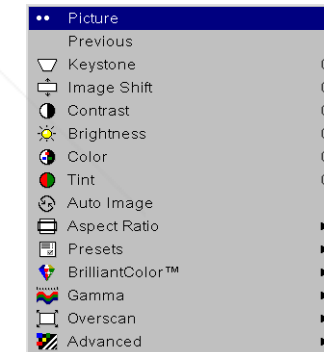

For Aspect Ratio, keep in mind that DVD players must be configured for 16:9 in order to view the highest quality image. For more information regarding Aspect Ratio, see page 6.

## Shutting down the projector

### Power Save

The projector also has a Power Save feature that automatically turns the lamp off after no active sources are detected and no user interaction with the projector is performed for 20 minutes. By default, this feature is on. See page 24.

### Sleep Timer

The projector also has a sleep timer feature that automatically turns the projector off after 4 hours. See page 24.

### Turning off the projector

Press the **Power** button on the remote to turn the projector off. The lamp turns off and the Power light on the Status Indicator Panel blinks amber for one (1) minute while the fans continue to run to cool the lamp. While the light is blinking, the projector does not accept any keypad and remote control input. When the lamp has cooled, the Power light is solid amber.





## Troubleshooting your setup

If your image appears correctly on the screen, skip to the next section. If it does not, troubleshoot the setup.



The Status Indicator Panel on top of the projector indicates the state of the projector and can help you troubleshoot.



**Table 2: Status indicator light behavior and meaning**

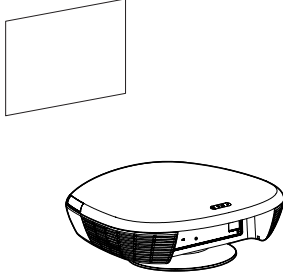
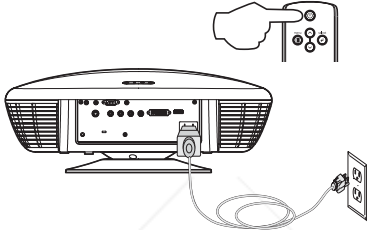
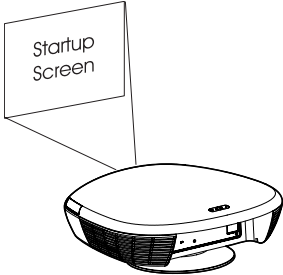
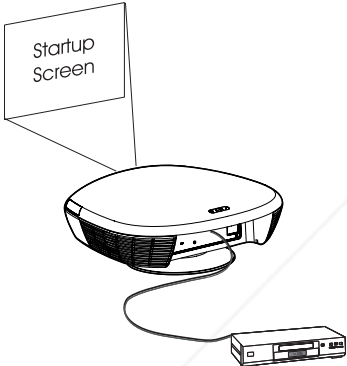

Status Indicator	Meaning
Power, green 	Powering up or powered up Solid: the lamp is on and an image is displayed. Blinking: the projector is powering up.
Power, amber 	Powering down or powered down Solid: the lamp is off and the projector is in standby. Blinking: the projector is powering down and the fans are running to cool the lamp.
Temperature 	The projector is too hot. Make sure the vents aren't blocked. Turn off the projector and wait one minute, then turn the projector on again. Contact Technical Support if the problem persists.
Lamp 	Turn off the projector and wait one minute, then turn the projector on again. If the lamp light turns on again, replace the lamp and reset the lamp timer.
Service 	Turn off the projector and wait one minute, then turn the projector on again. If the service lamp turns on again, service is required. Visit <a href="http://www.infocus.com/service">www.infocus.com/service</a> to contact Service.

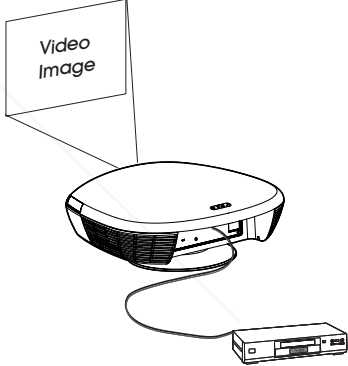

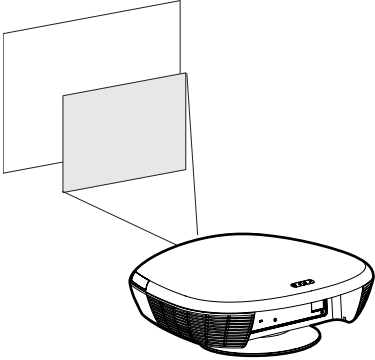
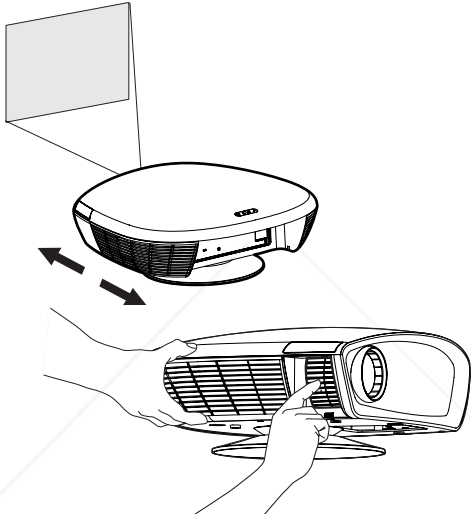
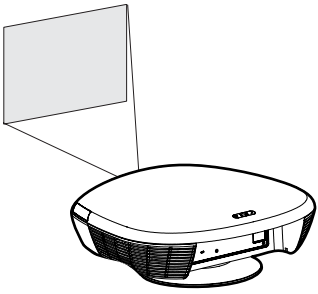
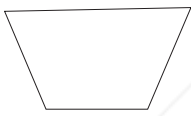
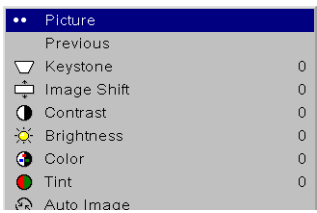

The following tables show common problems. In some cases, more than one possible solution is provided. Try the solutions in the order they are presented. When the problem is solved, you can skip the additional solutions.

Problem	Solution	Result
<p data-bbox="239 399 449 423">no start up screen</p> 	<p data-bbox="848 396 1255 448">plug power cord in back of projector press power button on remote</p> 	<p data-bbox="1365 399 1524 423">correct image</p> 
<p data-bbox="239 781 558 805">only start up screen appears</p> 	<p data-bbox="848 781 1094 805">connect active source</p> <p data-bbox="848 846 1115 870">press the Source button </p>	<p data-bbox="1365 776 1556 800">image projected</p> 



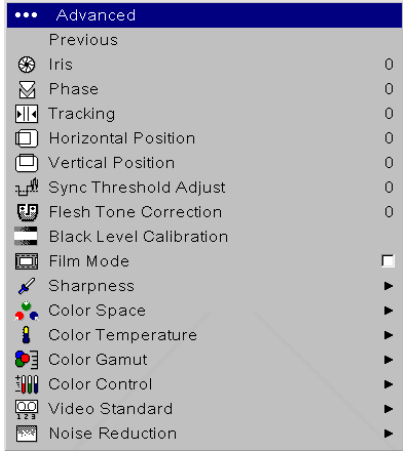

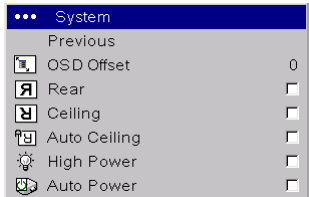

 FixYourDLP.com  
Sponsored by 

**Discount-Merchant.com (800) 281-8860**  
THE TRUSTED SOURCE FOR PROJECTOR LAMPS AND ACCESSORIES

Problem	Solution	Result
<p><b>image not centered on screen</b></p> 	<p><b>move projector, adjust zoom, adjust height</b></p> 	<p><b>correct image</b></p> 
<p><b>image not square</b></p> 	<p><b>Adjust Keystone in Picture menu. If using in tabletop mode, tilt the projector up or down.</b></p> 	<p><b>square image</b></p> 

<p><b>image not sharp</b></p> 	<p><b>Adjust focus or adjust Sharpness in the Picture&gt;Advanced menu</b></p> 	<p><b>correct image</b></p> 
<p><b>image upside down</b></p> 	<p><b>turn off ceiling in Settings&gt;System menu</b></p> 	<p><b>correct image</b></p> 

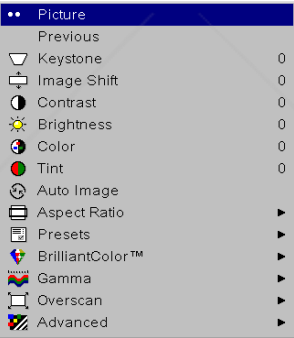

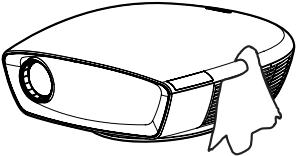
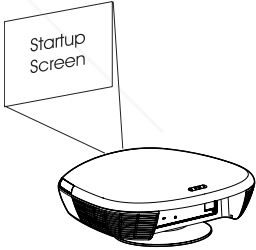
<p><b>image reversed left to right</b></p> 	<p><b>turn off rear in Settings&gt;System menu</b></p> 	<p><b>correct image</b></p> 
<p><b>projected colors don't match source</b></p> 	<p><b>adjust color, tint, color temperature, brightness, contrast in the menus. Verify cable connections.</b></p> 	<p><b>correct image</b></p> 
<p><b>lamp won't turn on, Temperature light is on</b></p> 	<p><b>make sure vents aren't blocked, turn off the projector and allow it to cool for one minute</b></p> 	<p><b>lamp turns on</b></p> 

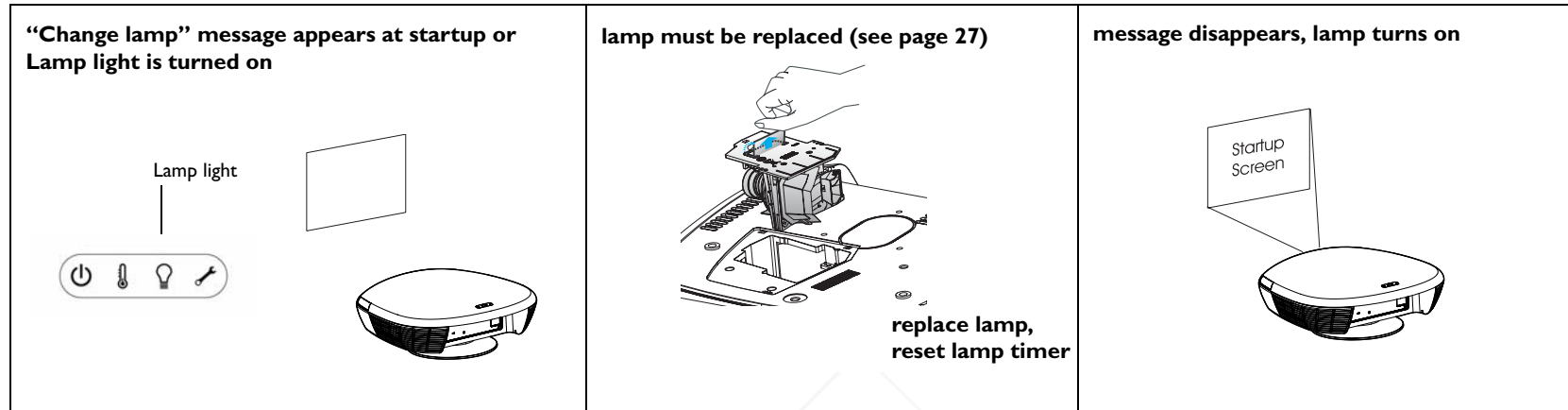

**Still need assistance?**

If you need assistance, visit our website at [www.infocus.com](http://www.infocus.com) or call us. This product is backed by a limited warranty. An extended warranty plan may be purchased from your retailer or dealer.

When sending the projector in for repair, we recommend shipping the unit in its original packing material, or having a professional packaging company pack the unit. Please insure your shipment for its full value.



**Discount-Merchant.com (800) 281-8860**  
**THE TRUSTED SOURCE FOR PROJECTOR LAMPS AND ACCESSORIES**

## Using the remote control

The remote uses two (2) AA batteries. They are easily installed by sliding the cover off the remote's back, aligning the + and - ends of the batteries, sliding them into place, and then replacing the cover.

To operate, point the remote at the projection screen or at the front of the projector (not at the video device or computer). The range of optimum operation is up to 30 feet (9.14m).

Press the remote's **Menu** button to open the projector's menu system. Use the arrow buttons to navigate, and the **Select** button to select features and adjust values in the menus. See page 19 for more info on the menus.

The remote also has:

- **Power** button to turn the projector on and off (see page 11 for shutdown info)
- backlight button to light the remote's buttons in the dark
- **Source** buttons to switch among sources (to assign a particular source to a source button, see page 24) and a source toggle
- **Resize** button to change the Aspect Ratio (see page 20)
- **Auto Image** button to resynch the projector to the source
- **Preset** button to select stored settings (see page 21)
- **Overscan** button to remove noise at the edge of a video image (page 21)
- **Custom** button that can be assigned to a special function, like Blank Screen or Freeze (see page 25).
- **Backlight/Flashlight** button on the underside of the remote. Press this button once to light up the remote, press and hold it to turn on the flashlight.

### Troubleshooting the remote

- Make sure the batteries are installed in the proper orientation and are not dead.
- Make sure you're pointing the remote at the front of the projector or at the screen, not at the video device or the computer, and are within the remote range of 30 feet (9.14m).

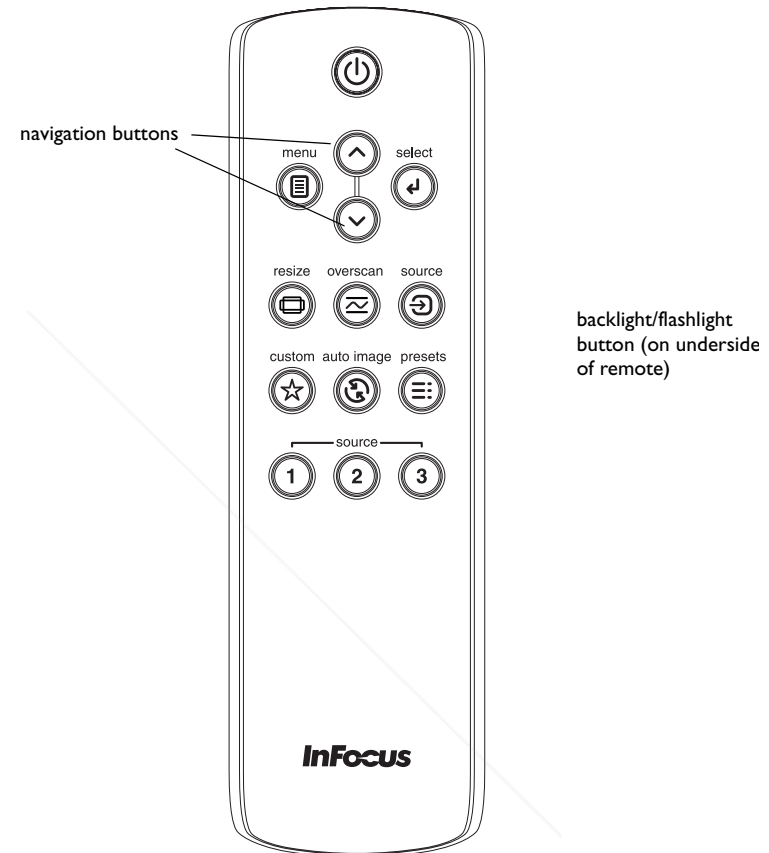

## Optimizing video images

Your projector has been factory optimized for excellent performance no matter what the source. However, if you wish to make further changes you can optimize the image using onscreen menus. For general information on using the menus, see page 19.

- Adjust the Keystone, Contrast, Brightness, Color, or Tint in the Picture menu (page 20).
- Select a Sharpness setting (page 22).
- Use the Color Control to adjust the color gain and offset (page 23).
- Adjust the Color Temperature. Select a listed value (page 23).
- Turn on Overscan to remove noise on the edges of the video image (page 21).
- Change the Aspect ratio (page 20). Aspect ratio is the ratio of the image width to image height. TV screens are usually 1.33:1, also known as 4:3. HDTV and most DVDs are 1.78:1, or 16:9 (the projector's default). Choose the option that best fits your input source in the menus, or press the **Resize** button on the remote to cycle through the options. See page 17.
- Select a specific Color Space. See page 22.
- Select a different Video Standard. Auto tries to determine the standard of the incoming video. Select a different standard if necessary. See page 23.
- Make sure your DVD player is set for a 16:9 television. See your DVD player's user's guide for instructions.

## Customizing the projector

You can customize the projector for your specific setup and needs. See page 24 to page 26 for details on these features.

- For rear projection, turn rear mode on in the **Settings>System** menu.
- For ceiling mounted projection, the projector has an Auto Ceiling feature to invert the image (**Settings>System** menu).
- Turn the projector's display messages on and off.
- Turn on power saving features.
- Specify blank screen colors and start up logos.
- Specify the language viewed on the menus.
- Save settings for the active source as a preset.

## Using the menus

To open the menus, press the **Menu** button on the remote. (The menus automatically close after 60 seconds if no buttons are pressed.) The Main menu appears. Use the arrow buttons to move up and down to highlight the desired submenu, then press the **Select** button.

To change a menu setting, highlight it, press **Select**, then use the up and down arrow buttons to adjust the value, select an option using radio buttons, or turn the feature on or off using check boxes. Press **Select** to confirm your changes. Use the arrows to navigate to another setting. When your adjustments are complete, navigate to Previous or Exit, then press **Select** to go to the previous menu; press the **Menu** button at any time to close the menus.

Dots appear before the menu name. The number of dots indicate menu's level, ranging from one (the Main menu) to four (the most nested menus).

The menus are grouped by usage:

- The Picture menu provides image adjustments.
- The Settings menu provides set-up type adjustments that are not changed often.
- The Source Info menu provides a read-only display of information about the projector and source.

Certain menu items may not be visible or may be grayed depending upon a particular source being connected. Differences are also seen in analog versus digital video sources and interlaced versus progressive sources.

Menu options are grayed out only if the source is selected but no signal is present. For example, if the projector is set to a video source but the source, such as a DVD player, is turned off video menu options are grayed out.

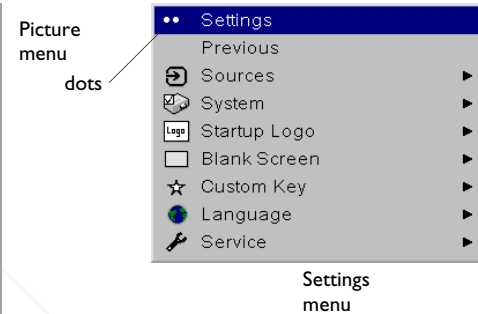
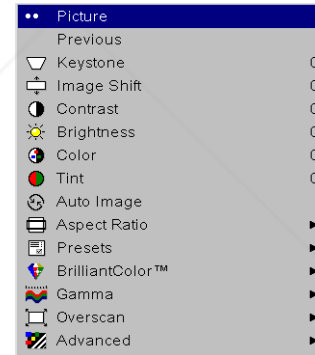
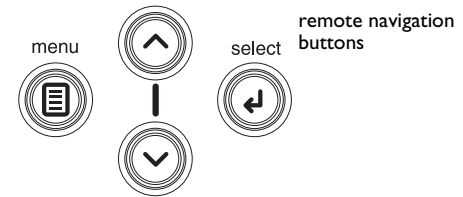
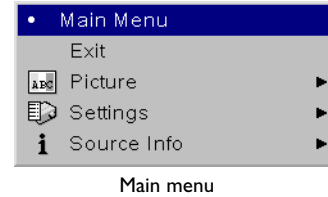

## Picture menu

To adjust the following settings, highlight the setting, press **Select**, use the up and down arrows to adjust the values, then press **Select** to confirm the changes.

**Keystone:** adjusts the image vertically and makes a squarer image. Tilt the projector up or down to adjust for keystone before using the digital keystone correction in the menu.

**Image Shift:** moves the image vertically. Use to shift the image, or to mask artifacts or bars on the top or bottom of the image.

**Contrast:** controls the degree of difference between the lightest and darkest parts of the picture.

**Brightness:** changes the intensity of the image.

**Color:** adjusts a video image from black and white to fully saturated color.

**Tint:** adjusts the red-green color balance in the image of NTSC video images. The tint setting applies to NTSC video sources only.

**Auto Image:** resynchs the projector to the source.

**Aspect Ratio:** Aspect ratio is the ratio of the image width to image height. HDTV and most DVDs are 16:9. TV screens are usually 4:3. The projector's default is 16:9. See "Choosing the aspect ratio" on page 6 for more information.

Select Native to see the unmodified input with no resizing by the projector. Select 16:9 to watch enhanced widescreen DVDs. Select Letterbox to preserve the 16:9 aspect ratio. If you have a 16:9 source and screen, the image fills the screen. If your source is letterboxed, the image is expanded to fill the screen. Select Natural Wide to stretch a 4:3 image to fill the entire 16:9 screen. The center two-thirds of the image is unchanged; the edges of the image are stretched. For more information regarding Aspect Ratio, see page 6.

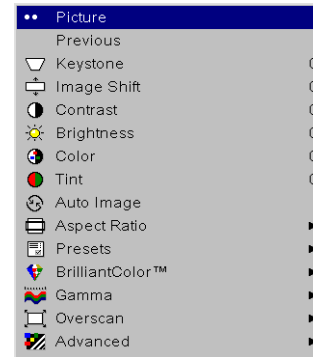

Picture menu

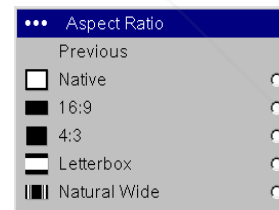
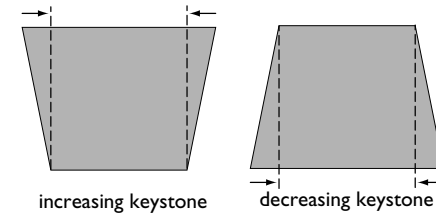

Aspect ratio

**Presets:** This allows you to customize settings and save the settings to be restored later. To restore the factory default settings, choose Factory Reset in the **Settings>Service** menu.

To set a preset for the current source, adjust the image, select **Save Settings** in the Presets menu, then choose Save User 1, 2, or 3. You can recall these settings in the future by selecting the appropriate user presets. All settings in the Picture menu (except Keystone) are saved and recalled. **ISF Day** and **ISF Night** settings support certified Imaging Science Inc. calibration. ISF presets are not available until after calibration is performed, and picture settings cannot be adjusted when ISF presets are active. For more information go to [www.infocus.com/service](http://www.infocus.com/service).

**BrilliantColor™:** produces an expanded on-screen color spectrum that delivers enhanced color saturation for bright, true-to-life images. This feature is off by default.

**Gamma:** Gamma tables contain preset intensity configurations optimized for the input source. You can select a gamma table that has been specifically tuned for either film, CRT (Cathode Ray Tube), video, PC, or Bright Room input. (Film input is material originally captured on a film camera, like a movie; video input is material originally captured on a video camera, like a TV show or sporting event.)

**NOTE:** Your viewing preferences may vary. Cycle through the gamma options and pick the one you like the best.

**Overscan:** removes noise around the edges of the video image. Select Zoom to remove the outer 3% of the image and scale the image back up to its original size. Select Crop to remove the outer 3% of the image without rescaling the image.

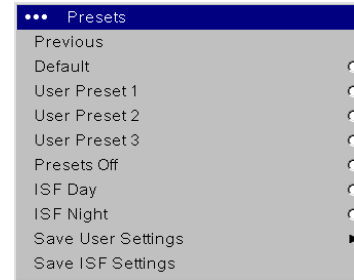

Presets

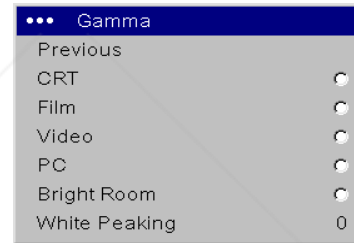
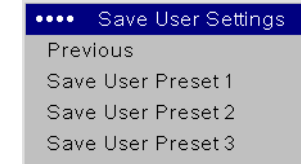

Gamma

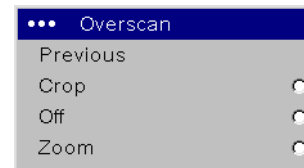

Overscan

### Advanced menu

Remember that not all options in the menus are available for all sources/signals.

**Iris:** adjusts the aperture of the iris from 0 to 100 (fully open) to regulate the amount of light emitting from the projector. Close the aperture to increase the contrast in dark images.

**Phase:** adjusts the horizontal phase of a computer source.

**Tracking:** adjusts the vertical scan of a computer source.

**Horizontal/Vertical Position:** adjusts the position of a computer source.

**Sync Threshold Adjust:** (progressive signals only) If a hardware device, such as a DVD player, is not syncing properly with the projector, adjust this option to help it to sync when connected to the projector.

**Flesh Tone Correction:** this modifies colors to make the skin complexion better.

**Black Level Calibration:** Automatically adjusts brightness to get the best black level. Before using, make sure there are black bars at the top, bottom, or sides of the image.

**Film Mode:** controls deinterlacing and is On by default. When checked, it assumes the incoming signal is film material and optimizes the image accordingly.

**Sharpness:** (video sources only) changes the clarity of the edges of a video image. Select a sharpness setting.

**Color Space:** This option applies to computer and component video sources. It allows you to select a color space that has been specifically tuned for the input signal. When Auto is selected, the projector automatically determines the standard. To choose a different setting, turn off Auto, then choose RGB for computer sources, choose either REC709 or REC601 for component video sources.

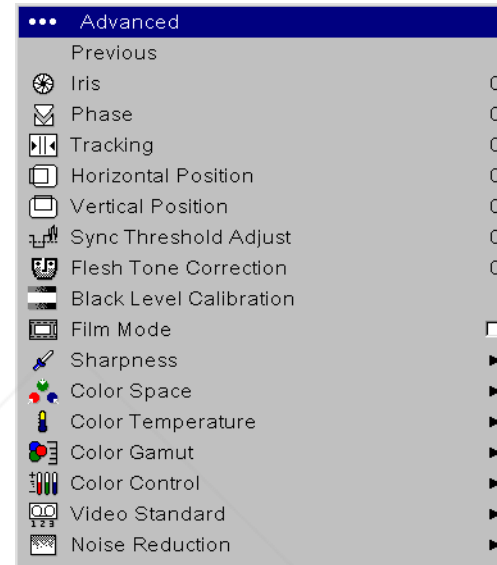

Advanced menu



Sharpness

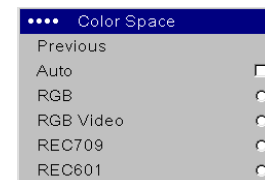

Color Space



**Color Temperature:** changes the intensity of the colors. Select a value. Native means an uncorrected/unchanged color temperature. Other values change the white point of the colors. 6500K (the default setting) is generally used for film content and 9300K is used for TV video.

**Color Gamut:** sets the total number of possible displayable colors (gamut). Choose Auto to have the projector select automatically based on the current signal format. Choose Maximum to display all colors that the projector is capable of displaying.

**Color Control:** allows you to individually adjust the gain and offset of the red, green, and blue colors. These advanced controls have the same effect as contrast and brightness, but each controls a single color only.

**Video Standard:** when it is set to Auto, the projector attempts to automatically pick the video standard based on the input signal it receives. (The video standard options may vary depending on your region of the world.) If the projector is unable to detect the correct standard, the colors may not look right or the image may appear “torn.” If this happens, manually select a video standard by selecting NTSC, PAL, or SECAM from the Video Standard menu.

**Noise Reduction:** adjusts signal noise reduction. Choose Enable then adjust the level. The software determines the differences between successive image frames and averages the changes out to reduce the noise.

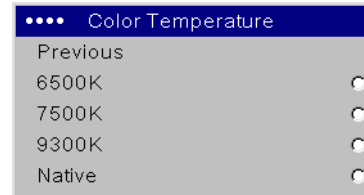

Color Temperature



Color Control

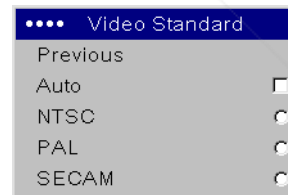

Video Standard

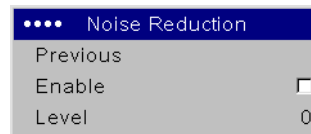

Noise Reduction

## Settings menu

**Sources:** allows programming of source buttons, enables autosource, and enables the SCART RGB source. When **Autosource** is selected, the **Source Enable** feature indicates which sources the projector attempts to lock onto. You can use the Source Enable feature to eliminate certain sources from this search, which will speed the search. By default, the check boxes for all sources are checked except SCART RGB. Uncheck a source box to eliminate it from the search. When Autosource is not checked, the projector defaults to Component initially, then defaults to whatever the last active source was when the projector was powered down. To display another source, you must manually select one by pressing the **Source** button on the remote. This cycles through all the sources that are selected in the Source Enable menu.

The Source 1, 2, and 3 menus in the Sources menu allow you to assign a source to the Source 1, 2, and 3 buttons on the remote. The Source 4 menu selection would apply to the Custom key if that option is chosen in the Custom key menu, see page 25. To use the SCART RGB source, you must first select it in the Source Enable menu (the projector cannot automatically detect this source). Enabling SCART will disable Component and Composite sources.

**System>OSD Offset:** allows you to adjust the position of the OSD. By default, the menus are postponed in the upper lefthand corner of the displayed image and the messages are postponed in the lower lefthand corner. Adjust the offset to move these items more to the right and middle of the display. **Rear:** reverses the image so you can project from behind a translucent screen. **Ceiling:** turns the image upside down for ceiling-mounted projection. **Auto Ceiling:** uses an internal sensor to automatically turn on ceiling mount mode if the projector is inverted. **High Power:** maximizes the light output of the lamp. **Auto Power:** When Auto Power is checked, the projector automatically goes into the startup state after the projector receives power. This allows control of ceiling mounted projectors with a wall power switch.

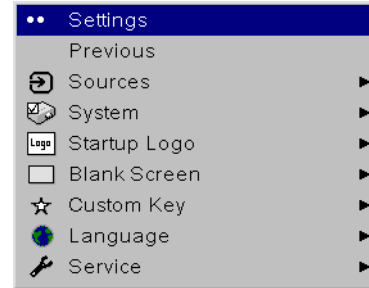

Settings menu

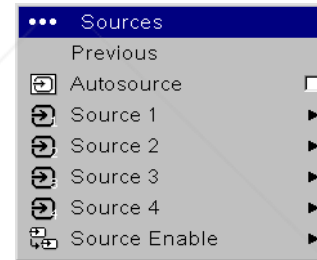

Sources

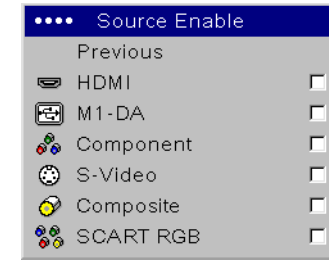

Source Enable

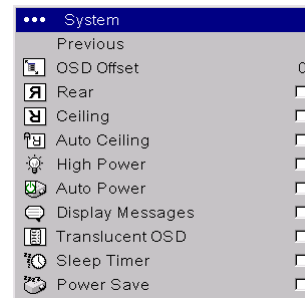

System menu

**Display Messages:** displays status messages (such as “Searching”) in the lower-left corner of the screen. **Translucent OSD (On Screen Display):** makes the menus while you are making image adjustments. **Sleep Timer:** automatically turns off the projector after 4 hours. **Power Save:** automatically turns the lamp off after no signals are detected for 20 minutes. After 10 additional minutes with no signal, the projector powers down. If an active signal is received before the projector powers down, the image is displayed.

**Startup Logo:** allows you to display a blank screen instead of the default screen at startup.

**Blank Screen:** determines what color is displayed when you select Blank Screen in the Startup Logo menu and when no source is displayed.

**Language:** allows you to select a language for the onscreen display.

**Custom key:** allows you to assign a different function to the Custom key on the remote, allowing you to quickly and easily use that function. Highlight an effect and press **Select** to choose a different one.

- **Blank Screen:** displays a solid blank image.
- **Freeze:** takes a snapshot of the projected image. If you’re watching video, the source video continues to run but the image is frozen.
- **Source Info:** the default effect. It opens a window with projector and source information.
- **Service Info:** opens the Service info window.
- **Source 4:** selects source 4 (by default, Source 4 is the Composite input). This gives you 4 direct source options on the remote. See page 24.



Startup Logo

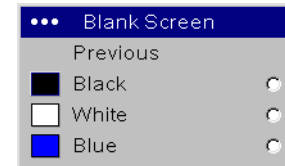

Blank Screen

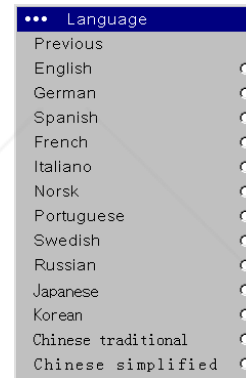

Language menu

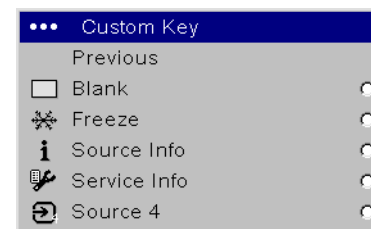

Custom Key

**Service:** To use these features, highlight them and press **Select**.

**Factory Reset:** restores all settings to their default.

**Reset Lamp hours:** resets the lamp hours used counter in the Service Info menu to zero. Do this only after changing the lamp.

**Test Pattern:** displays a test pattern. To display test patterns, first you must assign Blank Screen to the Custom key (page 25), then click the Test pattern check box in the Service menu to turn the option on, exit the menus, then press the **Custom** button on the remote. To select the patterns, use the up/down arrows on the remote. To exit the test patterns, press the **Custom** button.

**Blue Only:** turns off the Red and Green portions of the input, allowing you to properly adjust the color balance with a SMPTE color bar pattern.

**HDMI DDC:** turns the EDID extension on and off. Some graphic cards cannot recognize the projector's EDID. By default, the extensions are on (checkboxes are checked). Change these settings if you have trouble using HDMI or DVI sources.

**Serial Port:** allows you to select the baud rate to accommodate some older, slower external control systems.

**Service Info:** provides information about the projector's software, serial number, and lamp.

**Service Code:** only used by authorized service personnel.

**Source Info:** provides information about the active source.

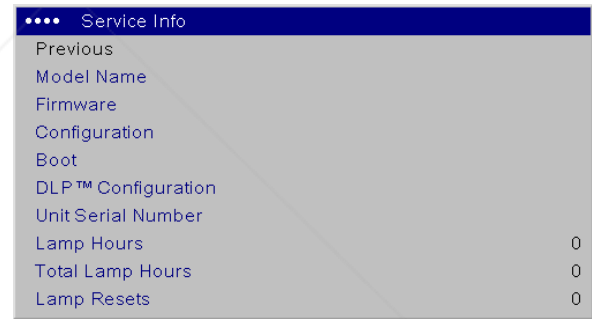
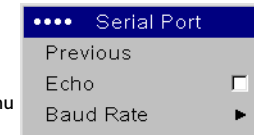
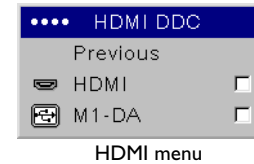
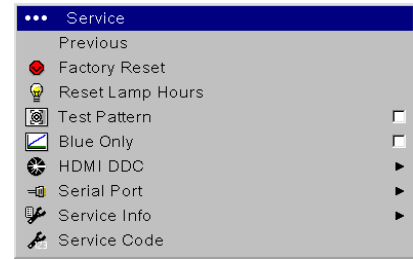

## Maintenance

### Replacing the projection lamp

The lamp hours timer in the Service Info menu counts the number of hours the lamp has been in use. Twenty hours before the lamp life expires, a message appears on the screen at startup indicating that you should change the lamp. The LED on top of the projector also blinks red twice to indicate that the lamp should be changed.

**NOTE:** You can order new lamp housings from [www.infocus.com](http://www.infocus.com) (in select areas), your retailer or your dealer. Use only a replacement lamp with the same type and rating as the original lamp.

#### WARNING:

To avoid burns, allow the projector to cool for at least 60 minutes before you replace the lamp.

Be extremely careful when removing the lamp housing. In the unlikely event that the bulb ruptures, small glass fragments may be generated. The lamp housing is designed to contain these fragments, but use caution when removing the lamp housing. Before replacing the lamp, clean the lamp compartment and dispose of cleaning materials. Wash hands after lamp replacement.

Hg – Lamp contains mercury. Manage in accordance with local disposal laws. See [www.lamprecycle.org](http://www.lamprecycle.org).

- 1 Turn off the projector and unplug the power cord. If ceiling mounted, disconnect all cables and detach the projector from the ceiling mount.
- 2 Wait 60 minutes to allow the projector to cool thoroughly.
- 3 Turn the projector upside down on a soft cloth so that the lamp door is facing you. Remove the base or ceiling mount plate, if attached.



turn off and unplug projector



wait 60 minutes

- 4 Loosen the two captive screws on the lamp door and lift the door off.
- 5 Loosen the two captive screws that attach the lamp housing to the projector.
- 6 Carefully remove the lamp housing. Dispose of the lamp in an environmentally proper manner.
- 7 Install the new lamp housing and tighten the screws.
- 8 Replace the lamp door.
- 9 Replace the base or ceiling mount plate, if necessary.
- 10 Plug in the power cord and press the **Power** button on the remote to turn the projector back on.
- 11 To reset the lamp hour timer, navigate to the **Settings>Service** menu and select **Reset Lamp Hours**. See page 26 for details.

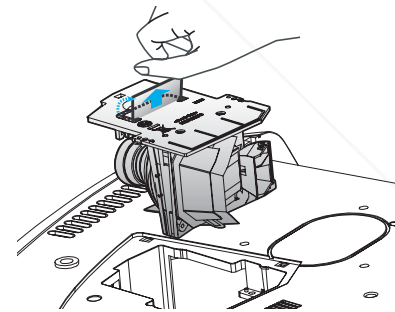
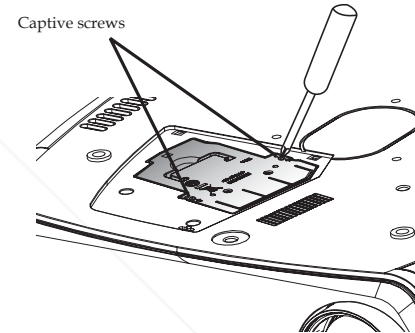
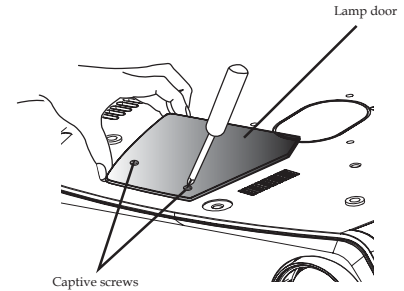
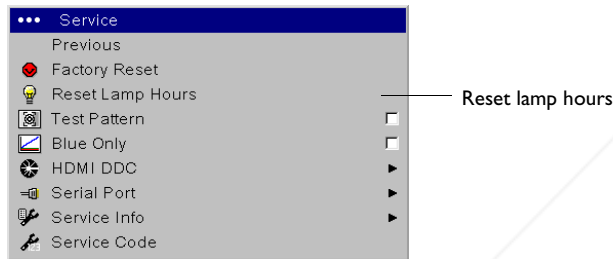

## Appendix

### Remote control discrete codes

You can use these codes to program another remote to learn the projector's remote functions.

To activate discrete mode, press and hold the **Custom** button on the remote for 10 seconds. The back light blinks twice when discrete mode is entered. The remote buttons are now remapped to new functions as listed below. To return to normal remote mode, press and hold the **Custom** button on the remote for 10 seconds. The remote also returns to normal mode automatically if no activity is detected for 2 minutes.

Function	Description	Remote button
Power off	turns power off	Nav Up
Power on	turns power on	Nav Down
Native resize	selects Native resize	resize
16:9 resize	selects 16:9 resize	overscan
4:3 resize	selects 4:3 resize	source
Letterbox resize	selects letterbox resize	custom
Natural wide resize	selects natural wide resize	auto image
User preset 1	selects user preset 1	Source 1
User preset 2	selects user preset 2	Source 2
User preset 3	selects user preset 3	Source 3

### Projector dimensions for ceiling mount installations

All values in millimeters (mm).

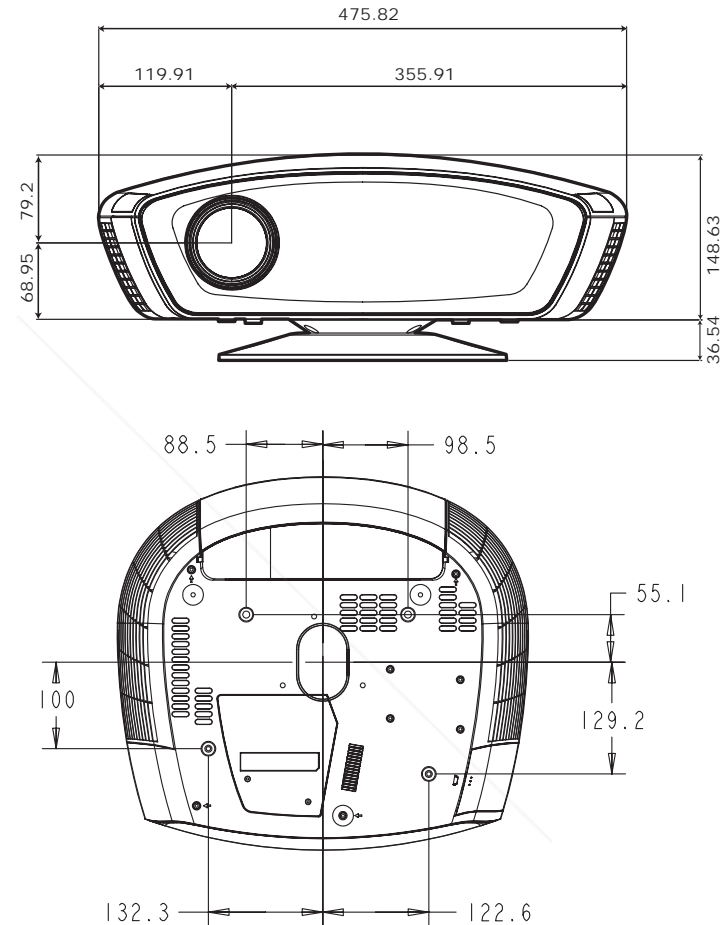

## Supported video formats

Connector	Signal Type	Supported formats
HDMI	Digital RGB and YCrCb (HDCP or non-HDCP)	1080p/24Hz 1080p/50Hz 1080p/60Hz
M1-DA	Digital RGB video via M1-to-DVI cable (HDCP or non-HDCP)	1080i/50Hz/60Hz 1080i/50Hz (Australia)
	Analog RGB video via M1-to-VESA cable	720p/50Hz/60Hz
	YPrPb video via M1-to-Component adapter	576i/p/50Hz/60Hz 480i/p/50Hz/60Hz
	Analog Computer via M1-to-VESA cable	All industry-standard analog and digital computer formats conforming to VESA standards
	Digital Computer via M1-to-DVI cable	
Component	YPrPb	1080p/24Hz 1080p/50Hz 1080p/60Hz 1080i/50Hz/60Hz 1080i/50Hz (Australia) 720p/50Hz/60Hz 576i/p/50Hz/60Hz 480i/p/50Hz/60Hz
Composite	Standard definition TV composite video sources	NTSC: M, 4.43 PAL: B,G,H,I,M,N SECAM: M
S-video	S-VHS Y/C	



## RS-232 terminal Product Interface specifications

### Communication configuration

To control the projector from an LCD control panel, connect an RS-232 cable to the serial control connector on the projector and set your computer's serial port settings to match this communication configuration:

Setting	Value
Bits per second	115,200
Data bits	8
Parity	None
Stop bits	1
Flow control	None
Emulation	VT100

### Command format

All commands consist of 3 alpha characters followed by a request, all enclosed in "greater than" and "less than" signs. The request can be a read request (indicated by a "?") or a write request (indicated by 1 to 4 ASCII digits).

A read request format: <AAA?> where

- < starts the command
- AAA denotes the command
- ? denotes the read request
- > ends the command

A write request example: <AAA#####> where

- < starts the command
- AAA denotes the command
- ##### denotes the value to be written (leading zeros not necessary)
- > ends the command

Some commands have ranges, while others are absolute. If a number greater than the maximum range is received, it is automatically set to the maximum number for that function. With absolute settings, "0" is off, 1-9999 is on. The one exception is the Power command, where 0 is off and 1 is on.

Refer to the support section of our website for detailed information on the Product Interface formats.

### Supported commands

Function	Command	Range	Default
Aspect Ratio	ARZ	0-5 0 = Auto 1 = Native 2 = 4:3 3 = 16:9 4 = Letterbox 5 = Natural Wide	1
Auto Ceiling Enable	ACL	0-1	0
Auto Color Gamut Enable	AGA	0-1	1
Auto Color Space enable	ACS	0-1	1
Auto Image	AIM	0-1	0
Auto Power Enable	APO	0-1	0
Auto Source Enable	ASC	0-1	1
Auto Video Standard Enable	AVS	0-1	1
Black Level Calibration	BLC	0-100	0
Blank	BLK	0-1	0
Blank Screen Color	BSC	0-2 0 = black 1 = blue	0
Blue Gain	BCG	1-255	128
Blue Offset	BCO	1-255	128
Blue Only Enable	BOE	0-1	0
Boot Version	BVS	3	0
Brightness	BRT	0-100	128
BrilliantColor Look	BCL	0-2	0

Ceiling	CEL	0-1	0
Color	CLR	0-100	50
Color Coordinate Adjust Enable	CCA	0-1	1
Color Gamut Enable	CGC	22	0
Color Space	CSM	0-2 0 = RGB 3 = REC709 2 = REC601	0
Color Temp	TMP	0-3 0 = 6500 1 = 7500 2 = 9300 3 = Native	0
Computer Advance	CAD	0-1	0
Configuration Version	CVS	3	0
Contrast	CON	0-100	128
Current Subsource	CRS	0-7	0
Custom Key Program	EFK	0-11	8
Display Messages Enable	DMG	0-1	1
Echo Received Char 1	EC1	0-1	0
Engine Version	EVS	77	0
Factory Reset (Write only)	RST	0-1	n/a
Film Mode Auto Detect	TTO	0-1	1
Film Mode Auto Detect	TTO	0-1	1
Firmware Version	FVS	3	0
Flash Mode Reset	FMR	0-1	0
Flesh Tone Correction	FTC	0-1	0
Freeze Enabled	FRZ	0-1	0

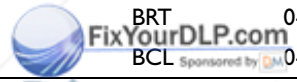

Gamma Table	GTB	0-8 2 = Video 3 = Film 5 = Bright Room 7 = CRT 8 = PC	3
Green Gain	GCG	0-100	128
Green Offset	GCO	0-100	128
HDMI DDC Enable 1	EE1	0-1	1
HDMI DDC Enable 3	EE3	0-1	1
High Power Enable	HPE	0-1	0
Horizontal Position	HPS	n/a	n/a
Illuminating State	LML	0-2	0
Iris	IRI	0-100	100
ISF Day Saved Status	IDS	0-2	0
ISF Night Saved Status	INS	0-2	0
Keycode Entry	KEY	0-70	0
Lamp Hours (Read only)	LMP	0-65535	0
Lamp Power	IPM	0-1	0
Lamp Power	IPM	0-1	0
Lamp Total Time On in hours for all bulbs	LMT	0-65535	0

Language	LAN	0-13 0 = English 1 = French 2 = German 3 = Italian 4 = Japanese 5 = Korean 6 = Norwegian 7 = Portuguese 8 = Russian 9 = Chinese Simplified 10 = Spanish 11 = Chinese Traditional	0
Logo Capture Compress	COM	0-1	0
Logo Capture Compression Progress Count	CPC	0-480	0
Logo Capture Enable	CAP	0-1	0
Menu Enable	MNU	0-1	0
Menu Navigation	NAV	0-4 1 = up 2 = down 3 = select	1
Model Name	MDL	4	0
Noise Reduction Level	NRL	8-248	128
Noise Reduction Mode	NRE	0-1 0 = Off 1 = Auto	0
Number of Lamp Resets	LMR	0-65535	0
Number of times unit has been turned on	O00	0-65535	0



**Discount-Merchant.com (800) 281-8860**  
 THE TRUSTED SOURCE FOR PROJECTOR LAMPS AND ACCESSORIES

Number of times unit has been turned on for at least 30 minutes	O30	0-65535	0	Red Offset	RCO	0-100	128
Number of times unit has been turned on for at least 60 minutes	O60	0-65535	0	Resolution String	RES	29	0
Number of times unit has been turned on for at least 90 minutes	O90	0-65535	0	Screen Trigger Enable	STE	0-1	1
Overscan	OVS	0-2	0	Sequence Version	SVS	3	0
Perform Lamp Reset	LRT	0-1	0	Serial 1 Baud Rate	BR1	4,7	7
Phase	MSS	0-100	50	Sharpness	SHP	0-4	2
PI Response String Enable	PRE	0-1	0	Sleep Timer	SLT	0-1	0
PI Verbose Enable	PVE	0-1	0	Source	SRC	0-5	0
PI Version	PVS	3	0	0 = HDMI			
Platform Name	PLA	10	0	1 = MI-DA			
Power Enable	PWR	0-1	0	2 = Component			
Power Save Enable	PSV	0-1	1	3 = S-Video			
Power-up Source	DSC	0-5	2	4 = Composite			
Preferred Aspect Ratio	PAR	1-7	7	5 = SCART RGB			
Presets	PST	0-9	0	Source 1 Program	SR1	0-5	0
		0 = default		Source 2 Program	SR2	0-5	2
		1 = User 1		Source 3 Program	SR3	0-5	3
		2 = User 2		Source 5 Program	SR4	0-5	3
		3 = User 3		Source Advance	SAD	0-1	0
		4 = Off		Source Enable 0	CE0	0-1	0
		8 = ISF Day		Source Enable 1	CE1	0-1	0
		9 = ISF Night		Source Enable 2	CE2	0-1	0
Rear Project	REA	0-1	0	Source Enable 3	CE3	0-1	0
Red Gain	RCG	0-100	128	Source Enable 4	CE4	0-1	0
				Source Enable 5	CE5	0-1	0
				Startup Logo	DSU	0-1	1
				Sync Threshold Adjust	STH	1-15	8
				System Error Code	ERR	0-7	0



System Power Enable	SPE	0-1	0	Vertical Keystone	DKV	0-100	50
System State	SYS	0-24	0	Vertical Position	VPS	0-100	50
Test Pattern Enable	TPE	0-1	0	Video Standard	VSU	0-9	0
Test Pattern Select	TPS	0-10, 15-21	0			0 = Auto	
Time in Hours Last Bulb1 Lasted	LB1	0-65535	0			1 = NTSC	
Time in Hours Last Bulb2 Lasted	LB2	0-65535	0	Video Advance	VAD	0-1	0
Time in Hours Last Bulb3 Lasted	LB3	0-65535	0	Vertical Image Shift	VIS	0-100	50
Time in minutes unit has been turned on	ONC	0-4294967295	0			2 = PAL	
Time in minutes unit is currently on	ONL	0-4294967295	0			5 = SECAM	
Time in minutes unit was previously turned on	ONP	0-4294967295	0				
Tint	TNT	2-98	50				
Total number of Strike Attempts	TSA	0-65535	0				
Total number of successful Strike Attempts	SSA	0-65535	0				
Tracking	MTS	0-100	50				
Translucent OSD	TOE	0-1	1				
Unit Part Number	UPN	8	0				
Unit Serial Number	USN	12	0				
User Preset 1 Saved Status	UPI	0-2	0				
User Preset 2 Saved Status	UP2	0-2	0				
User Preset 3 Saved Status	UP3	0-2	0				
Vertical Keystone	DKC	0-80	40				

FixYourDLP.com

Discount-Merchant.com (800) 281-8860  
 THE TRUSTED SOURCE FOR PROJECTOR LAMPS AND ACCESSORIES

## INDEX

### Numerics

12 volt outputs 4  
16x9 18

### A

Advanced menu 22  
aspect ratio 6, 20  
Auto Ceiling 24  
Auto Image 20  
Auto Power 24  
Autosource 24

### B

Black Level Calibration 22  
blank screen 25  
Brightness 20  
BrilliantColor 21

### C

cable box 7  
Ceiling 24  
CLI commands 32  
Color 20  
Color Control 23  
Color Gamut 23  
Color Space 22, 23  
Color Temperature 23  
command line interface commands 32  
component connector 8  
connecting  
    component 8  
    composite 8

computers 8  
digital components 7  
HDMI components 8  
RS-232 8  
S-video 8  
video device 7  
contacting InFocus 16  
Contrast 20  
Custom key 21  
customer service contact information 16  
customizing the projector 18

### D

digital connections 7  
dimensions of projector 29  
Display Messages 25  
DVDs 20  
DVI connector 4, 8

### F

Factory Reset 26  
Film mode 22  
Flesh tone correction 22  
focus 10

### G

gamma 21

## H

HDMI 4, 8, 26  
HDTV 7, 18, 20  
High Power 24  
Horizontal position 22

## I

image  
    adjusting 9  
    focus 10  
    size 5  
    zoom 10  
Image Shift 20

## K

keystone adjustment 10, 20

## L

lamp replacement 27  
Language 25  
LEDs 9, 11  
Letterbox 20  
logo 25

## M

maintaining the projector 27  
Menu button 19  
menu usage 19

## N

Noise reduction 23

## O

OSD Offset 24  
Overscan 21

## P

Phase 22  
Picture menu 20  
power cord 9  
Power Save 11, 25  
presets 21  
projection distance 5  
projector  
    connecting video devices 7  
    customization 18  
    dimensions 29  
    included items 3  
    maintenance 27  
    positioning 5  
    remote control 17  
    setting up 5  
    Status Indicator Panel 11  
    troubleshooting problems 11

## R

registering your projector 3  
remote control 17  
replacing the lamp 27  
RS-232  
    connecting 8  
    specifications 31

**S**

SCART 24  
screen triggers 4  
serial connection 8  
Service 26  
Service Code 26  
Service menu 26  
Settings menu 24  
sharpness 22  
Sleep Timer 25  
Source Enable 24  
Source Info 26  
Startup Logo 25  
Status Indicator Panel 11  
S-video connector 8  
Sync Threshold Adjust 22  
System menu 24

**T**

Tint 20  
Tracking 22  
Translucent OSD 25  
troubleshooting 11  
TV tuner 7

**V**

Vertical postion 22  
Video Standard 23  
volume adjustment 10

**Z**

zoom 10





# Disclaimer

This user manual is provided as a free service by FixYourDLP.com. FixYourDLP is in no way responsible for the content of this manual, nor do we guarantee its accuracy. FixYourDLP does not make any claim of copyright and all copyrights remain the property of their respective owners.

About FixYourDLP.com

FixYourDLP.com (<http://www.fixyourdpl.com>) is the World's #1 resource for media product news, reviews, do-it-yourself guides, and manuals.

Informational Blog: <http://www.fixyourdpl.com>

Video Guides: <http://www.fixyourdpl.com/guides>

User Forums: <http://www.fixyourdpl.com/forum>

FixYourDLP's Fight Against Counterfeit Lamps:

<http://www.fixyourdpl.com/counterfeits>

## Sponsors:

RecycleYourLamp.org – Free lamp recycling services for used lamps:

<http://www.recycleyourlamp.org>

Lamp Research - The trusted 3rd party lamp research company:

<http://www.lampresearch.com>

Discount-Merchant.com – The worlds largest lamp distributor:

<http://www.discount-merchant.com>



**FixYourDLP.com**

Sponsored by 