



# Disclaimer

This user manual is provided as a free service by FixYourDLP.com. FixYourDLP is in no way responsible for the content of this manual, nor do we guarantee its accuracy. FixYourDLP does not make any claim of copyright and all copyrights remain the property of their respective owners.

About FixYourDLP.com

FixYourDLP.com (<http://www.fixyourdpl.com>) is the World's #1 resource for media product news, reviews, do-it-yourself guides, and manuals.

Informational Blog: <http://www.fixyourdpl.com>

Video Guides: <http://www.fixyourdpl.com/guides>

User Forums: <http://www.fixyourdpl.com/forum>

FixYourDLP's Fight Against Counterfeit Lamps:

<http://www.fixyourdpl.com/counterfeits>

## Sponsors:

RecycleYourLamp.org – Free lamp recycling services for used lamps:

<http://www.recycleyourlamp.org>

Lamp Research - The trusted 3rd party lamp research company:

<http://www.lampresearch.com>

Discount-Merchant.com – The worlds largest lamp distributor:

<http://www.discount-merchant.com>



**FixYourDLP.com**

Sponsored by 

# TOSHIBA

## TDP-EW25 DATA PROJECTOR

---

### OWNER'S MANUAL

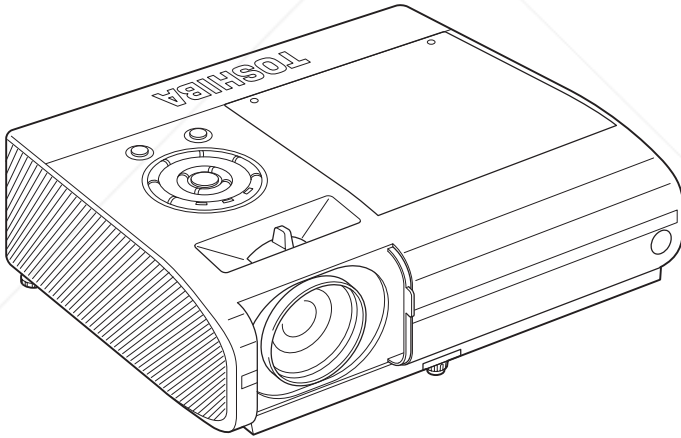

**Discount-Merchant.com (800) 281-8860**

**THE TRUSTED SOURCE FOR PROJECTOR LAMPS AND ACCESSORIES**

Before Using

Preparations

Operations

Maintenance

Others

# SAFETY PRECAUTIONS



The lightning flash with arrowhead symbol, within an equilateral triangle, is intended to alert the user to the presence of uninsulated "dangerous voltage" within the product's enclosure that may be of sufficient magnitude to constitute a risk of electric shock to persons.



The exclamation point within an equilateral triangle is intended to alert the user to the presence of important operating and maintenance (servicing) instructions in the literature accompanying the appliance.

**WARNING:** TO REDUCE THE RISK OF FIRE OR ELECTRIC SHOCK, DO NOT EXPOSE THIS APPLIANCE TO RAIN OR MOISTURE. DANGEROUS HIGH VOLTAGES ARE PRESENT INSIDE THE ENCLOSURE. DO NOT OPEN THE CABINET. REFER SERVICING TO QUALIFIED PERSONNEL ONLY.

**WARNING:** Handling the cord on this product or cords associated with accessories sold with this product, will expose you to lead, a chemical known to the State of California to cause birth defects or other reproductive harm. **Wash hands after handling.**

**WARNING:** Lamp contains mercury. Disposal of this product may be regulated due to environmental considerations. For disposal, reuse or recycling information, please contact your local government or the Electronic Industries Alliance at [www.eiae.org](http://www.eiae.org).

**MODEL NAME: TDP-EW25** **USA only**

TRADE NAME: DATA PROJECTOR	MODEL NAME: TDP-EW25
 Tested To Comply With FCC Standards	
FOR HOME OR OFFICE USE	

**FCC NOTICE:** This device complies with part 15 of the FCC Rules. Operation is subject to the following two conditions:

(1) This device may not cause harmful interference, and (2) this device must accept any interference received, including interference that may cause undesired operation.

This equipment has been tested and found to comply with the limits for a Class B digital device, pursuant to part 15 of the FCC Rules. These limits are designed to provide reasonable protection against harmful interference in a residential installation. This equipment generates, uses and can radiate radio frequency energy and, if not installed and used in accordance with the instructions, may cause harmful interference to radio communications.

However, there is no guarantee that interference will not occur in a particular installation. If this equipment does cause harmful interference to radio or television reception, which can be determined by turning the equipment off and on, the user is encouraged to try to correct the interference by one or more of the following measures:

- Reorient or relocate the receiving antenna.
- Increase the separation between the equipment and receiver.
- Connect the equipment into an outlet on a circuit different from that to which the receiver is connected.
- Consult the dealer or an experienced radio/TV technician for help.

RESPONSIBLE PARTY: TOSHIBA AMERICA INFORMATION SYSTEMS, INC.  
9740 Irvine Blvd., Irvine, CA 92618-1697 U.S.A  
Phone: (949) 583-3000

**WARNING:** Changes or modifications made to this equipment, not expressly approved by **USA only** Toshiba, or parties authorized by Toshiba, could void the user's authority to operate the equipment.

**Notice:** This Class B digital apparatus complies with Canadian ICES-003. Cet appareil numérique de la classe B est conforme à la norme NMB-003 du Canada. **CANADA only**



# IMPORTANT SAFETY INSTRUCTIONS

**CAUTION: PLEASE READ AND OBSERVE ALL WARNINGS AND INSTRUCTIONS GIVEN IN THIS OWNER'S MANUAL AND THOSE MARKED ON THE UNIT. RETAIN THIS BOOKLET FOR FUTURE REFERENCE.**

This unit is fully transistorized and does not contain any parts that can be repaired by the user.

**DO NOT REMOVE THE CABINET COVER, OR YOU MAY BE EXPOSED TO DANGEROUS VOLTAGE. REFER SERVICING TO QUALIFIED SERVICE PERSONNEL ONLY.**

## 1. Read Owner's Manual

After unpacking this product, read the owner's manual carefully, and follow all the operating and other instructions.



## 2. Power Sources

This product should be operated only from the type of power source which does not exceed the voltage range specified on the rating label and the power cord.

If you are not sure of the type of power supply to your home, consult your product dealer or local power company.



## 3. Source of Light

Do not look into the lens while the lamp is on. The strong light from the lamp may cause damage to your eyesight.

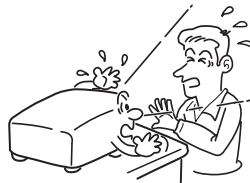

## 4. Ventilation

Openings in the cabinet are provided for ventilation and to ensure reliable operation of the product and to protect it from overheating, and these openings must not be blocked or covered. The openings should never be blocked by placing the product on a bed, sofa, rug or other similar surface. This product should not be placed in a built-in installation such as a bookcase or rack unless proper ventilation is provided.



Discount-Merchant.com (800) 281-8860  
THE TRUSTED SOURCE FOR PROJECTOR LAMPS AND ACCESSORIES



## 5. Heat

The product should be situated away from heat sources such as radiators, heat registers, stoves, or other products (including amplifiers) that produce heat.

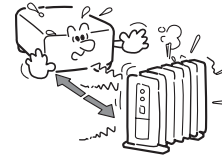

## 6. Water and Moisture

Do not use this product near water. - for example, near a bath tub, wash bowl, kitchen sink, or laundry tub; in a wet basement; or near a swimming pool and the like.

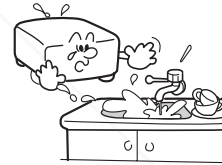

## 7. Cleaning

Unplug this product from the wall outlet before cleaning. Do not use liquid cleaners or aerosol cleaners. Use a soft cloth for cleaning.



## 8. Be sure that you firmly insert the plug into the wall outlet.

Incorrect or faulty connections may result in fire or electric shock. Avoid using an unsound or loose outlet.

## 9. Power-Cord Protection

Power-supply cords should be routed so that they are not likely to be walked on or pinched by items placed upon or against them, paying particular attention to cords at plugs, convenience receptacles, and the point where they exit from the product.



## 10. Overloading

Do not overload wall outlets; to reduce the risk of electric shock, do not use the polarized plug with an extension cord, receptacle, or other outlet unless the blades can be inserted completely with three-wire grounding type to prevent blade exposure. As this can result in a risk of fire or electric shock.





## IMPORTANT SAFETY INSTRUCTIONS (Continued)

### 11. Lightning storms

For added protection for this product during storm, or when it is left unattended and unused for long periods of time, unplug it from the wall outlet. This will prevent damage to the product due to lightning and power-line surges. However, while it is thundering or lightning, do not touch the apparatus and any connected cable and/or equipment. This will prevent you from receiving the electric shock by an electric surge.

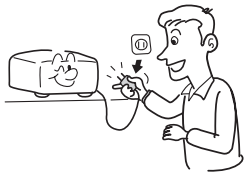

### 12. Object and Liquid Entry

Never push objects of any kind into this product through openings as they may touch dangerous voltage points or short-out parts that could result in a fire or electric shock. Never spill liquid of any kind on the product.



### 13. Do not place or keep the projector within the reach of the children.

It may fall down or tip over, which could result in severe injury.

### 14. Do not place the product vertically

Do not use the product in the upright position to project the pictures at the ceiling, or any other vertical positions. It may fall down and dangerous.

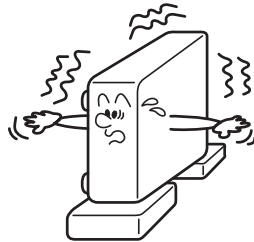

### 15. Stack Inhibited

Do not stack other equipment on this product or do not place this product on the other equipment. Top and bottom plates of this product develops heat and may give some undesirable damage to other unit.



### 16. Moving the projector

When carrying the projector, be sure to use the carrying handle to avoid any damage to the lens or main unit.

### 17. Attachments

Do not use attachments not recommended by product manufacturer as they may cause hazards.

### 18. Accessories

Do not place this product on an unstable cart, stand, tripod, bracket, or table. The product may fall, causing serious injury to a child or adult, and serious damage to the product. A product and cart combination should be moved with care. Quick stops, excessive force, and uneven surfaces may cause the product and cart combination to overturn.



### 19. Damage Requiring Service

Unplug this product from the wall outlet and refer servicing to qualified service personnel under the following conditions:

- When the power-supply cord or plug is damaged.
- If liquid has been spilled, or objects have fallen into the product.
- If the product has been exposed to rain or water.
- If the product does not operate normally by following the operating instructions. Adjust only those controls that are covered by the operating instructions as an improper adjustment of other controls may result in damage and will often require extensive work by a qualified technician to restore the product to its normal operation.
- If the product has been dropped or damaged in any way (If the cabinet should break, please handle with care to avoid injury).
- When the product exhibits a distinct change in performance - this indicates a need for service.



FixYourDLF.com

Sponsored by

Discount-Merchant.com (800) 281-8860

THE TRUSTED SOURCE FOR PROJECTOR LAMPS AND ACCESSORIES

## IMPORTANT SAFETY INSTRUCTIONS (Continued)

### 20. If glass components, including lens and lamp, should break, contact your dealer for repair service.

This product incorporates glass components, including a lens and a lamp. If such parts should break, please handle with care to avoid injury and contact your dealer for repair service. The broken pieces of glass may cause injury. In the unlikely event of the lamp rupturing, thoroughly clean the area around the projector and discard any edible items placed in that area.

### 21. Servicing

Do not attempt to service this product yourself as opening or removing covers may expose you to dangerous voltage or other hazards. Refer all servicing to qualified service personnel.



### 22. Replacement Parts

When replacement parts are required, be sure the service technician has used replacement parts specified by the manufacturer or have the same characteristics as the original part. Unauthorized substitutions may result in fire, electric shock, or other hazards. (Replacement of the lamp only should be made by users.)

### 23. Safety Check

Upon completion of any service or repairs to this product, ask the service technician to perform safety checks to determine that the product is in proper operating condition.



### 24. Do not leave thermal-paper documents or easily deformed items on top of the unit or near the air exhaust for long periods of time.

The heat from the unit could erase the information on the thermal paper, or cause deformation or warping.

### 25. Do not use the product in a closed installation state.

Do not place the product in a box or in any other closed installation state. Otherwise it may overheat. This could result in a risk of fire.

### 26. Do not look into the laser light source of the remote control or direct the laser pointer toward a person or a mirror.

The laser beam may cause damage to the eyesight.

### 27. When using a wireless LAN function:

- Do not use near people with heart pacemakers.
- Do not use near electronic medical equipment, or in hospitals or other medical institutions.
- Do not use inside aircraft or in places where the wireless LAN function could interfere with electromagnetic signals.

The electromagnetic interference could cause a malfunction, resulting in an accident.

### 28. If the use of a wireless LAN function interferes with another device's electromagnetic signals, cease use immediately.

The electromagnetic interference could cause a malfunction, resulting in an accident.





Discount-Merchant.com (800) 281-8860

THE TRUSTED SOURCE FOR PROJECTOR LAMPS AND ACCESSORIES

# POWER SUPPLY INFORMATION

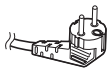
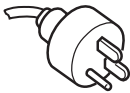
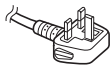
If your line voltage is 220 to 240V, use one of the following types of cable/plug.

Plug configuration	Plug type	Line voltage	Plug configuration	Plug type	Line voltage
	EURO	220 – 240V		Australian 240V 10A	200 – 240V
	UK	220 – 240V		Switzerland 240V 6A	200 – 240V
				North American 240V 15A	200 – 240V

Use a 5A fuse which is approved by ASTA or BSI to BS1362. Always replace the fuse cover after changing the fuse.

# IMPORTANT PRECAUTIONS

## Moisture Condensation

Never operate this unit immediately after moving it from a cold location to a warm location. When the unit is exposed to such a change in temperature, moisture may condense on the lens and the crucial internal parts. To prevent the unit from possible damage, do not use the unit for at least 2 hours when there is an extreme or sudden change in temperature.

## Place and Manner of Installation

- Do not place in hot locations, such as near heating equipment. Doing so could cause malfunction, and shorten the life of the projector.
- Avoid locations with oil or cigarette smoke. Doing so will dirty the optical parts, shortening their lives, and darkening the screen.
- Do not use this product in the upright position or tilt it up or down by more than 20° from level. Doing so may cause a failure or shorten the life of the product.
- Using this instrument near a TV or radio may cause interference to the images or audio sound. If this happens, move it away from the TV or radio.
- In a high altitude location where air is thin, cooling efficiency is reduced so use the projector with **[Fan mode]** set to **[High]**. [p.44](#)
- Only plug the power cord into outlets rated for use with the power cord's specified voltage range. Do not overload extension cords or table taps as this can result in fire or electric shock.
- Route the power cable or the connecting cable away from where people could trip over it. The projector may fall down, which could result in severe injury.
- Be sure the power cord is easily reached for unplugging in case of emergency. Do not place any obstacles near a wall outlet in which the cord is plugged.

# IMPORTANT PRECAUTIONS (Continued)

## Avoid Volatile Liquid

Do not use volatile liquids, such as an insect spray, near the unit. Do not leave rubber or plastic products touching the unit for a long time. They will leave marks on the finish. Do not use a chemically saturated cloth.

# EXEMPTION CLAUSES

- Toshiba Corporation bears no responsibility in the case of damages arising from natural disaster such as earthquakes, lightning, etc., fire not liable to Toshiba Corporation, acts by third parties, other accidents, or use under abnormal conditions including erroneous or improper operation and other problems.
- Toshiba Corporation bears no responsibility for incidental damages (lost profit, work interruption, corruption or loss of the memory contents, etc.) arising from the use of or the inability to use this unit.
- Toshiba Corporation accepts no liability whatsoever for any damages arising from not having followed the descriptions in this Instruction Manual.
- Toshiba Corporation accepts no liability whatsoever for any damages arising from malfunctions arising from combination with equipment or software that is not related to Toshiba Corporation.
- Toshiba bears no responsibility for information being intercepted or leaked due to the use of a wireless LAN, or any damages therefore.

FixYourDLP.com  
 Project-Merchant.com (800) 281-8860  
 THE TRUSTED SOURCE FOR PROJECTOR LAMPS AND ACCESSORIES

In the spaces provided below, record the Model and Serial No. located at the bottom of your projector.

Model No. \_\_\_\_\_ Serial No. \_\_\_\_\_

Retain this information for future reference.

## OTHER INFORMATION

### Copyrights

Showing or transmitting commercial imaging software or broadcast or cable-broad casting programs with the purpose of other than the personal and private viewing, including modifying images using the freeze or resize functions, or displaying with the varying aspect ratio of the images, could violate the direct or indirect copyrights of the imaging software or broadcast program, etc., if done without first consulting with the copyright holder. For this reason, please take appropriate measures before performing one of the actions listed above, including obtaining a license from the copyright holder.

### Disposal

This product contains substances which are harmful to humans and the environment.

- The lamp contains mercury.

Please dispose of this product or used lamps in accordance with local regulations.

#### Following information is only for EU-member states:

The use of the symbol indicates that this product may not be treated as household waste. By ensuring this product is disposed of correctly, you will help prevent potential negative consequences for the environment and human health, which could otherwise be caused by inappropriate waste handling of this product. For more detailed information about recycling of this product, please contact your local city office, your household waste disposal service or the shop where you purchased the product.



### Trademarks

- VGA, SVGA, XGA, SXGA, UXGA, WXGA are trademarks or registered trademarks of International Business Machines Corporation.
- DLP® (Digital Light Processing) is a registered trademark of Texas Instruments, Inc.
- Macintosh is a registered trademark of Apple Computer, Inc.
- Windows is a registered trademark of Microsoft Corporation in the U.S. and other countries.
- Adobe is a registered trademark and Acrobat Reader is a trademark of Adobe Systems Incorporated.
- Contains technology by Ingenient Technologies, Inc.  
Copyright© 2000-2006 Ingenient Technologies, Inc. All rights reserved.
- All other brand and product names are trademarks or registered trademarks of their respective companies.

### Notational Conventions Used in This Manual

- References to pages with related information are annotated as follows.  
For example, if making a reference to page 36: [p.36](#)
- The illustrations in this document are for reference purposes only and may not reflect your package exactly.

## REMOTE CONTROL BATTERIES

### Caution

- Never throw batteries into a fire.

Using the batteries improperly may cause them to explode or leak and lead to burn or injury. If battery-leaking fluid contacts skin, wash the fluid off immediately with clean water and consult a doctor. If the fluid is spilt on an instrument, avoid contact and wipe it off using tissue paper. (Dispose of the used tissue paper as flammable garbage after moistening with water.)

### Notes

- Be sure to use AAA (LR03) size batteries.
- Dispose of batteries in a designated disposal area.
- Attention should be drawn to the environmental aspects of battery disposal.
- Do not mix different battery types or combine used batteries with new ones.
- If the remote control does not operate correctly, or if the operating range becomes reduced, replace both batteries with new ones.
- If the batteries are dead or if you will not be using the remote control for a long time, remove the batteries to prevent battery acid from leaking into the battery compartment.

# CONTENTS

## Before Using

SAFETY PRECAUTIONS .....	2
IMPORTANT SAFETY INSTRUCTIONS .....	4
POWER SUPPLY INFORMATION .....	10
IMPORTANT PRECAUTIONS .....	10
EXEMPTION CLAUSES .....	11
OTHER INFORMATION .....	12
REMOTE CONTROL BATTERIES .....	13
CONTENTS .....	14

## Preparations

Checking the package contents .....	16
Names of each part on the main unit .....	17
Names of each part on the control panel and remote control .....	18
Label location .....	19
Names of the terminals on the rear panel .....	20
Preparing and using the remote control .....	21
Operating a computer using the remote control .....	22
Placement .....	23
Connection .....	24

## Operations

Turning the power on and off .....	26
Basic operations .....	28
Using handy features .....	31
Using auto setting (Only for input from computer) .....	31
Correcting the keystone distortion .....	31
Zooming out the images .....	32
Resizing image .....	33
Cutting off the picture and sound temporarily (Mute) .....	34
Changing picture mode .....	34
Changing screen size .....	34
Freezing the image (Freeze) .....	35
Setting the password .....	35
Using the menus 1 .....	37
Setup using the Setting display .....	37
The image adjustment menu .....	38
The position adjustment menu .....	39
The display setting menu .....	40
The Default setting menu .....	43
Displaying Information (Status display) .....	45
Before connecting via network .....	46
Communication mode .....	47
How to use the USB terminal .....	48
Using the menus 2 .....	50
Setup using the Setting display (2) .....	50

Setting up the Network Projector/Network Utility .....	51
Computer settings .....	56
The control setting menu .....	57
Setting slideshow options .....	58
Checking the projector status .....	61
Status display .....	61
Using the Network Projector .....	61
Installing the applications .....	62
Using the Network Utility .....	64
Displaying a computer's screen via the projector .....	64
Displaying a JPEG image saved on a computer via the projector .....	66
Displaying a video file saved on a computer via the projector .....	67
Easy Connect utility .....	70
Operating the projector .....	74
Projecting images stored in a USB memory .....	75
Playing a slide show from a thumbnail list .....	75
How to use the JPEG Conversion Tool .....	78
Launching the JPEG Conversion Tool .....	78
Converting files created with Microsoft® PowerPoint® .....	79
Making a presentation with converted JPEG files .....	80
Creating a screen capture and converting it into a JPEG file .....	81
Setting up the projector using a Web browser .....	82

## Maintenance

About lamp .....	85
Lamp replacement .....	86
Lens and main unit cleaning .....	89

## Others

Trouble indications .....	90
Before calling service personnel .....	91
Specifications .....	93

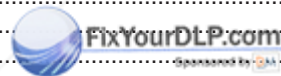

Discount-Merchant.com (800) 281-8860

THE TRUSTED SOURCE FOR PROJECTOR LAMPS AND ACCESSORIES



# Checking the package contents

Please make sure that the following items are included in the box, along with the main unit. If any item is missing, please contact the store immediately where you purchased the product.

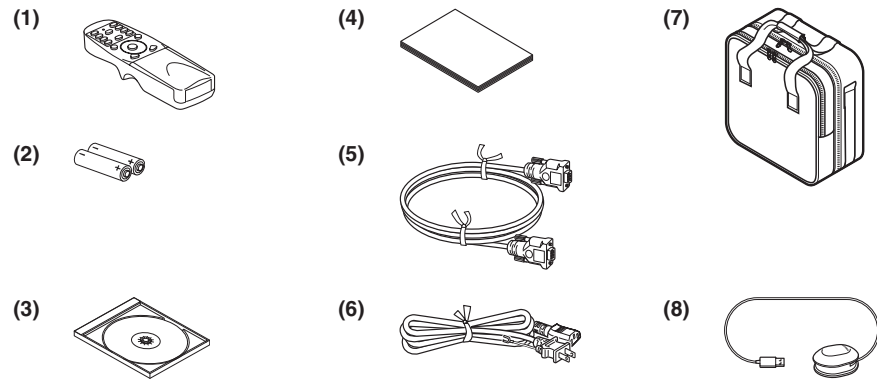

- (1) Remote control
- (2) LR03 (SIZE AAA) batteries for remote control
- (3) CD-ROM
- (4) Owner's Manual
- (5) RGB cable (3m)
- (6) Power cord (See note)
- (7) Carrying bag
- (8) Mouse remote control receiver

**Note**

The shape and number of supplied power cords vary depending on the product destination.

## Save Original Packing Materials

The original shipping carton and packing materials will come in handy if you ever have to ship your projector. For maximum protection, repack the set as it was originally packed at the factory.

### ◆The Supplied CD-ROM

The supplied CD-ROM contains an owner's manual, including information not available for the printed Owner's manual (Getting started), each Application, Project Management Utility Manual and Quick Reference in PDF format. (PDF: Portable Document Format) Please use **Acrobat Reader 5** or more to view the manual.

#### ■ Adobe® Acrobat® Reader® or Adobe® Reader®

The supplied CD-ROM does not contain **Acrobat® Reader®**. If you can not read PDF files, please install **Acrobat Reader** software in your computer by downloading it from the Adobe Systems website.

#### ■ Viewing the manual

Run the CD-ROM and double-click on **Start.pdf**. Acrobat® Reader® launches, and a screen appears asking you that "**Select your mode**", then click on the model name that you are using. After you select [**Owner's manual**] on the next screen, click on the desired language. The **Owner's Manual cover and list of bookmarks appear**. Click on a bookmark title to view that section of the manual. Click on **p.** to view a reference page with related information. See the Help menu for more information about Acrobat® Reader®.

# Names of each part on the main unit

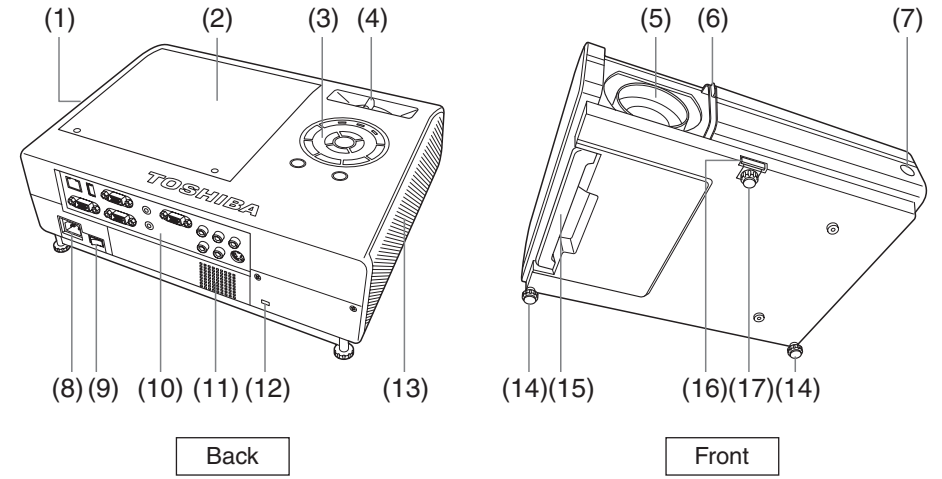

Name	Function
(1) Air exhaust	: Expels air that has grown hot inside the projector.
(2) Lamp cover	: Remove to replace lamp. <a href="#">p.86</a>
(3) Control panel	: Operates the projector. <a href="#">p.18</a>
(4) Focusing lever	: Adjusts screen focus.
(5) Lens	: Projects expanded image.
(6) Lens cover	: Slide shut when not using the projector to protect the lens.
(7) Infrared remote sensor	: Senses commands from the remote control. <a href="#">p.21</a>
(8) AC IN socket	: Connect the supplied power cord here.
(9) Main power switch	: AC power line ON (standby)/OFF.
(10) Terminals on the rear panel	: Connects external devices. <a href="#">p.20</a>
(11) Speaker	: Outputs audio sound.
(12) Antitheft lock hole	: Attach a safety cable or any other antitheft device.
(13) Air intake	: Draws in air from outside the projector for internal cool down.
(14) Tilt adjuster	: Adjusts the projector's horizontal tilt. <a href="#">p.29</a>
(15) Handle	: Hold to carry the projector by pulling out.
(16) Foot adjuster release button	: Press to set up or stow the foot adjuster. <a href="#">p.29</a>
(17) Foot adjuster	: Adjusts the vertical projection angle. <a href="#">p.29</a>





# Names of each part on the control panel and remote control

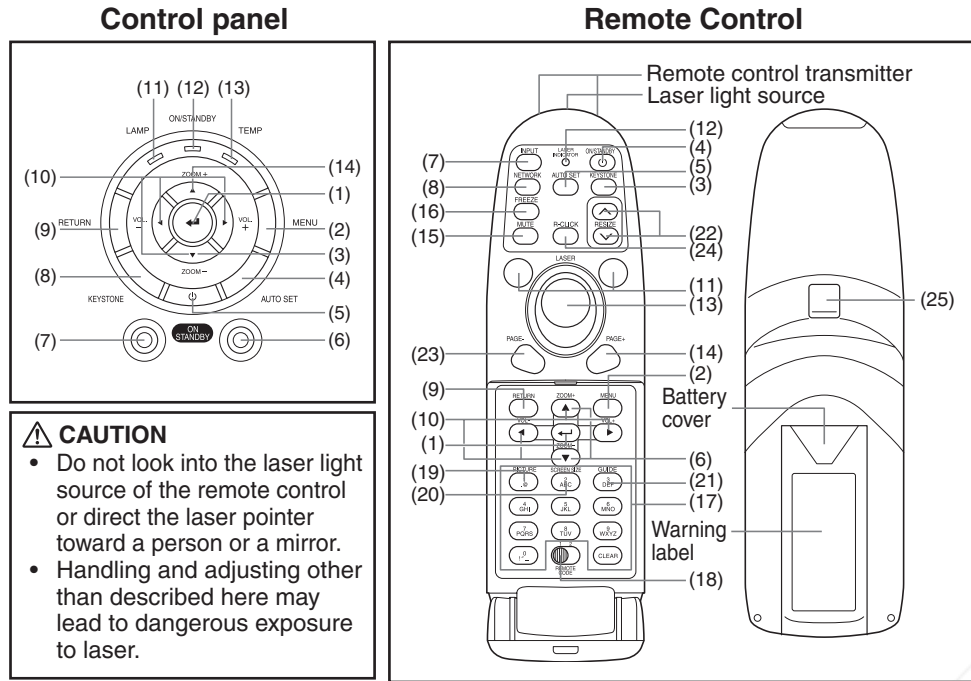

## CAUTION

- Do not look into the laser light source of the remote control or direct the laser pointer toward a person or a mirror.
- Handling and adjusting other than described here may lead to dangerous exposure to laser.

Name : Main Function

## Control panel

- |                           |   |
|---------------------------|---|
| (1) ENTER button          | : Accepts the selected mode.  |
| (2) MENU button           | : Displays menus. <a href="#">p.37</a>  |
| (3) ZOOM – button         | : Adjusts the screen size.  |
| (4) AUTO SET button       | : Performs auto-adjustment of input signals from computer. <a href="#">p.31</a> |
| (5) ON/STANDBY button     | : Turns the power on/off (standby). <a href="#">p.26</a>                        |
| (6) NETWORK button        | : Switches to network input mode. <a href="#">p.50</a>                          |
| (7) INPUT button          | : Selects input. <a href="#">p.28</a>   |
| (8) KEYSTONE button       | : Adjusts keystone distortion. <a href="#">p.31</a>                             |
| (9) RETURN button         | : Goes back one screen.   |
| (10) Selection button     | : Menu selections and adjustments, volume control, etc. <a href="#">p.37</a>    |
| (11) LAMP indicator       | : Displays lamp mode. <a href="#">p.90</a>                                      |
| (12) ON/STANDBY indicator | : Displays when power is On/Off (standby). <a href="#">p.26</a>                 |
| (13) TEMP indicator       | : Lights when external temperature is too high. <a href="#">p.90</a>            |
| (14) ZOOM + button        | : Adjusts the screen size.  |

## Remote control

- |                       |  |
|-----------------------|--|
| (1) ENTER button      | : Accepts the selected mode.                             |
| (2) MENU button       | : Displays menus. <a href="#">p.37</a>                   |
| (3) KEYSTONE button   | : Adjusts keystone distortion. <a href="#">p.31</a>      |
| (4) ON/STANDBY button | : Turns the power on/off (standby). <a href="#">p.26</a> |

- |                                 |  |
|---------------------------------|--|
| (5) AUTO SET button             | : Performs auto-adjustment of input signals from computer. <a href="#">p.31</a>                                  |
| (6) ZOOM button                 | : Adjusts the screen size.   |
| (7) INPUT button                | : Selects input. <a href="#">p.28</a>  |
| (8) NETWORK button              | : Switches to network input mode. <a href="#">p.50</a>   |
| (9) RETURN button               | : Goes back one screen.  |
| (10) Selection button           | : Menu selections and adjustments, volume control, etc. <a href="#">p.37</a>                                     |
| (11) LASER button               | : Shows a laser pointer.   |
| (12) Laser indicator            | : Lights when laser is on.   |
| (13) Mouse control button       | : Controls a mouse pointer. <a href="#">p.22</a>   |
| (14) PAGE+ button               | : Proceeds PowerPoint® slides. <a href="#">p.22</a>  |
| (15) MUTE button                | : Cuts off the picture and sound temporarily. <a href="#">p.34</a>   |
| (16) FREEZE button              | : Pauses image. <a href="#">p.35</a>   |
| (17) Ten-Key button             | : Use as a ten-key pad with wireless LAN, from which numbers and characters can be entered. <a href="#">p.52</a> |
| (18) Remote control code switch | : Sets the code of remote control to that of the projector. <a href="#">p.44</a>                                 |
| (19) PICTURE button             | : Changes image mode. <a href="#">p.34</a>   |
| (20) SCREEN SIZE button         | : Changes screen size. <a href="#">p.34</a>  |
| (21) GUIDE button               | : Displays operation guide for slideshow.  |
| (22) RESIZE button              | : Enlarges image. <a href="#">p.33</a>   |
| (23) PAGE- button               | : Goes back PowerPoint® slides. <a href="#">p.22</a>   |
| (24) R-CLICK button             | : Functions as right-click of a mouse. <a href="#">p.22</a>  |
| (25) L-CLICK button             | : Functions as left-click of a mouse. <a href="#">p.22</a>   |

## Note

- For the remainder of this manual, buttons are referred to as follows:  
Selection buttons ⇒ ; ENTER button ⇒

## Label location

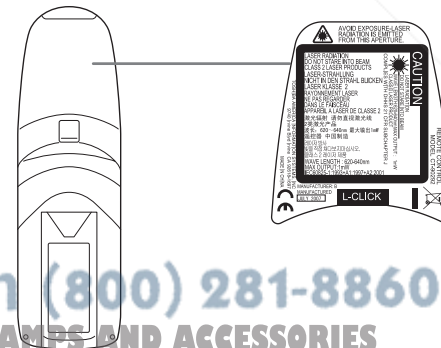

**Caution** – use of controls or adjustments or performance of procedures other than those specified herein may result in hazardous radiation exposure.

## Names of the terminals on the rear panel

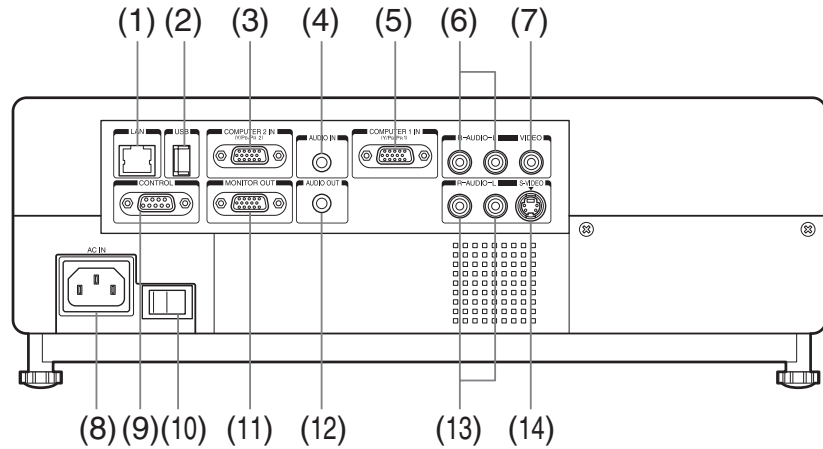

Name	Main Function
(1) LAN terminal	Connects a network cable.
(2) USB terminal	Connects a commercial USB memory. <a href="#">p.48</a>
(3) COMPUTER 2 IN terminal	Input RGB signal from a computer or other source, or a component video signal (Y/P <sub>B</sub> /P <sub>R</sub> ) from video equipment.
(4) AUDIO IN terminal	Input audio signals from a computer, or from video equipment with a component video signal output terminal.
(5) COMPUTER 1 IN terminal	Input analog RGB signal from a computer or other source, or a component video signal (Y/P <sub>B</sub> /P <sub>R</sub> ) from video equipment.
(6) AUDIO (L/R) terminal	Input audio signals from video equipment.
(7) VIDEO terminal	Input video signals from video equipment.
(8) AC IN socket	Connects the supplied power cord here.
(9) CONTROL terminal	When operating the projector via a computer, connect this to the controlling computer's RS-232C port. <a href="#">p.96</a>
(10) Main power switch	AC power line ON (standby)/OFF.
(11) MONITOR terminal	Connect to a computer display, etc.
(12) AUDIO OUT terminal	Outputs audio signals.
(13) AUDIO (L/R) terminal	Input audio signals from video equipment.
(14) S-VIDEO terminal	Input S video signals from video equipment.



Discount-Merchant.com THE TRUSTED SOURCE FOR PROJECTOR LAMP'S AND ACCESSORIES

## Preparing and using the remote control

### ■ Loading dry-cell batteries into the remote control

#### ① Remove the battery cover.

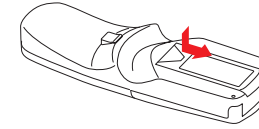

#### ② Insert the dry-cell batteries.

Be sure to align the plus and minus ends of the batteries properly.

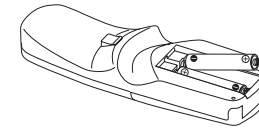

Two batteries (LR03, SIZE AAA) are used.

#### ③ Replace the battery cover.

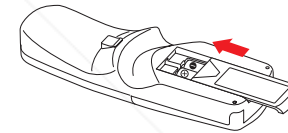

### ■ Operating the remote control

Point toward the projector's infrared remote sensor, and press a button on the remote control.

- Operating the projector from the front

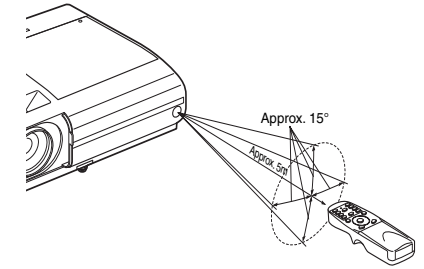

When operating the remote control from behind the projector, the signal beam is reflected on the projecting surface and may travel a shorter distance to reach the projector depending on the shape and material of the projecting surface.

### ■ Dry-cell batteries

- Before using the batteries, be sure to observe the Safety Precautions described in previous pages.
- Remove batteries from remote control when not using for extended periods.
- If the remote control stops working, or if its range decreases, replace all the batteries with new ones.
- Keep the batteries away from the reach of children. Batteries are choking hazards and can be very dangerous if swallowed. If the batteries are swallowed, seek medical assistance immediately.

### ■ The remote control

- The remote control may fail to operate if the infrared remote sensor is exposed to bright sunlight or fluorescent lighting.
- Do not drop or bang.
- Do not leave in hot or humid locations.
- Do not get wet or place on top of wet objects.
- Do not take apart.
- In rare cases, ambient conditions could impede the operation of the remote control. If this happens, point the remote control at the main unit again, and repeat the operation.

# Operating a computer using the remote control

A computer can be operated using the projector's remote control. This function is available on any computer with the Windows® 98/98SE, Windows® Me, Windows® 2000, Windows® XP, or Windows Vista™ OS, that is equipped with a USB port which can support USB1.1 (The mouse remote control receiver is also supported on OS 9 or OS X for the Macintosh). However, please note that Toshiba does not guarantee the operation of all computers.

## 1 Connecting a computer

Connect the mouse remote control receiver (supplied) to a computer.

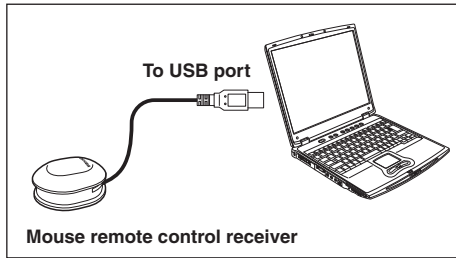

The remote control may fail to operate if the mouse remote control receiver is exposed to bright sunlight or fluorescent lighting.

In such a case, change position or direction of the mouse remote control receiver and retry.

## 2 Operating a computer

Operate remote control's buttons towards the mouse remote control receiver.

### ● Moving the mouse pointer

Press the mouse control button in the direction you wish the mouse pointer to move, then press.

### ● To left click

Press the L-CLICK button.

### ● To right click

Press the R-CLICK button.

### ● To drag and drop

Holding down the L-CLICK button, move the mouse control button until the mouse pointer is over the desired location, then release the L-CLICK button.

### ● Using the computer's page up [↑] and down [↓] function

Press the PAGE+ and PAGE- buttons to switch PowerPoint® slides.

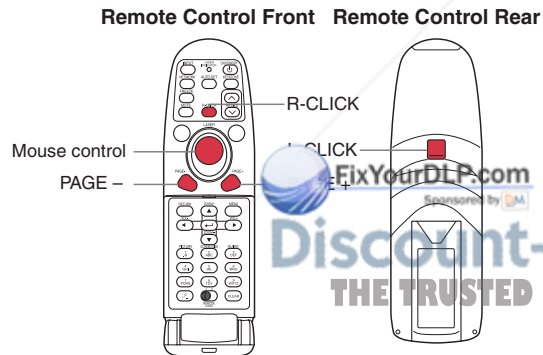

# Placement

## Placement Styles

As shown in the figures below, this device can be placed in 4 different styles. The factory setting is "floor-mounted front projection." Set the [Projection mode] in the Default setting 2 menu p.44, in accordance with your needs.

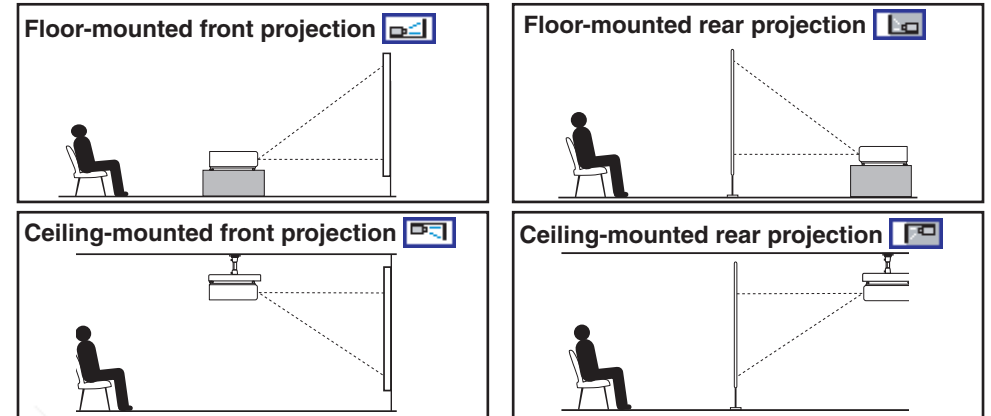

### ⚠ WARNING

- Always obey the instructions listed in IMPORTANT SAFETY INSTRUCTIONS when placing the unit. Attempting to clean or replace the lamp in a high location by yourself may cause you to fall, resulting in injury.
- If you wish to mount the projector on the ceiling, be sure to ask your dealer to do so. Mounting the projector on a ceiling requires special ceiling brackets (sold separately) and specialized knowledge. Improper mounting could cause the projector to fall, resulting in an accident.
- If the projector is ceiling-mounted, install the breaker for turning off the power in case of anomaly. Let everyone involved with the use of the projector know that fact.

## Projection Distance and Size

Use the figures, tables, and formulas below to determine the projection size and projection distance. (Projection sizes are approximate values for full-size picture with no keystone adjustment.)

Screen  
As seen from above

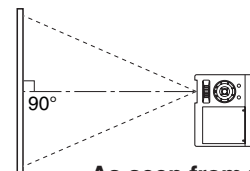

a is the distance (mm, feet) between the lens and the screen, and corresponds to a range of 498 mm (1.63 ft.) to 1526 mm (5.01 ft.).

$$a = 0.000625 \times \text{projection size (inches)}^2 + 12.9175 \times \text{projection size (inches)} - 32.85$$

As seen from the side

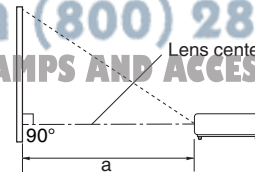

Projection size	Projection distance a
41 inches	498 mm (1.63 ft.)
50 inches	615 mm (2.02 ft.)
60 inches	744 mm (2.44 ft.)
80 inches	1005 mm (3.30 ft.)
100 inches	1265 mm (4.15 ft.)
120 inches	1526 mm (5.01 ft.)

# Connection

## Before connection

- Read the owner's manual of the device you are connecting to the projector.
- Some types of computer cannot be used or connected to this projector. Check for an RGB output terminal, supported signal [p.94](#), etc.
- Turn off the power of both devices before connecting.
- The figure is a sample connection. This does not mean that all of these devices can or must be connected simultaneously. (Dotted lines mean items can be exchanged.)

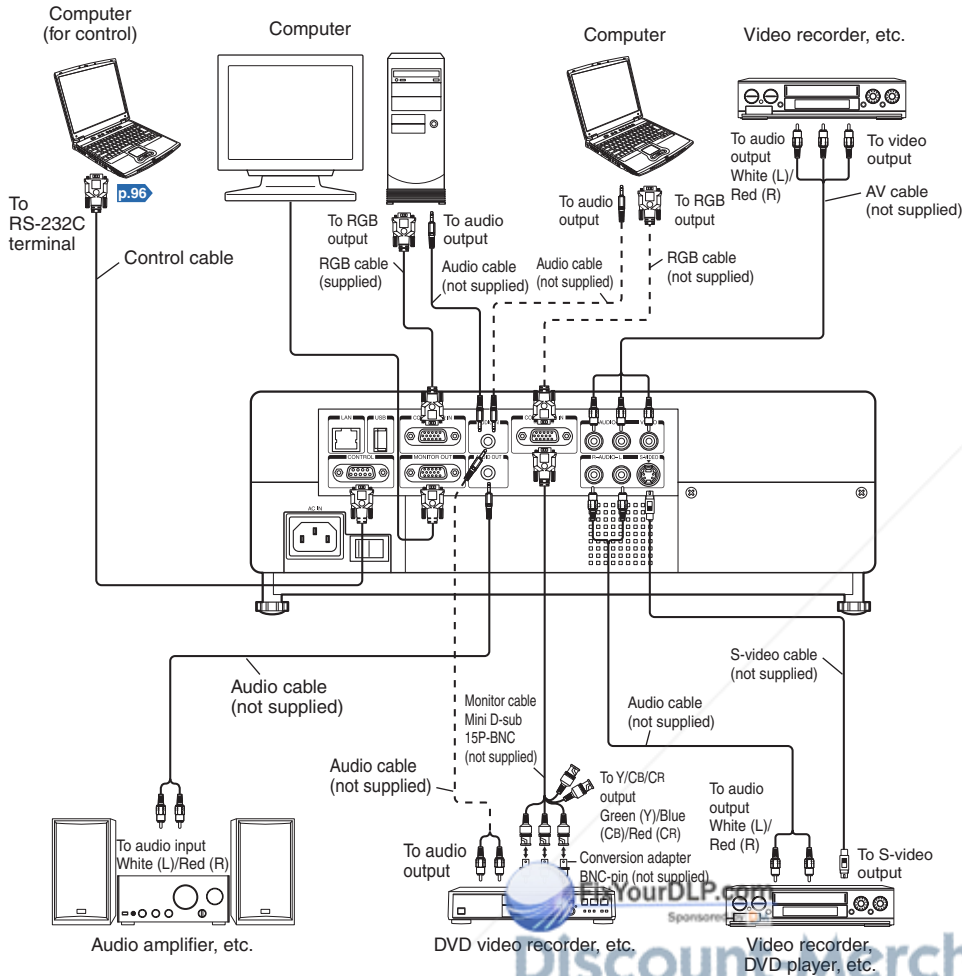

## Notes

- The COMPUTER 1 IN terminal functions identically to the COMPUTER 2 IN terminal.
- The MONITOR OUT terminal outputs signals from the COMPUTER 1 IN terminal or the COMPUTER 2 IN terminal, or outputs Y/PB/PR signals as selected with the INPUT button. If no input is selected, the MONITOR OUT terminal outputs the input signals last selected for each input terminal.
- Signals are output from MONITOR OUT terminal even in standby mode. However, from AUDIO OUT terminal, no audio signal is output.
- A computer monitor cannot accept Y/PB/PR signals correctly.
- The AUDIO IN terminal doubles for devices connected to COMPUTER terminals 1 and 2.
- When an AUDIO OUT terminal is connected, sound is not output from the projector speaker.
- Output volume of AUDIO OUT terminal can be adjusted by the **VOL** button.
- Moving pictures played back on computers using DVD software may appear unnatural if it is projected with this projector, but it is not a malfunction.

[DiscountMerchant.com](http://DiscountMerchant.com) (800) 281-8860  
 THE TRUSTED SOURCE FOR PROJECTOR LAMPS AND ACCESSORIES



# Turning the power on and off

## ■ Connecting the power cord

- 1 Insert the power cord connector into the AC IN socket of the projector.
- 2 Insert the power cord plug into a wall or other power outlet.

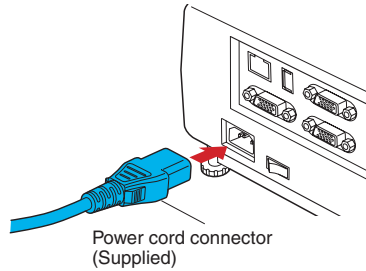

## ■ Turning the power on

- 1 Open the lens cover.

Slide the lens cover to open. If it is left closed, the power will not be turned on.

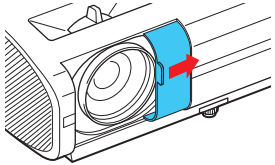

- 2 Turn on the main power switch.

The ON/STANDBY indicator will change to orange, indicating standby mode.

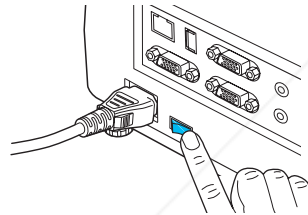

- 3 Press the ON/STANDBY button.

The power is turned on, and the ON/STANDBY indicator lights in green. After a moment, the start-up screen appears.

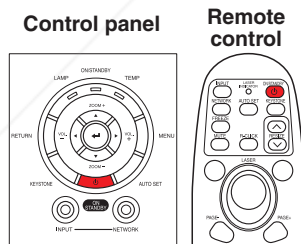

## ■ Notes

- The start-up screen will disappear after a moment. You can dismiss the start-up screen before this by performing any operation. You can also configure the start-up screen not to appear via the **Display setting** menu [p.40](#).
- The first time you use the projector after purchase, after the start-up screen disappears, the start menu is displayed [p.28](#).
- When [**Key lock**] is [**On**], the operation buttons of the projector do not work [p.45](#).
- When [**Password**] is [**On**], enter password then the start-up screen is displayed after the Password entry screen disappears [p.35](#).
- Do not touch the lens directly with your hand. If fingerprints or stains are left on the projection lens surface, they may interfere with the projector's ability to project images on the screen.
- If the lens cover is closed while in use, after a moment the power will turn off, then the projector goes into standby mode.

## ■ Turning the power off

- 1 Press the ON/STANDBY button.

A message appears on the screen, confirming that you wish to shut off the power. This message will disappear after a moment. (This operation is no longer valid after the message disappears.)

- 2 Press the ON/STANDBY button again.

When the setting of beep sound is [**On**], the projector beeps, and the screen disappears, but the internal cooling fan continues to operate. Then, the projector goes into standby mode.

During cooling, the ON/STANDBY indicator flashes. While the indicator is flashing, the power can not be turned back on. At this point of time, it does not matter even if you unplug the power cord.

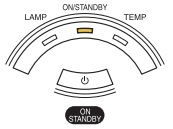

- 3 Close the lens cover.

After use, close the lens cover.

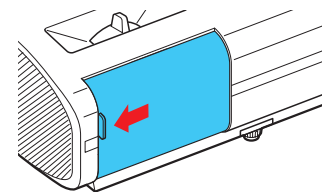

## ■ Note

- The projector consumes about 10W of power in standby. We recommend that you unplug the power cord if you will not be using the projector for an extended period.

## ■ Precaution

- If the power cord is unplugged before cooling is complete or the main power is turned off, give the lamp time (about 5 minutes) to cool before plugging it back in. If the lamp overheats, it may fail to light.

## ⚠ CAUTION

- Do not look into the lens while the lamp is on. The strong light from the lamp may cause damage to your eyesight.
- Do not block the air intake or exhaust. Doing so could cause a fire due to internal overheating.
- Do not place your hands, face, or other objects near the air exhaust, the lamp cover or the bottom of the unit. Doing so could cause burns, deform/break the object.

# Basic operations

## 1 Turn on the power.

Turn on the power by following the instructions in “Turning the power on” p.26.

## 2 Select the language and the lamp power (When using the first time).

When the projector is used for the first time after purchase, the start menu for language (to display the menus and messages on the screen) and lamp power selection and configuration is displayed in English. (If the screen is out of focus, adjust it according to the step 6.)

### 1 Use the ▲, ▼, ◀ or ▶ button to select the desired language and press the ⏻ button.

English..... English	Polski ..... Polish	日本語 ..... Japanese
Français ..... French	Norsk ..... Norwegian	中文(简体字) ..... Chinese (simplified)
Deutsch ..... German	Suomi ..... Finnish	中文(繁體字) ..... Chinese (traditional)
Italiano ..... Italian	Čeština ..... Czech	한국어 ..... Korean
Español ..... Spanish	Magyar ..... Hungarian	Indonesia ..... Indonesian
Português ..... Portuguese	Ελληνικός ..... Greek	
Русский ..... Russian	Dansk ..... Danish	
Svenska ..... Swedish	Nederlands ..... Dutch	
Türkçe ..... Turkish	Română ..... Rumanian	

Message for setup confirmation is displayed in a selected language. Then, the menu for lamp power selection and configuration is displayed. It is automatically set as Standard. To change the setting, follow the step 2.

### 2 Use the ▲ or ▼ button to select the lamp power and press the ⏻ button.

The lamp power, if selected, will be toggled without pressing the ⏻ button. The display automatically disappears in a few seconds.

### Notes

- When the projector is turned on the next time, the start menu does not appear upon startup. However, if [Reset all] is executed from the **Default setting 2** menu p.44, the start menu will be displayed the next time when the power is turned on.
- The language can also be set via the **Display setting** menu p.40 and Lamp power via the **Default setting 2** menu p.44.
- This owner's manual assumes that English has been selected.

## 3 Activate the connected device

Turn on and start the connected device such as a computer.

## 4 Press the INPUT button.

An image of the connected equipment is projected. Each time you press the **INPUT** button, it switches to the input of the connected equipment that is outputting video signals.

### Notes

- When [Auto input search] is set to [Off] in the **Default setting 1** menu p.43 (factory setting is [On]), the **Input select** menu appears if you press the **INPUT** button p.43.
- If no signal is being output from the connected equipment, pressing the **INPUT** button does not change the input and “There is no other input signal.” will appear.

## 5 Projector placement angle adjustments

The placement angle and the height of the projected image can be adjusted by the foot adjuster.

### 1 Lift up the front of the projector to the desired angle, then press the foot adjuster release button.

The foot adjuster extends. Release the button to lock the position.

### 2 To fine adjust the angle, twist the foot adjuster.

### 3 To adjust the horizontal angle, use the right and left tilt adjusters.

- To stow the foot adjuster, hold up the projector while pressing the foot adjuster release button, then slowly lower the projector.

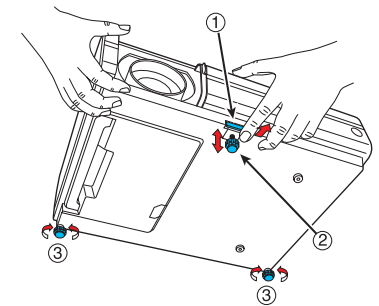

### Note

- When [Auto keystone] is set to [On] in the **Default setting 1** menu, the keystone distortion will automatically be corrected based on the projector placement angle. If you do not desire the automatic keystone correction, set [Auto keystone] to [Off].

## 6 Adjusting the screen size and focus

### 1 If you wish to make the screen size smaller, use the ZOOM button to adjust the screen size.

### 2 Use the focusing lever to adjust the focus.

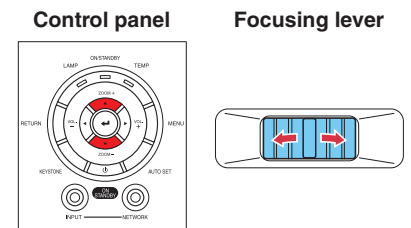

## 7 Adjusting the volume with the ◀ ▶ buttons

The speaker volume can be adjusted when an audio signal is being input.



## Basic operations (Continued)

### Notes

- Note that lamp characteristics may rarely cause the brightness to fluctuate slightly.
- A lamp is consumable item. If used for extended periods, images will appear dark, and the lamp could burn out. This is characteristic of a lamp, and is not malfunction. (The lifetime of the lamp depends on conditions of use.)
- The DLP® chip is made using extremely advanced technology, but there may be black spots (pixels that do not light) or bright spots (pixels that are constantly lit) on the panel. Please note that these are not malfunctions.
- Although this projector supports a wide range of RGB signals [p.94](#), any resolutions not supported by this projector (WXGA) will be expanded or shrunk, which will affect image quality slightly. To view high-quality images, it is recommended that the computer's external output should be set to WXGA resolution.
- With some models of computer having LCD displays or the like, displaying images simultaneously on the projector and the monitor's display may prevent the images from displaying properly. If this happens, turn off the computer's LCD display. For information on how to turn off the LCD display, see the owner's manual of your computer.
- If no signal is being input from the connected equipment or signal input is stopped while projecting, the "No signal" will appear.
- If a signal not supported by the projector is input, the "Unsupport signal" will appear.
- If an unavailable operation button is pressed, the  icon will appear.

## Using handy features

### Using auto setting (Only for input from computer)

This function automatically adjusts the projector settings such as sampling phase, frequency, screen position, and clamp pulse for each type of the input signal by using simple operations.

#### Press the remote control's AUTO SET button.

For computer input, the  icon will appear during processing.

#### Notes

- The image may not be projected or auto adjustment/setting may not be performed correctly for input signals other than those supported by the projector [p.94](#), [p.95](#).
- If auto setting fails adjustment, adjust manually with [Position] in the **Position adjustment** menu [p.39](#).

Remote control

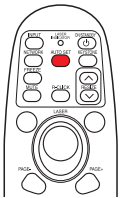

### Correcting the keystone distortion

When the projector placement angle against the screen is changed while projecting the image, the picture will undergo keystone (trapezoidal) distortion.

This projector is capable of correcting this keystone distortion.

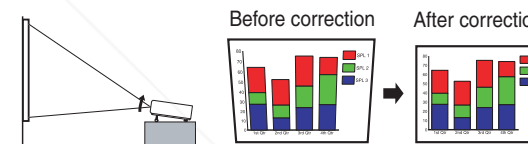

Control panel

Remote control

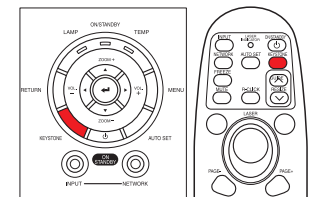

- The keystone distortion will be corrected automatically based on the projector's placement angle.

### Adjusting Keystone distortion [Manual]

#### 1 Press the KEystone button.

#### 2 Use the buttons for keystone adjustment.

#### Notes

- Depending on the amount of keystone adjustment and the content of images, some information may be lost, or the picture quality may suffer.
- Even if [Auto keystone] is set to [On], keystone distortion can be adjusted manually. Note that if you change the position or angle of the projector, automatic keystone correction will be performed again.
- When [Auto keystone] is set to [On], the automatic keystone correction will be performed each time the power is turned on.
- The keystone correction settings are memorized after the power has been turned off. Therefore, it is recommended that you set [Auto keystone] to [Off], if the case is that the projector placement angle against the screen remains unchanged and you do not wish to change the keystone adjustment that you set.
- Some adjustments using both digital zoom and keystone correction while displaying an input image with a 16:9 aspect ratio, may affect displaying the menu properly. In such a case, reset either digital zoom or keystone correction to use the menu.



Discount-Merchant.com (800) 281-0960  
THE TRUSTED SOURCE FOR PROJECTOR LAMPS AND ACCESSORIES

# Using handy features (Continued)

## Zooming out the images

This projector is provided with the digital zoom (electric zoom: 100 - 62%). (Note that the display, if digitally zoomed out, may suffer from some degradation.)

### 1 Press the ZOOM – button.

Each time the ZOOM – button is pressed, the image is reduced in size.

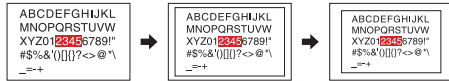

### 2 Press ZOOM + button to bring it back to the original size.

Each time the ZOOM + button is pressed, the image size increases.

(You cannot make it larger than the original size.)

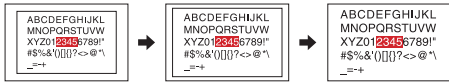

### Notes

- Pressing either ZOOM – or ZOOM + button will display an adjustment bar.
- The adjustment value will automatically be saved.

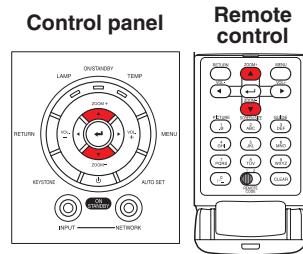

## Resizing image

The projected image can be resized (zoomed in/out).

### 1 Press the remote control's RESIZE ^ button.

Each time you press the RESIZE ^ button, zoom ratio is up. You can keep pressing.

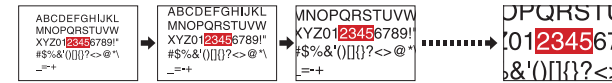

### 2 To zoom out, press the remote control's RESIZE v button.

Each time you press the RESIZE v button, zoom ratio is down. You can keep pressing. (However, the image cannot be smaller than the original size.)

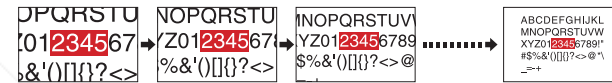

### 3 To move the area to zoom in, use the left, right, up, and down arrow buttons.

You can keep pressing.



### 4 When the image returns to the original size by pressing RESIZE v button several times, the zoom will be reset.

Pressing the RETURN button during resizing also resets the zoom.

### Notes

- The  icon appears while resizing.
- Operating a function other than Mute will release resizing.
- As zooming is processed digitally, the image quality is degraded in larger zoom ratio.
- During resizing or moving the zooming area, the image may be distorted.

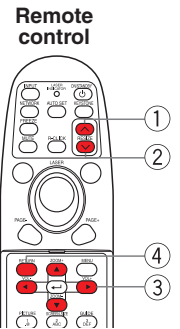

## Using handy features (Continued)

### ■ Cutting off the picture and sound temporarily (Mute)

When you want to project the images of another projector, overhead projector, etc. temporarily, this projector's images and sound can be turned off.

#### ● Press the remote control's MUTE button.

The picture and sound are cut off. (The Mute function is released when pressing the MUTE button again.)

#### ■ Notes

- The  icon will appear while mute is in effect.
- Operating any other functions will also cancel the muting.

#### ■ Precaution

- Do not close the lens cover to cut off the projected image temporarily. It may cause the lens cover to deform due to the heat.

Remote control



### ■ Changing picture mode

The projected image mode can be selected.

#### ● Press the remote control's PICTURE button.

Pressing the button switches Bright/Standard/True color in turn.

#### ■ Note

- [Picture mode] of the Image adjustment menu has the same function [p.38](#).

Remote control



### ■ Changing screen size

The screen size for the projected image can be changed.

#### ● Press the remote control's SCREEN SIZE button.

Pressing the button switches Normal/Full/Thru/4:3 zoom in turn.

#### ■ Notes

- Thru display is available for Computer and Network-input images.
- 4:3 zoom display is available for Y/Pb/Pr, Video and S-video-input images.
- [Screen size] of the Display setting menu has the same function [p.40](#).
- If you use this function on commercial video software, broadcast or cable-broadcasting except for the purpose of your private viewing and listening, it may infringe the copyright protected by the copyright laws.

Remote control

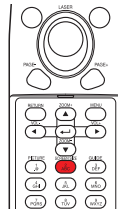

### ■ Freezing the image (Freeze)

The image being projected can be frozen. This function is to be used to pause a video during a presentation, etc.

#### ● Press the remote control's FREEZE button.

The picture pauses. (The Freeze function is released when pressing the FREEZE button again.)

#### ■ Notes

- The  icon will appear while freeze is in effect.
- Other operation will also release the freeze.
- Even if an image is frozen on the projector, the pictures are running on the video or other equipment.
- If you use this function on commercial video software, broadcast or cable-broadcasting except for the purpose of your private viewing and listening, it may infringe the copyright protected by the copyright laws.



Remote control



### ■ Setting the password

#### ● How to change password

The default password is 000000.

- 1 Select [Password] in the Default setting 2 menu and press the  or  button.
- 2 Select [Password registration] in the password registration, setting menu, and press the  button.  
The password entry screen is displayed.
- 3 Enter the current password (6-digit number).
  - Enter a 6-digit number for the password using numeric keys of the remote control.
  - Enter [000000] (6 zeros) for the first change.
  - The password is not displayed. Instead it appears as [\*\*\*\*\*].
- 4 Enter a new password (6-digit number).
- 5 Re-enter the same password for confirmation.

#### ■ Note

- Please do not forget your password. If you forget the password, you can not release the password by yourself.  
In such a case, please inquire your dealer.

## Using handy features (Continued)

### ● How to set password (from [Off] to [On])

- 1 Select [Password] in the Default setting 2 menu and press the or button.
  - 2 Select [Password setting] in the password registration, setting menu, and press the or button.
  - 3 Select [On].
  - 4 Select [OK] and press the button.  
The password entry screen is displayed.
  - 5 Enter the password using numeric keys of the remote control.
  - 6 The password setting will be set as [On].
- ### ● How to operate when password is [On]

- 1 Turn on the power.
- 2 The lamp lights and the password entry screen appears.
- 3 Enter the password using numeric keys of the remote control.  
If the entered password is correct, the start-up screen appears and the projector goes into normal operation. If the password is wrong, a message appears to prompt you to re-enter the password, and again the password entry screen is displayed. If you enter a wrong password for more than 5 times, the projector will automatically power off and enter standby mode.

#### ■ Note

- When the password setting is [On], the password will be enabled only when the power is turned on for the first time after the main power switch has been on. The password function will not be activated if the power backed on while it is standby mode without turning off the main power switch.

### ● How to set password (from [On] to [Off])

- 1 Select [Password] in the Default setting 2 menu and press the or button.  
The password entry screen is displayed.
- 2 Enter the password using numeric keys of the remote control.
- 3 Select [Password setting] in the password registration, setting menu, and press the or button.
- 4 Select [OFF].
- 5 Select [OK] and press the button.

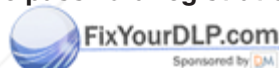

Discount-Merchant.com 1-800-265-0860  
THE TRUSTED SOURCE FOR PROJECTOR LAMPS AND ACCESSORIES

## Using the menus 1

You can call up on-screen menus, and conduct a number of adjustments and settings using the operation buttons [p.18](#) on the control panel (main unit side) and remote control.

### ■ Setup using the Setting display

The menu shown below is for operation instructions purposes and might differ from the actual display.

1. Press the MENU button Display the Setting display menu.

2. Select a Category

Select a category by using .

There are following 6 categories:

- Image adjustment menu [p.38](#)
- Position adjustment menu [p.39](#)
- Display setting menu [p.40](#)
- Default setting 1 menu [p.43](#)
- Default setting 2 menu [p.44](#)
- Status display menu [p.45](#)

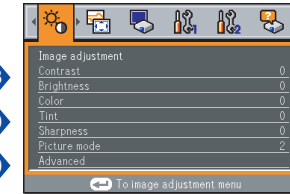

Displays the current adjustments and settings of selected category.  
Item shown with gray cannot be adjusted with the current input source.

3. Adjustments & Settings Press or to open the menu.

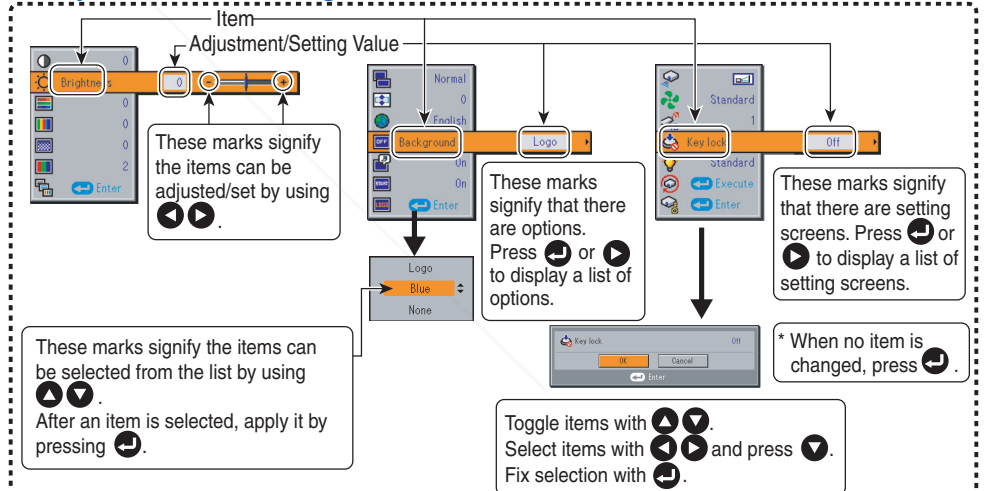

- The figure shows displays given for operation instructions purposes. As the display may differ depending on the item, use the following pages as a reference.
- To return to previous item, press the RETURN button.
- When Network or USB memory input is selected, pressing the MENU button displays the Setting display (2) menu.

4. End Press the MENU button once more.

(The menu will disappear automatically after 30 seconds, if no operation is conducted.)

## Using the menus 1 (Continued)

### ■ The image adjustment menu

Use this menu to set or adjust image-related items. Items that can be set or adjusted are marked with "Yes", and those that cannot are marked with "No". (When an item is masked, it indicates that you cannot select for the current input.)

Item ▲ ▼	Description	Computer	Y/Pb/Pr	Video	S-video	Network	USB memory
<b>Contrast</b>	Adjust the image contrast. Lower ◀▶ Higher	Yes	Yes	Yes	Yes	Yes	Yes
<b>Brightness</b>	Adjust the brightness of the image. Darker ◀▶ Brighter	Yes	Yes	Yes	Yes	Yes	Yes
<b>Color</b>	Adjust the color of the image. Lighter ◀▶ Deeper	No	Yes	Yes	Yes	No	No
<b>Tint</b> <sup>*1</sup>	Adjust the tint of the image color. Reddish ◀▶ Greenish	No	No	Yes	Yes	No	No
<b>Sharpness</b>	Adjust the sharpness of the image. Softer ◀▶ Sharper	No	Yes	Yes	Yes	No	No
<b>Picture mode</b>	Press . Toggle the picture mode with ▲ ▼. Bright/Standard/True color	Yes	Yes	Yes	Yes	Yes	Yes
<b>Advanced adjustment</b> Press  to enter the advanced adjustment	<b>Noise reduction</b> <sup>*2</sup>	Yes	Yes	Yes	Yes	Yes	Yes
	<b>R-level</b>	Yes	Yes	Yes	Yes	Yes	Yes
	<b>G-level</b>	Yes	Yes	Yes	Yes	Yes	Yes
	<b>B-level</b>	Yes	Yes	Yes	Yes	Yes	Yes
	<b>NTSC mode</b> <sup>*3</sup>	Set the black level with ◀▶. US : NTSC (US) mode JAPAN : NTSC (JAPAN) mode	No	No	Yes	Yes	No

\*1: [Tint] can be displayed and adjusted only when the video signal is set to [NTSC] or [NTSC4.43].

\*2: [Noise reduction] may not work depending on signal type.

\*3: [NTSC mode] can be displayed and adjusted only when the video signal is set to [NTSC] or [NTSC4.43]. NTSC mode is set to JAPAN when the language is set to Japanese. It is set to US for other languages.

### ■ The position adjustment menu

Use this menu to set or adjust position-related items. Items that can be set or adjusted are marked with "Yes", and those that cannot are marked with "No". (When an item is masked, it indicates that you cannot select for the current input.)

Item ▲ ▼	Description	Computer	Y/Pb/Pr	Video	S-video	Network	USB memory
<b>Phase</b>	Adjust to eliminate flicker with ◀▶	Yes	No	No	No	No	No
<b>Frequency</b>	Adjust with ◀▶ to eliminate periodic patterns and flickering when fine vertical lines appear on the screen.	Yes	No	No	No	No	No
<b>H-position</b>	Adjust the horizontal position of the image. Move left ◀▶ Move right	Yes	No	No	No	No	No
<b>V-position</b>	Adjust the vertical position of the image. Move down ◀▶ Move up	Yes	No	No	No	No	No
<b>Clamp pulse 1</b>	Adjust the clamp pulse position. Lower ◀▶ Higher	Yes	No	No	No	No	No
<b>Clamp pulse 2</b>	Adjust the clamp pulse width. Narrower ◀▶ Wider	Yes	No	No	No	No	No



Discount-Merchant.com (800) 281-8860  
THE TRUSTED SOURCE FOR PROJECTOR LAMPS AND ACCESSORIES



## Using the menus 1 (Continued)

### ■ The display setting menu

Use this menu to set screen display-related items.

(The items in gray color cannot be set with the current input selection.)

Item ▲ ▼	Description
<b>Screen size</b>	Screen size setting [Left] or [Right]: Enter setting] → [▲ ▼: Selection] → [Enter: ] <b>Normal/Full/Thru/4:3 zoom</b>
<b>Up/down shift</b>	Lets the projected images shift vertically when the screen size setting is 4:3 zoom display (within the range of 1280 × 800). Lower the image  Raise the image
<b>Language</b>	Select one of the languages below to use for displaying the menu and messages [Left] or [Right]: Enter setting] → [▲ ▼: Selection] → [Enter: ] English / Français / Deutsch / Italiano / Español / Português / Русский / Svenska / Türkçe / Polski / Norsk / Suomi / Čeština / Magyar / Ελληνικός / Dansk / Nederlands / Română / 日本語 / 中文(简体字) / 中文(繁體字) / 한국어 / Indonesia
<b>Background</b>	Screen to display when there is no input signal [Left] or [Right]: Enter setting] → [▲ ▼: Selection] → [Enter: ] <b>Logo/Blue/None</b>
<b>Icon</b>	Display icons as function guides <span style="float: right;">On  Off</span>
<b>Start-up screen</b>	Display start-up screen when power is turned on <span style="float: right;">On  Off</span>
<b>User logo</b>	Display a logo customized by the user for the start-up screen or when there is no input signal. [Left] or [Right]: Enter setting] → [▲ ▼: Selection]
<b>Logo registration</b>	Press  to display the registration menu.
<b>Display style</b>	
<b>Logo confirmation</b>	Press .
<b>Reset logo</b>	Yes  No

### ● Detailed description

#### [Screen size]

- **Normal** : Enlarge an input image to fit the screen without changing the aspect ratio of video signals.
- **Full** : Displays an input image in 1280 × 800 dot resolution by enlarging it to fill the entire screen.
- **Thru** : Displays an input image in the native resolution of the video signals. Thru display is not available for Y/PB/PR, Video and S-Video-input images. The larger image than the screen size will be displayed over the screen. The input image may appear vertically long with some frequencies of video signals.
- **4:3 zoom** : Displays an input image with a 4:3 aspect ratio by enlarging it vertically. The enlarged image will be displayed over the screen. 4:3 zoom display is not available for Computer and Network-input images.
- For Y/PB/PR input, screen size setting function is not available for the video signals with a 16:9 aspect ratio.
- For the Network-input images, the size can be set only when the image is displayed. The size setting is not available when the projector is connected to your computer using the Network Projector (Windows Vista™) function. It may fail to display the image to fill the entire screen with some input image sizes.
- For the USB memory-input images, the size cannot be set.

#### ■ Note

- If you use the screen size setting function on commercial video software, broadcast or cable-broadcasting programs to display images with the varying aspect ratio except for the purpose of your private viewing and listening, it may infringe the copyright protected by the copyright laws.

#### [Up/down shift]

Shifts the projected image vertically when [Screen size] is [4:3 zoom].

#### [Background]

- TOSHIBA is set for [Logo] by factory setting.
- If user's logo has been registered, it is displayed when [Logo] is set for background.

#### [Start-up screen]

If user's logo has been registered and this setting is [On], the logo is displayed at start-up.

#### [User logo]





Registers a part of the image that is input from computer, as a stationary picture and displays it as a logo at start-up and when no signal is input.



## Using the menus 1 (Continued)

### <Logo registration>

#### ● How to register user logo

- ① Project a picture to register.
- ② Select [User logo] in the Display setting menu, and press the  or  button.
- ③ Select <Logo registration> from the displayed menu list and press the  button.
- ④ The registration area is displayed for confirmation. Select [OK] and press the  button.
  - If the registered picture does not fall within the display area, operate the computer to scroll the screen.
- ⑤ Registration starts.
  - To stop the registration, press the RETURN button.

#### ■ Notes

- You can register a logo when the input is set to Computer, Network and USB memory.
- For the Network-input, a logo can be registered only when the image is displayed.
- For the USB memory-input, a logo cannot be registered when a thumbnail list is displayed.
- If you register a logo after keystone distortion or digital zoom has been adjusted, those adjustments will be reset to their factory settings. However, when the logo registration is complete, they will return to the adjustments that you made.
- The area that can be registered is 640 × 400 dots at the center of the screen. To register a company logo, prepare the image within the limit.
- Only one logo can be registered. When a new image is registered, the old one is erased.
- The time needed to register or display the image varies depending on the data size.
- If you use this function on commercial video software, broadcast or cable-broadcasting except for the purpose of your private viewing and listening, it may infringe the copyright protected by the copyright laws.

### <Display style>

Select the size of the registered logo.

 : Displays the registered image in original size at center of the screen.

 : Displays the registered image by enlarging fully in the screen.

(As processed digitally, the image quality is degraded.)

### <Logo confirmation>

You can preview the registered logo.

























### <Reset logo>

You can reset the registered logo and display style to the factory setting. (The logo set for the start-up screen and background is reset.)

## ■ The Default setting menu

This menu shows placement status and other settings.

### Default setting 1 menu

Item  	Description
 <b>Keystone</b>	Screen shrinking at bottom   Screen shrinking at top
 <b>Auto keystone</b>	Always correct keystone distortion automatically. On   Off
 <b>Blackboard mode</b>	When projecting on a non-screen surface, select a color in accordance with the projecting surface. Press  and switch with  and  . Off/Green/Black/Brown/Blue/Beige
 <b>No signal power off</b>	Set the time to wait for the power to be turned off after the last operation is made with no input signal. On (not turned off)   30 min.
 <b>Auto input search</b>	Set whether the input with signals is only selected or not. On   Off
 <b>Beep</b>	Beep when operation is made. On   Off
 <b>Power on</b>	Sets whether to turn on the power when the ON/STANDBY button is pressed (Manual), or when the main power switch is turned on (Auto). Manual   Auto

#### ● Detailed description

##### [Blackboard mode]

Projects the image in colors more like projecting on a screen.

##### ■ Precaution

- The projected image may differ depending on the type, color, and material of the blackboard and wall even if the selected color is the same as the projected screen.

##### [Auto input search]

[On]: Automatically searches the signals that can be projected, and switches input from the connected device that outputs the video signals each time the INPUT button is pressed. The input from the connected device that outputs no video signals is skipped.

[Off]: Displays the Input select menu.

Toggle with   buttons and press  button. (The input without signals can be selected.)

##### Input select menu

Input select
<input checked="" type="radio"/> Computer 1
<input type="radio"/> Y/P <sub>B</sub> /P <sub>R</sub> 1
<input checked="" type="radio"/> Computer 2
<input type="radio"/> Y/P <sub>B</sub> /P <sub>R</sub> 2
<input checked="" type="radio"/> Video
<input type="radio"/> S-video
<input checked="" type="radio"/> Network
<input checked="" type="radio"/> USB memory

●/○ shows whether signal is input or not.

##### [Power on]

Note that if [Power on] is set to [Auto], then if the power is supplied when restored after a power outage, the projector will come on.

# Using the menus 1 (Continued)

## Default setting 2 menu

Item ▲ ▼	Description
<b>Projection mode</b>	Sets projection mode in accordance with Placement Style. <a href="#">p.23</a> (Standard)  (Rear)  (Ceiling)  (Rear ceiling)
<b>Fan mode</b>	Sets the cooling fan speed. <b>Standard</b> <b>High</b>
<b>Remote control</b>	When 2 projectors are used and controlled by the remote control respectively, this menu sets the code for the projector and the remote control. [▲ or ▼]: Enter setting → [▲ ▼]: Select from 1, 2 → [▼]: Confirm → [▲ ▼]: Select OK to end Press [Cancel] to return.
<b>Key lock</b>	Lock the control panel buttons. [▲ or ▼]: Enter setting → [▲ ▼]: Select On/Off → [▼]: Confirm → [▲ ▼]: Select OK to end Press [Cancel] to return.
<b>Lamp power</b>	Set the lamp power. <b>Low</b> <b>Standard</b>
<b>Reset all</b>	Press [OK]. (The password and user logo are not reset.) Resets all adjustments and settings to their factory settings. <b>Yes</b> <b>No</b>
<b>Password</b>	Password setting <a href="#">p.35</a> Press [OK] → Password registration/Password setting

### ● Detailed description

#### [Fan mode]

Setting [Fan mode] to [High] increases the cooling fan speed. (The cooling fan noise gets louder.) Set this option to use the projector, for example, at high altitude (over 1,500 meters above sea level).

- Do not set Fan mode to [High] when using the projector at a lower altitude.

#### [Remote control]

Sets a remote control code from 2 types. You can set each code respectively for up to 2 projectors. The factory setting is [1].

To switch codes, set the same code for the projector and the remote control.

A remote control code is applied after the setting is done.

- You cannot operate the remote control if the codes of the projector and the remote control do not match.

#### Remote control code setting for remote control

Set the same **remote control code switch** as the projector. [p.18](#) [p.19](#)

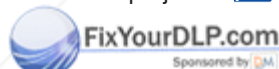

Discount-Merchant.com (800) 281-8268  
 THE TRUSTED SOURCE FOR PROJECTOR LAMPS AND ACCESSORIES

#### [Key lock]

Protect from operating errors by locking on the control panel buttons of the projector. (The remote control operations are available.)

Control panel operations are locked after the setting is done, and accordingly operation with the control panel buttons is disabled.

- To release the key lock, set the [Key lock] to [Off] using remote control. Pressing the [RETURN] button on the projector for 10 seconds also sets the [Key lock] to [Off]. (When operating the main unit, the 2 indicators of LAMP and TEMP light in orange for 3 seconds, and at the same time the projector beeps.) However, when Network or USB memory input is selected, the [Key lock] cannot be set to [Off] with the [RETURN] button on the projector.

#### [Lamp power]

When [Lamp power] is set to [Low], the screen becomes a little darker, but the cooling fan noise gets quieter.

## ■ Displaying Information (Status display)

This displays information about the input signal, lamp use time, etc.

"Yes": displayed, "No": not displayed

Item	Description	Computer	Y/Pb/Pr	Video	S-video	Network	USB memory
Input	Input source name	Yes	Yes	Yes	Yes	Yes	Yes
Mode name	RGB input mode <sup>[Note 1]</sup>	Yes	No	No	No	No	No
Resolution	Resolution (in dots)	Yes	No	No	No	No	No
Frequency	Sync frequency	Yes	No	No	No	No	No
Sync	Sync signal polarity <sup>[Note 2]</sup>	Yes	No	No	No	No	No
Signal format	Y/Pb/Pr signal format	No	Yes	No	No	No	No
Video mode	Color method of video signal	No	No	Yes	Yes	No	No
Lamp time	Time of lamp use <sup>[Note 3]</sup>	Yes	Yes	Yes	Yes	Yes	Yes
Lamp reset count	The count for lamp replacement	Yes	Yes	Yes	Yes	Yes	Yes
Total time	The total time that this projector is used.	Yes	Yes	Yes	Yes	Yes	Yes
Version	Firmware version <sup>[Note 4]</sup>	Yes	Yes	Yes	Yes	Yes	Yes

### Notes

- The mode of supported RGB signals [p.94](#) is shown.
- Sync signal polarity shown as P (positive) or N (negative) for [H/V].
- Displays [Lamp time] as a measure of when the lamp should be replaced. (Cannot be used as a counter of guaranteed lamp time.) When the displayed time approaches 2,000 hours, consult with a dealer about getting replacement for: TLPLW15 for TDP-EW25 (sold separately).
- [Version] shows the version of the projector's internal control program. This version is referred to for customer service, etc.

#### ■ Note

- The displayed information will not be refreshed if the status changes. To refresh the information, dismiss the display, then display it again.

# Before connecting via network

Check the OS of your computer before you connect a projector with your computer via network. This projector supports the **Network Projector** function of **Windows Vista™** features.

If your computer's OS is **Windows Vista™** and you intend to use the **Network Projector** function for network connection, see "**Connection using the Network Projector (Windows Vista™)**" p.46, "**Setting up the Network Projector/Network Utility**" p.51 and "**Using the Network Projector**" p.61.

If your computer's OS is Windows® 2000 or Windows® XP, see "**Connection using the Network Utility (Toshiba original tool)**" p.46, "**Setting up the Network Projector/Network Utility**" p.51 and "**Using the Network Utility**" p.64.

## Connection using the Network Projector (Windows Vista™)\*

\* Now referred to as "Network Projector."

### ■ Functions

By using the **Connect to a Network Projector wizard**, you can connect to any available Windows-compatible network projector over a wireless or a wired network. You can make a presentation without any troubles of connection settings.

#### ■ Notes

- This function's operation has been verified on the **Ultimate** and **Business** editions of **Windows Vista™**.
- To communicate in Ad hoc mode with a computer over wireless LAN also requires IP address settings.
- In case the resolution of your computer is higher than that of the projector, your computer must be set at lower resolution.
- Transferring video images and audio sound is not available.
- This function does not work during the connection using the **Network Utility** software.

## Connection using the Network Utility (Toshiba original tool)

### ■ Functions

The following functions are available with the wired LAN, or via wireless communications when the LAN dedicated application software: [**Network Utility**] p.64 included with this projector is used.

#### 1) Displaying a computer's screen via the projector

The computer's desktop screen can be sent, as well as the screens of a variety of software applications, to the projector for display. Likewise, the sound being played on a computer can also be sent to the projector.

#### 2) Displaying a JPEG file saved on a computer via the projector

JPEG files can be sent to the projector for display. Likewise, the sound being played on a computer can also be sent to the projector.

#### 3) Displaying a video image saved on a computer via the projector

Video files can be sent to the projector for image display. As well, the sound stored in the video file is sent to the projector.

#### 4) Operating the projector by means of a computer

Some of the same functions available from the remote control can be performed.

#### ■ Note

- Network Utility is also available with Windows Vista™.

### ■ Communication mode

The wireless LAN of this projector supports both Ad hoc and Infrastructure Communication modes.

#### ◆ Ad hoc communication mode

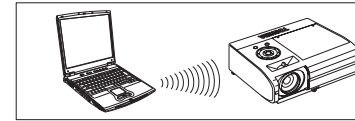

This is transmission mode to communicate between wireless LAN equipment. This mode is applicable, for example, to a presentation in the conference room, as it requires no other facilities. This function can only be used if

the projector is in range of the computer's wireless signals.

Toshiba does not guarantee the coverage of the radio wave in the form of figures. The coverage varies depending on the performance of each wireless LAN equipment, existence of obstacles or other wireless LAN equipment used by nearby working groups, etc. The coverage is generally estimated on the assumption that wireless LAN equipment be used in an unobstructed office or conference room.

#### ◆ Infrastructure communication mode

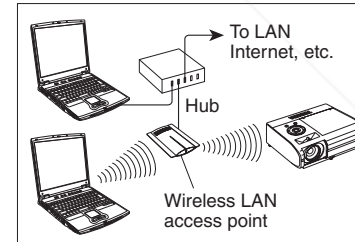

A mixed wireless and wired LAN can be created via wireless LAN access points. (Communication between wireless LAN devices is also allowed.) Connecting to the rest of the world via a wired LAN or the Internet generally requires a high level of security.

Use the appropriate transmission mode for your network environment.

### ■ Caution when using the wireless LAN functions

The Wireless LAN in this unit uses the 2.4 GHz waveband. If there is a similar wireless LAN in the area, or a wireless device using the 2.4 GHz waveband, or a microwave oven, the communication efficiency of this apparatus will be reduced, and may become unusable, but it is not a fault. If this happens, check an area away from the current location that will not cause radio interference to medical, industrial and public equipment, and change to it, or stop using the unit.

# How to use the USB terminal

This projector can connect with a commercial USB memory and a USB memory card reader/writer that are USB2.0 compliant, a digital camera or the like and display the JPEG and MPEG files saved in those devices. [p.49](#)

(Toshiba does not guarantee the operation of all USB 2.0-compliant devices.)

To connect or disconnect a USB device, use the following procedure:

## ■ Connecting USB device

### Plug the USB device.

Make sure the orientation is correct then plug the USB device in until it stays securely.

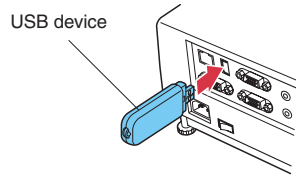

## ■ Disconnecting USB device

- ① Switch the input to USB memory and press the MENU button twice to display the Setting display (2), then select and run Unplug device in the Slideshow setting menu.

The processing for disconnecting a USB device starts.

- ② The message “This USB device can be unplugged safely” appears on the screen.

- ③ Unplug the USB device.

**Be sure to perform the above operations. Disconnecting a USB during operation may cause a malfunction or data corruption.**

### ■ Notes

- A USB device can be plugged even when the power is on.
- The projector may not recognize a supported USB device. In such a case, unplug the USB device then re-plug it.
- The USB terminal does not support the supplied mouse remote control receiver or a commercial mouse controller.
- A USB hub is also not supported.

### ■ Precaution

- Disconnecting the power plug while the USB device is operating may cause a malfunction or data corruption.

## ■ USB memories

This projector can read JPEG, MPEG1, and MPEG2 (PS) files stored in a USB memory and display them on the screen.

This allows you to give presentations without a computer, create an advertising screen board using the slideshow function, and more. (The projector cannot reproduce animation effects such as those produced by Microsoft® PowerPoint®.)

## ● The USB terminal

The USB terminal of the projector is USB2.0 compliant and can connect with a USB memory, a USB memory card reader/writer, a digital camera and the like.

## ● USB devices whose operation has been verified

Toshiba does not guarantee the operation of all USB devices.

- Toshiba USB memory : U2E series (256MB, 512MB, 2GB)
- Toshiba USB memory : U2G series (16GB)
- SanDiskUSB memory : SDCZ4 series (1GB, 2GB)
- SanDiskUSB memory : SDCZ6 series (1GB, 4GB)
- SanDiskUSB memory : SDCZ7 series (1GB, 2GB)
- Toshiba USB card R/W : IPCS078A
- SanDiskUSB card R/W : SDDR-88-J70

Note that this projector does not support all USB memories, USB card readers/writers, and digital cameras.

## ■ Backing up data

Toshiba recommends that you back up the data saved in the USB memory onto your computer and the like before use. (Toshiba assumes no liability for losses incurred by data lost through the use of this projector.)

## ■ Supported files

- (1) Supported file extensions are .jpg, .JPG, .jpeg, .JPEG, .mpg, .MPG, .mpeg, and .MPEG.
- (2) The maximum number including both folders and files is 512.
- (3) Some JPEG and MPEG files are not supported by this projector.

Regarding JPEG files, the limitations in (3) above can be alleviated by converting the JPEG file with the supplied **JPEG Conversion Tool** [p.78](#) software application.



**Discount-Merchant.com (800) 281-8860**  
THE TRUSTED SOURCE FOR PROJECTOR LAMPS AND ACCESSORIES



# Using the menus 2

## ■ Setup using the Setting display (2)

### ● Projector settings (Be sure to read this subsection.)

Using the factory settings as-is may suffer security damage, so be sure to change the projector settings.

### 1. Press the NETWORK button and press the MENU button twice

### 2. Select a Category

The Setting display (2) is displayed.  
\* Appears only when Network or USB memory input is selected.

Select a category by using .

The following 5 categories are available:

- Network Projector setup** p.51
- Network utility setup** p.51
- Control setting** p.57
- Slideshow setup** p.58
- Status display** p.61



Displays the current settings of selected category. Item shown in gray cannot be set with the currently set conditions of the projector.

### 3. Make settings Press or to open the menu.

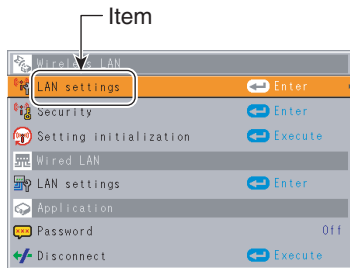

The figure shows a typical example. As the display may differ depending on the item, use the following pages as a reference. While the video file transfer function of Network Utility is in use, the background image of the Setting display (2) does not appear.

### 4. Back RETURN button

### 5. End Press the MENU button or RETURN button.

(The menu disappears 30 seconds after the last operation is conducted.)

## ■ Setting up the Network Projector/Network Utility

If you select **Network Utility**, the following items can be set.

Category	Item	Description
Wireless LAN	<b>Easy Connect (USB memory)</b>	[Yes  No ] → [Enter: ]
	<b>LAN settings</b>	<b>Mode:</b> Ad hoc   Infrastructure <b>SSID:</b> Specify a desired character string (1 to 32 characters). [  : Move left or right one character.] ↔ [() to ()] : Set a character.] <b>DHCP: Use</b> Not use <b>IP address:</b> Enter using the numeric keys of the remote control. [  : Move left or right one character.] ↔ [() to ()] : Set a character.] <b>Subnet mask:</b> Enter using the numeric keys of the remote control. [  : Move left or right one character.] ↔ [() to ()] : Set a character.] <b>Gateway:</b> Enter using the numeric keys of the remote control. [  : Move left or right one character.] ↔ [() to ()] : Set a character.] Confirm: [OK]   [Cancel] → [Enter: ]
	<b>Security</b>	<b>Network authentication:</b> Network Authentication Setting [ or ] : Enter setting] → [ : Selection] → [Enter: ] None/Open/Shared/WPA-PSK/WPA2-PSK <b>Encryption:</b> Select an encryption type using the   button. Off/WEP/TKIP/AES <b>Key index:</b> Select a desired number (1 to 4) using the   buttons. <b>Network key:</b> Specify a desired character string. (WEP: 5 to 13 characters, or 10 to 26 digits in hexadecimal notation) (TKIP/AES: 8 to 63 characters, or 64 digits in hexadecimal notation) [  : Move left or right one character.] ↔ [() to ()] : Set a character.] Confirm: [OK]   [Cancel] → [Enter: ]
	<b>Setting initialization</b>	Reset all the wireless LAN settings. Confirm: [Yes]   [No] → [Enter: ]
Wired LAN	<b>LAN settings</b>	<b>DHCP: Use</b> Not use <b>IP address:</b> Enter using the numeric keys of the remote control. [  : Move left or right one character.] ↔ [() to ()] : Set a character.] <b>Subnet mask:</b> Enter using the numeric keys of the remote control. [  : Move left or right one character.] ↔ [() to ()] : Set a character.] <b>Gateway:</b> Enter using the numeric keys of the remote control. [  : Move left or right one character.] ↔ [() to ()] : Set a character.] Confirm: [OK]   [Cancel] → [Enter: ]

\* To enter characters, use the numeric keypad on the remote control.

## Using the menus 2 (Continued)

Category	Item ▲ ▼	Description
Application	Remote control	Specify whether to allow the remote control of the projector from a computer. <b>Allowed</b> ◀▶ <b>Presentation</b> ◀▶ <b>Forbidden</b> <b>Allowed:</b> The projector always accepts remote commands from a computer. <b>Presentation:</b> Accepts only the remote commands from the computer by which an image is projected on the projector (Update automatically) using Network Utility. <b>Forbidden:</b> Always ignores any remote commands from a computer.
	WEB browser	<b>Browser authentication:</b> Switch on/off the password authentication for access to the setting screen using the Projector Configuration Tool. <p style="text-align: right;">On ◀▶ Off</p>
		<b>Password:</b> Enter the password used to access the setting screen when the <b>Browser authentication</b> is set to <b>On</b> . A character string (1 to 8 characters) can be specified as desired. [◀▶]: Move left or right one character. [↔] [p.] to [wxyz]: Set a character. <b>Confirm:</b> [OK] ◀▶ [Cancel] → [Enter: ⏎]

\* To enter characters, use the numeric keypad on the remote control.

### ● Character entry

Enter characters using numeric keys of the remote control.

Remote control button	Character entry mode	
	Items using characters, numbers, and symbols (e.g., projector name and destination address)	Number only
1 .@	"1" " " " " " " " " " "	"1"
2 ABC	"2" "A" "B" "C" "a" "b" "c"	"2"
3 DEF	"3" "D" "E" "F" "d" "e" "f"	"3"
4 GHI	"4" "G" "H" "I" "g" "h" "i"	"4"
5 JKL	"5" "J" "K" "L" "j" "k" "l"	"5"
6 MNO	"6" "M" "N" "O" "m" "n" "o"	"6"
7 PQRS	"7" "P" "Q" "R" "S" "p" "q" "r" "s"	"7"
8 TUV	"8" "T" "U" "V" "t" "u" "v"	"8"
9 WXYZ	"9" "W" "X" "Y" "Z" "w" "x" "y" "z"	"9"
0 [ ]	"0" "space!"#\$%&'()*+,-./:;<=>?@[ \ ^ _ ` { } ~"	"0"
CLEAR	Deletes one character.	Deletes one character.

### ● Details on individual items

#### • [Wireless LAN settings]

##### <Easy Connect (USB memory)>

This feature allows users to easily connect the projector to a computer over the network, without making **Wireless LAN settings** via **Network Utility**.

##### <Mode>

Your projector is set to **Ad hoc** in the factory. Change the setting if you want to use the projector in **Infrastructure** mode.

##### <SSID>

This is an ID code for connecting to specific individuals over a wireless LAN. This may also be called "**Network group**" or "**Network name**". Please read the following carefully.

Note: When you use the Ad hoc communication mode, if there is a similar **SSID** network group (for example, TDPJ1, TDPJ2, etc.) in the possible communication area, it is possible that your projector name will not be displayed in the **Network Utility** projector list column. If this is the case, set **SSID** to a completely different character string.

**Set the following items if you have set the communication mode to Infrastructure. If you have set the communication mode to Ad hoc for Network Projector setting, the following items should also be set.**

##### <DHCP>

If you set **DHCP** to **Use**, the IP address of the projector is assigned automatically by the DHCP server. If your network environment does not assign IP addresses automatically, set **DHCP** to **Not use**, then set the following items **IP address**, **Subnet mask** and **Gateway** manually.

##### <IP address>

When **DHCP** is set to **Not use**, consult with your network administrator for the settings below and set the **IP address** manually.

An IP address is a unique number assigned to a terminal. The format is a string of four dot-separated three-digit numbers. (Example: 111.112.xxx.xxx)

Note: If you set the same IP address for wireless LAN with the one for wired LAN, network function may fail to operate properly.

##### <Subnet mask>

A subnet mask is used to determine what subnet the IP address assigned to a terminal belongs to. (Example: 255.255.xxx.xxx)

Note: If you set the same subnet work for wireless LAN with the one for wired LAN, network function may fail to operate properly.

##### <Gateway>

This value specifies the IP address of the device, such as a router, to be used to access servers outside the network. (Example: 111.112.xxx.xxx)



## Using the menus 2 (Continued)

- **[Security for wireless LAN settings]**

**<Network authentication>**

Set the authentication to enhance network security. Select a method identical to that of wireless LAN terminal to be connected with.

**<Encryption>**

Set **Encryption** according to the setting you made for **Network authentication**, as follows.

When you have set **Network authentication** to **Open** or **Shared**, select **WEP** for **Encryption**.

When you have set **Network authentication** to **WPA-PSK/WPA2-PSK**, select **TKIP** or **AES** for **Encryption**.

Note: **Network authentication** is factory-set to **None**. If you use the projector with this setting left unchanged, security may be compromised due to access by a third party within the projector's coverage.

**<Key index>**

When you have set **Encryption** to **WEP**, Key index must be set. By default, "1" is selected. Select a key index identical to that of the wireless LAN terminal to be connected with.

Note: Since the range of key index varies by product type (1 to 4 or 0 to 3), make settings with attention.

**<Network key>**

**When you have set Encryption to [WEP]:**

- For use at an encryption level of 64-bit, specify a string of 5 arbitrary characters or a string of 10 characters in hexadecimal notation.
- For use at the 128-bit level, specify a string of 13 arbitrary characters or a string of 26 characters in hexadecimal notation.

**When you have set Encryption to [TKIP]/[AES]:**

Specify a string of 8 to 63 arbitrary characters or a string of 64 characters in hexadecimal notation.

Note 1: Alphabetic characters (A to F, a to f) used in hexadecimal notation are not case sensitive; the uppercase characters and their lowercase equivalents are handled to be identical.

Note 2: The longer the strings of characters set for the Network key, the stronger the encryption becomes, and hence the harder it will be for a third party to decipher your communications. However, the setting of larger encryption may slow down communication speed.

Note 3: To set a higher security level, specify a longer string of characters. For higher security, avoid using a word found in a dictionary and change the key sometimes.

**<Setting initialization>**

This item resets the wireless LAN settings to their factory defaults.

- **[Wired LAN settings]**

**<DHCP>**

If you set **DHCP** to **Use**, the IP address of the projector is assigned automatically by the DHCP server. If your network environment does not assign IP addresses automatically, set **DHCP** to **Not use**, then set the following items **IP address**, **Subnet mask** and **Gateway** manually.

**<IP address>**

When **DHCP** is set to **Not use**, consult with your network administrator for the settings below and set the **IP address** manually.

An IP address is a unique number assigned to a terminal. The format is a string of four dot-separated three-digit numbers. (Example: 111.112.xxx.xxx)

Note: If you set the same IP address for wireless LAN with the one for wired LAN, network function may fail to operate properly.

**<Subnet mask>**

A subnet mask is used to determine what subnet the IP address assigned to a terminal belongs to. (Example: 255.255.xxx.xxx)

Note: If you set the same subnet work for wireless LAN with the one for wired LAN, network function may fail to operate properly.

**<Gateway>**

This value specifies the IP address of the device, such as a router, to be used to access servers outside the network. (Example: 111.112.xxx.xxx)

- **[Application]**

**<WEB browser>**

**Browser authentication**

**Browser authentication** and **Password** are factory-set to **Off** and no string, respectively. You should set them as soon as possible.

**Password**

If you have forgotten your password, set it again using the menu on the main unit.

## Using the menus 2 (Continued)

### Note

- If you select [Network Projector] in the **Setting display (2)** menu, the same items in [Network Utility] will be displayed except for the following 2 items.
  - [Easy Connect (USB memory)] feature is not available.
  - In the item [Application], [Password] and [Disconnect] are available as follows.

Category	Item ▲ ▼	Description
Application	*** Password	Set password <span style="float: right;">On ◀ ▶ Off</span>
	Disconnect	Disconnect while transferring an image using Network Projector. [Yes ◀ ▶ No] → [Enter: ⏎]

See “Setting the Network Projector/Network Utility” p.51 to conduct adjustments and settings for Network Projector.

## Computer settings

Refer to instruction manuals of your computer or wireless LAN adapter to perform the following settings.

- Select **Ad hoc** (for some wireless LAN adapters, this is **Peer-to-Peer Group**).
- Set **SSID** (for some types of wireless LAN adapter, use **Network name** instead) as the same as projector’s **SSID** (at factory shipment, this is set to **TDPJ**).
- If **Encryption**, **Network authentication**, **Key index** and **Network key** are set on the projector, set to the same values.

### Note

- The Easy Connect utility p.70 allows users to easily connect the projector to a computer over wireless networks, without making wireless LAN settings. For Easy Connect support, the computer requires a wireless LAN environment that is NDIS5.1 or higher driver compliant.  
Refer to the user’s manual supplied with the wireless LAN adapter or the wireless LAN embedded computer for more information.

## The control setting menu

This menu sets Projector name, Email function and PJLink function, etc. Select **Control setting** in step 2 in “Projector settings” p.50. The following content will be displayed.

Item ▲ ▼	Description
<b>Projector name</b>	Specify a desired character string (0 to 16 characters). [◀ or ▶ : Enter setting.] → [▲ ▼ : Select item.] ↔ [◀ ▶ : Move left or right one character.] → [0 to wxyz] : Set a character. <b>Confirm:</b> [OK ▶ ▶ Cancel] → [Enter: ⏎]
<b>Email</b>	[◀ : E-mail setting] → [▲ ▼ : Select item]
	<b>Status notification:</b> On ▶ ▶ Off
	<b>SMTP server:</b> Enter a character string using numeric keys of the remote control.
	<b>Port number:</b> Enter a character string using numeric keys of the remote control.
	<b>Destination address:</b> Enter a character string using numeric keys of the remote control. <b>Confirm:</b> [OK ▶ ▶ Cancel]
<b>PJLink</b>	[◀ : PJLink setting] → [▲ ▼ : Select item]
	<b>PJLink authentication:</b> On ▶ ▶ Off
	<b>Password:</b> Enter a character string (1 to 32 characters) using numeric keys of the remote control. <b>Confirm:</b> [OK ▶ ▶ Cancel] → ⏎
<b>Wireless network</b>	[◀ or ▶ : Enter setting.] → [▲ ▼ : Select item.] ↔ [Enabled ▶ ▶ Disabled] <b>Confirm:</b> [OK ▶ ▶ Cancel] → [Enter: ⏎]

### Detailed description

- [Projector name]**  
This can be used to identify projectors when communicating with multiple projectors, or if there is a possibility that another person who is out of communication range will be using the same projector. It is recommended this is set to prevent wrong transmission.
- [Email]**  
<**Status notification**>: Sends alarm information to the specified E-mail address when an error such as lamp blowout occurs.  
<**SMTP server**>: Set an IP address of the SMTP server.  
<**Port number**>: Enter a port number of the SMTP server.  
<**Destination address**>: Enter within 60 characters. (Example: xxx@xxx.xxx)
- [PJLink]**  
<**PJLink authentication**>: Set whether or not to authenticate the user by password when the projector is accessed via the PJLink-compliant Software Application. (Set [On] or [Off].)  
<**Password**>: Enter a password for confirmation when the above <**PJLink authentication**> is set to [On].

## Using the menus 2 (Continued)

### ■ Precautions

- When purchased, <PJLink authentication> is set to [Off] and <Password> is not set by factory setting. You are recommended to make authentication setting as soon as possible.
- If you forget a password, set it again.

### • [Wireless network]

If you set **Wireless network** to **Disabled**, the wireless LAN connection will be unusable. Set **Wireless network** to **Disabled** when you do not wish to use the wireless LAN for network connection.

### ■ Note

- The Email function does not support transmission to the SMTP server that requires authentication.

## ■ Setting slideshow options

**Slideshow** is the function to allow users to display JPEG and MPEG image files saved in a USB memory.

If you select **Slideshow**, the following items can be set.

Category	Item ▲ ▼	Description
Still Image	Auto. demo	On ◀ ▶ Off (Select whether to automatically start a slide show when a USB memory is plugged.)
	Interval	Select the slide show display interval. ◀ or ▶ : Begin a slide show. Use the ▲ ▼ buttons to select. 5 sec./10 sec./30 sec./1 min./3 min./5 min./10 min.
	Display effect	Select the slide show display effect. ◀ or ▶ : Begin a slide show. Use the ▲ ▼ buttons to select. None / Wipe ↑ / Wipe ↓ / Wipe ← / Wipe → / Dissolve / Cover ↑ / Cover ↓ / Cover ← / Cover →
Movie Image	Auto. start	On ◀ ▶ Off (When a file is selected, start playing the file automatically.)
	Repeat	On ◀ ▶ Off (Play repeatedly after the end of playing)
Common	Play icon	Standard ◀ ▶ Continuous
	Thumbnail display	Switch the form of a thumbnail list. All ◀ ▶ File ◀ ▶ Off
	Unplug device	Run when unplugging a USB device. Yes ◀ ▶ No

### ● Details on individual items

#### Still Image

##### • [Auto. demo]

**On:** A slide show begins automatically when a USB memory is inserted and input switches to USB memory. At this time, the JPEG files in the root directory of the USB memory are used in the slide show. If the input has already been switched to USB memory, the slide show begins automatically when the USB memory is inserted.

- To pause the slide show, press the ⏸ button. Pressing this button again allows the slide show to begin. To stop the slide show, press the **RETURN** button.

**Off:** A list of thumbnails will be displayed when connecting with a USB memory or the like. Select a desired file from the list.

#### ■ Notes

- The Auto Demo function does not work when using a USB memory card reader/writer to mount multiple media.
- The Auto Demo function is available for JPEG files only.

##### • [Interval]

You can set the display interval of time (in seconds or minutes) for slide shows to be played automatically.

##### • [Display effect]

When playing a slide show, the projector can give various display effects or transitions to each slide being displayed.

The transitions available are listed below:

##### • None

Display each slide normally.

##### • Wipe

Display the next slide gradually upward (Wipe ↑), downward (Wipe ↓), to the left (Wipe ←), or to the right (Wipe →), over the current slide.

##### • Dissolve

Display the next slide gradually in a certain fixed block pattern over the current slide.

##### • Cover

Display the next slide as sliding upward (Cover ↑), downward (Cover ↓), to the left (Cover ←), or to the right (Cover →), over the current slide.

#### Movie Image

##### • [Auto. start]

**On:** Start playing a video file automatically when it is selected.

##### • [Repeat]

**On:** Repeat automatically from the beginning when the file reaches the end.

## Using the menus 2 (Continued)

### Common

- **[Play icon]**  
The slideshow icon can be displayed.
  - **Standard**  
The projector handles the slideshow icon as follows depending on the “On/Off” setting of **Icon** on the projector’s menu.  
**Icon On:** The projector displays the icon upon the start of playing a slide show and turns it off after a few seconds.  
**Icon Off:** The projector does not display the icon.
  - **Continuous**  
The projector keeps the icon displayed during the slide show.
- **[Thumbnail display]**  
Select the form of a thumbnail list.  
**All:** Displays a thumbnail preview of JPEG files, and if any JPEG files exist in the folder displays the leading thumbnail image.  
**File:** Displays only a thumbnail image of JPEG files. The thumbnail image of the JPEG files in the folder is not displayed.  
**Off:** Displays an icon without displaying thumbnail preview.

### Note

- Thumbnail image of MPEG files can not be displayed.
- **[Unplug device]**  
Run when unplugging a USB memory, a USB memory card reader/writer or a digital camera and the like.



Discount-Merchant.com  
THE TRUSTED SOURCE FOR PROJECTOR LAMPS AND ACCESSORIES

## Checking the projector status

### Status display

To check the current status of the projector, select **Status display** in step 2 in “**Projector settings**” [p.50](#). The following items of information will then be displayed.

<b>Application</b>	The name of the application currently running on the projector is displayed. (Examples: Slideshow, Network Utility)
<b>Details</b>	When inputting from USB memory “Free space/Status” are displayed.  When inputting from network For wireless LAN, “MAC address/Mode/Channel/SSID/Encryption/IP address/Subnet mask/Gateway” are displayed. For wired LAN, “Connection status/MAC address/IP address/Subnet mask/Gateway” are displayed. PJLink class is displayed.
<b>Version</b>	The firmware version number of the network feature and the USB memory feature is displayed.

## Using the Network Projector

### Setting up the projector

- 1 **Turn the projector power on.**
- 2 **Switch the input to Network.**  
Make sure to set the projector’s input to Network. If the other inputs are selected, the projector will not be recognized by the computer.
- 3 **A password prompt will be displayed.**  
A password prompt will be displayed only when [Password] is set to [On] in the **Application** category of the **Network Projector settings**.
- 4 **By referring to “Using the menus 2”, make the wireless LAN or wired LAN settings.**

### Setting up the computer

- 5 **Make the wireless LAN or wired LAN settings. Please see the help function of your computer for details.**
- 6 **Open the [Connect to a Network Projector] wizard by clicking on the [Start] button, by clicking [All Programs], then clicking [Accessories], finally clicking [Connect to a Network Projector].**
- 7 **Select the desired projector from the list or enter the projector address.**
- 8 **When the password prompt is displayed in step 3, enter the password.**

# Installing the applications

If you want to use the projector's internal wireless LAN function, install the Network Utility on the supplied CD-ROM onto your computer.

## ■ System Requirements

Supported OS: Windows® 2000, Windows® XP and Windows Vista™ (Ultimate, Business)  
(Windows® 98SE and Windows® ME are supported by JPEG Conversion Tool.)

CPU: Pentium M 1 GHz or higher recommended

RAM: 256 MB or more recommended

Screen area (resolution): 1280 by 800 pixels recommended

\* The system requirements may vary depending on the conditions of use.

### ■ Notes

- Some functions of applications may not be operational with Windows Vista™.
- The Windows Vista™ 64-bit version is not supported.

## ■ Application Types and Major Functions

### Network Utility

This application is used for network connections. Use it to send the images from the computer's screen to your projector, and display on the screen. In addition, also use it to transmit the sound being played on a computer to the projector.

### JPEG Conversion Tool

Use to convert JPEG and other files into a format that can be displayed as a slide show using a USB memory.

## ■ How to install

Run the CD-ROM and double-click on **Start.pdf**. Acrobat® Reader™ launches, and a screen appears asking you that "**Select your model**", then click on the model name that you are using. After you select **Application** on the next screen, click on **Network Utility** and **JPEG Conversion Tool** in the application items and run **setup.exe**, respectively. Follow the on-screen instructions.

During the installation, a dialog box may appear with the message "**Digital Signature Not Found**" and the prompt "**Do you want to continue the installation?**". Click on the [**Yes (Y)**] button to continue the installation.

When installation is finished, the following shortcuts will appear on your computer's desktop:

Network Utility →



JPEG Conversion Tool →



FixYourDLP.com  
Operations p.64 Sponsored by

Discount-Merchant.com (800) 281-8860  
Operations p.78

THE TRUSTED SOURCE FOR PROJECTOR LAMPS AND ACCESSORIES

## ■ How to uninstall

Uninstall [**Toshiba Data Projector**] and [**Jpeg Conversion Tool**] programs by using a program removal utility in the [**Control Panel**].

### ■ Notes

- Your computer screen may temporarily go out during installation, but it is not an error.
- Before beginning installation or uninstallation, you need to log on as Administrator.
- When the projector is operated using Windows Vista™, it is required to **run application as an administrator**. See the help section of the application for details.



# Using the Network Utility

## ■ Displaying a computer's screen via the projector

### 1 Launch the Network Utility software application.

When the **Network Utility** launches, the **Screen Image** transmission mode window appears on the computer screen.

To switch to the **Screen Image** transmission mode window from another mode, click on the **Screen Image** icon .

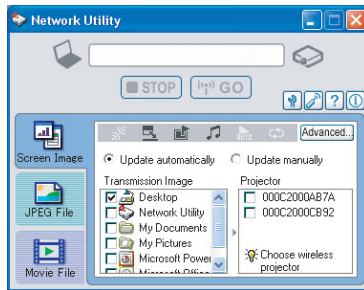

### 2 Select Transmission mode.

Click on **Update automatically** or **Update manually**. See step 6 for the meanings of **Update automatically** and **Update manually**.

### 3 Click on the Advanced button.

The **Screen Image: Advanced Settings** dialog appears. Set the dialog as shown below, as necessary.

#### • Interruption

Check the **No Interruptions** checkbox to prevent other computers from interrupting the projector, for example, during presentation.

#### • Window Display

Select the **Place in Tasktray at the start of transmission** checkbox to iconify the **Network Utility** and place it in the computer's tasktray when transmission initiated.

To display the window, double click on this icon, or right click and select **Open** from the popup menu. Even with the **Network Utility** window minimized, you can use the popup menu to stop or resume transmission as described in step 4 and later.

#### • Transmission Mode (Image)

Selecting **High quality** improves the quality of the projected image, but lowers communication speed. Selecting **High speed** has the opposite effect.

#### • Transmission Mode (Sound)

Check the **Transmit sound to a projector (Only when connected with only one projector)** checkbox to transmit the sound being played on a computer to the projector.

Note: The sound can be sent when one projector is selected.

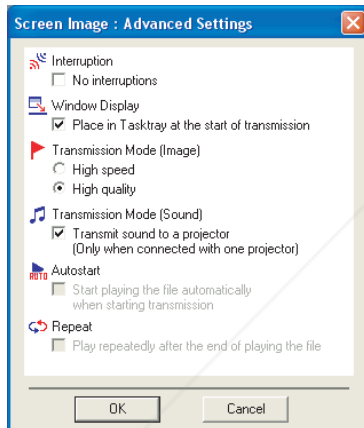

### 4 Select the screen image you wish the projector to display.

#### Select Desktop

The computer screen image is transmitted as-is.

#### Select application window

Select a running application (e.g. Microsoft® PowerPoint®), and send that application's window only.

The desktop and a list of running applications are displayed. Select the desired application from this list. (If the desired application is not on the list, launch it. Note that if too many applications are running, it will consume the computer's resources, which could slow communication speed.)

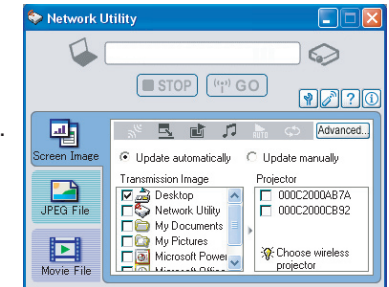

### 5 Select the projector to be transmitted.

The IDs of projectors accessible for transmission will be listed. (When a projector name is set, that name appears instead of MAC address.)

Select the checkbox of the projector you wish to transmit to from this list. Then icon  is displayed on the projector's screen for a few seconds.

It is possible to select up-to four projectors.

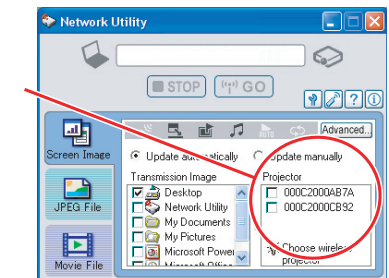

### 6 Click on the GO button.

When **“Update automatically”** is selected in step 2

Screen images are sent consecutively after the **GO** button is clicked. Besides, the sound being played on a computer can be sent to the projector.

When **“Update manually”** is selected in step 2

A single screen image is sent when the **GO** button is clicked.

### 7 To halt transmission from Update automatically, click on the STOP button.

If the **Network Utility** icon has been placed in the tasktray, double click on the icon to display the window, then halt transmission, or right click on the icon, and halt transmission.

#### ■ Notes

- It may not be possible to transmit the images from movie player or other video applications.
- When using **“Update automatically”**, the transmitted image refresh rate depends on the performance of the computer you are using and the surrounding radio wave environment.
- The projector screen may have a few differences from the computer screen.
- If you selected application window in step 4, if that application is not active (in use), the image may not be correctly displayed by the projector.
- The projector ID is the MAC address of the wired LAN inserted into the projector.
- Playing contents protected by copyright is not supported.

## Using the Network Utility (Continued)

- To transmit sound, press the **GO** button then launch the application that plays the contents including the sound. When you operate the projector using Windows Vista™, “**Switching audio play device**” window will be displayed after pressing the start button of Network Utility. Follow the instruction to switch the audio play device, and then launch the application that plays the contents including sounds.
- If no sound can be heard from the computer though the connection is stopped, re-launch the application that plays the contents including the sound.
- Transmission may not be available depending on the sound type.
- Sound cannot be transmitted if multiple projectors are selected.
- The audio signals transmitted by a computer become mono.

### ■ Displaying a JPEG image saved on a computer via the projector

#### 1 Launch the Network Utility software application.

The **Screen Image** transmission mode window appears on the computer's screen.

#### 2 Click on the JPEG File icon

The Network Utility window changes to **JPEG File** transmission mode.

#### 3 Click on the Browse button, and select the file to send.

Clicking on the **Browse** button displays the **Open** dialog box. Select the file to send, then click on the **Open** button.

The selected file is added to the pull-down list in the **Network Utility's Transmission File** field.

#### 4 Select the file to be sent from the pull-down list of the Transmission File field.

Click on the **Transmission File** field's **▼** button to display the pull-down list. Select the file to be sent from this list.

A thumbnail of the selected file appears **Preview** box. The file displayed here will be transmitted.

Step 3 can be skipped.

The way that drag and drop the file to be sent from the desktop or Windows Explorer into the **Preview** box is also available. In this case as well, the selected file is added to the file pull-down list **Transmission File** field's.

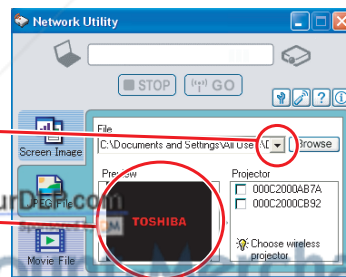
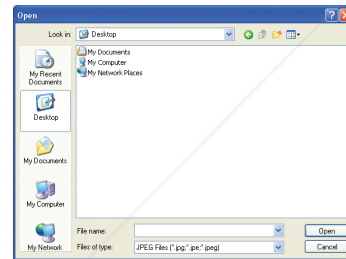
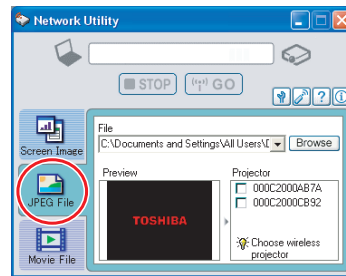

#### 5 Select the projector to be transmitted.

The IDs of projectors accessible for transmission will be listed. (If projector name has been set up already, it is shown instead of the MAC address.) Select the checkbox of the projector to be transmitted from this list. Then icon is displayed on the projector's screen for few seconds.

It is possible to select up-to four projectors.

#### 6 Click on the GO button.

The selected file's image is displayed by the projector.

#### ■ Notes

- Only one file can be sent at a time. To send another file, repeat steps 4 and 6.
- Selecting a file by drag and drop may not be available with Windows Vista™.

### ■ Displaying a video file saved on a computer via the projector

#### 1 Launch the Network Utility software application.

The **Screen Image** transmission mode window appears on the computer's screen.

#### 2 Click on the Movie File icon.

The **Network Utility** window changes to **Movie File** transmission mode.

#### 3 Click on the Advanced button.

The **Movie file: Advanced Settings** dialog appears. Set the dialog as shown below, as necessary.

##### • Interruption

Check the **No Interruptions** checkbox to prevent other computers from interrupting the projector, for example, during presentation.

##### • Transmission Mode (Sound)

Check the **Transmit sound to a projector (Only when connected with one projector)**

checkbox to transmit the sound being played on a computer to the projector.

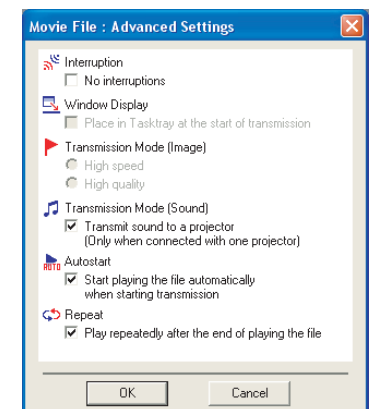
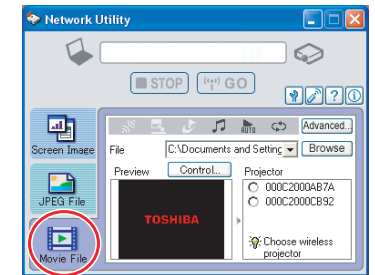
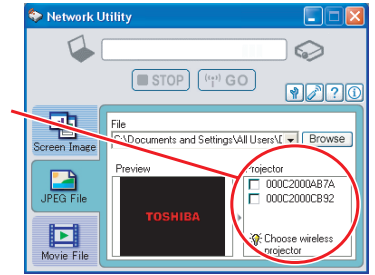

## Using the Network Utility (Continued)

### • Autostart

Check the **Start playing the file automatically when starting transmission** checkbox to automatically start playing the video file when connecting to the projector.

### • Repeat

Check the **Play repeatedly after the end of playing** checkbox to automatically repeat from the beginning when the file reaches the end.

## 4 Click on the Browse button and select the file to send.

Clicking on the **Browse** button displays the **Open** dialog box. Select the file to send then click on the **Open** button.

The selected file is added to the pull-down list in the **Network Utility's Select file** field.

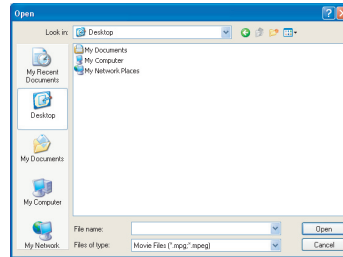

## 5 Select the file to send from the pull-down list of the Transmission File field.

Click on the **Transmission File** field's  button to display the pull-down list. Select the file to send from this list.

A thumbnail of the selected file appears in the **Preview** box. The file displayed here will be transmitted.

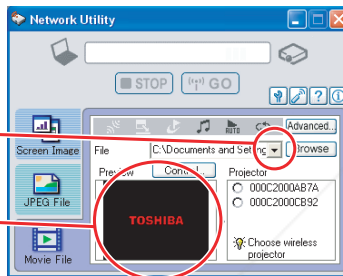

Step 4 can be skipped.

The way that drag and drop the file to send from the desktop or Windows Explorer into the **Preview** box is also available. In this case as well, the selected file is added to the pull-down list.

### Note

- Selecting a file by drag and drop may not be available with Windows Vista™.

## 6 Select the projector to transmit to.

The IDs of projectors accessible for transmission will be listed. (If projector name has been set up already, it is shown.) Select the checkbox of the projector to be transmitted to from this list. When the  icon is displayed on the projector's screen for few seconds.

It is possible to select only one projector.

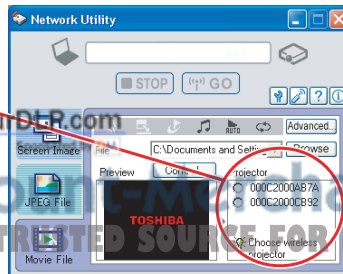

## 7 Click on the button.

The selected file's image is displayed by the projector and the Control window appears as well.

## 8 Play the video file via the Control window.

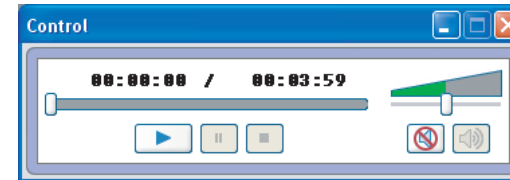

The function of each button and box is as follows:

**Current position:** Indicates the playing position. Dragging the slider can move the playing position.

**Play:** Starts playing the video file.

**Freeze:** The picture is paused.

**Stop:** Stops playing the video file.

**Volume:** Adjusts sound volume.

**Mute:** Cuts off picture and sound.

**Release mute:** Restores picture and sound.

### Notes

- Only one file can be sent at a time. To send another file, repeat steps 5 and 7.
- MPEG/AVI/ASF/WMV files can be transmitted.
- The update speed of the transmitted file depends on your computer's performance and the surrounding radio environment.
- The projector ID is the MAC address of the wired LAN mounted on the projector.
- The audio signals transmitted by a computer become mono.
- Playing contents protected by copyright is not supported.



## Using the Network Utility (Continued)

### ■ Easy Connect utility

This feature allows users to easily connect the projector to a computer over wireless networks, without making **Wireless LAN settings** via **Network Utility**.

Launch the **Network Utility** software application and click the Tool button  to bring up the **Wireless LAN Settings Utility** dialog box. Select a desired connection mode in this dialog box.

#### ● How to set up a simple 1:1 connection

##### • Setting on the projector

- 1 Turn the projector power on.
- 2 Switch the input to Network.
- 3 Press the  button on the projector control panel.

##### • Setting on the computer

#### 4 Launch the Network Utility software application.

When the **Network Utility** launches, the **Screen Image** transmission mode window appears on the computer screen.

#### 5 Click the Tool button .

The **Wireless LAN Settings Utility** dialog box appears.

#### 6 Select Simple 1:1 connection then click OK.

The connection starts up. When a connection confirmation message appears, proceed as instructed in the message.

#### 7 When the connection is complete, the computer screen image is transmitted.

If the transmission does not start, uncheck the **Confirm and immediately transmit screen image** checkbox.

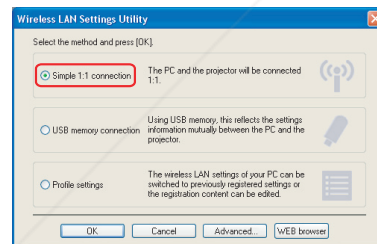
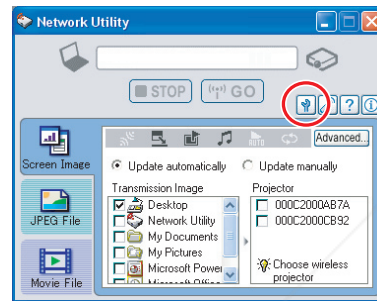

### ■ Notes

- This operation is allowed only when the Transmission mode is set to **Ad hoc** in the projector's wireless LAN settings.
- The operation procedure of the projector setting and the computer setting can be altered without affecting the connection setup, assuming the operation on each side is complete within 60 seconds.
- Be sure to use Network Utility version 5.0.

### ● How to connect USB memory

Set up wireless LAN using a commercial USB memory. See [p.49](#) for available USB memories.

#### 1) Copying the computer settings to the projector

##### • Setting on the computer

#### 1 Insert the USB memory into the USB terminal slot on the computer.

#### 2 Click the Tool button of the Network Utility to bring up the Wireless LAN Settings Utility dialog box. Select USB memory connection and click OK.

The dialog box for USB memory connection appears.

#### 3 Select [Projector settings] and click OK, then enter the required setting items and click OK.

The setting information is saved to the USB memory.

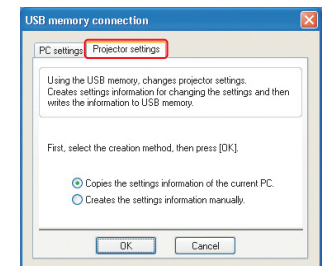
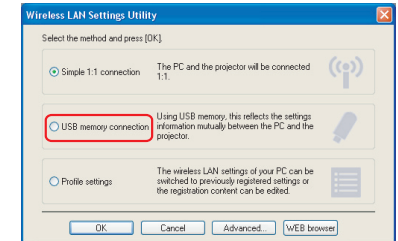

#### 4 Unplug the USB memory from the computer.

To unplug the USB memory, follow the instructions in the user's manual supplied with the USB memory or the computer.

##### • Setting on the projector

#### 5 Turn the projector power on.

#### 6 Switch the input to Network.

#### 7 Insert the USB memory into the projector.

A message appears, notifying that the projector settings have been changed.

#### 8 The projector name or the projector ID (MAC address of wired LAN) will be displayed on the computer's screen.



FixYourDLP.com

Sponsored by CAI



Discount-Merchant.com (800) 281-8860

THE ONLINE SOURCE FOR PROJECTOR LAMPS AND ACCESSORIES

## Using the Network Utility (Continued)

### 2) Modifying the computer settings using the projector settings

#### • Setting on the projector

- 1 Turn the projector power on.
- 2 Switch the input to Network.
- 3 Press the MENU button twice, then select Easy Connect (USB memory) in Network Utility settings from the Setting display (2) menu and press the  button.
- 4 When a confirmation window appears, insert the USB memory into the projector.
- 5 Click Yes then press the  button.  
The wireless LAN settings are saved to the USB memory. When successfully saved, a message appears.
- 6 Unplug the USB memory.

#### • Setting on the projector

- 7 Launch the Network Utility software application.
- 8 Insert the USB memory into the computer.
- 9 After a confirmation message appears, make settings.
- 10 When the setting is complete, the projector name of the connected projector or the projector ID (MAC address of wired LAN) is displayed.

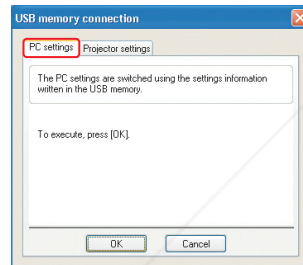

#### ■ Note

- This operation is allowed only when the Transmission mode is set to **Ad hoc** in the projector's wireless LAN settings. Be sure to use Network Utility version 5.0.

#### ● Profile settings

This feature allows the user to save the computer's wireless LAN settings. This feature is useful when you need to change wireless LAN settings according to where you use.

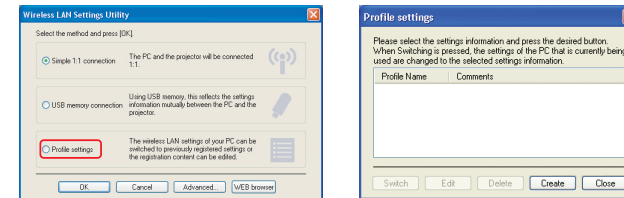

#### ● Advanced setting

This feature allows the user to set details for Easy Connect settings. Make the following settings as required in this dialog.

- **Registering profile automatically**  
Check this checkbox to automatically register the settings of the Easy Connect as profile setting data.
- **Switching settings automatically at start-up**  
Check this checkbox to automatically switch to the last used wireless LAN settings when launching the Network Utility.

#### ● WEB browser

Where the computer and the projector are connected over the network, bring up the window of Projector Configuration Tool by pressing the **WEB browser** button.

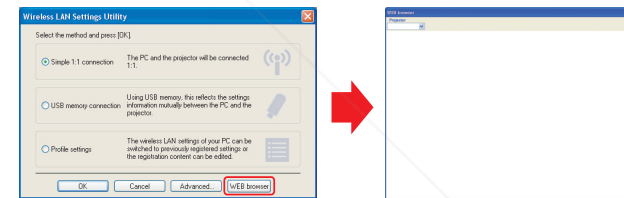

#### ■ Precautions

- If the page is not displayed correctly, re-select the projector.
- When the network settings are changed, the network connection is disconnected. If you wish to reconnect, set up the computer again.

#### ■ Precaution

- The simple 1:1 connection, the USB memory connection and the profile setting may not work normally depending on the type of the wireless LAN adapter and the wireless LAN embedded computer. When such a case arises, use the Network Utility menu to make necessary wireless LAN settings manually.



## Using the Network Utility (Continued)

### ■ Operating the projector

This function can be used with any projector input.

#### 1 Launch the Network Utility software application.

The **Screen Image** transmission mode window appears on the computer's screen.

#### 2 Click on the Remote Control button.

The **Remote Control** window appears.

As the **Network Utility** window is still displayed, you can operate the projector via the **Remote Control** window, while using the Network Utility's functions.

While it is possible to use this function merely to operate the projector, closing the **Network Utility** also closes the **Remote Control** window.

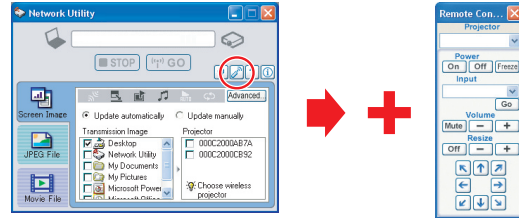

#### 3 Select the projector to be operated.

In the **Remote Control** window, click on the button, and select the desired projector from the pull-down list. When you make a selection, the **Remote Control** window displays as shown in the right figure.

Only one projector can be selected. (It is not possible to operate multiple projectors.)

#### 4 Click on the Remote Control window's buttons.

The function of each button and box is as follows:

**Power On:** Turns projector power on.

**Power Off:** Turns projector power off.

**Freeze:** The picture is paused.

**Input (box):** Click on the button, and select the desired input from the pull-down list.

**Go:** Switches to the input selected in the Input box.

**Mute:** Cuts off picture and sound. Click again to restore picture and sound.

**Volume +/-:** Adjust sound volume.

**Resize Off** Restores the picture to its original size.

**Resize +/-:** Adjusts the enlargement ratio.

: Move screen (up/down/left/right/diagonal)



#### 5 To quit, click on the button on the Remote Control window.

Performing this does not close the **Network Utility** window.

To exit both the **Network Utility** and the **Remote Control**, click on the button on the **Network Utility** window.

## Projecting images stored in a USB memory

### ■ Playing a slide show from a thumbnail list

With **Auto. demo** set to **Off** in "**Setting slideshow options**", data readout begins when a USB memory is inserted and the input switches to USB memory. A list of thumbnails will then appear on the screen.

The figure below is an example of this process:

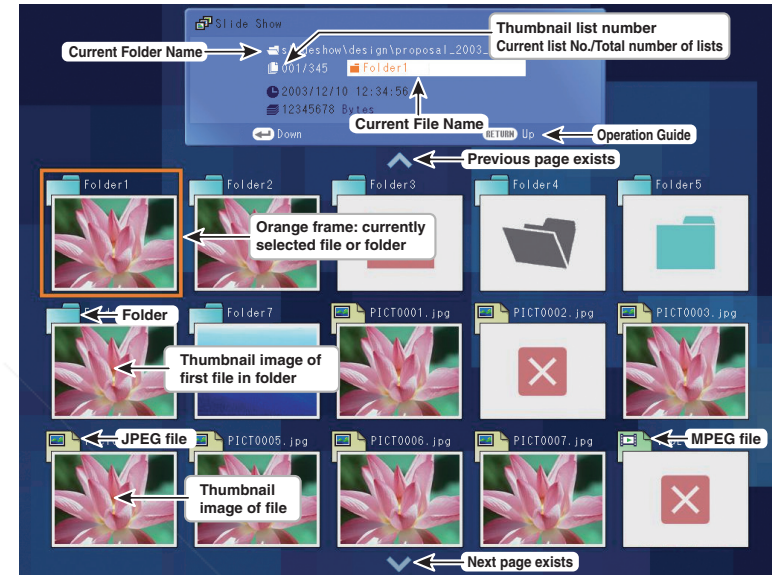

#### Symbols in the thumbnail list



Indicates that only folders are inside the folder.



Indicates that there is no data to be displayed in the folder.



Indicates that the JPEG, MPEG or other file is not supported.



Indicates that an unsupported JPEG, MPEG or other file is present.



When the **Thumbnail display** is set to **Off**, the screen appears like this.

## Projecting images stored in a USB memory (Continued)

### 1 Plug a USB memory.

Plug a USB memory according to the procedure in "Connecting USB device" [p.48](#).

The projector starts loading data from the USB memory and displays a thumbnail list on the screen.

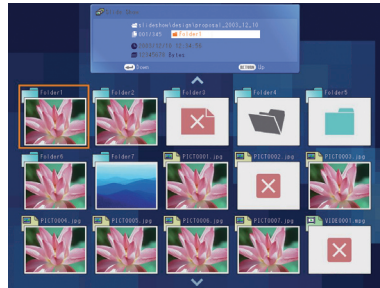

### 2 Searching for a target file

- Use the **▲** **▼** **◀** **▶** buttons to move the orange frame over the desired file or folder.
- If there are multiple pages of thumbnails, click the **▼** button on the bottom row to go to the next page, and the **▲** button on the top row to go to the previous page.
- To open a folder, move the orange frame to the desired folder and press the **▶** button. You can navigate down up to 5 levels using the same procedure. Pressing the **RETURN** button returns you to the next or other upper level folder.

### For JPEG files

### 3 Displaying slides

- Pressing the **▶** button with a file selected displays the image in that file only in full-screen view on the screen as a slide. Pressing the **▶** button enters the automatic play mode.
- To return to the thumbnail list display screen, press the **RETURN** button.

### 4 Changing slides

Pressing the **◀** **▶** buttons with a slide displayed changes slides.

(**◀** : previous slide; **▶** : next slide. These buttons are not available during an automatic play.)

### 5 Rotating a slide

Pressing the **▲** **▼** buttons with a slide displayed rotates the slide 90 degrees. The rotation information is preserved as long as you remain in the current folder.

(**▲** : Rotate left; **▼** : Rotate right. These buttons are not available during an automatic play.)

### For MPEG files

### 3 Displaying video

- Pressing the **▶** button while a file is selected plays only the video image in full-screen view. Pressing the **▶** button again pauses the video image.
- To return to the thumbnail list display screen, press the **RETURN** button.

### 4 Fast-forwarding and rewinding video images

- Pressing the **▲** **▼** buttons while a video image is displayed fast-forwards or rewinds the video image.  
(**▲** : Fast-forward; **▼** : Rewind)

### Notes

- The thumbnail display order and slide order goes in order from shortest file name to longest. If two file names have the same number of characters, they are ordered numerically if numbers are used in the file name, and alphabetically otherwise.
- It is possible to give presentations without using a computer by converting presentations created with Microsoft® PowerPoint® into JPEG files using the **JPEG Conversion Tool**, and storing them on a USB memory. [p.78](#)  
Note, however, that functions such as animation effects and hyperlinks cannot be used, so it should be tested before the actual presentation.
- Freeze function can not be used during slide show or automatic play.
- A slide show is terminated when the input is switched to another.
- With some USB memories, the slideshow playback may stop in the midway. When encountering such a phenomenon, use another USB memory because the current one is not supported.
- Pressing the **GUIDE** button on the remote control with a slide displayed displays the operation guide for slideshow.
- When you operate the projector using the USB memory card reader/writer, up to 4 media types are supported.



**Discount-Merchant.com (800) 281-8860**  
THE TRUSTED SOURCE FOR PROJECTOR LAMPS AND ACCESSORIES

# How to use the JPEG Conversion Tool

The **JPEG Conversion Tool** converts JPEG files not supported by the projector, image files in other formats, Microsoft® PowerPoint® files, and the like into JPEG files supported by the projector. The JPEG files converted with this tool can be displayed by sending them using the wireless LAN [p.66](#), or saving them on a USB memory.

## ■ Launching the JPEG Conversion Tool

The window shown in the figure to the right appears on the computer screen.

Drag the **Image Quality Settings** slider to the left or right to set the image quality of the file after conversion. Lower values create smaller files, but lower the image quality. (It is not possible to restore the quality of an image after it has been lowered.)

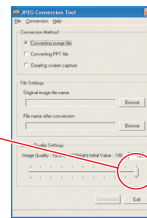

## ■ Converting an image file

This converts JPEG files using compression formats not supported by the projector, Windows® metafiles (wmf), and bitmapped files (bmp) into JPEG files.

(1) In the **Conversion Method** field, select **Converting image file**. (Status on launch)

(2) In the **File settings** field, click on the **Browse** button for **Original Image File Name**.

The **Open** dialog box appears.

(3) In the **Open** dialog box:

- Specify the location of the file to be converted; and
- In the **Files of Type** field, click on the **▼** button to select the file format. A list of files of that format appear in the **Open** dialog box.

(4) In the **Open** dialog box, select the file to convert, then click on the **Open** button.

(5) In the **JPEG Conversion Tool** window, in the **File settings** field, select **Browse** for **File name after conversion**. The **Save As** dialog box appears.

(6) In the **Save As** dialog box:

- Specify the location in which to save the converted file;
- Enter a file name of up to 8 characters in the **File Name** field; and
- Press the **Save** button.

(7) (a) In the **JPEG Conversion Tool**, click on the **Conversion** button.

(b) The resolution selection dialog box appears. Select a desired resolution and click on the **OK** button.

(c) A confirmation dialog box opens. Click **Yes**. The computer converts the file. When it finishes a message appears informing you that a **"JPEG file has been created"**.

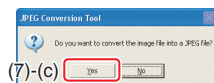
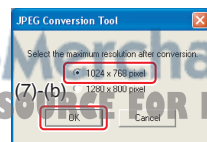
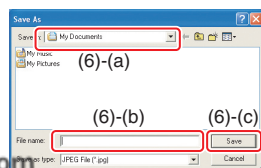
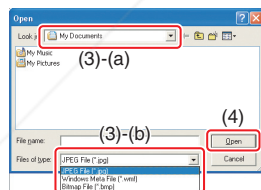
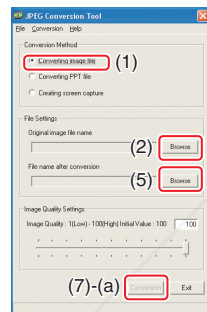

## ■ Converting files created with Microsoft® PowerPoint®

This process provides presentations without using a computer by converting presentation files created with Microsoft® PowerPoint® into JPEG files, storing them on a USB memory, and displaying them in a slide show.

- To use this conversion mode, Microsoft® PowerPoint® must be installed on the computer.
- Only static images are supported by this process. Animation and audio are not supported.

Presentation files created with Microsoft® PowerPoint® usually consist of several slides. For this reason, the tool creates a folder with the name specified in step (5), below, and file for each slide is created in the folder (starting with slide001.jpg).

(1) In the **Conversion Method** field, select **Converting PPT file**.

(2) In the **File settings** field, click on the **Browse** button for **PPT File Name**.

The **Open** dialog box appears.

(3) In the **Open** dialog box:

- Specify the location of the file to be converted; and
- Select the PowerPoint® presentation file to convert, then click on the **Open** button.

(4) In the **JPEG Conversion Tool** window, in the **File settings** field, click on the **Create** button for **New folder name**.

The **Folder create** dialog box appears.

(5) In the **Folder create** dialog box, in the **Folder Name of document** of document field, specify a folder name of 12 characters or less.

(6) In the **Folder create** dialog box, click on the **Selection** button. The **Browse Folders** dialog box appears.

(7) In the **Browse Folders** dialog box:

- Specify the location in which to save the folder; and
- Click on the **OK** button.

(8) In the **Folder create** dialog box:

- Click on the **Create** button. A confirmation dialog box appears;
- Click on the **OK** button.

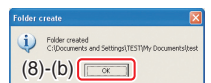
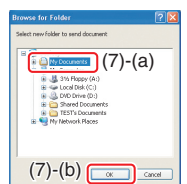
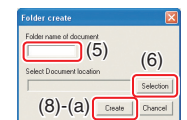
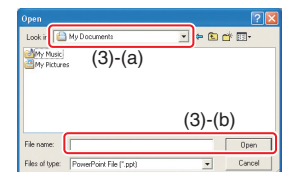
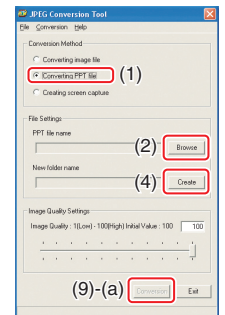

Operations



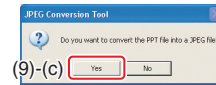
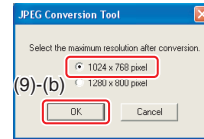

## How to use the JPEG Conversion Tool (Continued)

- (9) (a) In the **JPEG Conversion Tool** window, click on the **Conversion** button.
- (b) The resolution selection dialog box appears. Select a desired resolution and click on the **OK** button.
- (c) A confirmation dialog box opens. Click **Yes**.  
The computer begins to convert the file. When it finishes, a message appears informing you that a “**JPEG file has been created**”.



### ■ Making a presentation with converted JPEG files

- (1) Copy the folder created by the **JPEG Conversion Tool**, or its contents, onto a USB memory.
- (2) Use the step 1 in “**Playing a slide show from a thumbnail list**” p.75 to display a list of thumbnails.
- (3) Follow the instructions in step 2 in “**Playing a slide show from a thumbnail list**” p.75 to find the thumbnail of the first slide, Slide001.jpg, and move the orange frame to it. (Select Slide001.jpg)
- (4) Press the  button on the remote control. An enlarged view of the first slide appears on the screen. This starts the presentation.
- (5) To continue to the next slide, click on the remote control's  button. To go back to the previous slide, click on the  button.

### ■ Creating a screen capture and converting it into a JPEG file

This function saves the current computer screen as a JPEG file.

- (1) In the **Conversion Method** field, select **Creating screen capture**.
- (2) In the **File settings** field, click on the **Browse** button for **File name after conversion**.  
The **Save As** dialog box appears.
- (3) In the **Save As** dialog box:
  - (a) Specify the location in which to save the converted file;
  - (b) Enter a file name of up to 8 characters in the **File Name** field; and
  - (c) Click on the **Save** button.
- (4) (a) In the **JPEG Conversion Tool** window, click on the **Conversion** button.
  - (b) The resolution selection dialog box appears. Select a desired resolution and click on the **OK** button.
  - (c) A confirmation message appears. Click **Yes**.  
The computer creates a screen capture, and converts it into a JPEG file in the specified location. When it is finished, a message appears to tell you that a “**JPEG file has been created**”.

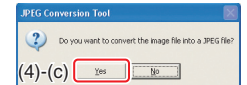
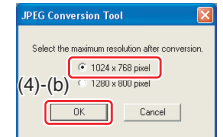
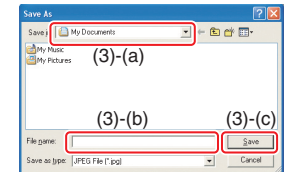
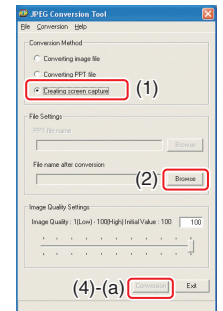

### ■ Note

- The selected resolution in the dialog box will be the maximum resolution of the converted image file. Specify the resolution in accordance with your projector's resolution.

# Setting up the projector using a Web browser

## ■ How to use the “Projector Configuration Tool”

The “Projector Configuration Tool” uses the Web server features of the projector to set up the projector using the network.

When using the “Projector Configuration Tool”, set up the Network connecting the projector and the computer.

1 See “Checking the projector status” p.61 to display information on the screen and write down the IP address.

2 Invoke Internet Explorer.

Internet Explorer Ver. 6.0 or Ver. 7.0\* is recommended. Enable the Javascript functions.

\* Toshiba does not guarantee the operation for later versions.

3 In the address bar, enter the IP address “http://xxx.xxx.xxx.xxx/” recorded in step 1 above.

The Web browser will then display the following page.

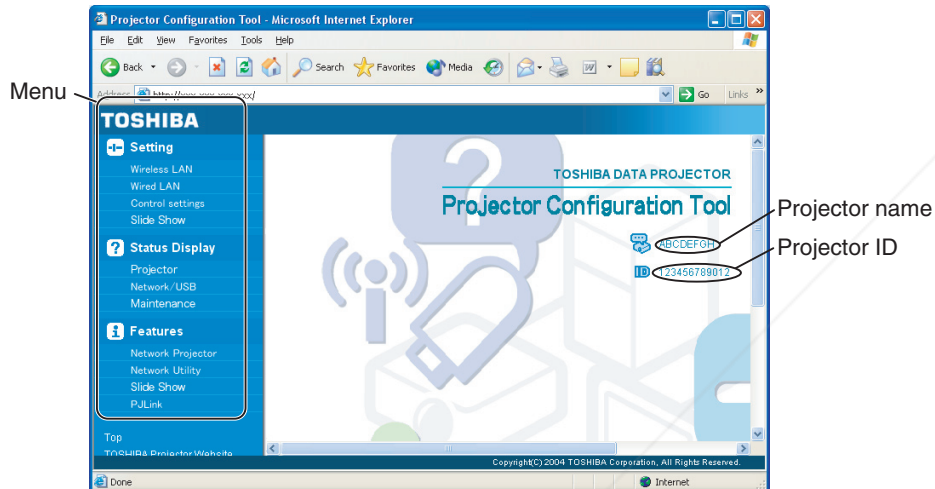

Note: If you use a proxy server, do not enable the proxy when accessing the above IP address.

When the wireless LAN is set to use Ad hoc mode, use the **WEB browser** function in the **Easy Connect** menu of Network Utility.

## ■ Note

- This function can be enabled using the **WEB browser** function in the **Easy Connect** menu of Network Utility without specifying the URL into the browser's address bar.

4 Select items from the menu on the left.

**Settings:**

Make settings for the Network or USB memory input menu.

**Status Display:**

Verify the projector state.

**Features:**

Shows the functions available with the Network or USB memory.

**Top:**

Returns you to the top page.

**TOSHIBA Projector Site:** The browser will display the home page at <http://multimedia.projector-toshiba.com/map.html>, providing projector information. The home page address is subject to change without notice.

(The Toshiba's web site can be browsed only when your computer can access the Internet.)

FixYourDLP.com  
Sponsored by  
DiscountMerchant.com (800) 281-8860  
THE TRUSTED SOURCE FOR PROJECTOR LAMPS AND ACCESSORIES



## Setting up the projector using a Web browser (Continued)

### ● Details on major items

#### • Settings

When **Browser authentication** has been set to **On**, access to the setup page requires the input of the password.

**Wireless LAN:** The items displayed on the screen can be set. Entering individual items and press the **Execute** button to update their setting.

**Wired LAN:** The items displayed on the screen can be set. Entering individual items and press the **Execute** button to update their setting.

**Control settings:** The items displayed on the screen can be set. Entering individual items and press the **Execute** button to update their setting.

**Slideshow:** The items displayed on the screen can be set. Entering individual items and press the **Execute** button to update their setting.

#### • Status display

Displays some states of the projector.

**Projector:** Displays the contents of status display in the menu.

**Network/USB:** Displays the contents of status display of the Network or USB memory input.

**Maintenance:** Describes an error if it occurs, for example, when the lamp has blown.

#### ■ Notes

- Clicking the ? button opens a popup help window.
- The security items such as “**Remote control**” and “**Browser authentication**” cannot be set.

## About lamp

The product's light source is a mercury lamp that lights at increased internal pressure. Be sure to fully understand the following characteristics of the lamp and handle it with extreme care.

- The lamp may burst with a loud noise due to impact or deterioration, or fail to light at the expiration of its life.
- How long it takes before the lamp bursts or the life expires may vary greatly by lamp. Some may burst shortly after first use.
- Burst is likely to happen if the lamp is used after the replacement period has elapsed.
- When the lamp bursts, the broken pieces of glass may get inside the product or be released outside from the openings for ventilation.
- When the lamp bursts, a slight amount of mercury gas enclosed in the lamp along with glass dust may be released from the openings for ventilation.

### ■ Immediately replace the lamp when a sign appears on the screen.

- When the replacement time approaches, a message will appear on the screen.
- The risk of burst will increase if the lamp is continuously used without being replaced.
- Frequently check the used hours and prepare spares when the replacement time approaches. (Refer to “Status display”. [p.45](#))

### ■ When the lamp is broken

- If glass components, including a lamp and a lens, should break, handle the broken pieces with care to avoid injury and contact your dealer for repair service.
- In the event of lamp burst, unplug the product from the wall outlet, leave and completely ventilate the room. Then, thoroughly clean the area around the projector and discard any edible items placed in that area.
- When the lamp bursts, consult a doctor if glass dust or mercury gas gets into your eyes or you breathe it.



**Discount-Merchant.com (800) 281-8860**  
THE TRUSTED SOURCE FOR PROJECTOR LAMPS AND ACCESSORIES

# Lamp replacement

A lamp is consumable supplies. If used for extended periods, images will appear dark, and the lamp could burn out. This is characteristic of a lamp, and is not malfunction. (The lifetime of the lamp depends on condition of use.) If this happens, replace it with a new one.

## ⚠ WARNING

- **If the projector is mounted on the ceiling, it is recommended to use your Toshiba dealership when the lamp has to be exchanged.**  
Uncovering the lamp while the projector is mounted on a ceiling may lead to a danger of damage from falling pieces of glass if the lamp is broken. Besides, working at high elevations can also be hazardous. Do not attempt to replace the lamp by yourself.
- **When replacing, always use lamp “TLPLW15” (sold separately).**

## ⚠ CAUTION

- **If you have been using the projector, the lamp will be very hot, and may cause burn injuries.**  
Wait for the lamp to cool (for longer than 1 hour) before replacing it.
- **If the lamp should break, please handle with care to avoid injury due to broken pieces and contact your dealer for repair service.**

### 1 Unplug power cord.

### 2 Wait until lamp is sufficiently cooled.

Wait for at least 1 hour.

### 3 Remove the outer lamp cover.

Loosen the 2 screws, raise the outer lamp cover with your fingers as shown to remove the outer lamp cover. Use care to avoid any damage to nails and/or tip of your finger(s). If you have any difficulty in removal, you can use a screwdriver or any other smaller tool for your convenience.

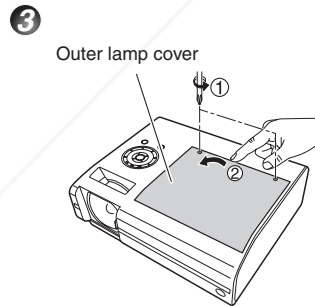

FixYourDLP.com  
Sponsored by

Discount-Merchant.com (800) 281-8860

THE TRUSTED SOURCE FOR PROJECTOR LAMPS AND ACCESSORIES

### 4 Remove the inner lamp cover.

Loosen the screw to remove the inner lamp cover.

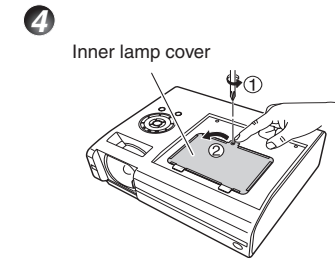

### 5 Pull out the lamp.

Loosen the 3 lamp locking screws, pull up the handle, and press the tab to remove the lamp.

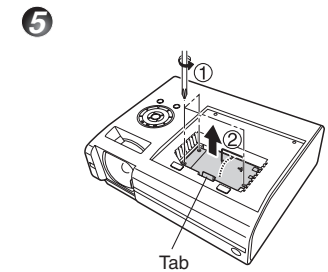

### 6 Mount the new lamp.

Align the orientation, press down the new lamp until the bottom is reached, and lock in place using the 3 lamp locking screws.

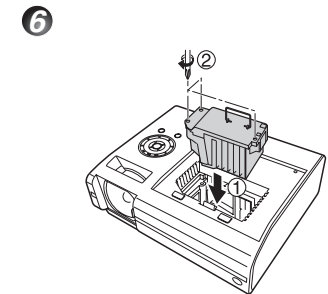

### 7 Replace the inner lamp cover.

Tighten the screw loosened in step 4 until the inner lamp cover is no longer loose.

### 8 Replace the outer lamp cover.

Align the cover, and press it in, then tighten the screws loosened in step 3 until the outer lamp cover is no longer loose. (Be sure to replace the outer lamp cover.)

### 9 Reset the lamp time

See the lamp's manual for instructions on resetting the lamp time.

## Lamp replacement (Continued)

### Notes and Precautions

- The [Lamp time] item in the **Status display** menu indicates the time of lamp use (as a rough guide) [p.45](#)
- Please replace the lamp after 2000 hours of use with [Lamp power] in the **Default setting 2** menu set to [Standard], and 3000 hours of use with [Lamp power] in the **Default setting 2** menu set to [Low]. [p.44](#)
- There are cases that the lamp can not work before the above mentioned period expires or before the replacement message is displayed.
- Attach the lamp cover correctly so that it is not loose. If it is not attached correctly, the projector may fail to be powered on or the lamp may fail to come on.
- Always replace the lamp with a new one.
- The lamp is made out of glass. Do not touch the glass surface with your bare hands, bang it, or scratch it. (Dirt, jolts, scratches and the like could break the lamp.)

### About lamp replacement messages

- The lamp replacement message of this projector displays an appropriate period according to the use period for [Standard] / [Low] of the [Lamp power] respectively.
- When the replacement time approaches, the message of "The lamp life is ending. Please change the lamp." is displayed every time the power is turned on. This display disappears when you press the  button.

### Used Lamps

This projector's lamps contain trace amounts of environmentally harmful inorganic mercury. Be careful not to break used lamps, and dispose of them in accordance with local regulations.

## Lens and main unit cleaning

### WARNING

- **Request cleaning and maintenance of a ceiling-mounted unit from your projector dealership.** Attempting to clean or replace the lamp in a high location by yourself may cause you to fall, resulting in injury.

### ■ Lens cleaning

- Clean the lens with a commercially available blower and/or lens cleaner.
- The lens is easily scratched, so do not rub it with hard objects, or strike it.

### ■ Main unit cleaning

- Clean the main unit after unplugging the power cord.
- Wipe dirt off the main unit gently with a soft cloth.
- Do not wipe the main unit with a damp cloth. Doing so may allow water to get inside, resulting in an electric shock or failure.
- Do not use benzene, thinner and the like as they may deform or discolor the unit or damage the paint surface.
- Do not use a chemically saturated cloth.

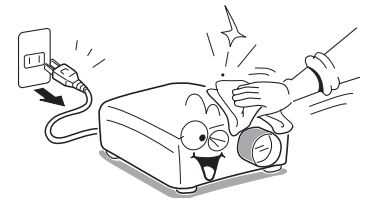
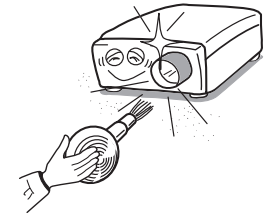

**Discount-Merchant.com (800) 281-8860**  
THE TRUSTED SOURCE FOR PROJECTOR LAMPS AND ACCESSORIES

# Trouble indications

The indicator lights to inform you of internal abnormalities.

	<p><b>No power</b></p> <p>⇒ Problem with projector</p> <ul style="list-style-type: none"> <li>• Unplug the power cord, and contact your dealer.</li> </ul>
	<p><b>Lamp went out during use, or won't come on</b></p> <p>⇒ Lamp temperature is high so that it is difficult to turn on, the lifetime of the lamp has ended or the projector is malfunctioning.</p> <ul style="list-style-type: none"> <li>• Unplug the power cord and wait for a short while, then turn the power back on.</li> <li>• If a lamp burns out, replace it with a new one.</li> </ul>
	<p><b>Power went out during use</b></p> <p>⇒ Internal overheating, or the outside temperature is too high.</p> <ul style="list-style-type: none"> <li>• Place the projector so that the air intake and exhaust are not blocked.</li> <li>• Unplug the power cord and wait for a short while, then turn the power back on.</li> </ul> <p>*The  icon will appear before the power goes out.</p>
	<p><b>Power went out during use</b></p> <p>⇒ Problem with internal cooling fan.</p> <ul style="list-style-type: none"> <li>• Unplug the power cord, and contact your dealer.</li> </ul> <p>*The  icon will appear before the power goes out.</p>
	<p><b>Power went out during use, or power won't come on</b></p> <p>⇒ The lamp cover is not properly attached.</p> <ul style="list-style-type: none"> <li>• Unplug the power cord, and reattach the lamp cover. <a href="#">p.86</a></li> </ul>
	<p><b>Power went out during use</b></p> <p>⇒ Problem inside the projector.</p> <ul style="list-style-type: none"> <li>• Unplug the power cord and wait for a short while, then turn the power back on.</li> <li>• If the above action will not clear the problem, unplug the power cord, and contact your dealer.</li> </ul> <p>*The  icon will appear before the power goes out.</p>

## Note

- After there is an abnormal indication, the abnormal status remains until the main power switch is turned off.

# Before calling service personnel

If you think something is wrong, check the followings before contacting customer service. Please see "Trouble indications" [p.90](#) as well.

If This Happens	Check
<p><b>No power</b></p>	<ul style="list-style-type: none"> <li>• Is the power cord plugged in? Is it connected to the projector?</li> <li>• Is the main power switch turned on? <a href="#">p.26</a></li> <li>• Is the outer lamp cover attached properly? <a href="#">p.86</a></li> <li>• Is the lens cover open? <a href="#">p.26</a></li> </ul>
<p><b>Power goes out during use</b></p>	<ul style="list-style-type: none"> <li>• Is the ambient temperature high? <a href="#">p.90</a></li> <li>• Is the air intake or air exhaust blocked? <a href="#">p.90</a></li> <li>• Is the lens cover open? <a href="#">p.26</a></li> </ul>
<p><b>No picture</b></p>	<ul style="list-style-type: none"> <li>• Is the projector turned on? (When [Auto input search] is [Off]) <a href="#">p.43</a></li> <li>• Is the mute function on? <a href="#">p.34</a></li> <li>• Is the brightness setting minimized? <a href="#">p.38</a></li> <li>• Are the connections set up correctly? <a href="#">p.24</a></li> <li>• Are all the connected devices functioning properly?</li> </ul>
<p><b>No audio</b></p>	<ul style="list-style-type: none"> <li>• Is the mute function on? <a href="#">p.34</a></li> <li>• Is the volume setting minimized? <a href="#">p.29</a></li> <li>• Are the connections set up correctly? <a href="#">p.24</a></li> <li>• Are all the connected devices functioning properly?</li> </ul>
<p><b>Picture not displayed correctly</b></p>	<ul style="list-style-type: none"> <li>• Is the input signal supported by the projector? <a href="#">p.94</a> <a href="#">p.95</a></li> <li>• Is there something generating an abnormal video signal, for instance the video tape?</li> </ul>
<p><b>Picture blurred</b> <b>Part of picture out of focus</b></p>	<ul style="list-style-type: none"> <li>• Is the lens dirty? <a href="#">p.89</a></li> <li>• Is the lens focus adjusted optimally? <a href="#">p.29</a></li> <li>• Is the projection distance within the projector's supported range? <a href="#">p.23</a></li> <li>• Is the projector's screen placement angle tilted too far? <a href="#">p.23</a></li> <li>• Are the sharpness or sampling phase adjustments off? <a href="#">p.38</a></li> </ul>
<p><b>Image is dark</b></p>	<ul style="list-style-type: none"> <li>• Are the brightness or contrast adjustments off? <a href="#">p.38</a></li> <li>• Is the lamp nearing the end of its service life? <a href="#">p.45</a></li> </ul>
<p><b>Colors too light</b> <b>Bad shading</b></p>	<ul style="list-style-type: none"> <li>• Are the color, tint, R-level, G-level, or B-level adjustments off? <a href="#">p.38</a></li> <li>• Is the screen dirty?</li> <li>• Is the blackboard mode set properly? <a href="#">p.43</a></li> <li>• Is the lamp nearing the end of its service life? <a href="#">p.45</a></li> </ul>
<p><b>Control panel key doesn't work</b></p>	<ul style="list-style-type: none"> <li>• Is the key lock function on? <a href="#">p.45</a></li> </ul>

Discount-Merchant.com (800) 281-8860  
THE TRUSTED SOURCE FOR PROJECTOR LAMPS AND ACCESSORIES

## Before calling service personnel (Continued)

If This Happens	Check
<b>Remote control doesn't work</b>	<ul style="list-style-type: none"> <li>Is the remote control code identical with the projector's code? <a href="#">p.44</a></li> <li>Are the remote control's batteries drained?</li> <li>Are the batteries inserted into the remote control correctly? <a href="#">p.21</a></li> <li>Is the remote control being used within the effective range? <a href="#">p.21</a></li> <li>Are there any obstructions between the remote control and projector?</li> <li>Are there any fluorescent or other bright lights shining at the projector's infrared remote sensor?</li> </ul>
<b>USB device images aren't projected</b>	<ul style="list-style-type: none"> <li>Is the USB memory inserted correctly?</li> <li>Is a USB memory not supported by the projector inserted? <a href="#">p.49</a></li> <li>Are there any JPEG or MPEG files saved on the USB memory?</li> <li>Are the files too large or in an unsupported format for the projector? For JPEG files, convert them with the supplied software application. <a href="#">p.78</a></li> </ul>
<b>The wireless LAN doesn't work</b>	<ul style="list-style-type: none"> <li>Are the transmission mode, SSID, etc. properly configured?</li> <li>Are there any obstructions between the computer and the projector?</li> <li>Do your computer and OS support the supplied software application? <a href="#">p.62</a></li> </ul>

## Specifications

### List of general specifications

Item	Specification	
Consumption Power	385 W	
Weight	4.2 kg	
External Dimensions (including protruding parts)	338 × 128 × 268 mm (W × H × D)	
Cabinet material	PC+ABS resin and ABS resin	
Conditions for usage environment	Temp: 5°C to 35°C; relative humidity: 30% to 70%	
Display pixels	1 DLP® chip	
Picture elements	1,024,000 pixels (1280H × 800V)	
Lens	F=2.63 f=8.37 mm	
Lamp	High-pressure mercury lamp (275 W)	
Projection screen size	41-120 inches	
Projection distance	498 mm – 1526 mm	
Speaker	1W (Mono)	
Connection terminal	COMPUTER 1 IN terminal	Mini D sub 15 pin RGB / Y/P <sub>B</sub> /P <sub>R</sub> (dual use)
	COMPUTER 2 IN terminal	Mini D sub 15 pin RGB / Y/P <sub>B</sub> /P <sub>R</sub> (dual use)
	MONITOR terminal	Mini D sub 15 pin RGB / Y/P <sub>B</sub> /P <sub>R</sub> (dual use)
	S-VIDEO terminal	Mini DIN 4 pin
	AUDIO (L/R) terminal	RCA Pin Jack × 2, 1.5 V (rms), 22 kΩ or more
	VIDEO terminal	RCA Pin Jack, 1 V (p-p), 75Ω
	AUDIO (L/R) terminal	RCA Pin Jack × 2, 1.5 V (rms), 22 kΩ or more
	AUDIO IN terminal	3.5mm dia. stereo mini-jack, 1.5 V (rms), 22 kΩ or more
	AUDIO OUT terminal	3.5mm dia. stereo mini-jack
	CONTROL terminal	D sub 9 pin (RS-232C)
USB terminal	USB 2.0 High-speed enabled Type A; Output voltage: +5 VDC; Supply current: 500 mA	
LAN terminal	10BASE-T/100BASE-TX	

### Notes

- This model complies with the above specifications.
- Designs and specifications are subject to change without notice.
- This model may not be compatible with features and/or specifications that may be added in the future.

### Separately sold product

Replacement Lamp Model TLPLW15



Discount-Merchant.com (800) 281-8880  
THE TRUSTED SOURCE FOR PROJECTOR LAMPS AND ACCESSORIES



## Specifications (Continued)

### List of supported signals (RGB signals)

This projector supports the following RGB signals. Note, however, that depending on the computer model, the screen may show flicker or streaking. Please adjust the projector if this happens.

Resolution	Mode	Refresh rate (Hz)	H-frequency (kHz)	Clock (MHz)
720 x 400	720x400_85	85.039	37.927	35.500
640 x 480	VGA_60	59.940	31.469	25.175
	VGA_72	72.809	37.861	31.500
	VGA_75	75.000	37.500	31.500
	VGA_85	85.008	43.269	36.000
800 x 600	SVGA_56	56.250	35.156	36.000
	SVGA_60	60.317	37.879	40.000
	SVGA_72	72.188	48.077	50.000
	SVGA_75	75.000	46.875	49.500
	SVGA_85	85.061	53.674	56.250
832 x 624	MAC16"	74.550	49.725	57.283
1024 x 768	XGA_60	60.004	48.363	65.000
	XGA_70	70.069	56.476	75.000
	XGA_75	75.029	60.023	78.750
	XGA_85	84.997	68.667	94.500
	MAC19"	74.700	60.134	79.857
1152 x 864	SXGA1_75	75.000	67.500	108.000
1280 x 960	QuadVGA_60	60.000	60.000	108.000
	QuadVGA_85	85.002	85.938	148.500
1280 x 1024	SXGA3_60	60.020	63.981	108.000
	SXGA3_75	75.025	79.976	135.000
	SXGA3_85	85.024	91.146	157.500
1280 x 800	WXGA_60	59.880	49.580	83.300
1400 x 1050	SXGA+	59.978	65.317	121.750
1600 x 1200	UXGA_60	60.000	75.000	162.000
	UXGA_65	65.000	81.250	175.500
	UXGA_70	70.000	87.500	189.000
	UXGA_75	75.000	93.750	202.500
	UXGA_85	85.000	106.250	229.500

### Note

- Signals whose resolution exceeds the native resolution (1280 x 800 pixels) will be compressed. For this reason, some information may be lost, or image quality may be affected.

### List of supported signals (Y/Pb/Pr signals)

Signal format	fh(kHz)	fv(Hz)
480i(525i)@60Hz	15.73	59.94
480p(525p)@60Hz	31.47	59.94
576i(625i)@50Hz	15.63	50.00
576p(625p)@50Hz	31.25	50.00
720p(750p)@60Hz	45.00	60.00
720p(750p)@50Hz	37.50	50.00
1080i(1125i)@60Hz	33.75	60.00
1080i(1125i)@50Hz	28.13	50.00
1080p(1125p)@60Hz	67.50	60.00
1080p(1125p)@50Hz	56.25	50.00

### List of supported signals (Video, S-Video signals)

Video mode	fh(kHz)	fv(Hz)	fsc(MHz)
NTSC	15.73	60	3.58
PAL	15.63	50	4.43
SECAM	15.63	50	4.25 or 4.41
PAL-M	15.73	60	3.58
PAL-N	15.63	50	3.58
PAL-60	15.73	60	4.43
NTSC4.43	15.73	60	4.43

### Pin assignment of COMPUTER 1 IN, COMPUTER 2 IN & MONITOR terminals

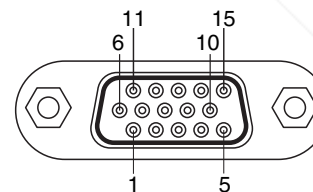

Mini D sub 15 Pin connector

#### Input Signal

- RGB input  
RGB signals: 0.7V(p-p) 75Ω  
Horizontal sync signal: TTL level (Pos/neg polarity)  
Vertical sync signal: TTL level (Pos/neg polarity)
- Y/Pb/Pr input  
Y signal: 1.0V (p-p) 75 Ω  
Pb/Pr signals: 0.7V (p-p) 75 Ω

Pin No.	Pin description	
	During RGB input	During Y/Pb/Pr input
1	Video signal (R)	Color difference signal (Pr)
2	Video signal (G)	Luminance signal (Y)
3	Video signal (B)	Color difference signal (Pb)
4	GND	*
5	GND	*
6	GND(R)	GND(Pr)
7	GND(G)	GND(Y)
8	GND(B)	GND(Pb)
9	N.C	*
10	GND	*
11	GND	*
12	N.C	*
13	Horizontal sync signal	*
14	Vertical sync signal	*
15	N.C	*

\* Do not connect anything.

## Specifications (Continued)

### ■ CONTROL terminal

#### ● Pin assignment

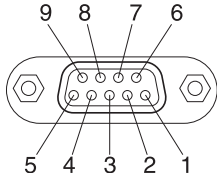

D sub 9 pin connector

Pin No.	Signal Name	Description
1	DCD	Data carrier detect
2	RXD	Receiving data
3	TXD	Sending data
4	DTR	Data terminal ready
5	GND	Signal ground
6	DSR	Data set ready
7	RTS	Request to send
8	CTS	Consent to send
9	RI	Ring indicator

#### ● Interface format

1. Communication method RS-232C, 9600bps, No Parity, Data Length: 8 bits; Stop Bit Length: 1 bit
2. Communication format
 

STX (02h)	Command (3Byte)	ETX (03h)
-----------	-----------------	-----------

 Only 1 command valid per communication.
3. Data format For input commands, only ASCII-compliant all-uppercase alphanumeric characters supported.
4. Replies
 

Acknowledge	ACK (06h)	CR(0Dh)	Data	... Normally ended
	ACK (06h)	ESC(1Bh)		... Aborted
No acknowledge	NAK (15h)			

If commands are to be sent consecutively, wait for the response from the projector before sending the next command.

#### ● Main Commands

Item	Command
Power on	<b>PON</b>
Power off	<b>POF</b>
Icon display on	<b>MO0</b>
Icon display off	<b>MO1</b>
Auto setting (RGB input)	<b>PAT</b>
Status display on	<b>DON</b>
Status display off	<b>DOF</b>



FixYourDLP.com  
Sponsored by

**Discount-Merchant.com (800) 281-8860**

**THE TRUSTED SOURCE FOR PROJECTOR LAMPS AND ACCESSORIES**

#### ■ Note

- Contact your dealer for control cable and other commands.



**Discount-Merchant.com (800) 281-8860**

**THE TRUSTED SOURCE FOR PROJECTOR LAMPS AND ACCESSORIES**

**TOSHIBA CORPORATION**



# Disclaimer

This user manual is provided as a free service by FixYourDLP.com. FixYourDLP is in no way responsible for the content of this manual, nor do we guarantee its accuracy. FixYourDLP does not make any claim of copyright and all copyrights remain the property of their respective owners.

About FixYourDLP.com

FixYourDLP.com (<http://www.fixyourdpl.com>) is the World's #1 resource for media product news, reviews, do-it-yourself guides, and manuals.

Informational Blog: <http://www.fixyourdpl.com>

Video Guides: <http://www.fixyourdpl.com/guides>

User Forums: <http://www.fixyourdpl.com/forum>

FixYourDLP's Fight Against Counterfeit Lamps:

<http://www.fixyourdpl.com/counterfeits>

## Sponsors:

RecycleYourLamp.org – Free lamp recycling services for used lamps:

<http://www.recycleyourlamp.org>

Lamp Research - The trusted 3rd party lamp research company:

<http://www.lampresearch.com>

Discount-Merchant.com – The worlds largest lamp distributor:

<http://www.discount-merchant.com>



**FixYourDLP.com**

Sponsored by 