



Disclaimer

This user manual is provided as a free service by FixYourDLP.com. FixYourDLP is in no way responsible for the content of this manual, nor do we guarantee its accuracy. FixYourDLP does not make any claim of copyright and all copyrights remain the property of their respective owners.

About FixYourDLP.com

FixYourDLP.com (<http://www.fixyourdpl.com>) is the World's #1 resource for media product news, reviews, do-it-yourself guides, and manuals.

Informational Blog: <http://www.fixyourdpl.com>

Video Guides: <http://www.fixyourdpl.com/guides>

User Forums: <http://www.fixyourdpl.com/forum>

FixYourDLP's Fight Against Counterfeit Lamps:

<http://www.fixyourdpl.com/counterfeits>

Sponsors:

RecycleYourLamp.org – Free lamp recycling services for used lamps:

<http://www.recycleyourlamp.org>

Lamp Research - The trusted 3rd party lamp research company:

<http://www.lampresearch.com>

Discount-Merchant.com – The worlds largest lamp distributor:

<http://www.discount-merchant.com>



FixYourDLP.com

Sponsored by 

TOSHIBA
Leading Innovation >>>

TLP-XE30 DATA PROJECTOR

OWNER'S MANUAL

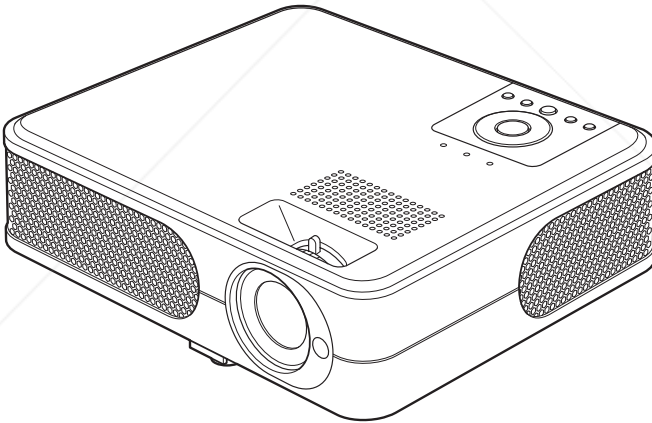

 **FixYourDLP.com**
Sponsored by 

Discount-Merchant.com (800) 281-8860

THE TRUSTED SOURCE FOR PROJECTOR LAMPS AND ACCESSORIES

In the spaces provided below, record the Model and Serial No. located at the bottom of your projector.

Model No. _____ Serial No. _____

Retain this information for future reference.

Before Using

Preparations

Operations

Maintenance

Others



SAFETY PRECAUTIONS



The lightning flash with arrowhead symbol, within an equilateral triangle, is intended to alert the user to the presence of uninsulated "dangerous voltage" within the product's enclosure that may be of sufficient magnitude to constitute a risk of electric shock to persons.



The exclamation point within an equilateral triangle is intended to alert the user to the presence of important operating and maintenance (servicing) instructions in the literature accompanying the appliance.

WARNING: TO REDUCE THE RISK OF FIRE OR ELECTRIC SHOCK, DO NOT EXPOSE THIS APPLIANCE TO RAIN OR MOISTURE. DANGEROUS HIGH VOLTAGES ARE PRESENT INSIDE THE ENCLOSURE. DO NOT OPEN THE CABINET. REFER SERVICING TO QUALIFIED PERSONNEL ONLY.

WARNING: Handling the cord on this product or cords associated with accessories sold with this product, will expose you to lead, a chemical known to the State of California to cause birth defects or other reproductive harm. **Wash hands after handling.**

WARNING: Lamp contains mercury. Disposal of this product may be regulated due to environmental considerations. For disposal, reuse or recycling information, please contact your local government or the Electronic Industries Alliance at www.eiae.org.

MODEL NAME: TLP-XE30 **USA only**

TRADE NAME: DATA PROJECTOR

MODEL NAME: TLP-XE30



Tested To Comply
With FCC Standards

FOR HOME OR OFFICE USE

FCC NOTICE: This device complies with part 15 of the FCC Rules. Operation is subject to the following two conditions:

(1) This device may not cause harmful interference, and (2) this device must accept any interference received, including interference that may cause undesired operation.

This equipment has been tested and found to comply with the limits for a Class B digital device, pursuant to part 15 of the FCC Rules. These limits are designed to provide reasonable protection against harmful interference in a residential installation. This equipment generates, uses and can radiate radio frequency energy and, if not installed and used in accordance with the instructions, may cause harmful interference to radio communications.

However, there is no guarantee that interference will not occur in a particular installation.

If this equipment does cause harmful interference to radio or television reception, which can be determined by turning the equipment off and on, the user is encouraged to try to correct the interference by one or more of the following measures:

- Reorient or relocate the receiving antenna.
- Increase the separation between the equipment and receiver.
- Connect the equipment into an outlet on a circuit different from that to which the receiver is connected.
- Consult the dealer or an experienced radio/TV technician for help.

RESPONSIBLE PARTY: TOSHIBA AMERICA INFORMATION SYSTEMS, INC.
9740 Irvine Blvd., Irvine, CA 92618-1697 U.S.A
Phone: (949) 583-3000

WARNING: Changes or modifications made to this equipment, not expressly approved by Toshiba, or parties authorized by Toshiba, could void the user's authority to operate the equipment.

Notice: This Class B digital apparatus complies with Canadian ICES-003. Cet appareil numérique de la classe B est conforme à la norme NMB-003 du Canada.

Following information is only valid for EU-member States:

Disposal of batteries and/or accumulators

The crossed out wheeled dust bin symbol indicates that batteries and/or accumulators must be collected and disposed of separately from household waste. If the battery or accumulator contains more than the specified values of lead (Pb), mercury (Hg), and/or cadmium (Cd) defined in the Battery Directive (2006/66/EC), then the chemical symbols for lead (Pb), mercury (Hg) and/or cadmium (Cd) will appear below the crossed out wheeled dust bin symbol.

By participating in separate collection of batteries, you will help to assure the proper disposal of products and batteries and thus help to prevent potential negative consequences for the environment and human health.

For more detailed information about the collection and recycling programmes available in your country, please contact your local city office or the shop where you purchased the product.



Hg Cd Pb

IMPORTANT SAFETY INSTRUCTIONS

CAUTION: PLEASE READ AND OBSERVE ALL WARNINGS AND INSTRUCTIONS GIVEN IN THIS OWNER'S MANUAL AND THOSE MARKED ON THE UNIT. RETAIN THIS BOOKLET FOR FUTURE REFERENCE.

This unit is fully transistorized and does not contain any parts that can be repaired by the user.

DO NOT REMOVE THE CABINET COVER, OR YOU MAY BE EXPOSED TO DANGEROUS VOLTAGE. REFER SERVICING TO QUALIFIED SERVICE PERSONNEL ONLY.

1. Read Owner's Manual

After unpacking this product, read the owner's manual carefully, and follow all of the operating and other instructions.

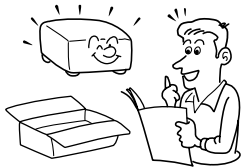

2. Power Sources

This product should be operated only from the type of power source which does not exceed the voltage range specified on the rating label and the power cord. If you are not sure of the type of power supply to your home, consult your product dealer or local power company.



3. Source of Light

Do not look into the lens while the lamp is on. The strong light from the lamp may cause damage to your eyesight.

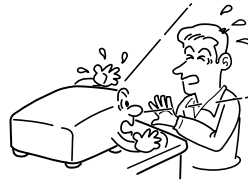

4. Ventilation

Openings in the cabinet are provided for ventilation and to ensure reliable operation of the product and protect it from overheating. These openings must not be blocked or covered. Never block an opening by placing the product on a bed, sofa, rug or other similar surface. Do not place it in a built-in installation such as a bookcase or rack, unless proper ventilation is provided.



FixYourDLP.com

Sponsored by

DiscountMerchant.com (800) 281-8860
THE TRUSTED SOURCE FOR PROJECTOR LAMPS AND ACCESSORIES



5. Heat

The product should be situated away from heat sources such as radiators, heat registers, stoves, or other products (including amplifiers) that produce heat.

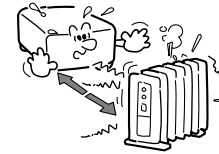

6. Water and Moisture

Do not use this product near water. - for example, near a bath tub, wash bowl, kitchen sink, or laundry tub; in a wet basement; or near a swimming pool and the like.

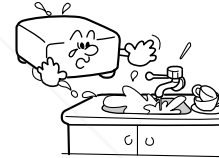

7. Cleaning

Unplug this product from the wall outlet before cleaning. Do not use liquid cleaners or aerosol cleaners. Always use a soft cloth for cleaning.

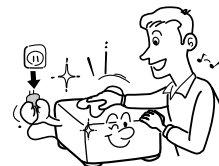

8. Be sure that you firmly insert the plug into the wall outlet.

Incorrect or faulty connections may result in fire or electric shock. Avoid using an unsound or loose outlet.

9. Power Cord Protection

Power cords should be routed so that they are not likely to be walked on or pinched by items placed upon or against them, paying particular attention to cords at plugs, convenience receptacles, and the point where they exit from the product.



10. Overloading

Do not overload wall outlets. To reduce the risk of electric shock, do not use the polarized plug with an extension cord, receptacle, or other outlet unless the blades can be inserted completely with three-wire grounding type to prevent blade exposure. Failure to follow these instructions may result in fire or electric shock.



IMPORTANT SAFETY INSTRUCTIONS (Continued)

11. Lightning storms

For added protection for this product during a storm, or when it is left unattended and unused for long periods of time, unplug it from the wall outlet. This will prevent damage to the product due to lightning and power-line surges. Never operate this unit on AC power during a thunderstorm. If you see lightning or hear thunder, never touch the unit, cables and/or peripherals. An electric surge caused by the storm, may result in an electrical shock or damage to the unit.

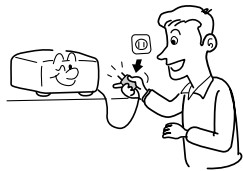

12. Object and Liquid Entry

Never push objects of any kind into this product through openings as they may touch dangerous voltage points or short-out parts that could result in a fire or electric shock. Never spill liquid of any kind on the product.



13. Do not place or keep the projector within the reach of the children.

It may fall or tip over, possibly causing serious injury.

14. Do not place the product vertically

Do not use the product in the upright position or any other vertical positions to project the pictures. It may fall which could result in serious injury and/or damage to the product.

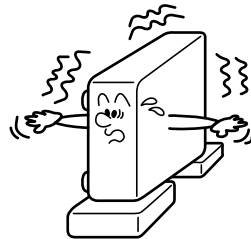

15. Stack Inhibited

Do not stack other equipment on this product and do not place this product on other equipment. The top and bottom surface of this product increase in temperature during normal use and may damage the other unit.



16. Attachments

Do not use attachments not recommended by the product manufacturer. Use of an incompatible attachment could cause hazards or damage to the product.

17. Accessories

Do not place this product on an unstable cart, stand, tripod, bracket, or table. The product may fall, causing serious injury to a child or adult, and serious damage to the product. A product and cart combination should be moved with care. Quick stops, excessive force, and uneven surfaces may cause the product and cart combination to overturn.



18. Damage Requiring Service

Unplug this product from the wall outlet and take the product to qualified service personnel if you encounter any of the following conditions:

- The power supply cord or plug is damaged.
- Liquid has been spilled, or objects have fallen into the product.
- The product has been exposed to rain or water.
- The product does not operate normally when following the operating instructions. Adjust only those controls that are covered by the operating instructions since an improper adjustment of other controls may result in damage and will often require extensive work by a qualified technician to restore the product to its normal operation.

- The product has been dropped or damaged in any way (If the cabinet should break, please handle with care to avoid injury) .
- The product exhibits a distinct change in performance, which indicates a need for service.

19. If glass components, including lens and lamp, should break, contact your dealer for repair service.

This product incorporates glass components, including a lens and a lamp.

If these should break, please handle with care to avoid injury and contact your dealer for repair service. Avoid any broken pieces of glass since they may cause injury. In the unlikely event that the lamp ruptures, thoroughly clean the area around the projector and discard any edible items placed in that area since they may be contaminated.

20. Servicing

Do not attempt to service this product yourself as opening or removing covers may expose you to dangerous voltage or other hazards. Refer all servicing to qualified service personnel.



Discount Merchant.com 1-800-391-9999
THE TRUSTED SOURCE FOR PROJECTOR LAMP AND ACCESSORIES

IMPORTANT SAFETY INSTRUCTIONS (Continued)

21. Replacement Parts

When replacement parts are required, be sure the service technician has used replacement parts specified by the manufacturer or have the same characteristics as the original part. Unauthorized substitutions may result in fire, electric shock, or other hazards.
(Only the replacement of the lamp should be made by users.)

22. Safety Check

Upon completion of any service or repairs to this product, ask the service technician to perform safety checks to verify that the product is in proper operating condition.

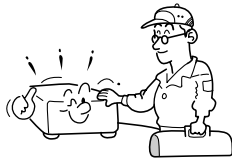

23. Do not leave thermal-paper documents or easily deformed items on top of the unit or near the air exhaust for long periods of time.

The heat from the unit could erase the information on the thermal paper, or cause deformation or warping.

24. Do not use the product in a closed installation location.

Do not place the product in a box or in any other closed installation location. Otherwise it may overheat, which could result in a risk of fire.



Discount-Merchant.com (800) 281-8800
THE TRUSTED SOURCE FOR PROJECTOR

POWER SUPPLY INFORMATION

If your line voltage is 220 to 240V, use one of the following types of cable/plug.

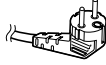
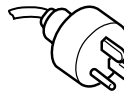
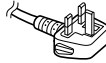
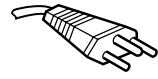
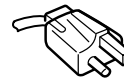
Plug configuration	Plug type	Line voltage	Plug configuration	Plug type	Line voltage
	EURO	220 – 240V		Australian 240V 10A	200 – 240V
	UK	220 – 240V		Switzerland 240V 6A	200 – 240V
Use a 5A fuse which is approved by ASTA or BSI to BSI362. Always replace the fuse cover after changing the fuse.				North American 240V 15A	200 – 240V

IMPORTANT PRECAUTIONS

Moisture Condensation

Never operate this unit immediately after moving it from a cold location to a warm location. When the unit is exposed to such a change in temperature, moisture may condense on the lens and the crucial internal parts. Do not use the unit for at least 2 hours when there is an extreme or sudden change in temperature to prevent the unit from possible damage.

Place and Manner of Installation

- Do not place in hot locations, such as near heating equipment. Doing so could cause malfunction, and shorten the life of the projector.
- Avoid locations with oil or cigarette smoke. Doing so will dirty the optical parts, shortening their lives, and darkening the screen.
- Do not use this product in the upright position or tilt it up or down by more than 20° from level. Doing so may cause a failure or shorten the life of the product.
- Using this instrument near a TV or radio may cause interference to the images or audio sound. If this happens, move it away from the TV or radio.
- Moving the projector from a low-temperature room to a high-temperature room may cause condensation on the lens or internal parts. If you continue to use it in that situation, it may malfunction. Wait until the condensation naturally disappears.
- In a high altitude location where air is thin, cooling efficiency is reduced so use the projector with **[Fan mode]** set to **[High]**. [p.41](#)
- Only plug the power cord into outlets rated for use with the power cord's specified voltage range. Do not overload extension cords or power strips as this can result in fire or electric shock.
- Route the power cable or the connecting cable away from where people could trip over it. The projector may fall, which could result in severe injury.
- Be sure the power cord is easily reached for unplugging in case of emergency. Do not place any obstacles near a wall outlet in which the cord is plugged.

IMPORTANT PRECAUTIONS (Continued)

Avoid Volatile Liquid

Do not use volatile liquids, such as an insect spray, near the unit. Do not leave rubber or plastic products touching the unit for a long time as they will leave marks on the finish. If cleaning with a chemically saturated cloth, be sure to follow the product's precautions.

LCD Panel

- If the air filter is stained and is clogged up, the main unit inner temperature rises. As a result, the life of the LCD is shortened and a malfunction may also occur. Clean the air filter from time to time and replace it regularly. It is recommended that this replacement be done at the time of replacing a lamp. (Ask a dealer where the unit was purchased or your nearby service station about an air filter for replacement.)

EXEMPTION CLAUSES

- Toshiba Corporation bears no responsibility in the case of damages arising from natural disaster such as earthquakes, lightning, etc., fire not liable to Toshiba Corporation, acts by third parties, other accidents, or use under abnormal conditions including erroneous or improper operation and other problems.
- Toshiba Corporation bears no responsibility for incidental damages (lost profit, work interruption, corruption or loss of the memory contents, etc.) arising from the use of or the inability to use this unit.
- Toshiba Corporation accepts no liability whatsoever for any damages arising from not having followed the descriptions in this Owner's Manual.
- Toshiba Corporation accepts no liability whatsoever for any damages arising from malfunctions arising from combination with equipment or software that is not related to Toshiba Corporation.

OTHER INFORMATION

Copyrights

Showing or transmitting commercial imaging software or broadcast or cable-broad casting programs with the purpose of other than the personal and private viewing, including modifying images using the freeze or resize functions, or displaying with the varying aspect ratio of the images, could violate the direct or indirect copyrights of the imaging software or broadcast program, etc., if done without first consulting with the copyright holder. For this reason, please take appropriate measures before performing one of the actions listed above, including obtaining a license from the copyright holder.

In the spaces provided below, record the Model and Serial No. located at the bottom of your projector.

Model No. _____ Serial No. _____

Retain this information for future reference.

Disposal

This product contains substances which are harmful to humans and the environment.

- The lamp contains mercury.

Please dispose of this product or used lamps in accordance with local regulations.

Following information is only for EU-member states:

The use of the symbol indicates that this product may not be treated as household waste. By ensuring this product is disposed of correctly, you will help prevent potential negative consequences for the environment and human health, which could otherwise be caused by inappropriate waste handling of this product. For more detailed information about recycling of this product, please contact your local city office, your household waste disposal service or the shop where you purchased the product.



Trademarks

- VGA, SVGA, XGA, SXGA, UXGA are trademarks or registered trademarks of International Business Machines Corporation.
- Macintosh is a registered trademark of Apple Computer, Inc.
- Windows is a registered trademark of Microsoft Corporation in the U.S. and other countries.
- Adobe and Acrobat Reader are registered trademarks of Adobe Systems Incorporated.
- All other brand and product names are trademarks or registered trademarks of their respective companies.

Notational Conventions Used in This Manual

- References to pages with related information are annotated as follows. For example, if making a reference to page 36: [p.36](#)
- The illustrations in this document are for reference purposes only and may not reflect your package exactly.

REMOTE CONTROL BATTERIES

Caution

- Never throw batteries into a fire. Using the batteries improperly may cause them to explode or leak and may result in serious injury. If battery-leaking fluid contacts skin, wash the fluid off immediately with clean water and consult a doctor. If the fluid spills on an instrument, avoid contact and wipe it off using tissue paper. Then dispose of the used tissue paper as flammable garbage after moistening it with water.

Notes

- Be sure to use AAA (R03) size batteries.
- Dispose of batteries in a designated disposal area.
- Attention should be drawn to the environmental aspects of battery disposal. Do not mix different battery types or combine used batteries with new ones.
- If the remote control does not operate correctly, or if the operating range becomes reduced, replace both batteries with new ones.
- If the batteries are dead or if you will not be using the remote control for a long time, remove the batteries to prevent battery acid from leaking into the battery compartment.

CONTENTS

Before Using

SAFETY PRECAUTIONS	2
IMPORTANT SAFETY INSTRUCTIONS	4
POWER SUPPLY INFORMATION	9
IMPORTANT PRECAUTIONS	9
EXEMPTION CLAUSES	10
OTHER INFORMATION	10
REMOTE CONTROL BATTERIES	11
CONTENTS	12

Preparations

Checking the package contents	14
Names of each part on the main unit	15
Names of each part on the control panel and remote control	16
Names of the terminals on the rear panel	18
Preparing and using the remote control	19
Placement	20
Connection	21

Operations

Turning the power on and off	23
Basic operations	25
Using handy features	27
Using auto setting	27
Correcting the keystone distortion	27
Resizing image	28
Cutting off the picture and sound temporarily (Mute)	29
Changing picture mode	29
Changing screen size	30
Freezing the image (Freeze)	30
Setting the password	31
Using the menus	34
How to use the menus	34
The image adjustment menu	35
The display setting menu	37
The default setting menu	40
Displaying Information (Status display)	42

Maintenance

About lamp	43
Lamp replacement	44
Air filter cleaning	46
Lens and main unit cleaning	47

Others

Trouble indications	48
Before calling service personnel	49
Specifications	50
List of general specifications	50
Separately sold product	50
List of supported signals (RGB signals)	51
List of supported signals (Y/P _B /P _R signals)	52
List of supported signals (Video, S-Video signals)	52
Pin assignment of COMPUTER 1 IN, COMPUTER 2 IN & MONITOR OUT terminals	52
CONTROL terminal	53

Checking the package contents

Please make sure that the following items are included in the box, along with the main unit. If any item is missing, immediately contact the store where you purchased the product.

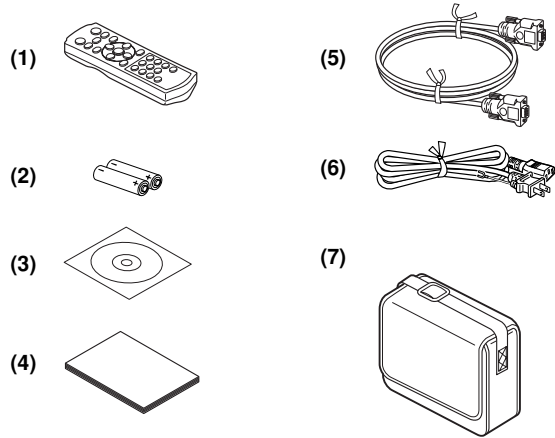

- (1) Remote control
- (2) R03 (SIZE AAA) batteries for remote control (2)
- (3) CD-ROM
- (4) Owner's Manual
- (5) RGB cable (3m) [Note 1]
- (6) Power cord [Note 1, 2]
- (7) Carrying bag

Notes

- 1: To maintain original performance, always use the supplied cables.
- 2: The shape and number of supplied power cords vary depending on the product destination.

Save Original Packing Materials

The original shipping carton and packing materials will come in handy if you ever have to ship your projector. For maximum protection, when shipping your projector, repack the set as it was originally packed at the factory.

◆The Supplied CD-ROM

The supplied CD-ROM contains an owner's manual, including information not available for the printed Owner's manual (Getting Started) in Portable Document Format (PDF). Please use **Acrobat Reader 5** or later version to view the manual.

■ Adobe® Acrobat® Reader® or Adobe® Reader®

The supplied CD-ROM does not contain **Adobe Acrobat Reader**. If you cannot read PDF files, please install **Adobe Reader** software on your computer by downloading it from the Adobe Systems website.

■ Viewing the manual

Run the CD-ROM and double-click on **Start.pdf**. **Adobe Acrobat Reader** launches, and the menu screen of the Owner's manual appears. Click on your language. The Owner's Manual cover and list of bookmarks appear. Click on a bookmark title to view that section of the manual. Click on **p. 26** to view a reference page with related information. See the Help menu for more information about **Adobe Acrobat Reader**.

Names of each part on the main unit

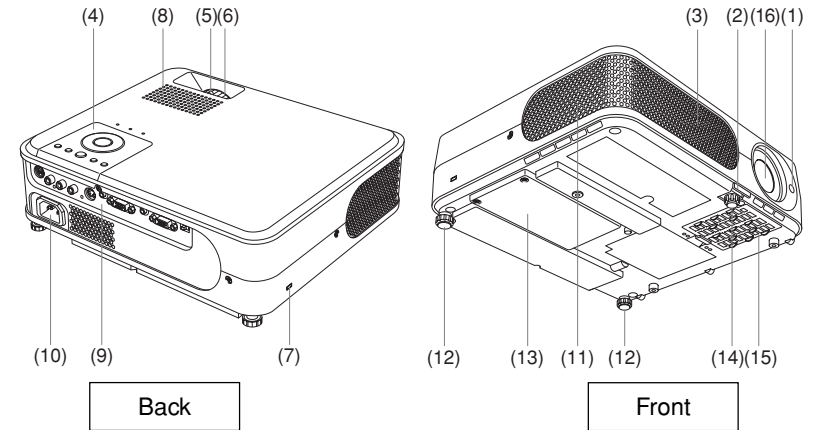

Name	Function
(1) Infrared remote sensor	: Senses commands from the remote control. p.19
(2) Foot adjuster release button	: Press to set up or stow the foot adjuster. p.26
(3) Air intake	: Draws in air from outside the projector.
(4) Control panel	: Operates the projector. p.16
(5) Zooming lever	: Adjusts screen size. p.26
(6) Focusing ring	: Adjusts screen focus. p.26
(7) Antitheft lock slot	: Attach a safety cable or any other antitheft device.
(8) Speaker	: Outputs audio sound.
(9) Terminals on the rear panel	: Connects external devices. p.18
(10) AC IN socket	: Connect the supplied power cord here.
(11) Air exhaust	: Expels air that has grown hot inside the projector.
(12) Tilt adjuster	: Adjusts the projector's horizontal tilt. p.26
(13) Lamp cover	: Remove to replace lamp. p.44
(14) Foot adjuster	: Adjusts the vertical projection angle. p.26
(15) Air filter	: Prevents dirt and garbage from getting into the inside of the projector.
(16) Lens	: Projects expanded image.

Names of each part on the control panel and remote control

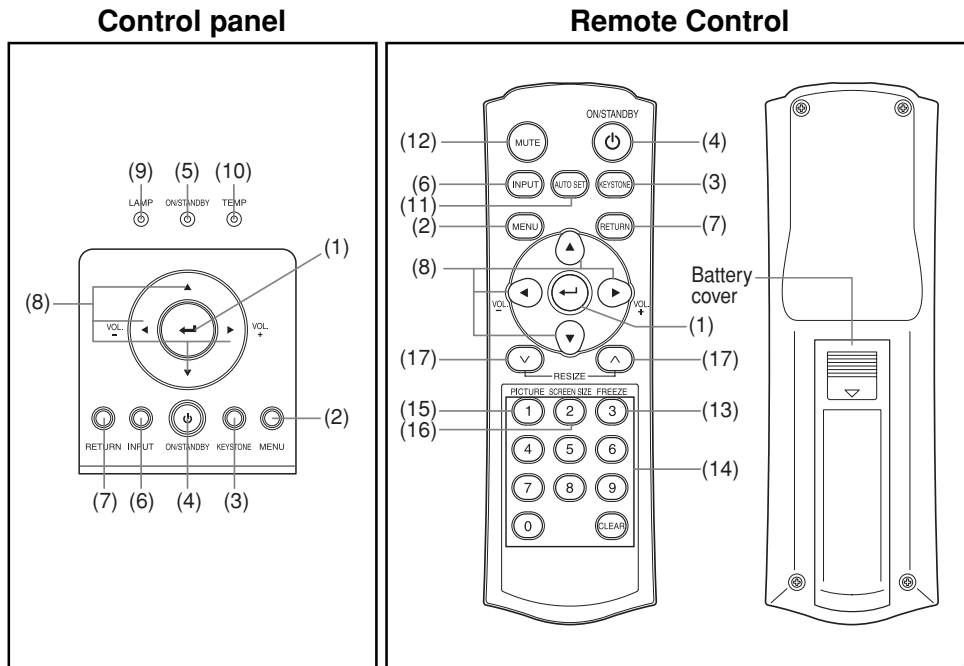

Name : Main Function

Control panel

- (1) ENTER button : Accepts the selected mode.
- (2) MENU button : Displays menus. [p.34](#)
- (3) KEystone button : Adjusts keystone distortion. [p.27](#)
- (4) ON/STANDBY button : Turns the power on/off (standby). [p.23](#)
- (5) ON/STANDBY indicator : Displays whether power is on or off (standby). [p.23](#)
- (6) INPUT button : Selects input. [p.25](#)
- (7) RETURN button : Goes back one screen.
- (8) Selection button : Menu selections and adjustments, volume control, etc. [p.34](#)
- (9) LAMP indicator : Informs the abnormality of lamp. [p.48](#)
- (10) TEMP indicator : Informs the abnormality of internal temperature. [p.48](#)

Remote control

- (1) ENTER button : Accepts the selected mode.
- (2) MENU button : Displays menus. [p.34](#)
- (3) KEystone button : Adjusts keystone distortion. [p.27](#)
- (4) ON/STANDBY button : Turns the power on/off (standby). [p.23](#)
- (6) INPUT button : Selects input. [p.25](#)
- (7) RETURN button : Goes back one screen.
- (8) Selection button : Menu selections and adjustments, volume control, etc. [p.34](#)

Name : Main Function

- (11) AUTO SET button : Sets up input from computer. [p.27](#)
- (12) MUTE button : Cuts off the picture and sound temporarily. [p.29](#)
- (13) FREEZE button : Pauses image. [p.30](#)
- (14) Ten-Key button : Use when entering password.

Remote control button	Input items	Remote control button	Input items
[1]	[1]	[7]	[7]
[2]	[2]	[8]	[8]
[3]	[3]	[9]	[9]
[4]	[4]	[0]	[0]
[5]	[5]	[CLEAR]	Deletes one character.
[6]	[6]		

- (15) PICTURE button : Changes image mode. [p.29](#)
- (16) SCREEN SIZE button : Changes screen size. [p.30](#)
- (17) RESIZE button : Enlarges image. [p.28](#)

Note

- For the remainder of this manual, buttons are referred to as follows:
 Selection buttons ⇒ ; ENTER button ⇒

Projector.com
 Sponsored by
 ProjectorMerchant.com (800) 281-8860
 THE TRUSTED SOURCE FOR PROJECTOR LAMPS AND ACCESSORIES

Names of the terminals on the rear panel

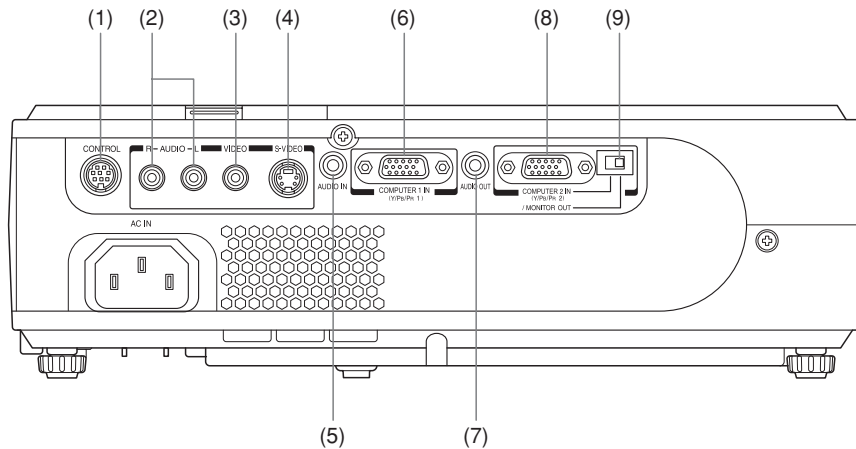

Name	Main Function
(1) CONTROL terminal	: When operating the projector via a computer, connect this to the controlling computer's RS-232C port. p.53
(2) AUDIO (L/R) terminal	: Input audio signals from video equipment.
(3) VIDEO terminal	: Input video signals from video equipment.
(4) S-VIDEO terminal	: Input S video signals from video equipment.
(5) AUDIO IN terminal	: Input audio signals from a computer, or from video equipment with a component video signal output terminal.
(6) COMPUTER 1 IN terminal	: Input RGB signal from a computer or other source or a component video signal (Y/P _B /P _R) from video equipment.
(7) AUDIO OUT terminal	: Outputs audio signals.
(8) COMPUTER 2 IN terminal (Also used for MONITOR OUT terminal)	: Inputs RGB signal from a computer or other source or a component video signal (Y/P _B /P _R) from video equipment. It can also be used as MONITOR OUT terminal by the switch of (9).
(9) Switch	: Switches between COMPUTER 2 IN and MONITOR OUT.



Discount-Merchant.com 1-800-281-8860
THE TRUSTED SOURCE FOR PROJECTOR LAMP AND ACCESSORIES

Preparing and using the remote control

■ Loading dry-cell batteries into the remote control

- 1 Remove the battery cover.

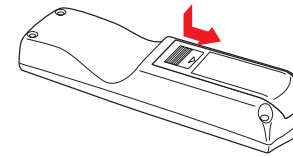

- 2 Insert the dry-cell batteries.

Be sure to align the plus and minus ends of the batteries properly.

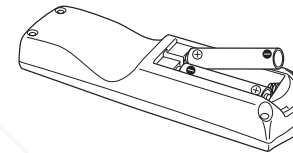

- 3 Replace the battery cover.

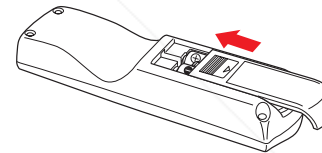

■ Operating the remote control

Point toward the projector's infrared remote sensor, and press a button on the remote control.

- Operating the projector from the front

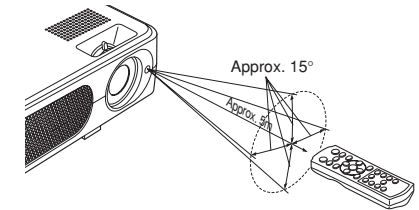

When operating the remote control from behind the projector, the infrared beam is reflected on the projecting surface and may travel a shorter distance to reach the projector depending on the shape and material of the projecting surface.

■ Dry-cell batteries

- Before using the batteries, be sure to observe the Safety Precautions described in previous pages.
- Remove batteries from remote control when not using for extended periods.
- If the remote control stops working, or if its range decreases, replace all the batteries with new ones.

■ The remote control

- The remote control may fail to operate if the infrared remote sensor is exposed to bright sunlight or fluorescent lighting.
- Do not drop or bang.
- Do not leave in hot or humid locations.
- Do not allow it to get wet or place it on top of wet objects.
- Do not take apart.
- In rare cases, ambient conditions could impede the operation of the remote control. If this happens, point the remote control at the main unit again, and repeat the operation.

Placement

Placement Styles

As shown in the figures below, this device can be placed in 4 different styles. The factory setting is "floor-mounted front projection." Set the [Projection mode] in the **Default setting 2** menu, in accordance with your needs. [p.41](#)

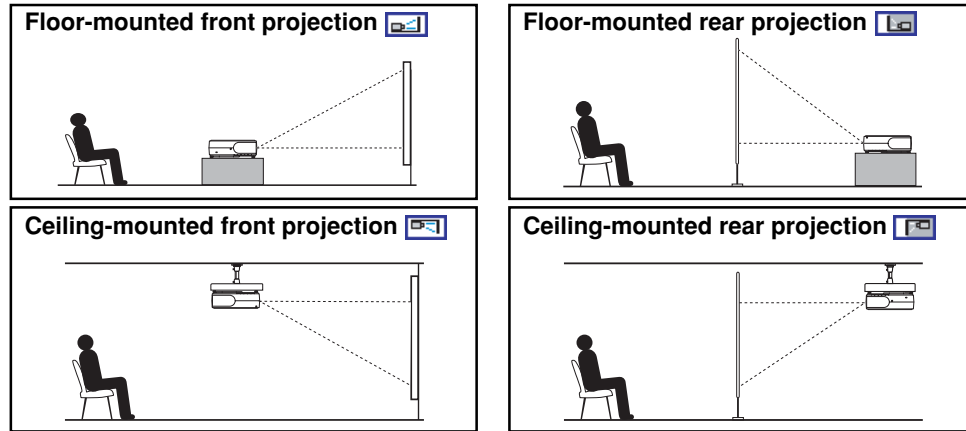

WARNING

- Always obey the instructions listed in IMPORTANT SAFETY INSTRUCTIONS when placing the unit. Attempting to clean or replace the lamp in a high location by yourself may cause you to fall, resulting in injury.
- If you wish to mount the projector on the ceiling, be sure to ask your dealer to do so. Mounting the projector on a ceiling requires special ceiling brackets (sold separately) and specialized knowledge. Improper mounting could cause the projector to fall, resulting in an accident.
- If the projector is ceiling-mounted, install the breaker for turning off the power in case of anomaly. Let everyone involved with the use of the projector know that fact.

Projection Distance and Size

Use the figures, tables, and formulas below to determine the projection size and projection distance. (Projection sizes are approximate values for full-size picture with no keystone adjustment.)

Screen **As seen from above**

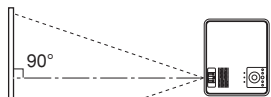

As seen from the side

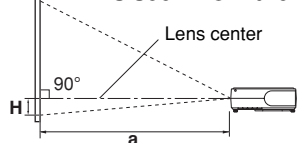

a is the distance (m) between the lens and the screen, and corresponds to a range of 1.15 m to 8.80 m. **H** is the height from the image bottom to the center of the lens.

$$a \text{ (min length)} = \frac{\text{projection size (inches)} - 0.9164}{33.998}$$

$$a \text{ (max length)} = \frac{\text{projection size (inches)} - 0.7525}{28.266}$$

projection size (inches)	projection distance a (m)		height (H) (cm)
	min length (200 Pin max)	max length (zooming min)	
33	1.15	1.15	6.7
40	1.15	1.39	8.1
60	1.74	2.10	12.2
80	2.33	2.80	16.3
100	2.91	3.51	20.3
150	4.39	5.28	30.5
200	5.86	7.05	40.6
250	7.33	8.82	50.8
300	8.80	-	61.0

Connection

Before connection

- Read the owner's manual of the device you are connecting to the projector.
- Some computers cannot be used with or connected to this projector. Check for an RGB output terminal, supported signal [p.51](#), etc.
- Turn off the power of both devices before connecting.
- The figure below shows sample connections. This does not mean that all of these devices can or must be connected simultaneously. (Dotted lines mean items can be exchanged.)

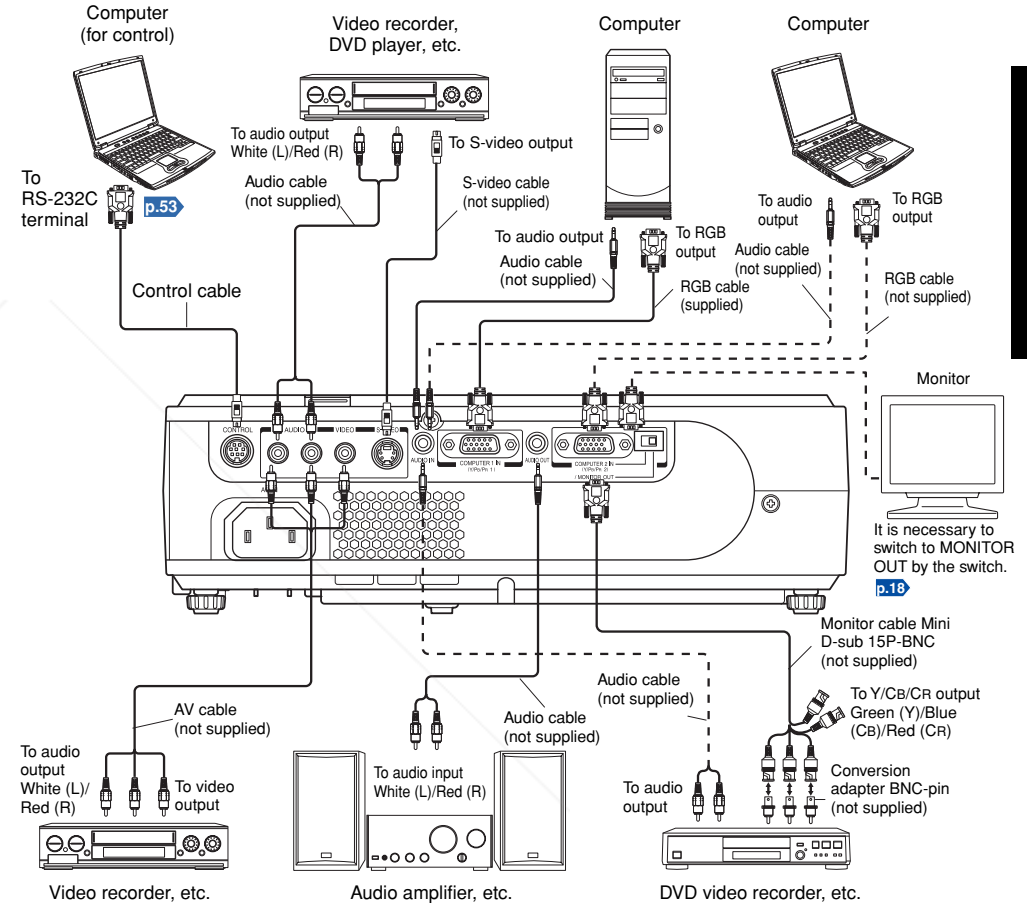

Preparations

It is necessary to switch to MONITOR OUT by the switch. [p.18](#)

FixYourPC.com
Discount-Merchants.com (800) 281-8860
THE TRUSTED SOURCE FOR PROJECTOR LAMPS AND ACCESSORIES

Connection (Continued)

Notes

- When COMPUTER 2 IN terminal (also used for MONITOR OUT terminal) is used as MONITOR OUT terminal, the signal which is input to COMPUTER 1 IN terminal is output.
- Signals are output from MONITOR OUT terminal even in standby mode. However, from AUDIO OUT terminal, no audio signal is output.
- A computer monitor cannot accept Y/PB/PR signals correctly.
- The AUDIO IN terminal doubles for devices connected to COMPUTER 1 terminal and COMPUTER 2 terminal.
- When an AUDIO OUT terminal is connected, sound is not output from the projector speaker.
- Output volume of AUDIO OUT terminal can be adjusted by the **VOL** button.
- Moving pictures played back on computers using DVD software may appear unnatural when projected with this projector. However, it is not a malfunction of the projector.

Turning the power on and off

Connecting the power cord

- 1 Insert the power cord connector into the AC IN socket of the projector.
- 2 Insert the power cord plug into a wall or other power outlet.

The ON/STANDBY indicator will change to orange, indicating standby mode.

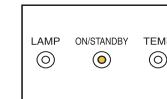
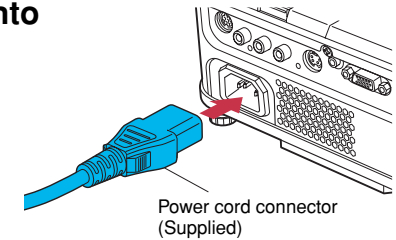

Removing the lens cover

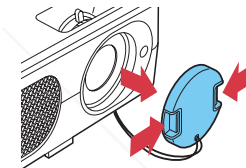

Be sure to remove the lens cover when the power is turned on. If the cover is left on the projector, it could become deformed due to heat.

Turning the power on Press the ON/STANDBY button.

When the beep sound is [On], the projector beeps, the power turns on, and the ON/STANDBY indicator lights in green. After a moment, the start-up screen appears.

Control panel

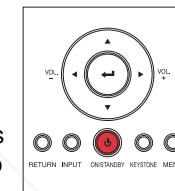

Remote Control

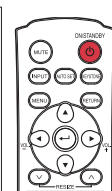

Start-up screen



CAUTION

- Do not look into the lens while the lamp is on. The strong light from the lamp may cause damage to your eyesight.
- Do not block the air intake or exhaust. Doing so could cause a fire due to internal overheating.
- Do not place your hands, face, or other objects near the air exhaust. Doing so could result in injury and/or damage the object.

Turning the power on and off (Continued)

Notes

- The start-up screen will disappear after a moment. You can dismiss the start-up screen before this by performing any operation. You can also configure the system to prevent the start-up screen from appearing. To do this, use the **Display setting** menu [p.37](#).
- The first time you use the projector after purchase, after the start-up screen disappears, the start menu is displayed [p.25](#).
- Beep sound can be set not to beep in the **Default setting 1** menu [p.40](#).
- When **[Key lock]** is **[On]**, the operation buttons of the projector do not work [p.41](#).
- When **[Password setting]** is **[On]**, then the start-up screen is displayed after the Password entry screen disappears [p.31](#).

Turning the power off

1 Press the ON/STANDBY button.

A message appears on the screen, confirming that you wish to shut off the power. This message will disappear after a moment. (This operation is no longer valid after the message disappears.)

2 Press the ON/STANDBY button once again.

When the setting of beep sound is **[On]**, the projector beeps, and the screen turns off, but the internal cooling fan continues to operate. Then, the projector goes into standby mode.

During cooling, the ON/STANDBY indicator flashes. While the indicator is flashing, the power can not be turned back on. At this point of time, it does not matter even if you unplug the power cord.

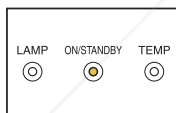

Note

- The projector consumes about 10W of power in standby. We recommend that you unplug the power cord if you will not be using the projector for an extended period.

PRECAUTION

- If you turn the power on before cooling is complete, give the lamp time (about 5 minutes) to cool before plugging it back in. If the lamp overheats, it may fail to light.

LCD Panels

LCD panels wear out. In order to prolong the lifetime of your LCD panel, take the following precautions.

- In order to extend the lifetime of the LCD panel, always turn off the power when not in use, and make sure that the lamp is off. Keeping the lamp off is also very effective at saving electricity.
- If the air filter becomes dirty and clogged, the projector's internal temperature will rise, shortening the lifetime of the LCD panel and causing malfunctions. Clean the air filter from time to time [p.46](#), and replace it periodically. Contact the store where you purchased your projector, or your local Service Station for replacement air filters.

Basic operations

1 Turn on the power.

Turn on the power by following the instructions in "Turning the power on" [p.23](#).

2 Select the language (When using the first time).

When the projector is used for the first time after purchase, the start menu for language (to display the menus and messages on the screen) selection is displayed in English. (If the screen is out of focus, adjust it according to the step [p.25](#).)

Use the **▲** or **▼** button to select the desired language and press the **⏻** button.

Message for setup confirmation is displayed in a selected language.

English	English
Français	French
Deutsch	German
Italiano	Italian
Español	Spanish
Português	Portuguese
Русский	Russian
Svenska	Swedish
Türkçe	Turkish
Polski	Polish
日本語	Japanese
中文(简体字)	Chinese (simplified)
中文(繁體字)	Chinese (traditional)
한국어	Korean

Notes

- When the projector is turned on the next time, the start menu does not appear upon startup. However, if **[Reset all]** is executed from the **Default setting 2** menu [p.41](#), the start menu will be displayed the next time when the power is turned on.
- The language can also be set via the **Display setting** menu [p.37](#).
- This owner's manual assumes that English has been selected.

3 Activate the connected device.

Turn on and start the connected device such as a computer.

4 Press the INPUT button.

An image of the connected equipment is projected.

Each time you press the **INPUT** button, it switches to the input of the connected equipment that is outputting video signals.

Notes

- When **[Auto input search]** is set to **[Off]** in the **Default setting 1** menu [p.40](#) (factory setting is **[On]**), the **Input select** menu appears if you press the **INPUT** button.
- If no signal is being output from the connected equipment, pressing the **INPUT** button does not change the input and "There is no other input signal." will appear.

Basic operation (Continued)

5 Projector placement angle adjustments

The placement angle and the height of the projected image can be adjusted by the foot adjuster.

- 1 Lift up the front of the projector to the desired angle, then press the foot adjuster release button.

The foot adjuster extends. Release the button to lock the position.

- 2 To fine adjust the angle, twist the foot adjuster.

- 3 To adjust the horizontal angle, use the right and left tilt adjusters.

- To stow the foot adjuster, hold up the projector while pressing the foot adjuster release button, then slowly lower the projector.

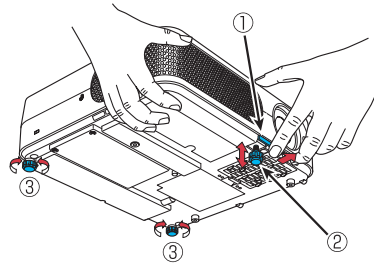

6 Adjusting the screen size and focus

- 1 Use the zooming lever to adjust the screen size.

- 2 Use the focusing ring to adjust the focus.

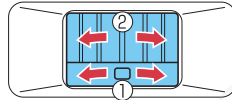

7 Adjusting the volume with the ◀ ▶ buttons

The speaker volume can be adjusted when an audio signal is being input.

Notes

- Lamp characteristics may rarely cause the brightness to fluctuate slightly.
- A lamp is consumable item. If used for extended periods, images will appear dark, and the lamp could burn out. This is characteristic of a lamp, and is not malfunction. (The lifetime of the lamp depends on conditions of use.)
- The LCD panel is made using extremely advanced technology. There may be black spots (pixels that do not light) or bright spots (pixels that are constantly lit) on the panel. These are intrinsic characteristics of the technology and are not malfunctions.
- Although this projector supports a wide range of RGB signals (p.51), any resolutions not supported by this projector (XGA) will be expanded or shrunk, which will affect image quality slightly. To view high-quality images, set the computer's external output to XGA.
- With some models of computer having LCD displays or the like, displaying images simultaneously on the projector and the computer's display may prevent the images from displaying properly. If this happens, turn off the computer's LCD display. For information on how to turn off the LCD display, see the computer's owner's manual.
- If no signal is being input from the connected equipment or signal input is stopped while projecting, the "No signal" message will appear.
- If a signal not supported by the projector is input, the "Unsupport signal" message will appear.
- If an unavailable operation button is pressed, the ✖ icon will appear.

Using handy features

Using auto setting (For computer input only)

This function automatically sets up the projector to the optimum state. It sets up sampling phase, frequency and screen position, for each type of the input signal by using simple operations.

- Press the remote control's AUTO SET button.

For computer input, the  icon will appear during processing. You can set as well by selecting [Auto setting] in the Image adjustment menu (p.35).

Notes

- The image may not be projected or auto adjustment/setting may not be performed correctly for input signals other than those supported by the projector (p.51, p.52).
- If auto setting fails adjustment, adjust manually with [Position] in the Image adjustment menu (p.35).

Remote Control



Correcting the keystone distortion

When the projector placement angle against the screen is changed while projecting the image, the picture will undergo keystone (trapezoidal) distortion.

This projector is capable of correcting this keystone distortion.

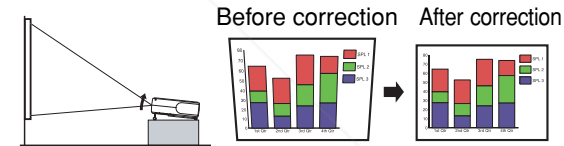

Control panel

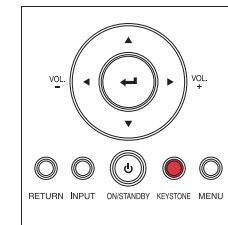



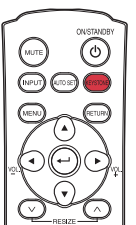

Remote Control



- 1 Press the KEYSTONE button.

The Keystone menu appears. By default, [Auto v-keystone] is selected.



Item	Description
 Auto v-keystone	Automatically corrects the vertical distortion. Press  .
 V-keystone	Screen shrinking at bottom   Screen shrinking at top

Using handy features (Continued)

Adjusting Keystone distortion [Auto]

2 Press the button.

The keystone distortion is automatically corrected. The  icon appears during this correction.

When adjustment is finished, the **Keystone** menu appears again. For fine adjustment, select [V-keystone] by the  button and adjust image manually by the  buttons.

Adjusting Keystone distortion [Manual]

2 Select [V-keystone] by the button.

3 Use the buttons for keystone adjustment.

Note

- Depending on the amount of keystone adjustment and the content of images, some information may be lost, or the picture quality may suffer.

Resizing image

The projected image can be resized (zoomed in/out).

1 Press the remote control's **RESIZE** button.

Each time you press the **RESIZE**  button, zoom ratio is up. You can keep pressing.



2 To zoom out, press the remote control's **RESIZE** button.

Each time you press the **RESIZE**  button, zoom ratio is down. You can keep pressing. (However, the image cannot be smaller than the original size.)



3 To move the area to zoom in, use the buttons.

You can keep pressing.



4 To reset the zoom, press the **RETURN** button.

The image is reset to the original size.

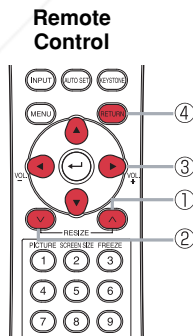

Notes

- The  icon appears while resizing.
- Operating a function other than Mute will release resizing.
- As zooming is processed digitally, the image quality is degraded in larger zoom ratio.
- During resizing or moving the zooming area, the image may be distorted.

Cutting off the picture and sound temporarily (Mute)

When you want to project the images of another projector, overhead projector, etc. temporarily, this projector's images and sound can be turned off.

Press the remote control's **MUTE** button.

The picture and sound are cut off. (The Mute function is released when pressing the **MUTE** button again.)

Notes

- The  icon will appear while mute is in effect.
- Operating any other functions will also cancel the muting.

Remote Control

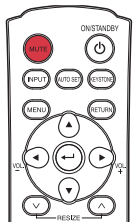

Changing picture mode

The projected image mode can be selected.

Press the remote control's **PICTURE** button.

1 The Picture mode menu appears.

- Brightness
- Standard
- True color

2 Select a mode using then press .

Though the  button is not pressed, the picture mode changes as the setting is changed and the display turns off automatically in a few seconds.

Note

- [Picture mode] of the **Image adjustment** menu has the same function [p.35](#).

Remote Control

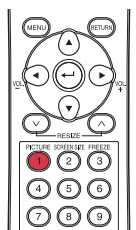

Using handy features (Continued)

■ Changing screen size

The screen size for the projected image can be changed.

● Press the remote control's SCREEN SIZE button.

Pressing the button switches Full/Thru/Wide in turn.

■ Notes

- Thru display is available for computer-input images.
- [Screen size] of the **Display setting** menu has the same function [p.37](#).
- If you use this function on commercial video software, broadcast or cable-broadcasting except for the purpose of your private viewing and listening, it may infringe the copyright protected by the copyright laws.

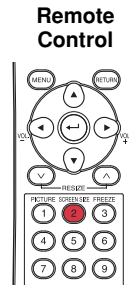

■ Freezing the image (Freeze)

The projected image can be frozen. This function is to be used to pause a video during a presentation, etc.

● Press the remote control's FREEZE button.

The picture pauses. (The Freeze function is released by pressing the FREEZE button again.)

■ Notes

- The  icon will appear while freeze is in effect.
- Other operations will also release the freeze.
- Even if an image is frozen on the projector, the pictures are running on the video or other equipment.
- If you use this function on commercial video software, broadcast or cable-broadcasting except for the purpose of your private viewing and listening, it may infringe the copyright protected by the copyright laws.

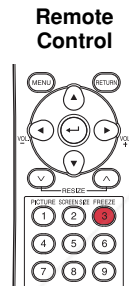

■ Setting the password

● How to change password

The default password is 0000.

① Select [Password] in the Default setting 2 menu and press the or button.

② Select [Password registration] in the password registration, setting menu, and press the button.

The password entry screen is displayed.

③ Enter the current password (4-digit number).

- Enter a 4-digit number for the password using numeric keys of the remote control.
- Enter [0000] (4 zeros) for the first change.
- The password is not displayed. Instead it appears as [****].

④ Enter a new password (4-digit number).





⑤ Re-enter the same password for confirmation.

■ Note

- Please do not forget your password. If you forget the password, you can not release the password by yourself. In such a case, please inquire your dealer.

Using handy features (Continued)

● How to set password (from [Off] to [On])





- 1 Select [Password] in the Default setting 2 menu and press the  or  button.
- 2 Select [Password setting] in the password registration, setting menu, and press the  or  button.
- 3 Select [On].
- 4 Select [OK] and press the  button.
The password entry screen is displayed.
- 5 Enter the password using numeric keys of the remote control.
- 6 The password setting will be set as [On].

● How to operate when password is [On]

- 1 Turn on the power.
- 2 The lamp lights and the password entry screen appears.
- 3 Enter the password using numeric keys of the remote control.

If the entered password is correct, the start-up screen appears and the projector goes into normal operation. If the password is wrong, a message appears to prompt you to re-enter the password, and again the password entry screen is displayed. If you enter a wrong password for more than 5 times, the projector will automatically power off and enter standby mode.

● How to set password (from [On] to [Off])

- 1 Select [Password] in the Default setting 2 menu and press the  or  button.
The password entry screen is displayed.
- 2 Enter the password using numeric keys of the remote control.
- 3 Select [Password setting] in the password registration, setting menu, and press the  or  button.
- 4 Select [OFF].
- 5 Select [OK] and press the  button.

■ Note

- While the password setting is [On], the password entry screen will be displayed only when the power is turned on next time.



Discount-Merchant.com (800) 281-8860
THE TRUSTED SOURCE FOR PROJECTOR LAMPS AND ACCESSORIES

Using the menus

You can call up on-screen menus, and conduct a number of adjustments and settings using the operation buttons [p.16](#) on the control panel (main unit side) and remote control.

How to use the menus

The menu shown below is for operation instructions purposes and might differ from the actual display.

1. Press the MENU button Display the **Setting display** menu.

2. Select a Category

Select a category by using . There are following 5 categories:

- Image adjustment menu** [p.35](#)
- Display setting menu** [p.37](#)
- Default setting 1 menu** [p.40](#)
- Default setting 2 menu** [p.41](#)
- Status display menu** [p.42](#)



Displays the current adjustments and settings of selected category. Item shown with gray cannot be adjusted with the current input source.

3. Adjustments & Settings Press or to open the menu.

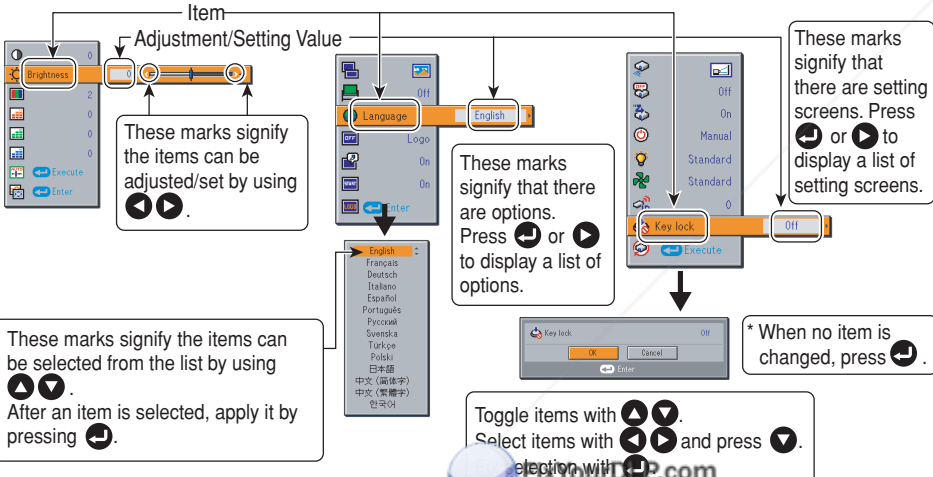

Item / **Adjustment/Setting Value**

These marks signify the items can be adjusted/set by using .

These marks signify that there are options. Press or to display a list of options.

These marks signify that there are setting screens. Press or to display a list of setting screens.

These marks signify the items can be selected from the list by using . After an item is selected, apply it by pressing .

Toggle items with . Select items with and press . Selection with .

* When no item is changed, press .

Discount-Merchant.com (800) 800-8008
Sponsored by DM

4. End Press the MENU button.
(The menu disappears about 30 seconds after the last operation.)

The image adjustment menu

Use this menu to set or adjust image-related items. Items that can be set or adjusted are marked "Yes", and those that cannot are marked "No". (When an item is masked, it indicates that you cannot select for the current input.)

Item	Description	Computer	Y/Pb/Pr	Video	S-video
Contrast	Adjust the image contrast. Lower Higher	Yes	Yes	Yes	Yes
Brightness	Adjust the brightness of the image. Darker Brighter	Yes	Yes	Yes	Yes
Color	Adjust the color of the image. Lighter Deeper	No	Yes	Yes	Yes
Sharpness	Adjust the sharpness of the image. Softer Sharper	Yes	Yes	Yes	Yes
Noise reduction¹⁾	Set the function to reduce screen noise. On (Enable) Off (Disable)	No	Yes	Yes	Yes
Picture mode	Press . Toggle the picture mode with . 1/2/3	Yes	Yes	Yes	Yes
R-level	Adjust red of the image color. Less red More red	Yes	Yes	Yes	Yes
G-level	Adjust green of the image color. Less green More green	Yes	Yes	Yes	Yes
B-level	Adjust blue of the image color. Less blue More blue	Yes	Yes	Yes	Yes
NTSC mode²⁾	Set the black level with . US : NTSC (US) mode JAPAN : NTSC (JAPAN) mode	No	No	Yes	Yes
Auto setting	Automatically adjusts items such as the sampling phase depending on the type of input signal.	Yes	No	No	No
Position	Press then change mode using and adjust with .	Yes	No	No	No
	Phase Adjust to eliminate flicker.	Yes	No	No	No
	Frequency Adjust to eliminate periodic patterns and flickering when many fine vertical lines appear on the screen.	Yes	No	No	No
	H-position Adjust the horizontal position of the image.	Yes	No	No	No

Using the menus (Continued)

Item ▲ ▼	Description	Computer	Y/Pb/Pr	Video	S-video
Position	V-position Adjust the vertical position of the image.	Yes	No	No	No
	Clamp 1 Adjusts the clamp pulse position.	Yes	No	No	No
	Clamp 2 Adjusts the clamp pulse width.	Yes	No	No	No

*1: **[Noise reduction]** may not work depending on signal type.

*2: **[NTSC mode]** can be displayed and adjusted only when the video signal is set to **[NTSC]** or **[NTSC4.43]**. NTSC mode is set to JAPAN when the language is set to Japanese. It is set to US for other languages.

■ The display setting menu

Use this menu to set screen display-related items.
(The items in gray color cannot be set with the current input selection.)

Item ▲ ▼	Description
Screen size	 (Full): Display with 1024 × 768 dot resolution (Thru): Display with sampling resolution (for computer input only) (Wide): Wide-screen display
Up/down shift	Lets the projected image shift vertically when the screen size setting is wide display (within the range of 1024 × 768).
Blackboard mode	When projecting on a non-screen surface, select a color in accordance with the projecting surface. Press and switch with and . Off/Green/Black/Brown/Blue/Beige
Language	Select one of the languages below to use for displaying the menu and messages [or : Enter setting mode] → [/▼: Selection] → [Apply:] English/Français/Deutsch/Italiano/Español/Português/Русский/Svenska/Türkçe/Polki/日本語/中文(簡体字)/中文(繁体字)/한국어
Background	Screen to display when there is no input signal [or : Enter setting mode] → [/▼: Selection] → [Apply:] Logo/Blue/None
Icon	Display icons as function guides On Off
Start-up screen	Display start-up screen when power is turned on On Off
User logo	Display a logo customized by the user for the start-up screen or when there is no input signal. [or : Enter setting mode] → [/▼: Selection]
	Logo registration Press to display the registration menu.
	Display style
	Background Black Blue White
	Logo confirmation Press .
	Reset logo Yes No

● Detailed description

[Screen size]

- If "Thru" is selected for [Screen size], portions exceeding the native resolution (1024 × 768 pixels) will not appear on the screen. Note that for RGB signals with clock frequency 140MHz or lower, all input pixel signals are sampled. However, if the clock speed is higher than this, the RGB pixel signal is thinned before sampling.

Using the menu (Continued)

Note

- If you use the screen size setting function on commercial video software, broadcast or cable-broadcasting programs to display images with the varying aspect ratio except for the purpose of your private viewing and listening, it may infringe the copyright protected by the copyright laws.

[Up/down shift]

Shifts the projected image vertically when [Screen size] is [Wide].

[Blackboard mode]

Projects the image in colors more like projecting on a screen.

Precaution

- The projected image may differ depending on the type, color, and material of the blackboard and wall even if the selected color is the same as the projected screen.

[Background]

- TOSHIBA is set for [Logo] by factory setting.
- If user's logo has been registered, it is displayed when [Logo] is set for background.

[Start-up screen]





If user's logo has been registered and this setting is [On], the logo is displayed at start-up.

[User logo]

Registers a part of the image that is input from computer, as a stationary picture and displays it as a logo at start-up and when no signal is input.

<Logo registration>

How to register user logo



- 1 Select [User logo] in the Display setting menu, and press the  or  button.
- 2 Select <Logo registration> from the displayed menu list and press the  button.
- 3 The registration area is displayed for confirmation. Select [OK] or [Cancel] and press the  button.
 - If the registered picture does not fall within the display area, operate the computer to scroll the screen.
- 4 Select [Yes] to register and press the  button.
- 5 Registration starts.
 - A message is displayed while registration is in process.

Notes

- You can register a logo from computer input only.
- The area that can be registered is 512 × 384 dots at the center of the screen. To register a company logo, prepare the image within the limit.
- Only one logo can be registered. When a new image is registered, the old one is erased.
- The time needed to register or display the image varies depending on the data size.
- If you use this function on commercial video software, broadcast or cable-broadcasting except for the purpose of your private viewing and listening, it may infringe the copyright protected by the copyright laws.

<Display style>

Select the size of the registered logo.

- : Displays the registered image in original size at center of the screen.
- : Displays the registered image by enlarging fully in the screen.
(As processed digitally, the image quality is degraded.)

<Background>

Sets background color when [Center] is selected for the logo [Display style].

<Logo confirmation>

You can preview the registered logo.

<Reset logo>

You can reset the registered logo, display style and background to the factory setting. (The logo set for the start-up screen and background is reset.)

Using the menus (Continued)

■ The default setting menu

This menu shows placement status and other settings.

Default setting 1 menu

Item ▲▼	Description
No signal power off	Set the time to wait for the power to be turned off after the last operation is made with no input signal. Off (not turned off) ◀▶ 30 min.
Auto input search	Set whether the input with signals is only selected or not. On ▶▶ Off
Beep	Beep when operation is made. On ▶▶ Off
Power on	Sets whether to turn on the power when the ON/STANDBY button is pressed (Manual), or when the power cord is plugged in (Auto). Manual ▶▶ Auto
Lamp power	Sets the lamp power. Low ▶▶ Standard

● Detailed description

[Auto input search]

[On]: Automatically searches the signals that can be projected, and switches input from the connected device that outputs the video signals each time the **INPUT** button is pressed. The input from the connected device that outputs no video signals is skipped.

[Off]: Displays the **Input select** menu.

Toggle with ▼▲ buttons and press ◀ button. (The input without signals can be selected.)

[Power on]

If **[Power on]** is set to **[Auto]** and there is a power outage, the projector will come on once power is restored.

[Lamp power]

[Standard]: The screen becomes a little brighter, but the cooling fan noise gets louder.

[Low]: The screen becomes a little darker, but the cooling fan noise gets quieter.

Input select menu

Input select	
●	Computer 1
○	Y/Pb/Pr 1
●	Computer 2
○	Y/Pb/Pr 2
●	Video
○	S-video

●/○ shows whether signal is input or not.

Default setting 2 menu

Item ▲▼	Description
Projection mode	Sets projection mode in accordance with Placement Style. p.20 (Standard) ◀▶ (Rear) ◀▶ (Ceiling) ◀▶ (Rear ceiling)
Fan mode	Sets the cooling fan speed. Standard ▶▶ High
Key lock	Lock the control panel buttons. [◀ or ▶]: Enter setting mode] → [▶▶]: Select On/Off] → [◀: Confirm] → [▶▶]: Select OK to end] Press [Cancel] to return.
Reset all	Press ◀. (The password and user logo are not reset.) Resets all adjustments and settings to their factory settings. Yes ▶▶ No
Password	Password setting p.31

● Detailed description

[Fan mode]

Setting **[Fan mode]** to **[High]** increases the cooling fan speed. (The cooling fan noise gets louder.) Set this option to use the projector, for example, at high altitude (over 1,500 meters above sea level).

- Do not set Fan mode to **[High]** when using the projector at a lower altitude.

[Key lock]

Protect from operating errors by locking on the control panel buttons of the projector. (The remote control operations are available.) Control panel operations are locked after the setting is done, and accordingly operation with the control panel buttons is disabled.

- To release the key lock, set the **[Key Lock]** to **[Off]** using remote control. Pressing the **[RETURN]** button on the projector for 10 seconds also sets the **[Key Lock]** to **[Off]**. (When operating the main unit, the 2 indicators of LAMP and TEMP light in orange for 3 seconds, and at the same time the projector beeps.)

Using the menus (Continued)

■ Displaying Information (Status display)

This displays information about the input signal, lamp use time, etc.

“Yes”: displayed, “No”: not displayed

Item	Description	Computer	Y/P _B /P _R	Video	S-video
Projector					
Input	Input source name	Yes	Yes	Yes	Yes
Mode name	RGB input mode ^[Note 1]	Yes	No	No	No
Resolution	Resolution (in dots)	Yes	No	No	No
Frequency	Sync frequency	Yes	No	No	No
Sync	Sync signal polarity ^[Note 2]	Yes	No	No	No
Signal format	Y/P _B /P _R signal format	No	Yes	No	No
Video mode	Color method of video signal	No	No	Yes	Yes
Lamp time	Time of lamp use ^[Note 3]	Yes	Yes	Yes	Yes
Lamp reset count	The count for lamp replacement	Yes	Yes	Yes	Yes
Total time	The total time that this projector is used.	Yes	Yes	Yes	Yes
Version	Firmware version ^[Note 4]	Yes	Yes	Yes	Yes

Notes

- 1: The mode of supported RGB signals [p.51](#) is shown.
- 2: Sync signal polarity shown as P (positive) or N (negative) for [H/V].
- 3: Displays [Lamp time] as a measure of when the lamp should be replaced. (Cannot be used as a counter of guaranteed lamp time.) Please replace the lamp after 2000 hours of use if [Lamp power] is set to [Standard], or after 3000 hours of use if [Lamp power] is set to [Low], consult with a dealer about getting replacement for lamp TLPLW11 (sold separately).
- 4: [Version] shows the version of the projector's internal control program. This firmware version will be requested for customer service purposes.

■ Note

- The displayed information will not be refreshed if the status changes. To refresh the information, dismiss the display, then display it again.

About lamp

The product's light source is a mercury lamp that lights at increased internal pressure. Be sure to fully understand the following characteristics of the lamp and handle it with extreme care.

- The lamp may burst with a loud noise due to impact or deterioration, or fail to light at the expiration of its life.
- How long it takes before the lamp bursts or the life expires may vary greatly by lamp. Some may burst shortly after first use.
- Burst is likely to happen if the lamp is used after the replacement period has elapsed.
- When the lamp bursts, the broken pieces of glass may get inside the product or be released outside from the openings for ventilation.
- When the lamp bursts, a slight amount of mercury gas enclosed in the lamp along with glass dust may be released from the openings for ventilation.

■ Immediately replace the lamp when a replacement message appears on the screen.

- When the replacement time approaches, a message will appear on the screen.
- The risk of burst will increase if the lamp is continuously used without being replaced.
- Frequently check the used hours and prepare spares when the replacement time approaches. (Refer to “Status display”. [p.42](#))

■ When the lamp is broken

- If glass components, including a lamp and a lens, should break, handle the broken pieces with care to avoid injury and contact your dealer for repair service.
- In the event of lamp burst, unplug the product from the wall outlet, leave and completely ventilate the room. Then, thoroughly clean the area around the projector and discard any edible items placed in that area, as they may be contaminated.
- If the lamp bursts, consult a doctor if glass dust or mercury gas gets into your eyes or is inhaled.



Discount-Merchant.com (800) 281-8860
THE TRUSTED SOURCE FOR PROJECTOR LAMPS AND ACCESSORIES

Lamp replacement

A lamp is consumable supplies. If used for extended periods, images will appear dark, and the lamp could burn out. This is characteristic of a lamp, and is not malfunction. (The lifetime of the lamp depends on condition of use.) If this happens, replace it with a new one.

⚠ WARNING

- If the projector is mounted on the ceiling, it is recommended to use your Toshiba dealership when the lamp has to be exchanged. Uncovering the lamp while the projector is mounted on a ceiling may lead to a danger of damage from falling pieces of glass if the lamp is broken. Besides, working at high elevations can also be hazardous. Do not attempt to replace the lamp by yourself.
- When replacement is required, be sure to use TLPLW11 (sold separately).

⚠ CAUTION

- If you have been using the projector, the lamp will be very hot, and may cause burn injuries. Wait for the lamp to cool (for longer than 1 hour) before replacing it.
- If the lamp should break, please handle with care to avoid injury due to broken pieces (p.43) and contact your dealer for repair service.

1 Unplug power cord.

2 Wait until lamp is sufficiently cooled.

Wait for at least 1 hour.

3 Remove the lamp cover.

Loosen the two screws, raise the lamp cover with your fingers as shown to remove the lamp cover. Use care to avoid any damage to nails and/or tip of your finger(s). If you have any difficulty in removal, you can use a screwdriver or any other smaller tool for your convenience.

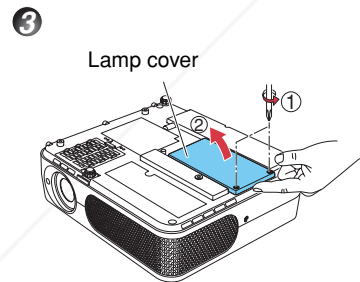

4 Pull out the lamp.

Loosen the three lamp locking screws, pull the handle, and remove the lamp.

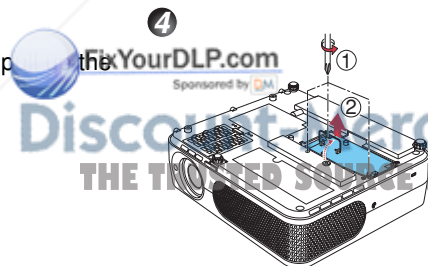

5 Mount the new lamp.

Align the orientation, press down the new lamp until the bottom is reached, and lock in place using the three lamp locking screws.

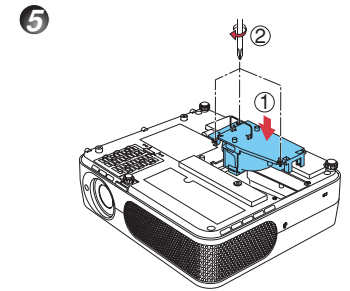

6 Replace the lamp cover.

Align the cover, and press it in, then tighten the screws loosened in step 3 until the lamp cover is no longer loose.



7 Reset the lamp time.

See the lamp's manual for instructions on resetting the lamp time.

■ Notes and Precautions

- The [Lamp time] item in the **Status display** menu indicates the time of lamp use (as a rough guide) p.42
- Please replace the lamp after 2000 hours of use with [Lamp power] in the **Default setting 1** menu set to [Standard], and 3000 hours of use with [Lamp power] in the **Default setting 1** menu set to [Low]. p.40
- There are cases that the lamp can not work before the above mentioned period expires or before the replacement message is displayed.
- Attach the lamp cover correctly so that it is not loose. If it is not attached correctly, the projector may fail to be powered on or the lamp may fail to come on.
- Always replace the lamp with a new one.
- The lamp is made out of glass. Do not touch the glass surface with your bare hands, bang it, or scratch it. (Dirt, jolts, scratches and the like could break the lamp.)

● About lamp replacement messages

- The lamp replacement message of this projector displays an appropriate period according to the use period for [Standard] / [Low] of the [Lamp power] respectively.
- When the replacement time approaches, the message of "The lamp life is ending. Please change the lamp." and the icon  are displayed every time the power is turned on. This display disappears when you press the  button.

■ Used Lamps

This projector's lamps contain trace amounts of environmentally harmful inorganic mercury. Be careful not to break used lamps, and dispose of them in accordance with local regulations.

Air filter cleaning

The air filter prevents dust and debris from getting inside the projector. Never run the projector with the filter removed. It is recommended that the air filter is cleaned regularly.

- The message "Check the air filter for dirt." is displayed every 100 hours. (If the usage time exceeds 100 hours, this message is displayed for about 30 seconds when the image is displayed for the first time after power is turned on. This display will be dismissed with any operation.)
- Check out the filter and any debris is found, use the following procedure for cleaning.

⚠ WARNING

- Request cleaning and maintenance of a ceiling-mounted unit from your projector dealership.

1 Unplug power cord.

2 Remove the air filter.

Pull out the air filter by taking the catch shown in the figure.

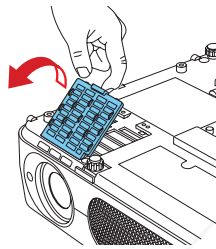

3 Clean the filter.

Carefully remove the dust and dirt from the air filter with a vacuum cleaner or the like.

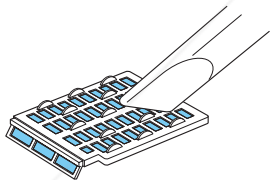

4 Replace the air filter.

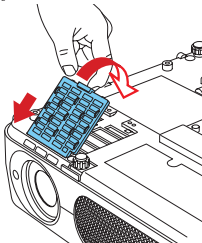

■ Notes

- Allowing dirt and dust to build up in the air filter will worsen the air circulation inside the projector, causing the internal temperature to rise, causing the projector to stop working or malfunction.
- Insert the air filter all the way in. Leaving gaps will allow dust and dirt to get inside the projector again.
- If you wash the air filter with water, make sure to dry it completely before replacing it.
- If the air filter is torn, consult with your dealer about replacing it with a new one. Continuing to use a ripped filter will allow dust and dirt to get inside the projector.

Lens and main unit cleaning

⚠ WARNING

- Request cleaning and maintenance of a ceiling-mounted unit from your projector dealership. Attempting to clean/replace the lamp at a high site by yourself may cause you to fall down, thus resulting in injury.

■ Lens cleaning

- Clean the lens with a commercially available blower and/or lens cleaner.
- The lens is easily scratched, so do not rub it with hard objects, or strike it.

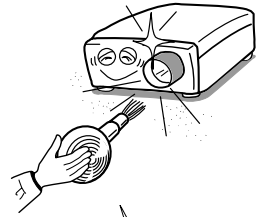





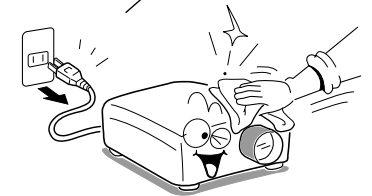



■ Main unit cleaning

- Unplug the power cord before cleaning the main unit.
- Wipe dirt off the main unit gently with a soft cloth.
- Do not wipe the main unit with a damp cloth. Doing so may allow water to get inside, resulting in an electric shock or unit failure.
- Do not use benzene, thinner and the like as they may deform or discolor the unit or damage the paint surface.
- When using a chemically treated cloth, follow the precautions included with the cloth.

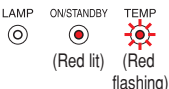

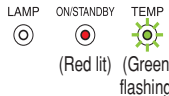
Trouble indications

The indicator lights to inform you of internal abnormalities.

<p>LAMP ON/STANDBY TEMP  (Off)</p>	<p>No power ⇒ Problem with projector • Unplug the power cord, and contact your dealer.</p>
<p>LAMP ON/STANDBY TEMP  (Red flashing) Or  (Red lit) (Red lit)</p>	<p>Lamp went out during use, or won't come on ⇒ Lamp temperature is high so that it is difficult to turn on, the lifetime of the lamp has ended or the projector is malfunctioning. • Unplug the power cord and wait for a short while, then turn the power back on. • If a lamp burns out, replace it with a new one. * The abnormal display will not disappear until the power cord is unplugged. You can not turn on the power during abnormal display.</p>
<p>LAMP ON/STANDBY TEMP  (Red lit) (Red flashing)</p>	<p>Power went out during use ⇒ Internal overheating, or the outside temperature is too high. • Place the projector so that the air intake and exhaust are not blocked. • Unplug the power cord and wait for a short while, then turn the power back on. * The  icon will appear before the power goes out. * The abnormal display will not disappear until the power cord is unplugged. You can not turn on the power during abnormal display.</p>
<p>LAMP ON/STANDBY TEMP  (Red lit) (Green flashing)</p>	<p>Power went out during use ⇒ Problem with internal cooling fan. • Unplug the power cord, and contact your dealer. * The  icon will appear before the power goes out. * The abnormal display will not disappear until the power cord is unplugged. You can not turn on the power during abnormal display.</p>
<p>LAMP ON/STANDBY TEMP  (Orange flashing) (Red lit)</p>	<p>Power went out during use, or power won't come on ⇒ The lamp cover is not properly attached. • Unplug the power cord, and reattach the lamp cover. p.45 * The abnormal display will not disappear until the power cord is unplugged. You can not turn on the power during abnormal display.</p>
<p>LAMP ON/STANDBY TEMP  (Red lit) (Orange lit)</p>	<p>Power went out during use ⇒ Problem inside the projector. • Unplug the power cord and wait for a short while, then turn the power back on. • If the above action will not clear the problem, unplug the power cord, and contact your dealer. * The  icon will appear before the power goes out. * The abnormal display will not disappear until the power cord is unplugged. You can not turn on the power during abnormal display.</p>

Before calling service personnel

If you think something is wrong, check the followings before contacting customer service. Please see "Trouble indications" [p.48](#) as well.

If This Happens	Check
No power	<ul style="list-style-type: none"> Is the power cord plugged in? Is it connected to the projector? Is the lamp cover attached properly? p.45
Power goes out during use	<ul style="list-style-type: none"> Is the ambient temperature high? p.48 Is the air intake or air exhaust blocked? p.48
No picture	<ul style="list-style-type: none"> Is the input source selected correctly? (When [Auto input search] is [Off]) p.25 Is the mute function on? p.29 Is the brightness setting minimized? p.35 Are the connections set up correctly? p.21 Are all the connected devices functioning properly?
No audio	<ul style="list-style-type: none"> Is the mute function on? p.29 Is the volume setting minimized? p.26 Are the connections set up correctly? p.21 Are all the connected devices functioning properly?
Picture not displayed correctly	<ul style="list-style-type: none"> Is the input signal supported by the projector? p.51 , p.52 Is there something generating an abnormal video signal, for instance the video tape?
Picture blurred Part of picture out of focus	<ul style="list-style-type: none"> Is the lens dirty? p.47 Is the lens focus adjusted optimally? p.26 Is the projection distance within the projector's supported range? p.20 Is the projector's screen placement angle tilted too far? p.20 Are the sharpness or sampling phase adjustments off? p.35
Image is dark	<ul style="list-style-type: none"> Are the brightness or contrast adjustments off? p.35 Is the lamp nearing the end of its service life? p.42
Colors too light Bad shading	<ul style="list-style-type: none"> Are the color, R-level, G-level, or B-level adjustments off? p.35 Is the screen dirty? Is the blackboard mode set properly? p.37 Is the lamp nearing the end of its service life? p.42
Control panel key doesn't work	<ul style="list-style-type: none"> Is the key lock function on? p.41
Remote control doesn't work	<ul style="list-style-type: none"> Are the remote control's batteries drained? Are the batteries inserted into the remote control correctly? p.19 Is the remote control being used within the effective range? p.19 Are there any obstructions between the remote control and projector? Are there any fluorescent or other bright lights shining at the projector's infrared remote sensor?

Specifications

■ List of general specifications

Item	Specification	
Consumption Power	320 W	
Weight	2.8 kg	
External Dimensions (including protruding parts)	288 × 92 × 247 mm (W × H × D)	
Cabinet material	PC resin and PC+ABS resin	
Conditions for usage environment	Temp: 5°C to 35°C; relative humidity: 30% to 70%	
LCD Panel	Display method	3-panel transmission
	Panel size	0.63 type
	Drive system	TFT active matrix
	Picture elements	786,432 pixels (1024H × 768V)
Lens	Zoom lens F=1.6-1.88 f=18.6-22.3 mm	
Lamp	High-pressure mercury lamp (220 W)	
Projection screen size	33-300 inches	
Projection distance	1.15-8.80 m	
Speaker	1W (Mono)	
Connection terminal	COMPUTER 1 IN terminal	Mini D sub 15 pin RGB / Y/Pb/Pr (dual use)
	COMPUTER 2 IN terminal	Mini D sub 15 pin RGB / Y/Pb/Pr / MONITOR OUT (dual use)
	S-VIDEO terminal	Mini DIN 4 pin
	AUDIO (L/R) terminal	RCA Pin Jack × 2
	VIDEO terminal	RCA Pin Jack
	AUDIO IN terminal	3.5mm dia. stereo mini-jack
	AUDIO OUT terminal	3.5mm dia. stereo mini-jack
	CONTROL terminal	Mini DIN 8 pin (RS-232C)

■ Notes

- This model complies with the above specifications.
- Designs and specifications are subject to change without notice.
- This model may not be compatible with features and/or specifications that may be added in the future.

■ Separately sold product

Replacement Lamp

Model TLPLW11



Discount-Merchant.com (800) 281-8860

THE TRUSTED SOURCE FOR PROJECTOR LAMPS AND ACCESSORIES

■ List of supported signals (RGB signals)

This projector supports the following RGB signals. Note, however, that depending on the computer model, the screen may show flicker or streaking. Please adjust the projector if this happens.

Resolution	Mode	Refresh rate (Hz)	H-frequency (kHz)	Clock (MHz)
720 x 400	720x400_85	85.039	37.927	35.500
640 x 480	VGA_60	59.940	31.469	25.175
	VGA_72	72.809	37.861	31.500
	VGA_75	75.000	37.500	31.500
	VGA_85	85.008	43.269	36.000
800 x 600	SVGA_56	56.250	35.156	36.000
	SVGA_60	60.317	37.879	40.000
	SVGA_72	72.188	48.077	50.000
	SVGA_75	75.000	46.875	49.500
	SVGA_85	85.061	53.674	56.250
832 x 624	MAC16"	74.550	49.725	57.283
1024 x 768	XGA_60	60.004	48.363	65.000
	XGA_70	70.069	56.476	75.000
	XGA_75	75.029	60.023	78.750
	XGA_85	84.997	68.667	94.500
	MAC19"	74.700	60.134	79.857
1152 x 864	SXGA1_75	75.000	67.500	108.000
1280 x 960	QuadVGA_60	60.000	60.000	108.000
	QuadVGA_85	85.002	85.938	148.500
1280 x 1024	SXGA3_60	60.020	63.981	108.000
	SXGA3_75	75.025	79.976	135.000
	SXGA3_85	85.024	91.146	157.500
1400 x 1050	SXGA+	59.978	65.317	121.750
1600 x 1200	UXGA_60	60.000	75.000	162.000
	UXGA_65	65.000	81.250	175.500
	UXGA_70	70.000	87.500	189.000
	UXGA_75	75.000	93.750	202.500
	UXGA_85	85.000	106.250	229.500

■ Note

- Signals whose resolution exceeds the native resolution (1024 × 768 pixels) will be compressed. For this reason, some information may be lost, or image quality may be affected.

Specifications (Continued)

■ List of supported signals (Y/P_B/P_R signals)

Signal format	fh(kHz)	fv(Hz)
480i(525i)@60Hz	15.73	59.94
480p(525p)@60Hz	31.47	59.94
576i(625i)@50Hz	15.63	50.00
576p(625p)@50Hz	31.25	50.00
720p(750p)@60Hz	45.00	60.00
720p(750p)@50Hz	37.50	50.00
1080i(1125i)@60Hz	33.75	60.00
1080i(1125i)@50Hz	28.13	50.00

■ List of supported signals (Video, S-Video signals)

Video mode	fh(kHz)	fv(Hz)	fsc(MHz)
NTSC	15.73	60	3.58
PAL	15.63	50	4.43
SECAM	15.63	50	4.25 or 4.41
PAL-M	15.73	60	3.58
PAL-N	15.63	50	3.58
PAL-60	15.73	60	4.43
NTSC4.43	15.73	60	4.43

■ Pin assignment of COMPUTER 1 IN, COMPUTER 2 IN & MONITOR OUT terminals

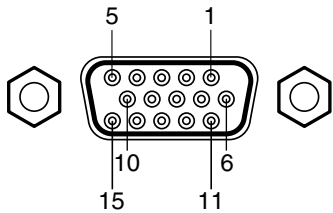

Mini D sub 15 Pin connector

Input Signal

- RGB input
RGB signals: 0.7V (p-p) 75 Ω
Horizontal sync signal: TTL level (Pos/neg polarity)
Vertical sync signal: TTL level (Pos/neg polarity)
- Y/P_B/P_R input
Y signal: 1.0V (p-p) 75 Ω
P_B/P_R signals: 0.7V (p-p) 75 Ω

Pin No.	Pin description	
	During RGB input	During Y/P _B /P _R input
1	Video signal (R)	Color difference signal (P _R)
2	Video signal (G)	Luminance signal (Y)
3	Video signal (B)	Color difference signal (P _B)
4	GND	*
5	GND	*
6	GND (R)	GND (P _R)
7	GND (G)	GND (Y)
8	GND (B)	GND (P _B)
9	N.C	*
10	GND	*
11	GND	*
12	N.C	*
13	Horizontal sync signal	*
14	Vertical sync signal	*
15	N.C	*

* Do not connect anything.

■ CONTROL terminal

● Pin assignment

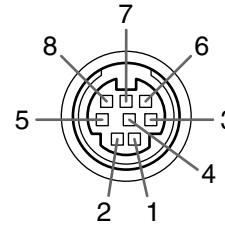

Mini DIN 8 pin connector

Pin No.	Signal Name	Description
1	RXD	Receiving data
2	CTS	Consent to send
3	DSR	Data set ready
4	GND	Signal ground
5	RTS	Request to send
6	N.C	No connection
7	TXD	Sending data
8	GND	Signal ground

● Interface format

- 1 Communication method RS-232C, 9600bps, No Parity, Data Length: 8 bits; Stop Bit Length: 1 bit
- 2 Communication format STX (02h) | Command (3Byte) | ETX (03h)
Only 1 command valid per communication.
- 3 Data format For input commands, only ASCII-compliant all-uppercase alphanumeric characters supported.
- 4 Replies Acknowledge ACK (06h) | CR (0Dh) | Data ... Normally ended
ACK (06h) | ESC (1Bh) ... Aborted
No acknowledge NAK (15h)

If commands are to be sent consecutively, wait for the response from the projector before sending the next command.

● Main Commands

Item	Command
Power on	PON
Power off	POF
Icon display on	MO0
Icon display off	MO1
Auto setting (RGB input)	PAT
Status display on	DON
Status display off	DOF

■ Note

- Contact your dealer for control cable and other commands.



Discount-Merchant.com (800) 281-8860

THE TRUSTED SOURCE FOR PROJECTOR LAMPS AND ACCESSORIES

TOSHIBA CORPORATION



Disclaimer

This user manual is provided as a free service by FixYourDLP.com. FixYourDLP is in no way responsible for the content of this manual, nor do we guarantee its accuracy. FixYourDLP does not make any claim of copyright and all copyrights remain the property of their respective owners.

About FixYourDLP.com

FixYourDLP.com (<http://www.fixyourdpl.com>) is the World's #1 resource for media product news, reviews, do-it-yourself guides, and manuals.

Informational Blog: <http://www.fixyourdpl.com>

Video Guides: <http://www.fixyourdpl.com/guides>

User Forums: <http://www.fixyourdpl.com/forum>

FixYourDLP's Fight Against Counterfeit Lamps:

<http://www.fixyourdpl.com/counterfeits>

Sponsors:

RecycleYourLamp.org – Free lamp recycling services for used lamps:

<http://www.recycleyourlamp.org>

Lamp Research - The trusted 3rd party lamp research company:

<http://www.lampresearch.com>

Discount-Merchant.com – The worlds largest lamp distributor:

<http://www.discount-merchant.com>



FixYourDLP.com

Sponsored by 