



Disclaimer

This user manual is provided as a free service by FixYourDLP.com. FixYourDLP is in no way responsible for the content of this manual, nor do we guarantee its accuracy. FixYourDLP does not make any claim of copyright and all copyrights remain the property of their respective owners.

About FixYourDLP.com

FixYourDLP.com (<http://www.fixyourdpl.com>) is the World's #1 resource for media product news, reviews, do-it-yourself guides, and manuals.

Informational Blog: <http://www.fixyourdpl.com>

Video Guides: <http://www.fixyourdpl.com/guides>

User Forums: <http://www.fixyourdpl.com/forum>

FixYourDLP's Fight Against Counterfeit Lamps:

<http://www.fixyourdpl.com/counterfeits>

Sponsors:

RecycleYourLamp.org – Free lamp recycling services for used lamps:

<http://www.recycleyourlamp.org>

Lamp Research - The trusted 3rd party lamp research company:

<http://www.lampresearch.com>

Discount-Merchant.com – The worlds largest lamp distributor:

<http://www.discount-merchant.com>



FixYourDLP.com

Sponsored by 

BARCO

BARCO PROJECTION

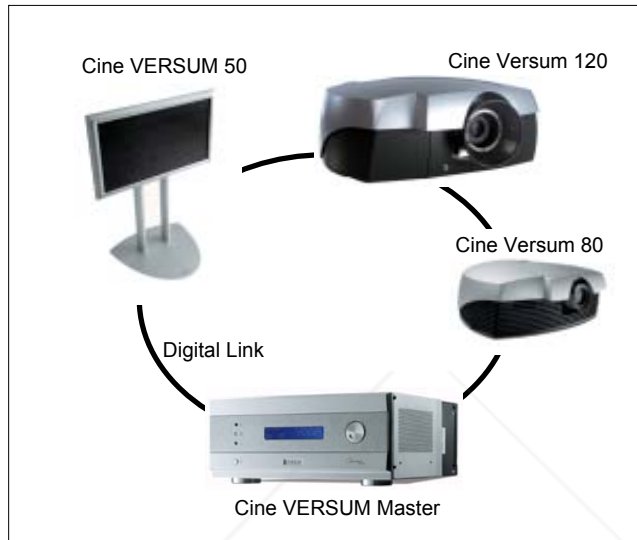

CINE VERSUM SYSTEM

R9841020 Cine VERSUM Master/R9001870/R9005010 - R9001870 Cine VERSUM 80
R9005010 Cine VERSUM 50 - R9010090 Cine VERSUM 120

 FixYourDLP.com
Sponsored by 

Discount-Merchant.com (800) 281-8860
INSTALLATION MANUAL
THE TRUSTED SOURCE FOR PROJECTOR LAMPS AND ACCESSORIES



Discount-Merchant.com (800) 281-8860

Barco nv Home Cinema
Noordlaan 5, B-8520 Kuurne

Phone: +32 56.36.84.30

Fax: +32 56.36.88.62

E-mail: salesassistantht.bci@barco.com

Visit us at the web: www.homecinema.barco.com

THE #1 SOURCE FOR PROJECTOR LAMPS AND ACCESSORIES

Copyright ©

All rights reserved. No part of this document may be copied, reproduced or translated. It shall not otherwise be recorded, transmitted or stored in a retrieval system without the prior written consent of BARCO.

Changes

Barco provides this manual 'as is' without warranty of any kind, either expressed or implied, including but not limited to the implied warranties or merchantability and fitness for a particular purpose. Barco may make improvements and/or changes to the product(s) and/or the program(s) described in this publication at any time without notice.

This publication could contain technical inaccuracies or typographical errors. Changes are periodically made to the information in this publication; these changes are incorporated in new editions of this publication.

Trademarks

Brand and product names mentioned in this manual may be trademarks, registered trademarks or copyrights of their respective holders. All brand and product names mentioned in this manual serve as comments or examples and are not to be understood as advertising for the products or their manufactures.

Federal Communication Commission (FCC Statement)

This equipment has been tested and found to comply with the limits for a class B digital device, pursuant to Part 15 of the FCC rules. These limits are designed to provide reasonable protection against harmful interference when the equipment is operated in a residential environment. This equipment generates, uses, and can radiate radio frequency energy and, if not installed and used in accordance with the instruction manual, may cause harmful interference to radio communications. Operation of this equipment in a residential area is likely to cause harmful interference in which case the user is encouraged to try to correct the interference by one or more of the following measures.

Introduction to the user :

If this equipment does cause interference to radio or television reception, the user may try to correct the interference by one or more of the following measures :

- Re-orientation of the receiving antenna for the radio or television.
- Relocate the equipment with respect to the receiver.
- Plug the equipment into a different outlet so that the equipment and receiver are on different branch circuits.
- Fasten cables connectors to the equipment by mounting screws.



The use of shielded cables is required to comply within the limits of Part 15 of FCC rules and EN55022.

Guarantee and Compensation

Barco provides a guarantee relating to perfect manufacturing as part of the legally stipulated terms of guarantee. On receipt, the purchaser must immediately inspect all delivered goods for damage incurred during transport, as well as for material and manufacturing faults Barco must be informed immediately in writing of any complaints.

The period of guarantee begins on the date of transfer of risks, in the case of special systems and software on the date of commissioning, at latest 30 days after the transfer of risks. In the event of justified notice of complaint, Barco can repair the fault or provide a replacement at its own discretion within an appropriate period. If this measure proves to be impossible or unsuccessful, the purchaser can demand a reduction in the purchase price or cancellation of the contract. All other claims, in particular those relating to compensation for direct or indirect damage, and also damage attributed to the operation of software as well as to other services provided by Barco, being a component of the system or independent service, will be deemed invalid provided the damage is not proven to be attributed to the absence of properties guaranteed in writing or due to the intent or gross negligence or part of Barco.

If the purchaser or a third party carries out modifications or repairs on goods delivered by Barco, or if the goods are handled incorrectly, in particular if the systems are commissioned operated incorrectly or if, after the transfer of risks, the goods are subject to influences not agreed upon in the contract, all guarantee claims of the purchaser will be rendered invalid. Not included in the guarantee coverage are system failures which are attributed to programs or special electronic circuitry provided by the purchaser, e.g. interfaces. Normal wear as well as normal maintenance are not subject to the guarantee provided by Barco either.

The environmental conditions as well as the servicing and maintenance regulations specified in this manual must be complied with by the customer.



Discount-Merchant.com (800) 281-8860
THE TRUSTED SOURCE FOR PROJECTOR LAMPS AND ACCESSORIES

TABLE OF CONTENTS

| | |
|---|-----------|
| 1. Safety Instructions | 5 |
| 1.1 General Safety Instructions | 5 |
| 1.1.1 General Instructions | 5 |
| 1.1.2 Electrical Safety | 6 |
| 1.1.3 Protection on Servicing | 6 |
| 1.1.4 Safety on Cleaning | 7 |
| 1.1.5 Safety on Shipping | 7 |
| 1.2 Display Related Safety Instructions | 7 |
| 1.2.1 Cine VERSUM 50 | 7 |
| 1.2.1.1 On installation site | 7 |
| 1.2.1.2 On product specifications | 8 |
| 1.2.2 Cine VERSUM 80 and Cine VERSUM 120 | 8 |
| 1.2.2.1 Heat and Fire Hazards | 8 |
| 1.2.2.2 Safety on Installation | 9 |
| 1.2.2.3 Protection from High Intensity Light Beam and Ultraviolet Radiation | 9 |
| 2. Cine VERSUM System | 11 |
| 2.1 Digital Video Distribution Concept | 11 |
| 2.2 Digital Video Distribution Parts | 11 |
| 2.2.1 Cine VERSUM Master | 12 |
| 2.2.2 Cine VERSUM 50 | 12 |
| 2.2.3 Cine VERSUM 80 | 13 |
| 2.2.4 Cine VERSUM 120 | 13 |
| 2.2.5 Digital Link | 13 |
| 3. Unpacking | 15 |
| 3.1 Unpacking Cine VERSUM Master | 15 |
| 3.2 Unpacking Cine VERSUM 80 | 16 |
| 3.3 Unpacking Cine VERSUM 120 | 17 |
| 3.4 Unpacking Cine VERSUM 50 | 18 |
| 4. Dimensions | 19 |
| 4.1 Cine VERSUM Master | 19 |
| 4.2 Cine VERSUM 80 | 21 |
| 4.3 Cine VERSUM 120 | 23 |
| 4.4 Cine VERSUM 50 | 24 |
| 5. Location of Controls | 27 |
| 5.1 On Cine VERSUM Master | 27 |
| 5.2 On Cine VERSUM 50 | 27 |
| 5.3 On Cine VERSUM 80 | 28 |
| 5.4 Cine VERSUM 120 | 29 |
| 5.5 On InfraRed Remote Control | 30 |
| 6. Installation Guidelines | 33 |
| 6.1 Projector Installation Guidelines | 33 |
| 6.1.1 General Installation Guidelines | 33 |
| 6.1.2 Image Projection | 34 |
| 6.1.2.1 Cleaning the lens | 34 |
| 6.1.2.2 Image Projection configurations | 34 |
| 6.1.2.3 Projector distance adjustment | 36 |
| 6.1.2.4 Projector installation requirements | 38 |
| 6.1.2.5 Lens Control | 38 |
| 6.1.2.6 Ceiling Mount for Cine VERSUM 80 Cine VERSUM 120 | 40 |
| 6.2 Plasma Screen Installation Guidelines | 41 |
| 6.2.1 About Installation of the Unit | 41 |
| 6.2.2 Installation using the Wall mount kit | 41 |
| 6.2.3 Installation using the Table mount kit | 42 |
| 7. Connections | 45 |
| 7.1 Power Supply Connection | 45 |
| 7.1.1 Supplied Power Cords | 45 |
| 7.1.2 Power Connection Cine VERSUM Master | 45 |
| 7.1.3 Power Connection Cine VERSUM 80 | 46 |
| 7.1.4 Power Connection Cine VERSUM 120 | 47 |
| 7.1.5 Power Connection Cine VERSUM 50 | 47 |
| 7.2 Connection for Preview and Communication | 48 |
| 7.2.1 Connection for Preview Monitors | 48 |
| 7.2.2 Connection for Communication | 49 |
| 7.2.3 Network Connection | 50 |
| 7.3 Digital Link to Display Modules | 51 |
| 7.3.1 Cine VERSUM System Link | 51 |
| 7.3.2 Digital Link to One Display | 52 |

| | |
|---|------------|
| 7.3.3 Digital Link to More Displays (Loop-through)..... | 53 |
| 7.3.4 Digital Link Cable for long distances..... | 54 |
| 7.4 Connection to Video Equipment..... | 55 |
| 7.4.1 Input Connection per Module..... | 56 |
| 7.4.2 Installation of an Input module..... | 58 |
| 8. Operating the Remote Control..... | 61 |
| 8.1 Battery Insertion in the Remote Control..... | 61 |
| 8.2 Operating the Remote Control..... | 62 |
| 8.3 Address setting for the Remote Control..... | 63 |
| 9. Points of Similarity between Graphical display and On Screen Menus..... | 65 |
| 9.1 Explanation about differences in menu displays..... | 65 |
| 10.Overview GUI Menu Screens..... | 69 |
| 10.1Overview Main menu..... | 69 |
| 10.2Overview Image Settings..... | 70 |
| 10.3Overview Advanced Settings..... | 71 |
| 10.4Overview Installation..... | 72 |
| 10.5Overview Service..... | 75 |
| 11.Powering on/off the Cine VERSUM System..... | 77 |
| 11.1Powering ON the Cine VERSUM System..... | 77 |
| 11.2Status of the System after powering up..... | 77 |
| 11.3Display Info 'New Display' and 'Lost Display'..... | 78 |
| 12.Image Projection after Powering Up..... | 81 |
| 12.1Image Projection Using the Jog Dial on Cine VERSUM Master..... | 81 |
| 12.2Image Projection Using the Remote Control..... | 81 |
| 12.3Lamp Mode Set Up for Cine VERSUM 120 Only..... | 82 |
| 12.3.1Lamp Mode Set Up Single/Dual (Image Settings menu)..... | 82 |
| 12.3.2Lamp Mode Set Up Economic/Normal (Image Settings menu)..... | 83 |
| 12.3.3Lamp mode/Power set up in Display Settings menu..... | 83 |
| 13.Projection Stop (Standby or Economic Standby mode)..... | 85 |
| 13.1Projection Stop Using the Selection Wheel..... | 85 |
| 13.2Projection Stop Using the Remote Control..... | 86 |
| 13.2.1Direct System Shutdown (standby)..... | 86 |
| 13.2.2System Shutdown (standby) via screen menu..... | 86 |
| 14.Switching linked displays To and Out Standby..... | 89 |
| 14.1Switching by means of the Cine VERSUM Master..... | 89 |
| 14.1.1Switching In/Out Standby using the Jog Dial..... | 89 |
| 14.1.2Switching In/Out Standby using the Remote Control..... | 90 |
| 14.2Direct Switching of the Linked Display..... | 91 |
| 14.2.1Switching a specific display In/Out standby..... | 91 |
| 15.Module Address Read out/Change..... | 93 |
| 15.1Default address of the Modules..... | 93 |
| 15.2Reading out/Changing the stored addresses..... | 93 |
| 15.2.1Reading out the stored address..... | 93 |
| 15.2.2Changing the stored addresses..... | 94 |
| 16.Input Source File Service..... | 97 |
| 16.1About Stored files..... | 97 |
| 16.2Loading a File..... | 97 |
| 16.3Editing a File..... | 99 |
| 16.4File identification..... | 99 |
| 16.5Rename a file..... | 102 |
| 16.6Copy a file..... | 102 |
| 16.7Delete a file..... | 103 |
| 16.8Delete all files..... | 104 |
| 16.9File options..... | 104 |
| 17.Adjusting the Picture..... | 105 |
| 17.1Setup Video and RGB module for the input signal type..... | 105 |
| 17.2Adjusting the Image Orientation..... | 106 |
| 17.3Adjusting the Image Aspect Ratio..... | 107 |
| 17.4Adjusting the Decoding Standard..... | 109 |
| 17.5White Peak Set up..... | 109 |
| 17.6Keystone Correction..... | 110 |
| 17.6.1Setting the Keystone correction: Global or on a File..... | 110 |
| 17.6.2Applying the Keystone correction..... | 111 |
| 17.7Adjusting the Image Shift and Size..... | 112 |
| 17.7.1Adjusting the Image Shift..... | 112 |
| 17.7.2Adjusting the Image Size..... | 113 |
| 17.8Outline the displayed Image (Blanking)..... | 113 |

| | | |
|--------------------|--|------------|
| 17.9 | Alignment of the Input Balance | 114 |
| 17.9.1 | Input Balance Selection | 115 |
| 17.9.2 | Input Balance Adjustment | 116 |
| 17.10 | Phase adjustment for Computer signals | 117 |
| 17.11 | Gamma Correction | 117 |
| 17.12 | Adjusting the Color Temperature | 118 |
| 17.12.1 | Selecting the preset Color Temperature | 119 |
| 17.12.2 | Customizing the Color Temperature | 120 |
| 17.13 | Adjusting the Picture Controls | 122 |
| 17.13.1 | Master Adjustment of the Analog Controls | 123 |
| 17.13.2 | Analog Controls adjustment per Display | 123 |
| 17.13.2.1 | Via Cine VERSUM Master | 124 |
| 17.13.2.2 | Via Display with Remote Control only | 125 |
| 18. | Additional settings Cine VERSUM Master | 127 |
| 18.1 | Output Resolution set up | 127 |
| 18.2 | Display Internal Generated Pattern | 128 |
| 18.3 | Shutdown Automatic when no signal | 129 |
| 18.4 | Source Transition | 130 |
| 18.5 | On Screen Display Configuration | 130 |
| 18.5.1 | About the OSD (Menu, Bar Scale and Message) | 130 |
| 18.5.2 | Status Change of the OSD | 131 |
| 18.5.3 | On Screen Display Position Alignment | 132 |
| 18.6 | On-Screen Display Language | 132 |
| 18.7 | Display Name Change | 133 |
| 19. | Picture in Picture (PIP) | 135 |
| 19.1 | Turning On/Off the Picture in Picture | 135 |
| 19.2 | Selecting Input Source for PIP Window | 135 |
| 19.3 | Configuration of the PIP Window | 136 |
| 20. | Cine VERSUM Master Settings & Info | 139 |
| 20.1 | Service Menu | 139 |
| 20.2 | Cine VERSUM Master Identification | 139 |
| 20.3 | Cine VERSUM Master Password | 140 |
| 20.4 | Cine VERSUM Master Address | 141 |
| 20.4.1 | About the Cine VERSUM Master Address | 141 |
| 20.4.2 | Cine VERSUM Master Address change | 142 |
| 20.4.3 | Selecting the Transmission Speed | 143 |
| 20.4.4 | Selecting the Interface standard (RS232/RS422) | 143 |
| 20.4.5 | RS422 data bus termination | 144 |
| 20.4.6 | Diagnosis | 144 |
| 21. | Maintenance Indicators | 145 |
| 21.1 | Display Information | 145 |
| 21.2 | Display Diagnosis | 147 |
| 21.3 | ColorWheel IndexCine VERSUM 80 | 148 |
| 21.4 | Test Pattern | 149 |
| Index | | 153 |



Discount-Merchant.com (800) 281-8860
THE TRUSTED SOURCE FOR PROJECTOR LAMPS AND ACCESSORIES



Discount-Merchant.com (800) 281-8860
THE TRUSTED SOURCE FOR PROJECTOR LAMPS AND ACCESSORIES

1. SAFETY INSTRUCTIONS

Overview

- General Safety Instructions
- Display Related Safety Instructions

1.1 General Safety Instructions

Overview

- General Instructions
- Electrical Safety
- Protection on Servicing
- Safety on Cleaning
- Safety on Shipping

1.1.1 General Instructions

Scope

This document includes safety considerations of the Cine VERSUM System. Throughout this manual, the term SERVICE PERSONNEL refers to persons having appropriate technical training and experience necessary to be knowledgeable of potential hazards to which they are exposed (including, but not limited to HIGH VOLTAGE ELECTRIC and ELECTRONIC CIRCUITRY and HIGH BRIGHTNESS PROJECTORS) in performing a task, and of measures to minimize the potential risk to themselves or other persons. The term USER and OPERATOR refers to any person other than SERVICE PERSONNEL, AUTHORIZED to operate the installed digital video distribution system.

General safety instructions

- Before operating your digital video distribution system, please read this manual thoroughly, and retain it for future use.
- Installation and preliminary adjustments should be performed by qualified BARCO service personnel or authorized BARCO service dealers.
- All warnings on the system parts and in the documentation manual should be adhered to.
- All instructions for operating and use of this equipment must be followed precisely.
- All local installation codes should be adhered to.

Owner's Record

The part number and serial number are indicated on the registration plate which is located at the rear of the Cine VERSUM 50, at the bottom of the Cine VERSUM Master, Cine VERSUM 80 and Cine VERSUM 120. Record these numbers in the spaces of the table provided below. Refer to them whenever you call upon your BARCO dealer regarding these products.

| Name | Parts Number | Serial Number | Dealer |
|--------------------|--------------|---------------|--------|
| Cine VERSUM Master | | | |
| Cine VERSUM 50 | | | |
| Cine VERSUM 80 | | | |
| Cine VERSUM 120 | | | |

1. Safety Instructions

Shock Hazard



The lightning flash with an arrowhead within a triangle is intended to tell the user that parts inside this product are risk of electrical shock to persons.

The exclamation point within a triangle is intended to tell the user that important operating and/or servicing instructions are included in the technical documentation for this equipment.

Image 1-1

1.1.2 Electrical Safety

Ratings & Grounding

- These products should be operated from an AC power source. Check if the mains voltage and the load matches the product electrical ratings.
- A grounded three-core power cable has to be used. Connect the power cord by inserting it in a grounded electrical outlet, making sure that the cord is properly grounded.
- If you are unable to install the AC Requirements, contact your electrician. Do not defeat the purpose of the grounding.
- Always connect this appliance to an electrically grounded outlet. Never use a ground bypass (cheater) adapter.

General

- Always plug power cord into appliance before plugging into outlet.
- Do not allow anything to rest on the power cord. Do not locate this product where persons will walk on the cord.
- Always unplug appliance from electrical outlet before cleaning and servicing and when not in use. Never yank cord to pull plug from outlet. Grasp plug and pull to disconnect.
- Do not operate appliance with a damaged cord or if the appliance has been dropped or damaged - until it has been examined by a qualified serviceman.
- Position the cord so that it will not be tripped over, pulled, or contact hot surfaces.
- If an extension cord is necessary, a cord with a current rating at least equal to that of the appliance should be used. Cord rated for less amperage than the appliance may overheat.
- Let appliance cool completely before storing. Remove cord from appliance when storing.
- Never push objects of any kind into this product through cabinet slots as they may touch dangerous voltage points or short out parts that could result in a risk of fire or electrical shock.
- Never spill liquid of any kind on the product. Should any liquid or solid object fall into the cabinet, unplug the set and have it checked by qualified service personnel before resuming operations.
- Lightning - For added protection for this video product during a lightning storm, or when it is left unattended and unused for long periods of time, unplug it from the wall outlet. This will prevent damage to the projector due to lightning and AC power-line surges.

1.1.3 Protection on Servicing



Attempts to alter the factory-set internal controls or to change other control settings not specially discussed in this manual can lead to permanent damage to the Projection Unit and cancellation of the warranty.

Servicing

Do not attempt to service the installed modules yourself, as opening or removing covers may expose you to dangerous voltage potential and risk of electric shock! Refer all projector service to a qualified BARCO service center.

Call for service in the following conditions :

- When the power cord or plug is damaged or frayed.
- If liquid has been spilled into the modules.
- If the product has been exposed to rain or water.
- If the product does not operate normally when the operating instructions are followed. Adjust only those controls that are covered by the operating instructions since improper adjustment of the other controls may result in damage and will often require extensive work by a qualified technician to restore the product to normal operation;
- If the product has been dropped or the cabinet has been damaged;
- If the product exhibits a distinct change in performance, indicating a need for service.

Replacement Parts

When replacement parts are required, be sure the service technician has used original BARCO replacement parts or authorized replacement parts which have the same characteristics as the BARCO original part. Unauthorized substitutions may result in degraded performance and reliability, fire, electric shock or other hazards. Unauthorized substitutions may void warranty.

Safety Check

Upon completion of any service or repairs to these modules, ask the service technician to perform safety checks to determine that the modules are in proper operating condition.

Lamp Explosion Hazard



P-VIPR lamps are under high pressure. The lamp must be handled with great care. They may explode if dropped or mishandled. Never try to disassemble the lamp housing.

Lamp disposal:

For disposal of spent lamps, always consult federal, state, local and provincial hazardous waste disposal rules and regulations to ensure proper disposal.

1.1.4 Safety on Cleaning

Cabinet

Unplug this product from the wall outlet before cleaning. Do not use liquid cleaners or aerosol cleaners. Use a damp cloth for cleaning.

To keep the cabinet looking brand-new, periodically clean it with a soft cloth. Stubborn stains may be removed with a cloth lightly dampened with mild detergent solution. Never use strong solvents, such as thinner or benzine, or abrasive cleaners, since these will damage the cabinet.

Optical Performances

To ensure the highest optical performance and resolution, the projection lenses are specially treated with an anti-reflective coating, therefore : AVOID TOUCHING THE LENS FACE. To remove dust on the lens, use a soft dry cloth. Do not use a damp cloth, detergent solution, or thinner. Follow the lens cleaning procedure in the Owners Manual.

1.1.5 Safety on Shipping

Original Shipping package

Save the original shipping packing material; they will come in handy if you ever have to ship one of your installed modules. For maximum protection, repack your set as it was originally packed at the factory.

1.2 Display Related Safety Instructions

1.2.1 Cine VERSUM 50

Overview

- On installation site
- On product specifications

1.2.1.1 On installation site

Transportation

- Any transportation of the unopened unit in its packaging should be done by two or more persons. To avoid injury or damage, do not lift the package by its packing bands.
- When transporting or storing the unit, always position it vertically – NEVER horizontally. Horizontal transportation or storage invalidates the product warranty.
- In transportation or storage of products in original packing, NEVER stack more than three units high. This warning is also indicated on the upper face of the carton.
- For transportation or storage, observe the warnings and instructions on the upper face of the carton.

1. Safety Instructions

Nearby equipment

If air conditioning ducts or lamps, etc. are located near the installation site, the attendant dust, extreme temperatures, humidity, and condensation may become sources of trouble. Please take sufficient steps to avoid this.

Safety locations

Do not install the unit where it may be easily touched or leaned against. Avoid locations subject to high vibrations or severe impacts.

Lightning conditions

- Consider existing lightning and sunlight angles when creating the installation layout. Extremely bright lightning can reduce the visibility and the quality of the displayed image.
- In extremely bright surroundings, adjusting screen intensity may not result in perceptibly brighter images. Keep in mind that extreme intensity settings can reduce system service life.

Installation partially outdoors

The unit is designed for indoor use, and is not suited for open-air use. Installation in locations that are even partially exposed to the elements may lead to malfunctions or breakdown caused by any of the following:

- Water and dust
- Changes in temperature and humidity
- Salt-bearing wind

1.2.1.2 On product specifications

Temperature and humidity conditions

- The installation site should meet the following conditions:
 - Operating temperature: 0 to 40 °C (largely depending on installation conditions)
 - Operating humidity: 20 to 80%
 - Storage temperature: -20 to 60°C
 - Storage humidity: 20 to 90%
 - Operating atmospheric pressure: 800 to 1100kPa
 - Storage atmospheric pressure: 600 to 1500 kPa
- We recommend against installing electronic products such as this unit in locations subject to high humidity. If the unit is to be installed in a location subject to relatively high humidity, observe the following:
 - Failure to install the unit in unacceptable ways may result in non-warranty damages.
 - Make sure the unit is grounded.
 - Do not allow water or other liquid to enter the unit.

Prevent condensation

One of the main sources of problems during winter is 'condensation'. Rapid temperature fluctuations can deposit water vapor inside the unit or on the screen, degrading performance. If condensation occurs, turn the unit off and leave it off for an hour or so. It is also good practice to increase the room temperature gradually.

Burn in of the picture

Avoid static pictures on the plasma screen for more than 15 minutes in order to prevent burn in of the picture on the plasma screen.

Effective remote control distance

This display emits weak infrared radiation. If other products controlled with infrared remote controls are placed nearby, remote control function may be affected. In such case, move them further away from the display or contact BARCO authorized dealer or assistance.

Depending on installation conditions, the range of the unit's own remote control may be reduced by infrared radiation emitted by the screen. The screen's infrared intensity will vary, depending on the image displayed.

1.2.2 Cine VERSUM 80 and Cine VERSUM 120

1.2.2.1 Heat and Fire Hazards

Warning Risk of Fire

Warning Risk of Fire: Do Not Place Flammable or Combustible Materials Near Projector !

BARCO large screen projection products are designed and manufactured to meet the most stringent safety regulations. This projector radiates heat on its external surfaces and from ventilation ducts during normal operation, which is both normal and safe.

Exposing flammable or combustible materials into close proximity of this projector could result in the spontaneous ignition of that material, resulting in a fire. For this reason, it is absolutely necessary to leave an "exclusion zone" around all external surfaces of the projector whereby no flammable or combustible materials are present. The exclusion zone must be not less than 40 cm (16") for all projectors. The exclusion zone on the lens side must be at least 2m. Do not cover the projector or the lens with any material while the projector is in operation. Keep flammable and combustible materials away from the projector at all times. Mount the projector in a well ventilated area away from sources of ignition and out of direct sun light. Never expose the projector to rain or moisture. In the event of fire, use sand, CO₂, or dry powder fire extinguishers; never use water on an electrical fire. Always have service performed on this projector by authorized BARCO service personnel. Always insist on genuine BARCO replacement parts. Never use non-BARCO replacement parts as they may degrade the safety of this projector.

Slots and Openings

Slots and openings in the cabinet and the sides are provided for ventilation; to ensure reliable operation of the projector and to protect it from overheating, these openings must not be blocked or covered. The openings should never be blocked by placing the product too close to walls, or other similar surface. This product should never be placed near or over a radiator or heat register. This projector should not be placed in a built-in installation or enclosure unless proper ventilation is provided.

Projection Room

Projection rooms must be well ventilated or cooled in order to avoid build up of heat around the projector.

1.2.2.2 Safety on Installation

Personal Injury or Property Damage

WARNING: To minimize risks of personal injury or property damage, due electrical shock, fire, energy hazards, mechanical and heat hazards, Ultraviolet an Infrared energy hazards, and/or chemical hazards this equipment must be installed and/or serviced **ONLY** by SERVICE PERSONNEL.

- If the mains switch is not readily accessible, make sure that the plug on the mains cord or the mains outlet is easily accessible, or that a general switch is provided in the installation in order to disconnect the mains from the unit.
- Do not place this projector on an unstable cart, stand, table...etc.
- To prevent risk of fire or electric shock, do not immerse or expose this appliance in water or other liquids.
- To prevent the risk of electric shock, do not disassemble this appliance, but always take it to an authorized, trained service person when service or repair work is required.
- The use of an accessory attachment not recommended by the manufacturer may cause a risk of fire, electric shock, or injury to persons.

Projector Damage

If the Air Filters are not regularly cleaned or replaced, the air flow inside the projector could be disrupted, causing overheating. Overheating may lead to the projector shutting down during operation.

In order to ensure that correct airflow is maintained, and that the projector complies with Electromagnetic Compatibility requirements, it should always be operated with all of it's covers in place.

Ensure that nothing can be spilled on, or dropped inside the projector. If this does happen, switch off and unplug the mains supply immediately. Do not operate the projector again until it has been checked by qualified service personnel.

The projector must always be mounted in a manner which ensures free flow of air into its air inlets and unimpeded evacuation of the hot air exhausted from its cooling system. Heat sensitive materials should not be placed in the path of the exhausted air.

1.2.2.3 Protection from High Intensity Light Beam and Ultraviolet Radiation

WARNING: Do not stare in the high intensity light beam

Do not look directly in the light beam. Due to the high luminance, damage to eye can happen.

Exposure to UV Radiation

The lamp contained in this product is an intense source of light and heat. One component of the light emitted from this lamp is ultraviolet light. Potential eye and skin hazards are present when the lamp is energized due to ultraviolet radiation. Avoid unnecessary exposure. Protect yourself and your employees by making them aware of the hazards and how to protect themselves. Protecting the skin can be accomplished by wearing tightly woven garments and gloves. Protecting the eyes from UV can be accomplished by wearing safety glasses that are designed to provide UV protection. In addition to the UV, the visible light from the lamp is intense and should also be considered when choosing protective eye wear.

Some medications are known to make individuals extra sensitive to UV radiation. The American Conference of Governmental Industrial Hygienists (ACGIH) recommends occupational UV exposure for an 8-hour day to be less than 0.1 microwatts per square centimeters of effective UV radiation. An evaluation of the workplace is advised to assure employees are not exposed to cumulative radiation levels exceeding these government guidelines.



Discount-Merchant.com (800) 281-8860
THE TRUSTED SOURCE FOR PROJECTOR LAMPS AND ACCESSORIES

2. CINE VERSUM SYSTEM

Overview

- Digital Video Distribution Concept
- Digital Video Distribution Parts

2.1 Digital Video Distribution Concept

Structure of the concept

The Cine VERSUM is from a concept of view a true digital video distribution system to which at present a 50" Plasma screen - Cine VERSUM 50 - ,a single chip DLP™ projector based on the HD2 chip - Cine VERSUM 80 - and a 3 chip DLP™ projector - Cine VERSUM 120 - can be connected.

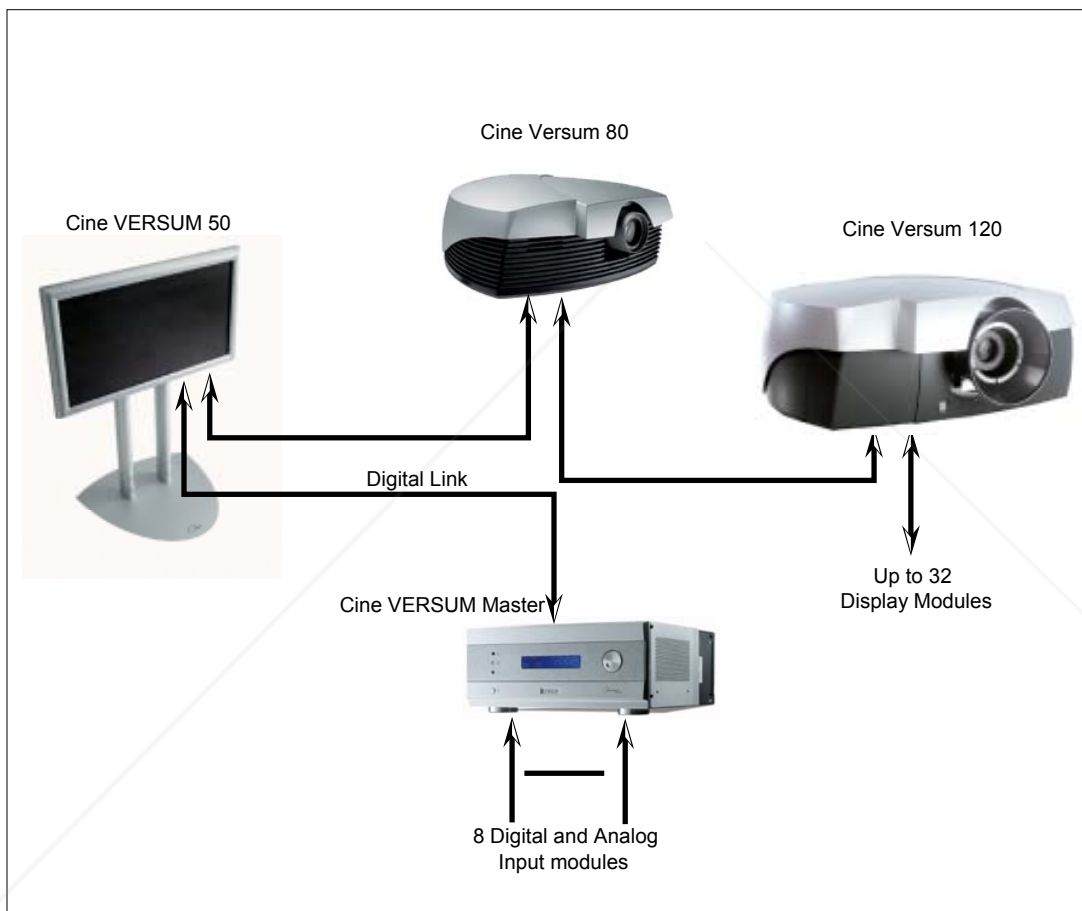

Image 2-1
Structure of the Cine VERSUM Concept



FixYourDLP.com

2.2 Digital Video Distribution Parts

Overview

- Cine VERSUM Master
- Cine VERSUM 50
- Cine VERSUM 80
- Cine VERSUM 120
- Digital Link

Discount-Merchant.com (800) 281-8860
THE TRUSTED SOURCE FOR PROJECTOR LAMPS AND ACCESSORIES

2. Cine VERSUM System

2.2.1 Cine VERSUM Master

General information

The heart of the system is a fully digital video signal switcher/signal processor called Cine VERSUM Master, which is entirely modular. It can be equipped with up to 8 digital and/or analog input modules. Currently developed modules include:

| | |
|-------------------|-------------------------|
| 3 digital inputs: | DVI |
| | SDI |
| | HD-SDI |
| 2 Analog Inputs: | RGB |
| | Video/S-Video/Component |

Another major benefit of the Master is that all input processing –scaling and switching- is done as close as possible to the sources, from then on the entire system is digital, which results in optimum image reproduction at all time.



Image 2-2
Cine VERSUM Master

2.2.2 Cine VERSUM 50

General Information

The Cine VERSUM 50 is a high-resolution 50" plasma display module. This 16:9 display provides superior brightness and incredible contrast, giving a clear, flicker-free display in light intensive environments. The Cine VERSUM 50 ensures a clear color reproduction and all-surpassing color purity. This enables enjoying extremely sharp pictures, without reduction in the blacks. A stylish slim design is intentionally chosen to allow easy integration in almost every home environment. BARCO is convinced that the future-oriented Cine VERSUM 50 concept is what the high demanding and critical customer is looking for. The advantages are numerous, as you will see, giving an answer to all the Home Theater lover's present needs; and those of the future.



Image 2-3
Cine VERSUM 50

2.2.3 Cine VERSUM 80

General Information

Based on the ground-breaking DLP™ 16:9 technology, the Cine VERSUM 80 delivers ultra-high quality color images with contrast ratios of over 1100:1 and a light output of 800 ANSI Lumen. The six-segment color wheel enables a pure color reproduction, reducing or completely eliminating all possible visual artifacts. Thanks to its superior design, noise generation on the Cine VERSUM 80 is virtually non-existent, making it ideal for even the most critical home theater usage.



Image 2-4
Cine VERSUM 80

2.2.4 Cine VERSUM 120

General Information

The extremely powerful Cine VERSUM 120 + Master combination provides the ultimate in home cinema entertainment.

The Cine VERSUM 120 accommodates screen sizes of 90" to 150" diagonal (200 cm to 330 cm wide) and ensures a high quality picture even in brighter environments.

With a wide versatility of lenses, the Cine VERSUM 120 can project out-of-axis both horizontally and vertically, which make the projector ideal for installation in the architecturally most demanding environments.

Combined with the Cine VERSUM Master and its Digital Link, the ultimate Cine VERSUM System accommodates both analog and digital sources, combining extreme picture quality with elegant installation capabilities and future - proof modularity.



Image 2-5
Cine VERSUM 120

2.2.5 Digital Link

General Information

The digital output of the Master is a proprietary Digital Link based on Fibre channel technology that allows transporting uncompressed video pictures in HD resolution over a distance of up to 150' (40m) to the first display device. Several displays can also be interconnected by the digital link by simply daisy chaining them. Presently two cable types have been developed for easy installation:

- The flexible Cine VERSUM SL cable for short distances up to 15 meter maximum. This kind of cable is available in different lengths: 1.5m, 5m and 15m.
- The Cine VERSUM XL rigid cable for longer distances up to 40 meter.

Based on this one of the biggest advantages of the whole VERSUM concept turns out to be to digitally distribute a wide range of video sources through the whole house by use of one single digital cable. This digital link transports uncompressed HD images together with all communication between the Cine VERSUM Master and the different display modules attached to it. As such each display device acts as a remote IR receiver for the Cine VERSUM Master.



Image 2-6
Digital link connectors

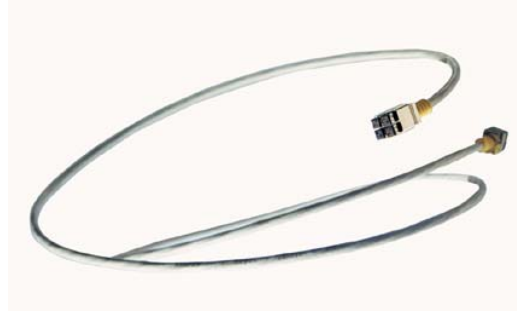

Image 2-7
Digital link cable



Discount-Merchant.com (800) 281-8860
THE TRUSTED SOURCE FOR PROJECTOR LAMPS AND ACCESSORIES

3. UNPACKING

Overview

- Unpacking Cine VERSUM Master
- Unpacking Cine VERSUM 80
- Unpacking Cine VERSUM 120
- Unpacking Cine VERSUM 50

3.1 Unpacking Cine VERSUM Master

How to unpack the Cine VERSUM Master

The original packing material can be reused to solely ship the Cine Versum Master. When doing so, it is important to use the material in the same way as they were originally shipped. Failure to correctly use the material can damage the product.

| Packaging Specifications | Description |
|--------------------------|---------------------------------|
| Dimensions | 570 (W) x 540 (H) x 290 (D) |
| Weight | 16 kgs |

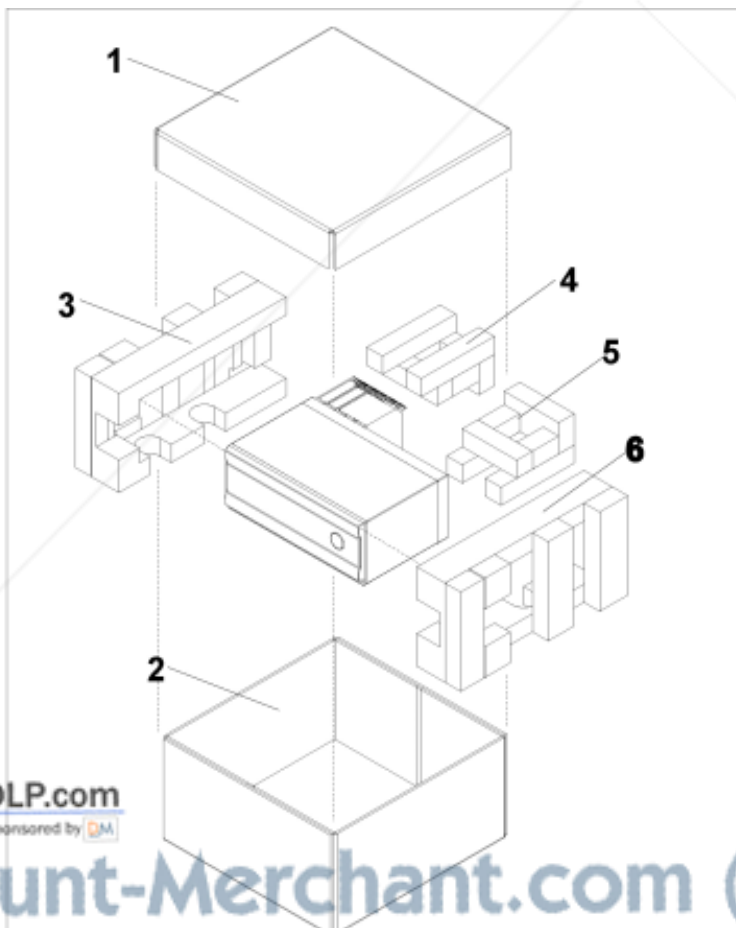

Discount-Merchant.com (800) 281-8860
 THE TRUSTED SOURCE FOR PROJECTOR LAMPS AND ACCESSORIES

3. Unpacking

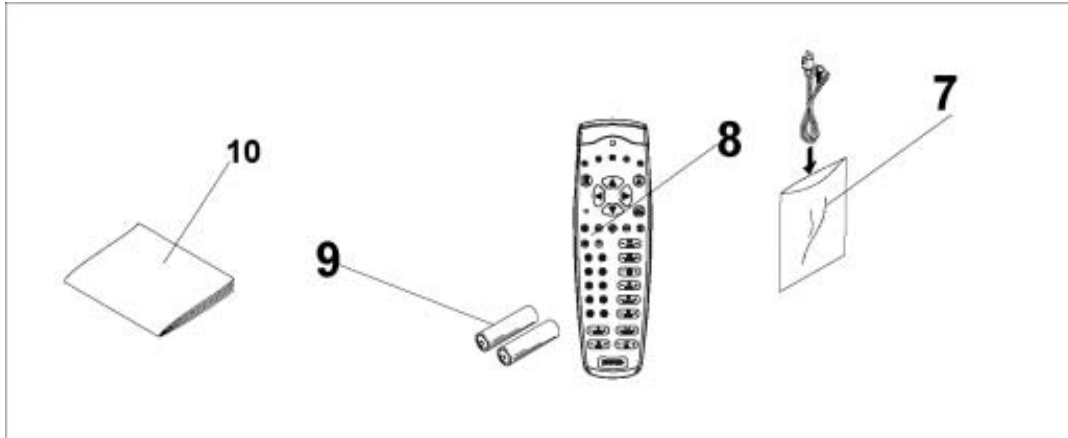

Image 3-2

| Ref. No | Description | Ref. No | Description |
|---------|------------------|---------|-------------------------------|
| 1 | Carton cover top | 6 | Pad |
| 2 | Carton box | 7 | Power cord |
| 3 | Pad | 8 | Remote Control |
| 4 | Pad | 9 | 2 Manganese AA Batteries, R6P |
| 5 | Pad | 10 | Operating Instruction |

3.2 Unpacking Cine VERSUM 80

How to unpack the Cine VERSUM 80

The original packing material can be re-used to solely ship the Cine VERSUM 80. When doing so, it is important to use the material in the same way as they were originally shipped. Failure to correctly use the material can damage the product.

| Packaging Specifications | Description |
|--------------------------|---------------------------------|
| Dimensions | 700 (W) x 640 (H) x 310 (D) |
| Weight | 28 kgs |

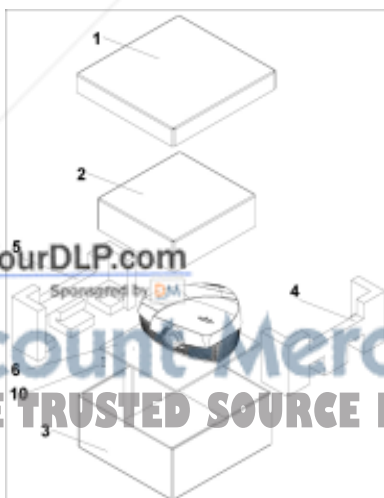

Image 3-3

FixYourDLP.com
 Discount Merchant.com (800) 281-8860
 THE TRUSTED SOURCE FOR PROJECTOR LAMPS AND ACCESSORIES

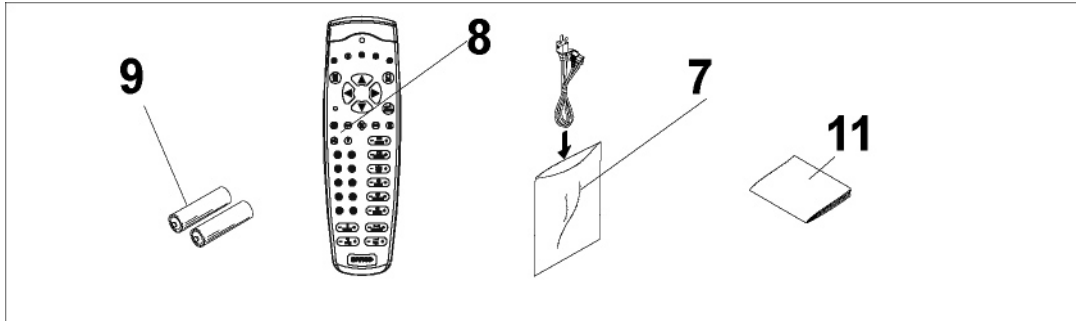

Image 3-4

| Ref. No | Description | Ref. No | Description |
|---------|------------------|---------|-------------------------------|
| 1 | Carton cover top | 7 | Power cord |
| 2 | Inner carton | 8 | Remote control |
| 3 | Carton box | 9 | 2 Manganese AA Batteries, R6P |
| 4 | Pad | 10 | Screw and washer (4 Nos) |
| 5 | Pad | 11 | Operating Instruction |
| 6 | Ply board | | |

3.3 Unpacking Cine VERSUM 120

How to unpack the Cine VERSUM 120

The original packing material can be re-used to solely ship the Cine VERSUM 120. When doing so, it is important to use the material in the same way as they were originally shipped. Failure to correctly use the material can damage the product. Drawings not available at time of printing.

3. Unpacking

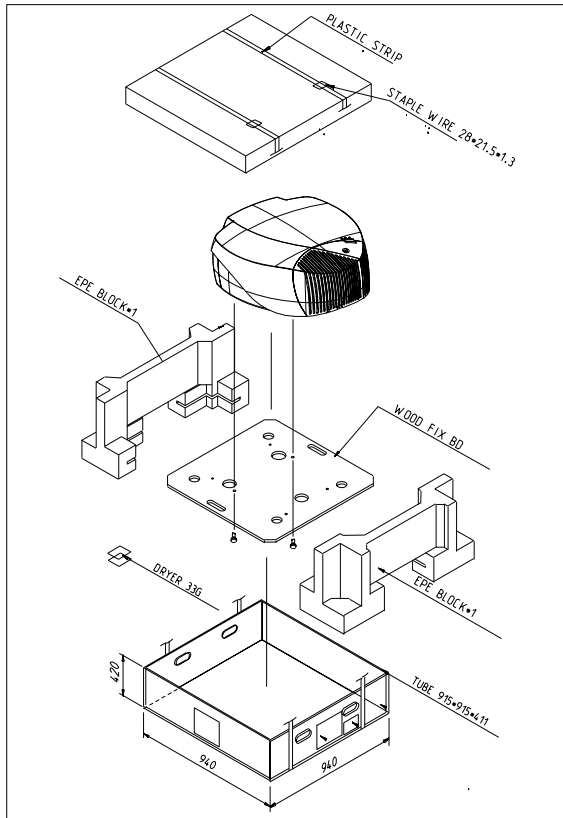

Image 3-5
Unpacking, Repacking the Cine VERSUM 120

3.4 Unpacking Cine VERSUM 50

How to unpack the Cine VERSUM 50

1. Drawing not available at time of printing.

Unpacking material

The original packing material can be re-used to safely ship the Plasma Display. When doing so, it is important to use the material in the same way as when they were originally shipped. Failure to correctly use the material can damage the display.

- Never move the unit by ragging it along the floor.
- Move the unit slowly, taking care to prevent scraping or striking the delicate front protective panel.
- In order to prevent adhesion of dust, remove the protective film only after all work and preparations for the installation site, including clean-up following unpacking, are complete.

Transportation of the unpacked unit

If the unit needs to be moved, the unit should be lifted by two persons.



Discount-Merchant.com (800) 281-8860
THE TRUSTED SOURCE FOR PROJECTOR LAMPS AND ACCESSORIES

4. DIMENSIONS

Overview

- Cine VERSUM Master
- Cine VERSUM 80
- Cine VERSUM 120
- Cine VERSUM 50

4.1 Cine VERSUM Master

Outside dimensions

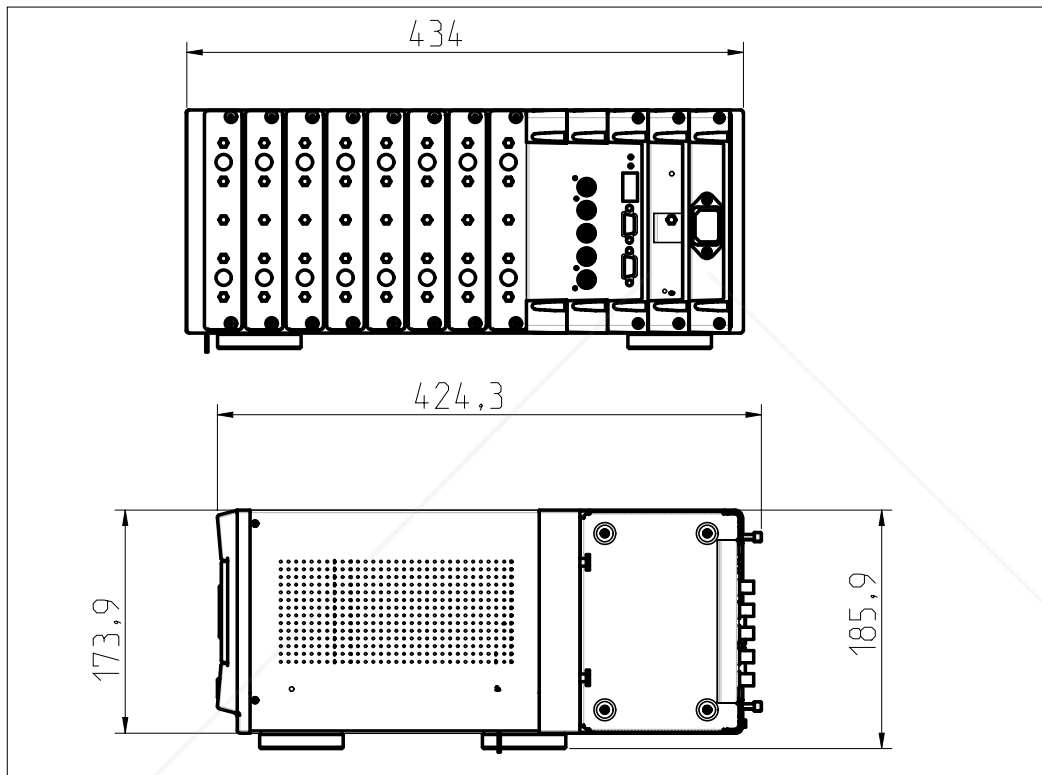

Image 4-1
Outside dimensions Cine VERSUM Master in mm

4. Dimensions

Top/Bottom side dimensions

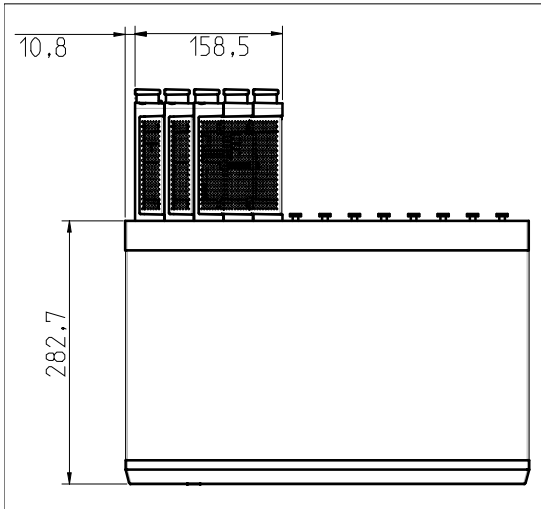

Image 4-2
Top side dimensions in mm

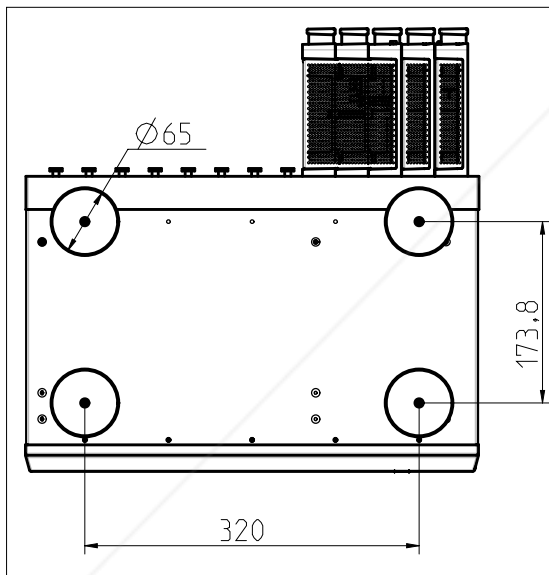

Image 4-3
Bottom side dimensions in mm

Air In-/Outlet for Master cooling

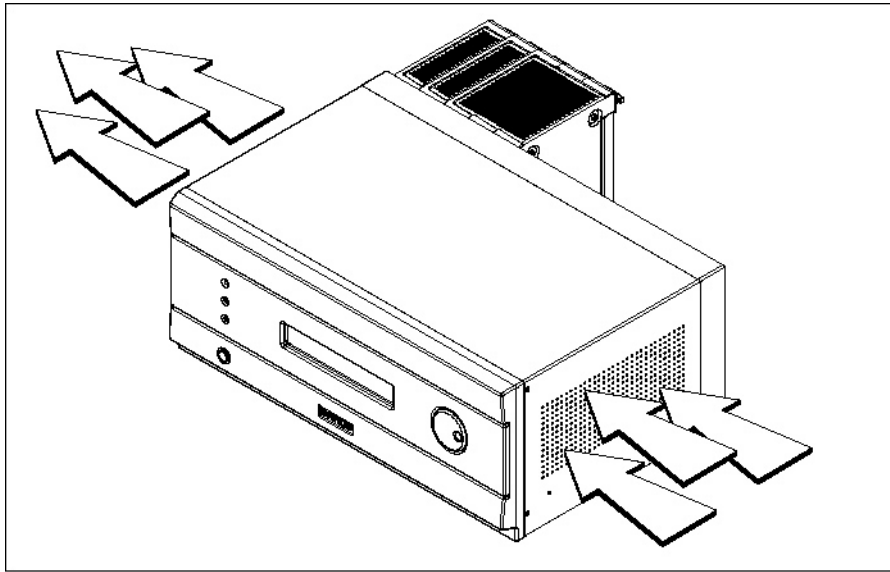

Image 4-4
Air In-/Outlet Cine VERSUM Master

4.2 Cine VERSUM 80

Outside dimensions

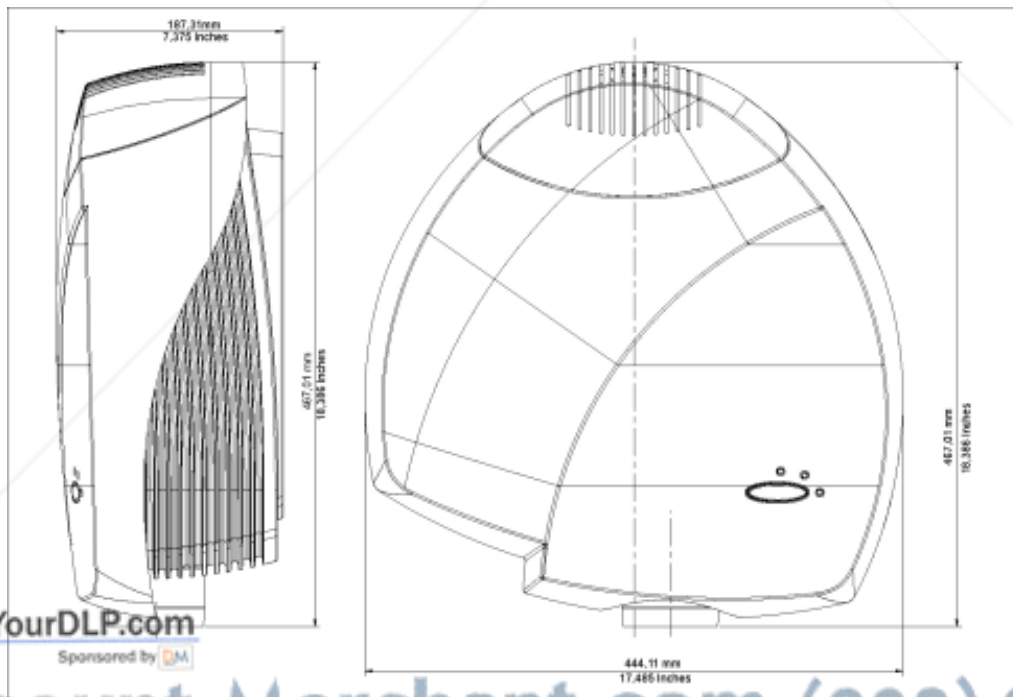

Image 4-5
Outside dimensions Cine VERSUM 80 in mm

FixYourDLP.com
Sponsored by DM
Discount-Merchant.com (800) 281-8860
THE TRUSTED SOURCE FOR PROJECTOR LAMPS AND ACCESSORIES

4. Dimensions

Bottom side dimensions

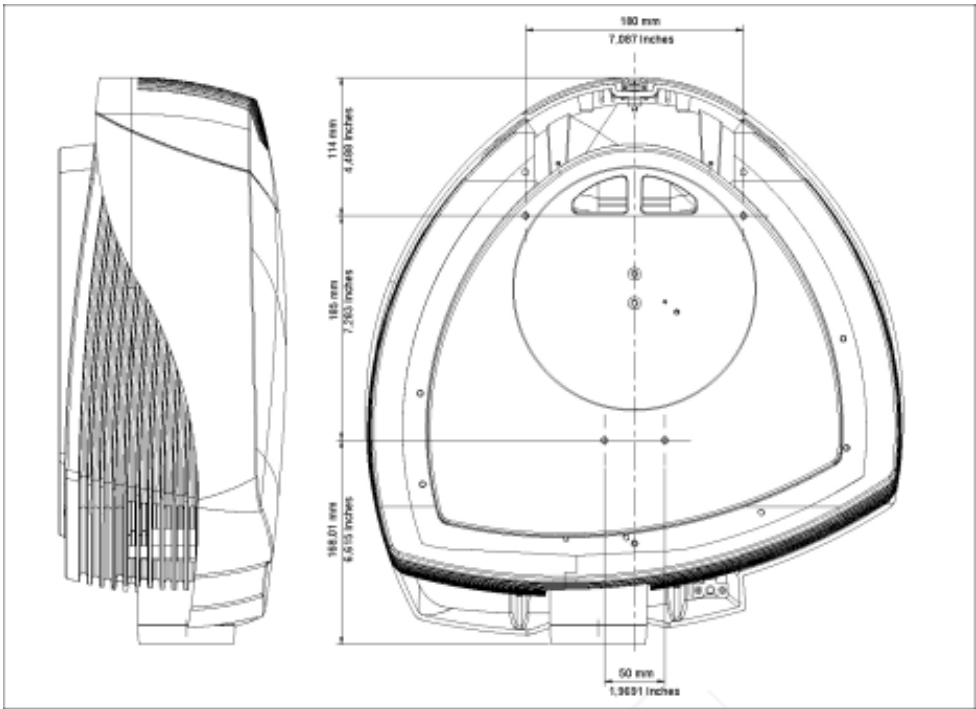

Image 4-6
Bottom side dimensions in mm

Air In-/Outlet for projector cooling

In order to ensure proper projector cooling, do not block the provided air In- and Outlets of the projector.

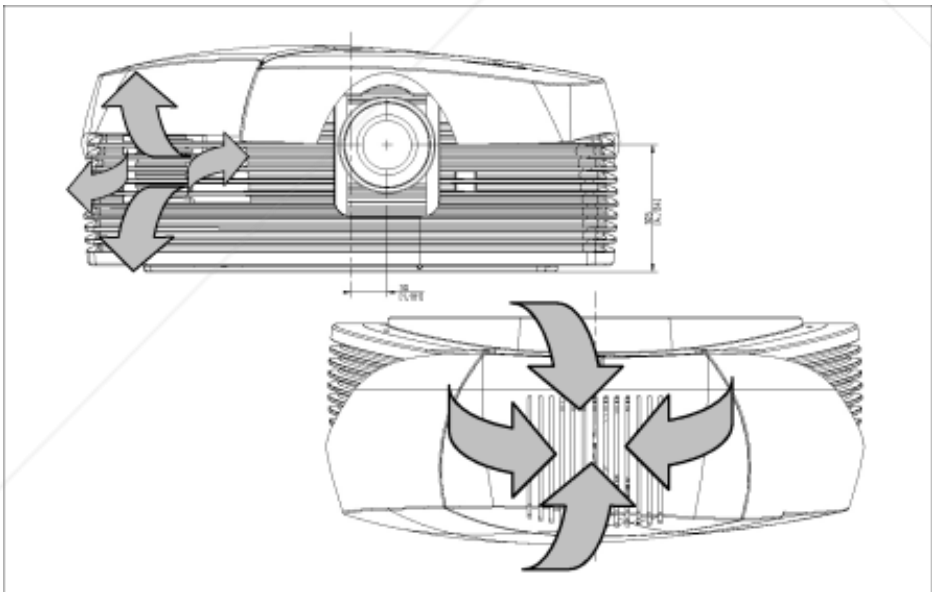

Image 4-7
Air In-/Outlet for projector cooling



FixYourDLR.com

Sponsored by DM

Discount-Merchant.com (800) 281-8860
THE TRUSTED SOURCE FOR PROJECTOR LAMPS AND ACCESSORIES

4.3 Cine VERSUM 120

Outside dimensions

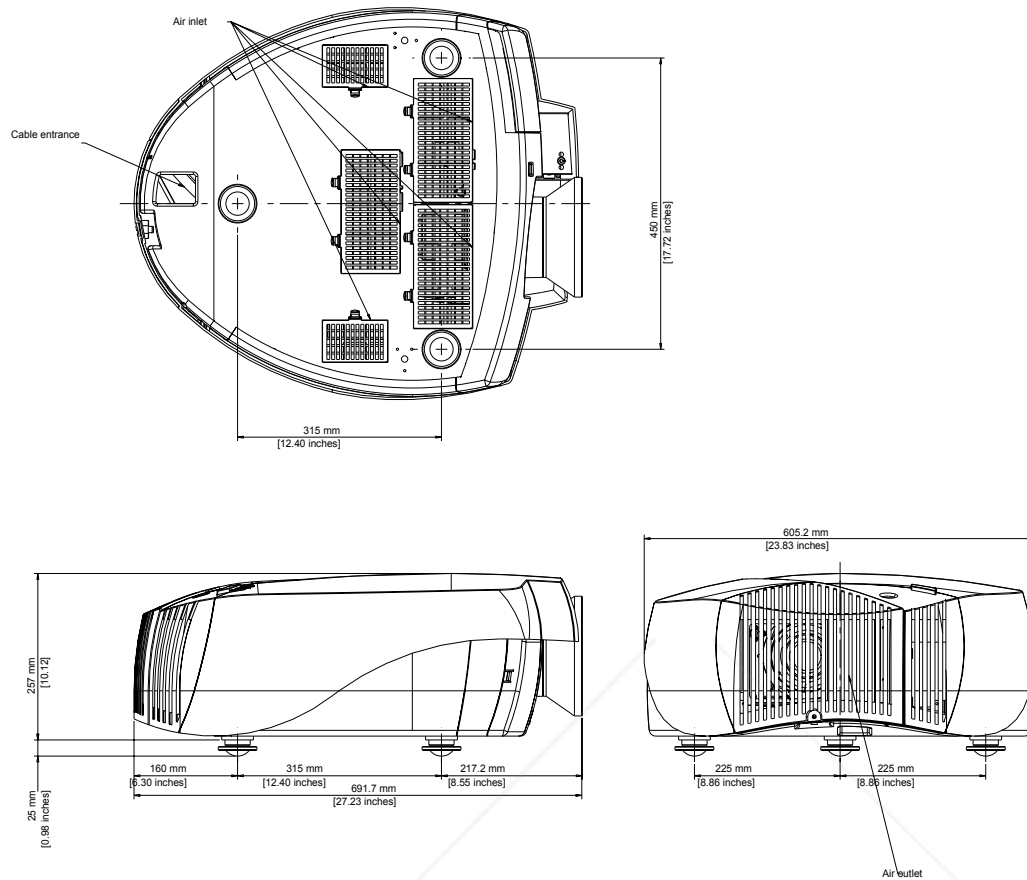
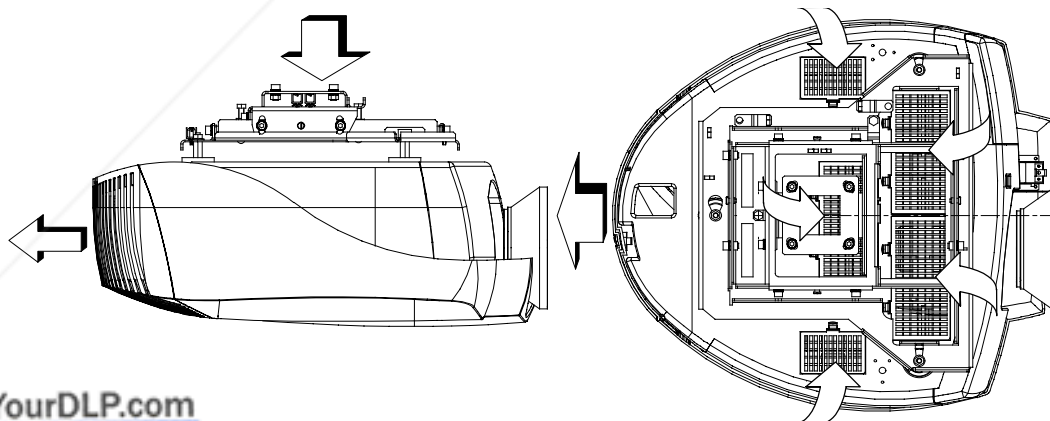

Image 4-8
Outside dimensions Cine VERSUM 120

Air In-/Outlet for projector cooling

In order to ensure proper projector cooling, do not block the provided air In- and Outlets of the projector.



 **FixYourDLP.com**
Image 4-9 sponsored by DM
Air In-/Outlet for projector cooling

Discount-Merchant.com (800) 281-8860
THE TRUSTED SOURCE FOR PROJECTOR LAMPS AND ACCESSORIES

4. Dimensions

4.4 Cine VERSUM 50

Front side dimensions

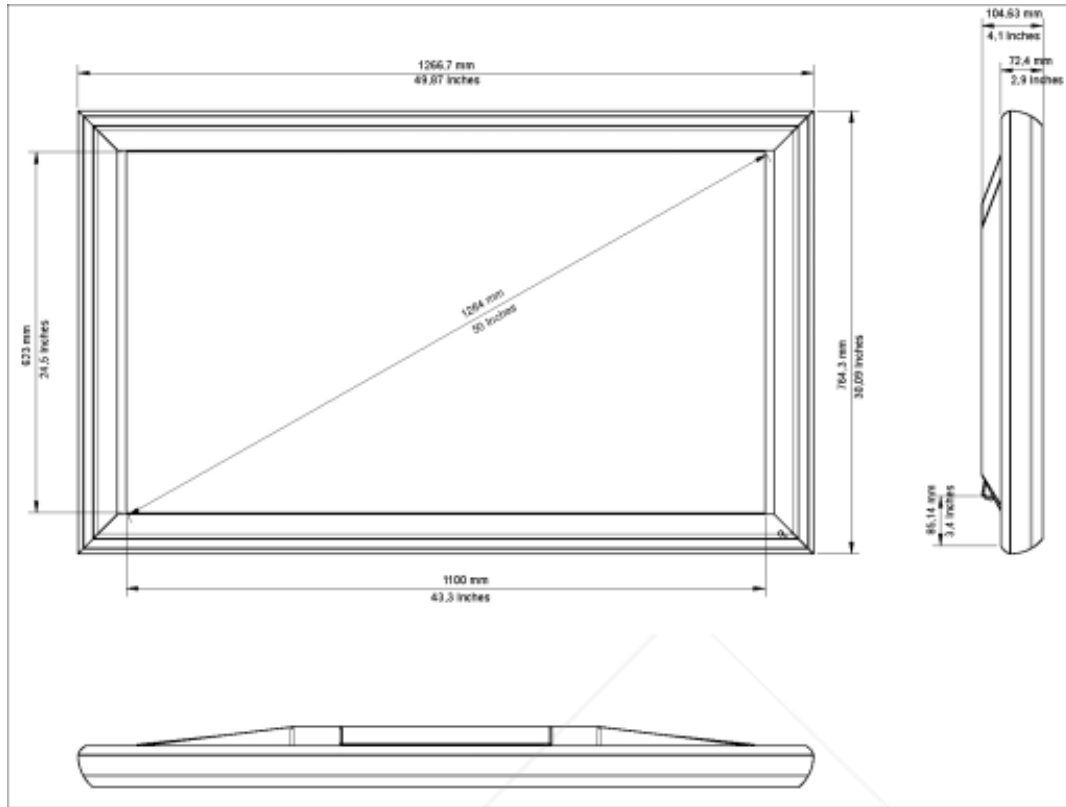

Image 4-10
Front side dimensions in mm

Rear side dimensions

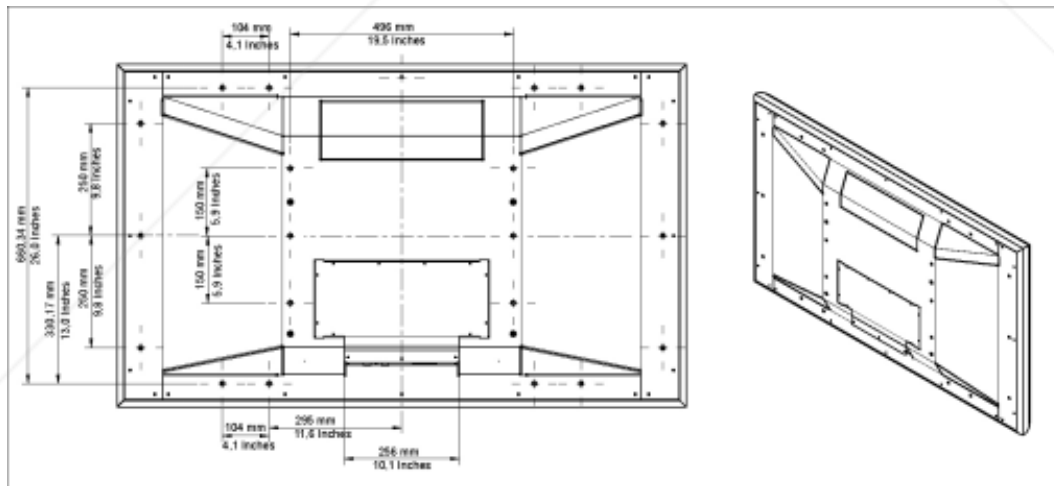

Image 4-11
Rear side dimensions in mm

Air In-/Outlet for Plasma cooling

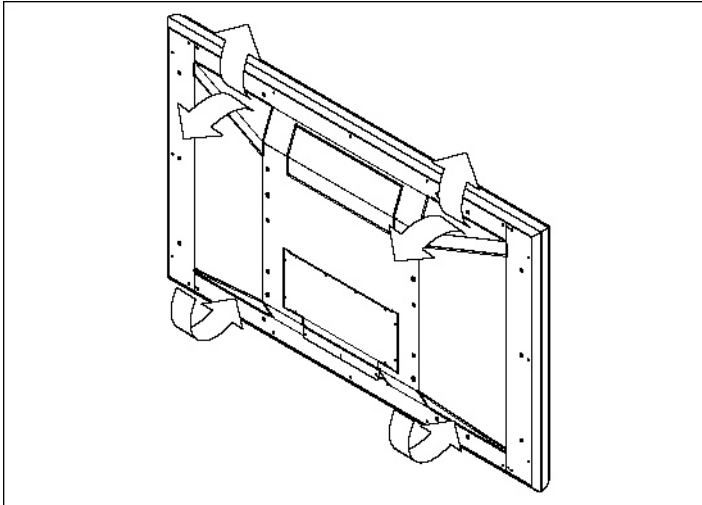

Image 4-12
Air In-/Outlet Cine VERSUM 50



Discount-Merchant.com (800) 281-8860
THE TRUSTED SOURCE FOR PROJECTOR LAMPS AND ACCESSORIES



Discount-Merchant.com (800) 281-8860
THE TRUSTED SOURCE FOR PROJECTOR LAMPS AND ACCESSORIES

5. LOCATION OF CONTROLS

Overview

- On Cine VERSUM Master
- On Cine VERSUM 50
- On Cine VERSUM 80
- Cine VERSUM 120
- On InfraRed Remote Control

5.1 On Cine VERSUM Master

Front View

The front side of the Cine VERSUM Master is provided with the following controls:



Image 5-1
Front side Cine VERSUM Master

Controls function description

| Ref. | Function | Description |
|------|---|--|
| 1 | Infra Red Reception LED indicator | Lights up when a valid IR signal from the Remote Control has been captured. |
| 2 | Infra Red Receiver | Infra Red reception diode for the IR signals from the IR transmitter |
| 3 | Standby LED | Blinks when the Cine VERSUM Master has been powered down to Standby or Economic Standby mode. |
| 4 | Push key main power switch | key pressed, switches the Cine VERSUM Master in: <ul style="list-style-type: none"> • the 'powered up' mode if the latest Master status was 'Operation mode'. • the 'standby' mode if the latest Master status was 'standby' or 'Economic standby' mode. |
| 5 | Blue Dot Matrix display with white LED backlighting | This display indicates the status of the Cine VERSUM Master and also the items when navigating through the different menu's. |
| 6 | Start up and Random access adjustment mode selection knob | All source parameters and picture tuning are setup in the adjustment mode. |

Table 5-1

5.2 On Cine VERSUM 50

Rear and Front view

The only hardware control on the Cine VERSUM 50 is the Main Power Switch (1), located at the backside of the screen itself. This switch puts the Screen in the OFF, Standby or Operation mode fixed by the previous status. From the Standby position or the operation mode, the Cine VERSUM 50 is controlled by the Cine VERSUM Master.

5. Location of Controls

The status of the Plasma screen is indicated by a blue LED (3), located at the bottom on the right of the screen. In the same corner an IR Sensor (2) is mounted to allow controlling the Cine VERSUM system via the screen.

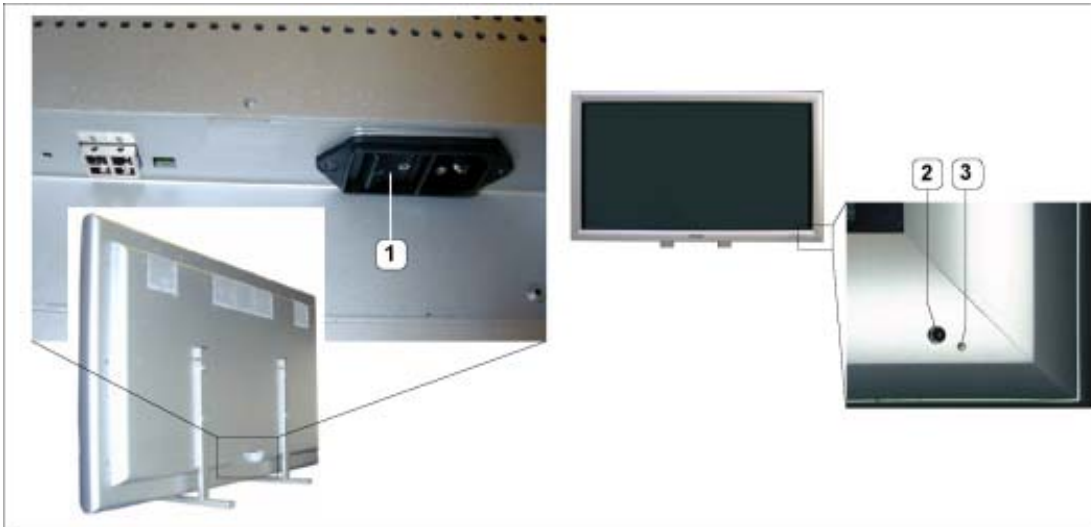

Image 5-2
Cine VERSUM 50 controls

Controls function description

| Ref. | Function | Description |
|------|--------------------|---|
| 1 | Main Power Switch | Switches the Cine VERSUM 50 in the Standby mode or operation mode. In these modes, the Cine VERSUM 50 is controlled by the Cine VERSUM Master or remotely on its own address. |
| 2 | Infra Red Receiver | Infra Red reception diode for the IR signals from the IR transmitter to control the Cine VERSUM System. |
| 3 | Standby LED | Indicates the status of the Cine VERSUM 50, lights up in standby and operation mode. |

Table 5-2

5.3 On Cine VERSUM 80

Top view

The top side of the Cine VERSUM 80 is provided with the following controls:



Image 5-3

Controls function description

| Ref. | Function | Description |
|------|--------------------|---|
| 1 | Infra Red Receiver | Infra Red reception diode for the IR signals from the IR transmitter. Allows switching On/Off (Standby) of the projector separately and controlling the Cine VERSUM System. |

| Ref. | Function | Description |
|------|-----------------------------------|--|
| 2 | Infra Red Reception LED indicator | Lights up when a valid IR signal from the Remote Control has been captured. |
| 3 | Standby LED | Lights up continuously: projector in the operation mode. Repeatedly blinks 2 times successively, followed by a long time Off: projector in the standby mode Blinks fast: projector in the cooling down mode after switching off (duration 1 min.). Lights up repeatedly 1 time long, 1 time short: projector has been started up in the cooling down mode, waiting for lamp ignition. |
| 4 | Push key main power switch | Key pressed, switches the projector, fixed by the previous mode, in the Standby or the Operation mode. |

Table 5-3



If the Standby LED and the IR LED indicator blinks together, FAN fail is detected in the projector.

5.4 Cine VERSUM 120

Top View

The top side of the Cine VERSUM 120 is provided with the following controls:

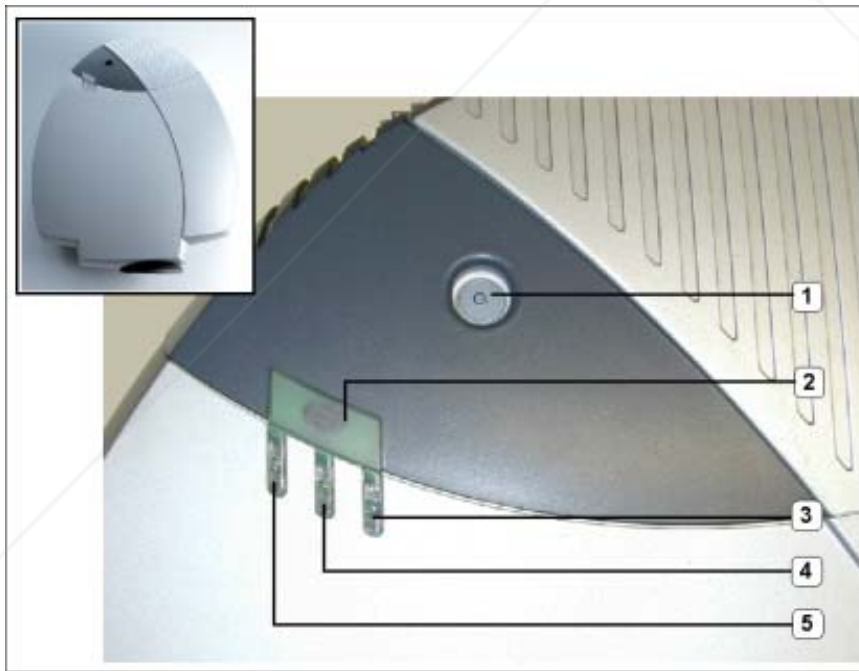

Image 5-1
Cine VERSUM 120 controls

Controls function description

| Ref. | Function | Description |
|------|--------------------|---|
| 1 | Main power switch | Button pressed, switches the projector in the 'Standby' mode. This mode is indicated by the standby LED which lights up repeatedly 2 times short on, 1 time long off. |
| 2 | Infra Red Receiver | Reception diode for the IR signals from the Remote Control. Allows switching On/Off (Standby) of the projector separately and controlling the Cine VERSUM Master. |

5. Location of Controls

| Ref. | Function | Description |
|------|-----------------------------------|---|
| 3 | Standby LED | Lights up continuously: projector in the operation mode. Lights up repeatedly 2 times short on, 1 time long off: projector in the standby mode Blinks fast: projector in the cooling down mode after switching off (duration 1 min.). Lights up repeatedly 1 time long, 1 time short: projector has been started up in the cooling down mode, waiting for lamp ignition. |
| 4 | | Not used |
| 5 | Infra Red Reception LED indicator | Lights up when a valid IR signal from the Remote Control has been captured. |

Table 5-4

5.5 On InfraRed Remote Control

Top side

The InfraRed Remote Control keys support the following functionality:

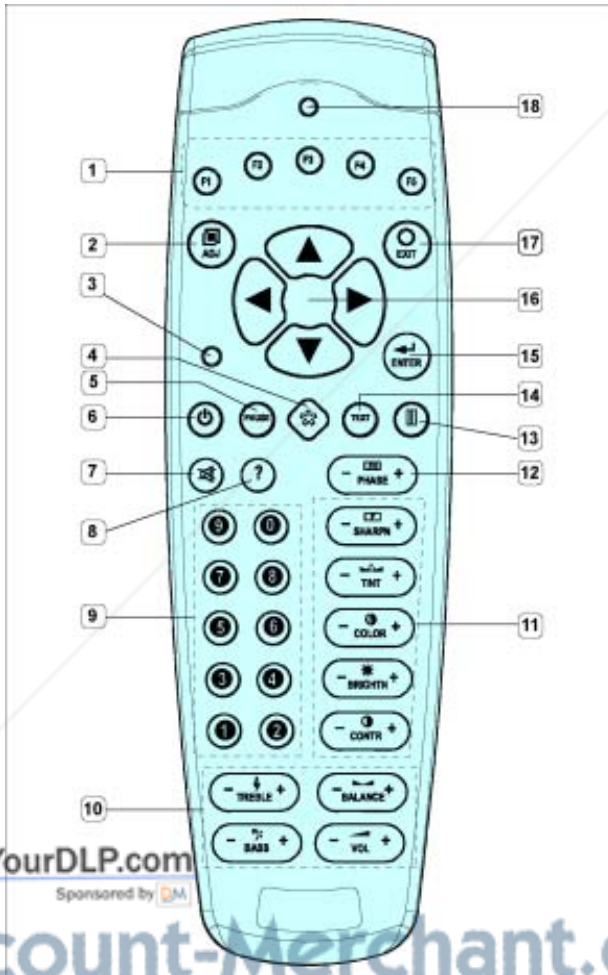

Image 5-5
InfraRed Remote Control

FixYourDLP.com
Sponsored by DM

Discount-Merchant.com (800) 281-8860
THE TRUSTED SOURCE FOR PROJECTOR LAMPS AND ACCESSORIES

Controls function description

| Ref. | Function | Description |
|------|-------------------------|---|
| 1 | Function keys | To position the PIP image in the displayed image. |
| 2 | ADJ (Adjust key) | Toggle key to enter or to exit the adjustment mode. |
| 3 | Address key | To match the address of the RCU with the Cine VERSUM Master (number between 0 and 9). |
| 4 | * key | Selecting the aspect ratio of the displayed image to the source. |
| 5 | PAUSE | To blank the image of the linked displays |
| 6 | Standby key | To power up/down the Cine VERSUM Master and separately the displays in the link. |
| 7 | MUTE | no use |
| 8 | ? | no use |
| 9 | Digit keys | Allow direct input selection and address setting |
| 10 | Audio controls | no use |
| 11 | Picture controls | Allow to optimize the picture reproduction (Attention: Sharpness control function is NOT implemented) |
| 12 | PHASE | Allow to remove image instability |
| 13 | FREEZE | Press to freeze the image |
| 14 | TEXT | Press to remove all on screen display when adjusting picture (Handy when adjusting picture during a meeting). Press key again for reactivation. |
| 15 | ENTER | Press to start the adjustment mode, confirm an adjustment or selection in the adjustment mode. Press again to leave the adjustment mode. |
| 16 | Cursor keys | Allow menu selections in the adjustment mode. |
| 17 | EXIT | Press to leave the adjustment mode via scrolling upwards in the menu structure. |
| 18 | RC operation indication | Lights up when a key on the remote control is pressed (Visual indication of remote control operation – Battery check). |

Table 5-5



Discount-Merchant.com (800) 281-8860
THE TRUSTED SOURCE FOR PROJECTOR LAMPS AND ACCESSORIES

6. INSTALLATION GUIDELINES

Overview

- Projector Installation Guidelines
- Plasma Screen Installation Guidelines

6.1 Projector Installation Guidelines

Overview

- General Installation Guidelines
- Image Projection

6.1.1 General Installation Guidelines



Before installing the projector, read first the safety instructions.

Temperature and humidity conditions

- The installation site should meet the following conditions:
 - Operating temperature: 10 to 35 °C (largely depending on installation conditions)
 - Operating humidity: 0 to 98% RH Non-condensing
 - Storage temperature: -35 to +65°C
 - Storage humidity: 0 to 98% RH Non-condensing
 - Operating atmospheric pressure: 700 to 1100kPa
 - Storage atmospheric pressure: 600 to 1500 hPa
- We recommend against installing electronic products such as this unit in locations subject to high humidity. If the unit is to be installed in a location subject to relatively high humidity, observe the following:
 - Failure to install the unit in unacceptable ways may result in non-warranty damages.
 - Make sure the unit is grounded.
 - Do not allow water or other liquid to enter the unit.

Environment

Do not install the projection system in a site near heat sources such as radiators or hot air ducts, or in a place subject to direct sunlight, excessive dust or humidity. Be aware that room heat rises to the ceiling, prevent that the temperature near the installation site becomes too excessive.

Environment condition check

A projector must always be mounted in a manner which ensures the free flow of clean air into the projectors ventilation inlets. For installations in environments where the projector is subject to airborne contaminants such as cigarette smoke or similar (these deposit a layer of greasy residue upon the projectors internal optics and imaging electronic surfaces, degrading performance), then it is highly advisable and desirable to have this contamination removed prior to it reaching the projectors clean air supply. Devices or structures to extract or shield contaminated air well away from the projector are a prerequisite, if this is not a feasible solution then measures to relocate the projector to a clean air environment should be considered.

Only ever use the manufactures recommended cleaning kit which has been specifically designed for cleaning optical parts, never use industrial strength cleaners on a projectors optics as these will degrade optical coatings and damage sensitive optoelectronics components. Failure to take suitable precautions to protect the projector from the effects of persistent and prolonged air contaminants will culminate in extensive and irreversible ingrained optical damage. At this stage cleaning of the internal optical units will be non-effective and impracticable. Damage of this nature is under no circumstances covered under the manufactures warranty and may deem the warranty null and void. In such a case the client shall be held solely responsible for all costs incurred during any repair. It is the clients responsibility to ensure at all times that the projector is protected from the harmful effects of hostile airborne particles in the environment of the projector. The manufacture reserves the right to refuse repair if a projector has been subject to wilful neglect, abandon or improper use.

Which screen type ?

There are two major categories of screens used for projection equipment. Those used for front projected images and those for rear projection applications.

6. Installation Guidelines

Screens are rated by how much light they reflect (or transmit in the case of rear projection systems) given a determined amount of light projected toward them. The 'GAIN' of a screen is the term used. Front and rear screens are both rated in terms of gain. The gain of screens range from a white matte screen with a gain of 1 (x1) to a brushed aluminized screen with a gain of 10 (x10) or more. The choice between higher and lower gain screens is largely a matter of personal preference and another consideration called the Viewing angle. In considering the type of screen to choose, determine where the viewers will be located and go for the highest gain screen possible. A high gain screen will provide a brighter picture but reduce the viewing angle. For more information about screens, contact your local screen supplier.

What image size? How big should the image be?

The Cine VERSUM 80 is equipped with a Zoom Lens (1.80-2.44:1) designed for projecting images with screen size width of : min 0.60 m (2.36 ft) to max (6.10 m 24.02 ft) (depending on the ambient light conditions), with a default aspect ratio 16 : 9, electronic 4 : 3.

The Cine VERSUM 120 can be combined with a wide versatility of lenses (optional) to project out-of-axis both horizontally and vertically, which make the projector ideal for installation in the architecturally most demanding environment.

6.1.2 Image Projection

Overview

- Cleaning the lens
- Image Projection configurations
- Projector distance adjustment
- Projector installation requirements
- Lens Control
- Ceiling Mount for Cine VERSUM 80 Cine VERSUM 120

6.1.2.1 Cleaning the lens



To minimize the possibility of damaging the optical coating or scratching exposed lens surface, we have developed recommendations for cleaning the lens. **FIRST, we recommend you try to remove any material from the lens by blowing it off with clean, dry deionized air. DO NOT use any liquid to clean the lenses.**

Necessary tools

Toraysee™ cloth (delivered together with the lens kit). Order number : R379058.

How to clean the lens ?

Proceed as follow :

1. Always wipe lenses with a CLEAN Toraysee™ cloth.
2. Always wipe lenses in a single direction.
Warning: Do not wipe back and forwards across the lens surface as this tends to grind dirt into the coating.
3. Do not leave cleaning cloth in either an open room or lab coat pocket, as doing so can contaminate the cloth.
4. If smears occur when cleaning lenses, replace the cloth. Smears are the first indication of a dirty cloth.



Do not use fabric softener when washing the cleaning cloth or softener sheets when drying the cloth.
Do not use liquid cleaners on the cloth as doing so will contaminate the cloth.



Other lenses can also be cleaned safely with this Toraysee™ cloth.



Discount-Merchant.com (800) 281-8860
THE TRUSTED SOURCE FOR PROJECTOR LAMPS AND ACCESSORIES

6.1.2.2 Image Projection configurations



Use the projector's menu system to select the appropriate projection mode for the configurations below.

Front Projection (Ceiling-Table mounted)

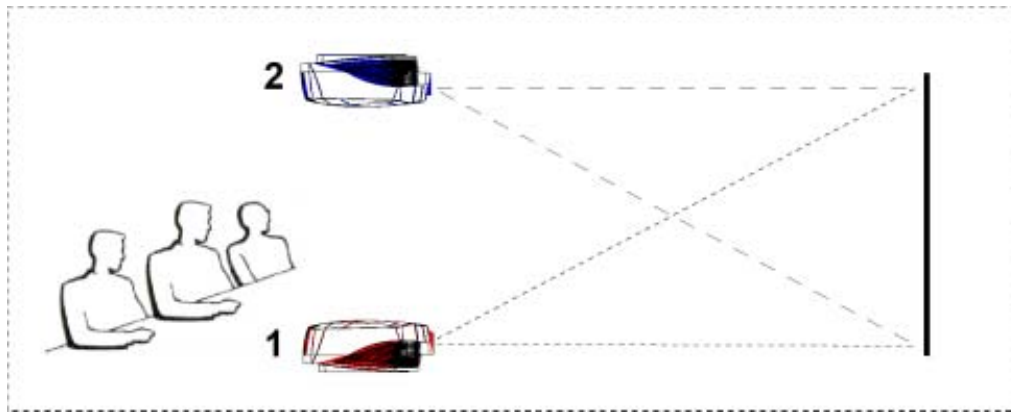

Image 6-1
Front projection

- 1 Table standing
- 2 Ceiling mounted



It is recommended that you use the optional BARCO ceiling-mount bracket to mount the projector to the ceiling.

Projection Using a Mirror

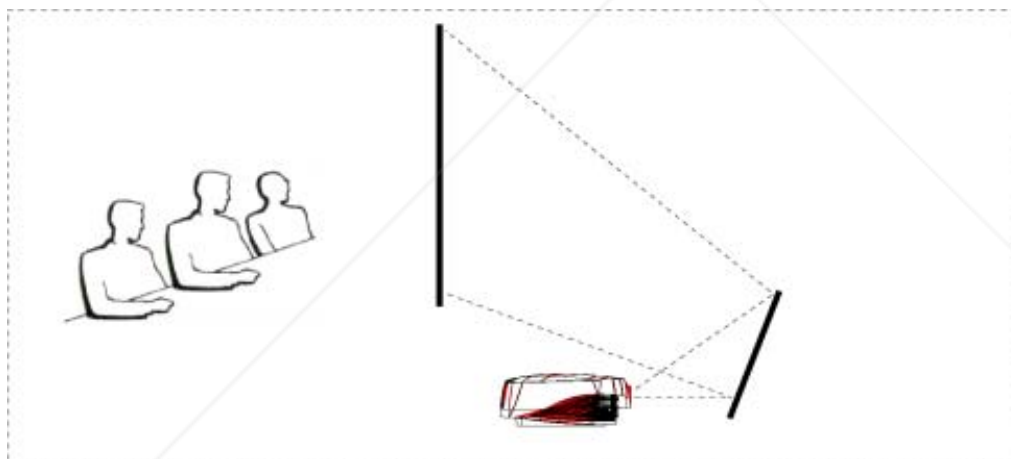

Image 6-2
Rear: Mirror projection

Rear Projection (Ceiling-Table mounted)

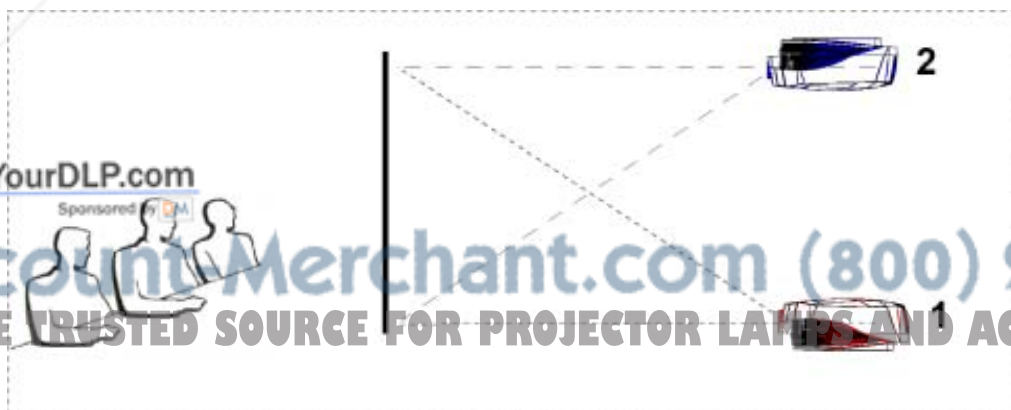

Image 6-3
Rear projection

- 1 Table standing
- 2 Ceiling mounted

FixYourDLP.com
 Sponsored by  DPA
DiscountMerchant.com (800) 281-8860
THE TRUSTED SOURCE FOR PROJECTOR LAMPS AND ACCESSORIES



It is recommended that you use the optional BARCO ceiling-mount bracket to mount the projector to the ceiling.

6.1.2.3 Projector distance adjustment

Cine VERSUM 80: Calculation of the projector distance PD

Place the projector at the required distance from the screen according to the desired screen size. The required distance can be calculated with the formula added to the drawing below.



The formula is based upon projecting an 16:9 image so that it occupies the entire 16:9 screen.

The projector distance PD is measured from lens support (indicated with fingertip in drawing) to screen face.

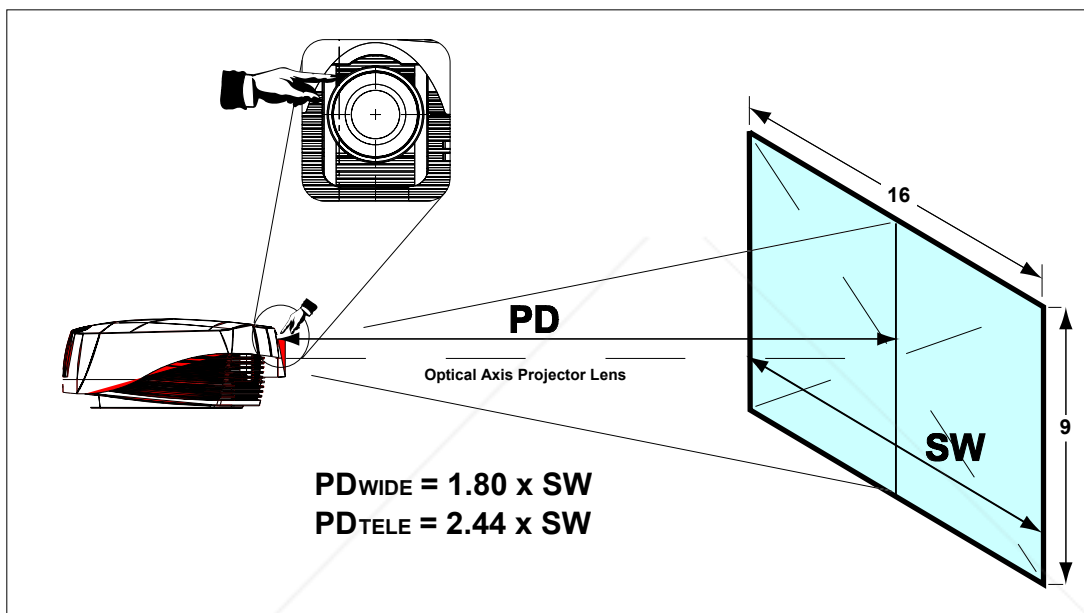

Image 6-4
Calculation of the projector distance (PD)

The maximum and minimum screen width in both Zoom Ranges are:

- Zoom Range WIDE: from 0.8 to 6.0 m
- Zoom Range TELE: from 0.6 to 4.5 m

Cine VERSUM 120: Calculation of the projector distance PD

Place the projector at the required distance from the screen according to the desired screen size. The required distance can be calculated with the formula added to the drawing below.



The formula is based upon projecting an 16:9 image so that it occupies the entire 16:9 screen.

The projector distance PD is measured from front bottom projector housing (indicated with arrow in drawing) to screen face.

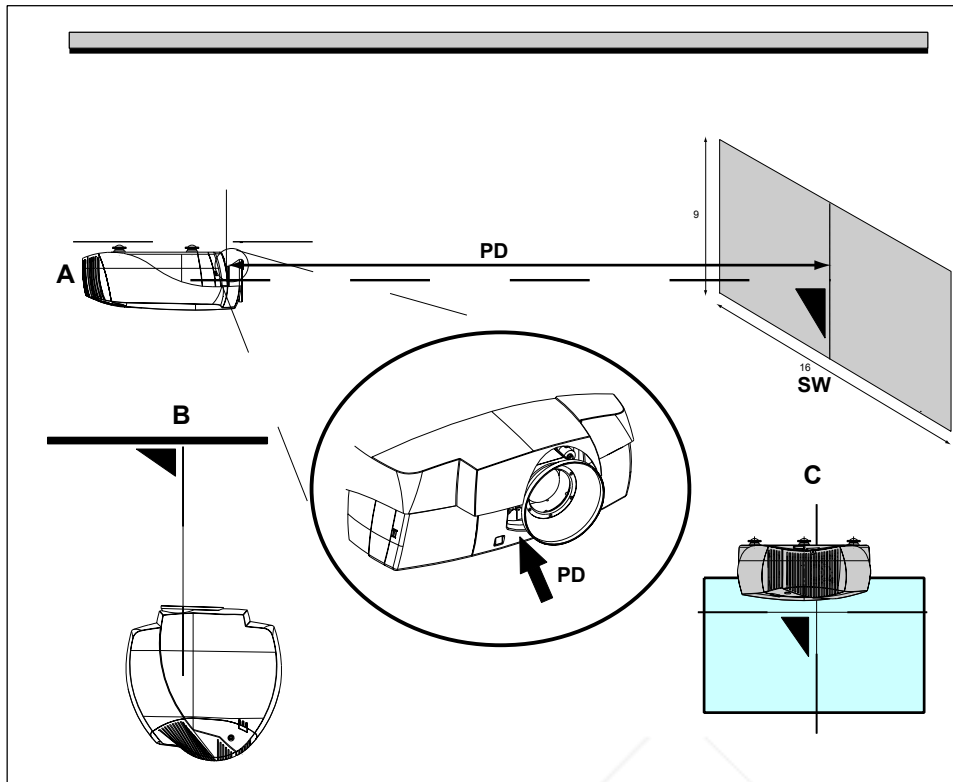

Image 6-5
Calculation of the projector distance (PD)

Below table of the lenses (available at time of printing)

| Lenses | | Metric formulas (meter) | Inch formulas (inch) |
|-----------------------------|------|-------------------------|----------------------|
| CineVERSUM™(1.2 - 1.44 : 1) | Wide | PD = 1.2 x SW | PD = 1.2 x SW |
| | Tele | PD = 1.44 x SW | PD = 1.44 x SW |
| CineVERSUM™(1.44 - 1.8 : 1) | Wide | PD = 1.44 x SW | PD = 1.44 x SW |
| | Tele | PD = 1.88 x SW | PD = 1.88 x SW |
| CineVERSUM™(1.6 - 2.24 : 1) | Wide | PD = 1.6 x SW | PD = 1.6 x SW |
| | Tele | PD = 2.24 x SW | PD = 2.24 x SW |
| CineVERSUM™(2.24 - 4 : 1) | Wide | PD = 2.24 x SW | PD = 2.24 x SW |
| | Tele | PD = 4 x SW | PD = 4 x SW |
| CineVERSUM™(3.6 - 5.6 : 1) | Wide | PD = 3.6 x SW | PD = 3.6 x SW |
| | Tele | PD = 5.6 x SW | PD = 5.6 x SW |
| CineVERSUM™(4 - 6.4 : 1) | Wide | PD = 4 x SW | PD = 4 x SW |
| | Tele | PD = 6.4 x SW | PD = 6.4 x SW |



Discount-Merchant.com (800) 281-8860
THE TRUSTED SOURCE FOR PROJECTOR LAMPS AND ACCESSORIES

6.1.2.4 Projector installation requirements

Cine VERSUM 80: Installation requirements

- Position the projector perpendicular to the screen and leveled to achieve an optimal image. An inclination of the projector is allowed but limited to 10° in one direction (. The latter generates image distortion (keystoned) which can be corrected using the projector's menu system.
- The projector lens should be centered horizontally in the middle of the screen (Vertical shift of the lens built-in).
- Position the screen so that it is not in direct sunlight or room light. Light falling directly onto the screen washes out the colors, making viewing difficult. Close the curtains and dim the lights when setting up the screen in a sunny or bright room.
- A polarizing screen cannot be used with this projector.



The maximum mounting inclination angle for the projector is 10°.

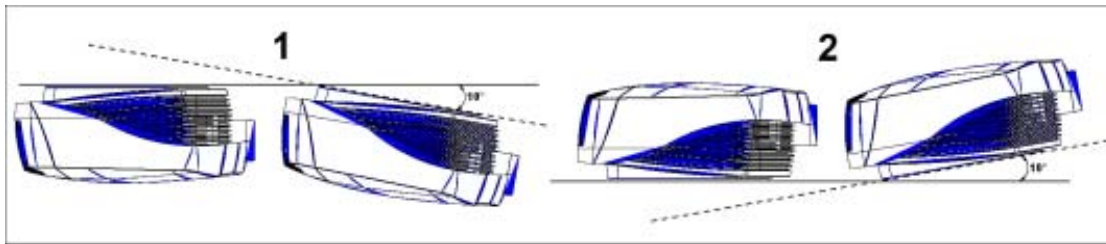

Image 6-6
Projector inclination angle

- 1 Ceiling mounted projector
- 2 Table installed projector

Cine VERSUM 120: Installation requirements

- Position the projector perpendicular to the screen and leveled to achieve an optimal image. An inclination of the projector is allowed but limited due to the maximum keystone correction range.
- A swing of the projector is limited to 10° in both directions (due to the lamp position in the projector).
- The projector lens should be centered horizontally in the middle of the screen (Vertical and Horizontal shift of the lens built-in).
- Position the screen so that it is not in direct sunlight or room light. Light falling directly onto the screen washes out the colors, making viewing difficult. Close the curtains and dim the lights when setting up the screen in a sunny or bright room.
- A polarizing screen cannot be used with this projector.



The maximum mounting swing angle for the projector is 10°.

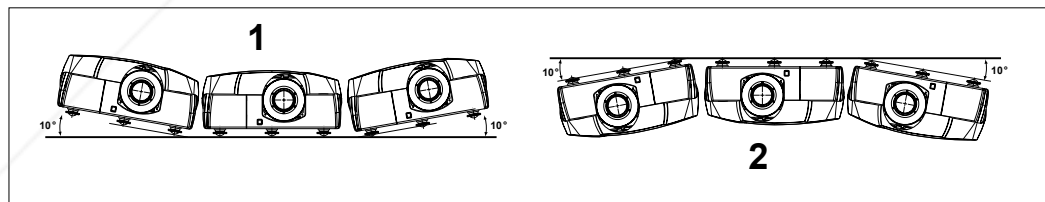

Image 6-7
Projector swing angle

- 1 Table installed projector
- 2 Ceiling mounted projector



Sponsored by DLP

6.1.2.5 Lens Control

Cine VERSUM 80: Using the provided Lens vertical Shift control

The picture can be adjusted vertically within the shift range of the lens by rotation the lens shift screw on top of the projector (below top cover) using a flat screwdriver or by hand to match the setup configuration.

The vertical lens shift range is +100% and -100% with respect to the optical axis of the projection lens (Tilting the projector will reduce the effectiveness of the lens shift function).

When the height of the projected image is adjusted, the image may become distorted (keystoned), depending on the relative positions of the projector and the screen. How to adjust the keystone correction, see "Keystone Correction", page 110.

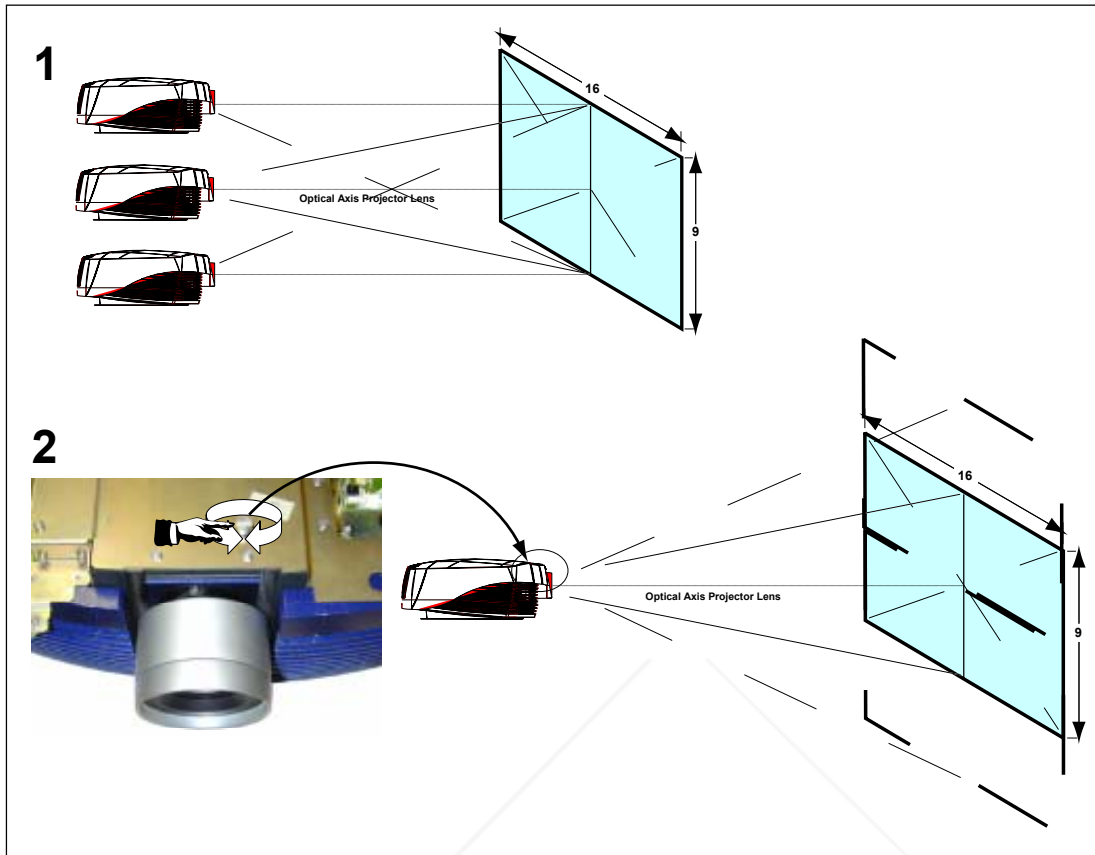

Image 6-8
Lens shift

- 1 Lens shift fixed screen
- 2 Lens shift fixed projector

Cine VERSUM 120: using the provided Lens Controls

The Cine VERSUM 120 is equipped with a zoom lens which is remote controlled. The following controls are provided:

- Lens FOCUS alignment
- Lens ZOOM alignment
- Lens HORIZONTAL SHIFT alignment
- Lens VERTICAL SHIFT alignment

Picture below shows a running through the menus to access to the lens controls (For details, see owners manual of the Cine VERSUM 120):

Main Menu/Installation/Display list/CV120/Lens

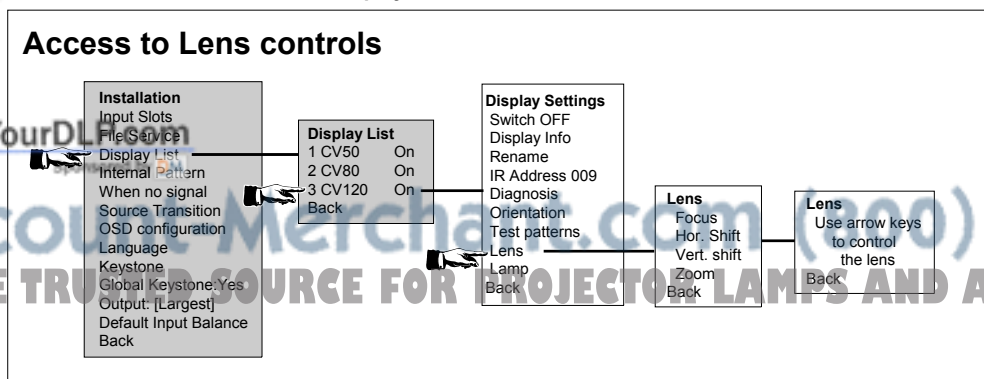

Image 6-9
Access to lens controls

6.1.2.6 Ceiling Mount for Cine VERSUM 80 Cine VERSUM 120

View Ceiling Mount assembly

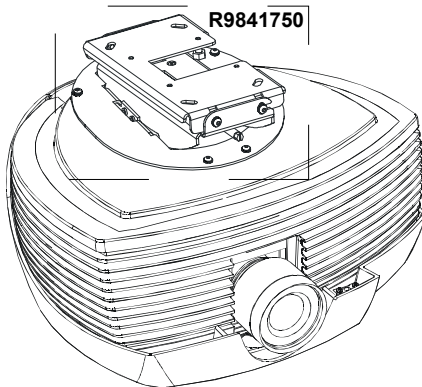

Image 6-10
Ceiling mount for Cine VERSUM 80

For more details about the ceiling mount Cine VERSUM 80, see the concerning installation manual.

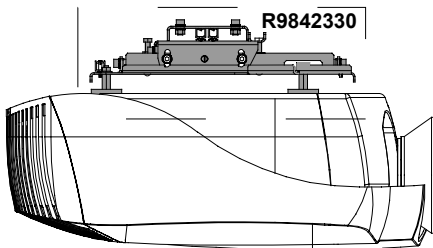

Image 6-11
Ceiling mount for Cine VERSUM 120

For more details about the ceiling mount Cine VERSUM 120, see the concerning installation manual.

Ceiling Mount Extension Supports for Cine VERSUM 80 and Cine VERSUM 120

Two extension supports are available and are common for both projectors.

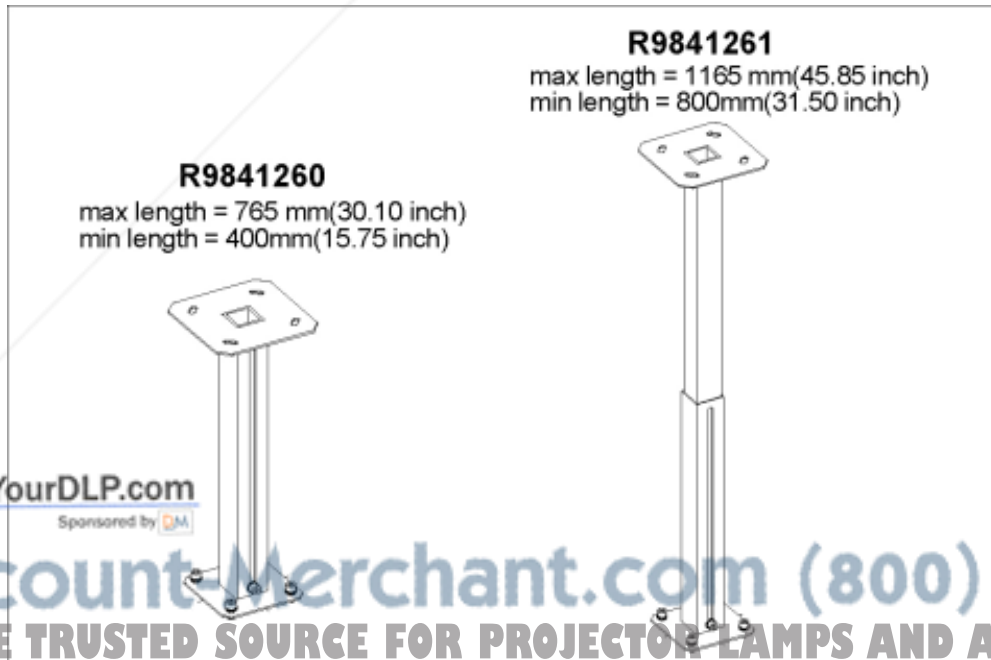

Image 6-12
Extension supports for ceiling mount assembly

For more details about the ceiling mount extension support, see the concerning installation manual.

6.2 Plasma Screen Installation Guidelines

Overview

- About Installation of the Unit
- Installation using the Wall mount kit
- Installation using the Table mount kit

6.2.1 About Installation of the Unit



To avoid malfunction, overheating of this unit, and possible fire hazard, make sure that the vents on the main unit are not blocked when installing. Also hot air is expelled from the air vents, be careful of deterioration and dirt build up on rear surface wall, etc..



Please be sure to use an M8 (Pitch=1.25mm) bolt. (Only this size bolt can be used.)



Because this unit weights about 40 kg and the lack of depth makes it fairly unstable, please use 2 people or more when packing, carrying or installing.



This unit incorporates a thin design. To ensure safety if vibrated or shaken, please be sure to take measures to prevent the unit from tipping over.

Way of installing the unit

Two kits are designed by BARCO for the installation of the unit, a Wall and a Table mount kit.

6.2.2 Installation using the Wall mount kit

How to install the Wall mount kit

1. Be sure to attach in 4 or more locations above and below, left and right of the center line.
2. Use bolts that are long enough to be inserted 12 mm to 18 mm into the main unit from the attaching surfaces for both 'a' holes and 'b' holes. Refer to the side view diagram below.
3. As this unit is constructed with glass, be sure to install it on a flat, not warped surface. (image 6-13, image 6-14, image 6-15)

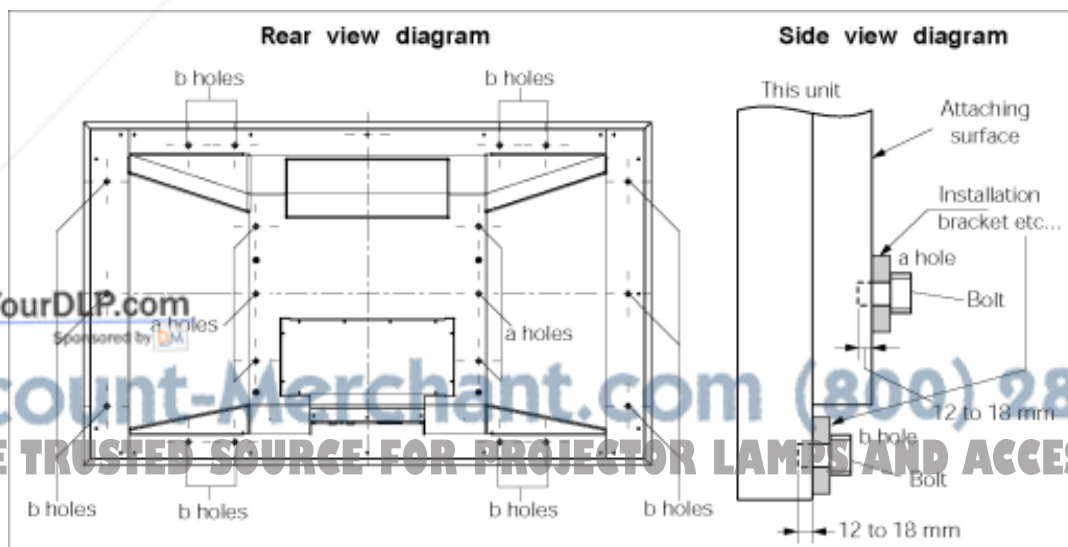

Image 6-13
Mounting holes

6. Installation Guidelines

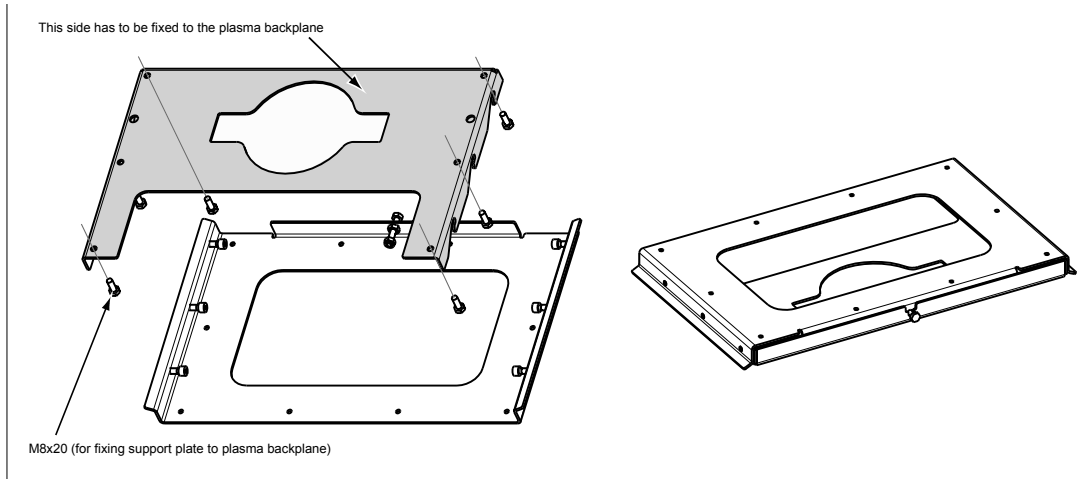

Image 6-14
Wall mount assembly

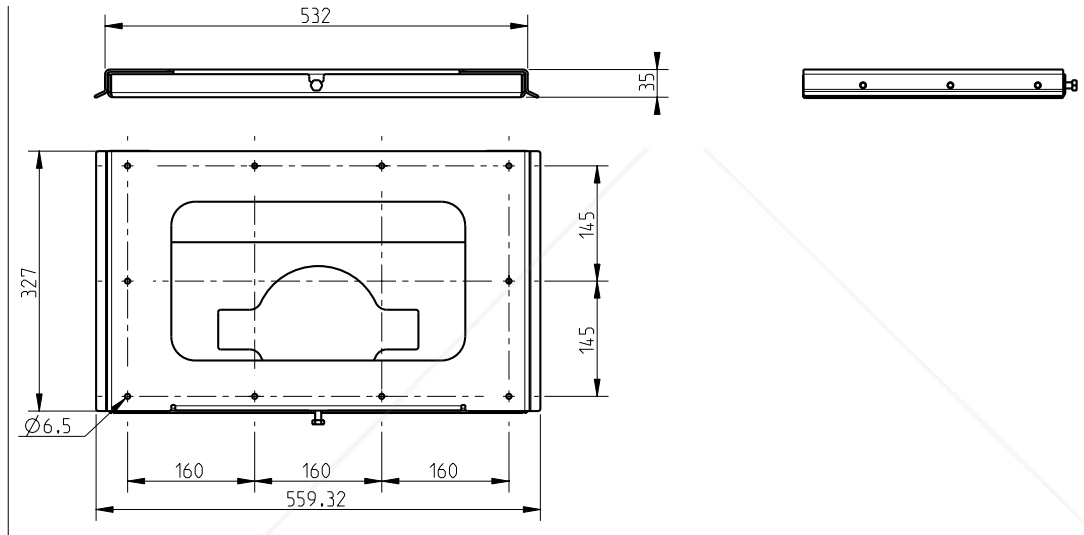

Image 6-15
Dimensions wall mount assembly

6.2.3 Installation using the Table mount kit

How to install the Table mount kit

1. Assemble the table mount as illustrated in drawing below. (image 6-16)
2. Mount the table mount onto the rear of the Cine VERSUM 50, using the 'a' holes (Installation using the Wall mount kit, page 41).

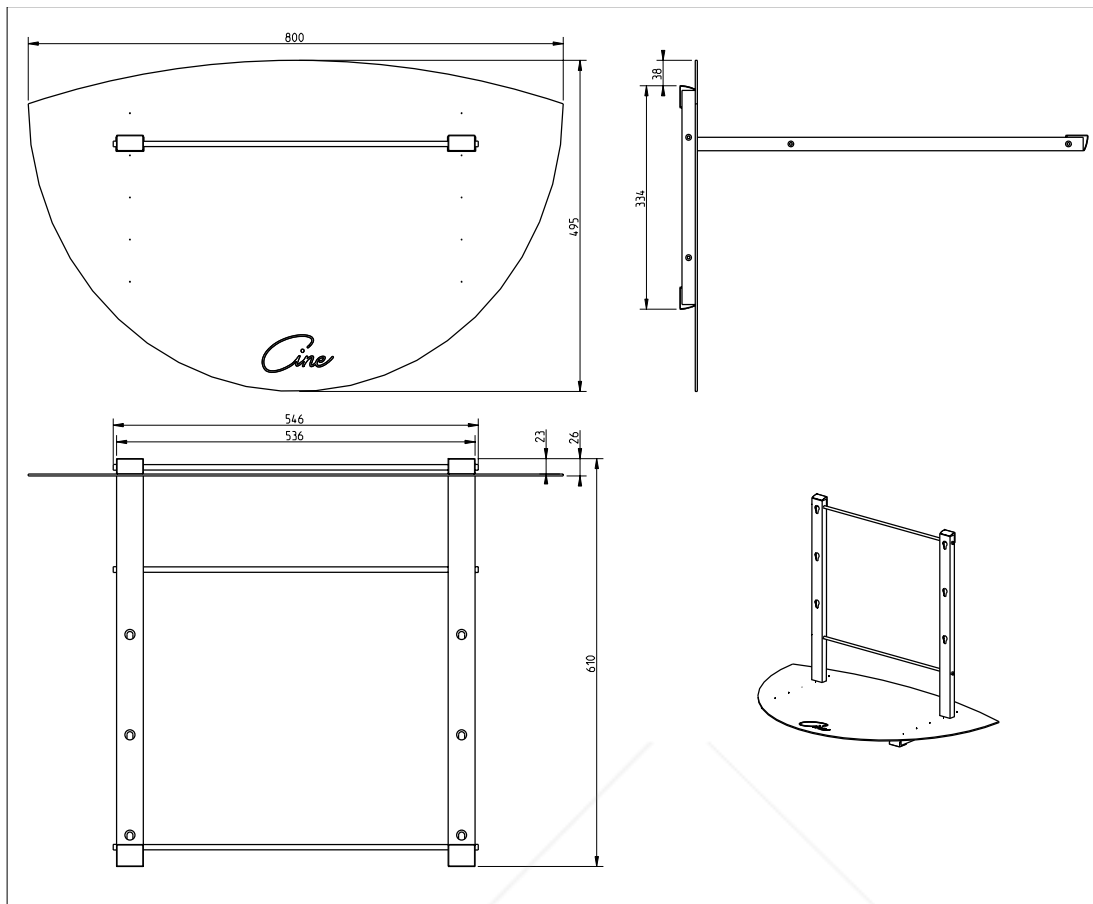

Image 6-16
Table mount assembly



Discount-Merchant.com (800) 281-8860
THE TRUSTED SOURCE FOR PROJECTOR LAMPS AND ACCESSORIES

7. CONNECTIONS

Overview

- Power Supply Connection
- Connection for Preview and Communication
- Digital Link to Display Modules
- Connection to Video Equipment

7.1 Power Supply Connection

7.1.1 Supplied Power Cords

The following power cords are added to the product

In the package of each product, two power cords are added, one with a plug shape, reference standard ANSI C73.11, and one with a plug shape, reference CEE (7).



Image 7-1
Power cord ANSI for Cine VERSUM 50, Cine VERSUM 80 and Cine VERSUM Master



Image 7-2
Power cord CEE for Cine VERSUM 50, Cine VERSUM 80 and Cine VERSUM Master



Image 7-3
Power cord ANSI (L-shaped socket) for Cine VERSUM 120



Image 7-4
Power cord CEE (L-shaped socket) for Cine VERSUM 120



Discount-Merchant.com (800) 281-8860

THE TRUSTED SOURCE FOR PROJECTOR LAMPS AND ACCESSORIES

7.1.2 Power Connection Cine VERSUM Master

AC Power Cord connection

Use the supplied power cord to connect the Cine VERSUM Master to the wall outlet. Plug the female power connector into the male connector at the rear of the unit. Make sure that the power cord is firmly inserted into the AC socket.



Image 7-5
Insertion of the power plug

AC Power Specifications

| | |
|-----------------------|--|
| AC Power Voltage | Auto Range 100 – 240V |
| AC Power Current | 1 A / 50 – 60 Hz |
| Main Fuses | Standby Power Supply: T 2AH/250V Main Power Supply: F 4A L 250V |
| Power Consumption | |
| Normal operation mode | 78 W Depending on input configuration |
| Standby mode | 8 W |
| Economic standby mode | 4 W |



For continued protection against risk of fire, all fuse replacements must be made using VDE and UL Listed or Recognized fuses with the same voltage and current rating.

7.1.3 Power Connection Cine VERSUM 80

AC Power Cord connection

Use the supplied power cord to connect the Cine VERSUM 80 to the wall outlet. First, remove the back cover (turn the quarter turn fastener a quarter turn counterclockwise) to facilitate the power plug insertion. Then, plug the female power connector into the male connector at the rear of the unit. Make sure that the power cord is firmly inserted into the AC socket and routed from the bottom side.



Image 7-6
Removal back cover



Image 7-7
Insertion of the power plug

AC Power Specifications

| | | |
|-------------------|-------------------------------|-------|
| AC Power Voltage | Auto Range 100 – 240V | |
| AC Power Current | 3 A – 1.5 A/ 50 – 60 Hz | |
| Main Fuse | Main Power Supply: T4A H 250V | |
| Power Consumption | | |
| | Normal operation mode | 270 W |
| | Standby mode | 8 W |

7.1.4 Power Connection Cine VERSUM 120**AC Power Cord connection**

Use the supplied power cord to connect the Cine VERSUM 120 to the wall outlet. First, remove the back cover (1) (turn the quarter turn fastener a quarter turn counterclockwise to unlock cover) and the power input cover (2) to allow the power plug insertion. Then, plug the female power connector into the male connector at the rear of the unit. Make sure that the power plug is firmly inserted into the AC socket and the power cable routed from the bottom side.

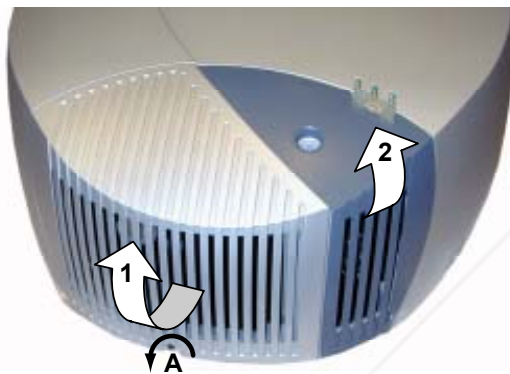

Image 7-8
Projector covers removal

- A Quarter turn fastener
- 1 Rear cover
- 2 Power input cover

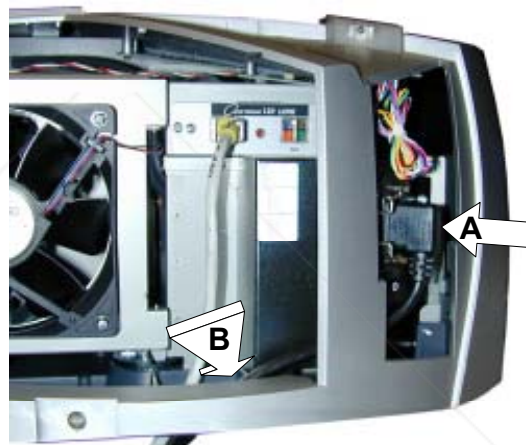

Image 7-9
Power connection

- A Right angle power socket
- B Power cable routing

AC Power Specifications

| | | |
|-------------------|--------------------------------|--|
| AC Power Voltage | Auto Range 90 – 240V | |
| AC Power Current | 7.0 A – 2.9 A/ 50 – 60 Hz | |
| Main Fuse | Main Power Supply: T15A H 250V | |
| Power Consumption | | |
| | Normal operation mode | 650 W (Dual lamp) -355 W (Single lamp) |
| | Standby mode | 14 W |

7.1.5 Power Connection Cine VERSUM 50**AC Power Cord connection**

Use the supplied power cord to connect the Cine VERSUM 50 to the wall outlet. Plug the female power connector into the male connector at the rear of the unit. Make sure that the power cord is firmly inserted into the AC socket.

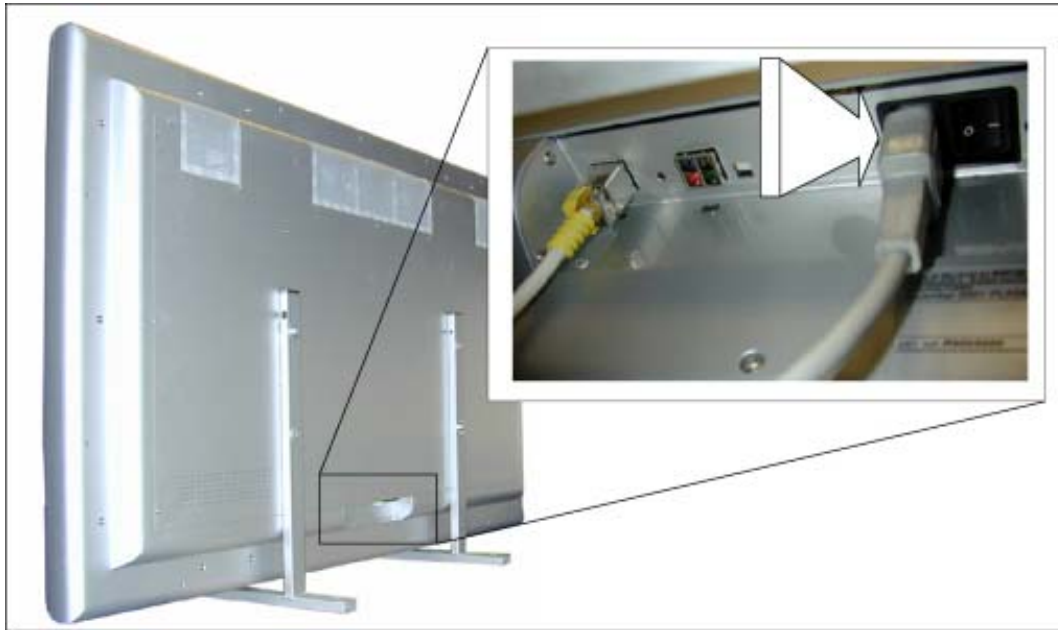

Image 7-10

AC Power Specifications

| | | |
|-------------------|--|-------|
| AC Power Voltage | Auto Range 100 – 240V | |
| AC Power Current | 4.0 –1.5 A / 50 – 60 Hz | |
| Main Fuse | Standby Power Supply: T 2AH/250V Main Power Supply: F 10AH/250V | |
| Power Consumption | | |
| | Normal operation mode | 350 W |
| | Standby mode | 4 W |

7.2 Connection for Preview and Communication

Overview

- Connection for Preview Monitors
- Connection for Communication
- Network Connection

7.2.1 Connection for Preview Monitors

Connection possibilities

The 5 BNC's on the output module carry the RGB Analog Video output signal with Separate Sync (H & V) for preview monitors or for any non-Cine VERSUM System display matching the output timings. The supplied RGB Analog video signal has the same resolution as the digital video output.

FixYourDLP.com
Sponsored by DM

Discount-Merchant.com (800) 281-8860
THE TRUSTED SOURCE FOR PROJECTOR LAMPS AND ACCESSORIES

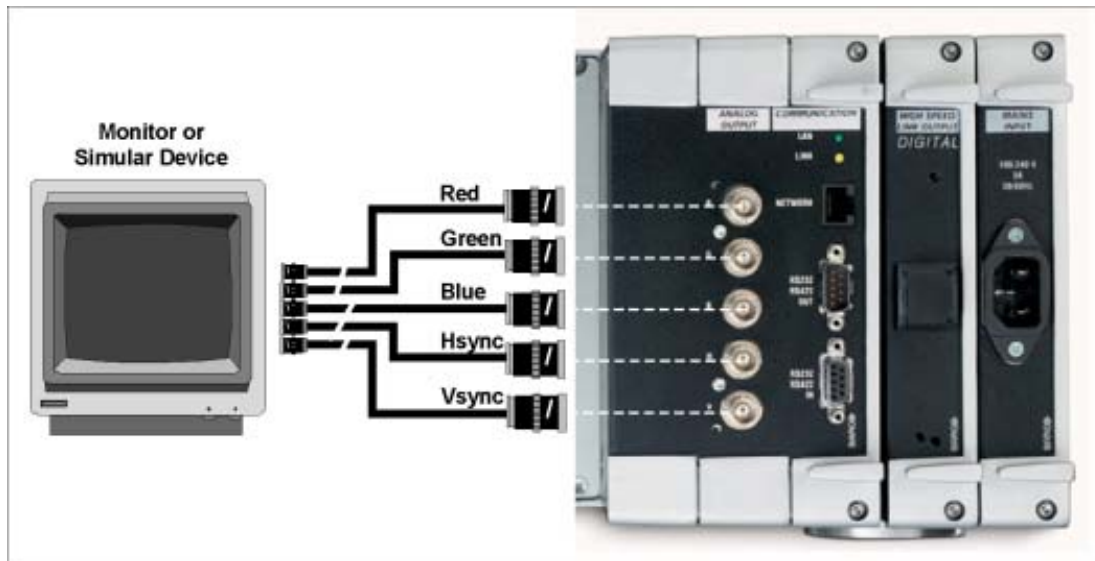

Image 7-11
Monitor connection

Analog Output Timings

| Vertical Sync | Pal | NTSC | PC/no signal |
|---------------|----------------|---------------|---------------|
| Period | 20 msec | 16.7 msec | 16.7 msec |
| Sync Width | 514 μ sec | 428 μ sec | 428 μ sec |
| Back Porch | 27.8 μ sec | 23 μ sec | 23 μ sec |
| Front Porch | 2.58 msec | 1.26 msec | 1.26 msec |
| Active Signal | 16.9 msec | 15 msec | 15 msec |

| Horizontal Sync | Pal | NTSC | PC/no signal |
|-----------------|----------------|----------------|----------------|
| Period | 23.4 μ sec | 19.6 μ sec | 19.6 μ sec |
| Sync Width | 2.30 μ sec | 2.00 μ sec | 2.00 μ sec |
| Back Porch | 1.8 μ sec | 1.5 μ sec | 1.5 μ sec |
| Front Porch | 1.12 μ sec | 680 nsec | 940 nsec |
| Active Signal | 18.2 μ sec | 15.4 μ sec | 15.2 μ sec |

- Back Porch = from rising edge of Sync to begin of active video.
- Front Porch = from end of active video to falling edge of Sync.

7.2.2 Connection for Communication

Purpose

The two D9 connectors RS422/RS232 In- and Output are defined as open standard for Communication with other Devices such as Control Panels (AMX, Creston™) and Audio Switchers).

FixYourDP.com
Sponsored by DM

Discount-Merchant.com (800) 281-8860
THE TRUSTED SOURCE FOR PROJECTOR LAMPS AND ACCESSORIES



Image 7-12
Communication connection

| RS232/422 IN | | RS232/422 OUT | | |
|--------------|-------------|---------------|--------------|-----------------------------------|
| Pin | Ref. | Pin | Ref. | Description |
| 1 | DCD_IN | | | Data Carry Detect |
| 6 | RXD+/DSR_IN | 6 | RXD+/DSR_OUT | Read Data/Data Set Ready |
| 2 | RXD-_IN | 2 | RXD-_OUT | Read Data |
| 3 | TXD-_IN | 3 | TXD-_OUT | Transmit Data |
| 8 | CTS_IN | | | Clear To Send |
| 4 | TXD+/DTR_IN | 4 | TXD+/DTR_OUT | Transmit Data/Data Terminal Ready |
| 9 | RI_IN | | | Ring Indicator |
| 5/10 | GROUND | 5/10 | GROUND | GROUND |

7.2.3 Network Connection

Purpose

Controlling and monitoring of the Cine VERSUM Master settings. Remote diagnostics to detect potential errors.



Actually, this connection is not supported internally (Development status).



Image 7-13
Network connection

7.3 Digital Link to Display Modules

Overview

- Cine VERSUM System Link
- Digital Link to One Display
- Digital Link to More Displays (Loop-through)
- Digital Link Cable for long distances

7.3.1 Cine VERSUM System Link

General info

BARCO's unique and proprietary digital link concept allows you to distribute both uncompressed high definition video images and two-way communication between the different Cine VERSUM System display modules throughout the network.

The no-compromise design of the Cine VERSUM System link allows for a throughput of 1,063 GB per second and per color to be achieved, resulting in a data streaming digital video distribution over the link of 3,18 GB per second.

Designed to provide the user with ultimate flexibility, the link allows for distances of up to 40 meters between each module. As such it is possible to connect up to a maximum of 32 different Cine VERSUM System display modules to one single Cine VERSUM Master over a total cable length of 1280 meters!

BARCO's Cine VERSUM System digital link comes in two different versions: a flexible cable for shorter distances (SL link) and a more shielded, rigid cable for longer distances (XL link). The length of the rigid cable can be custom made according to the requirements of each individual installation, up to a maximum length of 40 meters.

Available digital link cables

| Order Number | Description |
|--------------|--|
| R9841350 | Cable CINEVERSUM SL 1,5m |
| R9841360 | Cable CINEVERSUM SL 5m |
| R9841370 | Cable CINEVERSUM SL 15m |
| R9841380 | Cable CINEVERSUM XL xx m (Megaline cable on request) |
| R9841400 | Cable CINEVERSUM XL Connector (Female for long distance cable)+wall outlet+clips |

7.3.2 Digital Link to One Display

How to link

The digital output module on the Cine VERSUM Master is provided with one single output cable connector for SL type cable (for both video and communication).

Insert the plugs of the patch cord respectively into High Speed Link OUT on the digital module of the Cine VERSUM Master and Link IN on the Cine VERSUM 50 (image 7-14), Cine VERSUM 80 (image 7-15), or Cine VERSUM 120 (image 7-16)



To preserve image performances, limit the length of the patch cable, when using cable of type SL, to 15 m. For longer distances between both units, cable of type XL is recommended.



Image 7-14
Digital link with Cine VERSUM 50

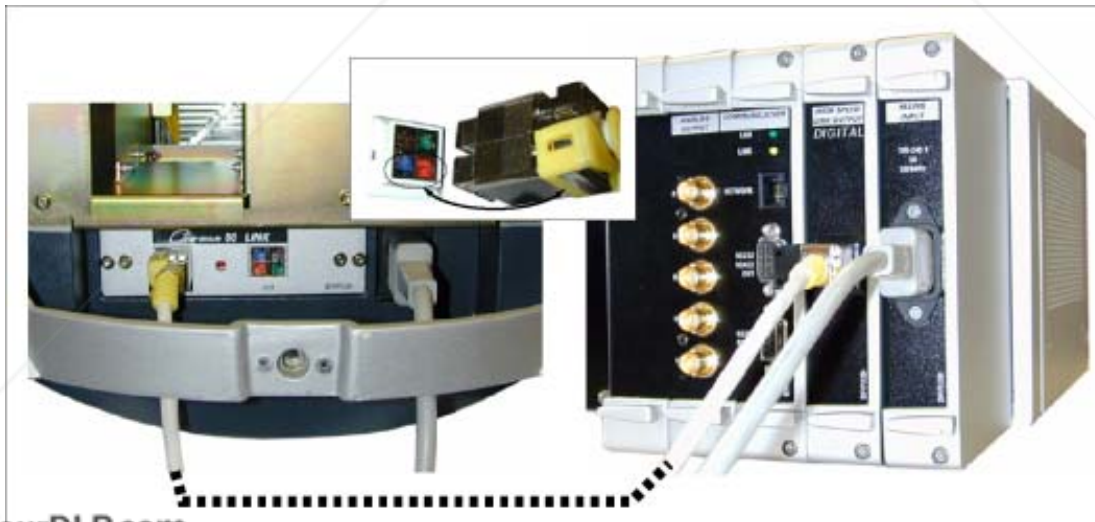

Image 7-15
Digital link with Cine VERSUM 80

 FixYourDLP.com
Discount-Merchant.com (800) 281-8860
THE TRUSTED SOURCE FOR PROJECTOR LAMPS AND ACCESSORIES

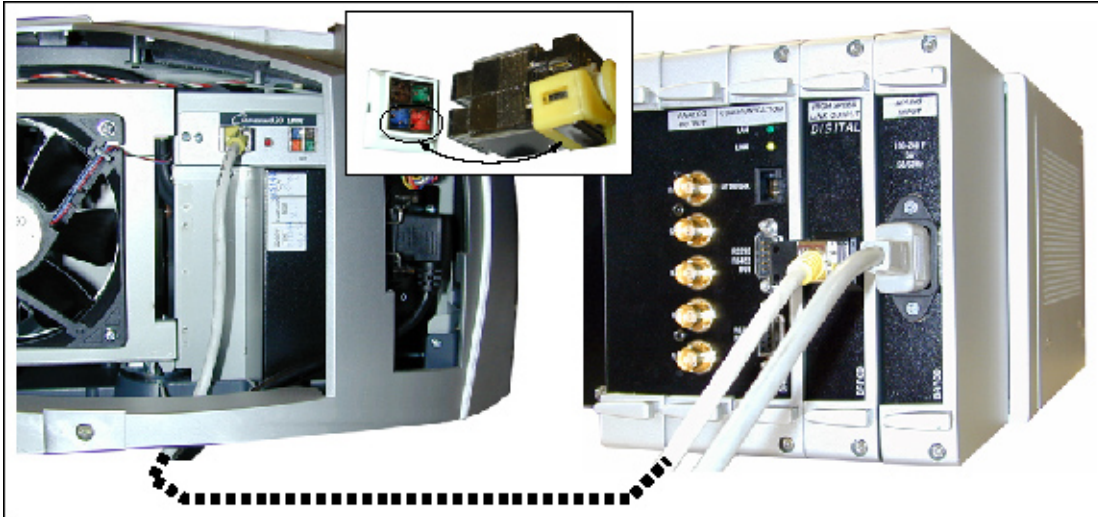

Image 7-16
Digital link with Cine VERSUM 120

7.3.3 Digital Link to More Displays (Loop-through)

How to link (e.g. a Cine VERSUM 50, a Cine VERSUM 80 and a Cine VERSUM 120)

The digital output module on the Cine VERSUM Master is provided with one single output cable connector for SL type cable (for both video and communication) with loop-through possibility on the Display Modules.

- Insert the plugs of the patch cord respectively into High Speed Link OUT on the digital module of the Cine VERSUM Master and Link IN on the Cine VERSUM 50.
- Insert the plugs of the patch cord respectively into the Link OUT on the Cine VERSUM 50 and the Link IN on the Cine VERSUM 80.
- Insert the plugs of the patch cord respectively into the Link OUT on the Cine VERSUM 80 and the Link IN on the Cine VERSUM 120 (last display in the chain).

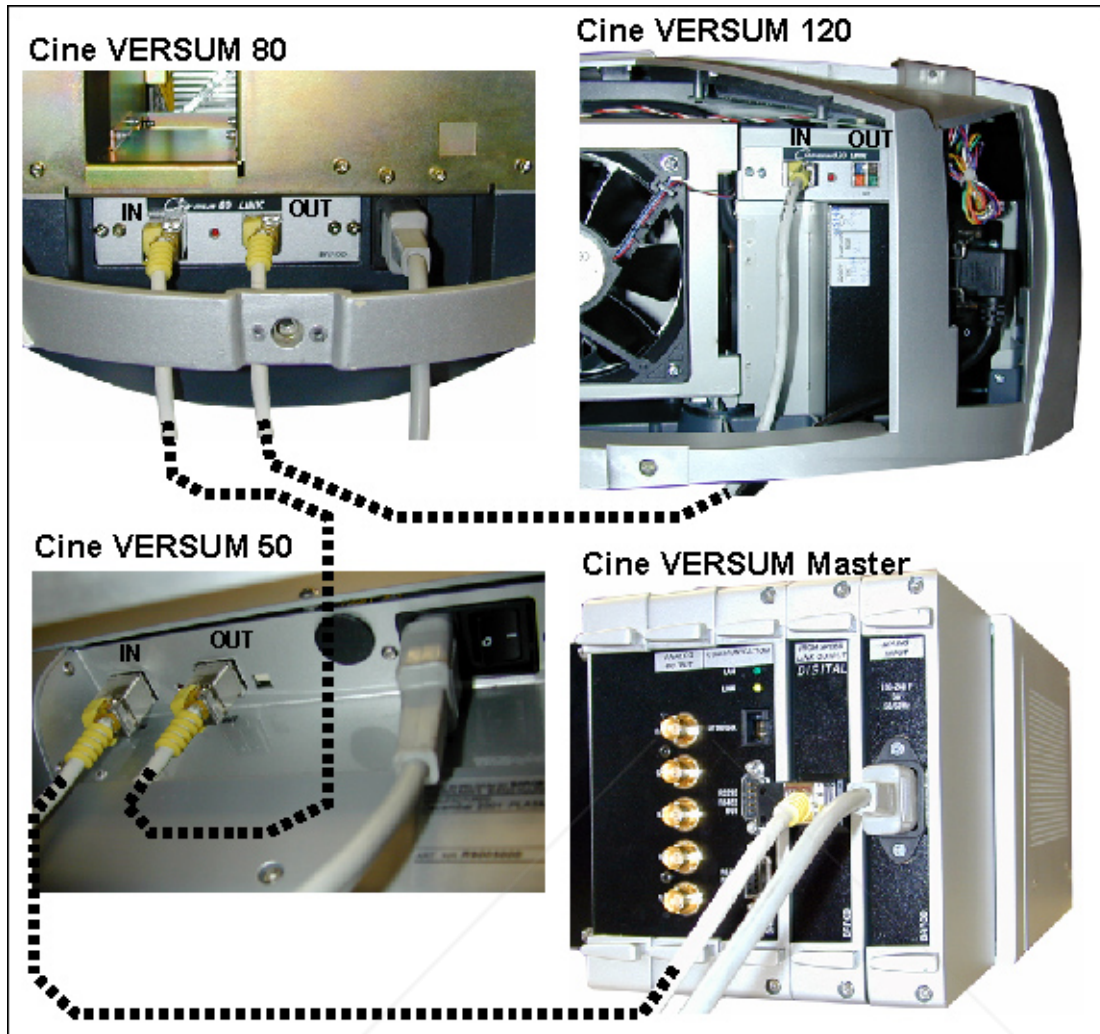

Image 7-17
Digital link with Cine VERSUM 50, Cine VERSUM 80 and Cine VERSUM 120

7.3.4 Digital Link Cable for long distances

Which cable has to be used

The XL cable allows the link for distances of up to 40m between each module. As such it is possible to connect up to a maximum of 32 different Cine VERSUM System display modules to one single Cine VERSUM Master over a total cable length of 1280m.



Image 7-18
Digital link cable long distance

FixYourDLBeam
Sponsored by DM
Discount-Merch.com (800) 281-8860
THE TRUSTED SOURCE FOR PROJECTOR LAMPS AND ACCESSORIES

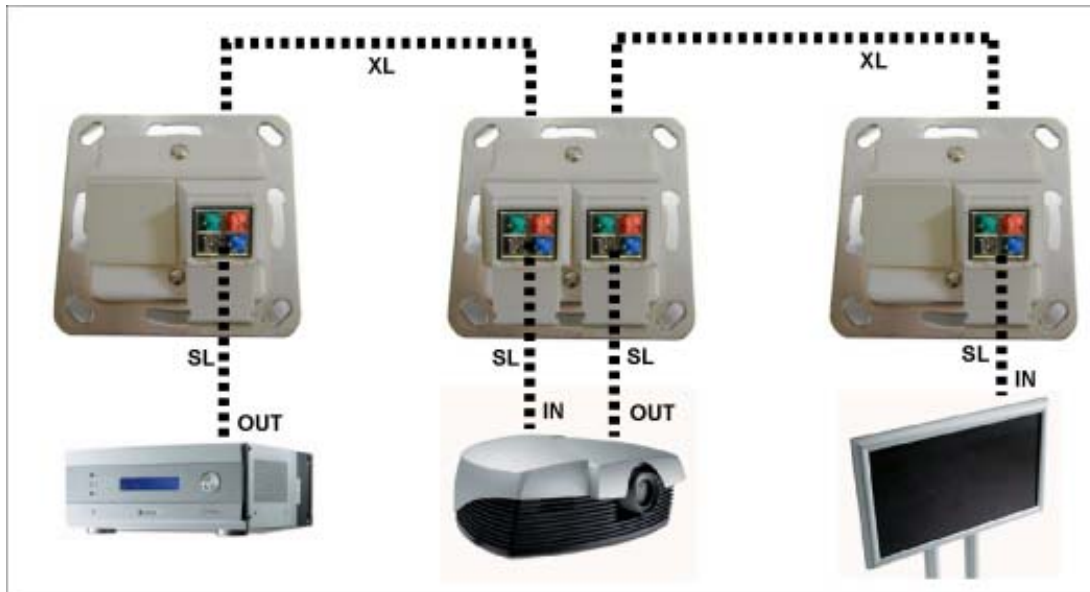

Image 7-19
Digital linking long distance via wall outlet

7.4 Connection to Video Equipment

Overview

- Input Connection per Module
- Installation of an Input module

General

The Cine VERSUM Master acts as the control unit of the complete Cine VERSUM System. It can be equipped with up to 8 digital and analog input modules which enable it to process all types of video, component video, RGB, SDI, HD-SDI, DVI and any future video standardizing.



Image 7-20
Input modules overview

- 1 RGB / YPrPb Input module
- 2 Video Input module
- 3 Video Input module
- 4 SDI Input module
- 5 HD SDI Input module
- 6-8 Free input slots (can be filled up with one of the above modules)

7.4.1 Input Connection per Module

Video Input module

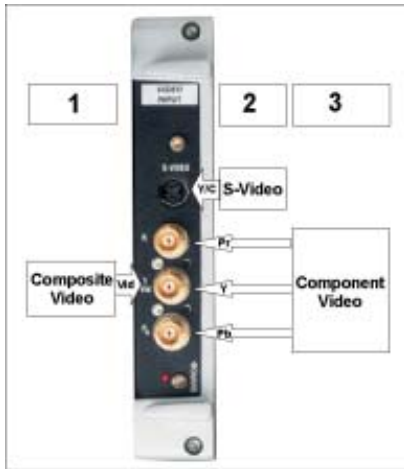

Image 7-21
Video Input module

| | |
|----------------------|--|
| Input mode | Signal format (1), (2) or (3) selectable |
| Decoder | Digital Multistandard Decoder, running at twice the oversampling rate (27 MHz). - PAL, PAL M, PAL N - NTSC, NTSC M, NTSC Japan, NTSC 4.43 - SECAM |
| Comb Filter | Adaptive 2/4 line Comb Filter for two dimensional Y/C separation |
| Features | - Built in Copy-Protection detection - Automatic Gain and Clamping control |
| Input signal level | |
| Video Input Mode | Composite Video signal 1.0Vpp |
| S-Video Input Mode | Y+Synchro 1.0Vpp C burst level 0.286Vpp |
| Component Input Mode | Y+Synchro 1.0Vpp Pr Pb |

RGB/HV/YPrPb Input

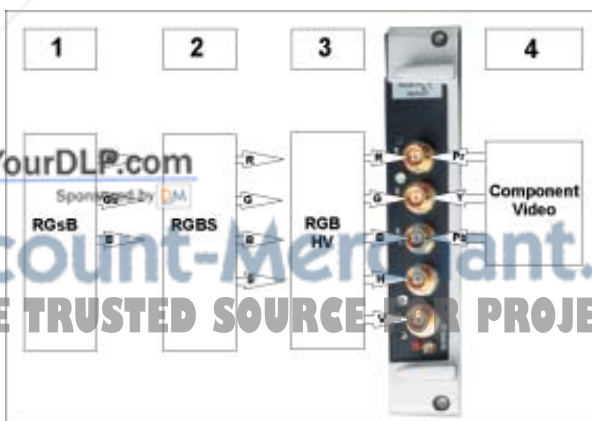

Image 7-22
RGB/HV Input module

FixYourDLP.com
Sponsored by DM
Discount-Merchants.com (800) 281-8860
THE TRUSTED SOURCE FOR PROJECTOR LAMPS AND ACCESSORIES

| | |
|----------------------|--|
| Input mode | Signal format (1), (2), (3) or (4) selectable on the GUI menu |
| Bandwidth | 500 MHz RGB Analog Bandwidth convertor |
| Signal support | Supports signals up to 205 MHz Pixel clock (1600 x 1200 @ 75 Hz) |
| Sync Detection | Automatic Sync detection for: RGBHV, RGSB and RGsB. |
| Sync Polarity | Automatic Sync Polarity detection |
| Input signal level | |
| RGsB Input Mode | RGB signal: 0.7Vpp Composite Video Sync on G: 1Vpp |
| RGSB Input Mode | RGB signal: 0.7Vpp Composite Video Sync on H: 1Vpp |
| RGB/HV Input Mode | RGB signal: 0.7Vpp Hs Sync signal: 0.7Vpp Vs Sync signal: 0.7Vpp |
| Component Input Mode | Y+Synchro: 1.0Vpp Pr Pb |

SDI Input

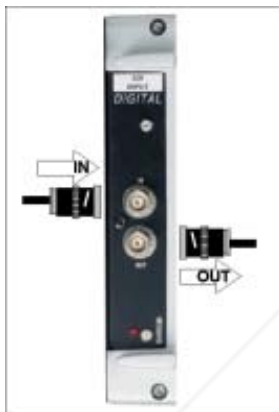

Image 7-23

| | |
|----------|--|
| Features | <ul style="list-style-type: none"> - Loop through SDI Input (SDI in/SDI out) - For DVD players and other Video equipment with SDI out. |
|----------|--|

HD SDI Input



Image 7-24

7. Connections

| | |
|----------|--|
| Features | <ul style="list-style-type: none"> - Loop through HD-SDI Input (HD-SDI in/HD-SDI out) - For HD-DVD players and other HD Video equipment with HD-SDI out. |
|----------|--|

Digital Visual Interface Input (DVI)



DVI: Digital Visual Interface is a display interface developed in repose to the proliferation of digital flat panels displays. It uses a high speed serial interface with TMDS (Transition Minimized differential signalling) to send data to the display. DVI can be single or dual link.

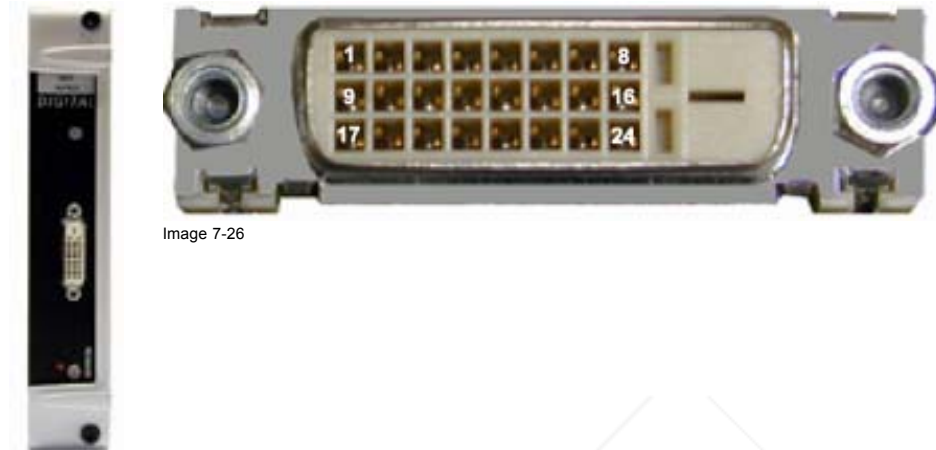

Image 7-26

Image 7-25
DVI input module
with DVI-D type
connector

| | | | | | | | |
|---|--------------|----|--------------|----|-----------------|----|-------------------|
| 1 | RX2- | 7 | SDA_PC | 13 | TMDS DATA 3- | 19 | RX0 Shield |
| 2 | RX2+ | 8 | nc | 14 | +5V Host | 20 | TMDS DATA 5- |
| 3 | RX2 Shield | 9 | RX1- | 15 | GND | 21 | TMDS DATA 5+ |
| 4 | TMDS DATA 4- | 10 | RX1+ | 16 | Hot Plug Detect | 22 | TMDS Clock Shield |
| 5 | TMDS DATA 4+ | 11 | RX1 Shield | 17 | RX0- | 23 | RXC+ |
| 6 | SCL_PC | 12 | TMDS DATA 3- | 18 | RX0+ | 24 | RXC- |

7.4.2 Installation of an Input module

How to install an Input module

1. Has the new input module to be inserted in a free slot?
If yes, go to step 2
If no, go to step 3
2. Take away the dummy plate by removing the two securing screws (A) and continue with step 5. (image 7-27)
3. Unlock the module by loosening the rod screws (A). (image 7-28)
4. Carefully pull out the module (image 7-28).
5. Match the module plug with the slot connector and push the plug into the connector. (image 7-29)
6. Secure the module by tightening the rod screws (A)(image 7-29).



Image 7-27



Image 7-28



Image 7-29



Discount-Merchant.com (800) 281-8860
THE TRUSTED SOURCE FOR PROJECTOR LAMPS AND ACCESSORIES

8. OPERATING THE REMOTE CONTROL

Overview

- Battery Insertion in the Remote Control
- Operating the Remote Control
- Address setting for the Remote Control

8.1 Battery Insertion in the Remote Control



– Insert batteries so that the plus (+) and minus (-) sides are aligned according to the markings in the battery case.

– Do not mix new batteries with used ones.

– The voltage of batteries may differ even if they are the same shape. Please do not mix different kinds of batteries.

– When not using the remote control unit for a long period of time (1 month or more), remove the batteries from the remote control unit to prevent leaking of battery fluid. If battery liquid has leaked, thoroughly wipe the inside of the case until all liquid is removed, and then insert new batteries.

– Do not charge, short, disassemble or throw the provided batteries in a fire.



When disposing of used batteries, please comply with governmental regulations or environmental public instruction's rules that apply in your country.

Where to find the batteries

The batteries are not placed in the remote control to avoid remote control operation in its package, resulting in a shorter battery life time.

The batteries are packed separately and added to the package of the remote control.

How to install the batteries

1. Push the cover tab (A) with the fingernail a little backwards and pull upwards the cover top (B). (image 8-1)
2. Slide the cover forwards to remove. (image 8-2)
3. Push the battery body towards the spring and lift it up to remove. (image 8-3)
4. Insert two AA size batteries, making sure the polarities match the + and – marks inside the battery compartment (image 8-3).
5. Insert the lower tab of the battery cover in the gap at the bottom of the remote control, and press the cover until it clicks in place (image 8-3).



Image 8-1
Battery cover unlock



Image 8-2
Battery cover removal



Image 8-3
Battery removal

8.2 Operating the Remote Control

Remote Control operation

This remote control includes a battery powered infrared transmitter which allows the user to control the Cine VERSUM Master remotely via its own built-in infrared receiver or via the infrared receivers built-in in the linked displays.



If backlight and RC operation indicator lights up too long or continuously, batteries need to be replaced.

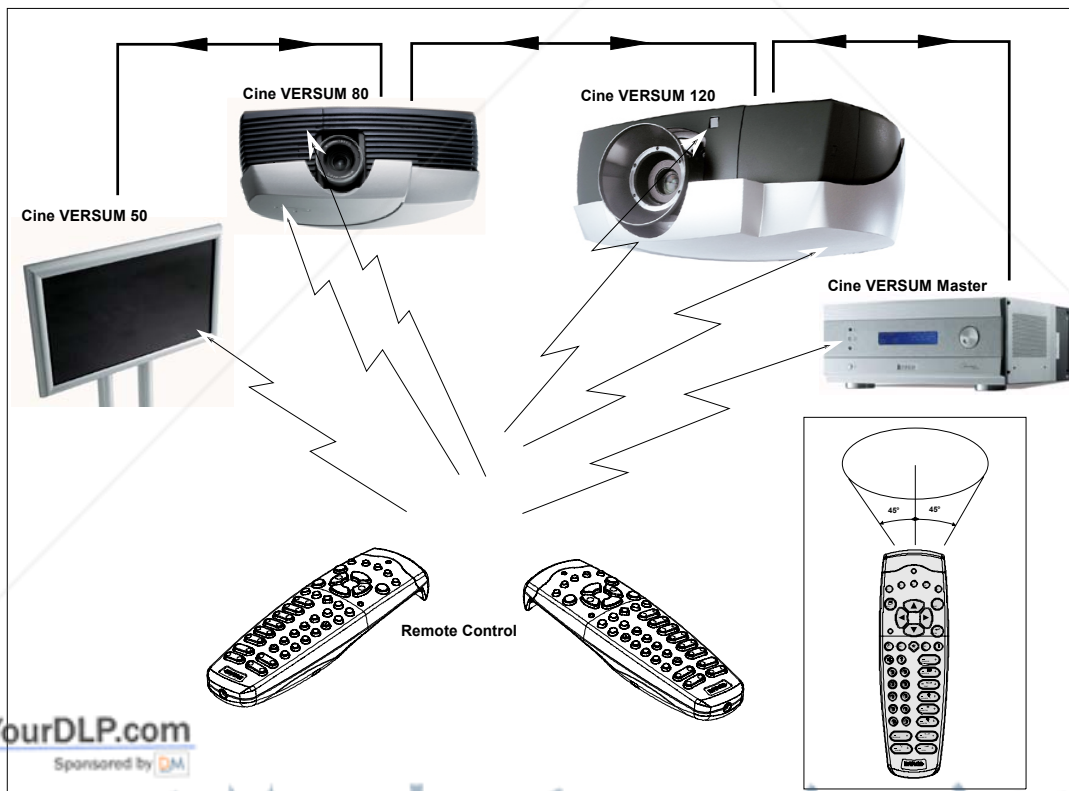

Image 8-4
Display Infra Red reception

When operating the remote control unit, point it at the remote sensor, located on the front side of the modules. The remote control unit is operable up to 9 m from the unit and within a 45° angle on each side of the sensor.

The signal from the remote control can be reflected off a screen for easy operation. However, the effective distance of the signal may differ due to the screen material.

When a key on the remote control is pressed, backlight is activated automatically. That allows the user to operate the remote control in a dark room. Backlight is turned off automatically a few seconds after the last key activation.

Remote control operation's difficulties

- The remote control unit may not operate if there are objects placed between it and the display.
- Operational distances will gradually become shorter as the batteries begin to wear out, replace weak batteries with new ones as soon as possible.
- Depending on the installation surroundings, this unit's remote control may be influenced by the infrared rays discharged from the plasma display, hampering reception of its rays or limiting its operational distance. The strength of infrared rays discharged from the screen will differ according to the picture displayed.

8.3 Address setting for the Remote Control

How to set the Remote Control address

1. Point the Remote Control to the module you desire to know the address and press the address key (recessed key).
On-screen and in the graphical display appears the number of the address. Now proceed to program the address in the Remote Control.
2. Again, press the ADDRESS key on the Remote Control. (image 8-5)
3. Press the digit key, corresponding with the desired address (between 0 and 9), WITHIN 5 SECONDS after the key has been pressed. (image 8-6)

The commands from the Remote Control are sent with the stored address.

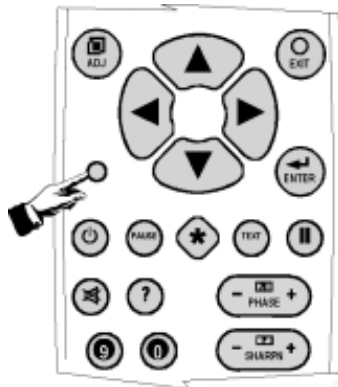

Image 8-5
Address key

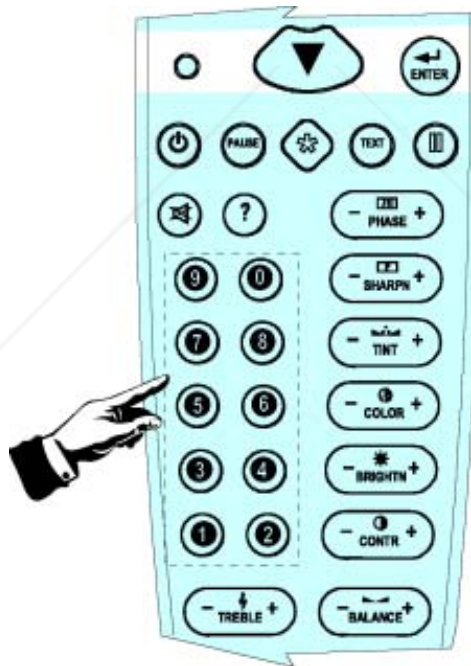

Image 8-6
Digit keys



Discount-Merchant.com (800) 281-8860
THE TRUSTED SOURCE FOR PROJECTOR LAMPS AND ACCESSORIES

9. POINTS OF SIMILARITY BETWEEN GRAPHICAL DISPLAY AND ON SCREEN MENUS

9.1 Explanation about differences in menu displays

Purpose

The different adjustment items are structured in main and sub menus. The way of showing the menus is different between the Cine VERSUM Master and the linked displays, but the subject matter of the menus is similar. Below a summary of the most important differences:

Graphical display on Cine VERSUM Master

On the Cine VERSUM Master a 4-line graphical display is built-in, with the result that only 4 items of a menu can be displayed. Rotating the selection wheel allows to scroll through the items, whereas pressing it, confirms the selection.

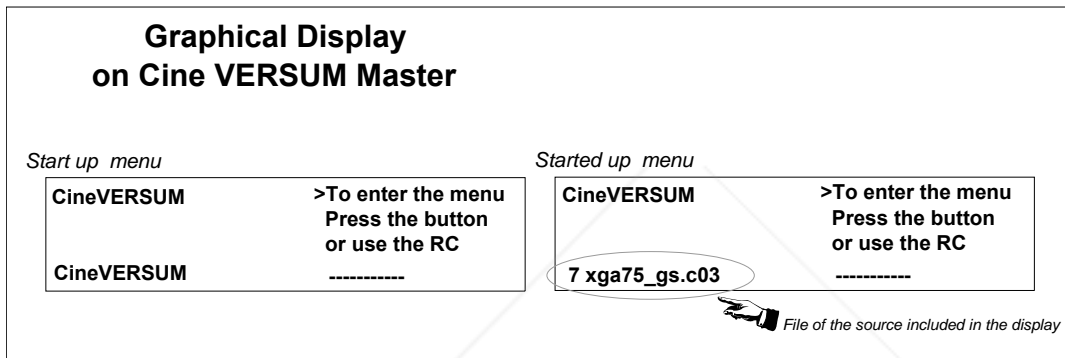

Image 9-1



Image 9-2

Indication of the selected item

The selected items on the graphical display are pointed with an arrow whereas the selected ones on the on-screen are highlighted.

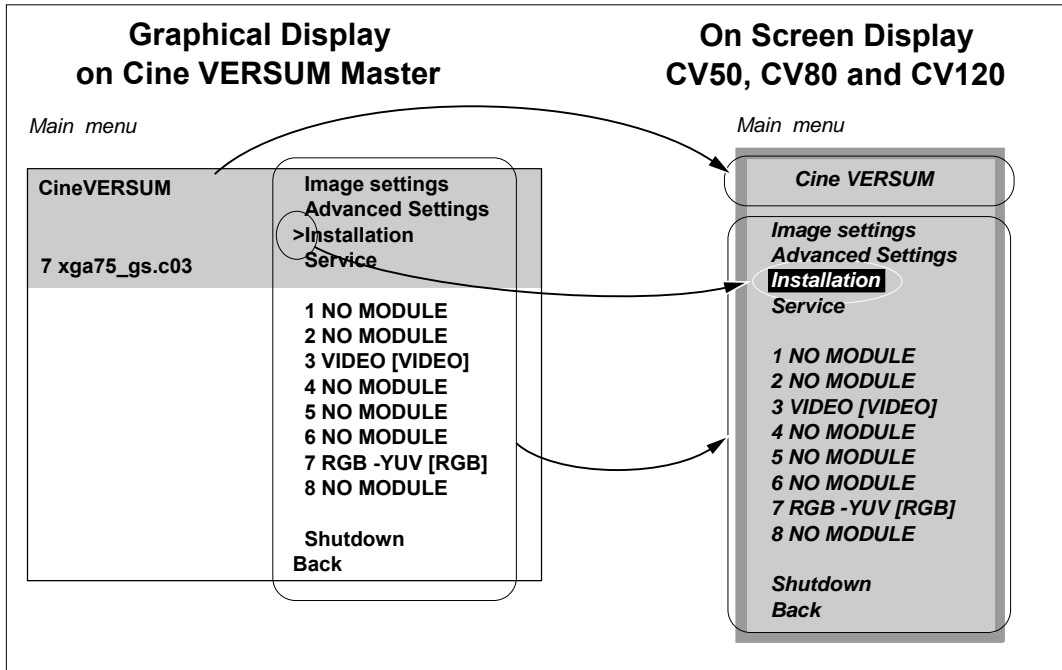

Image 9-3

Scrolling through the on-screen menus (Remote Control)

Scrolling through the on screen menus happens with the up and down cursor keys on the Remote Control. Pressing the ENTER key confirms of the selection.

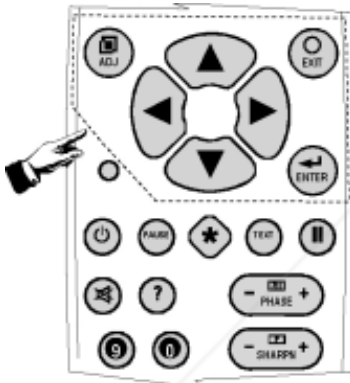

Image 9-4

Location of the menu or sub menu title

Title of a menu or sub menu is put on top of the on screen menu and in the left top corner on the graphical display.

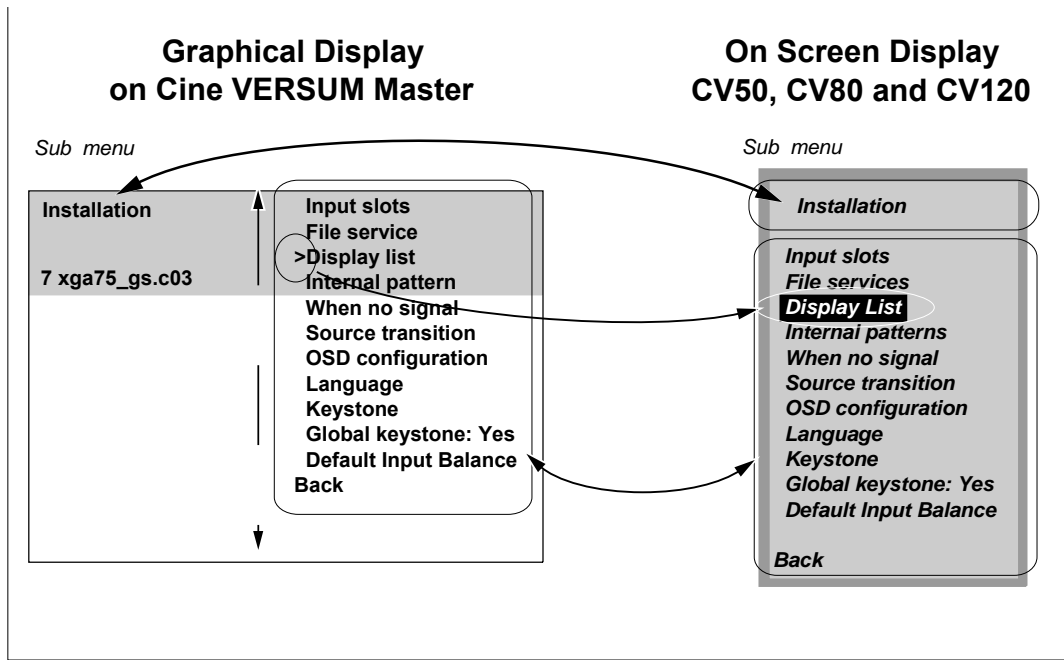

Image 9-5

Conclusion for the manual

Only the on screen menus will be depicted as illustration for the set up in the adjustment mode, except when a menu is specific for the graphical display or the on screen display.



Discount-Merchant.com (800) 281-8860
THE TRUSTED SOURCE FOR PROJECTOR LAMPS AND ACCESSORIES

10. OVERVIEW GUI MENU SCREENS

Overview

- Overview Main menu
- Overview Image Settings
- Overview Advanced Settings
- Overview Installation
- Overview Service

10.1 Overview Main menu

Main Menu

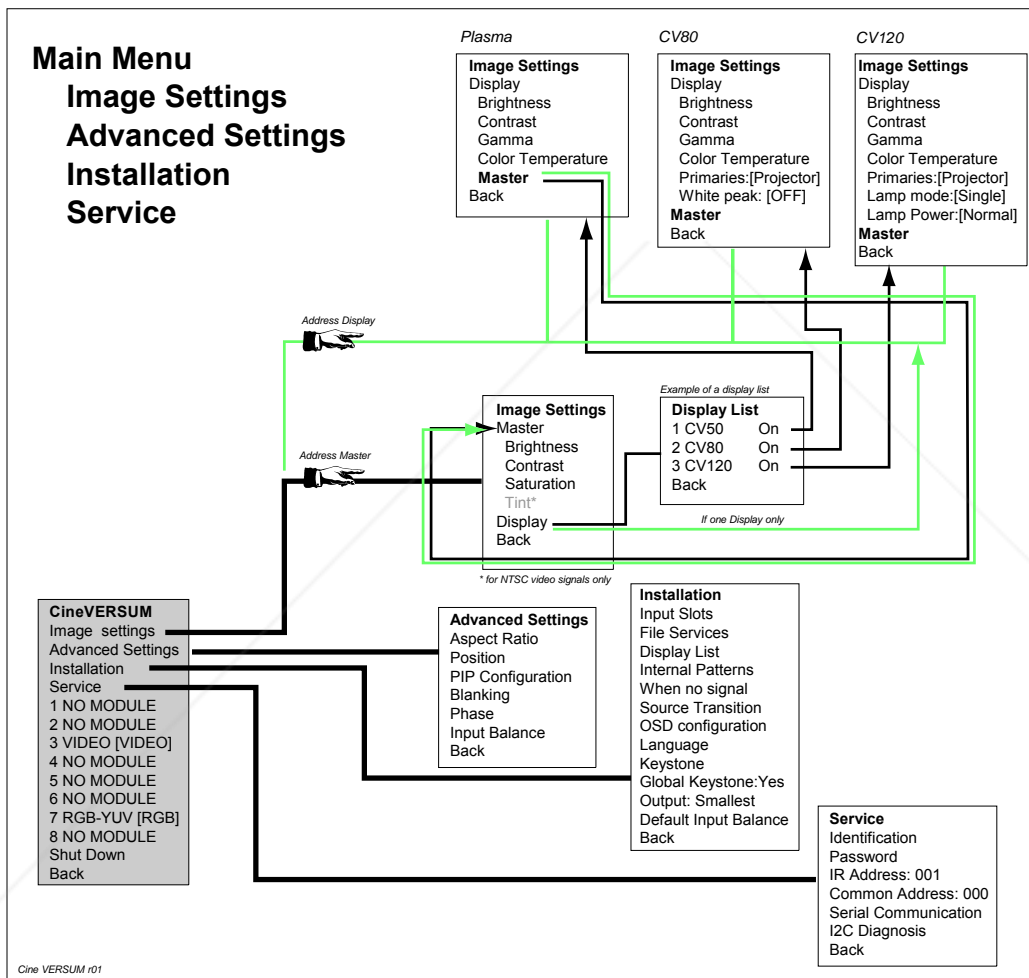
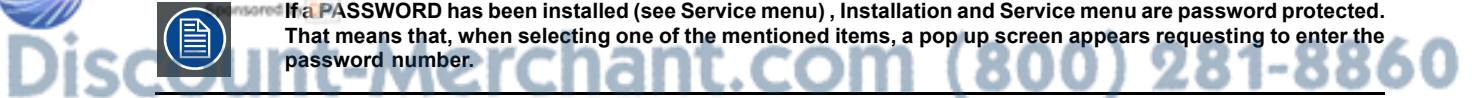

Image 10-1



If a **PASSWORD** has been installed (see Service menu) , Installation and Service menu are password protected. That means that, when selecting one of the mentioned items, a pop up screen appears requesting to enter the password number.



THE TRUSTED SOURCE FOR PROJECTOR LAMPS AND ACCESSORIES

10.2 Overview Image Settings

Main Menu-Image Settings

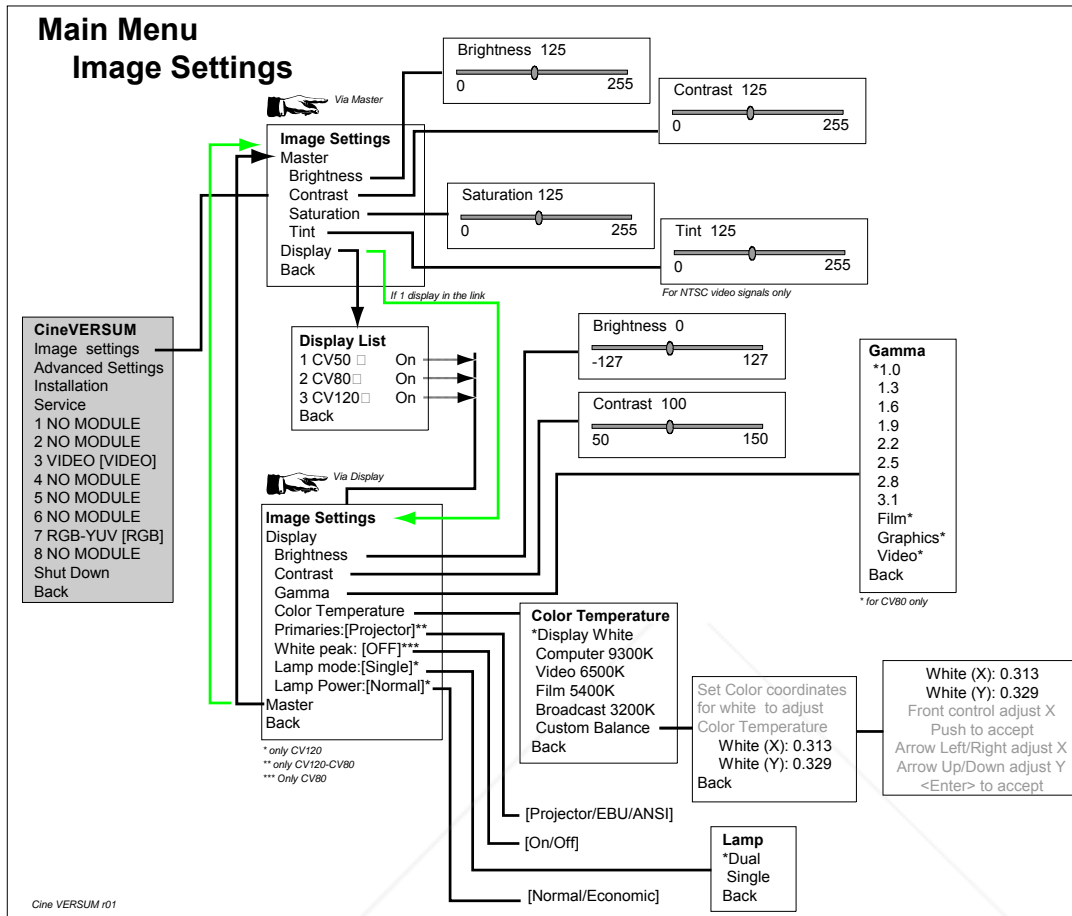

Image 10-2

10.3 Overview Advanced Settings

Main Menu-Advanced Settings

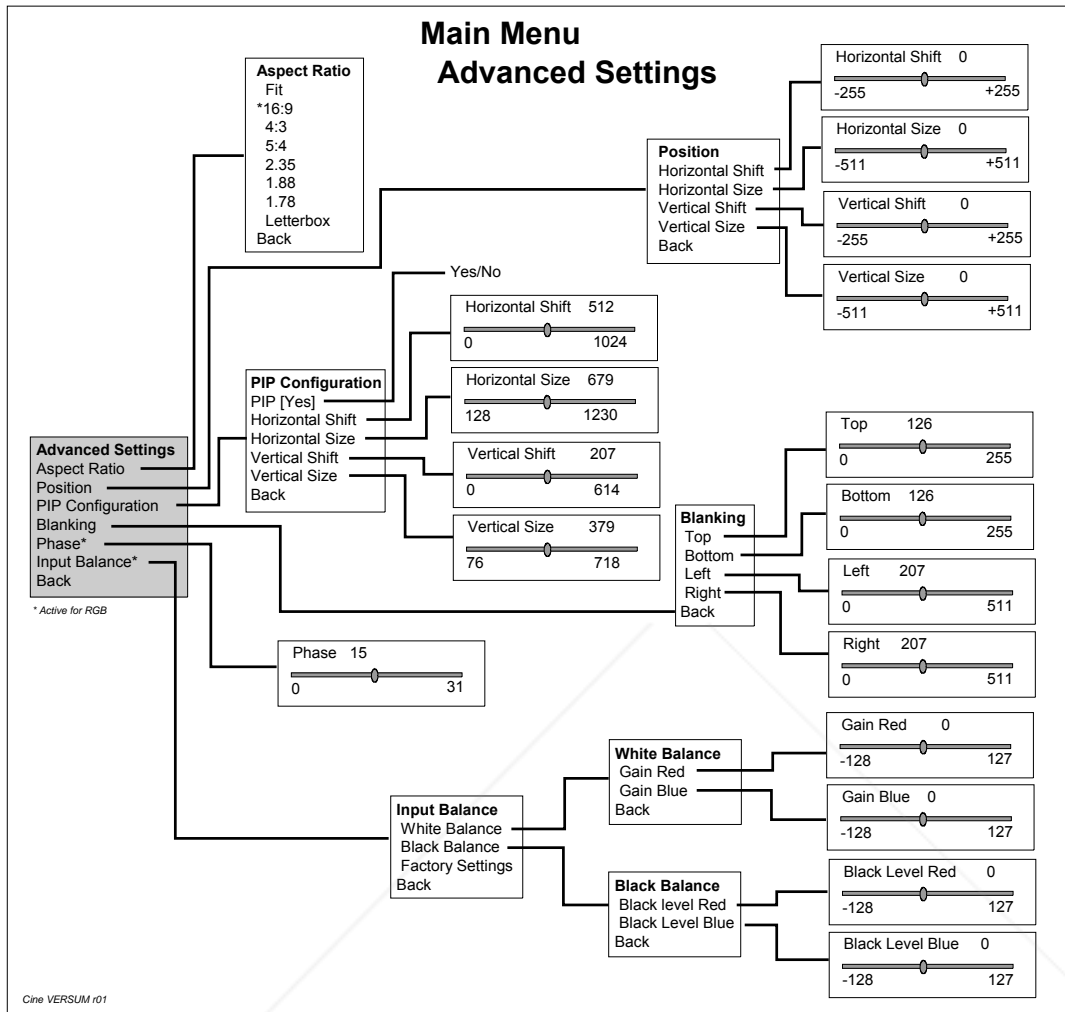

Image 10-3

10.4 Overview Installation

Main Menu-Installation 1

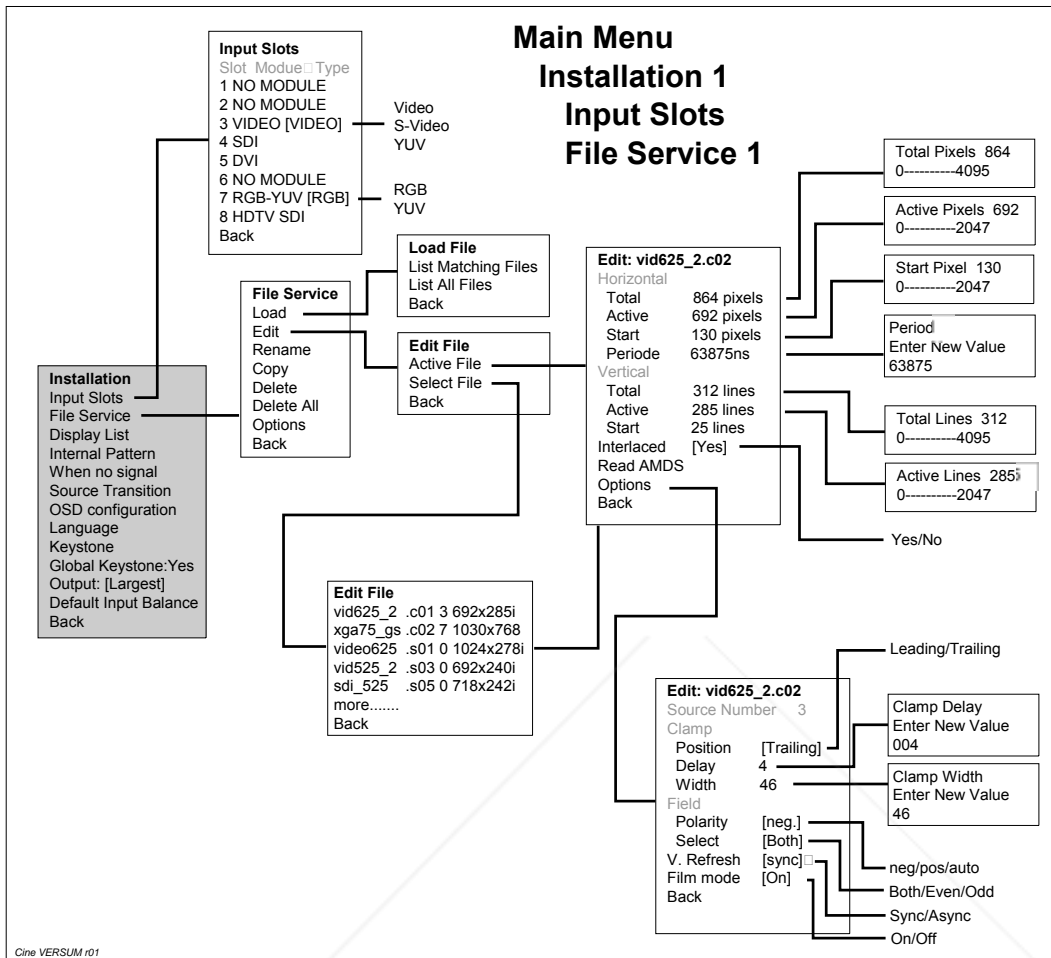

Image 10-4

Main Menu-Installation 2

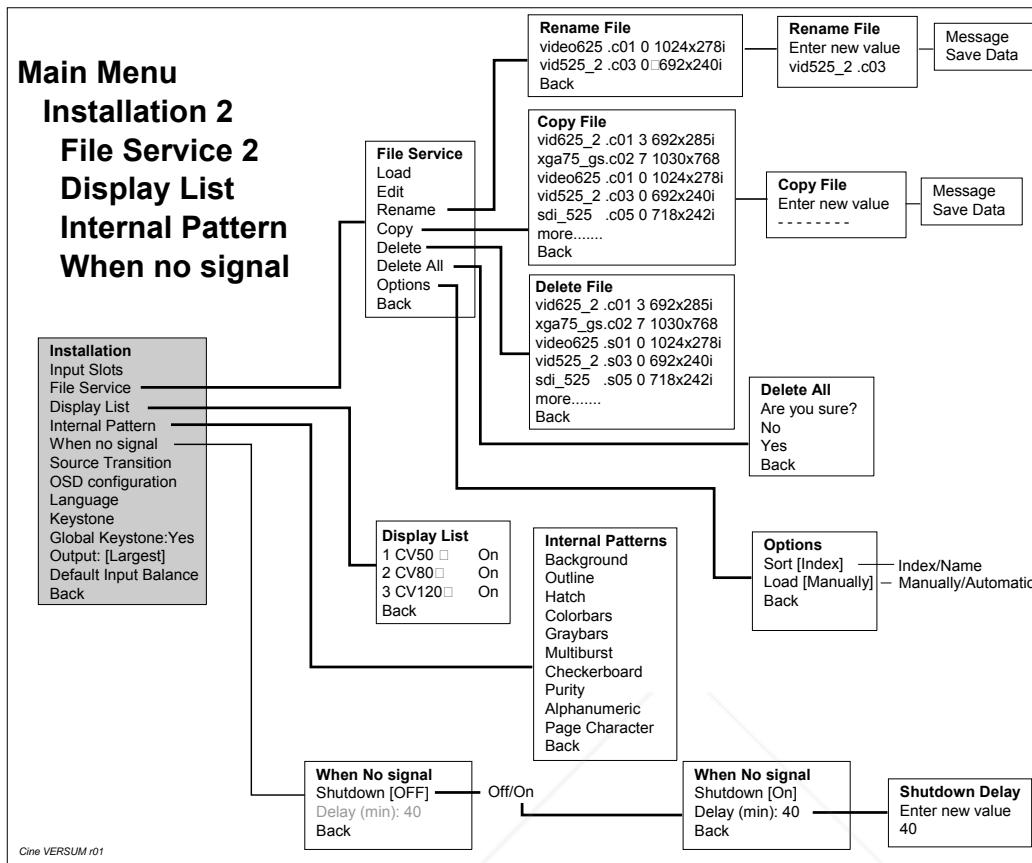

Image 10-5

Main Menu-Installation 3

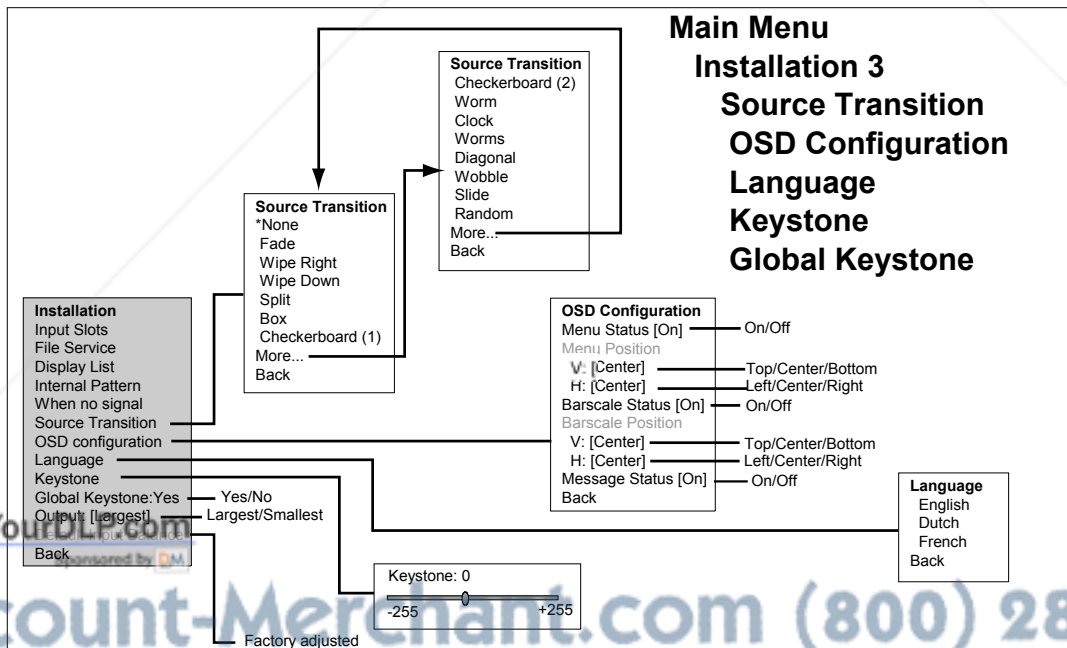

Image 10-6

FixYourDLF.com
 Discount-Merchant.com (800) 281-8860
 THE TRUSTED SOURCE FOR PROJECTOR LAMPS AND ACCESSORIES

Main Menu-Installation 4

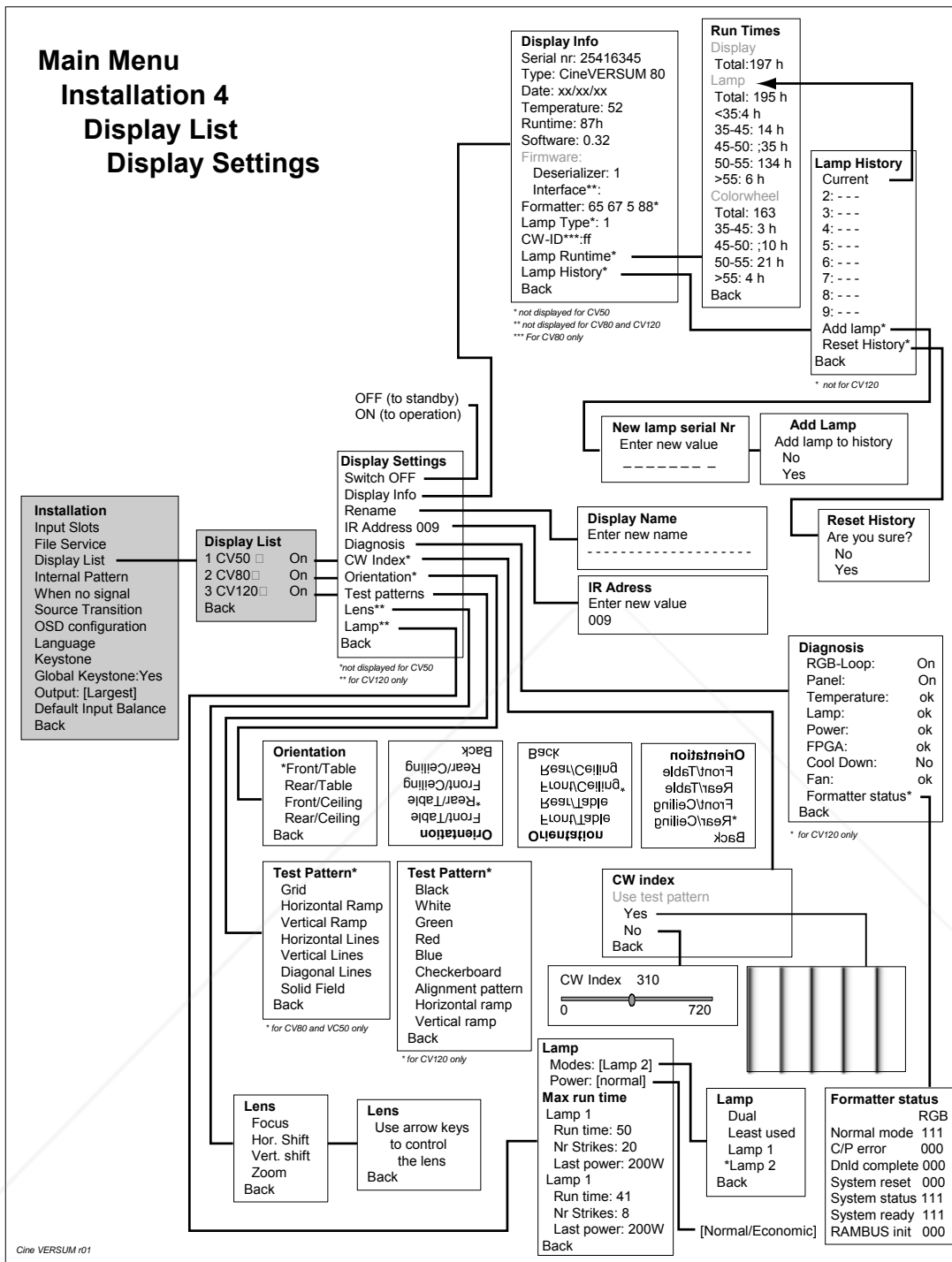

Image 10-7



Discount-Merchant.com (800) 281-8860
THE TRUSTED SOURCE FOR PROJECTOR LAMPS AND ACCESSORIES

10.5 Overview Service

Main Menu-Service

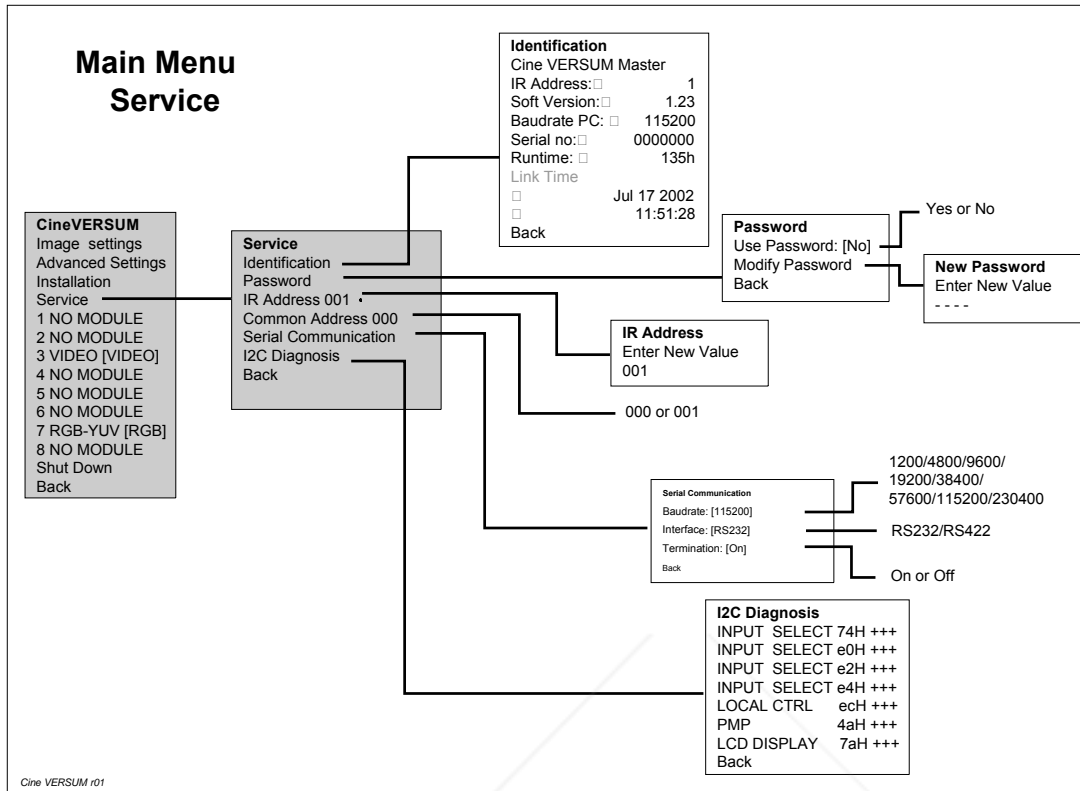

Image 10-8



Discount-Merchant.com (800) 281-8860
THE TRUSTED SOURCE FOR PROJECTOR LAMPS AND ACCESSORIES

11. POWERING ON/OFF THE CINE VERSUM SYSTEM

Getting started

After power, source and link cables have been installed, proceed to start up of the Cine VERSUM System.

Overview

- Powering ON the Cine VERSUM System
- Status of the System after powering up
- Display Info 'New Display' and 'Lost Display'

Powering on/off

Powering on/off is understood to mean switching on (to standby mode) and OFF the modules by means of its own power switch.

11.1 Powering ON the Cine VERSUM System

How to switch ON

An order of powering up the modules is not important.

1. Press the Power switch on the Cine VERSUM Master (On Cine VERSUM Master, page 27).
2. Turn over the power switch of the Cine VERSUM 50 (if in the link) in the (I) position (ON state) (Cine VERSUM 50, page 12).
3. Press the Power switch on the Cine VERSUM 80 (if in the link) (Cine VERSUM 80, page 13).
4. Press the Power switch on the Cine VERSUM 120 (if in the link) (Cine VERSUM 120, page 29)

11.2 Status of the System after powering up

About status of the modules after powering up

The last status of the modules is determinative for the status after the respective power switches have been turned on.

The System, from operation mode, can be powered down, using the respective power switches (Case A) or the power down mode (Case B). The power down mode switches the system in the standby mode. Also important is the status of the respective displays in the link (On or Off).

When turning on the power switch of the respective modules, the modules return to the last status.

Status of the modules in the system (Case A)

| | |
|----------------|---|
| Status modules | Cine VERSUM Master, Cine VERSUM 50, Cine VERSUM 80 and Cine VERSUM 120 in the operation mode. |
|----------------|---|



The linked displays return to the operation mode also, if they have the individual status 'ON' (Switching linked displays To and Out Standby, page 89).

The graphical display on the Cine VERSUM Master indicates how to enter the menus and at the bottom line the selected source file.



Menu 11-1

11. Powering on/off the Cine VERSUM System

Status of the modules in the system (Case B)

| | |
|-----------------------------------|---|
| Status modules | Cine VERSUM Master, Cine VERSUM 50, Cine VERSUM 80 and Cine VERSUM 120 in standby mode. |
| Standby LED on Cine VERSUM Master | Blinks (0.2s on/2s Off) |
| Standby LED on Connected Display | Blinks (0.2s on/2s Off) (For Cine VERSUM 50, blinking is superposed on already lightning up standby LED) |
| Display on Cine VERSUM Master | Start up menu (menu 11-2) preceded by messages indicating the detected displays (menu 11-3). |

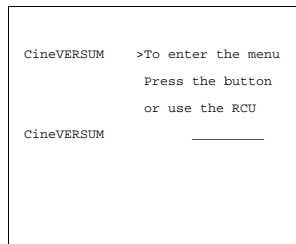

Menu 11-2



Menu 11-3

11.3 Display Info 'New Display' and 'Lost Display'

When appears 'New Display'?

With a powered up Cine VERSUM Master, each time a display is turned on (standby mode), a message 'New Display' appears on-screen and in the graphical display on the Master.

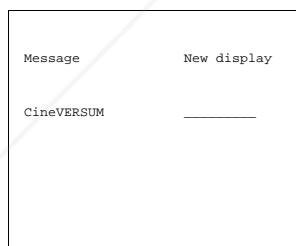

Menu 11-4

When appears 'Lost Display'?

With a powered up Cine VERSUM Master, each time a display is turned off (with power switch), a message 'Lost Display' appears on-screen (on the active display) and in the graphical display on the Master.

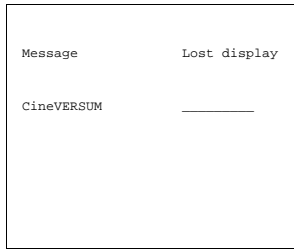

Menu 11-5



Discount-Merchant.com (800) 281-8860
THE TRUSTED SOURCE FOR PROJECTOR LAMPS AND ACCESSORIES



Discount-Merchant.com (800) 281-8860
THE TRUSTED SOURCE FOR PROJECTOR LAMPS AND ACCESSORIES

12. IMAGE PROJECTION AFTER POWERING UP

Overview

- Image Projection Using the Jog Dial on Cine VERSUM Master
- Image Projection Using the Remote Control
- Lamp Mode Set Up for Cine VERSUM 120 Only



Picture display can be started up using the selection wheel on the Cine VERSUM Master or using its Remote Control.

12.1 Image Projection Using the Jog Dial on Cine VERSUM Master

How starting the image projection

1. Press the jog dial on the Cine VERSUM Master (On Cine VERSUM Master, page 27).
Menu on graphical display changes as follows: (menu 12-1)
2. Place the arrow, by rotating the jog dial, in front of the item 'Power Up' (Always pointed at start up).
3. Press the jog dial to confirm.

The Cine VERSUM Master starts up, indicated by the message 'Power up' in the display. A few dots appear successively, indicating the start up period, to disappear after started up. (menu 12-2)

The Cine VERSUM Master starts on its turn image projection of the source, displayed when powering down the system, on the active linked displays. The file of the selected source is added to the menu (left-bottom). (menu 12-3)

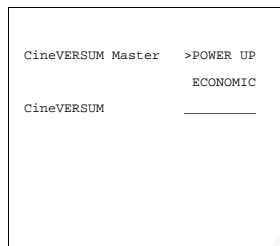

Menu 12-1

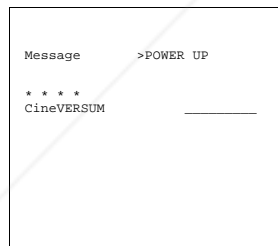

Menu 12-2

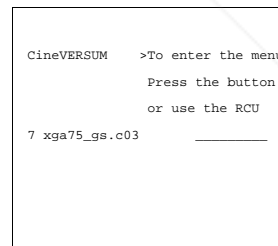

Menu 12-3

12.2 Image Projection Using the Remote Control

Way of starting image projection

Different keys on the remote control can be used for starting image projection. Make sure that the Remote control suits the address of the Cine VERSUM Master or uses the common address.

- (A) Standby key: last selected source re-selected.
- (B) Source selection key: direct access to the desired source.
- (C) ADJ (Adjust) and ENTER key: last selected source re-selected.

How starting the image projection(Case A & B)

1. Press the standby key or a valid source selection key (On InfraRed Remote Control, page 30). The Cine VERSUM Master starts up, indicated by the message 'Power up' in the display (menu 12-2).

The Cine VERSUM Master starts operation mode and starts on its turn image projection on the active linked displays. In case of pressing the standby key, the displayed image is the selected video source when powering down the system before. The file of the selected source is added to the menu (left-bottom)(menu 12-3).

How starting the image projection (Case C)

1. Press the ADJ or ENTER key (On InfraRed Remote Control, page 30). Menu on graphical display changes as follows –menu 12-1.
2. Press the cursor keys ↑ or ↓ to select item 'Power Up' (arrow in front of item).
3. Press ENTER to confirm. The Cine VERSUM Master starts up, indicated by the message 'Power up' in the display (menu 12-2).

The Cine VERSUM Master starts operation mode and starts on its turn image projection on the linked displays of the source displayed when powering down the system before. The file of the selected source is added to the menu (left-bottom)menu 12-3).

12.3 Lamp Mode Set Up for Cine VERSUM 120 Only

Overview

- Lamp Mode Set Up Single/Dual (Image Settings menu)
- Lamp Mode Set Up Economic/Normal (Image Settings menu)
- Lamp mode/Power set up in Display Settings menu

About Lamp Mode for Cine VERSUM 120

The Cine VERSUM 120 is equipped with a dual lamp unit. This lamp unit can be programmed to work in a single or a dual lamp mode as well as boosted in power from 200 W (Economic) to 250 W (Normal).

When a lamp fails in the dual lamp mode, the projector goes on with projection on the remaining lamp.

When programming Single mode, then the least used lamp will be ignited.



Lamp 'mode' and 'power' can be set up in the **IMAGE SETTINGS** and in the **DISPLAY SETTINGS** menu. Both set ups overrule each other, except when forced lamp 1 or 2 has been chosen in the **LAMP MODE** menu.

12.3.1 Lamp Mode Set Up Single/Dual (Image Settings menu)



When forced lamp 1 or 2 has been set up, then, item **LAMP MODE** in the Image Settings menu is replaced by non-active 'Forced lamp 1 or 2' item.

How to set up:

1. Enter the MAIN menu and scroll through the sub menus, using the jog dial or the Remote Control until the Image Settings menu for the Cine VERSUM 120 is displayed. (image 12-1)
2. Select menu item **LAMP MODE** and enter the lamp mode 'Single' or 'Dual' by pressing the jog dial or the **ENTER** key on the Remote Control.
Note: Results of lamp switching from Single to Dual will take some time due to the ignition time of the second lamp.
3. Leaving the GUI, use the **BACK** item in the menu or press **EXIT** key on the Remote Control.

Main Menu/Image Settings /Display/CV80 or CV120 / Lamp Power

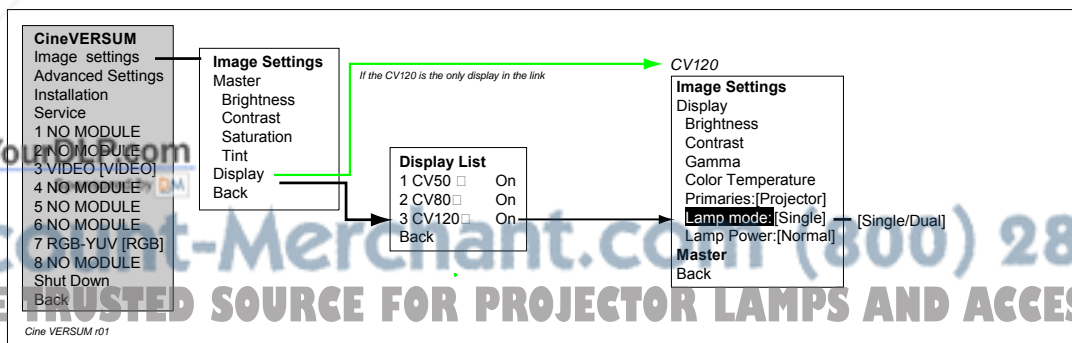

Image 12-1
Menu item Lamp Mode

12.3.2 Lamp Mode Set Up Economic/Normal (Image Settings menu)

How to set up:

1. Enter the MAIN menu and scroll through the sub menus, using the jog dial or the Remote Control until the Image Settings menu is displayed. (image 12-2)
2. Select menu item *LAMP POWER* and enter the lamp mode 'Economic' or 'Normal' by pressing the jog dial or the **ENTER** key on the Remote Control.
Note: To increase the lamp life time, enter the economic lamp power mode.
3. Leaving the GUI, use the *BACK* item in the menu or press **EXIT** key on the Remote Control.

Main Menu/ Image Settings /Display/ CV80 or CV120 /Lamp Power

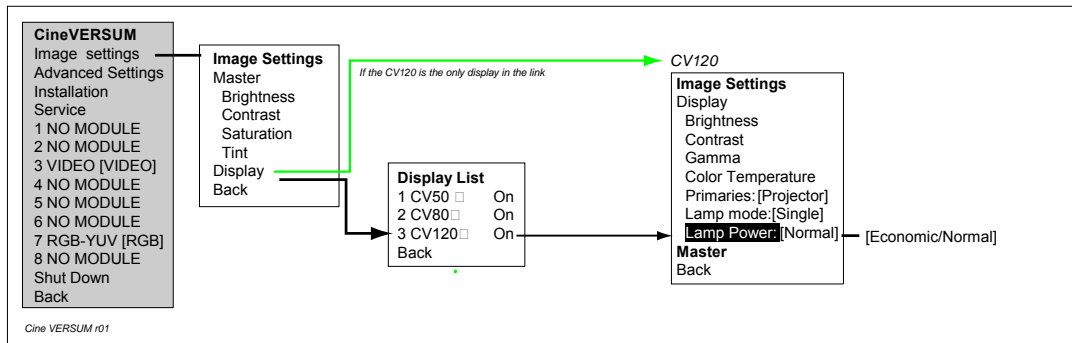

Image 12-2
Menu item Lamp Power

12.3.3 Lamp mode/Power set up in Display Settings menu

How to set up

1. Enter the MAIN menu and scroll through the sub menus, using the jog dial or the Remote Control until the Display Settings menu for the Cine VERSUM 120 is displayed. (image 12-3)
2. Select item *LAMP* and press jog dial or **ENTER** key to confirm.
Lamp menu is displayed, inclusive items *MODE* and *POWER*.
3. To set up Lamp Power, select item *POWER* and press the jog dial or the **ENTER** key on the remote Control for 'Normal' or 'Economic' lamp power.
4. To set up the Lamp Mode, select item *MODES* and press the jog dial or the **ENTER** key on the remote Control.

A lamp mode menu is displayed allowing 4 different possibilities. The active mode is preceded with a star. Select the mode you desire and press the jog dial or **ENTER** key on the Remote Control to confirm.

- DUAL: both lamps will be ignited at start up (Can be overruled in the IMAGE SETTINGS menu).
- LEAST USED (=SINGLE): least used lamp of both will be ignited at start up (Can be overruled in the IMAGE SETTINGS menu).
- LAMP 1: at start up, Lamp 1 will be forced to ignite (CANNOT be overruled in the IMAGE SETTINGS menu).
- LAMP 2: at start up, Lamp 2 will be forced to ignite (CANNOT be overruled in the IMAGE SETTINGS menu).

5. Leaving the GUI, use the *BACK* item in the menu or press **EXIT** key on the Remote Control.

Main Menu/ Installation /Display List/ cv120 /Lamp

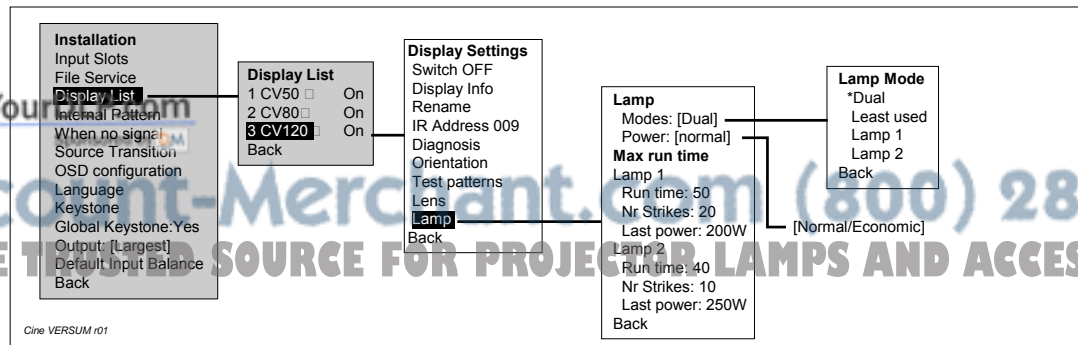

Image 12-3
Menu item lamp



Discount-Merchant.com (800) 281-8860
THE TRUSTED SOURCE FOR PROJECTOR LAMPS AND ACCESSORIES

13. PROJECTION STOP (STANDBY OR ECONOMIC STANDBY MODE)

Overview

- Projection Stop Using the Selection Wheel
- Projection Stop Using the Remote Control



Economic Standby for the Cine VERSUM Master only: in this mode, the power dissipation is reduced and the system stays operational for re-start of the system.

13.1 Projection Stop Using the Selection Wheel

How to stop image projection

1. Press the jog dial on the Cine VERSUM Master. Scroll through the menu by rotating the jog dial until item 'Shutdown' is pointed. (menu 13-1)
2. Press the jog dial to confirm. The Master starts the shutdown process indicated in the graphical display with the message 'Power Down'. At the end, the system returns to startup screen. (menu 13-2)

The Master goes into standby mode and switches on its turn the linked displays into the standby mode (disabling image projection).

3. To switch the Cine VERSUM Master into the 'Economic Standby', press the jog dial again. The graphical display indicates two items, 'POWER UP' and 'ECONOMIC'. (menu 13-4)
4. Scroll down in the menu by rotating the jog dial until item 'ECONOMIC' is pointed (menu 13-4).
5. Press the jog dial gain to confirm.

The Cine VERSUM Master switches into the Economic mode, meaning into the lowest power dissipation. The lightning of the graphical display is reduced to a minimum including the Zzzzz message. (menu 13-5)

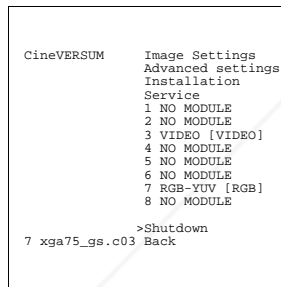

Menu 13-1

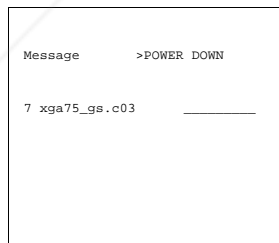

Menu 13-2

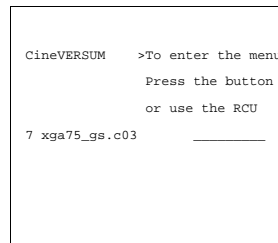

Menu 13-3

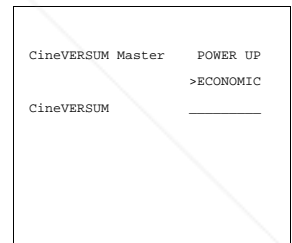

Menu 13-4

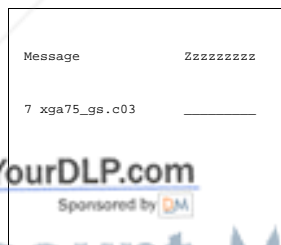

Menu 13-5

FixYourDLP.com
 Sponsored by  DM

Discount-Merchant.com (800) 281-8860
THE TRUSTED SOURCE FOR PROJECTOR LAMPS AND ACCESSORIES

13.2 Projection Stop Using the Remote Control

Overview

- Direct System Shutdown (standby)
- System Shutdown (standby) via screen menu

13.2.1 Direct System Shutdown (standby)



The On Screen menus on the Cine VERSUM 50, Cine VERSUM 80 and Cine VERSUM 120 are with respect to content identic. Nevertheless, some items are specific for a display and are therefore grayed out if not applicable for that specific display. Make sure that the Remote control suits the address of the Cine VERSUM Master or uses the common address.

How to stop image projection

1. Point the front of the Remote Control (to the IR receiver of the Cine VERSUM Master, Cine VERSUM 80, Cine VERSUM 50, Cine VERSUM 120 or the projection screen. The latter reflects the signal from the Remote Control. However, the effective distance of the signal may differ due to the screen material.
2. Press for a few seconds the standby key on the Remote control (On InfraRed Remote Control, page 30).

On the screen appears a message, indicating the start of the power down process.

After a few seconds, the Cine VERSUM Master goes into standby mode and switches on its turn the active linked displays into the standby mode (disabling image projection). (menu 13-6)

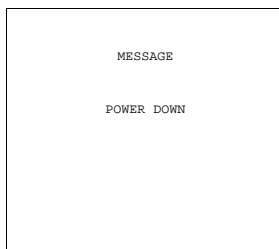

Menu 13-6

13.2.2 System Shutdown (standby) via screen menu

How to stop image projection

1. Point the front of the Remote Control (to the IR receiver of the Cine VERSUM Master, Cine VERSUM 80, Cine VERSUM 50, Cine VERSUM 120 or the projection screen. The latter reflects the signal from the Remote Control. However, the effective distance of the signal may differ due to the screen material.
2. Press the 'ADJ' or 'ENTER' key on the Remote Control (On InfraRed Remote Control, page 30).

On the screen appears the main menu. (menu 13-7)

3. Scroll through the items, using the arrow keys ↑ or ↓, until item 'Shutdown' is highlighted (menu 13-7).
4. Press **ENTER** to confirm.

On the screen appears a message, indicating the start of the power down process.

After a few seconds, the Cine VERSUM Master goes into standby mode and switches on its turn the active linked displays into the standby mode (disabling image projection). (menu 13-8)

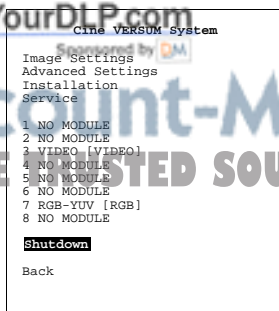

Menu 13-7



Menu 13-8



After the power down time, the standby LED on the Cine VERSUM 80 stays blinking on a beat of 0.3s on, 0.3s off for approximately 1 minute, named the cool down time. A new start up command will be executed after the cool down period only.



FixYourDLP.com

Sponsored by 

Discount-Merchant.com (800) 281-8860

THE TRUSTED SOURCE FOR PROJECTOR LAMPS AND ACCESSORIES



Discount-Merchant.com (800) 281-8860
THE TRUSTED SOURCE FOR PROJECTOR LAMPS AND ACCESSORIES

14. SWITCHING LINKED DISPLAYS TO AND OUT STANDBY

Overview

- Switching by means of the Cine VERSUM Master
- Direct Switching of the Linked Display

14.1 Switching by means of the Cine VERSUM Master

Overview

- Switching In/Out Standby using the Jog Dial
- Switching In/Out Standby using the Remote Control

14.1.1 Switching In/Out Standby using the Jog Dial

How to switch one or more displays To or Out standby mode

1. From the startup menu on the graphical display, press the jog dial to enter the main menu. (menu 14-1)
2. Scroll through the menu items until item INSTALLATION is pointed (menu 14-1).
3. Press the jog dial to confirm.

The INSTALLATION menu will open showing the available installation items. (menu 14-2)

4. Scroll through the menu items until item DISPLAY LIST is pointed (menu 14-2).
5. Press the jog dial to confirm.

The Display list menu opens showing the status of the linked displays, ON (operation), Standby or No display found (Display not powered up).

The name of the linked displays in the display list menu below are numbered 1, 2 up to 6 as example. Notice that each display in the chain can be renamed. (menu 14-3)

6. Select the display, whose status you want to change, by rotating the jog dial, e.g. Display 2 with status ON (menu 14-3).
7. Press the jog dial to confirm.

The Display settings menu opens showing the display setting items for that specific display. (menu 14-4)

8. Scroll through the menu items until item SWITCH OFF is pointed (menu 14-4).
9. Press the jog dial to confirm.

The selected display switches to the standby mode preceded by a message. Finally, the status of the Display 2 will change to 'Standby'. (menu 14-5)

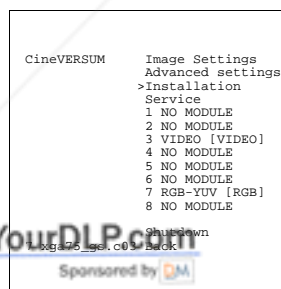

Menu 14-1

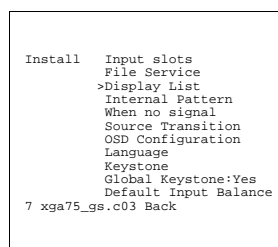

Menu 14-2

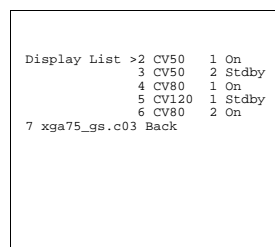

Menu 14-3

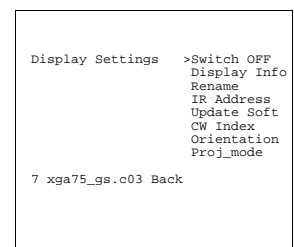

Menu 14-4

14. Switching linked displays To and Out Standby

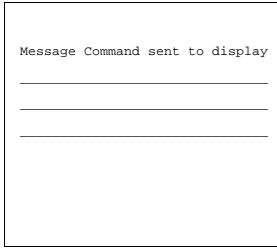

Menu 14-5

Recap

If the status of a display is On, via the display settings menu the display can be switched into the standby mode. If the status of a display is Standby, then the display can be switched to the operation mode.

14.1.2 Switching In/Out Standby using the Remote Control



Make sure the Remote Control suits the address of the Cine VERSUM Master or uses the common address.

How to switch one or more displays To or Out standby mode

1. Press the **ADJ** or **ENTER** key on the remote control to display the main menu on the screen. (menu 14-6)
2. Using the **↑** and **↓** arrow keys, scroll through the menu items until item 'Installation' is highlighted (menu 14-6).
3. Press **ENTER** key to confirm.
The installation menu opens, showing the different installation items. (menu 14-7)
4. Using the **↑** and **↓** arrow keys, scroll through the menu items until item 'Display list' is highlighted (menu 14-7).
The Display list menu opens, showing the linked displays. (menu 14-8)
5. Using the **↑** and **↓** arrow keys, select the display , whose status you want to change, e.g. Display 2 with status ON (menu 14-8).
6. Press **ENTER** to confirm.
The Display settings menu opens showing the display setting items for that specific display. (menu 14-9)
7. Scroll through the menu items, using the **↑** and **↓** arrow keys, until item Switch OFF is highlighted (menu 14-9).
8. Press **ENTER** to confirm.
The selected display switches to the standby mode preceded by a message. Finally, the status of the Display 2 will change to 'Standby'. (menu 14-10)



Menu 14-6

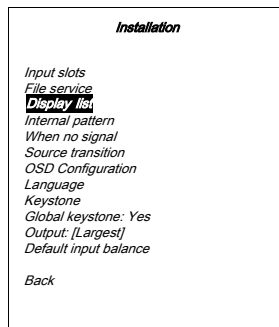

Menu 14-7

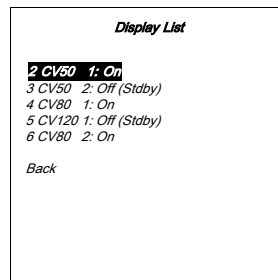

Menu 14-8

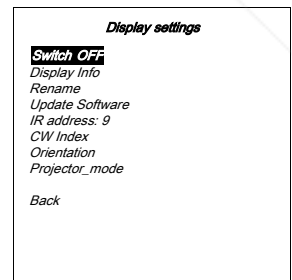

Menu 14-9

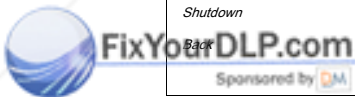

Discount-Merchant.com (800) 281-8860
THE TRUSTED SOURCE FOR PROJECTOR LAMPS AND ACCESSORIES



Menu 14-10

Recap

If the status of a display is On, via the display settings menu the display can be switched into the standby mode. If the status of a display is Standby, then the display can be switched to the operation mode.

For a display with status 'standby', counteracting these status can be made using the jog dial on the Cine VERSUM Master or via the on-screen of an active display.

14.2 Direct Switching of the Linked Display

14.2.1 Switching a specific display In/Out standby



Make sure the Remote Control suits the address of the display you desire to switch In or Out standby.

How to switch one or more displays To or Out standby mode

1. Program the Remote Control with the address of the display you desire to switch In or Out standby (Module Address Read out/Change, page 93).
2. Point the Remote Control to the respective display.
3. Press a few seconds the standby key on the Remote Control. (image 14-1)
The respective display switches into the standby mode.
4. Press a few seconds the standby key on the Remote Control again to restart operation.

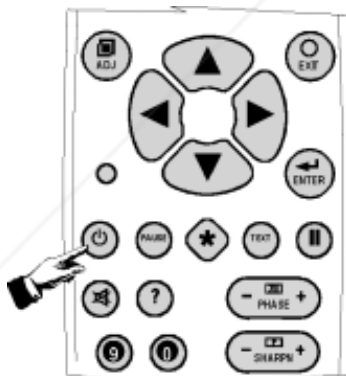

Image 14-1
Standby key



Discount-Merchant.com (800) 281-8860
THE TRUSTED SOURCE FOR PROJECTOR LAMPS AND ACCESSORIES



Discount-Merchant.com (800) 281-8860
THE TRUSTED SOURCE FOR PROJECTOR LAMPS AND ACCESSORIES

15. MODULE ADDRESS READ OUT/CHANGE

15.1 Default address of the Modules

Introduction

To allow separate remote access to the different modules, an individual address has to be stored in each module.

Overview default address modules

Each module leaves the factory with a default address:

| Module | Address |
|--------------------|---------|
| Cine VERSUM Master | 1 |
| Cine VERSUM 80 | 9 |
| Cine VERSUM 50 | 9 |
| Cine VERSUM 120 | 9 |

15.2 Reading out/Changing the stored addresses

Overview

- Reading out the stored address
- Changing the stored addresses

15.2.1 Reading out the stored address



Reading out the stored address of a module can be done using the address key on the Remote Control or via the Display settings menu.

Reading out the stored address using the Remote Control (inclusive Cine VERSUM Master)

1. Point the front of the Remote Control to the IR Receiver of the module you desire to read out the stored address.
2. Press the address key (accessible with the top of a pencil)(On InfraRed Remote Control, page 30).

A message, indicating the address number, appears as on screen message on the active display and also on the graphical display of the Cine VERSUM Master.

The messages below belong to the Cine VERSUM Master. When pointing the displays, similar messages are generated maybe with another address. (menu 15-1)

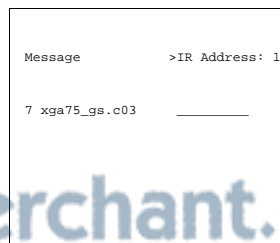

Menu 15-1

Menu 15-2

Reading out the stored address using Display setting menu (exclusive Cine VERSUM Master)

- Using the jog dial on the Cine VERSUM Master or the Remote control keys, successively selects Main menu, Installation and Display list.

The display list (On screen, menu 15-4; Graphical display, menu 15-3) sums up the linked displays. The display name is preceded by its address number. The address number can also be find in the display settings menu of the respective display (continue with step 2).

- Scroll through the display list until the display you desire to read out the address is highlighted (on screen) (menu 15-4) or pointed (graphical display) (menu 15-3).
- Press jog dial on Cine VERSUM Master or press **ENTER** on Remote Control to confirm.

The display settings of the selected display appear in the on screen menu (menu 15-6) and in the graphical display (menu 15-5), inclusive the IR address number.

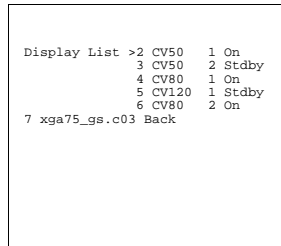

Menu 15-3

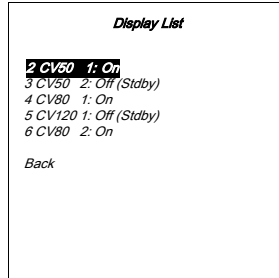

Menu 15-4

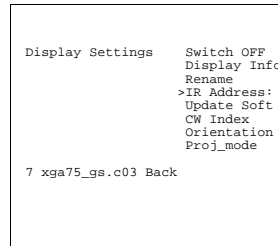

Menu 15-5

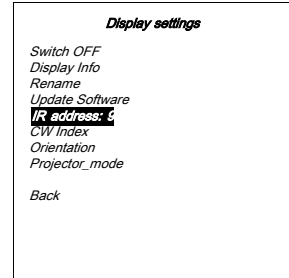

Menu 15-6

Reading out the stored address Cine VERSUM Master using Service menu

- Enter the GUI menu by pressing the jog dial on the Master or by pressing the **ENTER** key on the Remote Control.

The main menu appears on-screen and in the graphical display on the Master. (menu 15-7)

- Select item SERVICE by rotating the jog dial on the Master or by pressing the **↑** and **↓** key on the Remote Control.

The service menu opens including the item indicating the IR address of the Cine VERSUM Master. (menu 15-8)

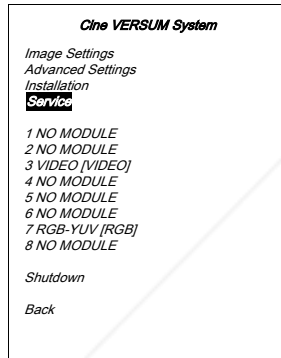

Menu 15-7

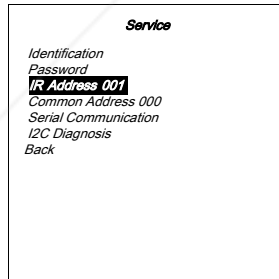

Menu 15-8

15.2.2 Changing the stored addresses

Example of address setting

In order to be able to control separately the displays by means of the Remote Control (e.g. operation and standby mode), an unique address has to be stored for each display separately.

FixYourProjector.com

Discount-Merchant.com (800) 281-8860

THE TRUSTED SOURCE FOR PROJECTOR LAMPS AND ACCESSORIES

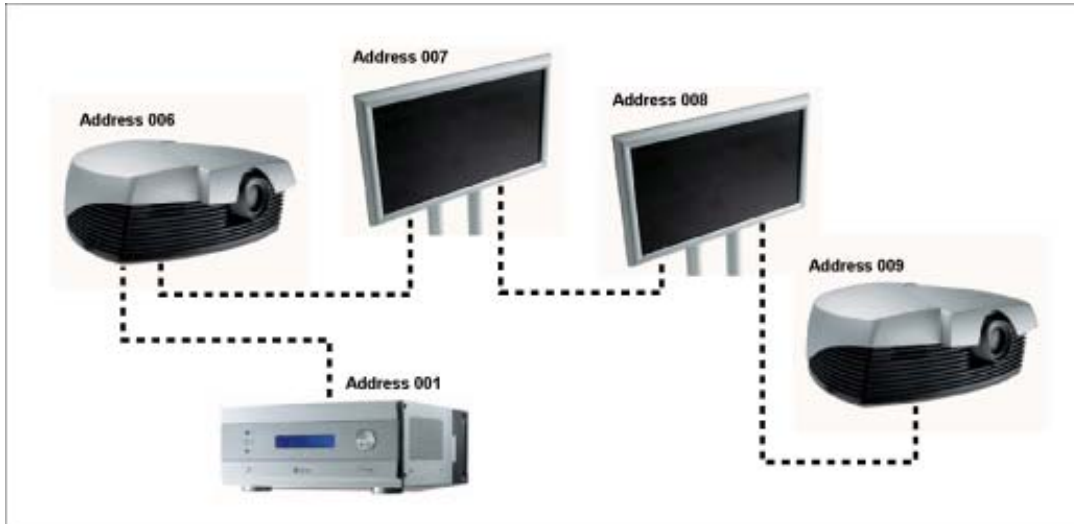

Image 15-1
Example of address set up

Changing the stored address of a linked display

1. Successively scroll through the menus Main (Cine VERSUM System), Installation, Display list.
2. Select in the display list the display you desire to change the address.
3. Press the jog dial or press **ENTER** to confirm.
The display settings menu for that specific display appears on the screen and on the graphical display.
4. Scroll through the display setting items, using the jog dial or up/down arrow keys on the Remote Control and select item IR address 001.
5. Press the jog dial or press **ENTER** to confirm.
A text box appears on the screen (menu 15-9) and in the graphical display (menu 15-10) requesting to enter a new 3 digit address value.
6. Enter a 3 digit number, from 000 to 256, using the number keys on the RCU.
Note: As the Remote Control can remote addresses from 000 to 009 only, it is recommended to use this range of addresses.



Menu 15-9

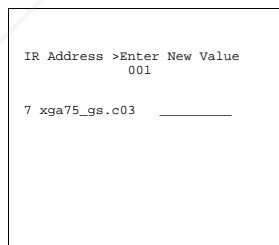

Menu 15-10

Changing the stored address of the Cine VERSUM Master

1. Successively scroll through the menus Main (Cine VERSUM System), Service.
2. Select in the Service list item IR Address 001
3. Press the jog dial or press **ENTER** to confirm.

A text box appears on the screen (menu 15-11) and in the graphical display (menu 15-12) requesting to enter a new 3 digit address value.

4. Enter a 3 digit number, from 000 to 256, using the number keys on the RCU.

Note: As the Remote Control can remote addresses from 000 to 009 only, it is recommended to use this range of addresses.

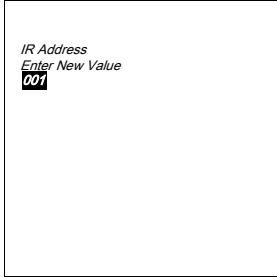

Menu 15-11

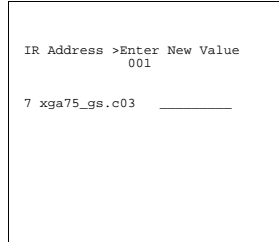

Menu 15-12

16. INPUT SOURCE FILE SERVICE

Overview

- About Stored files
- Loading a File
- Editing a File
- File identification
- Rename a file
- Copy a file
- Delete a file
- Delete all files
- File options

16.1 About Stored files

Cine VERSUM Master memory

The Master's memory contains a list of files corresponding to the most used sources. When the Master starts up (with active connected sources to the input modules), the input signals are scanned and compared with an already stored file. Mostly the result is a new custom file (linked to the input slot and e.g. differences in adjustments) for that input signal which is stored in the memory of the Master. If the automatic created file needs small corrections, the Edit file option allows to adjust the file.

If no stored file corresponds to the specs of the scanned input signal, a most corresponding file can be loaded for that input signal and then further edited to match the specs of the input signal.

How a file is coded

The stored file name includes 5 parts, e.g. bbbbbb.eee n pppppppi

| Part name | Description |
|-----------|---|
| bbbbbbb | Base name of the file (8 characters) e.g. vid625_2 |
| eee | File extension including: first character = C: custom made file first character = S: standard file second and third character: serial number (=file index) e.g. 05 |
| n | Input slot number e.g. 3 |
| pppppppp | Active pixel format e.g. 692x285 |
| i | blank: non interlaced file i: interlaced file |

16.2 Loading a File

How to select the FILE SERVICE menu

1. Press the selection wheel on the Master or the **ENTER** key on the Remote Control.

The Main menu appears on-screen and in the graphical display. (menu 16-1)

2. Select item INSTALLATION by rotating the selection wheel on the Master or the up/down arrow keys on the Remote Control (menu 16-1) and press to confirm.
3. Press the selection wheel on the Master or the key ENTER on the Remote Control to confirm.

The sub menu INSTALLATION appears on-screen and in the graphical display. (menu 16-2)

16. Input Source File Service

- Select item FILE SERVICE by rotating the selection wheel on the Master or the up/down arrow keys on the Remote Control (menu 16-2).
- Press the selection wheel on the Master or the key ENTER on the Remote Control to confirm.
The sub menu FILE SERVICE appears on-screen and in the graphical display. (menu 16-3)

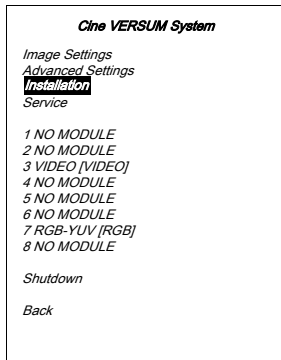

Menu 16-1

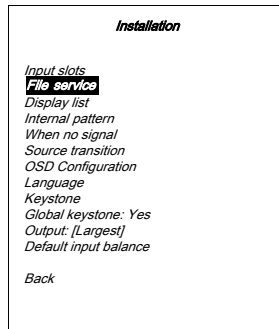

Menu 16-2

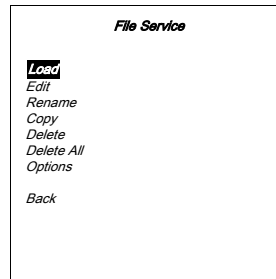

Menu 16-3

How to load a file

- Select item LOAD by rotating the selection wheel on the Master or the up/down arrow keys on the Remote Control (menu 16-3).
- Press the selection wheel on the Master or the key ENTER on the Remote Control to confirm.
The sub menu LOAD FILE appears on-screen and in the graphical display. This menu allows to choice between 2 lists, Matching files and All files.

| | |
|----------------------------|--|
| Matching Files (menu 16-5) | A list of the available files which fit the best the scanned input source. |
| All Files (menu 16-6) | A List of all available files (Stored and Custom files). (menu 16-4) |

- Select one of the two lists by rotating the selection wheel on the Master or the up/down arrow keys on the Remote Control.
- Press the selection wheel on the Master or the key ENTER on the Remote Control to confirm.
A list with all stored (S-files) and custom files (C-files) (depending the selected list) appears on-screen and in the graphical display. (menu 16-5)
- Select a file which matches the best the input source, by rotating the selection wheel on the Master or the up/down arrow keys on the Remote Control.
- Press the selection wheel on the Master or the key ENTER on the Remote Control to confirm. If the file doesn't match fully the specs of the input signal, proceed to editing the file in the EDIT FILE menu.

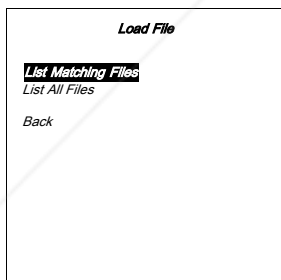

Menu 16-4

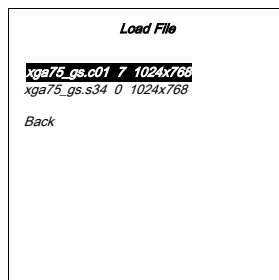

Menu 16-5

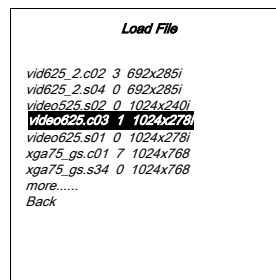

Menu 16-6



Discount-Merchant.com (800) 281-8860
THE TRUSTED SOURCE FOR PROJECTOR LAMPS AND ACCESSORIES

16.3 Editing a File

How to Edit a File

1. Select the FILE SERVICE menu (see "Loading a File", page 97)
2. Select item EDIT by rotating the selection wheel on the Master or the up/down arrow keys on the Remote Control.

The sub menu EDIT FILE (menu 16-7) appears on-screen and in the graphical display. This menu allows to choose between 2 lists, Active file and Select File.

| | |
|-------------|---|
| Active File | File associated to the selected input module. When selecting Active File, the editing menu opens for that file (menu 16-8). |
| Select File | When selected, a list of all files is displayed. The file you desire to edit must be selected (menu 16-9). menu 16-7) |

3. Attentively read the specifications of the connected source and next, proceed editing the different parameters. Overview of the active parameters, image 10-4

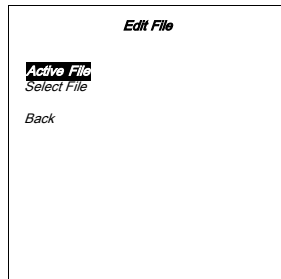

Menu 16-7

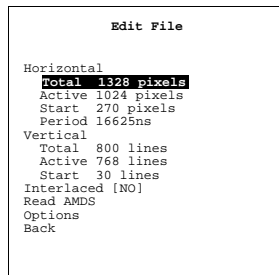

Menu 16-8

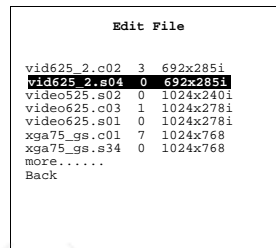

Menu 16-9

How adjusting the parameters

1. For a parameter associated to a barscale, rotate the selection wheel on the Master or press the left/right arrow keys on the Remote Control to increment or decrement the value. (image 16-1)
2. For a parameter associated to a value change, on the Master, rotate the selection wheel to increment or decrement the digit and press the wheel to jump between digits and with the Remote Control, press the respective digit keys consecutively. (image 16-2)
3. For an item with the parameter between brackets, toggle with the selection wheel on the Master or with the **ENTER** key on the Remote Control to change the parameter. (image 16-3)

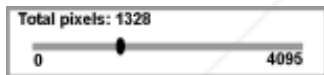

Image 16-1
Barscale

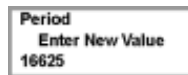

Image 16-2
Value change

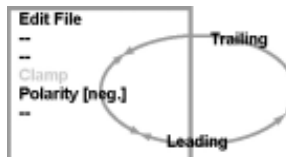

Image 16-3
Toggle function

16.4 File identification

How identifying the new selected source

When selecting the respective input slot with the new source, the horizontal period, the total number of vertical lines and the interlaced mode are automatically measured and filed in the menu table as a new custom file.



When editing a custom file, NEVER adjust the automatically measured values as they are used to identify the input source file when selecting.

DiscountMerchant.com (800) 281-8860
THE TRUSTED SOURCE FOR PROJECTOR LAMPS AND ACCESSORIES

Explanation of the Edit file menu items

| Menu Item | Explanation |
|--------------------------|---|
| Horizontal Total Pixels | If the value for 'Horizontal Total pixels' is wrong, sampling mistakes, small vertical bars will be seen in the image (Total numbers of pixels between 2 sync pulses is used to adjust the sampling rate). Select 'Total' and increase or decrease the pixel quantity for no bars in the image. (image 16-4) |
| Active pixels | The 'Active pixels' determine the width of the window on the screen. This value is normally given in the source specifications. If not, adjust until full image is displayed (no missing pixels). (image 16-4) |
| Horizontal start | This is the number of the pixels between the beginning of the input signal and the start of the video information in the signal. (image 16-4) |
| Horizontal Period | This is already filled in with the correct value at the time of the source identifying. |
| Vertical Total Lines | This is already filled in with the correct value at the time of the source identifying. |
| Active Lines | This is the number of horizontal lines determining the height of the projected image. This value is normally given in the specification of the source. If not, adjust until full image height is displayed (no missing lines). |
| Vertical Start | This is the number of the lines between the start of the input signal and the start of the image on the screen. |
| Interlaced [On] or [Off] | This selection is automatically filled at source identifying. If the image is wrong, due to wrong measurements, use the ENTER key to toggle between On and Off. (For interlaced images, 1 frame contains 2 fields). |
| Read AMDS | AMDS = Automatic Mode Detection & Synchronization Selecting AMDS and confirmed with ENTER , the system re-identify the input source. |

Explanation of the Edit file menu option items

| Option Item | Explanation |
|------------------|--|
| Source Number | The source number of a non-active source can be changed to any other source number. This makes it possible to create a file for future source numbers. |
| Clamp Position | Clamping determines the back level of the signal. The clamp pulse can be related to the leading or the trailing edge of the synchro pulse. Use the ENTER key to toggle between Leading and Trailing. (image 16-5) |
| Clamp Delay | The time between the leading edge of the clamp pulse and the locked edge of the synchro pulse. Can be any value between 0 and 255. Change the value by pushing the cursor key ↑ or ↓. (image 16-5) |
| Clamp Width | The width of the clamp pulse can be any value between 0 and 255. Change the value by pushing the cursor key ↑ or ↓. image 16-5) |
| Field Polarity | The field polarity function is used for interlaced images. Both rasters of the image could be shifted in a wrong way (double lines are visible in the image). This can be corrected by forcing the field polarity to Neg. or Pos. Use the ENTER key to toggle between Pos. and Neg. |
| Field Select | Default setting = [Both] The field select is only used for interlaced images. One frame of an interlaced image contains two fields, an even and an odd field. The choice exists to project [both] fields on the screen or only the [even] or [odd] field. This can be useful for 3D projection. Use the ENTER key to toggle between Both, Even and Odd. |
| Vertical Refresh | The way of updating the image information on the display panels. This item is not available for Pal-NTSC-Secam sources, and for that reason displayed in gray. - For sources with a vertical frequency up to 60 Hz: the vertical refresh rate is the same as the vertical frequency of the source. This is a necessity to project moving images without 'motion artifacts'. For stationary images with a vertical frequency up to 60 Hz, it is still possible to use asynchronous refresh. When loading Pal, Secam or NTSC-files, the synchronous mode is default for all other sources below 60 Hz, asynchronous mode is default. - For sources with a vertical frequency higher than 60 Hz: the vertical refresh is different than the vertical frequency of the source. Synchronous refresh cannot be used. |



Discount-M... THE TRUSTED SOURCE FOR... 3860... AND ACCESSORIES

| Option Item | Explanation |
|------------------------------------|---|
| Vertical Synchro Polarity | The vertical refresh can be synchronized with the leading or trailing sync edge. Default setting is [Leading]. Toggling to [Trailing] is only necessary for special applications where the trailing edge of the synchro signal has to be taken as a reference. Use the ENTER key to toggle between Leading and Trailing. |
| Film mode detection: [On] or [Off] | <p>Detects in the [on] mode if the source is film or video. Use the ENTER key to toggle between [on] or [off]</p> <p>When enabled, the hardware looks for telltale signs of 3:2 or 2:2 pull-down sequences. These are the result of converting cinema material recorded at 24 frames-per-second to the television frequencies of 60 or 50 interlaced fields per second respectively. When FILM conversion is detected, the original 24 frames-per-second are restored. This avoids de-interlacing artefacts, and results in a perfect artefact-free display. Note that in some cases (video clips, scrolling news stickers,...) FILM and VIDEO material are mixed on one screen. This may confuse the detector and cause it to go into FILM restoration mode. This will cause "jaggies" or motion artefacts. In such cases, disabling FILM mode processing is the best cure.</p> |
| Banner Protect: [On] or [Off] | <p>Only active when film mode detection is in the on position. Use the ENTER key to toggle between [on] or [off].</p> <p>FILM mode processing normally processes the entire display, but this may cause problems on sources where video and FILM content are mixed. One very common example is scrolling banners at the bottom of the screen (e.g. financial news). For those cases, the "banner protect" feature will force the bottom quarter of the screen to be always processed in VIDEO mode, regardless of the rest of the screen, which may be either video or FILM mode.</p> |

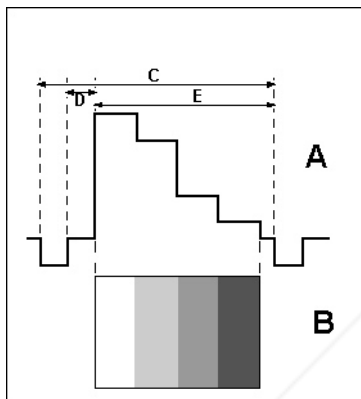

Image 16-4
Video pixels

- A Video Signal
- B Image
- C Total Pixels
- D Start Pixels
- E Active Pixels

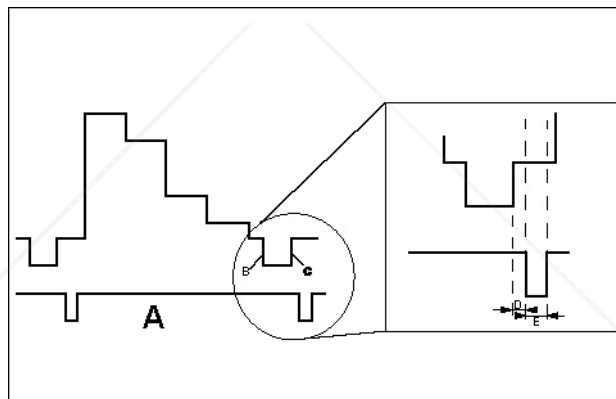

Image 16-5
Video clamping

- A Clamp signal
- B Leading edge sync signal
- C Trailing edge sync signal
- D Clamp pulse delay
- E Clamp pulse width



3:2 pull-down

Method used to map the 24 fps of film onto the 30 fps (60 fields) or 25 fps (50 fields), so that one film frame occupies three video fields, the next two, etc. It means the two fields of every other video frame come from different film frames making operations such as rotoscoping impossible, and requiring care in editing. Some sophisticated equipment can unravel the 3:2 sequence to allow frame-by-frame treatment and subsequently re-compose 3:2. The 3:2 sequence repeats every five video frames and four film frames, the latter identified as A-D. Only film frame A is fully on a video frame and so exists at one time code only, making it the editable point of the video sequence.



2:2 pull-down

The process of transferring 24-frames/sec film format into video by repeating each frame (used for PAL DVD's) as two video fields. (AD)



Artefacts

Undesirable elements or defects in a video picture. These may occur naturally in the video process and must be eliminated in order to achieve a high-quality picture. Most common in analog are cross color and cross luminance. Most common in digital are macroblocks, which resemble pixelation of the video image.

16.5 Rename a file

How to rename a file

1. Select the FILE SERVICE menu (Loading a File, page 97).
2. Select item RENAME by rotating the selection wheel on the Master or the ↑ or ↓ keys on the Remote Control.
The sub menu RENAME FILE (menu 16-10) appears on-screen and in the graphical display, including a list of all stored customer files.
3. Select the file whose name you desire to change by rotating the selection wheel on the Master or the ↑ or ↓ arrow keys on the Remote Control.
4. Press the selection wheel on the Master or the key ENTER on the Remote Control to confirm.
The selected file name, only the section file name with extension (extension is unchangeable), is displayed in the menu box RENAME FILE, requesting to enter new values. The first character is highlighted and can be changed. (menu 16-11)
5. Continue with changing the 8 characters consecutively as follows:
 - Pressing the cursor keys ← or → on the Remote Control or pressing the selection wheel on the Master allows to select the character position.
 - Pressing the cursor keys ↑ or ↓ on the Remote Control or rotating the selection wheel on the Master allows to change the character (Numeric characters can be entered remotely with the numeric keys).
6. When the last character of the file name has been entered, a message box pops up, confirming saving data.
The message box disappears after a few seconds. (menu 16-12)

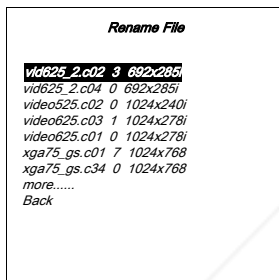

Menu 16-10

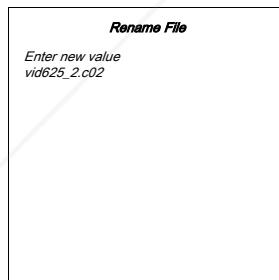

Menu 16-11

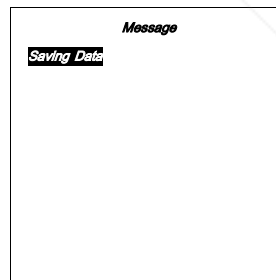

Menu 16-12

16.6 Copy a file

How to copy a file

1. Select the FILE SERVICE menu (see "Loading a File", page 97)
2. Select item COPY by rotating the selection wheel on the Master or the ↑ or ↓ keys on the Remote Control
The sub menu COPY FILE (menu 16-13) appears on-screen and in the graphical display, including a list of all stored customer and standard files.
3. Select the file you desire to copy by rotating the selection wheel on the Master or the ↑ or ↓ keys on the Remote Control.
4. Press the selection wheel on the Master or the key ENTER on the Remote Control to confirm
The menu box COPY FILE, requesting to enter new values (=file name) appears on-screen and in the graphical display . The first character is highlighted and can be filled in. (menu 16-14)

FixYourDLP.com
Discount-Merchant.com (800) 281-8860
THE THINGS YOU WANT TO BUY AT DISCOUNT PRICES ARE HERE

5. Continue with filling in the other characters consecutively as follows:
 - Pressing the cursor keys ↑ or ↓ on the Remote Control or rotating the selection wheel on the Master allows to select the characters.
 - Pressing the cursor keys ← or → on the Remote Control or pressing the selection wheel on the Master allows to change the character (Numeric characters can be entered remotely with the numeric keys).
6. At the end of the file name, a message box pops up, asking to confirm saving data. Press the key ENTER on the Remote Control or press the selection wheel on the master to confirm. (menu 16-15)

The message box disappears and the new file name is stored WITH A NEW INDEX.

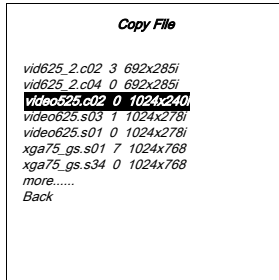

Menu 16-13

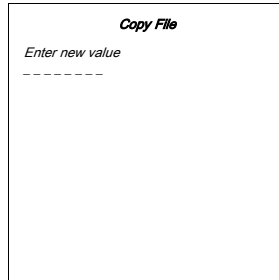

Menu 16-14

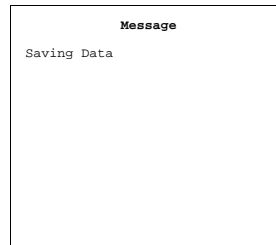

Menu 16-15

16.7 Delete a file

How to delete a file

1. Select the FILE SERVICE menu (see "Loading a File", page 97)
2. Select item DELETE by rotating the selection wheel on the Master or the ↑ or ↓ keys on the Remote Control
The sub menu DELETE FILE (menu 16-16) appears on-screen and in the graphical display, including a list of all stored customer files.
3. Select the file you desire to delete (Attention: the active file cannot be deleted) by rotating the selection wheel on the Master or the ↑ or ↓ keys on the Remote Control.
4. Press the selection wheel on the Master or the key ENTER on the Remote Control to delete the file (Attention: there is no confirmation request).

The file is removed from the file list.

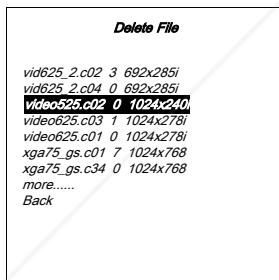

Menu 16-16

16.8 Delete all files

How to delete ALL files

1. Select the FILE SERVICE menu (see "Loading a File", page 97)
2. Select item DELETE ALL by rotating the selection wheel on the Master or the ↑ or ↓ keys on the Remote Control.
A confirmation request menu appears on-screen and in the graphical display. (menu 16-17)
3. Select menu item Yes or No, and press ENTER on the Remote Control or press the selection wheel on the Master to confirm:

| Menu item | Result |
|-----------|--|
| No | System returns to FILE SERVICE menu. |
| YES | ALL CUSTOMER files will be deleted, except the active file. The system returns to the FILE SERVICE menu. |

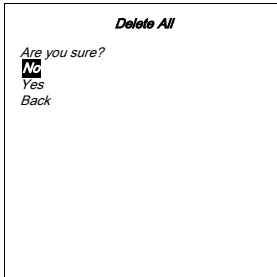

Menu 16-17

16.9 File options

Setting the system for File Load and File Sort

In the FILE OPTION from the FILE SERVICE menu, the way of sorting the files and file loading for new sources can be defined.

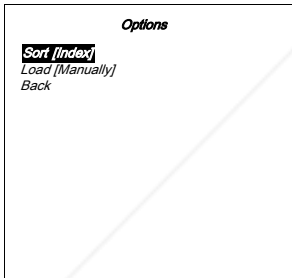

Menu 16-18

| File sort | Result |
|-----------|---|
| [Name] | The files in the list will be sorted on the file name. |
| [Index] | The files in the list will be sorted on the file extension. |

| File Load | Result |
|-------------|--|
| [Automatic] | Correct file will be loaded automatically. |
| [Manually] | Correct file has to be loaded manually. |

17. ADJUSTING THE PICTURE

Overview

- Setup Video and RGB module for the input signal type
- Adjusting the Image Orientation
- Adjusting the Image Aspect Ratio
- Adjusting the Decoding Standard
- White Peak Set up
- Keystone Correction
- Adjusting the Image Shift and Size
- Outline the displayed Image (Blanking)
- Alignment of the Input Balance
- Phase adjustment for Computer signals
- Gamma Correction
- Adjusting the Color Temperature
- Adjusting the Picture Controls

17.1 Setup Video and RGB module for the input signal type

Introduction

After the signal sources have been connected to the respective modules, the input signal type of the Video and RGB module has to be setup.

| Module | Signal Type 1 | Signal Type 2 | Signal Type 3 |
|---------|-----------------|-------------------|---------------|
| Video | Composite Video | YUV (standard) | S-Video |
| RGB-YUV | RGB | YUV (progressive) | |

How to setup the input mode

1. Press the jog dial on the Master or the **ADJ** key on the Remote Control.
The Main menu appears on-screen and in the graphical display. (menu 17-1)
2. Select item INSTALLATION by rotating the jog dial on the Master or the up/down arrow keys on the Remote Control (menu 17-1).
3. Press the jog dial on the Master or the key **ENTER** on the Remote Control to confirm.
The sub menu INSTALLATION appears on-screen and in the graphical display. (menu 17-2)
4. Select item INPUT SLOTS by rotating the jog dial on the Master or the up/down arrow keys on the Remote Control (see menus in step 1).
5. Press the jog dial on the Master or the key **ENTER** on the Remote Control to confirm.
The Input slots menu appears on-screen and in the graphical display showing the kind of inserted module in the respective slots, and for the Video and the RGB module the signal type setup placed between brackets. (menu 17-3)
6. Select, by rotating the jog dial on the Master or the up/down arrow keys on the Remote Control, the Input slot you desire to change the signal input setting (see menus in step 3).
7. Toggle by pressing the jog dial on the Master or the **ENTER** key on the Remote Control until the correct input type appears between brackets.

17. Adjusting the Picture

8. Repeat the same action for all installed Video and RGB modules.
9. Leave the GUI menus:
 - Using the jog dial on the Master: scroll in the menu to the bottom until item 'Back' is pointed and press to confirm. Repeat the same action if necessary.
 - Using the Remote Control: press the **EXIT** key to leave the menus consecutively or press the **ADJ** key to leave the menus at once.

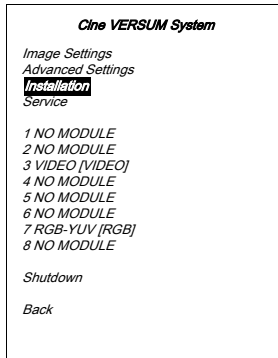

Menu 17-1

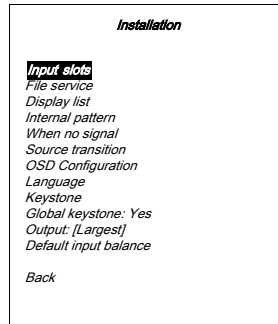

Menu 17-2

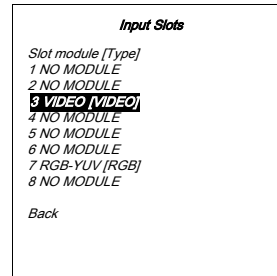

Menu 17-3

17.2 Adjusting the Image Orientation



Image orientation set up is applicable on the Cine VERSUM 80 and on the Cine VERSUM 120 only.

How to adjust the image orientation

Depending on the projector mounting, the orientation of the displayed image has to be corrected. This function is available for projector display only.

1. Enter the INSTALLATION menu (Setup Video and RGB module for the input signal type, page 105).
2. Select item DISPLAY LIST by rotating the jog dial on the Master or the up/down arrow keys on the Remote Control. (menu 17-4)
3. Press the jog dial on the Master or the key **ENTER** on the Remote Control to confirm.

The Display List menu appears on-screen and in the graphical display showing the detected displays, inclusive address number, display name (can be renamed) and status. (menu 17-5)

4. Select the projector you have to correct the image orientation by rotating the jog dial on the Master or the up/down arrow keys on the Remote Control.
5. Press the jog dial on the Master or the key **ENTER** on the Remote Control to confirm.

The Display Settings menu for that particular display appears on-screen and in the graphical display showing the specific items for the selected display (is different for Plasma and Projector display). (menu 17-6)

6. Select item ORIENTATION by rotating the jog dial on the Master or the up/down arrow keys on the Remote Control.
7. Press the jog dial on the Master or the key **ENTER** on the Remote Control to confirm.

The Orientation menu appears on-screen and in the graphical display showing the 4 possible mounting configurations. (menu 17-7)

8. Select the Orientation item which suit the projector mounting by rotating the jog dial on the Master or the up/down arrow keys on the Remote Control.
9. Press the jog dial on the Master or the key **ENTER** on the Remote Control to confirm.

The projector fits to the selected image orientation and the system returns to operation automatically after a few seconds. (image 17-1)

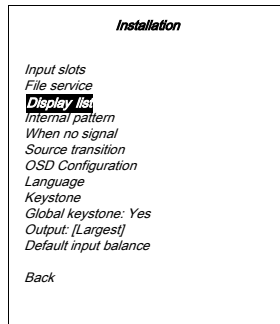

Menu 17-4

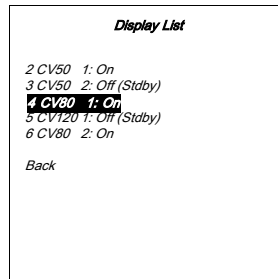

Menu 17-5

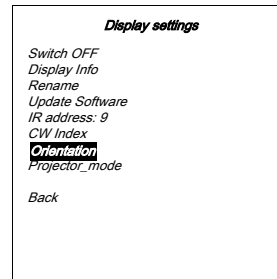

Menu 17-6

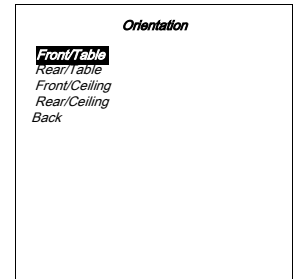

Menu 17-7

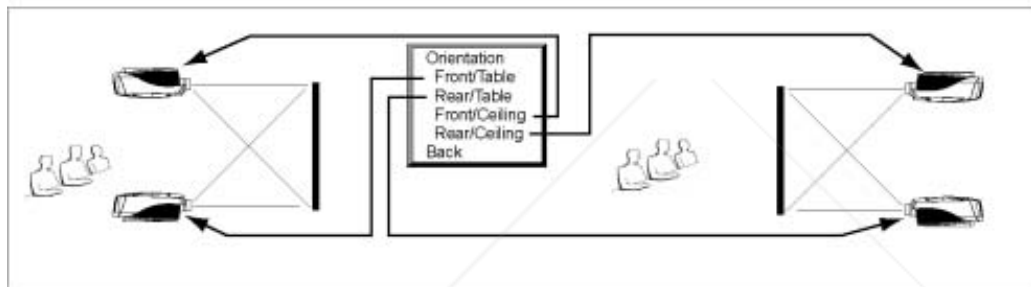

Image 17-1
Image orientation adjustment

17.3 Adjusting the Image Aspect Ratio

How to adjust the image Aspect Ratio

This function allows you to modify or customize the image display mode to enhance the input image.

1. Press the jog dial on the Master or the **ADJ** key on the Remote Control.
The Main menu appears on-screen and in the graphical display. (menu 17-8)
2. Select item **ADVANCED SETTINGS** by rotating the jog dial on the Master or the up/down arrow keys on the Remote Control (menu 17-8).
3. Press the jog dial on the Master or the key **ENTER** on the Remote Control to confirm.
The sub menu **ADVANCED SETTINGS** appears on-screen and in the graphical display. (menu 17-9)
4. Select item **ASPECT RATIO** by rotating the jog dial on the Master or the up/down arrow keys on the Remote Control.

17. Adjusting the Picture

5. Press the jog dial on the Master or the key **ENTER** on the Remote Control to confirm.

The sub menu ASPECT RATIO appears on-screen and in the graphical display, including all available aspect ratios. (menu 17-10)

Explanation

| Aspect Ratio | Description |
|--------------|--|
| Fit | Forces format of all input signals into the native panel resolution. |
| 16:9 | Wide screen television format/Anamorf format. |
| 4:3 | Standard television format. |
| 5:4 | Workstations format. |
| 2.35 | Panavision or Cinemascope format, frequently used by Hollywood films. |
| 1.88 | Film format used by a lot of non-action films. |
| 1.78 | Wide screen television format/Anamorf format. |
| Letterbox | Forces the letter format of the input signal into the native panel resolution. |

6. Select the desired ASPECT RATIO (depending the image format of the input source) item by rotating the jog dial on the Master or the up/down arrow keys on the Remote Control and press respectively the jog dial on the Master of key **ENTER** on the Remote Control to confirm. (image 17-2)

7. Press the jog dial on the Master or the key **ENTER** on the Remote Control to confirm.

Image of the input signal is displayed in the selected format. If item FIT is selected, then the image format of the selected input source is forced into the native panel resolution, with or without loss of image contents.

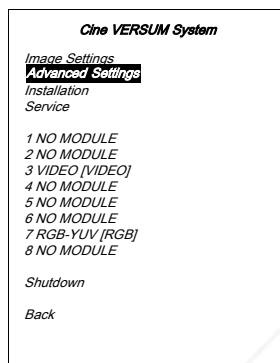

Menu 17-8

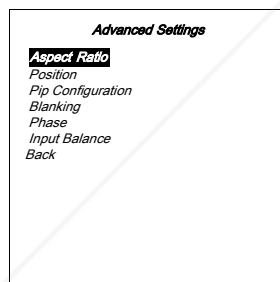

Menu 17-9

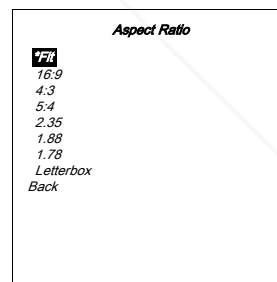

Menu 17-10

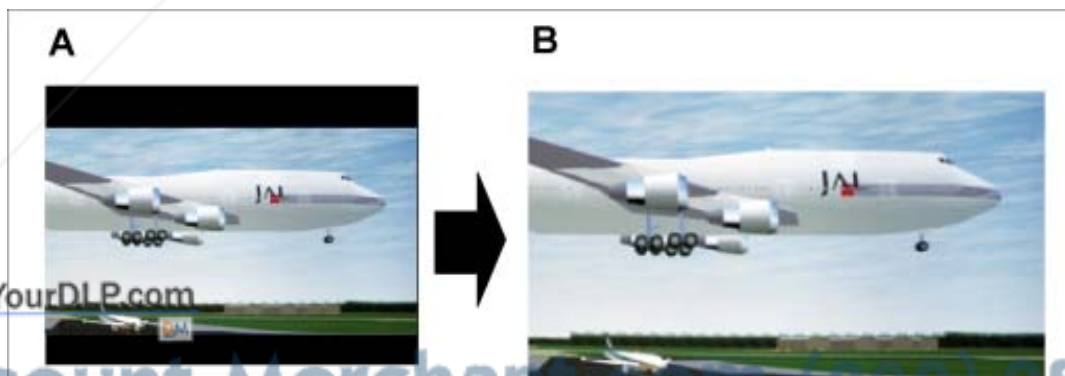

Image 17-2

- A Letterbox format input signal
 B Conversion to native panel resolution

17.4 Adjusting the Decoding Standard

About Decoding Standard

The possibility is offered to decode the NTSC video signals via the default American IRE standard (Decoding a NTSC signal using the European EBU standard may result in a greenish tint.) and the PAL/SECAM video signals via the European EBU standard.

When the PROJECTOR standard has been chosen, then, video signals are decoded based on the installed Color Parameters.



Choice of the color decoding standard is applicable on the Cine VERSUM 80 and Cine VERSUM 120 only.

Where to select the color decoding

1. Enter the MAIN menu and scroll through the sub menus, using the jog dial or the Remote Control until the Image Settings menu is displayed. (image 17-3)
2. Select item *PRIMARIES* by rotating the jog dial on the Master or the up/down arrow keys on the Remote Control.
3. Press the jog dial on the Master or the **ENTER** key on the Remote Control to select the desired standard, indicated between brackets.
4. To leave the GUI, use the item *BACK* in the menus or the **EXIT** key on the Remote Control.

Main Menu/ Image Settings /Display/ CV80 or CV120 / Primaries

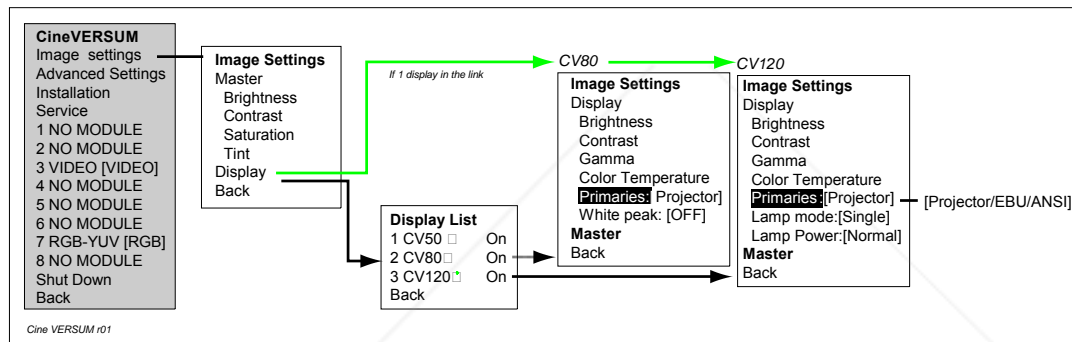

Image 17-3
Color standard selection

17.5 White Peak Set up

About White Peak

In video centric applications true color reproduction is generally a priority over brightness. To achieve this a typical design will not utilize a white segment. This has the side effect of reducing the amount of light allowed through the color wheel, which reduces the overall brightness. To compensate for this a technique can be applied called Spoke Light Capture (SLR).

The spokes are defined to be the time between colors. The DMD is normally kept in the "off" state during this time preventing any light from getting to the screen. If the light is passed through the spokes, the average over time across them is made up of a mixture of the two adjacent colors. This will result in a secondary color. If these spokes are taken three at a time, over time they will sum up to white light. This "virtual white segment" is the basic principal of SLR and can yield a substantial boost to system brightness.

Where to set up the white Peak

1. Enter the MAIN menu and scroll through the sub menus, using the jog dial or the Remote Control until the Image Settings menu is displayed. (image 17-4)
2. Select item *WHITE PEAK* by rotating the jog dial on the Master or the up/down arrow keys on the Remote Control.
3. Press the jog dial on the Master or the **ENTER** key on the Remote Control to enable (On) or disable (Off) the white peak feature, status indicated between brackets.
4. To leave the GUI, use the item *BACK* in the menus or the **EXIT** key on the Remote Control.

Main Menu/ Image Settings /Display/ CV80 or CV120 / Primaries

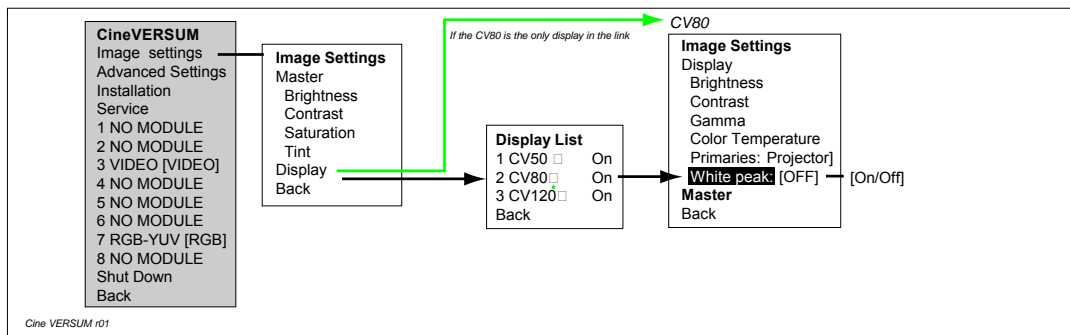

Image 17-4
White peak set up

17.6 Keystone Correction



Keystone correction set up is applicable on the Cine VERSUM 80 and on the Cine VERSUM 120 only.

Overview

- Setting the Keystone correction: Global or on a File
- Applying the Keystone correction

About Keystone correction

In case of an inclined projector mounting, side keystone correction has to be applied to the displayed picture.



Straight lines and the edges of the displayed image may appear jagged, when adjusting the Keystone setting.

The Installation menu includes the items KEYSTONE and GLOBAL KEYSTONE Yes/No. The latter allows to define if keystone correction may be applied to ALL files (Yes) or only to the active file (No).



Matching to the file on the respective input slots 1 to 8, an additional file is created on the corresponding input slot numbers, 91 to 98. Both matching files can contain different settings.

17.6.1 Setting the Keystone correction: Global or on a File

How to set the Keystone correction

1. Press the jog dial on the Master or the **ADJ** key on the Remote Control.
The Main menu appears on-screen and in the graphical display. (menu 17-11)
2. Select item **INSTALLATION** by rotating the jog dial on the Master or the up/down arrow keys on the Remote Control (menu 17-11) and press to confirm.
3. Press the jog dial on the Master or the key **ENTER** on the Remote Control to confirm.
The sub menu **INSTALLATION** appears on-screen and in the graphical display. (menu 17-12)

4. Select item GLOBAL KEYSTONE: YES by rotating the jog dial on the Master or the up/down arrow keys on the Remote Control (menu 17-12).
5. Set Global Keystone to Yes or to No, using the jog dial on the Master or the key **ENTER** on the Remote Control as toggle switch.
 - Confirmation YES: Keystone correction will be applied to ALL files.
 - Confirmation NO: keystone correction will be applied to the ACTIVE file.

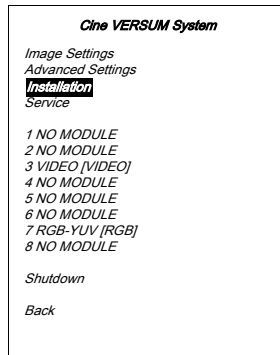

Menu 17-11

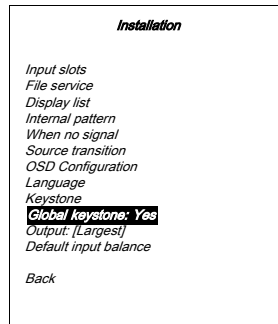

Menu 17-12

17.6.2 Applying the Keystone correction

How to adjust Keystone correction

1. Select item KEYSTONE by rotating the jog dial on the Master or the up/down arrow keys on the Remote Control. (menu 17-13)
2. Press the jog dial on the Master or the key **ENTER** on the Remote Control to confirm.

A bar scale with zero point appears on-screen and in the graphical display of the Master. (image 17-5)
3. Adjust the Keystone
 - With the Remote Control: press the ← and → key to adjust the Keystone correction.
 - With the jog dial on the Master: rotate the jog dial to the left or to the right to adjust the Keystone correction.
4. Press **EXIT** on the Remote Control or press the jog dial on the Master to return.

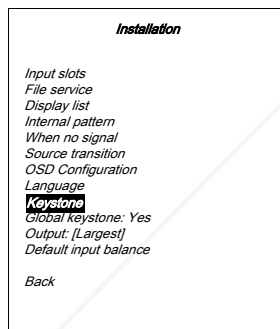

Menu 17-13

Image 17-5
Keystone correction

17.7 Adjusting the Image Shift and Size

Overview

- Adjusting the Image Shift
- Adjusting the Image Size

17.7.1 Adjusting the Image Shift

How to adjust the Vertical and Horizontal image shift

1. Select the **ADVANCED SETTINGS** menu (menu 17-8).
2. Select item **POSITION** by rotating the jog dial on the Master or the up/down arrow keys on the Remote Control. (menu 17-14)
3. Press the jog dial on the Master or the key **ENTER** on the Remote Control to confirm.
The sub menu **POSITION** appears on-screen and in the graphical display. This menu contains the items Vertical and Horizontal shift and size. (menu 17-15)
4. Select the **SHIFT** item, horizontal or vertical, you desire to adjust by rotating the jog dial on the Master or the up/down arrow keys on the Remote Control.
5. Press the jog dial on the Master or the key **ENTER** on the Remote Control to confirm.
A bar scale with zero point appears on-screen and in the graphical display of the Master. (image 17-6)
6. Adjust the shift:
 - With the Remote Control: press the ← or → key to adjust the shift level.
 - With the jog dial on the Master: rotate the jog dial to the left or to the right.
7. Press **EXIT** on the Remote Control or press the jog dial on the Master to return.

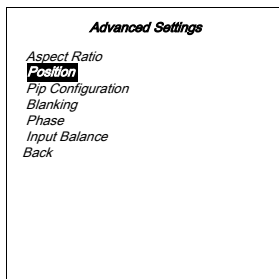

Menu 17-14

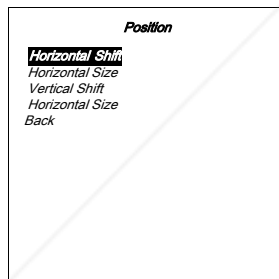

Menu 17-15

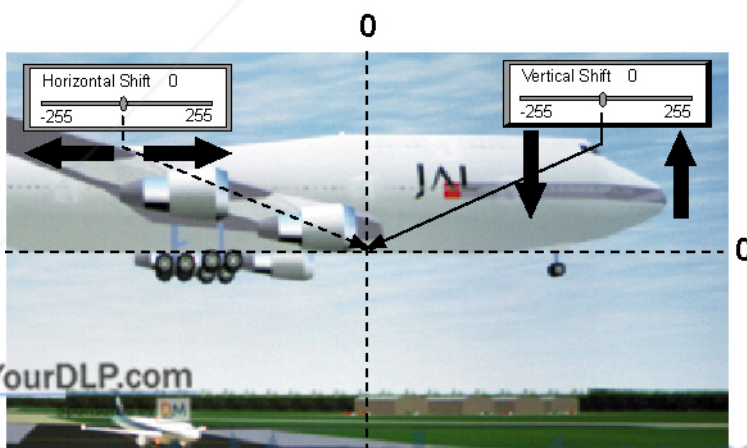
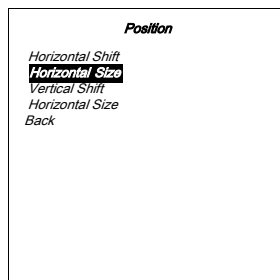

Image 17-6
Picture shift adjustment

17.7.2 Adjusting the Image Size

How to adjust the Vertical and Horizontal image size

1. Select sub menu POSITION (Adjusting the Image Shift, page 112)
2. Select the SIZE item, vertical or horizontal, you desire to adjust by rotating the selection wheel on the Master or the up/down arrow keys on the Remote Control. (menu 17-16)
3. Press the selection wheel on the Master or the key ENTER on the Remote Control to confirm.
A barscale with zero point appears on-screen and in the graphical display of the Master. (image 17-7)
4. Adjust the size:
 - With the Remote Control: press the ← or → key to adjust the shift level.
 - With the selection wheel on the Master: rotate the wheel to the left or to the right.
5. Press **EXIT** on the Remote Control or press the selection wheel on the Master to return.

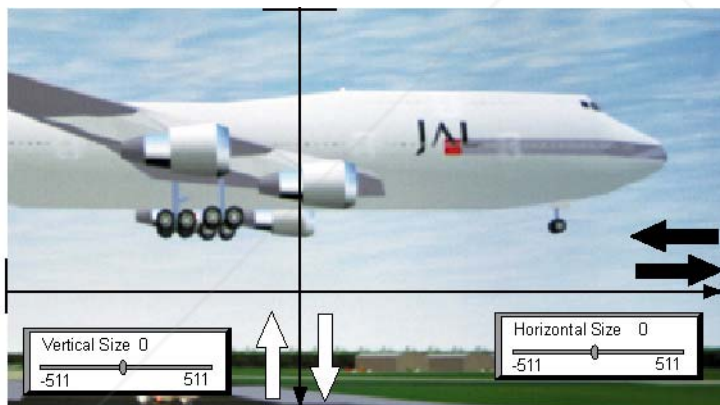

Menu 17-16

Image 17-7
Picture size adjustment

17.8 Outline the displayed Image (Blanking)

How to outline the displayed image

Undesired information at the borders of the displayed image can be removed with the blanking adjustment. Follow next steps:

1. Select the ADVANCED SETTINGS menu (menu 17-8).
2. Select item BLANKING by rotating the jog dial on the Master or the up/down arrow keys on the Remote Control.
3. Press the jog dial on the Master or the key **ENTER** on the Remote Control to confirm.
The sub menu BLANKING appears on-screen and in the graphical display. This menu contains the items Top/Bottom and Left/Right blanking. (menu 17-17)
4. Select the side of the image you desire to apply blanking by rotating the jog dial on the Master or the up/down arrow keys on the Remote Control.
5. Press the jog dial on the Master or the key **ENTER** on the Remote Control to confirm.
The corresponding bar scale appears on-screen and in the graphical display of the Master. (image 17-8)

17. Adjusting the Picture

6. Adjust the blanking:
 - With the Remote Control: press the ← or → key to adjust the blanking level.
 - With the jog dial on the Master: rotate the jog dial to the left or to the right.
7. Press **EXIT** on the Remote Control or press the jog dial on the Master to return.

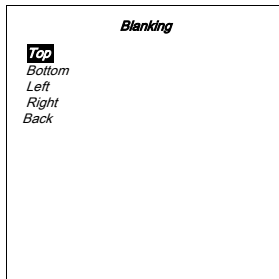

Menu 17-17

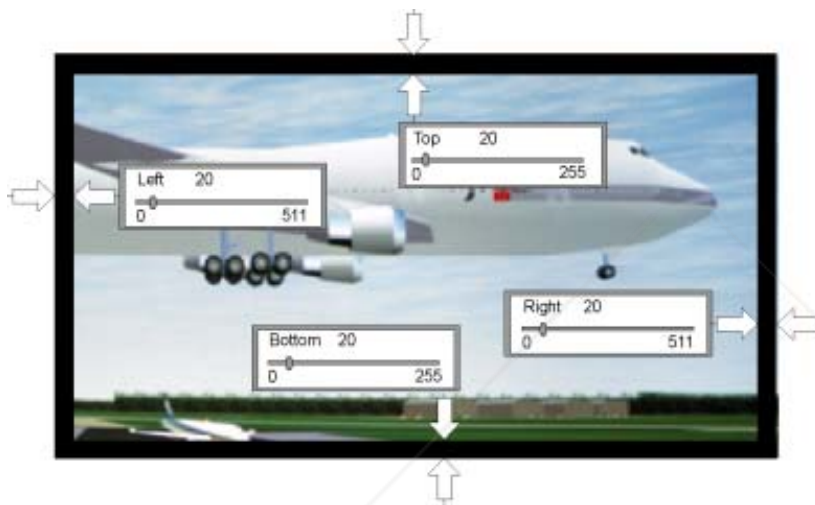

Image 17-8
Blanking adjustment

17.9 Alignment of the Input Balance

Overview

- Input Balance Selection
- Input Balance Adjustment

About the Input Balance alignment

Two kind of input balance alignments, ONLY APPLICABLE on RGB/YUV input signals, can be find in the menu structure, one named 'Default Input Balance' (classified in the Installation menu) and the other named 'Input Balance' (classified in the Advanced settings menu).

FixYourDLP.com
Sponsored by DM
Installation
Input slots
File service
Display list
Internal pattern
When no signal
Source transition
OSD Configuration
Language
Keystone
Global keystone: Yes
Output: (Largest)
Default input balance
Back

Menu 17-18

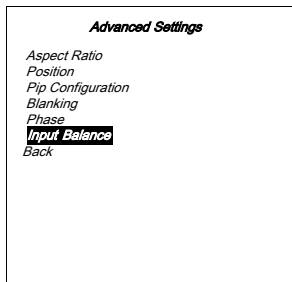

Menu 17-19

The 'Default Input Balance' is used to align the input balance of the different modules referring to standard input signals.



As standard input signals are required for the alignment of the Default Input Balance, this alignment has to be consider as FACTORY ALIGNED. Attempting to align the Default Input Balance can have serious consequences on the image performances. For that reason, the Default Input Balance adjustment has been made inaccessible.

Due to the signal distribution or the signal transmissions, a color imbalance can occurs. To allow the customer to be able to correct the imbalance per file, the alignment 'Input Balance', situated in the menu Advanced Settings, has been provided.

Observe the image on color dominance in the black and white areas of the displayed picture. If color dominance has been observed in one of the areas or in both, then proceed to the corresponding input balance adjustment.



Adjust the Color Saturation level to zero before starting the Input Balance adjustment.

17.9.1 Input Balance Selection

How to select the Input Balance

1. Check if the active source (File) is a RGB or YUV input signal.
2. Select the ADVANCED SETTINGS menu (menu 17-8).
3. Select item INPUT BALANCE by rotating the jog dial on the Master or the up/down arrow keys on the Remote Control (menu 17-19).
4. Press the jog dial on the Master or the key **ENTER** on the Remote Control to confirm.

The sub menu INPUT BALANCE appears on-screen and in the graphical display. This menu contains the items White and Black balance, as well as the return to the Factory settings. (menu 17-20)

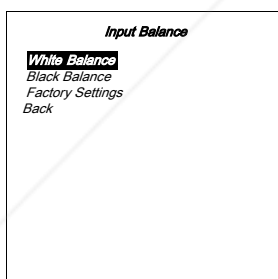

Menu 17-20

After changing the Input Balance, a return to the factory settings can be obtained by selecting the item FACTORY SETTINGS in the Input balance menu, followed by a confirmation.



17.9.2 Input Balance Adjustment

How to adjust the Input Balance

Always start with the Black balance adjustment if a dominant color has been observed in both areas.

1. Select in the Input Balance menu item BLACK BALANCE and confirm.

A sub menu appears on-screen and in the graphical display, showing the adjustable items Black Level RED and BLUE. (menu 17-21)

2. Select, depending the color dominant, in the Black Balance menu item BLACK LEVEL RED or Blue and confirm. If necessary apply the adjustment for both colors.

The corresponding bar scale appears on-screen and in the graphical display of the Master. (image 17-9)

3. Adjust the Black level:

- With the Remote Control: press the ← and → key to increase or decrease the color level.
- With the jog dial on the Master: rotate the jog dial to the left or to the right to increase or decrease the color level.

4. Press **EXIT** on the Remote Control or press the jog dial on the Master to return.

5. Select in the Input Balance menu item WHITE BALANCE and confirm.

A sub menu appears on-screen and in the graphical display, showing the adjustable items Gain RED and BLUE. (menu 17-22)

6. Select, depending the color dominant, in the White Balance menu item GAIN RED or Blue and confirm. If necessary apply the adjustment for both colors.

The corresponding bar scale appears on-screen and in the graphical display of the Master (image 17-9).

7. Adjust the Gain level:

- With the Remote Control: press the ← and → key to increase or decrease the color gain.
- With the jog dial on the Master: rotate the jog dial to the left or to the right to increase or decrease the color gain.

8. Press **EXIT** on the Remote Control or press the jog dial on the Master to return.

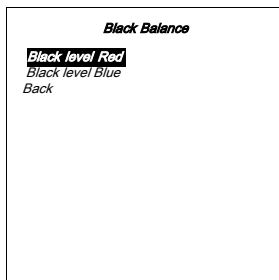

Menu 17-21

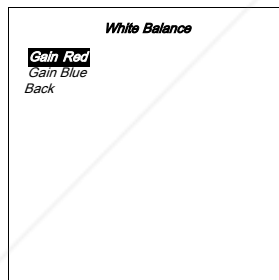

Menu 17-22

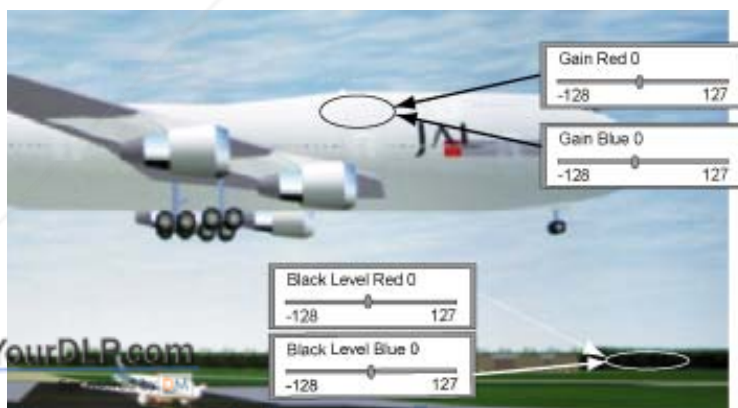

Image 17-9
Input balance adjustment

17.10 Phase adjustment for Computer signals

About Phase adjustment

When displaying computer patterns or graphics which are very detailed (tilting, vertical stripes, etc..) jitter in picture (missampling) may occur, causing horizontal stripes in portions of the screen. Should this occur, adjust 'Phase' for optimum computer image.

How to adjust the Phase

1. Check if the active source (File) is a RGB or YUV input signal.
2. Select the ADVANCED SETTINGS menu (menu 17-8).
3. Select item PHASE by rotating the jog dial on the Master or the up/down arrow keys on the Remote Control. (menu 17-23)
4. Press the jog dial on the Master or the key **ENTER** on the Remote Control to confirm.

The corresponding bar scale appears on-screen and in the graphical display of the Master. (image 17-10)

5. Adjust the Phase:

- With the Remote Control: press the ← and → key to refine the jitter.
- With the jog dial on the Master: rotate the jog dial to the left or to the right to refine the jitter.

Note: Don't mix up with wrong number of total pixels. If the jitter doesn't disappear with the phase adjustment, check the total number of pixels. (Best image = pixel on pixel off pattern. For example: shut down screen of a PC)

6. Press **EXIT** on the Remote Control or press the jog dial on the Master to return.

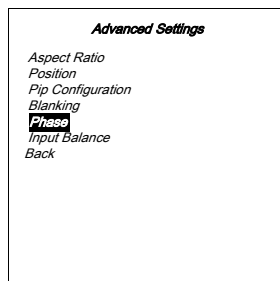

Menu 17-23



Image 17-10

17.11 Gamma Correction

Gamma Correction

Gamma is an image quality enhancement function that offers a richer image by brightening the darker portions of the image without altering the brightness of the brighter portions.



Gamma correction as well as Color Temperature set up are available (= appears in the on-screen menu and graphical display) **ONLY** when the display is remotely addressed with its unique address (Local settings) or selected via the Display list.



Only for the Cine VERSUM 80 HD2, three Gamma tables are added to the list, named Film, Graphics and Video.

How to set up the Gamma value

- Enter the MAIN menu and select the sub menu IMAGE SETTINGS, using the jog dial or the Remote Control. (image 17-11)
Depending the addressed unit:
 - Master: The global Image settings menu is displayed, inclusive the menu item *DISPLAY*. The latter has to be selected to enter the image settings menu for a specific display.
 - Display: The Image settings menu for that specific display appears, inclusive the item *GAMMA*.
- Select the menu item *GAMMA* in the image settings menu for that specific display, by rotating the jog dial on the Master or the ↑ and ↓ keys on the Remote Control.
- Press the jog dial on the Master or the key **ENTER** on the Remote Control to confirm.
A table with the available Gamma values appears on-screen and in the graphical display of the Master. The active Gamma correction is indicated with an asterisk in front of the item.
- Select the desired Gamma value by rotating the jog dial on the Master or the ↑ and ↓ keys on the Remote Control. Changing the Gamma value has the following influence on the displayed image:

| Gamma Value | Influence on the displayed image |
|---------------------------|--|
| $\gamma = 2.2$ | This is the standard value. With reference to the eye perception, the displayed image is the most natural image. (Best match between camera recording, projector display and human eye). |
| $1.0 < \gamma < 2.2$ | A lower value enhanced the details in the dark image content, without changing the black level, resulting in a lower contrast perception. |
| $2.2 > \gamma > 3.1$ | A higher value occurs a fade away of the details in the dark image content, without changing the black level, resulting in a higher contrast perception. |
| Film Graphics Video | Gamma tables with lookup tables that can be loaded to enhance Film, Graphics or Video (NTSC, PAL, SECAM) display. |

- Press **EXIT** on the Remote Control or press the jog dial on the Master to return.
Gamma value is stored for that specific display unit.

Main Menu/ Image Settings /Display/ CV80-CV50-CV120 /Gamma

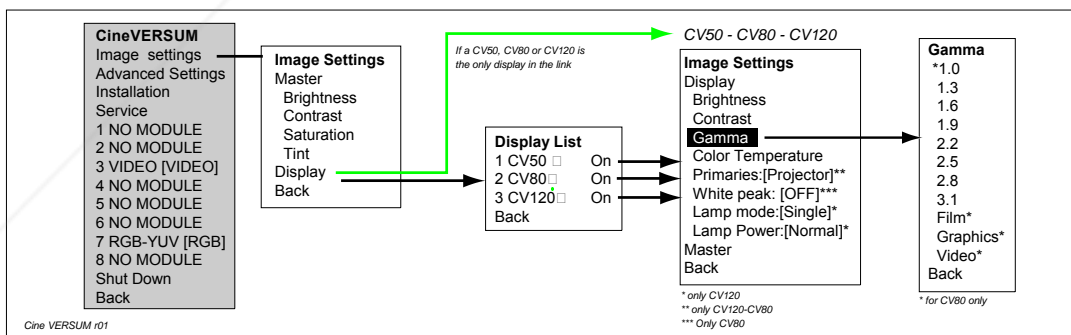

Image 17-11
Menu Gamma
Sponsored by DM

Discount-Merchant.com (800) 281-8860

17.12 Adjusting the Color Temperature

Overview

- Selecting the preset Color Temperature
- Customizing the Color Temperature

About Color Temperature setting

This function can be used to adjust the color temperature to suit the type of image input to the display unit (DVD, Video, Computer image, TV broadcast etc..)



The Color Temperature menu will include 5 fixed values. To allow the customer to adjust the Color Temperature to his own taste, item Customer Balance has been added to the menu.



Customer Balance adjustment happens differently for Cine VERSUM 50 and the projector displays, Cine VERSUM 80 and Cine VERSUM 120.

17.12.1 Selecting the preset Color Temperature

How to select the right Color Temperature

- Enter the MAIN menu and select the sub menu IMAGE SETTINGS, using the jog dial or the Remote Control. (image 17-12)
Depending the addressed unit:
 - Master: The global Image settings menu is displayed, inclusive the menu item *DISPLAY*. The latter has to be selected to enter the image settings menu for a specific display.
 - Display: The Image settings menu for that specific display appears, inclusive the item *COLOR TEMPERATURE*.
- Select the menu item *COLOR TEMPERATURE* in the image settings menu for that specific display, by rotating the jog dial on the Master or the ↑ and ↓ keys on the Remote Control.
- Press the jog dial on the Master or the key **ENTER** on the Remote Control to confirm.
A table with the preset Color temperature values appears on-screen and in the graphical display of the Master. The active Color temperature is indicated with an asterisk in front of the item. (menu 17-24)
- Select the Color Temperature item, which suit the type of the input signal, by rotating the jog dial on the Master or the ↑ and ↓ keys on the Remote Control.
- Press the jog dial on the Master or the key **ENTER** on the Remote Control to confirm.
New Color Temperature value is stored and the image changeover to the new Color Temperature.
- Press **EXIT** on the Remote Control or press the jog dial on the Master to return.
Color Temperature value is stored for that specific display unit.

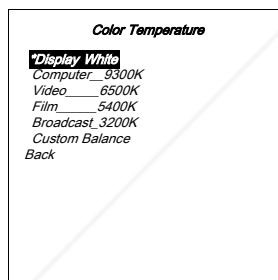

Menu 17-24

Main Menu / Image Settings / Display / CV80-CV50-CV120 / Color Temperature

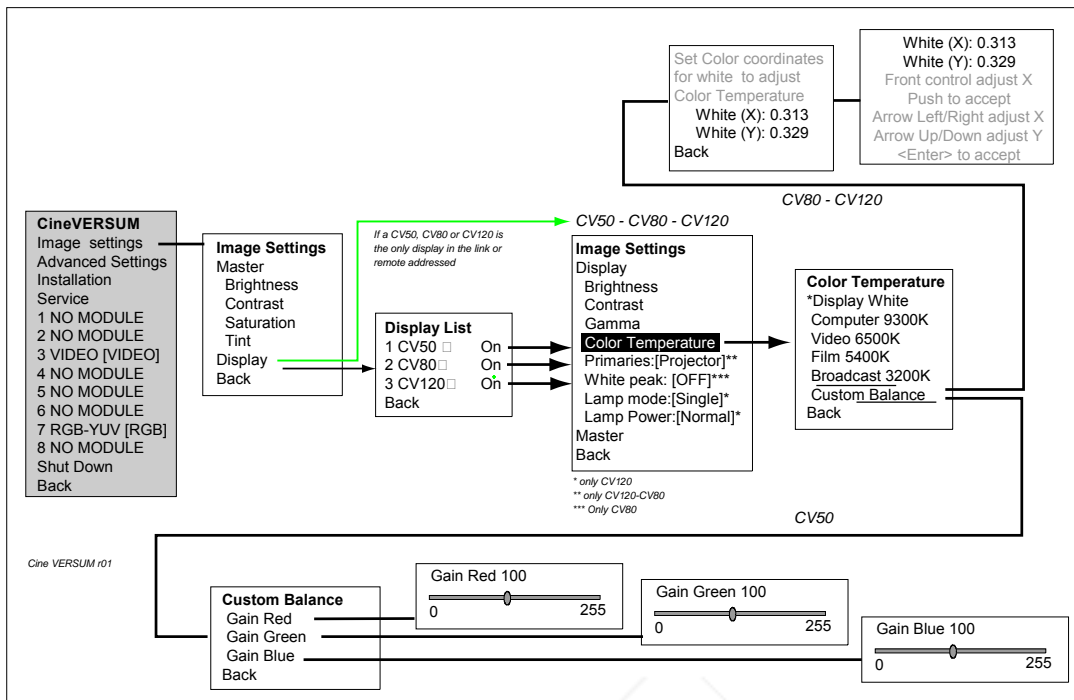

Image 17-12
Menu Color Temperature

| Display White | Computer 9300K | Video6500K | Film5400K | Broadcast3200K |
|----------------|----------------|----------------|----------------|----------------|
| Gain Red 255 | Gain Red 255 | Gain Red 255 | Gain Red 255 | Gain Red 255 |
| Gain Green 255 | Gain Green 162 | Gain Green 142 | Gain Green 129 | Gain Green 81 |
| Gain Blue 255 | Gain Blue 213 | Gain Blue 138 | Gain Blue 102 | Gain Blue 29 |

Image 17-13

17.12.2 Customizing the Color Temperature

How to adjust the Color Temperature for Cine VERSUM 50

1. Select the Color Temperature item, which match the best the input signal, by rotating the jog dial on the Master or the ↑ and ↓ keys on the Remote Control (Selecting the preset Color Temperature, page 119).
2. Press the jog dial on the Master or the key **ENTER** on the Remote Control to confirm.
3. Select item **CUSTOM BALANCE** by rotating the jog dial on the Master or the ↑ and ↓ keys on the Remote Control. (menu 17-25)
Note: Item 'Display White: an image with maximum white will be displayed.
4. Press the jog dial on the Master or the key **ENTER** on the Remote Control to confirm.

A sub menu Custom Balance opens, including the Gain adjustments for Red, Green and Blue. The start level of the Gain for the three colors corresponds with these of the selected predefined Color Temperature in step 1. (menu 17-26)

5. Select successively one or more Gain items, depending the Color Temperature you aim at, by rotating the jog dial on the Master or the ↑ and ↓ keys on the Remote Control.
6. Press the jog dial on the Master or the key **ENTER** on the Remote Control to confirm.

The corresponding bar scale appears on-screen and in the graphical display on the Master. (Image 17-14)

7. Adjust the respective Gain levels, by rotating the jog dial on the Master or the ← and → keys on the Remote Control, until the desired Color Temperature has been reached.
8. Press **EXIT** on the Remote Control or select item *BACK* in the menus to return.

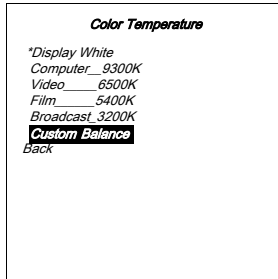

Menu 17-25

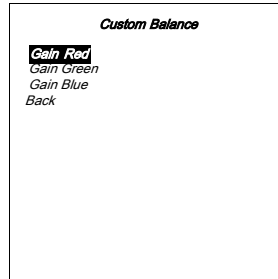

Menu 17-26

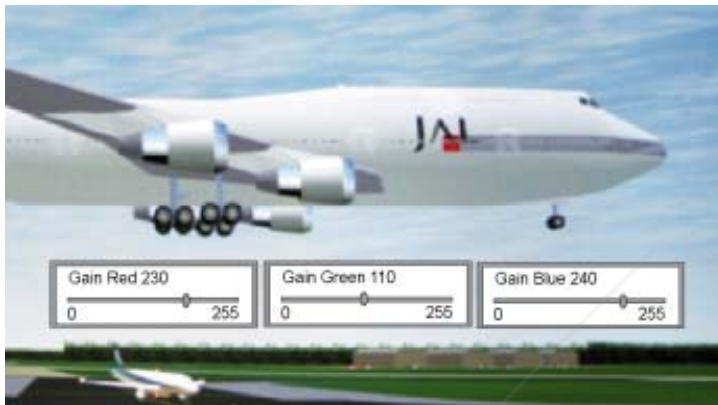

Image 17-14

How to adjust the Color Temperature for Cine VERSUM 80 and Cine VERSUM 120

1. Select the Color Temperature item, which match the best the input signal, by rotating the jog dial on the Master or the ↑ and ↓ keys on the Remote Control (Selecting the preset Color Temperature, page 119).
2. Press the jog dial on the Master or the key **ENTER** on the Remote Control to confirm.
3. Select item **CUSTOM BALANCE** by rotating the jog dial on the Master or the ↑ and ↓ keys on the Remote Control. (menu 17-27)
Note: Item 'Display White': an image with maximum white will be displayed.
4. Press the jog dial on the Master or the key **ENTER** on the Remote Control to confirm.
Note: The measured color coordinates and luminance of R, G, B and W are written into the projector. These were be find by measuring with a colorimeter. Adjusting the white coordinate will not affect the full-on color intensity of a pixel that is R, G or B. Via the Custom balance, the preset value of a color temperature can be modified.

A sub menu opens, requesting to set up the X-Y coordinates for white, inclusive display of the already stored values (image 17-12).

Overview of the white X-Y coordinates with respect to the preset color temperatures. (image 17-15)

5. Proceed to the X-Y adjustment, using the jog dial on the master:
 - Select the coordinate to be modified by rotating the jog dial and press to confirm.
 - A new sub menu opens allowing to adjust, by rotating the jog dial, the value of the selected coordinate.
 - Press the jog dial to confirm resulting in return to the coordinated selection menu.
 - Repeat the procedure from the beginning for the other coordinate.
 - Leaving the system, via item *BACK*.

17. Adjusting the Picture

6. Proceed to the X-Y adjustment, using the Remote Control:
 - Select a coordinate to be modified by pressing the ↑ or ↓ key on the Remote Control and press **ENTER** to confirm.
 - A new sub menu opens allowing to adjust, by pressing the ↑ or ↓ keys the Y-value and by pressing ← or → keys the X-value.
 - Press **EXIT** to return.
7. Press **EXIT** on the Remote Control or select item *BACK* in the menus to return.

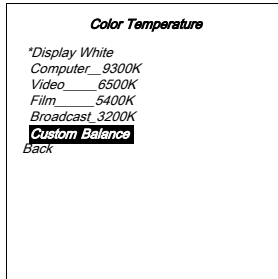

Menu 17-27

| Display White | Computer 9300K | Video 6500K | Film 5400K | Broadcast 3200K |
|----------------------------------|----------------------------------|----------------------------------|----------------------------------|----------------------------------|
| White X: 0.316 White Y: 0.332 | White X: 0.283 White Y: 0.297 | White X: 0.313 White Y: 0.329 | White X: 0.335 White Y: 0.349 | White X: 0.423 White Y: 0.399 |

Image 17-15

17.13 Adjusting the Picture Controls

About picture controls

Picture controls as, Brightness, Contrast, Saturation and Tint can be remotely controlled using the Remote control (refer to the Owner's manual). The same functions are also available in the GUI, displayed on-screen and in the graphical display on the Master.

The three analog controls can be adjusted for all the linked displays at the same time (=Master), on the other hand, corrections can be applied for each display separately (=Display), depending the environment conditions.

Menu overview picture controls

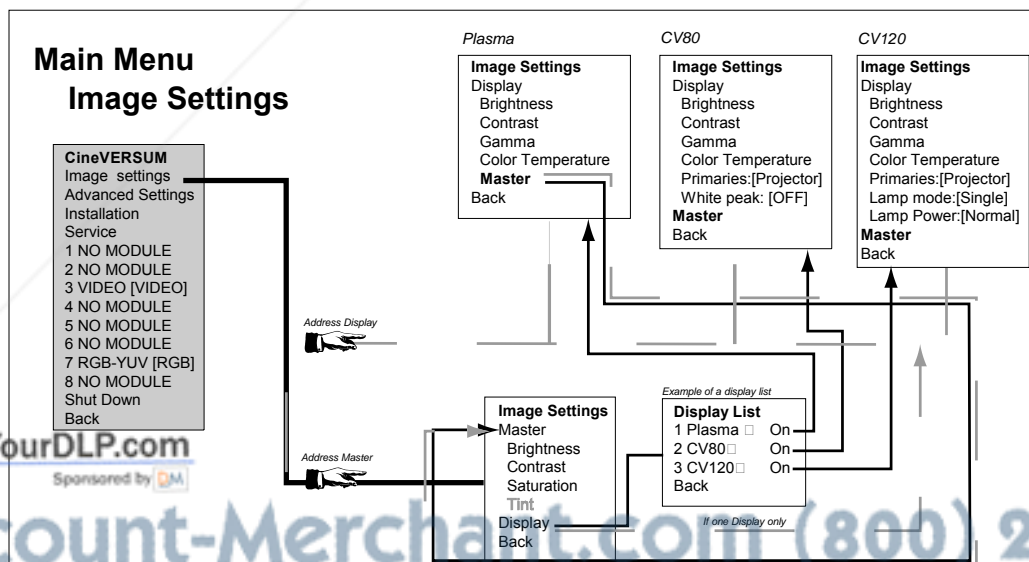

Image 17-16

17.13.1 Master Adjustment of the Analog Controls

How to adjust the analog controls

1. From the main menu, select item *IMAGE SETTINGS*.

Note: When using the Remote Control, make sure that the address of the RC is the common or the Master address!

The Image Settings menu appears on-screen and in the graphical display on the Master, showing the two main items 'Master' and 'Display'. (menu 17-28)

2. Select the item you want to adjust, using the ←or→key on the Remote Control or by rotating the jog dial on the Master.
3. Press the jog dial on the Master or the key **ENTER** on the Remote Control to confirm.

The bar scale, adjustable between 0 and 255, according to the selected analog control appears on-screen and in the graphical display. (image 17-17)

4. Adjust the level of the analog control by rotating the jog dial on the Master or pressing the ←or→key on the Remote Control.

| Selected Item | Pressing Key← or Jog dial to the left | Pressing Key→ or Jog dial to the right |
|--------------------------|---------------------------------------|--|
| Brightness | For less brightness | For more brightness |
| Contrast | For less contrast | For more contrast |
| Saturation | For less color intensity | For more color intensity |
| Tint (NTSC signals only) | Skin tones become purplish | Skin tones becomes greenish |

5. If you want to proceed to adjustment of the analog controls per display, select item *DISPLAY*. This item is explained in chapter below 'Analog Controls adjustment per Display'.
6. Press **EXIT** on the Remote Control or press the jog dial on the Master to return.

New Value of the adjusted analog control is stored in the Cine VERSUM Master and will be applied to all linked displays.

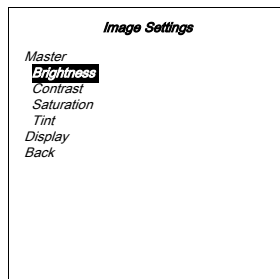

Menu 17-28

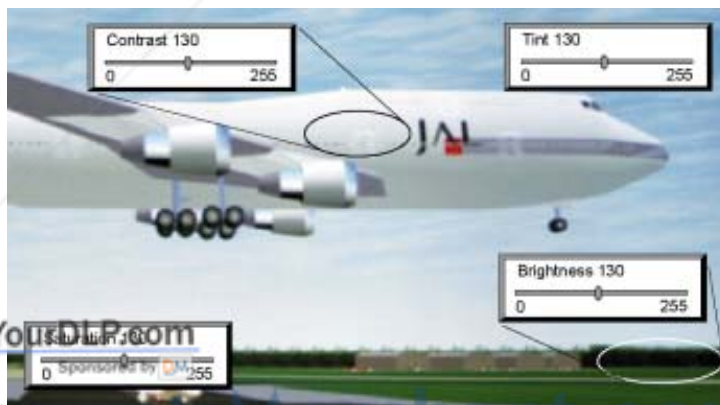

Image 17-17
Analog controls

17.13.2 Analog Controls adjustment per Display



The items in the display settings per display are, Brightness, Contrast, Gamma and Color Temperature. The 2 last mentioned items are already explained, see "Gamma Correction", page 117, and see "Adjusting the Color Temperature", page 118.

17.13.2.1 Via Cine VERSUM Master



Chapter below is a continuation of procedure, see "Master Adjustment of the Analog Controls", page 123.

About Image Settings menu

When adjusting the analog controls separately on the linked display, then the items in the Image Settings menu depends on the addressed display. Below the Image Settings menu for respectively the Cine VERSUM 50, the Cine VERSUM 80 and the Cine VERSUM 120.

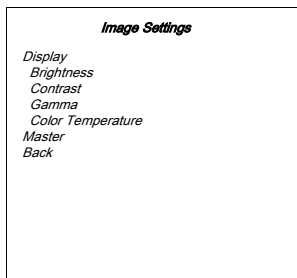

Menu 17-29

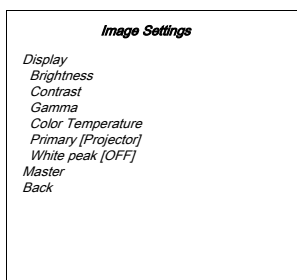

Menu 17-30

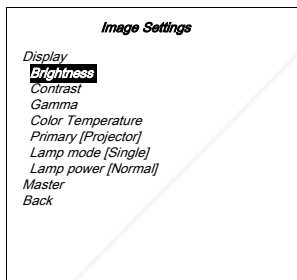

Menu 17-31

How to adjust the analog controls per display

1. From the master IMAGE SETTINGS menu, select item *DISPLAY*. (menu 17-32)
The display list appears on-screen and in the graphical display, showing all the detected displays in the link. (menu 17-33)
2. Select the Display you want to adjust the analog controls, using the ←or→key on the Remote Control or by rotating the jog dial on the Master.
3. Press the jog dial on the Master or the key **ENTER** on the Remote Control to confirm.
The Image Settings menu for that specific display (menu 17-29, menu 17-30, menu 17-31) appears on-screen and in the graphical display on the Master, including the two main items 'Display' and 'Master'. These latter two items allow to switch between master and display analog control adjustment.
4. Select the item you want to adjust, using the ←or→key on the Remote Control or by rotating the jog dial on the Master.
5. Press the jog dial on the Master or the key **ENTER** on the Remote Control to confirm.
The bar scale, adjustable between -127 and 127, according to the selected analog control appears on-screen and in the graphical display. (image 17-18)

- Adjust the level of the analog control, with default value the Master setting, by rotating the jog dial on the Master or pressing the ←or→key on the Remote Control.

| Selected Item | Pressing Key←or jog dial to the left | Pressing Key→ or jog dial to the right |
|---------------|--------------------------------------|--|
| Brightness | For less brightness | For more brightness |
| Contrast | For less contrast | For more contrast |

- If you want to proceed to re-adjustment of one of the analog controls for all displays, select item *Master* in the respective Image Settings menu (menu 17-29, menu 17-30, menu 17-31).

The GUI menu returns to the Image settings menu of the Master, and the procedure can be repeated (see "Master Adjustment of the Analog Controls", page 123)

- Press **EXIT** on the Remote Control or press the jog dial on the Master to return.

New Value of the adjusted analog control is stored in the addressed Display.

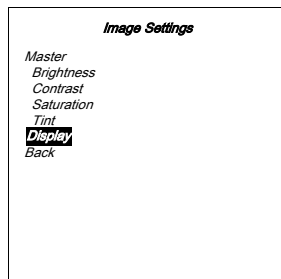

Menu 17-32

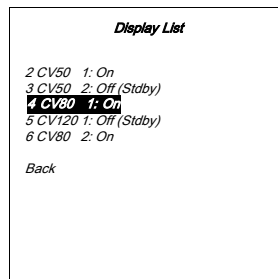

Menu 17-33

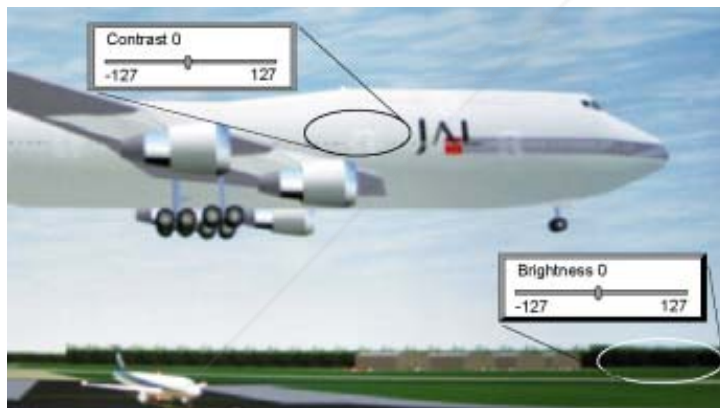

Image 17-18
Analog controls per display

17.13.2.2 Via Display with Remote Control only

How to adjust analog controls per display

- Program the Remote Control with the address of the Display you want to apply correction to the Brightness and Contrast setting. (see "Address setting for the Remote Control", page 63).

- From the main menu, select item *IMAGE SETTINGS*.

The Image Settings menu for that specific display (menu 17-29, menu 17-30, menu 17-31) appears on-screen and in the graphical display on the Master, showing the two main items '*Master*' and '*Display*'.

- Select the item you want to adjust, using the ←or→key on the Remote Control and press key **ENTER** on the remote control to confirm.

The bar scale, adjustable between -127 and 127, according to the selected analog control appears on-screen and in the graphical display.

17. Adjusting the Picture

- Adjust the level of the analog control, with default value the Master setting, by pressing the ←or→key on the Remote Control.

| Selected Item | Pressing Key← | Pressing Key→ |
|---------------|---------------------|---------------------|
| Brightness | For less brightness | For more brightness |
| Contrast | For less contrast | For more contrast |

- If you want to proceed to re-adjustment one of the analog controls for all displays, select item 'Master' (menu 17-29, menu 17-30, menu 17-31).
- The GUI menu returns to the Image settings menu of the Master, and the procedure can be repeated. (see "Master Adjustment of the Analog Controls", page 123)
- Press **EXIT** on the Remote Control to return.

New Value of the adjusted analog control is stored in the selected Display.

18. ADDITIONAL SETTINGS CINE VERSUM MASTER

Overview

- Output Resolution set up
- Display Internal Generated Pattern
- Shutdown Automatic when no signal
- Source Transition
- On Screen Display Configuration
- On-Screen Display Language
- Display Name Change

18.1 Output Resolution set up

Why Output Resolution set up?

In case the digital video distribution system contains a combination of a Cine VERSUM 50 (Resolution 1280/768), a Cine VERSUM 80 (Resolution 1280/720) and/or a Cine VERSUM 120 (Resolution 1280/720), then the Cine VERSUM Master has to scale his output resolution to one of these displays.



When selecting the resolution of the Cine VERSUM 80 or the Cine VERSUM 120, then the picture on the Cine VERSUM 50 is displayed with a black bar at the bottom. The latter can occurs burning-in of the plasma screen. For that reason, selection of the output resolution referring to Cine VERSUM 50 is recommended. On the other hand, the highest output resolution occurs for the Cine VERSUM 80 and the Cine VERSUM 120 a lost of lines at the bottom.

How to set up the output resolution

1. Select the INSTALLATION menu (see "Loading a File", page 97).
2. Select item *OUTPUT* by rotating the jog dial on the Master or the ↑ or ↓ keys on the Remote Control. (menu 18-1)
3. Press the jog dial on the Master or the key **ENTER** on the Remote Control to toggle between *SMALLEST* or *LARGEST*.
 - Selecting 'Smallest': default output resolution to displays is 1280/720, occurring full image on the Cine VERSUM 80/Cine VERSUM 120 and a picture with a black bar on the bottom for the Cine VERSUM 50. (image 18-1)
 - Selecting 'Largest': default output resolution to displays is 1280/768, occurring full image on the Cine VERSUM 50 and lost of lines on bottom on Cine VERSUM 80/Cine VERSUM 120 (May be a problem with subtitles). (image 18-2)
4. Press the **EXIT** key on the Remote Control or select item *BACK* on the graphical display, by rotating the jog dial followed by pressing it, to leave the GUI menus.

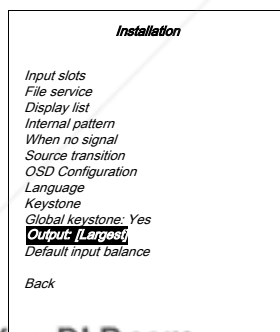

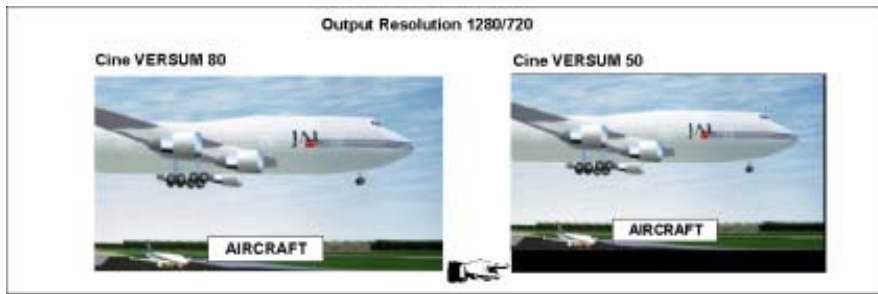

Image 18-1
Picture on display



Image 18-2
Picture on display

18.2 Display Internal Generated Pattern

How to display an internal pattern

In total 10 different internal patterns (Generated in the Cine VERSUM Master) can be displayed instead of the selected source. To select a pattern, carry out the following steps:

1. Select the INSTALLATION menu (see "Loading a File", page 97).
2. Select item INTERNAL PATTERN by rotating the jog dial on the Master or the ↑ or ↓ keys on the Remote Control.
3. Press the jog dial on the Master or the key **ENTER** on the Remote Control to confirm.

The sub menu INTERNAL PATTERNS appears on-screen and in the graphical display, including a list of available internal generated patterns. (menu 18-2)

4. Select the pattern you desire to display by rotating the jog dial on the Master or the ↑ or ↓ keys on the Remote Control.
5. Press the jog dial on the Master or the key **ENTER** on the Remote Control to confirm.

The image from the selected source will be replaced by the selected internal test pattern. Press again to reverse the image. For the purity test pattern, the different purity patterns, Black-Green-Red-Blue-White, are selected consecutively by pressing again the **ENTER** key or the jog dial. (image 18-3)

6. Press the **EXIT** key on the Remote Control or select item BACK on the graphical display, by rotating the jog dial followed by pressing it, to leave the GUI menus.

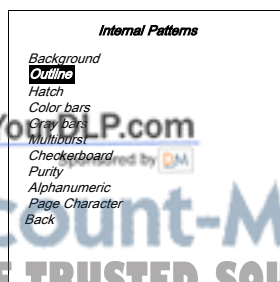

Menu 18-2

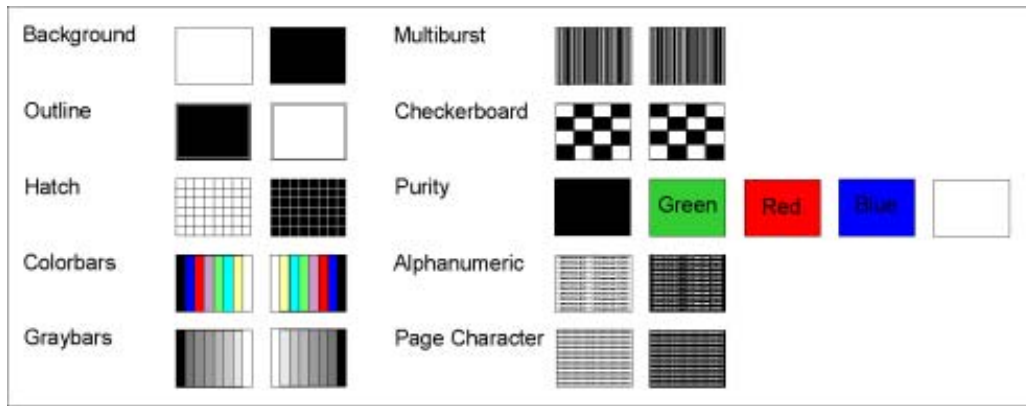

Image 18-3
Available testpatterns

18.3 Shutdown Automatic when no signal

How to setup the automatic shutdown

If no input signal is available for a delay of minimum 40 seconds, the Cine VERSUM Master can be setup for automatic shutdown (Standby mode).

1. Select the INSTALLATION menu (see "Loading a File", page 97)
2. Select item *WHEN NO SIGNAL* by rotating the jog dial on the Master or the ↑ or ↓ keys on the Remote Control.
3. Press the jog dial on the Master or the key **ENTER** on the Remote Control to confirm.

The sub menu *WHEN NO SIGNAL* appears on-screen and in the graphical display, including the status of the shutdown, On or Off. If the status is 'Off', then the delay time can not be adjusted (text is displayed in gray). (menu 18-3)

4. Select item *SHUTDOWN* by rotating the jog dial on the Master or the ↑ or ↓ keys on the Remote Control.
5. Press the jog dial on the Master or the key **ENTER** on the Remote Control to toggle the status of the Shutdown to 'On'.

Item *DELAY* becomes active (text displayed in black) allowing to change the delay time.

6. Select item *DELAY* by rotating the jog dial on the Master or the ↑ or ↓ keys on the Remote Control.
7. Press the jog dial on the Master or the key **ENTER** on the Remote Control to confirm.

The menu box *SHUTDOWN DELAY*, requesting to enter new values for 2 numbers (=delay time) appears on-screen and in the graphical display. The first character is highlighted and can be filled in. After the second number has been putted in, the data is saved automatically.

8. Continue with filling in the 2 numbers consecutively as follows:
 - Pressing the cursor keys ↑ or ↓ on the Remote Control or rotating the jog dial on the Master allows to select the characters.
 - Pressing the cursor keys ← or → on the Remote Control or pressing the jog dial on the Master allows to change the character (Numeric characters can be entered remotely with the numeric keys).
9. Press **EXIT** on the Remote Control to return or select **BACK** in the menu by rotating the jog dial on the Master or the ↑ or ↓ keys on the Remote Control, confirmed by pressing the jog dial or the **ENTER** key.

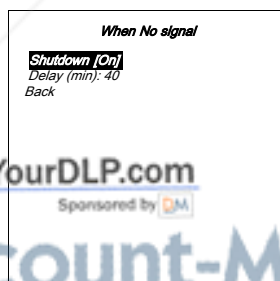

Menu 19-3

18.4 Source Transition

Source transition

Seamless transition mode can be applied during input source switching. There is a choice between 14 different effects which render the transitions more enjoyable.

How to enter the source transition effect

1. Select the INSTALLATION menu (see "Loading a File", page 97)
2. Select item *SOURCE TRANSITION* by rotating the jog dial on the Master or the ↑ or ↓ keys on the Remote Control.
3. Press the jog dial on the Master or the key **ENTER** on the Remote Control to confirm.

The sub menu *SOURCE TRANSITION* appears on-screen and in the graphical display, including a list of available source transition effects. The already active transition effect is indicated with an asterisk placed in front of the name. (menu 18-4)

4. Select the transition effect you desire to apply by rotating the jog dial on the Master or the ↑ or ↓ keys on the Remote Control.
5. Press the jog dial on the Master or the key **ENTER** on the Remote Control to confirm.

Confirmation is indicated with an asterisk placed in front of the new selected source transition effect.

6. Press **EXIT** on the Remote Control to return or select **BACK** in the menu by rotating the jog dial on the Master or the ↑ or ↓ keys on the Remote Control, confirmed by pressing the jog dial or the **ENTER** key.

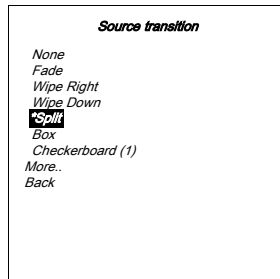

Menu 18-4

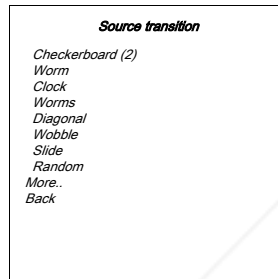

Menu 18-5

18.5 On Screen Display Configuration

Overview

- About the OSD (Menu, Bar Scale and Message)
- Status Change of the OSD
- On Screen Display Position Alignment

18.5.1 About the OSD (Menu, Bar Scale and Message)

OSD switching On/Off

To allow image adjustments during a performance without disturbing the image by the OSD, the On Screen Display can be turned off in 2 ways:

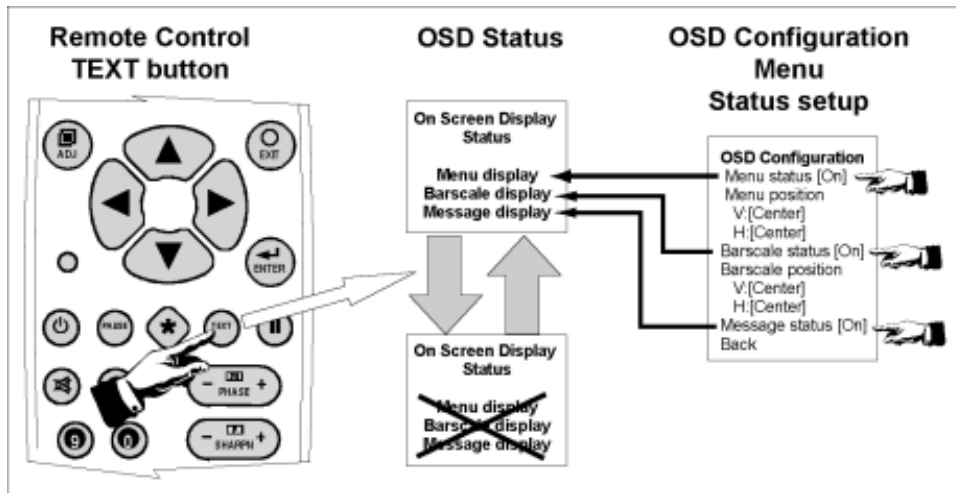

Image 18-4

- Press the key **TEXT** on the Remote Control. The OSD's, included Menu, Bar scale and Message are disabled. To reactivate the OSD, press the key **TEXT** again. Attention, only the OSD's (including MENU, BAR SCALE and MESSAGE) with status 'On' will be active again.
- Via the OSD configuration menu. Disabling and enabling the display (=changing the status) for respective Menu, Bar scale and Messages, has to be done for each item separately.

18.5.2 Status Change of the OSD

How to change the status of the OSD

The status of the OSD can be changed in the OSD Configuration menu. The menu is displayed on-screen, if status of the Menu is set to 'on', and in the graphical display on the Cine VERSUM Master. In case of a non active Menu OSD (=status 'Off'), refer to the menu in the graphical display on the Cine VERSUM Master.

1. Select the **INSTALLATION** menu using the respective keys on the Remote Control or the jog dial on the Cine VERSUM Master.
2. Select item **OSD CONFIGURATION** by rotating the jog dial on the Master or the **↑** or **↓** keys on the Remote Control.
3. Press the jog dial on the Master or the key **ENTER** on the Remote Control to confirm.

The sub menu **OSD CONFIGURATION** appears on-screen (If Menu status is 'On') and in the graphical display, including the status setting of the bars cale, the menu and Message as well as the alignment of the position of it (not for the Message box). (menu 18-6)

4. Select the OSD item you want to change the status by rotating the jog dial on the Master or the **↑** or **↓** keys on the Remote Control.
5. Press the jog dial on the Master or the key **ENTER** on the Remote Control to toggle the status from On to Off or back to On.
6. Press **EXIT** on the Remote Control to return or select **BACK** in the menu by rotating the jog dial on the Master or the **↑** or **↓** keys on the Remote Control, confirmed by pressing the jog dial or the **ENTER** key.

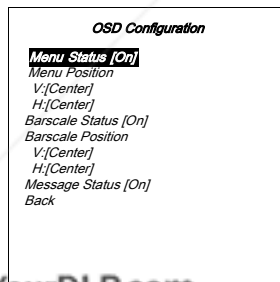

Menu 18-6

FixYourDLP.com
Sponsored by DM

Discount-Merchant.com (800) 281-8860
THE TRUSTED SOURCE FOR PROJECTOR LAMPS AND ACCESSORIES

18.5.3 On Screen Display Position Alignment

How to define the position of the OSD

The position of the OSD for the Menu and the Bar scale is adjustable. The vertical and the horizontal position of the OSD are adjustable and are located in the menu below the respective OSD name, Menu position and Bar scale position. The procedure is for both the same. Follow the next steps:

1. Select the OSD adjustable item you want to change by rotating the jog dial on the Master or the ↑ or ↓ keys on the Remote Control. (menu 18-7)
2. Press the jog dial on the Master or the key **ENTER** on the Remote Control to toggle between Top, Center and Bottom in case of Vertical position, and between left, Center and Right in case of Horizontal position.

The OSD jumps to the selected position on the screen.

3. Press **EXIT** on the Remote Control to return or select **BACK** in the menu by rotating the jog dial on the Master or the ↑ or ↓ keys on the Remote Control, confirmed by pressing the jog dial or the **ENTER** key.

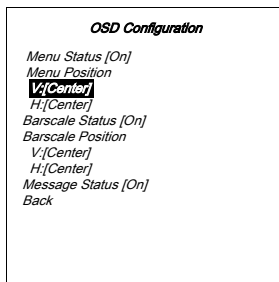

Menu 18-7

18.6 On-Screen Display Language

How to change the language of the menus

When entering the Language menu, the available languages are displayed. The active language is indicated with an asterisk in front of the language name.

1. Select the **INSTALLATION** menu using the respective keys on the Remote Control or the jog dial on the Cine VERSUM Master. (menu 18-8)
2. Select item **LANGUAGE** by rotating the jog dial on the Master or the ↑ or ↓ keys on the Remote Control.
3. Press the jog dial on the Master or the key **ENTER** on the Remote Control to confirm.

The sub menu **LANGUAGE** appears on-screen and in the graphical display, including the available languages. (menu 18-9)

4. Select the desired language by rotating the jog dial on the Master or the ↑ or ↓ keys on the Remote Control.
5. Press the jog dial on the Master or the key **ENTER** on the Remote Control to confirm.

The language changes to the selected one and is indicated in the menu with an asterisk in front of the language name.

6. Press **EXIT** on the Remote Control to return or select **BACK** in the menu by rotating the jog dial on the Master or the ↑ or ↓ keys on the Remote Control, confirmed by pressing the jog dial or the **ENTER** key.



Menu 18-8

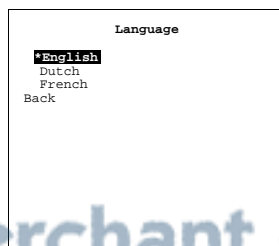

Menu 18-9

18.7 Display Name Change

Where to find the display RENAME function

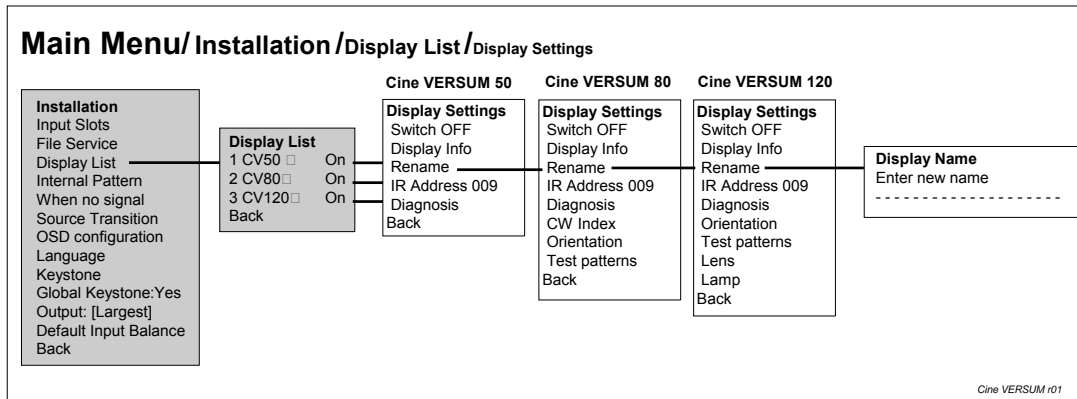

Image 18-5
Rename function search

How to change the name of a display

When starting up the system for the first time, the name of the detected displays, registered in the display list, is the serial number of the respective display. The name can contain maximum 20 characters. To change the name, follow next steps:

1. Select the **INSTALLATION** menu using the respective keys on the Remote Control or the jog dial on the Cine VERSUM Master. (menu 18-10)
2. Select item **DISPLAY LIST** by rotating the jog dial on the Master or the \uparrow or \downarrow keys on the Remote Control.
3. Press the jog dial on the Master or the key **ENTER** on the Remote Control to confirm.

The Display List menu appears on-screen and in the graphical display showing the detected displays, inclusive address number, display name (can be renamed) and status. (menu 18-11)

4. Select the display, you desire to change the name, by rotating the jog dial on the Master or the up/down arrow keys on the Remote Control.
5. Press the jog dial on the Master or the key **ENTER** on the Remote Control to confirm.

The Display Settings menu for that particular display appears on-screen and in the graphical display showing the specific items for the selected display (image 18-5).

6. Select item **RENAME** by rotating the selection wheel on the Master or the up/down arrow keys on the Remote Control.
7. Press the jog dial on the Master or the key **ENTER** on the Remote Control to confirm.

The DISPLAY NAME menu appears on-screen and in the graphical display on the Master requesting to enter a new display name (max 20 characters). (menu 18-12)

8. Start with filling in the new name, (Always 20 characters) as follows:
 - Pressing the cursor keys \leftarrow or \rightarrow on the Remote Control or pressing the jog dial on the Master allows to select the character position.
 - Pressing the cursor keys \uparrow or \downarrow on the Remote Control or rotating the jog dial on the Master allows to change the character (Numeric characters can be entered remotely with the numeric keys).
9. When the last character of the display name has been entered, a message box pops up, confirming saving data.

The message box disappears after a few seconds. (menu 18-13)

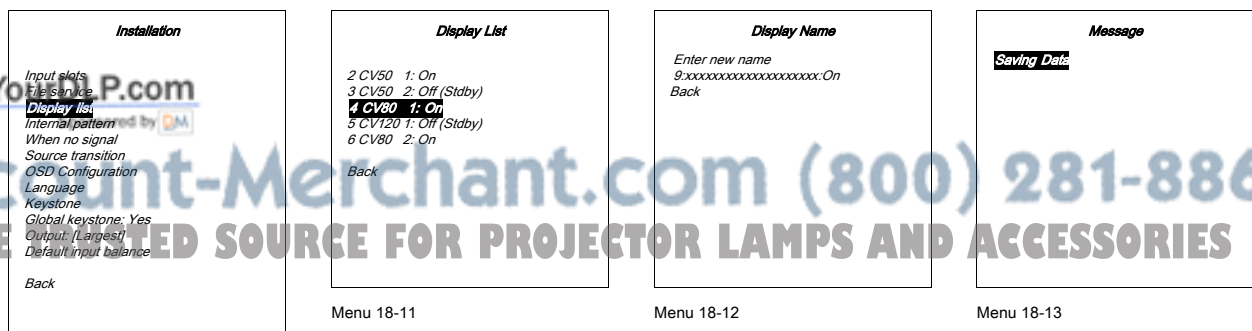

Menu 18-10

Menu 18-11

Menu 18-12

Menu 18-13



Discount-Merchant.com (800) 281-8860
THE TRUSTED SOURCE FOR PROJECTOR LAMPS AND ACCESSORIES

19. PICTURE IN PICTURE (PIP)

Overview

- Turning On/Off the Picture in Picture
- Selecting Input Source for PIP Window
- Configuration of the PIP Window

What is Picture in Picture

If PIP is enabled, a window is inserted in the active image, in which the image of another selected input source will be displayed. The position and the size of the window is adjustable. How to turn On/Off and adjusting the size and position of the PIP window, see below.

19.1 Turning On/Off the Picture in Picture

How to turn On/Off the PIP

1. Select the ADVANCED SETTINGS menu (Adjusting the Image Aspect Ratio, page 107)
2. Select item PIP CONFIGURATION by rotating the selection wheel on the Master or the up/down arrow keys on the Remote Control. (menu 19-1)
3. Press the jog dial on the Master or the key **ENTER** on the Remote Control to confirm.
The sub menu PIP CONFIGURATION appears on-screen and in the graphical display. This menu contains the items PIP toggle function On/Off, Vertical and Horizontal shift and size alignment. (menu 19-2)
4. Select item PIP [yes] by rotating the jog dial on the Master or the up/down arrow keys on the Remote Control to confirm.
5. Press the **ENTER** key on the Remote Control or the jog dial on the Master to toggle the PIP function On (Yes) or Off (No).
6. Press **EXIT** key on the Remote Control or select item BACK to return.

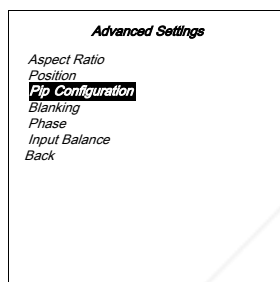

Menu 19-1

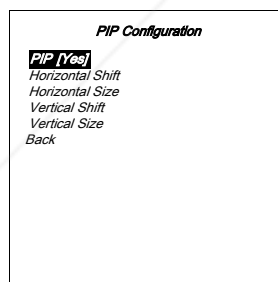

Menu 19-2

19.2 Selecting Input Source for PIP Window

How to select input source for PIP window

The procedure below supposes an already selected input source (main image) and the PIP function set to 'Yes'.

1. Select the input source, remotely accessible with the digit keys on the Remote Control, you desire to be displayed into the PIP window.

If no valid source is connected to the input of the selected input module, no PiP window appears.

If a valid source is connected to the input, the selected input appears as PiP window on the screen. (image 19-1)

2. If the same input source (PIP image) is selected again, then, the main image is replaced by the PIP image and the PIP window disappears.

19. Picture in Picture (PIP)

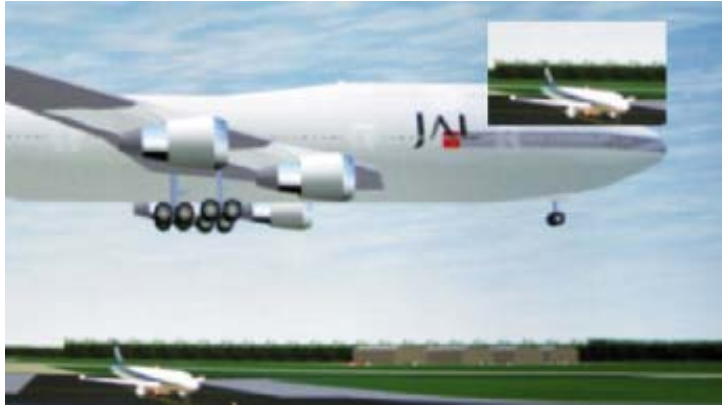

Image 19-1
Picture in Picture



When a PiP window is on the screen, zapping over inputs change only the PiP window. When the same source is pressed twice, the selected source becomes the main window and the PiP window disappears.

19.3 Configuration of the PIP Window

How to configure the PIP window manually

1. Select the PIP Configuration menu (Turning On/Off the Picture in Picture, page 135).
2. Select the item you desire to adjust by rotating the jog dial on the Master or the up/down arrow keys on the Remote Control. (menu 19-3)
3. Press the jog dial on the Master or the key **ENTER** on the Remote Control to confirm.
The corresponding bar scale appears on-screen and in the graphical display of the Master. (image 19-2)
4. Adjust the Size or Shift (Position on the image)
 - With the Remote Control: press the \uparrow and \downarrow key for Top/Bottom blanking, and the \leftarrow and \rightarrow key for Left/Right blanking.
 - With the selection wheel on the Master: rotate the jog dial to the left or to the right.
5. Press EXIT on the Remote Control or press the jog dial on the Master to return.

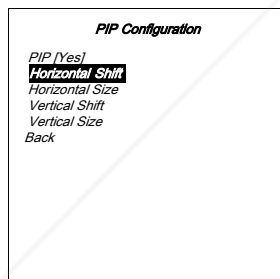

Menu 19-3



Image 19-2
PIP configuration

How to configure the PIP window quickly

The function keys F1 to F5 on the Remote Control have the following action:

- F1-F2-F4 and F5: changing the place of the PIP window in the projected image.

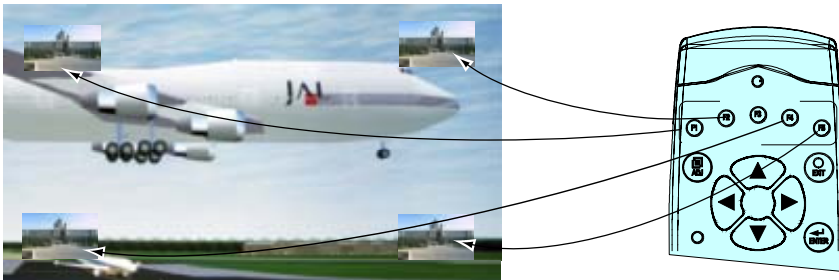

Image 19-3
Position of the PIP window

- F1-F2-F4 and F5: enlarging the PIP window when pressed a second time.

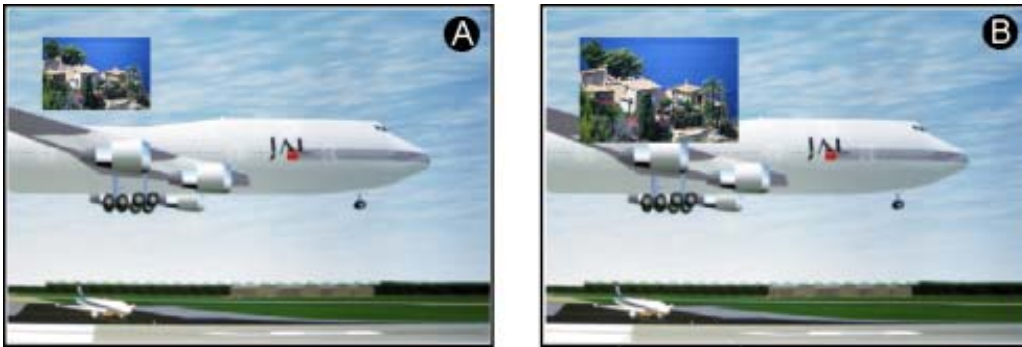

Image 19-4
PIP window enlarged

- A Normal PIP window
- B Enlarged PIP window

- F3: swapping the main source and the PIP source.

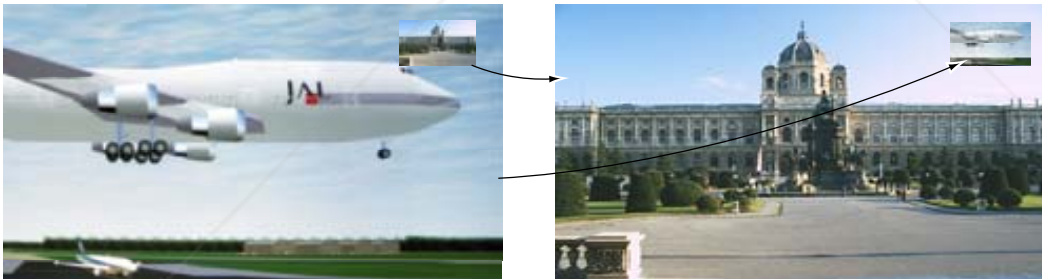

Image 19-5
Image swapping



Discount-Merchant.com (800) 281-8860
THE TRUSTED SOURCE FOR PROJECTOR LAMPS AND ACCESSORIES

20. CINE VERSUM MASTER SETTINGS & INFO

Overview

- Service Menu
- Cine VERSUM Master Identification
- Cine VERSUM Master Password
- Cine VERSUM Master Address



Entering the Installation as well as the Service menu can be password protected. If this should be the case, trying to enter both menus is preceded by a pop up menu, requesting to enter password.

20.1 Service Menu

How to enter the service menu

1. Select the INSTALLATION menu (see "Loading a File", page 97).
2. Select item *SERVICE* by rotating the jog dial on the Master or the ↑ or ↓ keys on the Remote Control.
3. Press the jog dial on the Master or the key **ENTER** on the Remote Control to confirm.

The sub menu *SERVICE* appears on-screen and in the graphical display, including a list of available settings and info, specific for the Cine VERSUM Master. (menu 20-1)

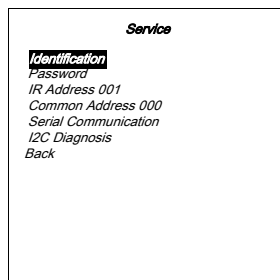

Menu 20-1

20.2 Cine VERSUM Master Identification

How to select the Identification menu

1. Select item *IDENTIFICATION* by rotating the jog dial on the Master or the ↑ or ↓ keys on the Remote Control.
2. Press the selection wheel on the Master or the key **ENTER** on the Remote Control to confirm.

The sub menu *IDENTIFICATION* appears on-screen and in the graphical display, including a list of general information about the Cine VERSUM Master. (menu 20-2)

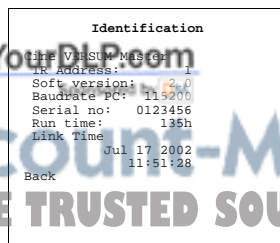

Menu 20-2

Explanation about the identification items

The identification menu shows the general information of the Cine VERSUM Master status.

- IR Address: typical address of the Cine VERSUM Master, to be used by the Remote Control to allow communication.
- Soft Version: the loaded software version. This version number can be useful when calling for service assistance.
- Baudrate PC: transfer speed for communication with an IBM PC (or compatible) or MAC. The baudrate must be the same as the baudrate of the connected computer.
- Serial no: the fabrication number of the Cine VERSUM Master. This number can be useful when calling for service assistance.
- Run Time: total run time since the first start up.
- Link Time: below Link Time item, the creation date and time of the loaded software is shown.

20.3 Cine VERSUM Master Password

How to activate the password protection

To prevent user's modify system set ups, entering the service and installation menu can be password protected. Follow next steps:

1. Select item *PASSWORD* in the Service menu by rotating the jog dial on the Master or the ↑ or ↓ keys on the Remote Control.
2. Press the jog dial on the Master or the key ENTER on the Remote Control to confirm.

The sub menu *PASSWORD* appears on-screen and in the graphical display, including the activation, Yes or No, of the password function and the possibility to change the password (4 digits). (menu 20-3)

3. Select item *USE PASSWORD [No]* by rotating the jog dial on the Master or the ↑ or ↓ keys on the Remote Control.

The status of the password function is indicated between brackets. To change the status, continue with step 4.

4. Press the jog dial on the Master or the key **ENTER** on the Remote Control to change the status from Yes to No and back.

Status [Yes]: entering the Installation as well as the service menu is password protected (after the Cine VERSUM System has been shut down and restarted).

Status [No]: Installation and Service menu are accessible all the time.

5. Press the key **EXIT** on the Remote Control or select Back in the graphical display by rotating the jog dial on the Master followed by pressing the jog dial to confirm, to return.

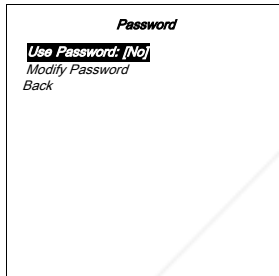

Menu 20-3

How to change the password

1. Select item **MODIFY PASSWORD** by rotating the jog dial on the Master or the ↑ or ↓ keys on the Remote Control.
2. Press the jog dial on the Master or the key **ENTER** on the Remote Control to confirm.
The sub menu **NEW PASSWORD** appears on-screen and in the graphical display, including the possibility to enter 4 digits, composing the new password. (menu 20-4)
3. Start with filling in the new name, (Always 4 characters) as follows:
 - Pressing the cursor keys ← or → on the Remote Control or pressing the jog dial on the Master allows to select the character position (moving to the right).
 - Pressing the cursor keys ↑ or ↓ on the Remote Control or rotating the jog dial on the Master allows to change the character (Numeric characters can be entered remotely with the numeric keys on the Remote Control).
4. When the last character of the new password has been entered, the system returns to preceding menu.
5. Press **EXIT** on the Remote Control or select **BACK** in the graphical display menu, rotating the jog dial to select and pressing to confirm, to leave the menu mode.

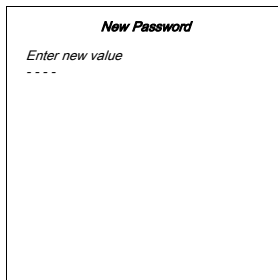

Menu 20-4

20.4 Cine VERSUM Master Address

Overview

- About the Cine VERSUM Master Address
- Cine VERSUM Master Address change
- Selecting the Transmission Speed
- Selecting the Interface standard (RS232/RS422)
- RS422 data bus termination
- Diagnosis

20.4.1 About the Cine VERSUM Master Address

Common address

The common address of the Cine VERSUM Master is 0 or 1, and is selectable in the Service menu. That means that all commands from the Remote Control, programmed with address 0 or 1, will be executed by the Cine VERSUM Master.

Individual address

In addition to the common address, an individual address can be set up in the Cine VERSUM Master, in case e.g. more units are located in the same location. In this way, the units can be addressed individually.

The individual address can be set in the Service mode and the address number to be set depends on used control device (Remote Control or PC).

- Addresses between 0 and 9: control device is the IR Remote Control¹
- Addresses between 0 and 255: control device is an IBM PC (or compatible), Apple, Mac, etc..

Reading out the stored address in the Cine VERSUM Master

- Point the front of the Remote Control at the IR sensor of the Cine VERSUM Master.
- Press the address key on the Remote Control.

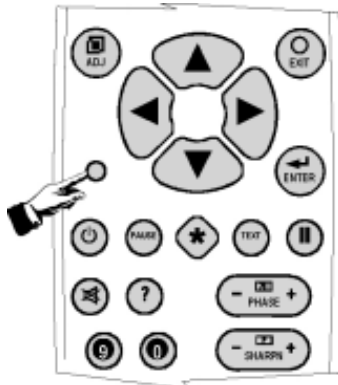
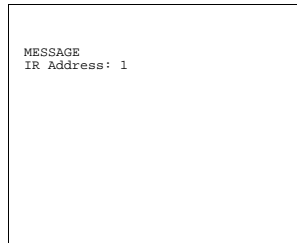

Image 20-1

- A text box appears on-screen and in the graphical display on the Cine VERSUM Master indicating the stored address.



Menu 20-5

20.4.2 Cine VERSUM Master Address change

How to change the IR Address

The IR address of the Cine VERSUM Master can be composed of 3 numbers. Due to the limits of the Remote Control, values between 000 and 009 can be entered only. In case of PC control, values between 000 and 255 can be entered.

1. Select item *IR ADDRESS* in the Service menu by rotating the jog dial on the Master or the ↑ or ↓ keys on the Remote Control.
2. Press the jog dial on the Master or the key ENTER on the Remote Control to confirm.

The sub menu IR ADDRESS appears on-screen and in the graphical display, including the possibility to enter 3 digits, composing the new IR Address. (menu 20-6)

3. Press the cursor keys ← or → on the Remote Control or press the jog dial on the Master to select the last digit.
4. Pressing the cursor keys ↑ or ↓ on the Remote Control or rotating the jog dial on the Master allows to change the character (Numeric characters can be entered remotely with the numeric keys on the Remote Control).

When the address number has been entered, system returns to service menu.

5. Press **EXIT** on the Remote Control or select *BACK* in the graphical display menu, rotating the jog dial to select and pressing to confirm, to exit the GUI.



Menu 20-6

FixYourDLP.com
Sponsored by DM

Discount-Merchant.com (800) 281-8860
THE TRUSTED SOURCE FOR PROJECTOR LAMPS AND ACCESSORIES

20.4.3 Selecting the Transmission Speed

How to set the transmission speed of the RS232 connection

1. Select item *SERIAL COMMUNICATION* in the Service menu by rotating the jog dial on the Master or the ↑ or ↓ keys on the Remote Control.
2. Press the jog dial on the Master or the key ENTER on the Remote Control to confirm.
The sub menu SERIAL COMMUNICATION appears on-screen and in the graphical display, including the possibility to set the Baudrate (transmission speed), the Interface standard RS232/RS422 and the RS422 termination. (menu 20-7)
3. Select item *BAUDRATE* in the Serial Communication menu by rotating the jog dial on the Master or the ↑ or ↓ keys on the Remote Control.
4. Press the jog dial on the Master or the **ENTER** key on the Remote Control to change the Baudrate value between brackets.
Note: Make sure that both the projector and the computer are set for the same Baud rate. Refer to the computer's operation manual for instructions for setting the Baudrate.
5. Press **EXIT** on the Remote Control or select *BACK* in the graphical display menu, rotating the jog dial to select and pressing to confirm, to exit the GUI.

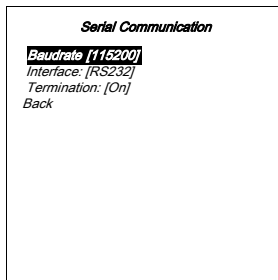

Menu 20-7

20.4.4 Selecting the Interface standard (RS232/RS422)

About Data Transmission

Standards have been developed to insure compatibility between units provided by different manufacturers, and to allow for reasonable success in transferring data over specified distances and/or data rates.

RS232: Single-ended Data Transmission. The specification allows for data transmission from one transmitter to one receiver at relatively slow rates (up to 20K bits/second) and short distances (up to 50Ft. @ the maximum data rate).

RS422: Differential Data Transmission: This standard was designed for greater distances and higher Baud rates. Data rates of up to 100K bits/second and distances up to 4000Ft. can be accommodated with RS422.

How to set the interface standard

Refer to the manual of the connected control unit about the data transmission standard to be set.

1. Select item *INTERFACE* in the Serial Communication menu by rotating the jog dial on the Master or the ↑ or ↓ keys on the Remote Control (Selecting the Transmission Speed, page 143.). (menu 20-8)
2. Press the jog dial on the Master or the **ENTER** key on the Remote Control to change the Interface standard between brackets to RS232 or RS422.
3. Press **EXIT** on the Remote Control or select *BACK* in the graphical display menu, rotating the jog dial to select and pressing to confirm, to exit the GUI.



Menu 20-8

20.4.5 RS422 data bus termination

How to terminate the RS422 data bus

The last control unit on the RS422 data bus has to be terminated.

1. Select item *TERMINATION* in the Serial Communication menu by rotating the jog dial on the Master or the ↑ or ↓ keys on the Remote Control (Selecting the Transmission Speed, page 143.). (menu 20-9)
2. Press the jog dial on the Master or the **ENTER** key on the Remote Control to set the termination to ON.
3. Press **EXIT** on the Remote Control or select *BACK* in the graphical display menu, rotating the jog dial to select and pressing to confirm, to exit the GUI.

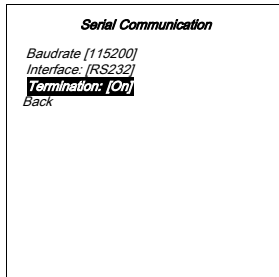

Menu 20-9

20.4.6 Diagnosis

How to interpret the diagnosis table

The diagnosis menu includes a list of I²C controlled IC's. Seven locations are mentioned in the table with the respective address (Hex code), followed by 3 plus signs. The significance of the plus signs is referred to the data communication between the I²C controlled IC's, in order write – read – acknowledge.

If one of the communication parameters is not available, then the respective plus sign is replaced by a minus sign. This info can be useful for the technician if you call for technical assistance.

How to enter the diagnosis menu

1. Select item *I²C DIAGNOSIS* in the Service menu by rotating the jog dial on the Master or the ↑ or ↓ keys on the Remote Control.
2. Press the jog dial on the Master or the key **ENTER** on the Remote Control to confirm.

The Diagnosis table appears on-screen and in the graphical display. (menu 20-10)

3. Press **EXIT** on the Remote Control or select *BACK* in the graphical display menu, rotating the jog dial to select and pressing to confirm, to exit the GUI.

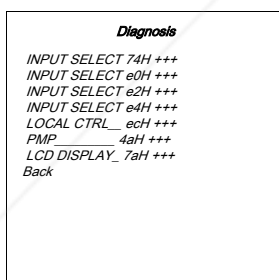

Menu 20-10

21. MAINTENANCE INDICATORS

Overview

- Display Information
- Display Diagnosis
- ColorWheel IndexCine VERSUM 80
- Test Pattern

21.1 Display Information

What info is displayed

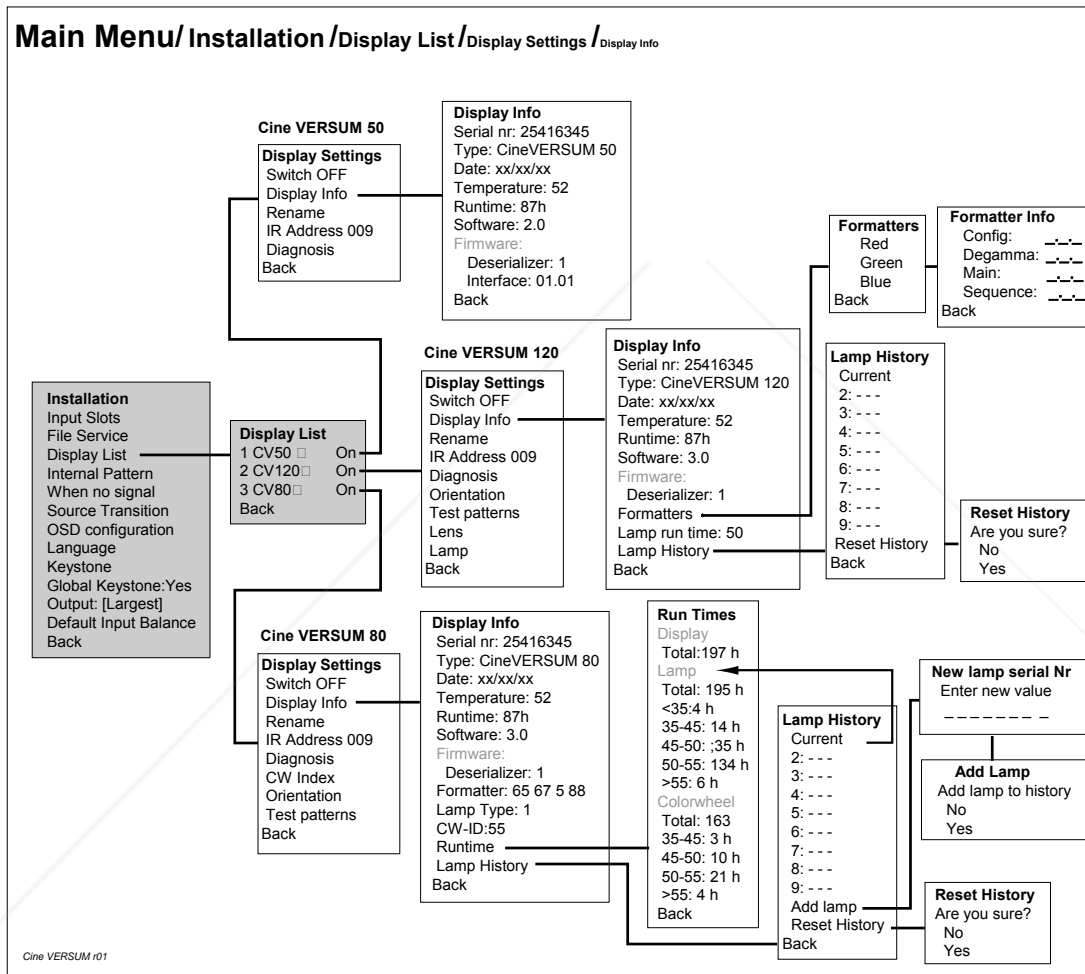

Image 21-1
Display info for Cine VERSUM Master – Cine VERSUM 80 and Cine VERSUM 120

Depending on the selected display in the DISPLAY LIST menu, specific info is displayed on-screen and in the graphical display on the Cine VERSUM Master when selecting DISPLAY INFO in the Display settings menu.

Explanation of the items

| Common for Cine VERSUM 50 – Cine VERSUM 80 and Cine VERSUM 120 | |
|--|------------------------------|
| Serial number | Serial number of the display |
| Type | Kind of the display |
| Date | Date of fabrication |
| Temperature | Inside temperature |

21. Maintenance Indicators

| Common for Cine VERSUM 50 – Cine VERSUM 80 and Cine VERSUM 120 | |
|--|---|
| Runtime | Total operation time of the display |
| Software | Installed software |
| Deserializer | Converts the serial data into parallel data |

| For Cine VERSUM 80 only | |
|-------------------------|--|
| Formatter | Serial number |
| Lamp type | Kind of the display |
| Color Wheel ID | Color wheel identification number |
| Runtime | Via sub menu info about lamp run time and Color wheel run time, split up in ranges of temperature. . |
| Lamp History | Lamp history is kept up to date in the lamp history table. Via sub menu the possibility to add a new lamp and to reset the lamp history. When selecting 'Current' in the lamp history table, lamp run time of the built-in lamp is shown. |

| For Cine VERSUM 120 only | |
|--------------------------|--|
| Formatters | Via sub menu info about the formatter for Red, Green and Blue. |
| Lamp run time | Total time of the lamp operation time. |
| Lamp History | Lamp history is kept up to date in the lamp history table. Via sub menu the possibility to reset the lamp history. When selecting 'Current' in the lamp history table, lamp run time of the built-in lamp is shown. |

| For Cine VERSUM 50 only | |
|-------------------------|----------------|
| Interface | Version number |



Due to rounding errors, the sum of hours in the Run times table is not always equal.

21.2 Display Diagnosis

What info is displayed

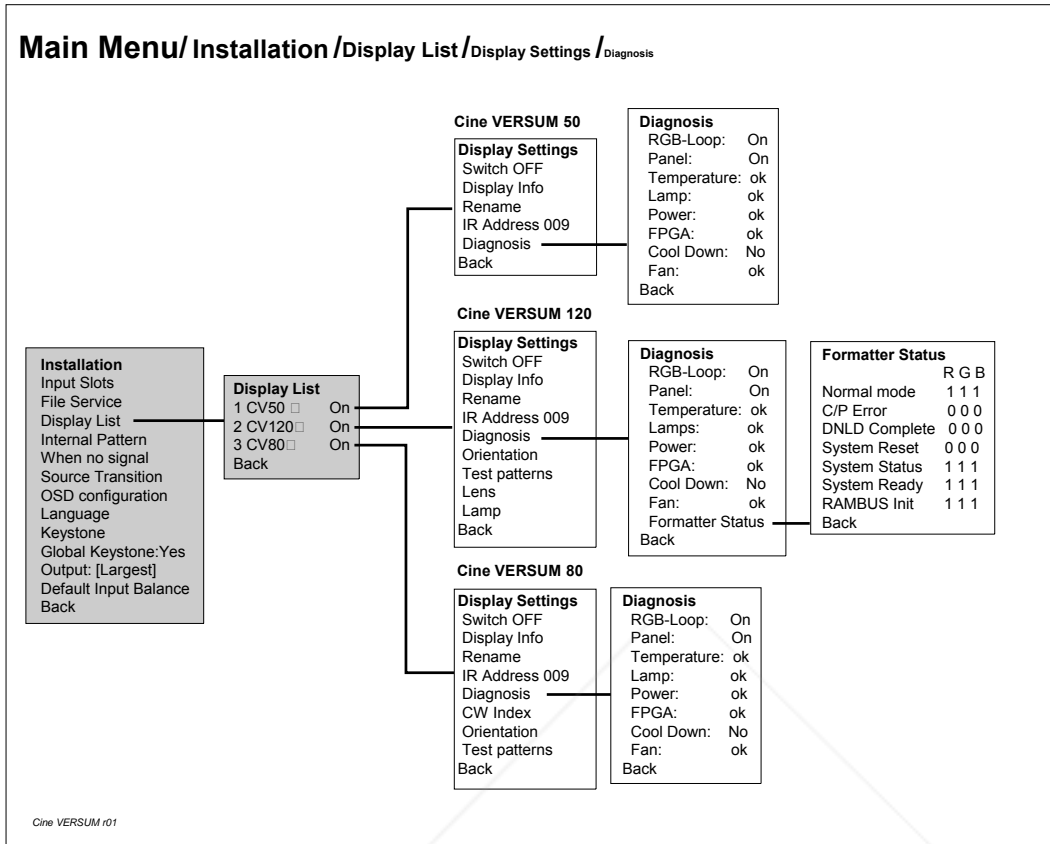

Image 21-2
Diagnostic for Cine VERSUM Master – Cine VERSUM 80 and Cine VERSUM 120

Explanation of the items

| Common for Cine VERSUM 50 – Cine VERSUM 80 and Cine VERSUM 120 | |
|--|---|
| RGB-Loop | On: signal loop-through enabled Off: signal loop-through disabled |
| Panel | On: picture display Off: no picture display |
| Temperature | OK: temperature not out of range |
| Lamp | OK: no lamp failure |
| Power | OK: no power failure |
| FPGA | OK: The programmable components on the deserializer board are configured. |
| Cool down | Yes: display in the cool down mode. Display can not be started up. No: display not in the cool down mode. Display ready for operation. |
| Fan | OK: no Fan failure |
| For Cine VERSUM 120 only | |
| Formatter Status | Info about the formatter board for Red, Green and Blue separately |

| For Cine VERSUM 120 only | |
|--------------------------|---|
| Normal mode | 0: Normal projector mode 1: Flash programming mode |
| Command/Parameter Error | 0: No error 1: Error |
| Download Complete | 0: Incomplete 1: Complete |
| System Reset | 0: System has not been reset 1: System has not been reset since last status read |
| System Status | 0: System failure 1: System OK |
| System Ready | 0: Busy 1: Ready |

21.3 ColorWheel IndexCine VERSUM 80

How to adjust the colorwheel index

1. Select item *CW INDEX* in the display info menu by rotating the jog dial on the Master or the ↑ or ↓ keys on the Remote Control. (image 21-3)
2. Press the jog dial on the Master or the key **ENTER** on the Remote Control to confirm.
The CW (Color Wheel) Index menu appears on-screen and in the graphical display on the Master including the request to use the internal generated test pattern for the adjustment of the color wheel Yes or No. (menu 21-1)
3. Select item YES by rotating the jog dial on the Master or the ↑ or ↓ keys on the Remote Control.
Note: *When you select 'No', then an external horizontal ramp test pattern has to be used as input source for the adjustment of the color wheel index. In this case a bar scale appears on-screen and in the graphical display on the master. The adjustment procedure is the same as for selection 'Yes'.*
4. Press the jog dial on the Master or the key **ENTER** on the Remote Control to confirm.
A horizontal ramp test pattern is displayed (generated in the display itself) and a CW index bar scale appears in the graphical display on the master.
5. Adjust the color wheel index, using the ←and→keys on the Remote Control or by rotating the jog dial on the Master, for an uniformly grey course of the test pattern (no vertical colored bars in the test pattern). (image 21-4)
6. Press **EXIT** on the Remote Control or select *BACK* in the graphical display menu, rotating the jog dial to select and pressing to confirm, to exit the GUI.

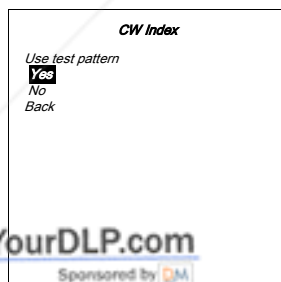

Menu 21-1

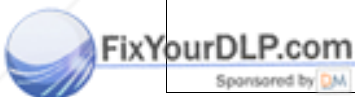

Discount-Merchant.com (800) 281-8860
THE TRUSTED SOURCE FOR PROJECTOR LAMPS AND ACCESSORIES

Main Menu/Installation/Display List/Display Settings/CW Index

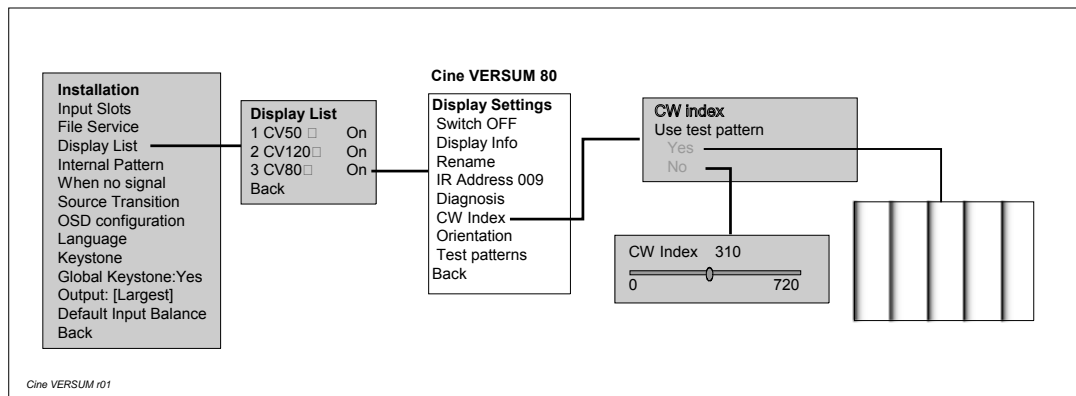

Image 21-3
Color wheel index for Cine VERSUM 80 only

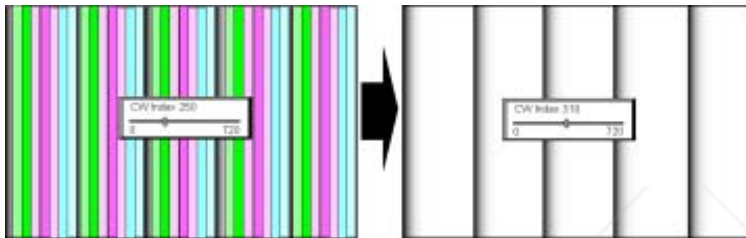

Image 21-4

21.4 Test Pattern

Different test patterns

There are 3 locations where test pattern are generated:

- Cine VERSUM Master: these test patterns are common for all linked displays.
- Cine VERSUM 80: these test patterns are available when the display itself has been addressed.
- Cine VERSUM 120: these test patterns are available when the display itself has been addressed.



The solid field test patterns, generated in the Cine VERSUM 80 and Cine VERSUM 120, are inserted in the output of the formatter and are therefore not subject to any color correction. These test patterns can be used to evaluate the color display of the engine.

Test patterns generated in the Cine VERSUM Master

Main Menu/Installation/Internal pattern

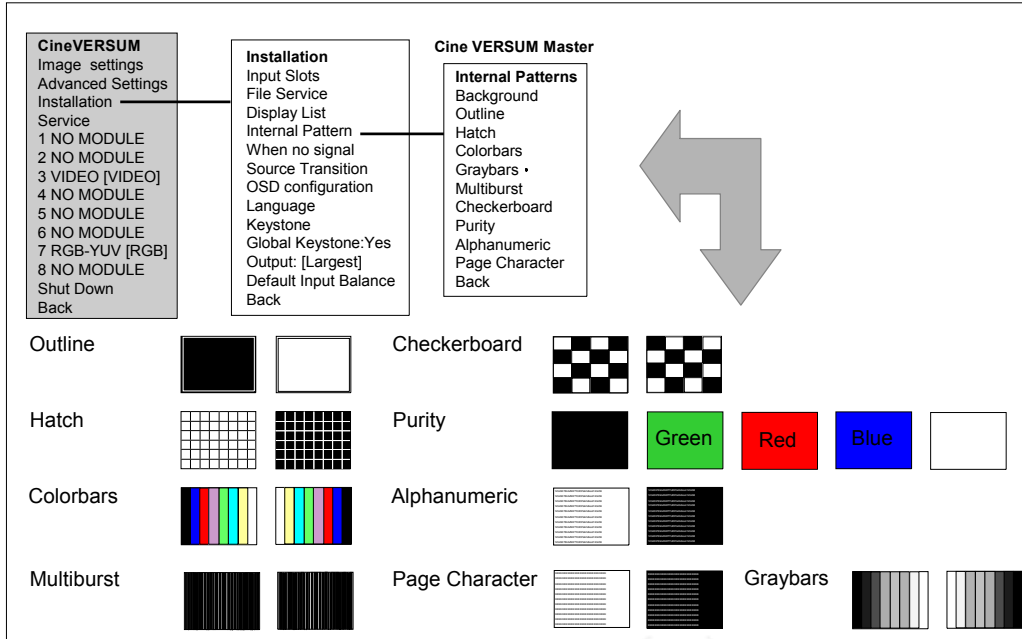

Image 21-5
Test patterns Cine VERSUM Master

Test patterns generated in the Cine VERSUM 80

Main Menu/Installation/Display List/Display Settings /Testpatterns

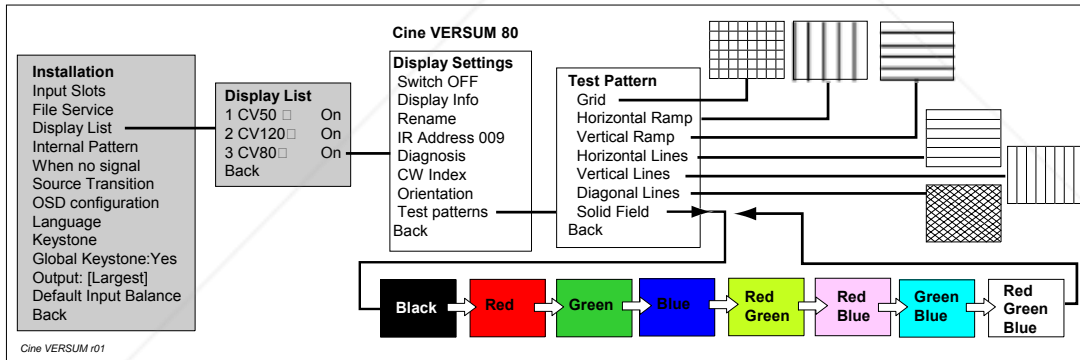

Image 21-6
Test patterns Cine VERSUM 80

Test patterns generated in the Cine VERSUM 120

Main Menu/Installation/Display List/Display Settings/Testpatterns

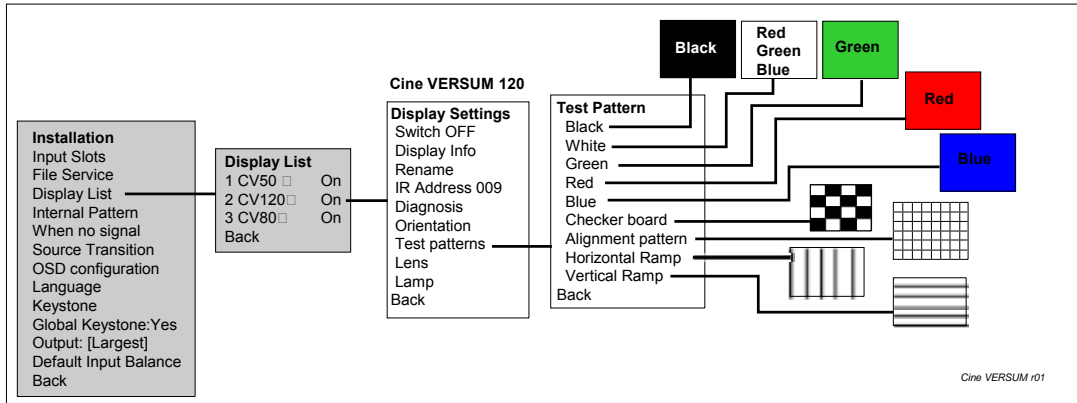

Image 21-7
Test patterns Cine VERSUM 120



Discount-Merchant.com (800) 281-8860
THE TRUSTED SOURCE FOR PROJECTOR LAMPS AND ACCESSORIES

INDEX

A

- Address 93–94, 141
 - Changing 94
 - Cine VERSUM Master 141
 - Default address of the modules 93
 - Reading out 93
 - Reading out/Changing 93
- Analog controls 123
 - Master 123
- Analog controls adjustment 123
 - Display 123
- Analog controls Display 124–125
 - Via Cine VERSUM Master 124
 - Via Display 125

C

- Ceiling mount 40
 - Cine VERSUM 120 40
 - Cine VERSUM 80 40
- Cine VERSUM 120 8, 13
 - Safety instructions 8
- Cine VERSUM 50 7, 12, 41
 - Abstract 12
 - Installation 41
 - Safety instructions 7
- Cine VERSUM 80 8, 13, 28
 - Abstract 13
 - Location of controls 28
 - Safety instructions 8
- Cine VERSUM Master 12, 127, 139–144
 - Abstract 12
 - Additional settings 127
 - Address 141
 - Address change 142
 - Diagnosis 144
 - Identification 139
 - Interface standard 143
 - Password 140
 - RS422 data bus termination 144
 - Transmission speed 143
- Cine VERSUM System 11, 33, 77, 129, 139
 - Concept 11
 - General description 11
 - Installation guidelines 33
 - Master settings & Info 139
 - Powering ON 77
 - Powering up the system 77
 - Shutdown when no signal 129
- Cine VERSUM Systemlink 51
 - General Info 51
- Color temperature 118–120
 - Adjustment 118
 - Customizing 120
 - Selecting 119
- Colorwheel 148
 - Index adjustment 148
- Communication 49
 - Connection 48, 50, 55
 - Communication 48
 - Network 50
 - Preview monitors 48
 - Video equipment 55
- Connections 45, 56
 - Cine VERSUM 50 45
 - Cine VERSUM 80 45
 - Cine VERSUM Master 45
 - Module inputs 56
 - Power supply 45

D

- Decoding standard 109
 - Adjusting 109
- Digital link 51–53
 - To More displays 53
 - To One display 52
- Digital Link 13
 - Abstract 13
- Digital link cable 54
 - Long distances 54
- Digital Video distribution 11
 - Functional Parts 11
- Dimensions 19, 21, 23–24
 - Cine VERSUM 120 23
 - Cine VERSUM 50 24
 - Cine VERSUM 80 21
 - Cine VERSUM Master 19
- Display 91, 123, 133, 145, 147
 - Analog controls adjustment 123
 - Diagnosis 147
 - In/out standby 91
 - Information 145
 - Name change 133
- Display info 78
 - Lost display 78
 - New display 78

E

- Economic standby mode 85
 - Using selection wheel 85
- Electrical Safety 6

F

- File 97, 99
 - Editing 99
 - Loading 97
- File service 97
 - Input source 97

G

- Gamma correction 117
 - Alignment 117

I

- Image 106–107, 110–113, 130
 - Applying the Keystone correction 111
 - Aspect ratio 107
 - Keystone correction 110
 - Keystone correction setting 110
 - Orientation 106
 - Outline 113
 - Shift adjustment 112
 - Size adjustment 113
 - Source transition 130
- Image position 112
 - Shift and Size 112
- Image projection 34, 36, 38, 81
 - Configuration – Projector distance 34
 - Configurations 34
 - Lens control 38
 - Projector distance 36
 - Projector installation requirements 38
 - Using selection wheel 81
 - Using the Remote Control 81
- InfraRed Remote Control 30
 - Location of controls 30
- Input balance 114–116

- Adjustment 116
- Alignment 114
- Selection 115
- Input module 58
- Installation 58
- Input modules 105
- Setup 105
- Input source 99, 102
- File copy 102
- File identification 99
- File rename 102
- Installation 7
- Safety precautions 7
- Installation CV50 41–42
- Table mount kit 42
- Wall mount kit 41
- Installation Guidelines 33
- Condition Check 33
- Screen Type 33
- Internal pattern 128

L

- Lamp mode 82–83
- Economic/Normal 83
- Set up 82
- Single/Dual 82
- Lamp selection 83
- Lamp 1 or 2 83
- Lens 34
- Cleaning 34
- Lens control 38
- Location of controls 27
- Cine VERSUM Master 27
- Location of User's controls 29
- Cine VERSUM 120 29
- Locations of controls 27
- Cine VERSUM 50 27

M

- Main fuse 47
- Maintenance 145
- Indicators 145
- Master 123
- Analog controls 123
- Menu 69–72, 75
- Advanced settings 71
- Image settings 70
- Installation 72
- Main menu 69
- Service 75
- Menu displays 65
- Explanation about differences 65
- Menu screens 69
- Overview 69
- Menus 65
- Points of similarity 65
- Module address 93
- Read out /Change 93

O

- On screen display 130–132
- Configuration 130
- Explanation 130
- Position alignment 132
- Status change 132
- On-Screen display 132
- Language 132
- Operating 61
- Remote Control 61
- Output resolution 127
- Set up 127

P

- Phase (RGB-YUV) 117
- Adjustment 117
- Picture 81, 105
- Adjusting 105
- Projection 81
- Picture controls 122
- Adjusting 122
- PiP 135
- Selecting input source 135
- PIP 135
- Turning On/Off 135
- PIP Window 136
- Configuration 136
- Plasma Screen 41
- Installation guidelines 41
- Power connection 45–47
- Cine VERSUM 120 47
- Cine VERSUM 50 47
- Cine VERSUM 80 46
- Cine VERSUM Master 45
- Power consumption 47
- Power cords 45
- Power specifications 47
- Power Supply 45
- Power voltage 47
- Preview monitors 48
- Connection 48
- Product specifications 8
- Safety precautions 8
- Projection Stop 85
- Economic standby mode 85
- Standby mode 85
- Projector 33
- Installation guidelines 33
- General 33
- Projector configurations 34
- Projector distance 36

R

- Remote control 63
- Address setting 63
- Remote Control 61–62
- Battery insertion 61
- Operating 61
- Operation 62

S

- Safety instruction 5
- Safety instructions 5, 7
- General 5
- Module related 7
- Safety Instructions 6–9
- Heat and Fire Hazards 8
- On cleaning 7
- On Shipping 7
- Protection on Servicing 6
- Ultraviolet Radiation 9
- Safety Precautions 9
- Safety on Installation 9
- Service menu 139
- Selection 139
- Sources 103–104
- Deleting a file 103
- Deleting all files 104
- File load 104
- File sort 104
- Standby mode 85–86
- Direct access 86
- Using Remote Control 86
- Via screen menu 86
- Status of the system 77
- Stored files 97

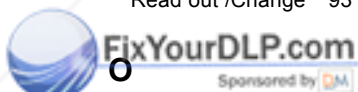

Discount-Merchant.com (800) 281-8860
 THE #1 SOURCE FOR PROJECTOR LAMPS AND ACCESSORIES

Switching In/Out standby 89–91
Using the jog dial 89
Using the Remote Control 90–91
 On address Cine VERSUM Master 90
 On address pointed display 91
 via Cine VERSUM Master 89
Switching linked displays 89
 To and Out standby 89

T

Test pattern 149
 Cine VERSUM 120 149
 Cine VERSUM 80 149
 Cine VERSUM Master 149

U

Unpacking 15–18
 Cine VERSUM 120 17
 Cine VERSUM 50 18
 Cine VERSUM 80 16
 Cine VERSUM Master 15

W

White peak 109
 Set up 109



Discount-Merchant.com (800) 281-8860
THE TRUSTED SOURCE FOR PROJECTOR LAMPS AND ACCESSORIES



Discount-Merchant.com (800) 281-8860
THE TRUSTED SOURCE FOR PROJECTOR LAMPS AND ACCESSORIES

Revision Sheet

To:

► **Barco nv Home Cinema/Documentation**
Noordlaan 5, B-8520 Kuurne
Phone: +32 56.36.84.30, Fax: +32 56.36.88.62
E-mail: antoon.dejaegher@barco.com, Web: www.homecinema.barco.com

From: _____

Date: _____

Please correct the following points in this documentation (**R5976468/01**):

page

wrong

correct



Discount-Merchant.com (800) 281-8860
THE TRUSTED SOURCE FOR PROJECTOR LAMPS AND ACCESSORIES



Disclaimer

This user manual is provided as a free service by FixYourDLP.com. FixYourDLP is in no way responsible for the content of this manual, nor do we guarantee its accuracy. FixYourDLP does not make any claim of copyright and all copyrights remain the property of their respective owners.

About FixYourDLP.com

FixYourDLP.com (<http://www.fixyourdpl.com>) is the World's #1 resource for media product news, reviews, do-it-yourself guides, and manuals.

Informational Blog: <http://www.fixyourdpl.com>

Video Guides: <http://www.fixyourdpl.com/guides>

User Forums: <http://www.fixyourdpl.com/forum>

FixYourDLP's Fight Against Counterfeit Lamps:

<http://www.fixyourdpl.com/counterfeits>

Sponsors:

RecycleYourLamp.org – Free lamp recycling services for used lamps:

<http://www.recycleyourlamp.org>

Lamp Research - The trusted 3rd party lamp research company:

<http://www.lampresearch.com>

Discount-Merchant.com – The worlds largest lamp distributor:

<http://www.discount-merchant.com>



FixYourDLP.com

Sponsored by 