



# Disclaimer

This user manual is provided as a free service by FixYourDLP.com. FixYourDLP is in no way responsible for the content of this manual, nor do we guarantee its accuracy. FixYourDLP does not make any claim of copyright and all copyrights remain the property of their respective owners.

About FixYourDLP.com

FixYourDLP.com (<http://www.fixyourdpl.com>) is the World's #1 resource for media product news, reviews, do-it-yourself guides, and manuals.

Informational Blog: <http://www.fixyourdpl.com>

Video Guides: <http://www.fixyourdpl.com/guides>

User Forums: <http://www.fixyourdpl.com/forum>

FixYourDLP's Fight Against Counterfeit Lamps:

<http://www.fixyourdpl.com/counterfeits>

## Sponsors:

RecycleYourLamp.org – Free lamp recycling services for used lamps:

<http://www.recycleyourlamp.org>

Lamp Research - The trusted 3rd party lamp research company:

<http://www.lampresearch.com>

Discount-Merchant.com – The worlds largest lamp distributor:

<http://www.discount-merchant.com>



**FixYourDLP.com**

Sponsored by 



# Multimedia Projector

## MODEL PLC-WM4500

## PLC-WM4500L \*

### Network Supported

Refer to the Owner's Manual below for details about network function.

Network Set-up and Operation

\* Projection lens is optional.

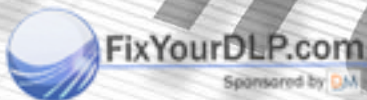
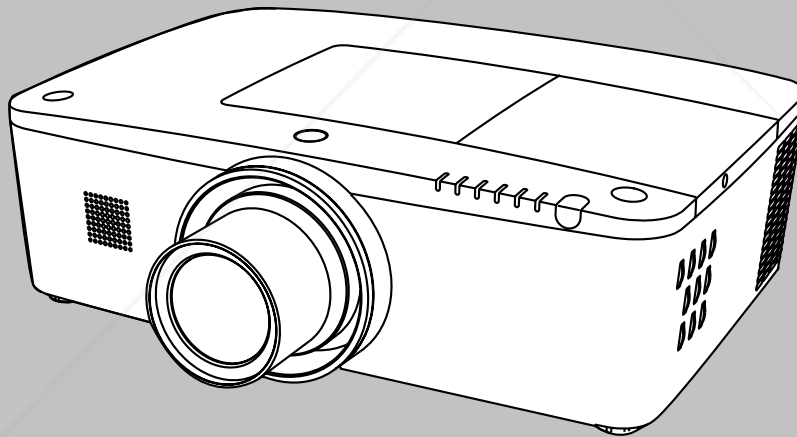

**Discount-Merchant.com (800) 281-8860**

THE TRUSTED SOURCE FOR PROJECTOR LAMPS AND ACCESSORIES

# Owner's Manual



PROJECTOR

# Features and Design

This Multimedia Projector is designed with most advanced technology for portability, durability, and ease of use. This projector utilizes built-in multimedia features, a palette of 1.07 billion colors, and matrix liquid crystal display (LCD) technology.

## ◆ **Functionally Rich**

This projector has many useful functions such as lens shifting, ceiling and rear projection, perpendicular omnidirectional projection, variety of lens options, etc.

## ◆ **Multi-use Remote Control**

Use the remote control as wired and wireless, or as a PC wireless mouse. Eight remote control codes and selectable pointer shapes are also available.

## ◆ **Simple Computer System Setting**

The projector has the Multi-scan system to conform to almost all computer output signals quickly (p.36). Supported resolution up to WUXGA.

## ◆ **Useful Functions for Presentation**

Digital zoom function allows you to focus on the crucial information during a presentation (pp.29, 43).

## ◆ **Security Function**

The Security function helps you to ensure security of the projector. With the Key lock function, you can lock the operation on the side control or remote control (p.61). PIN code lock function prevents unauthorized use of the projector (pp.61-62).

## ◆ **Power Management**

The Power management function reduces power consumption and maintains lamp life (p.59).

## ◆ **Picture in Picture Function**

This projector is capable of projecting two images simultaneously by using either built-in P in P mode or P by P mode (pp.55-56).

## ◆ **Motor-driven Lens Shift**

Projection lens can be moved up, down, right and left with the motor-driven lens shift function. This function makes it easy to provide projected image where you want. Zoom and focus can also be adjusted with a motor-driven operation. (p.27)

## ◆ **Multilanguage Menu Display**

Operation menu is available in 12 languages; English, German, French, Italian, Spanish, Portuguese, Dutch, Swedish, Russian, Chinese, Korean, and Japanese (p.51).

## ◆ **Logo Function**

The Logo function allows you to customize the screen logo (pp.52-54). You can capture an image for the screen logo and use it for the starting-up display or between presentations.

## ◆ **Pointer Function**

Remote control pointer function. This function helps you to make a smart presentation on a projected screen.

## ◆ **Multiple Interface Terminals**

The projector has several interface terminals that can support various types of equipment and signals (p.11).

## ◆ **Closed Caption**

This is a printed version of the program sound or other information displayed on the screen. You can turn on the feature and switch the channels (p.63).



**Discount-Merchant.com (800) 281-8860**  
**THE TRUSTED SOURCE FOR PROJECTOR LAMPS AND ACCESSORIES**

### ✓ **Note:**

- The On-Screen Menu and figures in this manual may differ slightly from the product.
- The contents of this manual are subject to change without notice.

# Table of Contents

<b>Features and Design</b> .....	<b>2</b>	Wireless Mouse Operation	32
<b>Table of Contents</b> .....	<b>3</b>	<b>Input Selection</b> .....	<b>33</b>
<b>To The Owner</b> .....	<b>4</b>	Direct Operation	33
<b>Safety Instructions</b> .....	<b>5</b>	Computer Input Source Selection	34
Air Circulation	6	Video Input Source Selection	35
Installing the Projector in Proper Directions	7	<b>Computer Input</b> .....	<b>36</b>
Moving the Projector	8	Computer System Selection	36
Cautions in Handling the Projector	8	Auto PC Adjustment	37
<b>Compliance</b> .....	<b>9</b>	Manual PC Adjustment	38
<b>Part Names and Functions</b> .....	<b>10</b>	Image Level Selection	40
Front	10	Image Adjustment	41
Back	10	Screen Size Adjustment	42
Bottom	10	<b>Video Input</b> .....	<b>45</b>
Rear Terminal	11	Video System Selection	45
Side Control and Indicators	12	Image Level Selection	46
Remote Control	13	Image Adjustment	47
Remote Control Battery Installation	15	Screen Size Adjustment	49
Remote Control Receivers and Operating Range	15	<b>Setting</b> .....	<b>51</b>
Wired Remote Control Transmitter	15	Setting	51
Remote Control Code	16	<b>Maintenance and Care</b> .....	<b>65</b>
Adjustable Feet	16	Filter Instructions	65
<b>Installation</b> .....	<b>17</b>	Replacing the Filter Cartridge	66
Positioning the Projector	17	Resetting the Filter Counter	67
Lens Shift Adjustment	17	Lamp Replacement	68
Lens Installation	18	Cleaning the Projection Lens	70
Connecting to a Computer		Cleaning the Projector Cabinet	70
(Digital and Analog RGB)	19	Warning Indicators	71
Connecting to Video Equipment		<b>Appendix</b> .....	<b>72</b>
(Video, S-video, HDMI)	20	Troubleshooting	72
Connecting for Audio Signal	21	Menu Tree	75
Connecting the AC Power Cord	22	Indicators and Projector Condition	78
<b>Basic Operation</b> .....	<b>23</b>	Compatible Computer Specifications	81
Turning On the Projector	23	Technical Specifications	83
Turning Off the Projector	24	Optional Parts	84
How to Operate the On-Screen Menu	25	Lens Replacement	84
Menu Bar	26	PJ Link Notice	84
Operating with Projector Control	27	Configurations of Terminals	85
Sound Adjustment	28	PIN Code Number Memo	86
Operating with Remote Control	29	Dimensions	87
Keystone Correction	31	List of Picture in Picture	88
Pointer Function	32	Serial Control Interface	88

## Trademarks

Each name of corporations or products in this book is either a registered trademark or a trademark of its respective corporation.





# To The Owner

Before installing and operating the projector, read this manual thoroughly.

The projector provides many convenient features and functions. Operating the projector properly enables you to manage those features and maintains it in good condition for many years to come.

Improper operation may result in not only shortening the product life, but also malfunctions, fire hazard, or other accidents.

If your projector seems to operate improperly, read this manual again, check operations and cable connections and try the solutions in the "Troubleshooting" section in the back of this manual. If the problem still persists, contact the dealer where you purchased the projector or the service center.

 <b>CAUTION</b> <b>RISK OF ELECTRIC SHOCK</b> <b>DO NOT OPEN</b> 
<b>CAUTION: TO REDUCE THE RISK OF ELECTRIC SHOCK, DO NOT REMOVE COVER (OR BACK). NO USER-SERVICEABLE PARTS INSIDE EXCEPT LAMP REPLACEMENT. REFER SERVICING TO QUALIFIED SERVICE PERSONNEL.</b>
 THIS SYMBOL INDICATES THAT DANGEROUS VOLTAGE CONSTITUTING A RISK OF ELECTRIC SHOCK IS PRESENT WITHIN THIS UNIT.
 THIS SYMBOL INDICATES THAT THERE ARE IMPORTANT OPERATING AND MAINTENANCE INSTRUCTIONS IN THE OWNER'S MANUAL WITH THIS UNIT.

## FOR EU USERS

The symbol mark and recycling systems described below apply to EU countries and do not apply to countries in other areas of the world.

Your product is designed and manufactured with high quality materials and components which can be recycled and/or reused.

The symbol mark means that electrical and electronic equipment, batteries and accumulators, at their end-of-life, should be disposed of separately from your household waste.

Note:

If a chemical symbol is printed beneath the symbol mark, this chemical symbol means that the battery or accumulator contains a heavy metal at a certain concentration. This will be indicated as follows: Hg: mercury, Cd: cadmium, Pb: lead

In the European Union there are separate collection systems for used electrical and electronic equipment, batteries and accumulators.

Please, dispose of them correctly at your local community waste collection/recycling centre.

Please, help us to conserve the environment we live in!



**READ AND KEEP THIS OWNER'S MANUAL FOR LATER USE.**



## Safety Precaution

**WARNING: ● THIS APPARATUS MUST BE EARTHED.**

**● TO REDUCE THE RISK OF FIRE OR ELECTRIC SHOCK, DO NOT EXPOSE THIS APPLIANCE TO RAIN OR MOISTURE.**

- This projector produces intense light from the projection lens. Do not stare directly into the lens, otherwise eye damage could result. Be especially careful that children do not stare directly into the beam.
- Install the projector in a proper position. Otherwise it may result in a fire hazard.
- Allowing the proper amount of space on the top, sides, and rear of the projector cabinet is critical for proper air circulation and cooling of the unit. The diagrams shown here indicate the minimum space required. If the projector is to be built into a compartment or similarly enclosed, these minimum distances must be maintained.
- Do not cover the ventilation slots on the projector. Heat build-up can reduce the service life of your projector, and can also be dangerous.

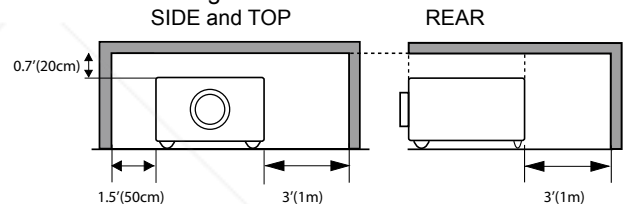

- If the projector is unused for an extended time, unplug the projector from the power outlet.
- Do not project the same image for a long time. The afterimage may remain on the LCD panels by the characteristic of panel.



## CAUTION ON HANGING FROM THE CEILING

**DO NOT SET THE PROJECTOR IN GREASY, WET, OR SMOKY CONDITIONS SUCH AS IN A KITCHEN TO PREVENT A BREAKDOWN OR A DISASTER. IF THE PROJECTOR COMES IN CONTACT WITH OIL OR CHEMICALS, IT MAY BECOME DETERIORATED.**

## CAUTION

Not for use in a computer room as defined in the Standard for the Protection of Electronic Computer/Data Processing Equipment, ANSI/NFPA 75.

# Safety Instructions

All the safety and operating instructions should be read before the product is operated.

Read all of the instructions given here and retain them for later use. Unplug this projector from AC power supply before cleaning. Do not use liquid or aerosol cleaners. Use a damp cloth for cleaning.

Follow all warnings and instructions marked on the projector.

For added protection to the projector during a lightning storm, or when it is left unattended and unused for long periods of time, unplug it from the wall outlet. This will prevent damage due to lightning and power line surges.

---

Do not expose this unit to rain or use near water, for example, in a wet basement, near a swimming pool, etc..

Do not use attachments not recommended by the manufacturer as they may cause hazards.

Do not place this projector on an unstable cart, stand, or table. The projector may fall, causing serious injury to a child or adult, and serious damage to the projector. Use only with a cart or stand recommended by the manufacturer, or sold with the projector. Wall or shelf mounting should follow the manufacturer's instructions, and should use a mounting kit approved by the manufacturers.

An appliance and cart combination should be moved with care. Quick stops, excessive force, and uneven surfaces may cause the appliance and cart combination to overturn.



---

Slots and openings in the back and side of the cabinet are provided for ventilation, to ensure reliable operation of the equipment and to protect it from overheating.

The openings should never be covered with cloth or other materials, and the bottom opening should not be blocked by placing the projector on a bed, sofa, rug, or other similar surface. This projector should never be placed near or over a radiator or heat register.

This projector should not be placed in a built-in installation such as a book case unless proper ventilation is provided.

Never push objects of any kind into this projector through cabinet slots as they may touch dangerous voltage points or short out parts that could result in a fire or electric shock. Never spill liquid of any kind on the projector.

Do not install the projector near the ventilation duct of air conditioning equipment.

This projector should be operated only from the type of power source indicated on the marking label. If you are not sure of the type of power supplied, consult your authorized dealer or local power company.

Do not overload wall outlets and extension cords as this can result in fire or electric shock. Do not allow anything to rest on the power cord. Do not locate this projector where the cord may be damaged by persons walking on it.

Do not attempt to service this projector yourself as opening or removing covers may expose you to dangerous voltage or other hazards. Refer all servicing to qualified service personnel.

Unplug this projector from wall outlet and refer servicing to qualified service personnel under the following conditions:

- a. When the power cord or plug is damaged or frayed.
- b. If liquid has been spilled into the projector.
- c. If the projector has been exposed to rain or water.
- d. If the projector does not operate normally by following the operating instructions. Adjust only those controls that are covered by the operating instructions as improper adjustment of other controls may result in damage and will often require extensive work by a qualified technician to restore the projector to normal operation.
- e. If the projector has been dropped or the cabinet has been damaged.
- f. When the projector exhibits a distinct change in performance-this indicates a need for service.

When replacement parts are required, be sure the service technician has used replacement parts specified by the manufacturer that have the same characteristics as the original part. Unauthorized substitutions may result in fire, electric shock, or injury to persons.

Upon completion of any service or repairs to this projector, ask the service technician to perform routine safety checks to determine that the projector is in safe operating condition.

## NOTE FOR CUSTOMERS IN THE US

Ⓜ LAMP(S) INSIDE THIS PRODUCT CONTAIN MERCURY AND MUST BE RECYCLED OR DISPOSED OF ACCORDING TO LOCAL, STATE OR FEDERAL LAWS.

## Air Circulation

Openings in the cabinet are provided for ventilation. To ensure reliable operation of the product and to protect it from overheating, these openings must not be blocked or covered.

### CAUTION

Hot air is exhausted from the exhaust vent. When using or installing the projector, the following precautions should be taken.

- Do not put any flammable object or spray can near the projector, hot air is exhausted from the air vents.
- Keep the exhaust vent at least 3' (1 m) away from any objects.
- Do not touch peripheral parts of the exhaust vent, especially screws and metallic parts. These areas will become hot while the projector is being used.
- Do not put anything on the cabinet. Objects put on the cabinet will not only get damaged but also may cause fire hazard by heat.

Cooling fans are provided to cool down the projector. The fans' running speed is changed according to the temperature inside the projector.

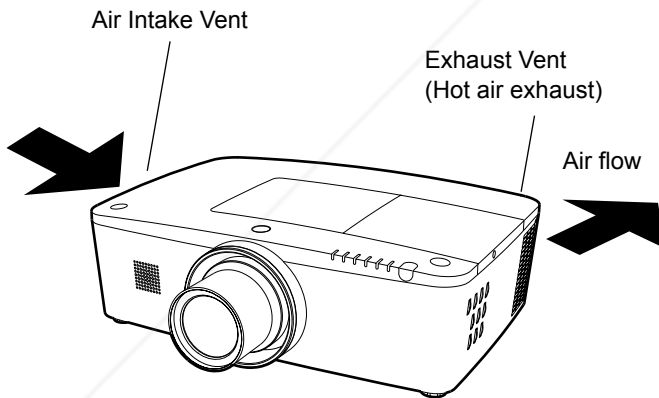

### IMPORTANT!

#### Filter Maintenance!!

The projector uses a lamp which generates significant heat. The cooling fans and air vents are provided to dissipate the heat by drawing air into the housing and the filter is located in the intake vents to prevent dust from getting inside of the projector.

In order to care for the projector appropriately, regular cleaning is required. Remove any dirt or dust that has accumulated on the projector.

If the projector reaches a time set in the timer setting, a Filter warning icon (Fig. 1) appears on the screen and WARNING FILTER indicator on the top panel lights up (see below), indicating that the filter replacement is necessary.

Blocking the air vents and leaving the projector uncleaned for a long time may not only damage the projector and may require costly repairs but may also cause accidents or fire.

For maintenance of the filter, refer to "Filter counter" on page 64 and "Maintenance and Care" on pages 65-67.

**Damages to the projector caused by using an uncleaned filter or improper maintenance will void the warranty on the projector.**

#### Top Panel

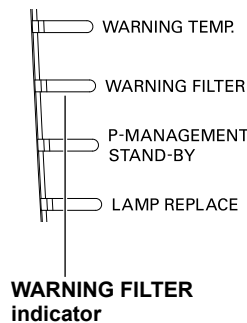

Fig. 1 Filter warning icon

## Installing the Projector in Proper Directions

Use the projector properly in specified positions. Improper positioning may reduce the lamp life and result in severe accident or fire hazard.

This projector can project the picture in upward, downward, or inclined position in perpendicular direction to the horizontal plane. When installing the projector in downwardly inclined position, install the projector bottom side up.

✓ **Note:**  
To inverse or reverse the image, set the ceiling function to **On**. (pp. 44, 50)

### Positioning Precautions

Avoid positioning the projector as described below when installing.

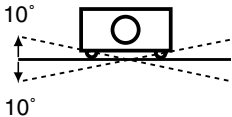

Do not tilt the projector more than 10 degrees from side to side.



Do not put the projector on either side to project an image.

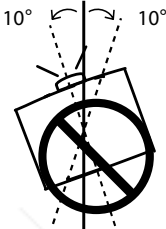

In upward projection, do not tilt the projector over 10 degrees right and left.

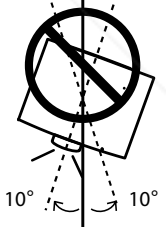

In downward projection, do not tilt the projector over 10 degrees right and left.



### CAUTION ON CEILING MOUNTING

For ceiling mounting, you need the ceiling mount kit designed for this projector. When not mounted properly, the projector may fall, causing hazards or injury. For details, consult your dealer. The warranty on this projector does not cover any damage caused by use of any non-recommended ceiling mount kit or installation of the ceiling mount kit in an improper location.



**Discount-Merchant.com (800) 281-8860**  
**THE TRUSTED SOURCE FOR PROJECTOR LAMPS AND ACCESSORIES**



## Moving the Projector

### Notes on protector

Remove the protector on the lens before use, and keep it for later use. For transportation, press and hold the LENS button or LENS SHIFT button to adjust the lens to the central position when four arrows turn to red, and then attach the protector to protect the lens (Only for PLC-WM4500).

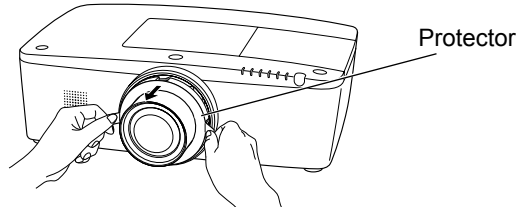

Use the handle grip when moving the projector.

Retract the adjustable feet to prevent damage to the lens and cabinet when carrying.

When this projector is not in use for an extended period, put it into a suitable case to protect the projector.

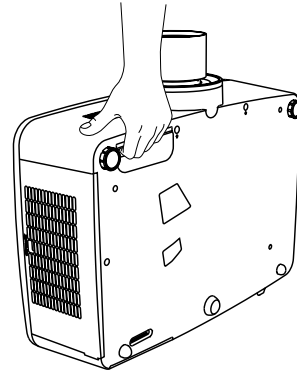

### CAUTION IN CARRYING OR TRANSPORTING THE PROJECTOR

- Do not drop or bump the projector, otherwise damages or malfunctions may result.
- When carrying the projector, use a suitable carrying case.
- Do not transport the projector by courier or any other transport service in an unsuitable transport case. This may cause damage to the projector. For information about transporting the projector by courier or any other transport service, consult your dealer.
- Do not put the projector in a case before it is cooled enough.

## Cautions in Handling the Projector

Do not hold the lens or the lens compartment tube when lifting or moving the projector. Doing so may cause damage to the lens and the projector.

Care must be taken when handling the projector; do not drop, bump, subject it to strong forces, or put other things on the cabinet.

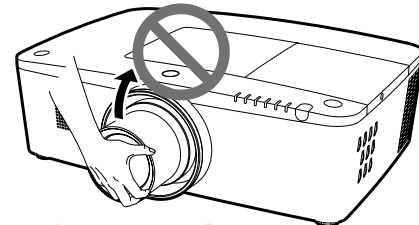
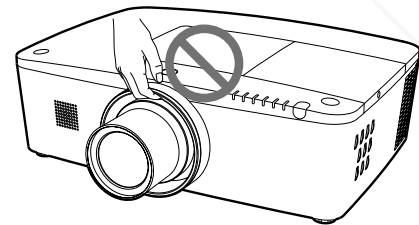

### CAUTION



Projection lens is a motorized lens. Please note the followings when using the projector.

- Do not touch the lens while it is moving as this could cause injury to the fingers.
- Never allow children to touch the lens.

Do not hold the lens and the peripheral part.

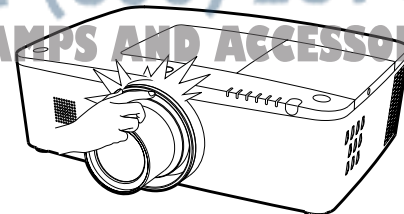

# Compliance

## Federal Communications Commission Notice

Note: This equipment has been tested and found to comply with the limits for a Class B digital device, pursuant to Part 15 of the FCC Rules. These limits are designed to provide reasonable protection against harmful interference in a residential installation. This equipment generates, uses and can radiate radio frequency energy and, if not installed and used in accordance with the instructions, may cause harmful interference to radio communications. However, there is no guarantee that interference will not occur in a particular installation. If this equipment does cause harmful interference to radio or television reception, which can be determined by turning the equipment off and on, the user is encouraged to try to correct the interference by one or more of the following measures:

- Reorient or relocate the receiving antenna.
- Increase the separation between the equipment and receiver.
- Connect the equipment into an outlet on a circuit different from that to which the receiver is connected.
- Consult the dealer or an experienced radio/TV technician for help.

Use of shielded cable is required to comply with class B limits in Subpart B of Part 15 of FCC Rules.

Do not make any changes or modifications to the equipment unless otherwise specified in the instructions. If such changes or modifications should be made, you could be required to stop operation of the equipment.

Model Number : PLC-WM4500, PLC-WM4500L  
Trade Name : Sanyo  
Responsible party : SANYO NORTH AMERICA CORPORATION  
Address : 21605 Plummer Street, Chatsworth, California 91311, U.S.A.  
Telephone No. : (818)998-7322

## AC Power Cord Requirement

The AC Power Cord supplied with this projector meets the requirement for use in the country you purchased it.

### AC Power Cord for the United States and Canada:

AC Power Cord used in the United States and Canada is listed by the Underwriters Laboratories (UL) and certified by the Canadian Standard Association (CSA).

AC Power Cord has a grounding-type AC line plug. This is a safety feature to be sure that the plug will fit into the power outlet. Do not try to defeat this safety feature. Should you be unable to insert the plug into the outlet, contact your electrician.

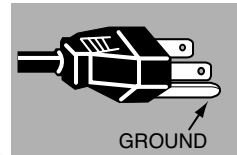

### AC Power Cord for the United Kingdom:

This cord is already fitted with a moulded plug incorporating a fuse, the value of which is indicated on the pin face of the plug. Should the fuse need to be replaced, an ASTA approved BS 1362 fuse must be used of the same rating, marked thus  $\diamond$ . If the fuse cover is detachable, never use the plug with the cover omitted. If a replacement fuse cover is required, ensure it is of the same colour as that visible on the pin face of the plug (i.e. red or orange). Fuse covers are available from the Parts Department indicated in your User Instructions.

If the plug supplied is not suitable for your socket outlet, it should be cut off and destroyed.

The end of the flexible cord should be suitably prepared and the correct plug fitted.

**WARNING: A PLUG WITH BARED FLEXIBLE CORD IS HAZARDOUS IF ENGAGED IN A LIVE SOCKET OUTLET.**

The Wires in this mains lead are coloured in accordance with the following code:

Green-and-yellow ..... Earth  
Blue ..... Neutral  
Brown ..... Live

As the colours of the wires in the mains lead of this apparatus may not correspond with the coloured markings identifying the terminals in your plug proceed as follows:

The wire which is coloured green-and-yellow must be connected to the terminal in the plug which is marked by the letter E or by the safety earth symbol  $\perp$  or coloured green or green-and-yellow.

The wire which is coloured blue must be connected to the terminal which is marked with the letter N or coloured black.

The wire which is coloured brown must be connected to the terminal which is marked with the letter L or coloured red.

**WARNING: THIS APPARATUS MUST BE EARTHED.**

**THE SOCKET-OUTLET SHOULD BE INSTALLED NEAR THE EQUIPMENT AND EASILY ACCESSIBLE.**

# Part Names and Functions

## Front

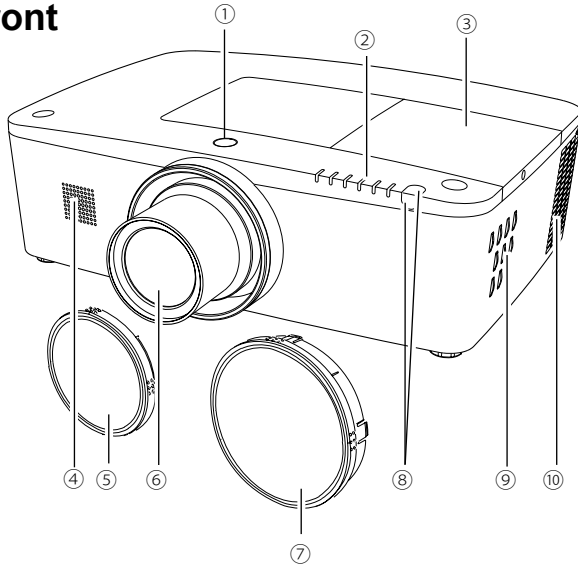

- ① Lens Release Button
- ② Indicators
- ③ Lamp Cover
- ④ Speaker
- ⑤ Lens Cap  
(for PLC-WM4500)
- ⑥ Projection Lens  
(for PLC-WM4500)
- ⑦ Lens Mount Cover  
(for PLC-WM4500L)
- ⑧ Infrared Remote Receiver (Front & Top)
- ⑨ Side Controls

- ⑩ Exhaust Vent

## Back

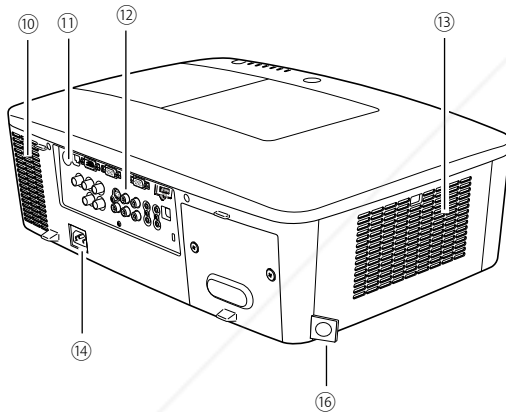

Hot air is exhausted from the exhaust vent. Do not put heat-sensitive objects near this side.

- ⑪ Infrared Remote Receiver (Back)
- ⑫ Terminals and Connectors
- ⑬ Filter Cover & Air Intake Vent
- ⑭ Power Cord Connector

## Bottom

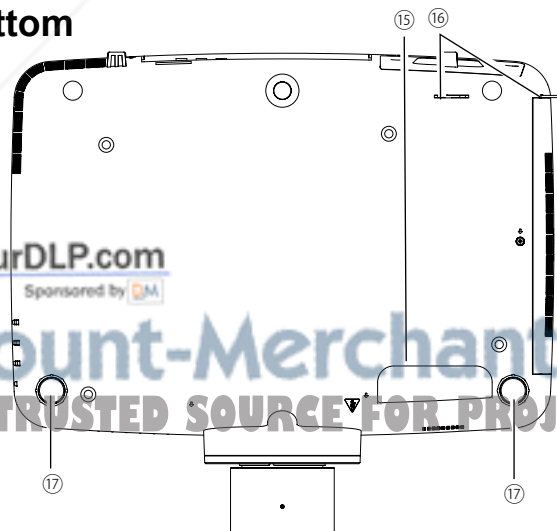

- ⑮ Hand Grip
- ⑯ Security Chain Hook
- ✓ **Note:**  
*This is not a handle for carrying the projector.  
Do not carry the projector with this hook.*
- ⑰ Adjustable Feet

Rear Terminal

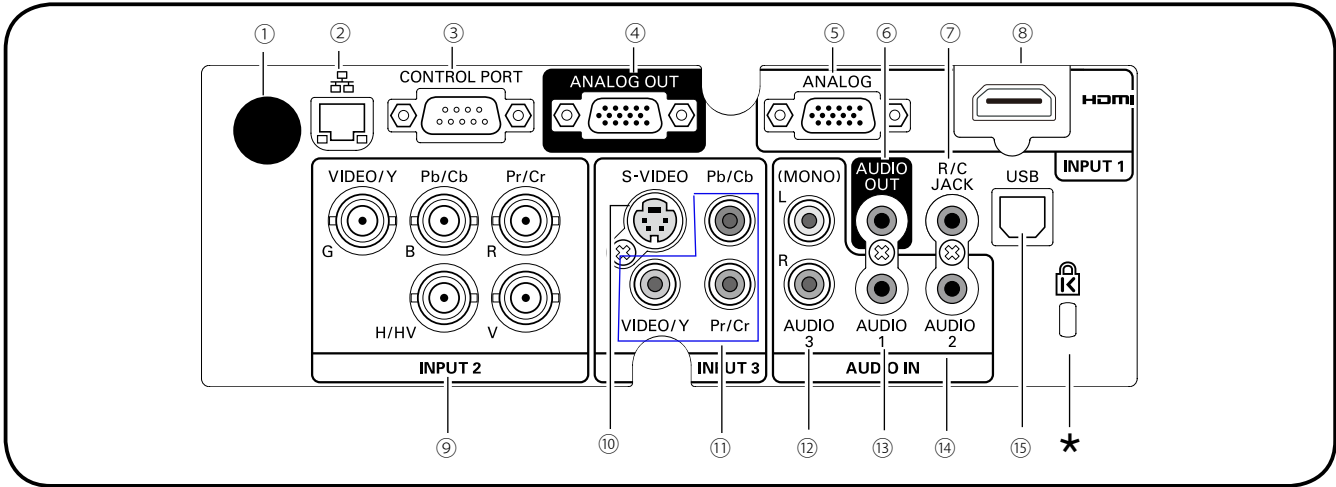

- ① **INFRARED REMOTE RECEIVER (Back)**  
The infrared remote receiver is also located in the front and top (pp.10, 15).
- ② **LAN CONNECTION TERMINAL**  
Connect the LAN cable (refer to the owner's manual of "Network Set-up and Operation").
- ③ **CONTROL PORT CONNECTOR**  
When controlling the projector with RS-232C, connect the control equipment to this connector with the serial control cable. (p.19)
- ④ **ANALOG OUT TERMINAL**  
This terminal can be used to output the incoming analog RGB signal from INPUT 1-3 terminal to the other monitor (pp.19-20).
- ⑤ **COMPUTER INPUT TERMINAL (ANALOG)**  
Connect the computer (or RGB scart) output signal to this terminal (pp.19-20).
- ⑥ **AUDIO OUTPUT JACK**  
This jack outputs the audio signal from computer or video or HDMI equipment to external audio equipment (p.21).
- ⑦ **R/C JACK**  
When using the wired remote control, connect the wired remote control to this jack with a remote control cable (not supplied) (p.15).
- ⑧ **HDMI TERMINAL**  
Connect the HDMI signal (including sound signal) from video equipment or the DVI signal from computer to this terminal (pp.19, 20).  
Sponsored by **HDMI** is registered trademarks of HDMI Licensing, LLC.
- ⑨ **5 BNC INPUT JACKS**  
Connect the component or composite video output signal from equipment to VIDEO/Y, Pb/Cb, and Pr/Cr jacks or connect the computer output signal (5 BNC Type [Green, Blue, Red, Horiz. Sync, and Vert. Sync.]) to G, B, R, H/V, and V jacks (pp.19-20).
- ⑩ **S-VIDEO INPUT JACK**  
Connect the S-VIDEO output signal from video equipment to this jack (p.20).
- ⑪ **VIDEO INPUT JACK**  
Connect the component or the composite video output signal from video equipment to these jacks (p.20).
- ⑫ **AUDIO 3 JACKS (L(MONO)/R)**  
Connect the audio output signal from video equipment connected to ⑩ or ⑪ to this jack. For a mono audio signal (a single audio jack), connect it to the L (MONO) jack (p.21).
- ⑬ **AUDIO 1 JACK**  
Connect the audio output (stereo) signal from a computer or video equipment (p.21).
- ⑭ **AUDIO 2 JACK**  
Connect the audio output (stereo) signal from a computer or video equipment (p.21).
- ⑮ **USB CONNECTOR (Series B)**  
Use this connector when controlling a computer with the remote control of the projector. Connect the USB port of the computer to the USB terminal with a USB cable (not supplied) (p.19).
- ★ **Kensington Security Slot**  
This slot is for a Kensington lock used to deter theft of the projector.  
\*Kensington is a registered trademark of ACCO Brands Corporation.

Discount Merchant.com (800) 281-8860  
 THE #1 SOURCE FOR PROJECTOR LAMPS AND ACCESSORIES

Side Control and Indicators

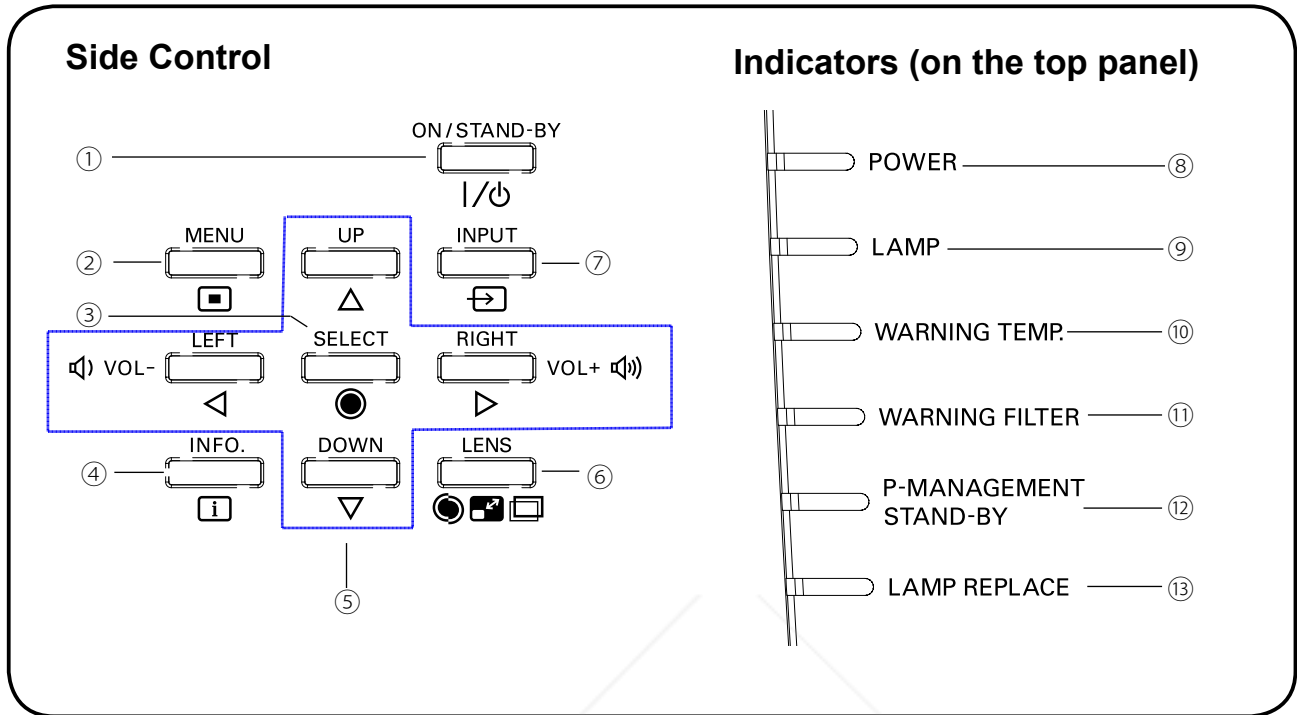

- ① **ON/STAND-BY button**  
Turn the projector on or off (pp.23-24).
- ② **MENU button**  
Open or close the On-Screen Menu (p.25).
- ③ **SELECT button**
  - Execute the selected item (p.25).
  - Expand or compress the image in the Digital zoom mode (p.43).
- ④ **INFO. button**  
Display the information window on the screen (p.27).
- ⑤ **Point ▲▼◀▶ ( VOLUME - / + ) buttons**
  - Select an item or adjust the value in the On-Screen Menu (p.25).
  - Pan the image in Digital zoom + mode (p.43).
  - Adjust the volume level (with Point ◀ ▶ buttons) (p.28).
- ⑥ **LENS button**  
Enter the focus, zoom, and lens shift adjustment mode (p.27).
- ⑦ **INPUT button**  
Select an input source (pp.33-35).
- ⑧ **POWER indicator**
  - Light green while the projector is in stand-by mode.
  - Light green during operations.
- ⑨ **LAMP indicator**  
Light red during operations.
- ⑩ **WARNING TEMP. indicator**  
Blink red when the internal temperature of the projector exceeds the operating range (pp.71, 78-80).
- ⑪ **WARNING FILTER indicator**
  - Blink fast when the filter cartridge is not installed (pp.65, 80).
  - Light orange when the filter counter reaches a time set in the timer setting, urging immediate filter cartridge replacement (pp.64, 65, 80).
- ⑫ **P-MANAGEMENT STAND-BY indicator**  
Light blue when the projector is in the Power management mode (pp.59, 78).
- ⑬ **LAMP REPLACE indicator**  
Light orange when the projection lamp reaches its end of life (pp.68, 79).

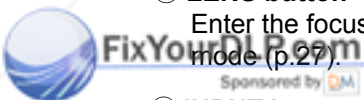

Discount Merchant.com (800) 281-8860

THE TRUSTED SOURCE FOR PROJECTOR LAMPS AND ACCESSORIES

Remote Control

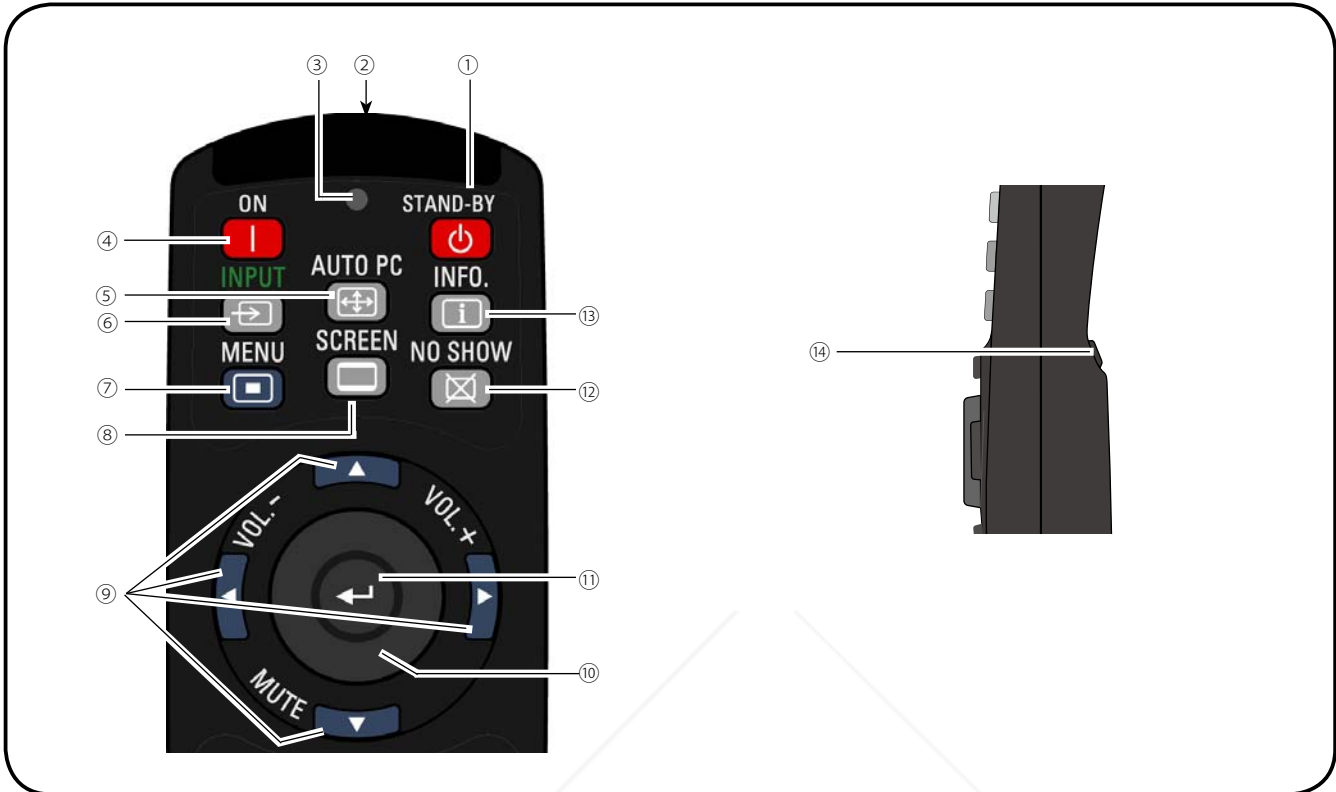

- ① **STAND-BY button**  
Turn the projector off (p.24).
- ② **WIRED REMOTE jack**  
Connect the remote control cable (not supplied) to this jack when using as a wired remote control.
- ③ **SIGNAL EMISSION indicator**  
Light red while a signal is being sent from the remote control to the projector.
- ④ **ON button**  
Turn the projector on (p.23).
- ⑤ **AUTO PC button**  
Automatically adjust the computer image to its optimum setting (pp.29, 37).
- ⑥ **INPUT button**  
Select a signal (pp.33-35).
- ⑦ **MENU button**  
Open or close the On-Screen Menu (p.25).
- ⑧ **SCREEN button**  
Select the screen size (p.29).
- ⑨ **POINT ▲▼◀▶ (VOLUME - / +, MUTE) buttons**
  - Select an item or adjust the value in the On-Screen Menu (p.25).
  - Pan the image in Digital zoom + mode (p.43).
  - Adjust the volume level (with Point ◀▶ buttons) or mute the sound (with Point ▼ button.) (p.28).
- ⑩ **MOUSE POINTER button**  
Move a pointer of the projector or a pointer for wireless mouse operation (p.32).
- ⑪ **SELECT button**
  - Execute the selected item (p.25).
  - Expand or compress the image in the Digital zoom mode (p.43).
- ⑫ **NO SHOW button**  
Temporarily turn off the image on the screen (p.29).
- ⑬ **INFO. button**  
Display the input source information (p.27).
- ⑭ **L-CLICK button**  
Act as the left mouse button for wireless mouse operation (p.32).



To ensure safe operation, observe the following precautions:

- Do not bend, drop, or expose the remote control to moisture or heat.
- For cleaning, use a soft dry cloth. Do not apply benzene, thinner, spray, or any other chemical materials.

Remote Control

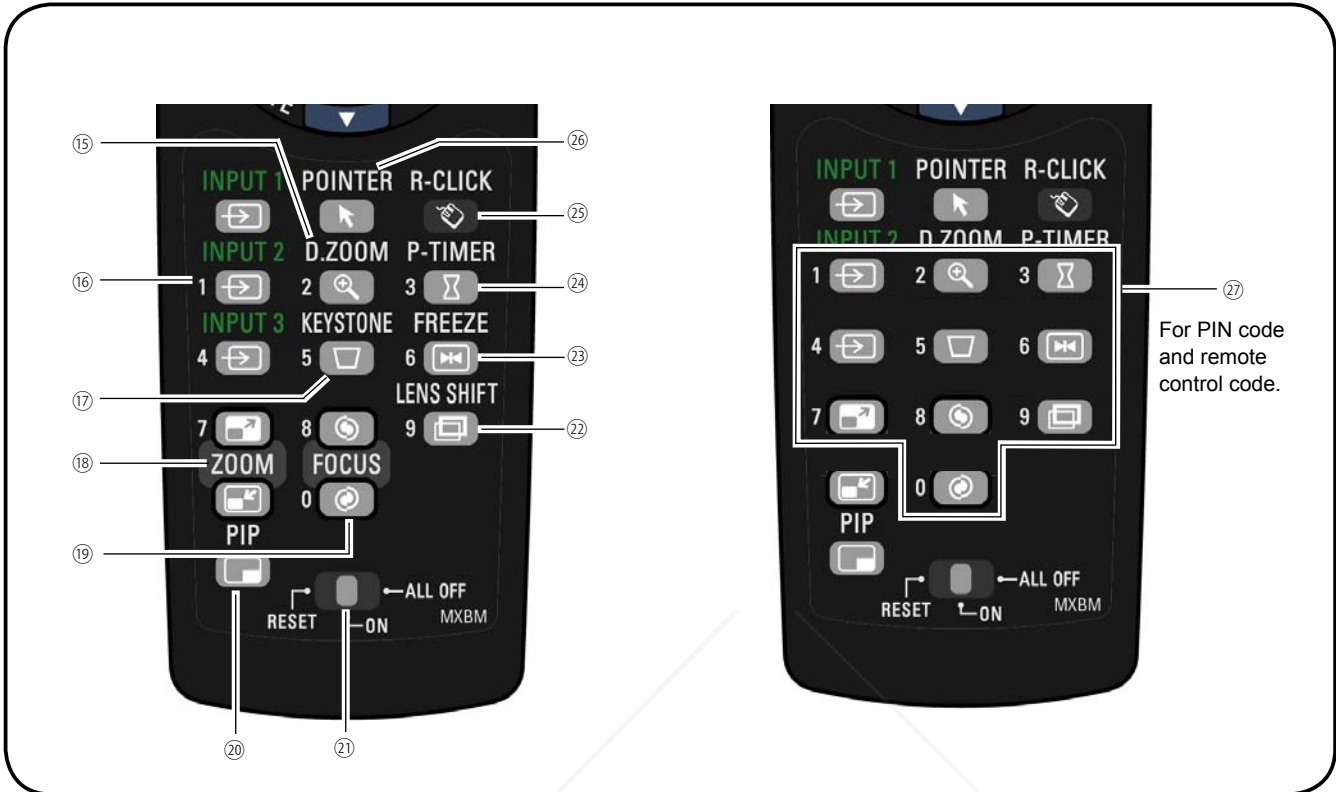

15 **D.ZOOM button**

Select the Digital zoom +/- mode and resize the image (p.43).

16 **INPUT 1- 3 buttons**

Select an input source (INPUT 1 – INPUT 3) (pp.33-35).

17 **KEYSTONE button**

Correct keystone distortion (pp.31, 44, 50).

18 **ZOOM ▲▼ buttons**

Zoom in and out the images (p.29).

19 **FOCUS buttons**

Adjust the focus (p.29).

20 **PIP button**

Operate the Picture in Picture function. (pp.30,55-56)

21 **RESET/ON/ALL-OFF switch**

When using the remote control, set this switch to "ON". Set it to "ALL OFF" for power saving when it is not in use. Slide this switch to "RESET" to initialize the remote control code.

22 **LENS SHIFT button**

Select the Lens Shift function (p.29).

23 **FREEZE button**

Freeze the picture on the screen and mute the sound (p.30).

24 **P-TIMER button**

Operate the P-timer function (p.30).

25 **R-CLICK button**

Act as the right mouse button for wireless mouse operation (p.32).

26 **POINTER button**

Act as the On-Off switch for the Pointer (pp.30, 32, 60).

27 **NUMBER buttons**

Act as number buttons. Use these buttons when setting the remote control codes (p.16) or when entering the PIN code numbers (pp. 23, 54, 62).

For PIN code and remote control code.



FixYourDLP.com

Sponsored by DM

DiscountMerchant.com (800) 860-860

THE TRUSTED SOURCE FOR PROJECTOR LAMPS AND ACCESSORIES

## Remote Control Battery Installation

**1** Open the battery compartment lid.

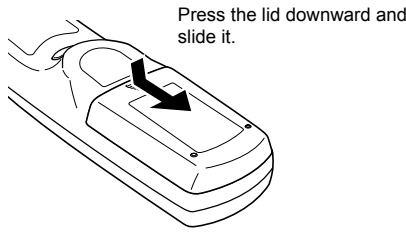

**2** Install new batteries into the compartment.

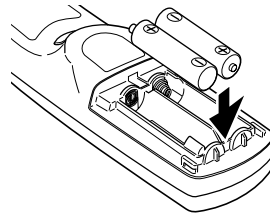

**Two AAA size batteries**  
For correct polarity (+ and -), be sure battery terminals are in contact with pins in the compartment.

**3** Replace the compartment lid.

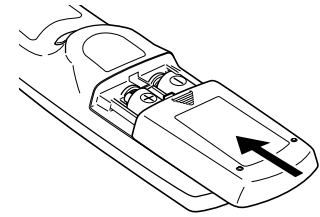

To ensure safe operation, please observe the following precautions :

- Use two (2) AAA or LR03 type alkaline batteries.
- Always replace batteries in sets.
- Do not use a new battery with a used battery.
- Avoid contact with water or liquid.
- Do not expose the remote control to moisture or heat.
- Do not drop the remote control.
- If the battery has leaked on the remote control, carefully wipe the case clean and install new batteries.
- Risk of an explosion if battery is replaced by an incorrect type.
- Dispose of used batteries according to the instructions or your local disposal rule or guidelines.

## Remote Control Receivers and Operating Range

Point the remote control toward the projector (to Infrared Remote Receivers) when pressing the buttons. Maximum operating range for the remote control is about 16.4' (5 m) and 60 degrees in front, back and top of the projector.

Infrared Remote Receivers are provided in front, back and top of the projector. You can conveniently use all of the receivers (pp. 10, 11, 59).

✓ **Note:**

When hanging the projector from the ceiling, select the Infrared Remote Receiver which is located farther away from the fluorescent light (p.59).

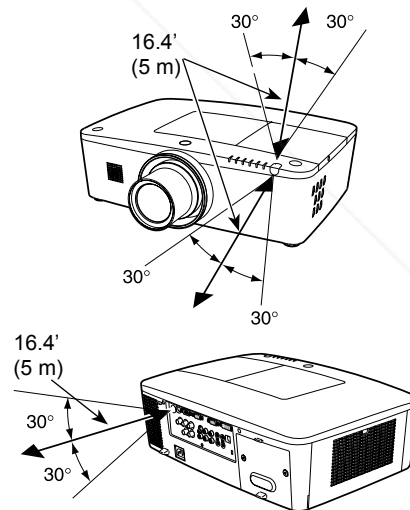

## Wired Remote Control Transmitter

The remote control can be used as a wired remote control. Wired remote control helps you use the remote control outside of the operating range (16.4' / 5 m). Connect the remote control and the projector with the remote control cable (sold separately). Connected with the remote control cable, the remote control does not emit wireless signal.

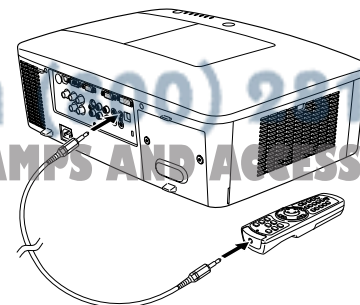



## Remote Control Code

The eight different remote control codes (Code 1–Code 8) are assigned to this projector. Switching the remote control codes prevents interference from other remote controls when several projectors or video equipment next to each other are operated at the same time. Change the remote control code for the projector first before changing that for the remote control. See “Remote control” in the Setting Menu on page 58.

- 1 Press and hold the MENU and a number button (1–8) for more than five seconds to switch between the codes.
- 2 To initialize the remote control code, slide the RESET/ ON/ ALL-OFF switch to “RESET”, and then to “ON”. The initial code is set to **Code 1**.

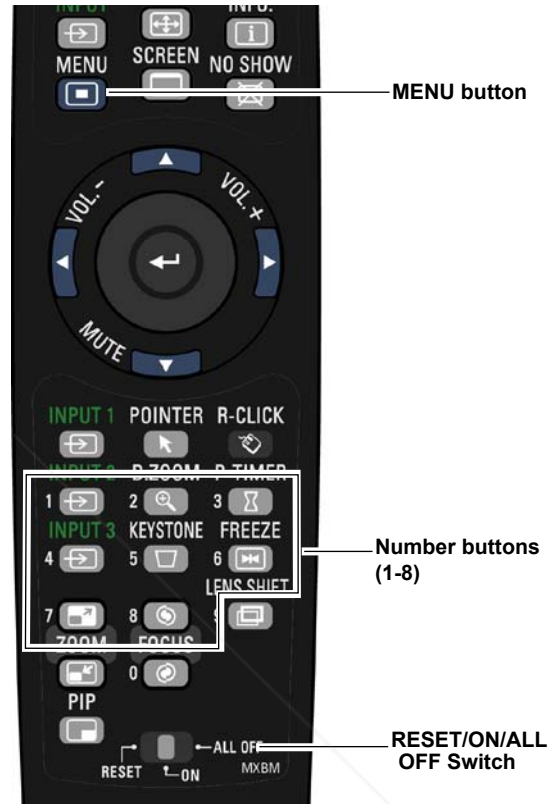

Press and hold the MENU and a number button (1-8) that corresponds to the remote control code for more than five seconds to switch between the codes.

## Adjustable Feet

Projection angle can be adjusted up to 4.0 degrees with the adjustable feet.

Rotate the adjustable feet and tilt the projector to the proper height; to raise the projector, rotate the both feet clockwise.

To lower the projector or to retract the adjustable feet, rotate the both feet counterclockwise.

To correct keystone distortion, press the KEYSTONE button on the remote control or select Keystone from the menu (see pages 14, 31, 44, 50).

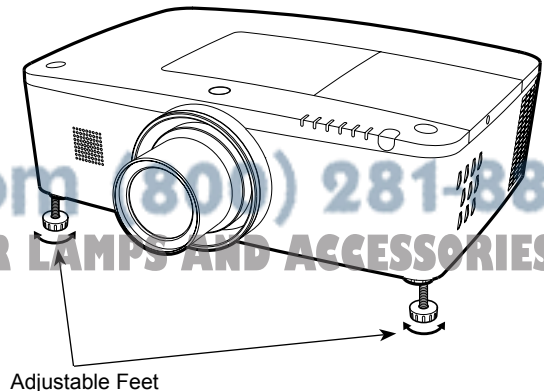

# Installation

## Positioning the Projector

For projector positioning, see the figures below. The projector should be set perpendicularly to the plane of the screen. (for PLC-WM4500)

✓ **Note:**

- The brightness in the room has a great influence on picture quality. It is recommended to limit ambient lighting in order to obtain the best image.
- All measurements are approximate and may vary from the actual sizes.

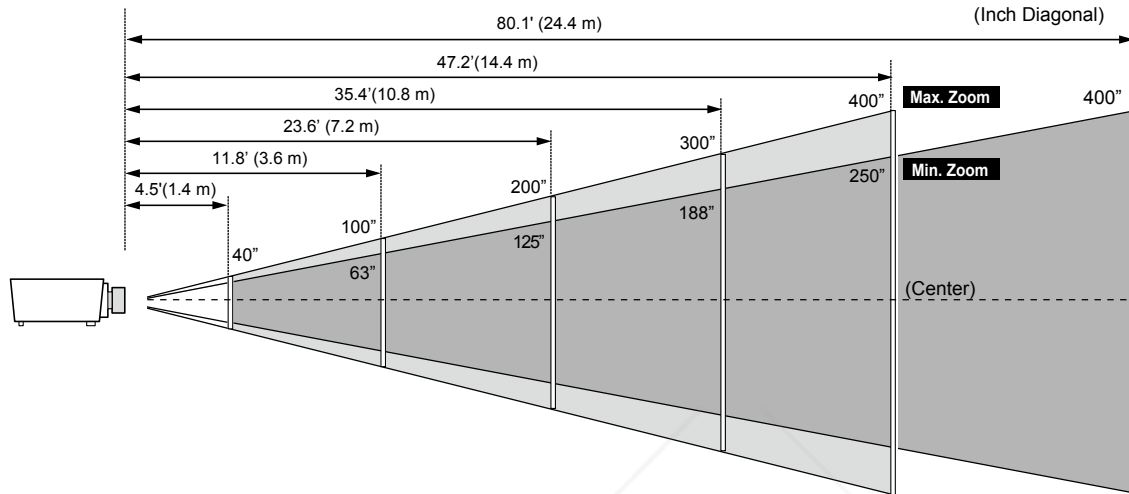

Screen Size (W x H) mm	40"	100"	200"	300"	400"
16:10 aspect ratio	862 x 538	2154 x 1346	4308 x 2692	6462 x 4039	8616 x 5385
Zoom (max.)	4.5'(1.4 m)	11.8' (3.6 m)	23.6' (7.2 m)	35.4'(10.8 m)	47.2'(14.4 m)
Zoom (min.)	7.9'(2.4 m)	19.7' (6.0 m)	40.0' (12.2 m)	60.0' (18.3 m)	80.1' (24.4 m)

## Lens Shift Adjustment

Projection lens can be moved from side to side and up and down with the motor-driven lens shift function. This function makes the positioning of images easy on the screen. (See page 27)

The display position can be shifted upward up to 60% elevation of the display.

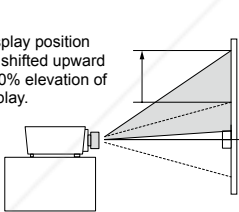

When the lens is shifted to top.

The display position can be shifted downward up to 60% low level of the display.

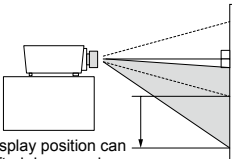

When the lens is shifted to bottom.

### Lens shift adjustable range

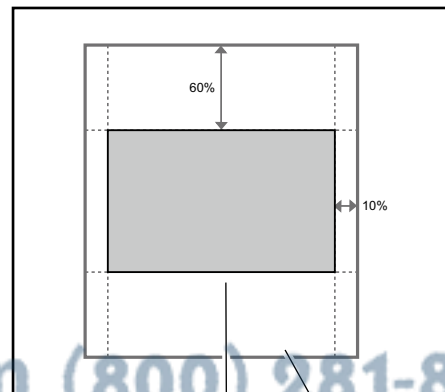

The display position can be shifted to the left in up to 10% width of the display.



When the lens is shifted to leftmost.

The display position can be shifted to the right in up to 10% width of the display.

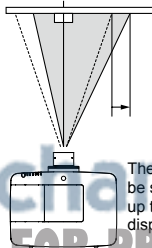

When the lens is shifted to rightmost.

Lens shift center position      Shift range

## Lens Installation

When replacing the lens or using an optional lens, install the lens by following the instructions below. Ask the sales dealer for detailed information of the optional lens specifications.

### Removing the lens

- 1 Shift the lens to the center position by using the Lens shift function (p.27).
- 2 Turn off the projector and unplug the AC power cord.
- 3 While pressing the Lens release button on the top of the cabinet, turn the lens counterclockwise until it stops and pull it out slowly from the projector.

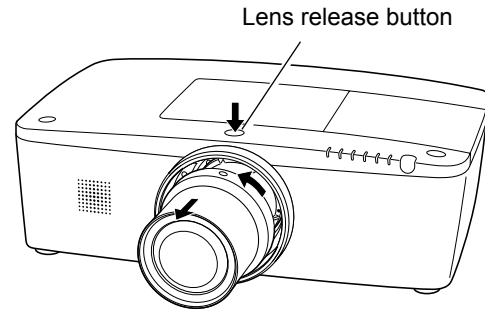

#### **CAUTION**

Be careful when handling the lens. Do not drop.

### Attaching the lens to the projector

- 1 Remove the lens mount cover.
- 2 Fit the lens to the projector by aligning the red dot on the lens with the red dot of the projector.
- 3 Slowly turn the lens clockwise until it clicks. Make sure that the lens is fully inserted to the projector.



#### **CAUTION**

Do not press the lens release button when attaching the lens.

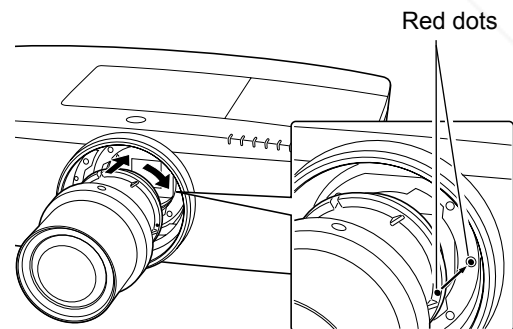

#### NOTES ON LENS INSTALLATION

- Do not touch or remove any parts except the lens and related parts. It may result in malfunctions, electrical shock, fire hazard or other accidents.
- Before installing or replacing the lens, check that the Model No. of the Projection Lens matches to the projector.
- For details of the lens and installation, contact the sales dealer where you purchased the projector.

## Connecting to a Computer (Digital and Analog RGB)

**Cables used for connection** (\* = Cables not supplied with this projector.)

- VGA Cable (One cable is supplied.)
- HDMI-DVI cable \*
- BNC cable \*
- Serial Cross cable \*
- USB cable \*

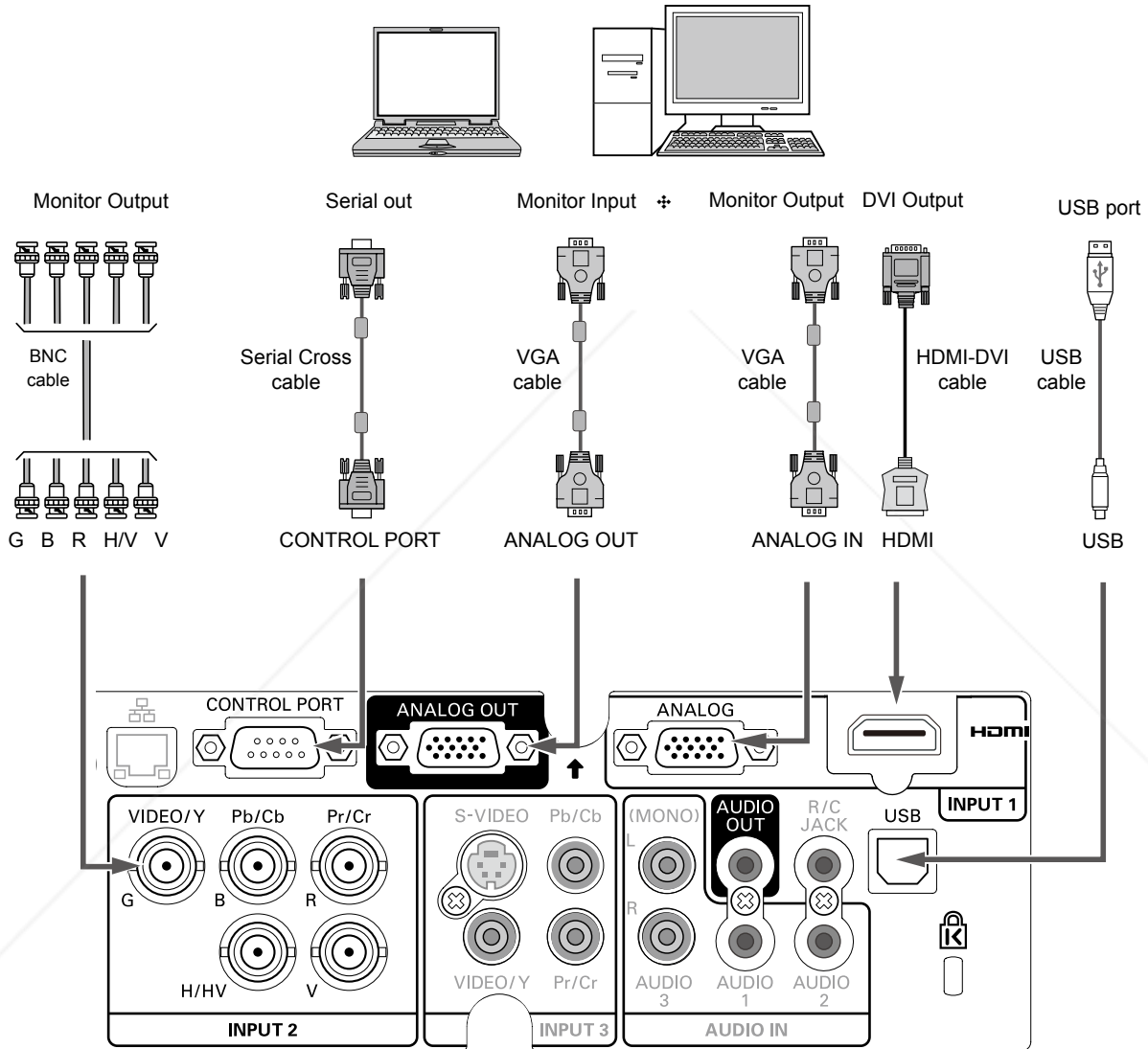

FixYourDLP.com  
Sponsored by DM

Discount-Merchant.com (800) 281-8860

 Unplug the power cords of both the projector and external equipment from the AC outlet before connecting cables.

See the next page for the signals that can output to the ANALOG OUT terminal.

## Connecting to Video Equipment (Video, S-video, HDMI)

**Cables used for connection** (\* = Cables not supplied with this projector.)

- Video cable (RCA x 1 or RCA x 3) \*
- BNC cable (BNC x 1 or BNC x 3) \*
- S-video cable \*
- Scart-VGA cable \*
- HDMI cable \*

**Analog Out Signal Table**

Input Terminal		Monitor Out	Cable
Input 1	D-sub15	RGB (PC analog)	YES
		RGB (SCART)	NO
	HDMI	HDMI	NO
Input 2	5 BNC	RGB	YES
		Video	YES
		Y, Pb/Cb, Pr/Cr	YES
Input 3	RCA	Y, Pb/Cb, Pr/Cr	YES
		S-video	NO
	Video	Video	YES

\* A cable with one end D-sub 15 and the other end (Black box) compatible with each equipment is necessary.



*Unplug the power cords of both the projector and external equipment from the AC outlet before connecting cables.*

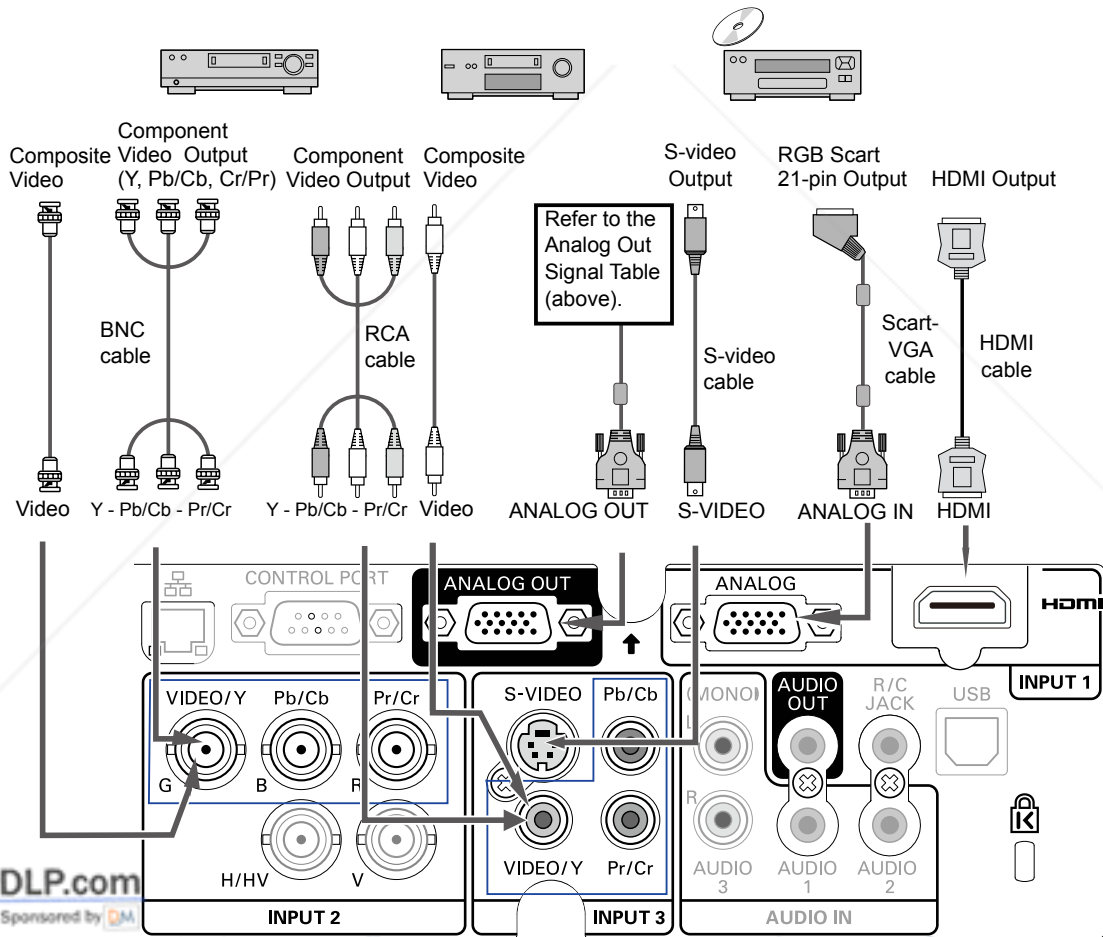

Discount-Merchant.com (800) 281-8860

THE TRUSTED SOURCE FOR PROJECTOR LAMPS AND ACCESSORIES

## Connecting for Audio Signal

**Cables used for connection** (\* = Cables not supplied with this projector.)

- Audio cable \*

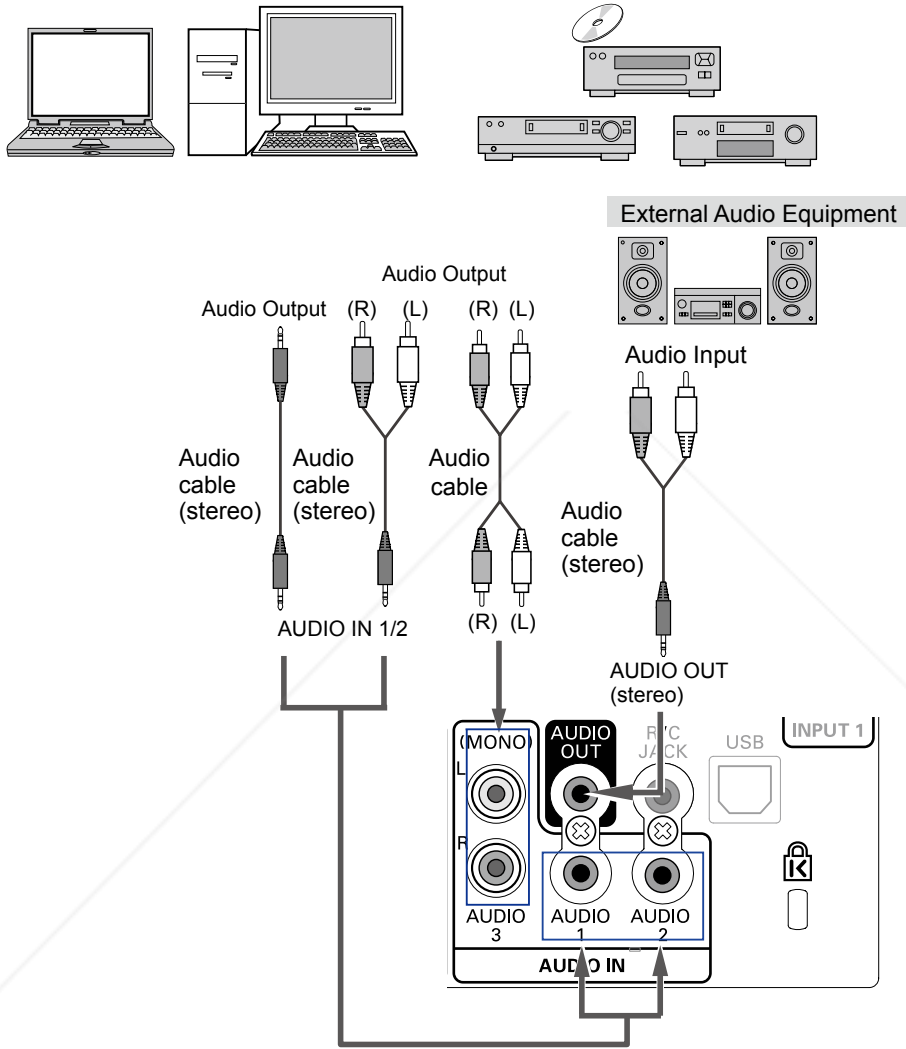

**Discount-Merchant.com (800) 281-8860**

**THE TRUSTED SOURCE FOR PROJECTOR LAMPS AND ACCESSORIES**



*Unplug the power cords of both the projector and external equipment from the AC outlet before connecting cables.*

## Connecting the AC Power Cord

This projector uses nominal input voltages of 100–240 V AC and it automatically selects the correct input voltage. It is designed to work with single-phase power systems having a grounded neutral conductor. To reduce the risk of electrical shock, do not plug into any other type of power system.

If you are not sure of the type of power being supplied, consult your authorized dealer or service center.

Connect the projector with all peripheral equipment before turning on the projector.

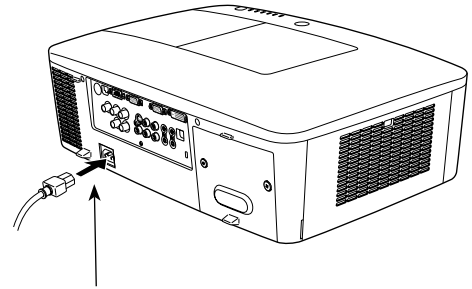

Connect the AC power cord (supplied) to the projector.



### CAUTION

The AC outlet must be near this equipment and must be easily accessible.

✓ **Note:**

*Unplug the AC power cord when the projector is not in use. When the projector is connected to an outlet with AC power cord, it is in stand-by mode and consumes a little electric power.*

### NOTE ON THE POWER CORD

AC power cord must meet the requirements of the country where you use the projector. Confirm the AC plug type with the chart below and proper AC power cord must be used. If the supplied AC power cord does not match your AC outlet, contact your sales dealer.

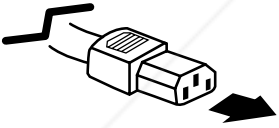
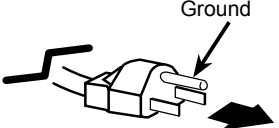
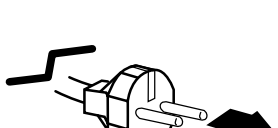
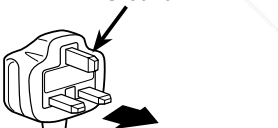
Projector side	AC Outlet side		
 <p>To POWER CORD CONNECTOR on your projector.</p>	<p><b>For the U.S.A. and Canada</b></p>  <p>Ground</p> <p>To the AC Outlet. (120 V AC)</p>	<p><b>For Continental Europe</b></p>  <p>To the AC Outlet. (200–240 V AC)</p>	<p><b>For the U.K.</b></p>  <p>Ground</p> <p>To the AC Outlet. (200–240 V AC)</p>



**Discount-Merchant.com (800) 281-8860**  
**THE TRUSTED SOURCE FOR PROJECTOR LAMPS AND ACCESSORIES**

# Basic Operation

## Turning On the Projector

- 1 Complete peripheral connections (with a computer, VCR, etc.) before turning on the projector.
- 2 Connect the projector's AC power cord into an AC outlet. The LAMP indicator lights red and the POWER indicator lights green.
- 3 Press the ON/STAND-BY button on the side control or the ON button on the remote control. The LAMP indicator dims and the cooling fans start to operate. The preparation display appears on the screen and the countdown starts.
- 4 After the countdown, the input source that was selected the last time and the Lamp control status icon (see page 57) appear on the screen.

If the projector is locked with a PIN code, PIN code input dialog box will appear.

✓ **Note:**

- When the Logo select function is set to **Off**, the logo will not be shown on the screen (p.52).
- When **Countdown off** or **Off** is selected in the Display function, the countdown will not be shown on the screen (p.52).
- When the Input button function is set to **Mode 3**, the input signal will be searched automatically (p.51).
- If you press the ON/STAND-BY button on the top control or the remote control during the countdown period, you can skip the countdown and go to the normal operations. In this case, however, the brightness of the image needs some time to stabilize after turning on the projector. The display may flicker after turning on the lamp for the characteristics of the lamp. This is normal operation and not a malfunction.

### Enter a PIN code

Use the Point ▲▼ buttons on the side control or Number buttons on the remote control to enter a number.

#### When using side control

Use the Point ▲▼ buttons on the side control to select a number. Press the Point ► button to fix the number and move the red frame pointer to the next box. The number changes to \*. Repeat this step to complete entering a four-digit number. After entering the four-digit number, move the pointer to "Set". Press the SELECT button so that you can start to operate the projector.

#### When using remote control

Press the Number buttons on the remote control to enter a number (p.14). When you complete entering a four-digit number, the pointer moves to "Set". Press the SELECT button so that you can start to operate the projector.

If you fixed an incorrect number, use the Point ◀ button to move the pointer to the number you want to correct, and then enter the correct number.

If you entered an incorrect PIN code, "PIN code" and the number (\*\*\*\*) will turn red for a moment. Enter the correct PIN code all over again.



The preparation display will disappear after 30 seconds.

### Selected Input Source and Lamp control



(See page 57 for Lamp control status.)

✓ **Note:**

- The Lamp replacement icon and the Filter warning icon may appear on the screen depending on the usage state of the projector.
- When the Picture in Picture function is set to User(1-5), User(1-5), Input source, Lamp control status, Lamp replacement icon and Filter warning icon will appear on the screen for 10 seconds.

### PIN Code Input Dialog Box

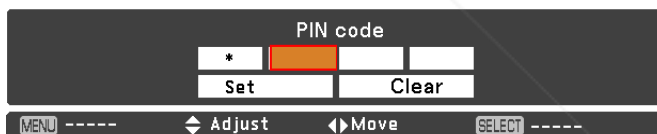

After the OK icon disappears, you can operate the projector.

✓ **Note:**

- If the PIN code number is not entered within three minutes after the PIN code dialog box appeared, the projector will be turned off automatically.
- The "1234" is set as the initial PIN code at the factory.



### What is PIN code?

PIN (Personal Identification Number) code is a security code that allows the person who knows it to operate the projector. Setting a PIN code prevents unauthorized use of the projector.

A PIN code consists of a four-digit number. Refer to the PIN code lock function in the Setting Menu on pages 61-62 for locking operation of the projector with your PIN code.



#### CAUTION ON HANDLING PIN CODE

If you forget your PIN code, the projector can no longer be started. Take a special care in setting a new PIN code; write down the number in a column on page 86 of this manual and keep it on hand. Should the PIN code be missing or forgotten, consult your dealer or service center.

## Turning Off the Projector

- 1 Press the ON/STAND-BY button on the side control or the STAND-BY button on the remote control, and **Power off?** appears on the screen.
- 2 Press the ON/STAND-BY button on the side control or the STAND-BY button on the remote control again to turn off the projector. The LAMP indicator lights bright and the POWER indicator turns off. After the projector is turned off, the cooling fans operate for 90 seconds. You cannot turn on the projector during this cooling down period.
- 3 When the projector has cooled down enough, the POWER indicator lights green and then you can turn on the projector. To unplug the AC power cord, wait until the projector is completely cooled down.

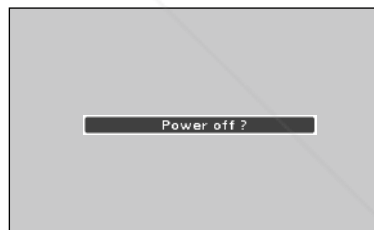

**Power off?** disappears after 4 seconds.

#### ✓ Note:

- When the Direct on function is set to **On**, the projector will be turned on automatically by connecting the AC power cord to an AC outlet (p.60).
- The running speed of cooling fans is changed according to the temperature inside the projector.
- Do not put the projector in a case before the projector is cooled enough.
- If the **WARNING TEMP.** indicator blinks red, see "Warning Indicators" on page 71.
- The projector cannot be turned on during the cooling period with the **POWER** indicator turned off. You can turn it on again after the **POWER** indicator becomes green again.



TO MAINTAIN THE LIFE OF THE LAMP, ONCE YOU TURN THE PROJECTOR ON, WAIT AT LEAST FIVE MINUTES BEFORE TURNING IT OFF. DO NOT UNPLUG THE AC POWER CORD WHILE COOLING FANS ARE RUNNING OR BEFORE THE POWER INDICATOR LIGHTS GREEN AGAIN. OTHERWISE IT WILL RESULT IN SHORTENING OF THE LAMP LIFE.



DO NOT OPERATE THE PROJECTOR CONTINUOUSLY WITHOUT REST. CONTINUOUS USE MAY RESULT IN SHORTENING THE LAMP LIFE. TURN OFF THE PROJECTOR AND LET STAND FOR ABOUT AN HOUR IN EVERY 24 HOURS.

## How to Operate the On-Screen Menu

The projector can be adjusted or set via the On-Screen Menu. The menus have a hierarchical structure, with a main menu that is divided into submenus, which are further divided into other submenus. For each adjustment and setting procedure, refer to respective sections in this manual.

- 1 Press the MENU button on the side control or the remote control to display the On-Screen Menu.
- 2 Use the Point ▲▼ buttons to highlight or select a main menu item. Press the Point ► or the SELECT button to access the submenu items. (The selected item is highlighted in orange.)
- 3 Use the Point ▲▼ buttons to select the desired submenu item and press the SELECT button to set or access the selected item.
- 4 Use the Point ▲▼◀▶ buttons to adjust the setting or switch between each option and press the SELECT button to activate it and return to the submenu.
- 5 Press the Point ◀ button to return to the main menu. Press the MENU button to exit the On-Screen Menu.

### Side Control

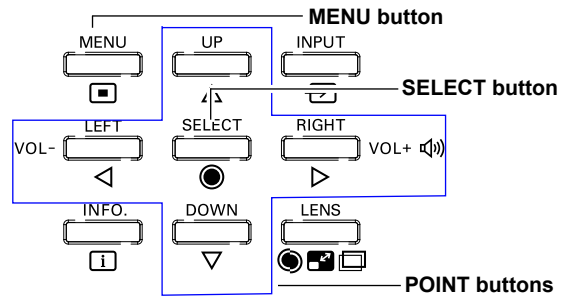

### Remote Control

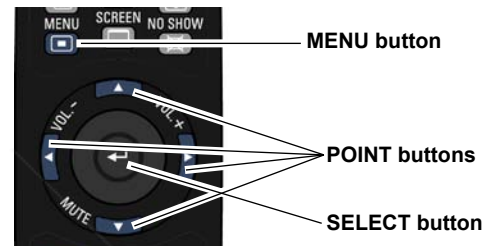

### On-Screen Menu

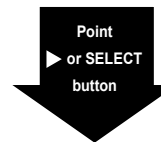
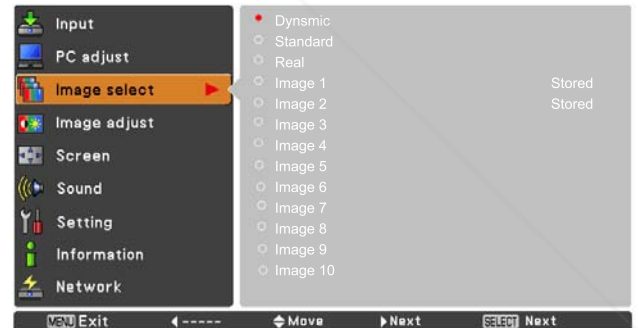

The currently set item is marked.

The selected item is highlighted in orange.

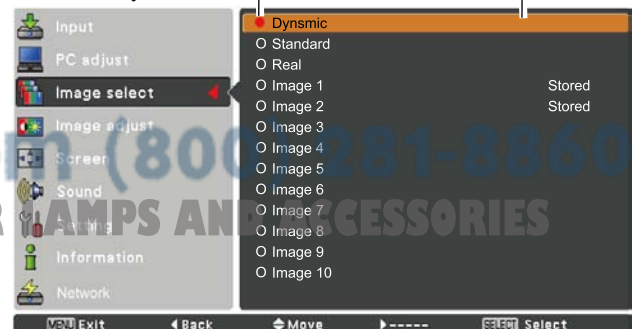

## Menu Bar

For detailed functions of each menu, see “Menu Tree” on pages 75-77.

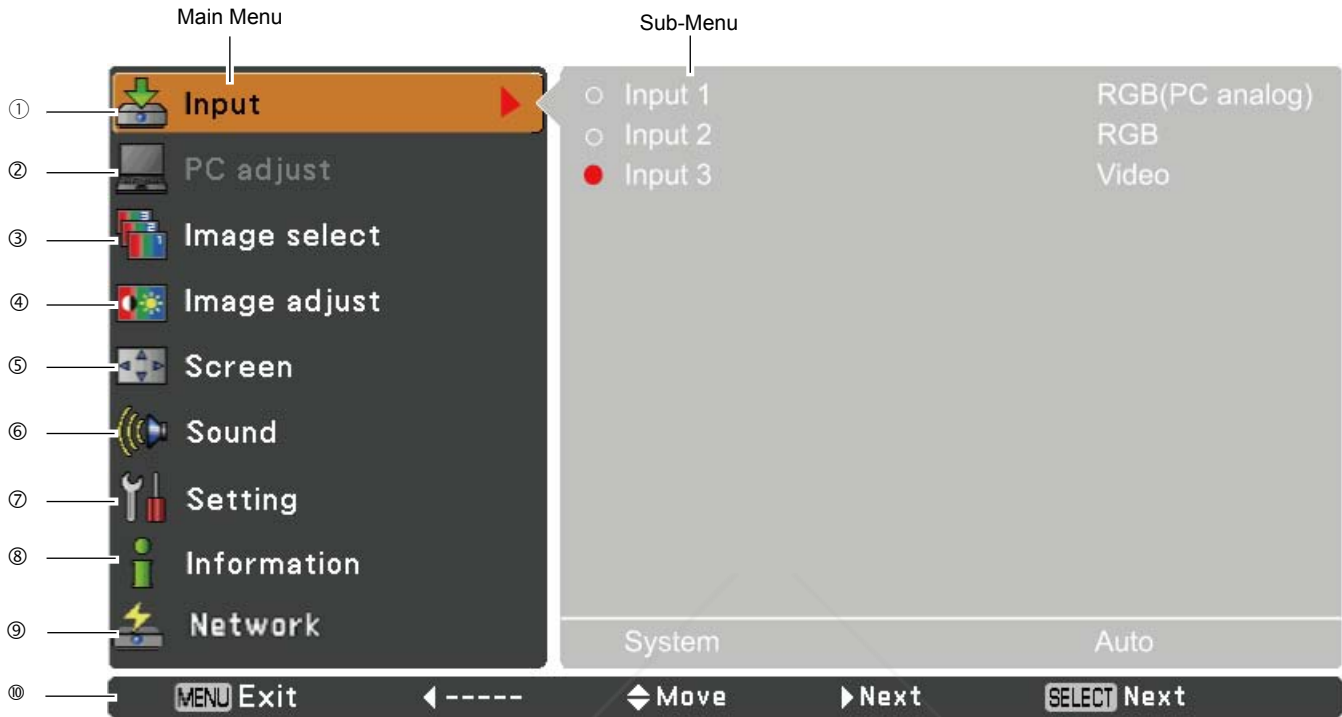

### ① Input

Used to select an input source (**Input 1**, **Input 2**, **Input 3**) (p.33).

### ② PC adjust

Used to adjust the parameters to match with the input signal format (pp.37-39).

### ③ Image select

For computer source, used to select an image level among **Dynamic**, **Standard**, **Real**, and **Image 1-10** (p.40).

For Video source, used to select an image level among **Dynamic**, **Standard**, **Natural**, **Cinema**, and **Image 1-10** (p.46).

### ④ Image adjust

For computer source, used to adjust the computer image. [**Contrast/Brightness/Color temp./White balance (R/G/B)/Offset(R/G/B)/Sharpness/Gamma/Reset/Store**] (pp.41-42).

For Video or HDMI source, used to adjust the video image. [**Contrast/Brightness/Color/Tint/Color temp./White balance (R/G/B)/Offset (R/G/B)/Sharpness/Gamma/Noise Reduction/Progressive/Reset/Store**] (pp.47-48).

### ⑤ Screen

For computer source, used to adjust the size of the image. [**Normal/Full/Wide(16:9)/Zoom/True/Custom/Custom adj./Digital zoom +/-/Keystone/Ceiling/Rear/Screen aspect/Reset**] (pp.42-44).

For video or HDMI source, used to adjust the size of the image. [**Normal/Full/Wide(16:9)/Zoom/Natural Wide/Custom/Custom adj./Keystone/Ceiling/Rear/Screen aspect/Reset**] (pp. 49-50).

### ⑥ Sound

Used to adjust the volume or mute the sound (p.28).

### ⑦ Setting

Used to set the projector's operating configurations (pp.51-64).

### ⑧ Information

Display the input source information: **Input**, **H-sync freq.**, **V-sync freq.**, **Screen**, **Language**, **Lamp status**, **Lamp counter**, **Filter counter**, **Power management**, **Key lock**, **PIN code lock**, **Simple mode**, **Remote control**, and **SERIAL NO.** (p.27).

### ⑨ Network

See the owner's manual of "Network Set-up and Operation".

### ⑩ Guide

The key operation is displayed.

## Operating with Projector Control

### Lens Operation

The following lens operation can be made with the Lens button on the side control.

Press the LENS button to enter each lens operation mode. The selected adjustment display appears on the screen.

Zoom → Focus → Lens Shift → .....

#### Zoom Adjustment

Display **Zoom** on the screen. Use the Point ▲▼ buttons to zoom in and out the image.

#### Focus Adjustment

Display **Focus** on the screen. Use the Point ▲▼ buttons to adjust focus of the image.

#### Lens Shift Adjustment

Display **Lens shift** on the screen. Use the Point ▲▼◀▶ buttons to position the screen to the desired point without having picture distortion.

The screen can be moved up or down to 60 percent, or sideways up to 10 percent from the central axis of the lens shift.

Press and hold the LENS button on the side control or the LENS SHIFT button on the remote control for 5 seconds or more to return the lens to the center position, after that the four white arrows on the screen turn to red.

✓ **Note:**

- The arrow disappears at the maximum lens shift in each direction.
- The arrow turns red when the lens shift comes to the center position of the screen.

#### INFO. button

Information display can be used to confirm the current operating condition of the projector and the signal being projected through the projector.

Press the INFO. button on the remote control to display the information window on the screen. To hide the information window, press the INFO. button again or press the MENU button. The information window can also be selected from the menu.

✓ **Note:**

- The H-sync freq. and V-sync freq. values described in the figure may be different from the actual values.
- SERIAL NO. is used to service the projector.

### Side Control

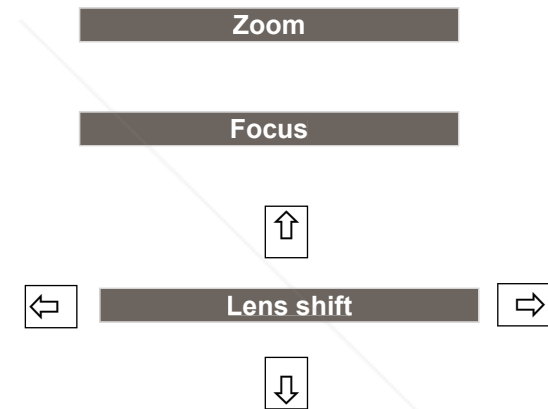
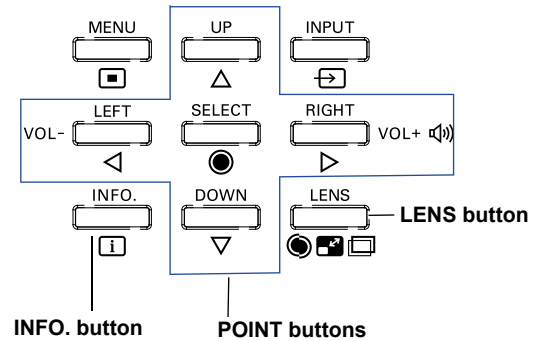

### Information Menu



FixYourDLP.com

DiscWhisper.com (800) 281-8860  
 THE TRUSTED SOURCE FOR PROJECTOR PARTS AND ACCESSORIES

## Sound Adjustment

### Direct Operation

#### Volume

Press the VOLUME+/- buttons on the side control or on the remote control to adjust the volume. The volume dialog box appears on the screen for a few seconds.

#### Mute

Press the MUTE (Point ▼) button on the remote control to select **On** to temporarily turn off the sound. To turn the sound back on, press the MUTE (Point ▼) button again to select **Off** or press the VOLUME +/- buttons. The Mute function is also effective for the AUDIO OUT jack.

### Menu Operation

- 1 Press the MENU button to display the On-Screen Menu. Use the Point ▲▼ buttons to select **Sound**. Press the Point ► or the SELECT button to access the submenu items.
- 2 Use the Point ▲▼ buttons to select the desired submenu item and press the SELECT button to access the selected item.

#### Volume

Press the Point ► button to turn up the volume; press the Point ◀ button to turn down the volume.

#### Built-in SP

Press the Point ▲▼ buttons to switch the Built-in SP function **On/Off**. When the Built-in SP sound is turned off, **Off** is displayed.

#### Mute

Press the SELECT button to switch the mute function **On/Off**. When the sound is turned off, **On** is displayed. Press the VOLUME +/- buttons again to turn the sound back on.

### Side Control

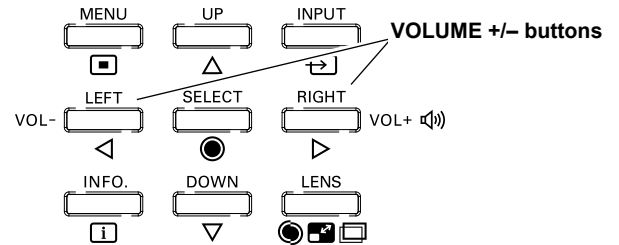

### Remote Control

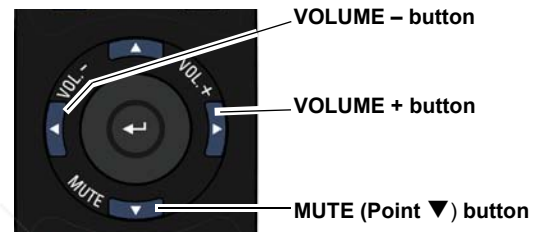

### Volume Dialog Box

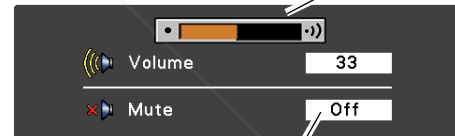

Press the Point ▼ button to set the Mute function **On** or **Off**. The dialog box disappears after 4 seconds.

### Sound Menu

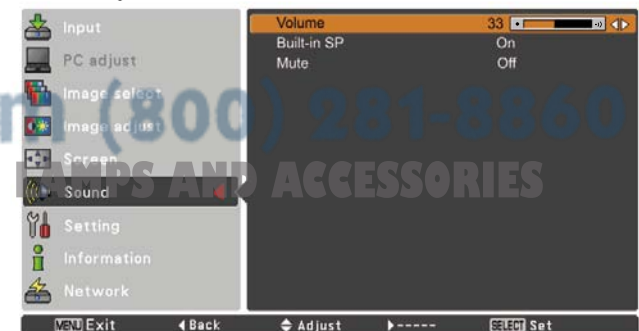
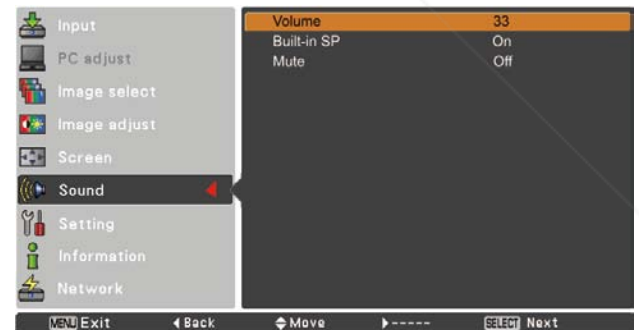

## Operating with Remote Control

Using the remote control for some frequently used operations is advisable. Just pressing one of the buttons enables you to make the desired operation quickly without calling up the On-Screen Menu.

### AUTO PC button

Press the AUTO PC button on the remote control to operate the Auto PC adj. function. The computer screen adjustment can be done easily by pressing this button. See page 37 for details.

### SCREEN button

Press the SCREEN button on the remote control to select the desired screen size. The selected screen size symbol appears on the screen for 4 seconds. See pages 42 to 44 and 49 to 50 for details. Press and hold the SCREEN button for more than 5 seconds to return all the screen size adjustment setting to the factory default setting.

### NO SHOW button

Press NO SHOW button on the remote control to black out the image. To restore to normal, press the NO SHOW button again or press any other button. The NO SHOW symbol appears on the screen for 4 seconds.

### D.ZOOM button

Press the D.ZOOM button on the remote control to enter to the Digital zoom +/- mode. See page 43 for details.

### LENS SHIFT button

See page 27 for details.

### ZOOM buttons

Press the ZOOM buttons on the remote control to zoom in and out the image.

### FOCUS buttons

Press the FOCUS buttons on the remote control to adjust focus of the image.

### INFO. button

Press the INFO. button on the remote control to display the information window on the screen. See page 27 for details.

### Remote Control

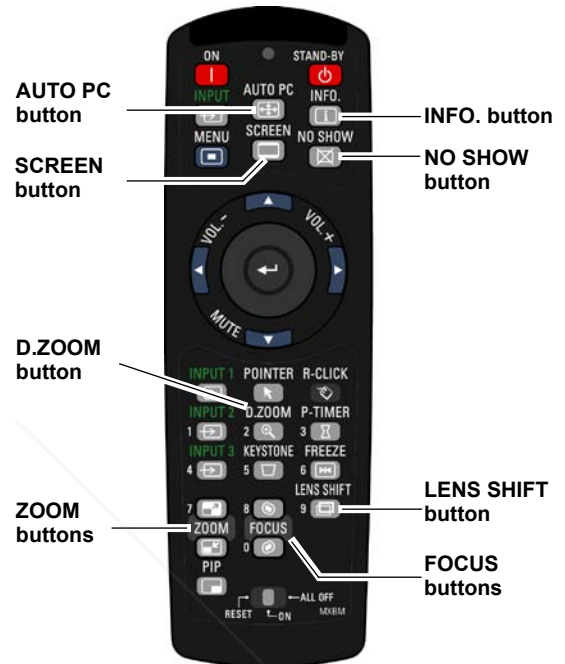

✓ **Note:**

See the next page for the description of other buttons.

## MOUSE POINTER button

Move the pointer on the screen with this button.

## POINTER button

Press POINTER button on the remote control to display the Pointer on the screen. (pp.32, 60)

## P-TIMER button

Press the P-TIMER button on the remote control to operate the Count up/Count down function. Refer to p.60 for detail of Setting for the P-timer function.

To stop the count time, press the P-TIMER button.

To cancel the P-timer function, press and hold the P-TIMER button for a few seconds.

## FREEZE button

Press the FREEZE button on the remote control to freeze the picture on the screen and mute the sound. To cancel the FREEZE function, press the FREEZE button again or press any other button. Fig.1 will appear when the Freeze function is working.

Fig.1



## PIP button

Press the PIP button on the remote control several times until the desired mode of Picture in Picture appears. Each user mode (User 1-5) appears only when it has stored data.

Press and hold the PIP button for more than 3 seconds to display the setting dialog box of Picture in Picture. See pages 55-56 for details of Picture in Picture function.

## Remote Control

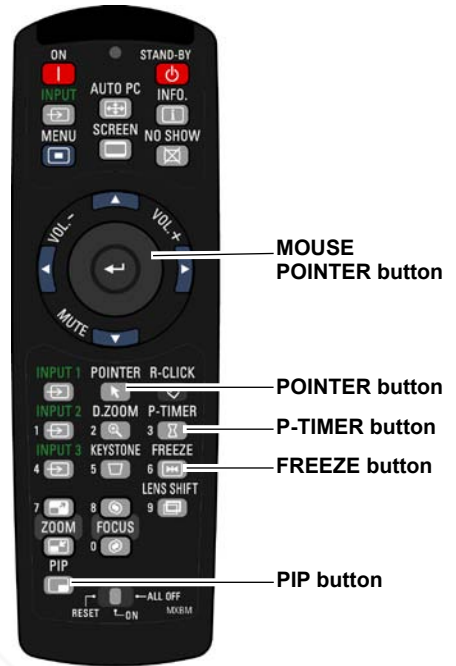

✓ **Note:**

See the previous page for the description of other buttons.

### User 1 of PIP (example)

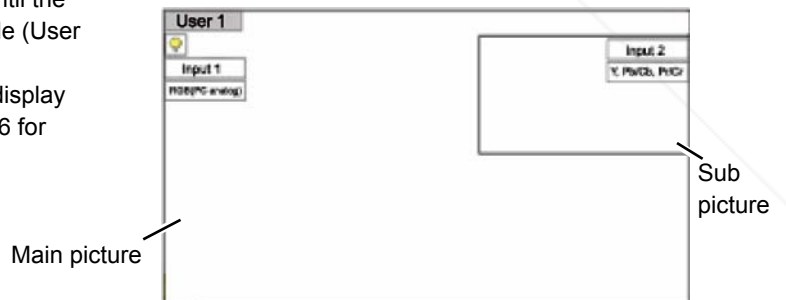

### User 2 of PIP (example)



## Keystone Correction

If a projected picture has keystone distortion, correct the image with Keystone adjustment. It is not available when On-Screen menu is displayed.

Press the KEYSTONE button on the remote control. The keystone dialog box appears. Correct keystone distortion by pressing the Point ▲▼ buttons on the remote control. Keystone adjustment can be memorized. (p.44, 50)

### Remote Control

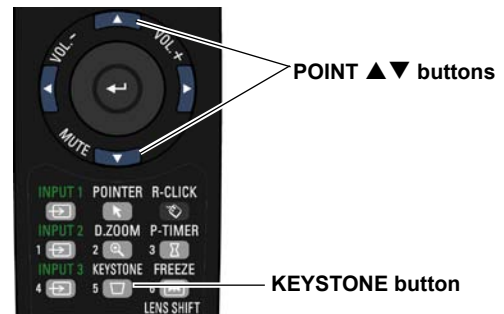

### Keystone

Reduce the upper width with the Point ▲ button.

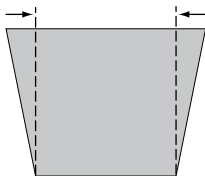

Reduce the lower width with the Point ▼ button.

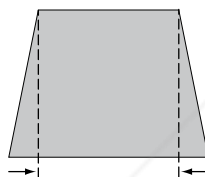

#### ✓ Note:

- The white arrows indicate that there is no correction.
- A red arrow indicates the direction of correction.
- An arrow disappears at the maximum correction.
- If you press and hold the KEYSTONE button for more than 3 seconds while the Keystone correction dialog box is being displayed, the Keystone correction adjustment will be released.
- The adjustable range is limited depending on the input signal.



## Pointer Function

You can move the Pointer of the projector with the remote control to emphasize a part of the projected image.

- 1 Press the POINTER button to activate the Pointer function.
- 2 Use the MOUSE POINTER button to move the Pointer.
- 3 To cancel the Pointer function, press the POINTER button again or press any other button.

### Dot

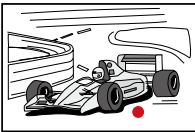

### Arrow

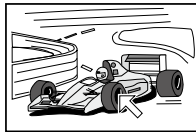

### Finger

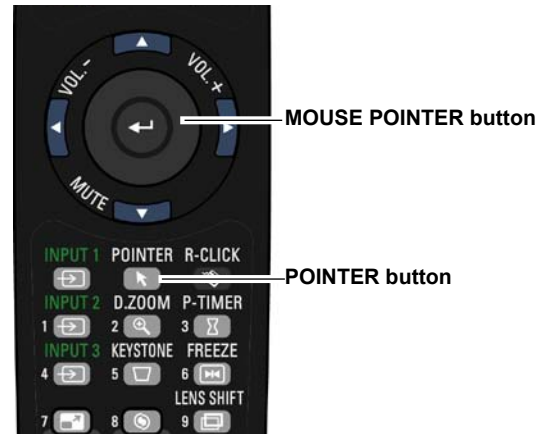
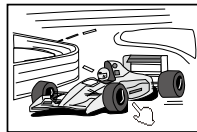

✓ **Note:**

You can choose the pattern of Pointer (**Dot/Arrow/Finger**) in the Setting Menu (p.60)

## Wireless Mouse Operation

The remote control can be used as a wireless mouse for your computer.

- 1 Before operating the wireless mouse, connect your computer and the projector with a USB cable (p.19). When the Pointer function is used, the wireless mouse is not available.
- 2 When a USB cable is connected to the computer and the projector, turn on the projector first, then the computer. If you turn on the computer first, the wireless mouse function may not operate properly.

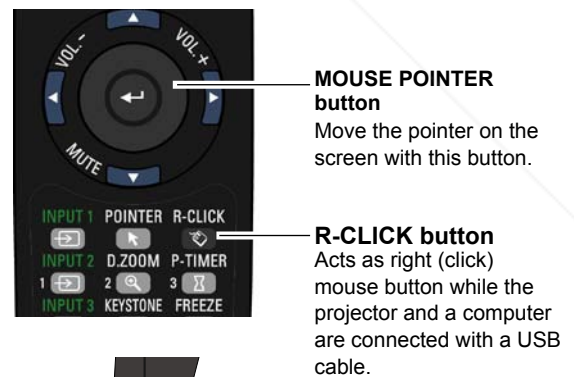

# Input Selection

## Direct Operation

### Side Control/Remote Control Operation

#### Side Control

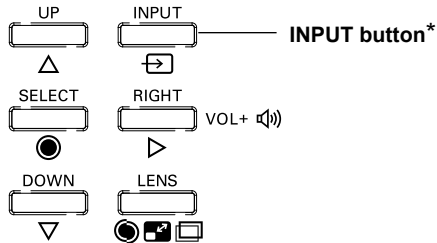

#### Remote Control

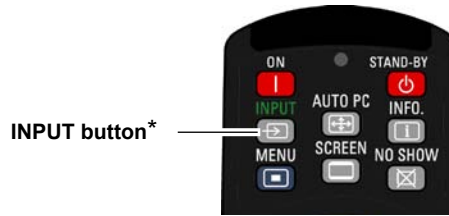

\* Only the Input button function is set **Mode 1** in the Setting menu, the INPUT button is used for switching input source. (p.51)

The input source changes each time you press the INPUT button on the side control or the remote control as follows:

Input 1 → Input 2 → Input 3 → ...

Before using the INPUT button on the side control or the remote control, you must select a correct input source by On-Screen Menu and the latest input source will be displayed.

### Remote Control Operation

Press the INPUT 1, INPUT 2, or INPUT 3 button on the remote control. The input source appears on the screen as you press each button. Select the connected input source.

#### INPUT 1 button

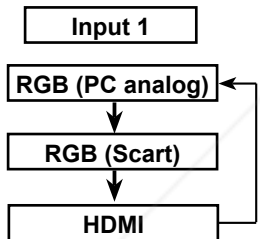

#### INPUT 2 button

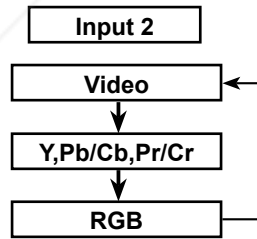

#### Remote Control



#### INPUT 3 button

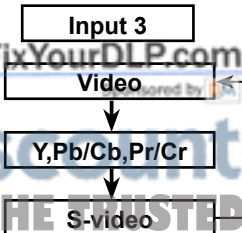

## Computer Input Source Selection

### Menu Operation

- 1 Press the MENU button to display the On-Screen Menu. Use the Point ▲▼ buttons to select **Input** and then press the Point ► or the SELECT button.
- 2 Use the Point ▲▼ buttons to select the desired input and then press the Point ► button to access the submenu items.
- 3 Use the Point ▲▼ buttons to select the desired source and then press the SELECT button.

### WHEN SELECTING INPUT 1 (COMPUTER INPUT TERMINALS)

#### RGB(PC analog)

When your computer is connected to the INPUT 1 (ANALOG) terminal, select **RGB (PC analog)**.

✓ **Note:**

Input source changes if the INPUT 1 button on the remote control is pressed.

### INPUT MENU

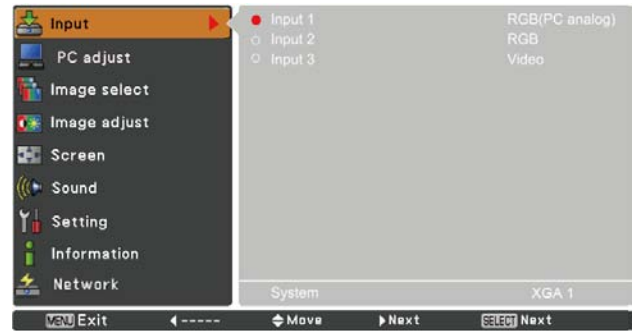

### INPUT 1 MENU



### INPUT 2 MENU



### WHEN SELECTING INPUT 2 (5 BNC INPUT JACKS)

When connecting the computer output [5 BNC Type (Green, Blue, Red, Horiz. Sync, and Vert. Sync.)] from the computer to G, B, R, H/HV and V jacks:

#### RGB

When your computer is connected to the INPUT 2 (5 BNC INPUT JACKS) terminal, select **RGB**.

## Video Input Source Selection

### Menu Operation

- 1 Press the MENU button to display the On-Screen Menu. Use the Point ▲▼ buttons to select **Input** and then press the Point ► or the SELECT button.
- 2 Use the Point ▲▼ buttons to select the desired input and then press the Point ► button to access the submenu items.
- 3 Use the Point ▲▼ buttons to select the desired source and then press the SELECT button.

### WHEN SELECTING INPUT 1 (COMPUTER INPUT TERMINALS )

When connecting to video equipment, select the type of Video source in the Source Select Menu.

#### RGB(Scart)

When scart video equipment is connected to the INPUT 1 (ANALOG) terminal, select **RGB (Scart)**.

#### HDMI

When the video signal is connected to the HDMI terminal, select **HDMI**.

### WHEN SELECTING INPUT 2 (5 BNC INPUT JACKS )

When connecting to video equipment, select the type of Video source in the Source Select Menu.

#### Video

When the video input signal is connected to the VIDEO jack, select **Video**.

#### Y,Pb/Cb,Pr/Cr

When the video input signal is connected to the Y-Pb/Cb-Pr/Cr jacks, select **Y,Pb/Cb,Pr/Cr**.

#### ✓ Note:

- When the video input signal is connected to the Y-Pb/Cb-Pr/Cr jacks, **Y,Pb/Cb,Pr/Cr** takes precedence of **RGB**.
- Y,Pb/Cb,Pr/Cr input can accept the component signal and the analog RGB signal. When analog RGB signal is not recognized in Y,Pb/Cb,Pr/Cr input source, set to **RGB** input manually.

### WHEN SELECTING INPUT 3 (AV TERMINALS )

When connecting to video equipment, select the type of Video source in the Source Select Menu.

#### Video

When the video input signal is connected to the VIDEO jack, select **Video**.

#### Y,Pb/Cb,Pr/Cr

When the video input signal is connected to the Y-Pb/Cb-Pr/Cr jacks, select **Y,Pb/Cb,Pr/Cr**.

#### S-video

When the video input signal is connected to the S-VIDEO jack, select **S-video**.

### INPUT 1 MENU

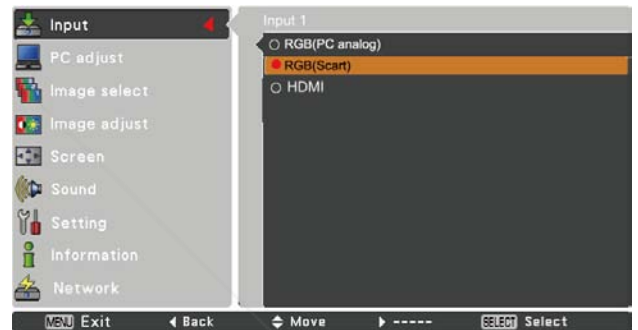

### INPUT 2 MENU

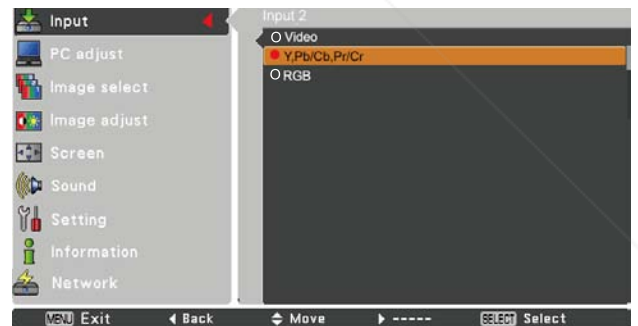

### INPUT 3 MENU



# Computer Input

## Computer System Selection

### Automatic Multi-Scan System

This projector automatically tunes to various types of computers with its Multi-scan system and Auto PC adjustment. If a computer is selected as a signal source, this projector automatically detects the signal format and tunes to project a proper image without any additional settings. (Signal formats provided in this projector are shown on pages 81-82)

One of the following messages may appear when:

**Auto** The projector cannot recognize the connected signal conforming to the provided PC Systems. **Auto** is displayed on the System Menu box and the Auto PC adjustment function works to display proper images. If the image is not projected properly, a manual adjustment is required (pp.38-39).

**-----** There is no signal input from the computer. Check the connection between your computer and the projector. (See "Troubleshooting" on pp.72-74.)

**Mode 1** The preset system is manually adjusted in the PC adjust Menu. The adjusted data can be stored in **Mode 1-10** (pp.38-39).

**SVGA 1** PC Systems provided in this projector is chosen. The projector chooses a proper system provided in the projector and displays it.

\***Mode 1** and **SVGA 1** are examples.

### PC System Menu



The PC System Menu Selected system is displayed.

### Selecting Computer System Manually

PC system can also be selected manually.

- 1 Press the MENU button to display the On-Screen Menu. Use the Point ▲▼ buttons to select **Input** and then press the Point ► or the SELECT button.
- 2 Use the Point ▲▼ buttons to select **System** and then press the Point ► or the SELECT button.
- 3 Use the Point ▲▼ buttons to select the desired system and then press the SELECT button.

### PC System Menu

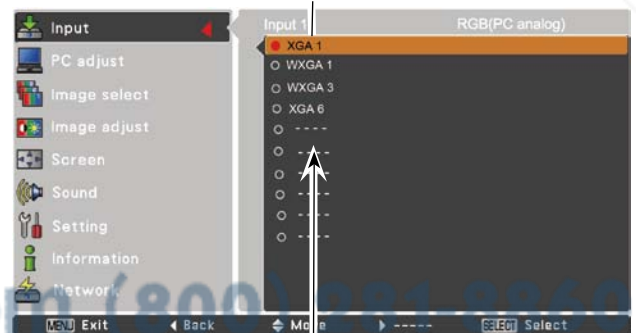

Customized **Mode (1-10)** set in the PC adjust Menu (pp.38-39).

Systems in this dialog box can be selected.

## Auto PC Adjustment

Auto PC Adjustment function is provided to automatically adjust Fine sync, Total dots, Position H and Position V positions to conform to your computer.

### Direct Operation

The Auto PC adjustment function can be operated directly by pressing the AUTO PC button on the remote control.

### Remote Control



AUTO PC button

### Menu Operation

#### Auto PC adj.

- 1 Press the MENU button to display the On-Screen Menu. Use the Point ▲▼ buttons to select **PC adjust** and then press the Point ► or the SELECT button.
- 2 Use the Point ▲▼ buttons to select **Auto PC adj.** and then press the SELECT button.

#### To store the adjusted parameters.

The adjusted parameters from the Auto PC Adjustment can be stored in the projector. Once the parameters are stored, the setting can be done just by selecting Mode in PC SYSTEM Menu (p.36). See "Manual PC Adjustment" on pages 38-39.

#### ✓ Note:

- Fine sync, Total dots, Position H and Position V of certain computers cannot be fully adjusted with the Auto PC Adjustment function. When the image is not provided properly with this operation, manual adjustments are required. (pp.38-39)
- The Auto PC adjustment cannot be operated when **480i, 575i, 480p, 575p, 720p, 1035i, 1080i or 1080p** is selected in the PC System Menu (p.36), or when the signal is coming from the HDMI terminal.
- Depending on the condition of signals and the type and length of cables, the signals may not be properly viewed.

### PC adjust Menu

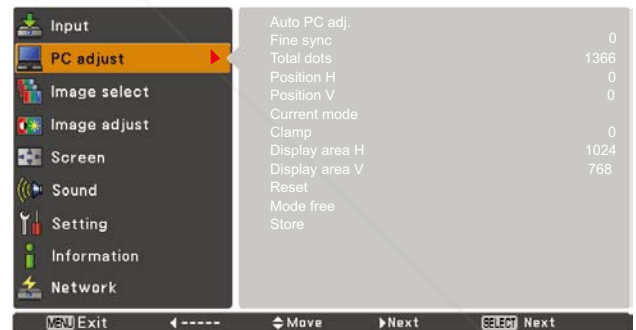

Use the Point ▲▼ buttons to select **Auto PC adj.** and press the SELECT button. **Please wait...** appears while the Auto PC adjustment is in process.

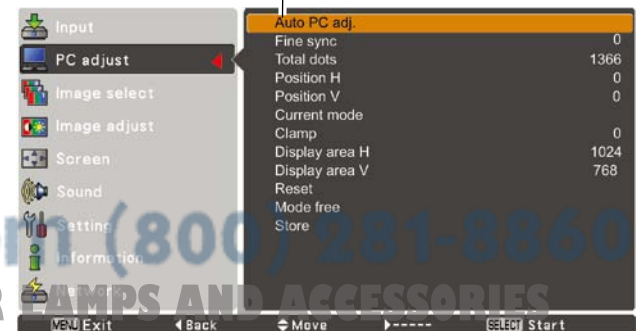

## Manual PC Adjustment

Some computers employ special signal formats which may not be tuned by Multi-Scan system of this projector. Manual PC Adjustment enables you to precisely adjust several parameters to match those special signal formats. The projector has 10 independent memory areas to store those parameters manually adjusted. It allows you to recall the setting for a specific computer.

- 1 Press the MENU button to display the On-Screen Menu. Use the Point ▲▼ buttons to select **PC adjust** and then press the Point ► or the SELECT button.
- 2 Use the Point ▲▼ buttons to select the desired item and then press the SELECT button to display the adjustment dialog box. Use the Point ◀▶ buttons to adjust the setting value.

### Fine sync

Use the Point ◀▶ buttons to adjust the value, eliminating a flicker from the image displayed (from 0 to 31).

### Total dots

Use the Point ◀▶ buttons to adjust the number of total dots in one horizontal period to match your PC image.

### Position H

Use the Point ◀▶ buttons to adjust the horizontal picture position.

### Position V

Use the Point ◀▶ buttons to adjust the vertical picture position.

### Current mode

Press the SELECT button to show H-sync freq. and V-sync freq. of the connected computer.

### Clamp

Use the Point ◀▶ buttons to adjust the clamp level. When the image has dark bars, try this adjustment.

### Display area H

Use the Point ◀▶ buttons to adjust the horizontal area displayed by this projector.

### Display area V

Use the Point ◀▶ buttons to adjust the vertical area displayed by this projector.

## PC adjust Menu

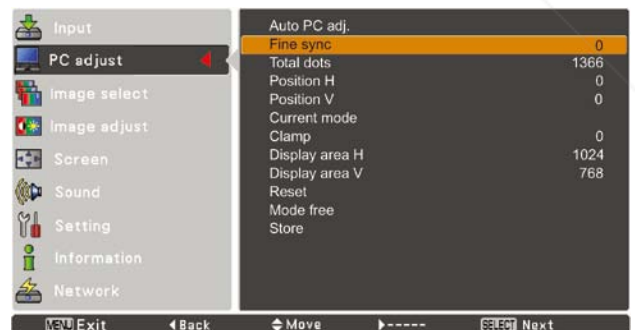
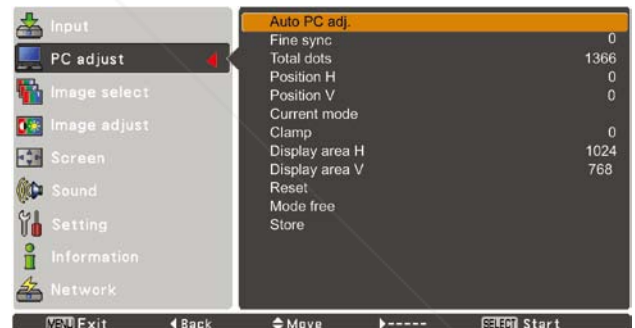
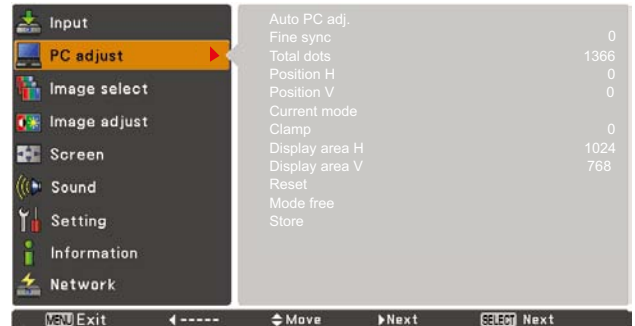

## Reset

To reset the adjusted data, select **Reset** and press the SELECT button. A confirmation box appears and then select **Yes**. All adjustments will return to their previous figures.

## Mode free

To clear the stored data, select **Mode free** and then press the Point ► or the SELECT button. Move the highlight to the Mode that you want to clear and then press the SELECT button.

## Store

To store the adjusted data, select **Store** and then press the Point ► or the SELECT button. Move the highlight to one of the Modes 1 to 10 in which you want to store, and then press the SELECT button.

### Mode free

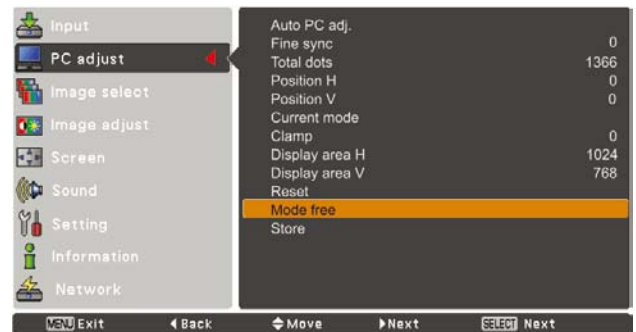

This mode has stored parameters.

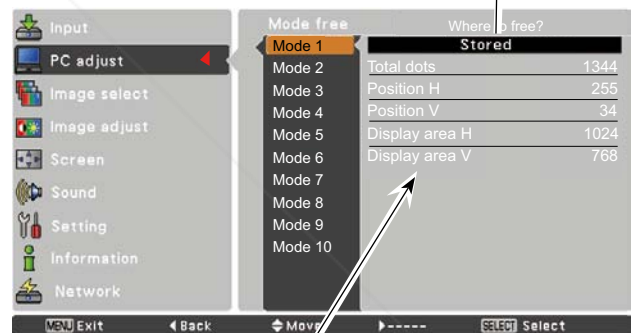

Values of **Total dots**, **Position H**, **Position V**, **Display area H** and **Display area V**.

Press the SELECT button to clear the stored data.

### Store

Vacant

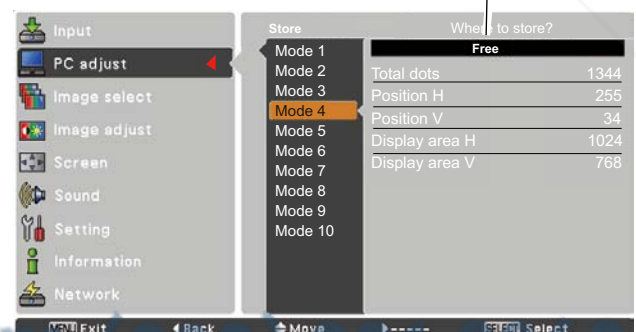

Press the MENU button to close this dialog box.

Press the SELECT button to store the data.

#### ✓ Note:

- **Display area (H/V)** cannot be selected when **480i**, **575i**, **480p**, **575p**, **720p**, **1035i**, **1080i** or **1080p** is selected in the PC System Menu (p.36).
- When input computer signal to the projector, PC adjust function will become available.



## Image Level Selection

### Menu Operation

- 1 Press the MENU button to display the On-Screen Menu. Use the Point ▲▼ buttons to select **Image select** and then press the Point ► or the SELECT button.
- 2 Use the Point ▲▼ buttons to select the desired item and then press the SELECT button.

#### Dynamic

For viewing pictures in a bright room.

#### Standard

Normal picture level preset on the projector.

#### Real

Picture level with improved halftone for graphics.

#### Image 1–10

User preset picture adjustment in the Image adjust Menu. (pp.41-42)

### Image select Menu

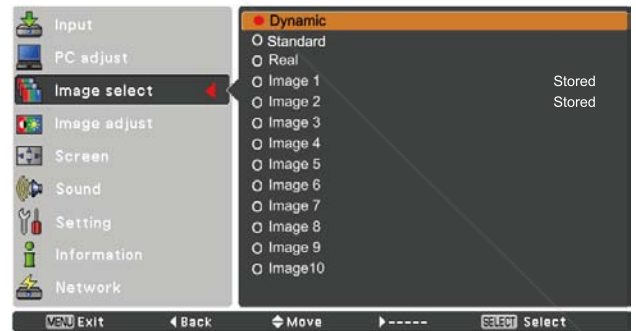

## Image Adjustment

- 1 Press the MENU button to display the On-Screen Menu. Use the Point ▲▼ buttons to select **Image adjust** and then press the Point ► or the SELECT button.
- 2 Use the Point ▲▼ buttons to select the desired item and then press the SELECT button to display the adjustment dialog box. Use the Point ◀▶ buttons to adjust the setting value.

### Contrast

Press the Point ◀ button to decrease the contrast; press the Point ► button to increase the contrast (from 0 to 63).

### Brightness

Press the Point ◀ button to decrease the brightness; press the Point ► button to increase the brightness (from 0 to 63).

### Color temp.

Use the Point ◀▶ buttons to select the desired Color temp. level (XLow, Low, Mid or High).

### White balance (Red)

Press the Point ◀ button to lighten red tone; press the Point ► button to deepen red tone (from 0 to 63).

### White balance (Green)

Press the Point ◀ button to lighten green tone; press the Point ► button to deepen green tone (from 0 to 63).

### White balance (Blue)

Press the Point ◀ button to lighten blue tone; press the Point ► button to deepen blue tone (from 0 to 63).

### Offset(Red/Green/Blue)

Press the Point ◀ button to lighten red/green/blue tone of the black level of an image; press the Point ► button to deepen red/green/blue tone of the black level of an image.

### Sharpness

Press the Point ◀ button to decrease the sharpness of the image; press the Point ► button to increase the sharpness of the image (from 0 to 31).

### Gamma

Use the Point ◀▶ buttons to adjust the gamma value to obtain a better balance of contrast (from 0 to 15).

### Image adjust Menu



### Selected Image mode

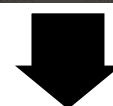
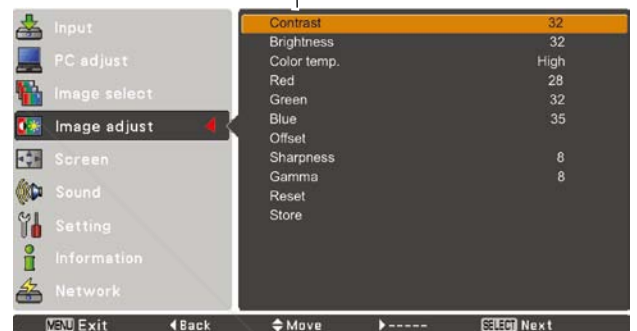

Use the Point ◀▶ buttons to adjust the setting value.



✓ **Note:**

When White balance Red, Green or Blue is adjusted, Color temp. will change to Adj..

## Reset

To reset the adjusted data, select **Reset** and press the SELECT button. A confirmation box appears and then select **Yes**. All adjustments will return to their previous figures.

## Store

To store the adjusted data, select **Store** and press the Point ► or the SELECT button. Use the Point ▲▼ buttons to select one from Image 1 to 10 and press the SELECT button.

A confirmation box appears and then select **Yes**. Stored data can be called up by selecting an **Image (1–10)** in the Image Mode Selection on page 40.

## Store



A confirmation box appears and then select **Yes**.

## Screen Size Adjustment

Select the desired screen size that conforms to the input signal source.

- 1 Press the MENU button to display the On-Screen Menu. Use the Point ▲▼ buttons to select **Screen** and then press the Point ► or the SELECT button.
- 2 Use the Point ▲▼ buttons select the desired item and then press the SELECT button.

## Normal

Provide the image within a screen size keeping its original aspect ratio.

## Full

Provide the image to fit full screen size.

## Wide (16:9)

Provide the image at the 16:9 wide screen ratio.

## Zoom

Scale the image proportionally to fit the entire screen. Either side of image may go over the screen.

## True

Provide the image in its original size. When the original image size is larger than the screen size (1280 x 800), the projector enters to the panning mode automatically. Use the Point ▲▼◀▶ buttons to pan the image. When adjusted, the arrows will turn red. When reached to the correction limits, the arrows will disappear.

## Custom

Provide the last stored aspect screen image.

## SCREEN MENU

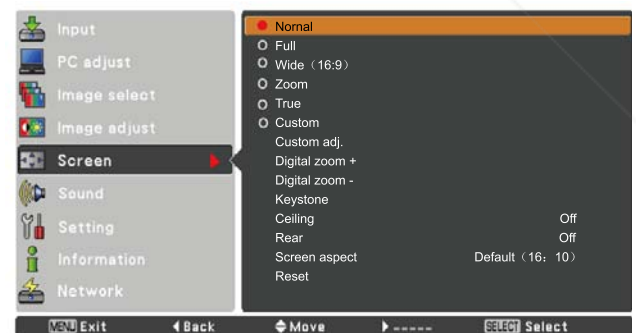
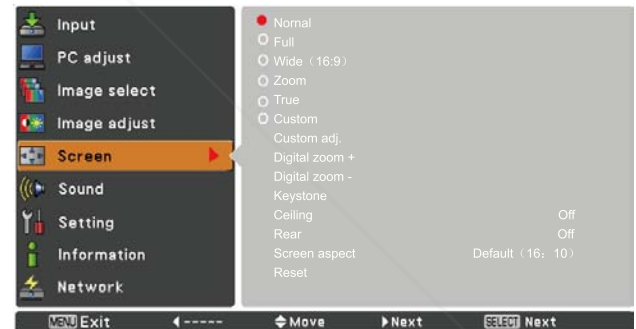

## ✓ Note:

- The projector cannot display any resolution higher than 1920 x 1200. If your computer's screen resolution is higher than 1920 x 1200, lower the resolution before connecting the projector.
- The image data other than 1280x 800 is modified to fit the screen size in initial mode.
- **Full, Wide(16:9), Zoom, True and Digital zoom +/-** cannot be selected when no signal is detected in the PC System Menu. (p.36)

## Custom adj.

Adjust the screen scale and position manually with this function. Press the Point ► button or the SELECT button at **Custom adj.** and **Custom adj.** is displayed on the screen, you can use the Point ▲▼ buttons to choose the item you want to adjust.

**Scale H/V** ..... Adjust the Horizontal/Vertical screen scale.

**H&V** ..... When set to **On**, the aspect ratio is fixed.

**Scale V** appears dimmed and becomes unavailable. Adjust **Scale H**, then the screen scale is automatically modified based on the aspect ratio.

**Position H/V** ..... Adjust the Horizontal/Vertical screen position.

**Common** ..... Save the adjusted scale to all the inputs.

Press the SELECT button at **Common** to display a confirmation box. To save the scale, press the SELECT button at **Yes**. When **Custom** is selected, the saved scale is used.

**Reset** ..... Reset the all adjusted values. Press the SELECT button at **Reset** to display a confirmation box. To reset, press the SELECT button at **Yes**.

## Digital zoom +

Select **Digital zoom +**. The On-Screen Menu disappears and **D. zoom +** appears. Press the SELECT button to expand the image size. Use the Point ▲▼◀▶ buttons to pan the image. The Panning function can work only when the image is larger than the screen size.

You can also enter the Digital zoom + mode by pressing the D.ZOOM button on the remote control.

## Digital zoom -

Select **Digital zoom -**. The On-Screen Menu disappears and **D. zoom -** appears. Press the SELECT button to compress image size.

The projected image can be also compressed by pressing the D.ZOOM button on the remote control.

You can also enter the Digital zoom - mode by pressing the D.ZOOM button on the remote control.

To return to the previous screen size, select a screen size from the Screen Size Adjustment Menu or select an input source from the Input Source Selection Menu (see pages 33-35) again or adjust the screen size with the D.ZOOM button.

## Custom adj.



### ✓ Note:

- When no signal is detected, **Normal** is set automatically and the Aspect dialog box disappears.
- The adjustable range for **Scale H/V** and **Position H/V** is limited depending on the input signal.

### ✓ Note:

- The panning function may not operate properly if the stored Mode in the PC adjust Menu is used (p.39).
- The minimum compression ratio is limited depending on the input signal, when the Keystone function is working or when the custom is selected for the screen size.
- **True and Digital zoom +/-** cannot be selected when **480i, 575i, 480p or 575p** is selected in the PC System Menu (p.36).
- **Digital zoom +/-** cannot be selected when **True** is selected.
- **Digital zoom -** cannot be operated when **Custom** is selected.

## Keystone

This function is used to adjust keystone distortion of the projected image. Use the Point ▲▼ buttons to choose the item you want to adjust.

### ◆ Keystone correction

To correct keystone distortion, press the SELECT button. Keystone appears on the screen. Use the Point ▲▼ buttons to correct keystone distortion (p.31).

### ◆ Store or Reset

To store or reset the keystone correction, press the Point ► button.

**Store** ..... Keep the keystone correction even when the AC power cord is unplugged.

**Reset** ..... Release the keystone correction when the AC power cord is unplugged.

## Keystone

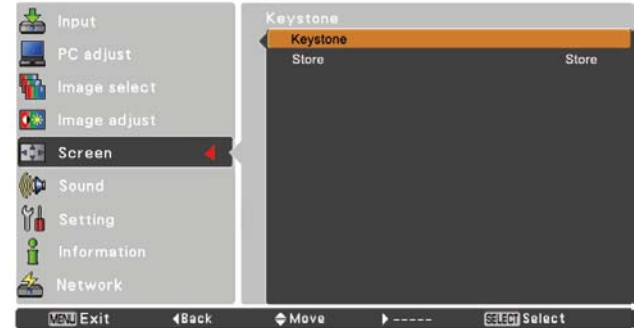

## Ceiling

When this function is set to **On**, the picture will be top/bottom and left/right reversed. This function is used to project the image from a ceiling-mounted projector.

## Ceiling

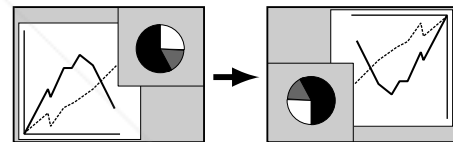

## Rear

When this function is set to **On**, the picture will be left/right reversed. This function is used to project the image from rear of the screen.

## Rear

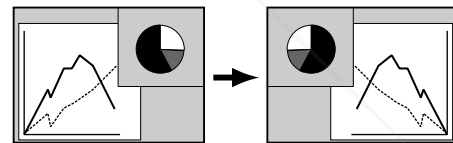

## Screen aspect

This function is used to project the image to a 4:3 or 16:9 projection screen.

**Default (16:10)** ..... 16:10 is the aspect of the LCD panel. The original Screen Menu is available.

**16:9** ..... Set to a 16:9 projection screen.

**4:3** ..... Set to a 4:3 projection screen.

## Reset

This function returns all adjusted values to the factory default settings. Press the SELECT button at **Reset** to display a confirmation box. To reset, press the SELECT button at "Yes."

### ✓ Note:

- Natural wide cannot be selected when 720p, 1035i, 1080i or 1080p is selected on AV System Menu (p.45).
- When the 16:9 function is selected, Wide(16:9) is not available in the PC and AV screen (pp.42-44,49).
- When the 4:3 function is selected, Natural wide is not available in the AV screen (p.49).

# Video Input

## Video System Selection

- 1 Press the MENU button to display the On-Screen Menu. Use the Point ▲▼ buttons to select **Input** and then press the Point ► or the SELECT button.
- 2 Use the Point ▲▼ buttons to select **Video**, **S-video** or **Computer 1(Component)** and then press the SELECT button.
- 3 Use the Point ▲▼ buttons to select **System** and then press the Point ► or the SELECT button. Use the Point ▲▼ buttons to select the desired system and then press the SELECT button.

### Video Jack or S-video Jack

#### Auto

The projector automatically detects an incoming video system, and adjusts itself to optimize its performance.

When Video System is **PAL-M** or **PAL-N**, select the system manually.

#### PAL/SECAM/NTSC/NTSC4.43/PAL-M/PAL-N

If the projector cannot reproduce proper video image, select a specific broadcast signal format from among **PAL**, **SECAM**, **NTSC**, **NTSC 4.43**, **PAL-M**, and **PAL-N**.

### Y, Pb/Cb, Pr/Cr Jacks

#### Auto

The projector automatically detects an incoming video signal, and adjusts itself to optimize its performance.

When the Video System is **1035i**, **1080i** or **1080p**, select the system manually.

#### Y, Pb/Cb, Pr/Cr SIGNAL FORMAT

If the projector cannot reproduce proper video image, select a specific component video signal format from among **480i**, **575i**, **480p**, **575p**, **720p**, **1035i**, **1080i** and **1080p**.

### AV System Menu (Video or S-video)



### AV System Menu (Y, Pb/Cb, Pr/Cr)



Discount-Merchant.com (800) 281-8860

THE TRUSTED SOURCE FOR PROJECTOR PARTS AND ACCESSORIES

**Note:**  
The AV System Menu cannot be selected when selecting RGB (Scart).

## Image Level Selection

### Menu Operation

- 1 Press the MENU button to display the On-Screen Menu. Use the Point ▲▼ buttons to select **Image select** and then press the Point ► or the SELECT button.
- 2 Use the Point ▲▼ buttons to select the desired item and then press the SELECT button.

#### Dynamic

For viewing pictures in a bright room.

#### Standard

Normal picture level preset on the projector.

#### Natural

Naturally picture level preset on the projector.

#### Cinema

Picture level adjusted with fine tone.

#### Image 1–10

User preset picture adjustment in the Image adjust Menu. (p.48)

### Image select Menu

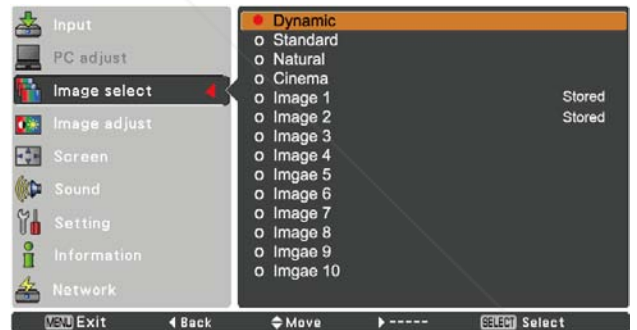
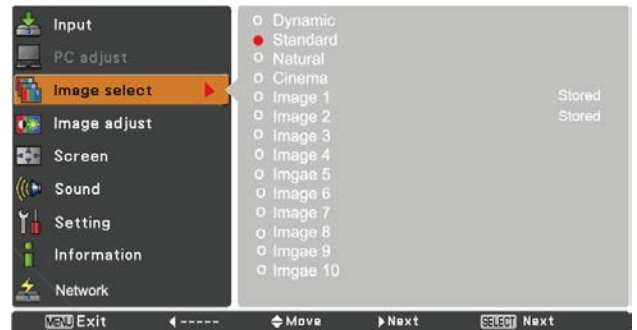

# Image Adjustment

- 1** Press the MENU button to display the On-Screen Menu. Use the Point ▲▼ buttons to select **Image adjust** and then press the Point ► or the SELECT button.
- 2** Use the Point ▲▼ buttons select the desired item and then press the SELECT button to display the adjustment dialog box. Use the Point ◀▶ buttons to adjust the setting value.

### Contrast

Press the Point ◀ button to decrease the contrast; press the Point ▶ button to increase the contrast (from 0 to 63).

### Brightness

Press the Point ◀ button to decrease the brightness; press the Point ▶ button to increase the brightness (from 0 to 63).

### Color

Press the Point ◀ button decrease the intensity of the color; press the Point ▶ button increase the intensity of the color (from 0 to 63).

### Tint

Press the Point ◀▶ buttons to adjust the tint value to get a proper color balance (from 0 to 63).

### Color temp.

Use the Point ◀▶ buttons to select the desired Color temp. level (XLow, Low, Mid or High).

### White balance (Red)

Press the Point ◀ button to lighten red tone; press the Point ▶ button to deepen red tone (from 0 to 63).

### White balance (Green)

Press the Point ◀ button to lighten green tone; press the Point ▶ button to deepen green tone (from 0 to 63).

### White balance (Blue)

Press the Point ◀ button to lighten blue tone; press the Point ▶ button to deepen blue tone (from 0 to 63).

✓ **Note:**

- When White balance Red, Green or Blue is adjusted, the Color temp. level will change to **Adj.**
- **Tint** cannot be selected when the video system is **PAL, SECAM, PAL-M** or **PAL-N** (p.45).

### Image adjust Menu

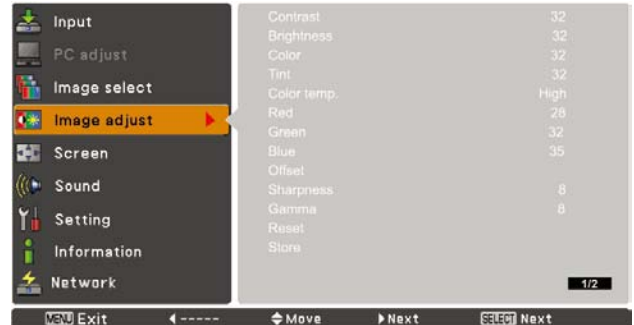

Selected Image mode

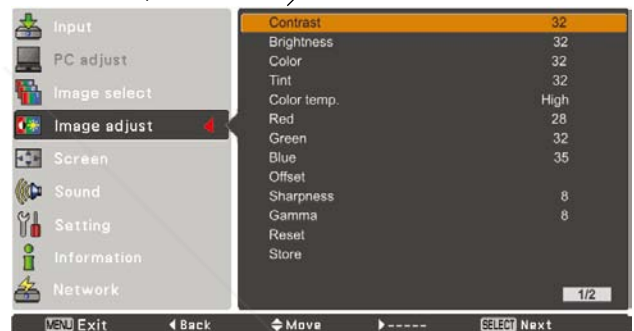

Use the Point ◀▶ buttons to adjust the setting value.



FixYourDLP.com

DiscountMerchant.com (800) 281-8860

THE TRUSTED SOURCE FOR PROJECTOR LAMPS AND ACCESSORIES



## Offset(Red/Green/Blue)

Press the Point ◀ button to lighten red/green/blue tone of the black level of an image; press the Point ▶ button to deepen red/green/blue tone of the black level of an image (from 0 to 63).

## Sharpness

Press the Point ◀ button to decrease the sharpness of the image; press the Point ▶ button to increase the sharpness of the image (from 0 to 31).

## Gamma

Use the Point ◀ ▶ buttons to adjust the gamma value to obtain a better balance of contrast (from 0 to 15).

## Noise reduction

Noise interference on the screen can be reduced. Press the Point ◀ ▶ buttons to change the noise reduction mode.

**Off** ..... Noise reduction mode is **Off**.

**On** ..... Noise reduction mode is **On**.

## Progressive

An interlaced video signal can be displayed in progressive mode. Press the Point ◀ ▶ buttons to change the progressive scan mode.

**Off** ..... Progressive scan mode is **Off**.

**On** ..... Progressive scan mode is **On**.

**Film** ..... For watching a film. With this function, the projector reproduces pictures faithful to the original film quality.

## Reset

To reset the adjusted data, select **Reset** and press the SELECT button. A confirmation box appears and then select **Yes**. All adjustments will return to their previous figures.

## Store

To store the adjusted data, select **Store** and press the Point ▶ or the SELECT button. Use the Point ▲ ▼ buttons to select one from Images 1 to 10 and press the SELECT button.

A confirmation box appears and then select **Yes**. Stored data can be called up by selecting an **Image (1-10)** in the Image Mode Selection on page 46.

### ✓ Note:

- **Noise reduction** and **Progressive** cannot be selected when **Video delay control** is set to **On** (p.63).
- **Progressive** cannot be selected when **480p**, **575p**, **720p** or **1080p** is selected (p.45).
- **Noise reduction** cannot be selected when **1080p** is selected (p.45).

## Store



A confirmation box appears and then select **Yes**.

## Screen Size Adjustment

- 1 Press the MENU button to display the On-Screen Menu. Use the Point ▲▼ buttons to select **Screen** and then press the Point ► or the SELECT button.
- 2 Use the Point ▲▼ buttons to select the desired item and then press the SELECT button.

### Normal

Provide the image within a screen size keeping its original aspect ratio.

### Full

Provide the image to fit full screen size.

### Wide(16:9)

Provide the image at the 16:9 wide screen ratio.

### Zoom

Scale the image proportionally to fit the entire screen. Either side of image may go over the screen.

### Natural Wide

Expand the right and left side of images naturally without changing the center areas.

### Custom

Provide the last stored aspect screen image.

### Custom adj.

Adjust the screen scale and position manually with this function. Press the Point ► button at Custom adj. and the Custom adjustment menu is displayed on the screen, you can use the Point ▲▼ buttons to choose the item you want to adjust.

**Scale H/V** ..... Adjust the Horizontal/Vertical screen scale.

**H&V** ..... When set to **On**, the aspect ratio is fixed.

**Scale V** appears dimmed and becomes unavailable. Adjust **Scale H**, then the screen scale is automatically modified based on the aspect ratio.

**Position H/V** ..... Adjust the Horizontal/Vertical screen position.

**Common** ..... Save the adjusted scale or position to all the inputs. Press the SELECT button at Common to display a confirmation box. To save the scale or position, press the SELECT button at "Yes". When Custom is selected, the saved scale or position is used.

**Reset** ..... Reset all the adjusted values. Press the SELECT button at **Reset** to display a confirmation box. To reset, press the SELECT button at **Yes**.

### Custom adj.



#### ✓ Note:

- When no signal is detected, **Normal** is set automatically and the Aspect dialog box disappears.
- The adjustable range for Scale H/V and Position H/V are limited depending on the input signal.
- Natural wide cannot be selected when 720p, 1035i, 1080i or 1080p is selected on AV System Menu (p.45).

## Keystone

This function is used to adjust keystone distortion of the projected image. Use the Point ▲▼ buttons to choose the item you want to adjust.

### ◆ Keystone correction

To correct keystone distortion, press the SELECT button.

Keystone appears on the screen. Use the Point ▲▼ buttons to correct keystone distortion (p.31).

### ◆ Store or Reset

To store or reset the keystone correction, press the Point ► button.

**Store** ..... Keep the keystone correction even when the AC power cord is unplugged.

**Reset** ..... Release the keystone correction when the AC power cord is unplugged.

## Keystone



## Ceiling

When this function is set to **On**, the picture will be top/bottom and left/right reversed. This function is used to project the image from a ceiling-mounted projector.

## Ceiling

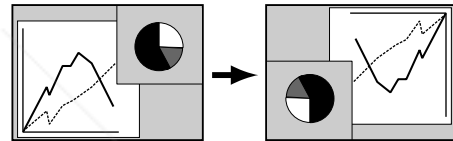

## Rear

When this function is set to **On**, the picture will be left/right reversed. This function is used to project the image from rear of the screen.

## Rear

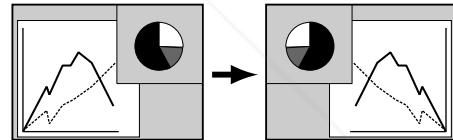

## Screen aspect

This function is used to project the image to a 4:3 or 16:9 or projection screen.

**Default (16:10)** .....16:10 is the aspect of the LCD panel. The original Screen Menu is available.

**16:9** ..... Set to a 16:9 projection screen.

**4:3** ..... Set to a 4:3 projection screen.

### ✓ Note:

- When the 16:9 function is selected, Wide(16:9) is not available in the PC and AV screen (pp.42-44, 49).

- When the 4:3 function is selected, Natural wide is not available in the AV screen (p.49).

## Reset

This function returns all adjusted values to the factory default settings. Press the SELECT button at **Reset** to display a confirmation box. To reset, press the SELECT button at "Yes."

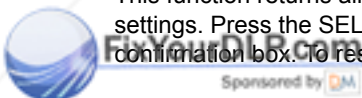

Sponsored by DM

**Discount-Merchant.com (800) 281-8860**  
**THE TRUSTED SOURCE FOR PROJECTOR LAMPS AND ACCESSORIES**

# Setting

## Setting

This projector has a Setting menu that allows you to set up the other various functions described below.

- 1** Press the MENU button to display the On-Screen Menu. Press the Point ▲▼ buttons to select **Setting** and press the Point ► or the SELECT button to access the submenu items.
- 2** Use the Point ▲▼ buttons to select the desired item and then press the Point ► or the SELECT button to access the selected item.
- 3** Use the Point ▲▼ buttons to select the desired item and then press the SELECT button.

### Language

The language used in the On-Screen Menu is available in English, German, French, Italian, Spanish, Portuguese, Dutch, Swedish, Russian, Chinese, Korean and Japanese.

### Menu position

This function is used to change the position of the On-Screen Menu. Select **Menu position** and press the SELECT button.

The Menu position changes each time you press the SELECT button as follows.

the top left → the top right → the center → the bottom left → the bottom right → the top left →.....

### Input button

This function detects the input signal automatically. When a signal is found, the search will stop. Use the Point ▲▼ buttons to select one of the following options.

**Mode 1**.....Input search will not work.

**Mode 2**.....Input search works under the following situation:

- When pressing the INPUT button on the side control or the remote control.

**Mode 3**.....Input search works under the following situation:

- When turning on the projector by pressing the ON/STAND-BY button on the side control or pressing the ON button on the remote control.
- When pressing the INPUT button on the remote control or on the side control.
- When no signal is detected.

### Setting Menu

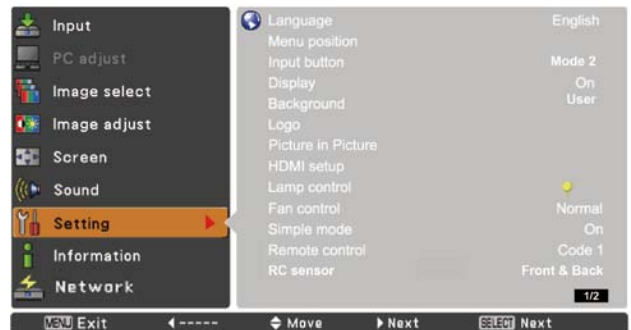

### Language

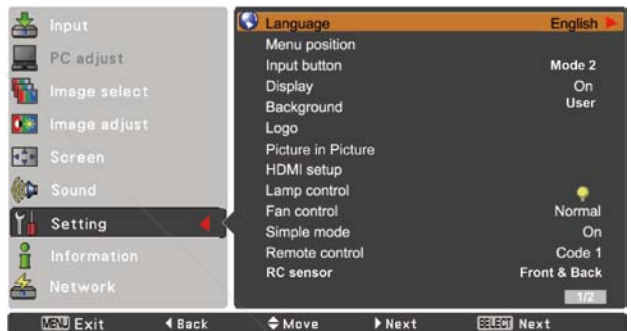

#### ✓ Note:

- While **Input button** is set to **Mode 3**, and no signal is detected, if the No Show or Freeze function is active, cancel it to activate the Input search.
- While **Input button** is set to **Mode 1** or **Mode 2**, the status of **Input** and **Lamp** are displayed every time the signal is switched.
- Only the last selected input source can be detected.
- If the **INPUT**, **INPUT 1**, **INPUT 2**, **INPUT 3**, **ON / STAND-BY** or **MENU** button is pressed during Input search in progress, Input search will stop and go back to the previous input signal.

## Display

This function decides whether to display On-Screen Displays.

- On** ..... Show all the On-Screen displays. Use this function when you want to project images after the lamp becomes bright enough. The factory default setting is in this option.
- Countdown Off** ..... Show the input image instead of the countdown when turning on the projector. Use this function when you want to project the image as early as possible even when the lamp is not bright enough.
- Off** ..... Hide the On-Screen Displays except;
  - On-Screen Menu
  - **Power off?** (p.24)
  - **No signal** for Power management. (p.59)
  - **Please wait ...**
  - Arrows for the True function in the Screen Menu (p.42)
  - **P-timer**
  - **Simple mode**
  - **Picture in Picture**

## Background

Select the background screen for when no input signal is detected. Press the Point ▲▼ buttons to switch between each option.

- Blue** . . . . Project a blue background.
- Black** . . . Project a black background.  
It is invalid when there is no image.
- User** . . . . Project an image captured in the Logo setting.

## Logo (Logo and Logo PIN code lock settings)

This function allows you to customize the screen logo with **Logo select**, **capture**, **Logo PIN code lock** and **Logo PIN code change** functions.

✓ **Note:**

When **On** is selected in the **Logo PIN code lock** function, **Logo select**, **Capture** and **Logo PIN code change** cannot be selected.

## Logo select

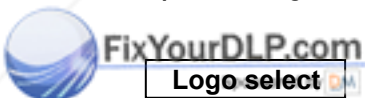
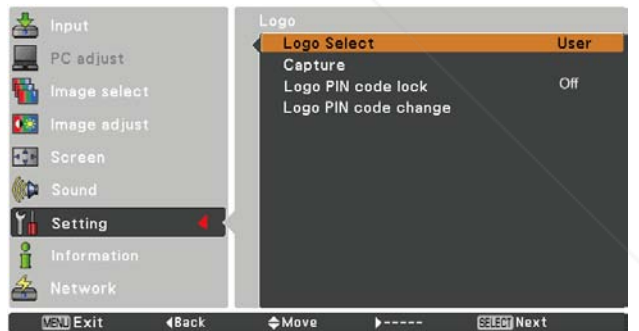
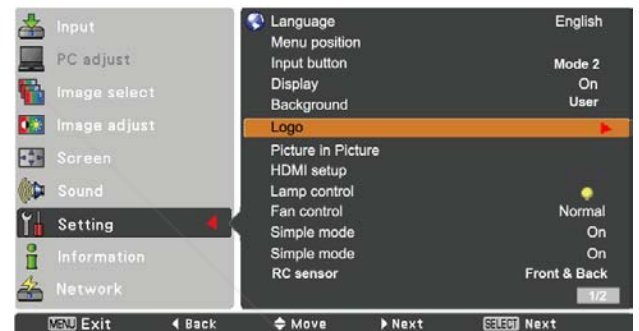

## Logo select

This function decides on the starting-up display from among following options.

- User** ..... Show the image you captured.
- Default** ..... Show the factory-set logo.
- Off** ..... Show the countdown display only.

**Capture**

This function enables you to capture an image being projected to use it for a starting-up display or interval of presentations.

Select **Capture** and press the SELECT button. A confirmation box appears and select **Yes** to capture the projected image.

After capturing the projected image, go to the Logo select function and set it to **User**. Then the captured image will be displayed the next time you turn on the projector.

To cancel the capture function, select **Yes** in the "Quit?" confirmation box.

✓ **Note:**

- Before capturing an image, select **Standard** in the Image Select Menu to capture a proper image (pp.40, 46).
- A signal from a computer can be captured up to WXGA (1280 x 800). A signal from video equipment can be captured except for **720p, 1035i, 1080i and 1080p**.
- When capturing the image that has been adjusted by the Keystone function, the adjusted data is automatically reset and the projector captures an image without keystone correction.
- When **Logo PIN code lock** is set to **On**, **Capture** cannot be selected.
- When starting to capture a new image, the previously stored image is cleared even if you cancel the capturing.
- When there is no captured image or it is interrupted while capturing an image, **User** cannot be selected, you can only switch between **Default** and **Off**.
- Capture function is not available when the Picture in Picture function is set to User1-5.

**Logo PIN code lock**

This function prevents an unauthorized person from changing the screen logo.

- Off**..... The screen logo can be changed freely from the Logo Menu (p.52).
- On**..... The screen logo cannot be changed without a Logo PIN code.

If you want to change the **Logo PIN code lock** setting, press the SELECT button and the Logo PIN code dialog box appears. Enter a Logo PIN code by following the steps below. The initial **Logo PIN code** is set to "4321" at the factory.

**Capture**

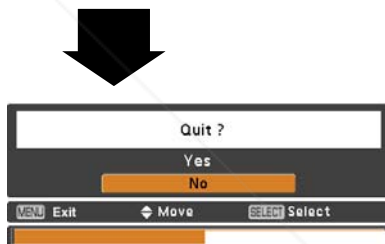
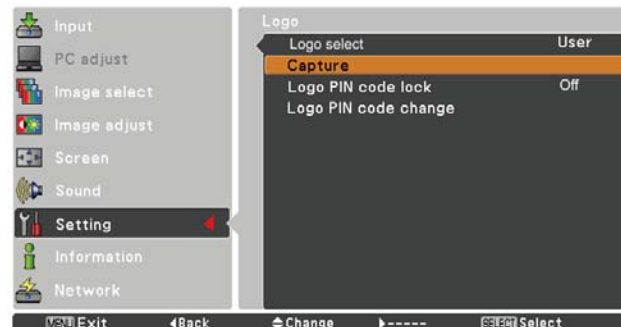

**Logo PIN code lock**

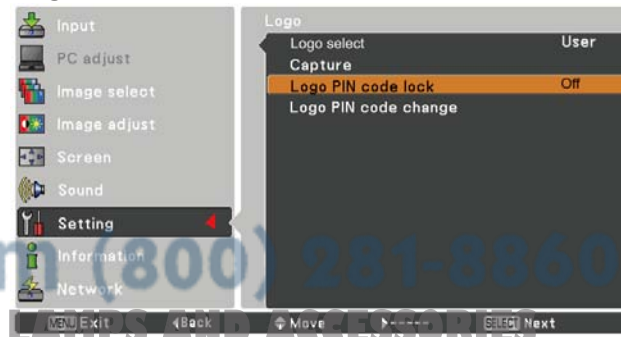

## Enter a Logo PIN code

Use the Point ▲▼ buttons to enter a number. Press the Point ► button to fix the number and move the red frame pointer to the next box. The number changes to \*. If you fixed an incorrect number, use the Point ► button to move the pointer to the number you want to correct, and then enter the correct number.

Repeat this step to complete entering a four-digit number.

After entering the four-digit number, move the pointer to **Set**. Press the SELECT button so that you can start to operate the projector.

If you entered an incorrect Logo PIN code, **Logo PIN code** and the number (\*\*\*\*) will turn red for a moment. Enter the correct Logo PIN code all over again.

## Change the Logo PIN code lock setting

Use the Point ▲▼ buttons to switch **On** or **Off**, and then press the SELECT button to close the dialog box.

### Logo PIN code change

Logo PIN code can be changed to your desired four-digit number. Press the Point ▼ button to select **Logo PIN code change** and then press the SELECT button. The Current logo PIN code dialog box appears. Use the Point ▲▼ buttons to set the current logo PIN code. The New logo PIN code dialog box appears. Set a new Logo PIN code, the confirmation box appears, and choose Yes to set the new Logo PIN code.

Be sure to note the new Logo PIN code and keep it on hand. If you lost the number, you could no longer change the Logo PIN code setting.

## Enter a Logo PIN code

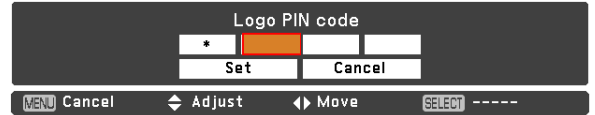

After a correct Logo PIN code is entered, the following dialog box appears.

## Change the Logo PIN code lock setting



## Change the Logo PIN code

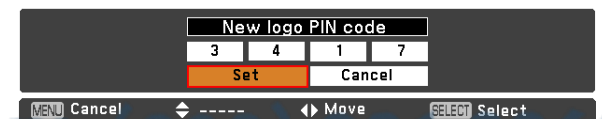
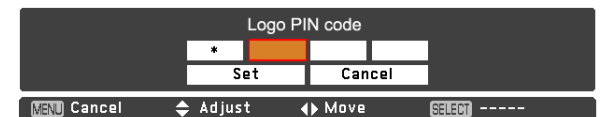

**CAUTION:**  
WHEN YOU HAVE CHANGED THE LOGO PIN CODE, WRITE DOWN THE NEW PIN CODE IN COLUMN OF THE LOGO PIN CODE NO. MEMO ON PAGE 86, AND KEEP IT SECURELY. SHOULD THE LOGO PIN CODE BE LOST OR FORGOTTEN, THE LOGO PIN CODE SETTING CAN NO LONGER BE CHANGED.

## Picture in Picture

This function is used to project two images simultaneously by placing a separate small sub screen within or next to the main screen. Use the Point ▲▼ buttons to select **Picture in Picture** and then press the SELECT button to display a dialog box. You can also display the dialog box by pressing and holding the PIP button on the remote control for more than 3 seconds.

Only the sound from the source of Main picture is valid, while the source of Sub picture cannot output the sound. ( In **P in P**, the larger picture is main picture, and the smaller one is sub picture; in **P by P**, the left picture is main picture, and the right one is sub picture.)

### User setting

Show the selected mode (**Off/User 1-5**) and its status (**Stored /Free/ Adj.**). **User 1** and **User 2** have stored default values. See page 30 for details.

### P in P/P by P

**P in P**: Provide the images of Main picture and Sub picture at the ratio of **Screen aspect** in the Screen Menu.

**P by P**: Provide the images of Main picture and Sub picture at the ratio of **4:3**.

### Main picture / Sub picture

**Input**.....Select an input from Input 1-3.

**Source**...Select an input source. The display varies depending on the selected input.

**Size**..... Select the display size. Main picture can be changed between 10 and 100%, and Sub picture can be changed between 10 to 50% in increments of 10%. When **P by P** is selected in Mode, the projection size is fixed to 50%.

**Position**..Press the SELECT button at **Position** and the display position setting screen appears.

Use the Point ▲▼◀▶ buttons to adjust the display position of active frame indicated in white. The frame will disappear after 10 seconds or when the SELECT button is pressed.

### Selecting the Main picture or Sub picture

During Picture in Picture mode, and being undisplayed On Screen Menu, press the SELECT button to select Main or Sub picture. (A red frame will be displayed on the selected picture.)

### Switching Input and Source

When selecting Main picture or Sub picture, input and source can be set by pressing the INPUT button on the side control or INPUT 1/2/3 button on the remote control. Operation on the On Screen Menu is not necessary.

## Picture in Picture

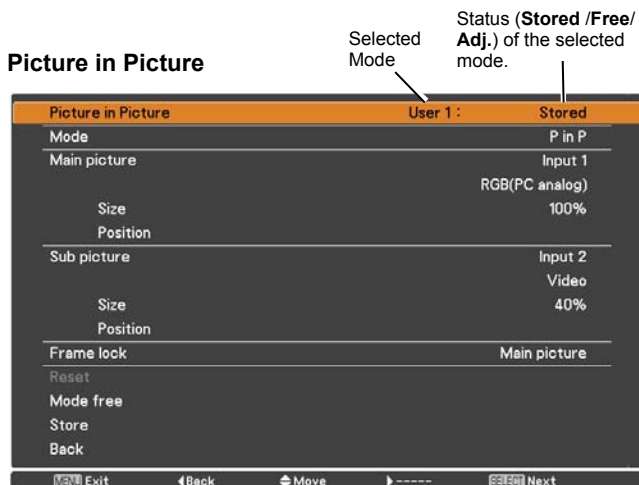

### ✓ Note:

- **P by P** is not available when the 4:3 function is selected in Screen aspect (p.44).
- When **P by P** is selected in every User 1-5 and the 4:3 function is selected in Screen aspect, PIP button on the remote control is not available. To set **Picture in Picture**, select **Default(16;10)** or **16:9** in Screen aspect (p.44).

## Position Menu

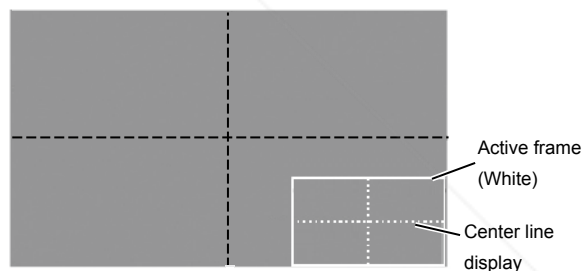

### ✓ Note:

- The Picture in Picture function is not available depending on the input signals and the selected input terminals. Refer to 'List of Picture in Picture' for details. (p.88)
- When the input signal(s) is/are incompatible, **X** mark will be displayed on the Main/Sub picture.



# Setting

## Frame lock

Set the Frame Lock to Main picture or Sub picture.

## Reset

Press the SELECT button at **Reset** to display a confirmation box. To reset, press the SELECT button at **Yes**.

## Mode free

Delete the data stored in the Mode and return to Free. Use the Point ▲▼ buttons to select Mode free and press the SELECT button to show the Where to free? dialog box. Move the highlight to one of the mode (User1 - 5) which you want to delete and press the SELECT button. Then the confirmation box appears. To delete, select Yes.

## Store

Store the adjusted data in the User 1-5. Use the Point ▲▼ buttons to select Store and press the SELECT button to show the Where to store? dialog box. Move the highlight to one of the mode (User1 - 5) which you want to store and press the SELECT button. Then the confirmation box appears. To store adjusted data, select Yes.

## HDMI setup

This function is only used for HDMI input source.

### Image

Select **Normal** or **Enhanced** to match the video range setting of your HDMI Digital RGB equipment.

### Sound

**HDMI:** When using the HDMI cable, select **HDMI**.

Both video and audio are transferred and you need not to connect any additional cables for audio.

**AUDIO 1 :** When using the DVI-HDMI cable, select **AUDIO 1** and connect the audio cable to COMPUTER/COMPONENT AUDIO IN terminal.

The names for the output setting of Digital RGB vary from equipment to equipment. For details, refer to the owner's manual of your Digital RGB equipment. When the black parts of the image are destroyed or stand out, please switch to **Normal** or **Enhanced**, and then switch the output type of the HDMI Digital RGB output equipment.

To store the adjusted data.

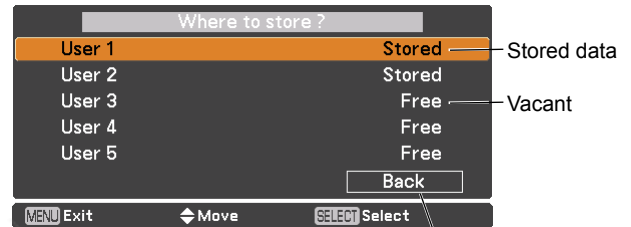

Return to Picture in Picture menu.

## HDMI setup

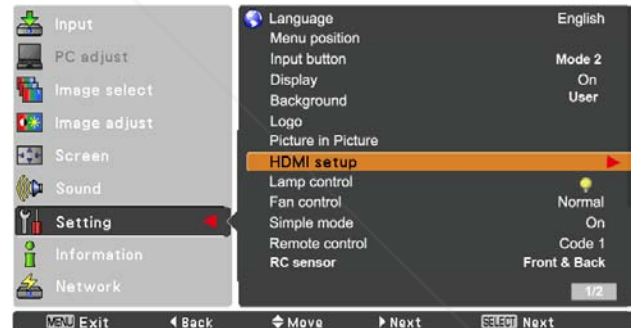

## Lamp control

### Lamp control

This function allows you to change brightness of the screen.

- Auto . . . . . Brightness according to the input signal.
- Normal . . . . . Normal brightness.
- Eco 1 . . . . . Lower brightness and decrease of fan speed. Lower brightness reduces the lamp power consumption and extends the lamp life.
- Eco 2 . . . . . Lower brightness and increase of fan speed. Lower brightness reduces the lamp power consumption and extends the lamp life. It is recommended to use Eco 2 when using the projector continuously over a long period of time. The fan noise becomes louder in Eco 2 than in Eco 1. Select the suitable mode for the used environment.

✓ **Note:**

*The fan noise becomes louder in Eco 2 than in Eco 1. Select the suitable mode for the used environment.*

### Lamp life control

Select the lamp operation when the total lighting time of a lamp exceeds the recommended total hours of use.

- Mode 1** ..... A lamp can be turned on even after exceeding the recommended total hours of use.
- Mode 2** ..... A lamp can be turned on even after exceeding the recommended total hours of use. But the projector turns off automatically after 3 minutes.

✓ **Note:**

- Lamp mode cannot be changed for a while after turning on the projector. Lamp needs some time to stabilize after the power is turned on. Stored lamp mode will be active after the lamp is stabilized.
- If **Mode 2** has been selected and the projection lamp exceeds the recommended total hours of use, the replacement icon will be displayed at the time of power-on. Then the projector will turn off after 3 minutes.

### Lamp life control

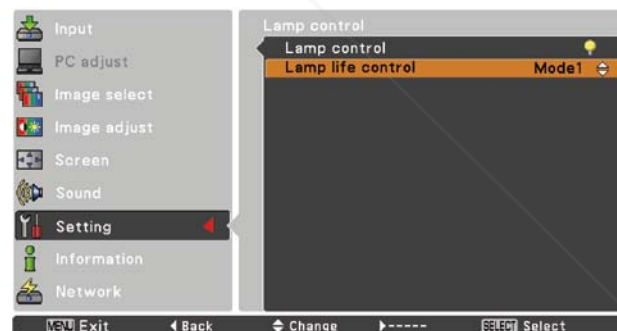
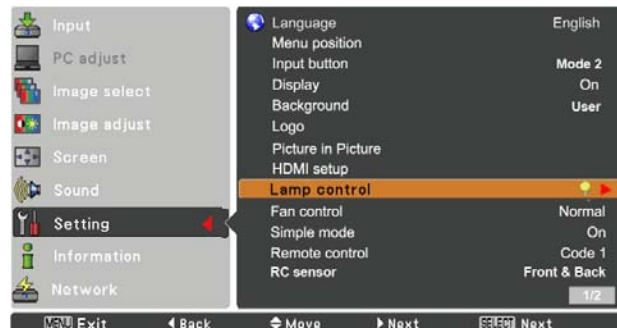

  
 Discount-Merchant.com (800) 281-8860
   
 THE TRUSTED SOURCE FOR PROJECTOR LAMPS AND ACCESSORIES

#### Lamp replacement icon



The Lamp replacement icon will not appear when the Display function is set to Off (p.52), during "Freeze" (p.30) or "No show" (p.29).

## Fan control

Choose the running speed of cooling fans from the following options.

**Normal**..... Operate in this mode under normal conditions.

**Max** ..... Use this mode when you want to increase the cooling effect when operating the projector in high ambient temperature environment. Fan noise is louder than **Normal**.

## Simple mode

This function decides whether to activate the simple mode.

**Off** . . . . Simple mode function is off.

**On** . . . . Only the simple mode buttons are active.

✓ **Note:**

*Warning icon and **Simple mode : On** message appear on the screen when press the button which is not the simple mode button.*

## Remote control

The eight different remote control codes (**Code 1-Code 8**) are assigned to the projector; the factory-set, initial code (**Code 1**) and the other seven codes (**Code 2 to Code 8**).

The same code should be set on both the projector and the remote control. For example, operating the projector in **Code 7**, the remote control code also must be switched to **Code 7**.

### To change the code for the projector

Select a remote control code in this Setting Menu.

### To change the code for the remote control:

Press and hold the MENU button and a number button (1-8) on the remote control for more than five seconds to switch between the codes. See "Remote Control Code" on page 16.

✓ **Note:**

- When different codes are set on the projector and on the remote control, any operation cannot be made. In that case, switch the code on the remote control to fit the code on the projector.
- If the batteries are removed from the remote control for a long period of time, the remote control code will be reset.

## Simple mode buttons



Only these buttons are active when the simple mode is set to **On**. [ON, STAND-BY, INPUT, AUTO PC, INFO., MENU, SCREEN, ▲▼◀▶, SELECT, NO SHOW, VOL.+, VOL.-, MUTE, RESET/ON/ALL-OFF switch] Number buttons (p.14) also become active only when setting the remote control codes numbers or entering the PIN code numbers (pp. 54, 62).



**Simple mode : On**

## RC sensor

Select a location of the infrared remote receiver of the remote control. See “Remote Control Receivers and Operating Range” on page 15 for details.

- All**..... Activate all of the receivers.
- Front & Top** . . . . .Activate both the front and top receivers.
- Top & Back** . . . . .Activate both the top and back receivers.
- Front & Back** . . . . .Activate both the front and back receivers.
- Front**..... Activate only the front receiver.
- Top**..... Activate only the top receiver
- Back**..... Activate only the back receiver.

## Power management

For reducing power consumption as well as maintaining the lamp life, the Power management function turns off the projection lamp when the projector is not operated for a certain period.

Select one of the following options:

- Ready** ..... When the lamp has been fully cooled down, the POWER indicator changes to green blinking. In this condition, the projection lamp will be turned on if the input signal is reconnected or any button on the side control or remote control is pressed.
- Shut down**..... When the lamp has been fully cooled down, the power will be turned off.
- Off**..... Power management function is off.
- Timer**..... If the input signal is interrupted and no button is pressed for more than 30 seconds, the timer display with **No signal** appears. It starts the countdown until the lamp is turned off. Use the Point ▲▼ buttons to set the Timer(1~30Min).

✓ **Note:**

Factory default is **Ready: 5 Min.**

## Standby mode

This function is available when operating the projector via network.

- Network** ..... Supply the power to the network function even after turning off the projector. You can turn on/off the projector via network, modify network environment, and receive an e-mail about projector status while the projector is powered off.
- Eco**..... Select **Eco** when you do not use the projector via network. The projector’s network function will stop when turning off the projector.

Refer to the owner’s manual of “Network Set-up and Operation”.

✓ **Note:**

- Factory default is **Network**.
- When selecting **Network**, the cooling fans may be running depending on the temperature inside the projector even if the projector is turned off.
- When **Eco** is selected and the projector is in Stand-by, the communication of RS-232C serial port is not available.

## Power management



Timer left before Lamp is off.

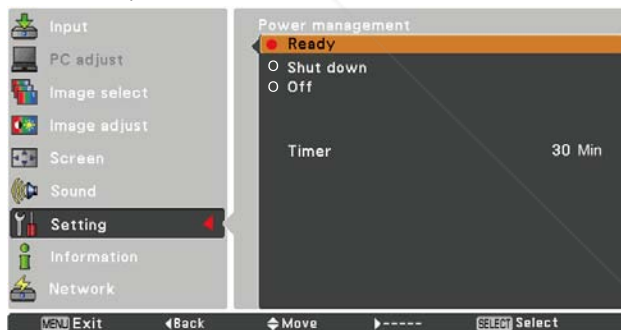
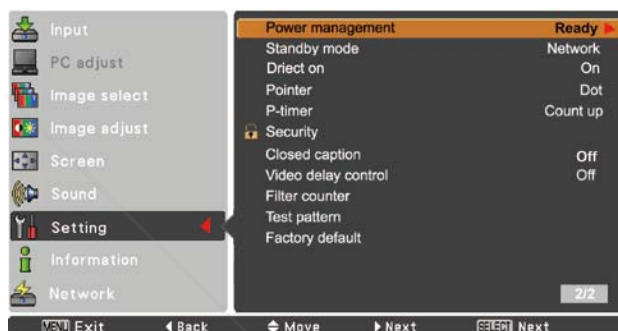

FixYourDLP.com  
Sponsored by

Discount-Merchant.com (800) 281-8860  
THE TRUSTED SOURCE FOR PROJECTOR LAMPS AND ACCESSORIES

## Direct on

When this function is set to **On**, the projector will be automatically turned on just by connecting the AC power cord to the wall outlet.

### ✓ Note:

Be sure to turn off the projector properly (see "Turning Off the Projector" on page 24). If the projector is turned off in the incorrect sequence, the Direct on function does not work properly.

## Pointer

You can emphasize a part of the projected image with this function. Use the Point ▲▼ buttons to select a pattern of the Pointer (Arrow, Finger, or Dot) (p.32)

## P-timer

This function allows you to change the presentation of the P-timer and execute it.

Select one of the following options:

- Count up** ..... The P-timer display **000:00** appears on the screen and the count starts (**000:00–180:00**)
- Count down** ..... The time set in the Timer setting appears on the screen and the countdown starts.
- Timer**..... Use the Point ▲▼ buttons to set the Timer (**1–180 Min**). Only set to **Count down**, **Timer** is active. Factory default value is **10 Min**.
- Start** ..... It executes the count up or count down function. Press the SELECT button at **Start**, **Start** changes to **Stop** in the Screen Menu. At that time, press the SELECT button at **Stop** to stop **Count up** or **Count down**, and **Stop** changes to **Restart** in the Screen Menu. Press the SELECT button at **Restart** to resume **Count up** or **Count down**.
- Reset** ..... Reset the P-timer values. Press the SELECT button at **Reset** to return to the following value;  
**Count up** ... "000:00"  
**Count down** ... Timer that you set
- Exit**..... To exit the P-timer operation.

### Stop or Cancel the P-timer via Remote Control

To stop the P-timer, press the P-TIMER button.  
 To cancel the P-timer, press and hold the P-TIMER button for a few seconds.

## P-TIMER



P-timer display

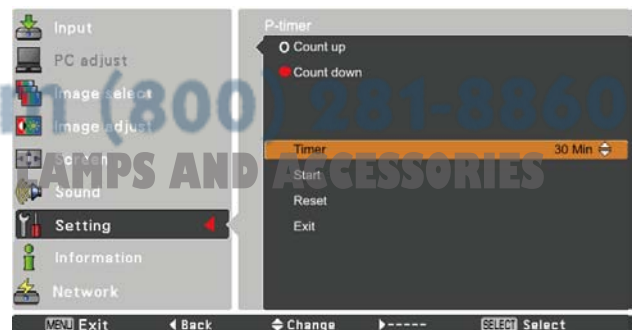
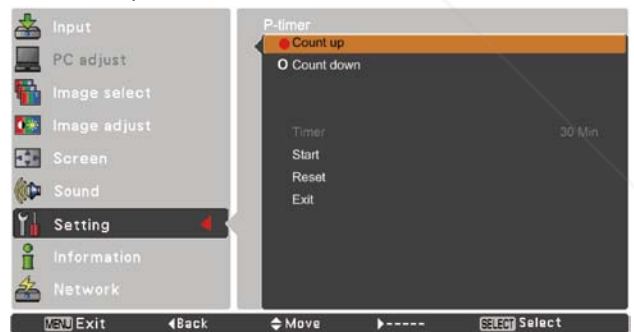
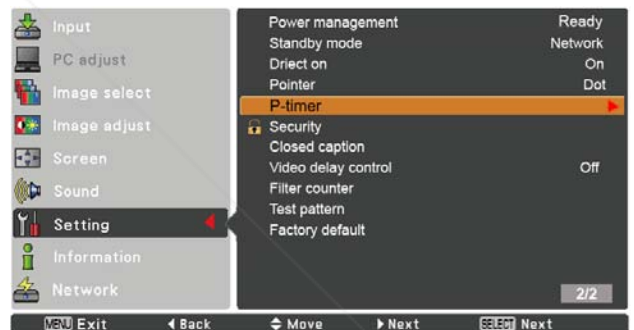



**Security (Key lock and PIN code lock)**

This function allows you to use the Key lock and PIN code lock function to set the security for the projector operation.

**Key lock**

This function locks the side control and remote control buttons to prevent operation by unauthorized persons.



..... Unlocked.



..... Lock the operation of the side control. To unlock, use the remote control.



..... Lock the operation of the remote control. To unlock, use the side control.

If the side control accidentally becomes locked and you do not have the remote control nearby or there is something wrong with your remote control, contact the dealer where you purchased the projector or the service center.

**PIN code lock**

This function prevents the projector from being operated by unauthorized persons and provides the following setting options for security.

- Off** ..... Unlocked.
- On1** ..... Enter the PIN code every time turning on the projector.
- On2** ..... Enter the PIN code to operate the projector once the power cord is disconnected; as long as the AC power cord is connected, the projector can be operated without a PIN code.

Whenever you change the PIN code lock setting or the PIN code (the four-digit number), you are required to enter the PIN code. The "1234" is set as the initial PIN code at the factory.

If you want to change the PIN code lock setting, Press the SELECT button and the PIN code dialog box appears.

**Key lock**

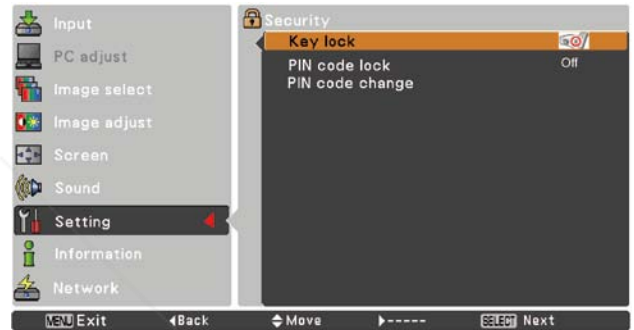
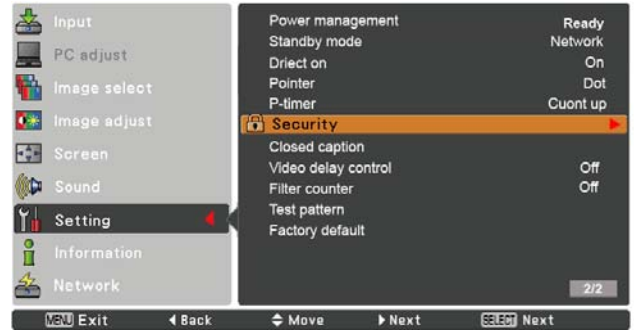

**PIN code lock**

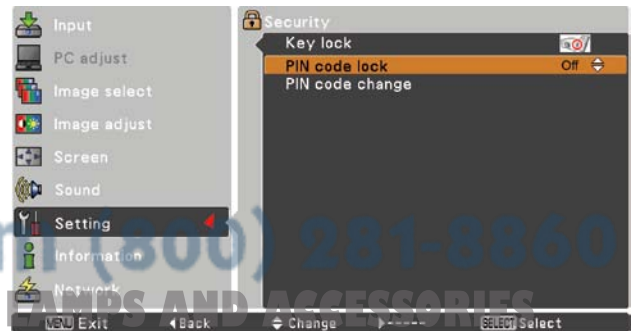

FixYourDLP.com

Discount-Merchant.com (800) 281-8860

THE TRUSTED SOURCE FOR PROJECTOR PARTS AND ACCESSORIES

## Enter a PIN code

Use the Point ▲▼ buttons to enter a number. Press the Point ► button to fix the number and move the red frame pointer to the next box. The number changes to \*. If you fixed an incorrect number, use the Point ◀ button to move the pointer to the number you want to correct, and then enter the correct number.

Repeat this step to complete entering a four-digit number.

After entering the four-digit number, move the pointer to **Set**. Press the SELECT button so that you can start to operate the projector.

If you entered an incorrect PIN code, **PIN code** and the number (\*\*\*\*) will turn red for a moment. Enter the correct PIN code all over again.

## Enter a PIN code

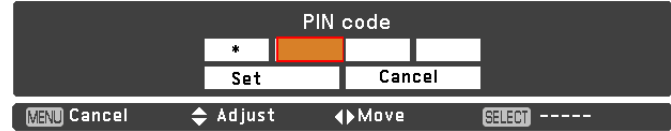

## Change the PIN code lock setting

Use the Point ▲▼ buttons to select **Off**, **On1** or **On2**. Press the SELECT button to close the dialog box.

### PIN code change

The PIN code can be changed to your desired four-digit number. Press the Point ▼ button to select **PIN code change** and press the SELECT button. The Current PIN code dialog box appears. Use the Point ▲▼ buttons to set the current PIN code. The New PIN code dialog box appears. Set a new PIN code, the confirmation box appears, and choose Yes to set the new PIN code.

## Change the PIN code



### CAUTION:

WHEN YOU HAVE CHANGED THE PIN CODE, WRITE DOWN THE NEW PIN CODE IN COLUMN OF THE PIN CODE NO. MEMO ON PAGE 86, AND KEEP IT SECURELY. IF YOU FORGET YOUR PIN CODE, THE PROJECTOR CAN NO LONGER BE STARTED.

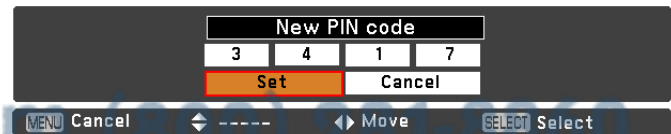
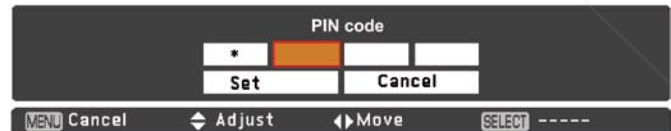

## Closed caption

Closed caption is a printed version of the program sound or other information displayed on the screen. If the input signal contains closed caption, you can turn on the feature and switch the channels. Press the Point ▲▼ buttons to select **Off**, **CC1**, **CC2**, **CC3** or **CC4**.

If the closed caption is not clear, you can change the text from **Color** to **White**.

### ✓ Note:

The Closed caption is available only under the situation below.

- When the input signal is NTSC of composite and S-video, and the system is set according to the signal or set on **Auto**.
- The system must be set on **NTSC** or **Auto** in Video System Selection. (P.39)
- The item of Closed caption is displayed in gray while it is not available.
- The Closed caption is unavailable when On-Screen menu and P-Timer are displayed.

## Video delay control

When you want to make a digital processing of a projected image faster, set this function.

Use the Point ▲▼ buttons to select **On** or **Off**.

### ✓ Note:

**Noise reduction** and **Progressive** can not be selected when **Video delay control** is set to **On**.

## Closed caption

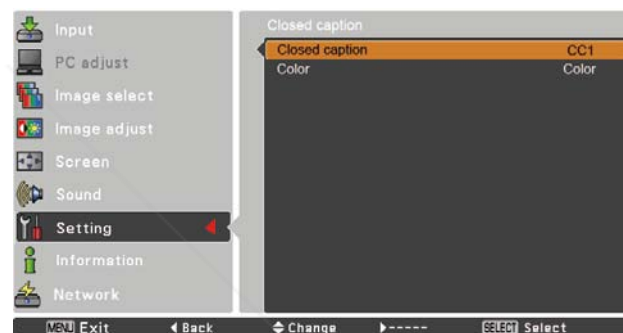
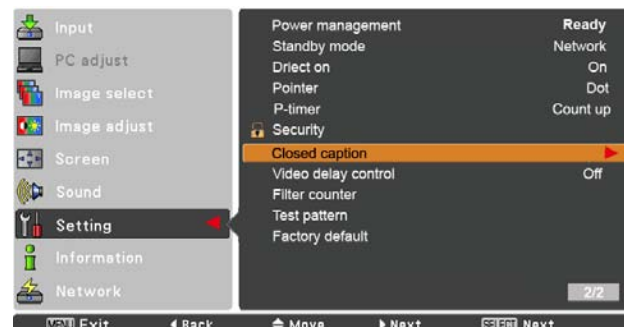

Press the Point ▲▼ buttons to select **Off**, **CC1**, **CC2**, **CC3** or **CC4**, and then Press SELECT button.



## Filter counter

This function is used to set a frequency for the filter cartridge replacement.

Use the Point ▲▼ buttons to select **Filter counter** and then press the Point ► or the SELECT button to access the submenu items.

**Filter counter**..... Show the total accumulated time of the filter cartridge.

**Timer** ..... To set a timer, when the projector reaches the time, the Filter warning icon (Fig. 1) appears on the screen and the total accumulated time turns red, indicating that the filter cartridge replacement is necessary.

**Filter counter reset**...When replacing the Filter cartridge, reset the Filter counter (p.67).

Fig.1 Filter warning icon



Filter warning icon appears on the screen at a set time.

## Test pattern

Various test pattern are available for use when setting up the projector.

## Factory default

This function returns all setting values except for **User logo**, **PIN code lock**, **Logo PIN code lock**, **Lamp counter**, and **Filter counter** to the factory default settings.

## Filter counter



Press the SELECT button to select **Timer** and then use the Point ▲▼ buttons to set the timer. Select from (**Off**/ **600H**/**900H**/**1200H**/**1500H**/**1800H**/**2000H**) depending on the use environment.

### ✓ Note:

- Fig. 1 appears at turning on and selecting input source.
- Fig. 1 will not appear when the Display function is set to **Off** (p.52), during "Freeze" (p.30) or No show (p 29).

# Maintenance and Care

## Filter Instructions

Filter prevents dust from accumulating on the optical elements inside the projector. Should the filter becomes clogged with dust particles, it will reduce cooling fans' effectiveness and may result in internal heat buildup and adversely affect the life of the projector.

If the projector reaches a time set in the timer setting (p.64), a Filter warning icon (Fig.1) appears on the screen and the WARNING FILTER indicator on the top panel lights up (p.80). When you see this icon, replace the filter cartridge as soon as possible (pp.30, 58). All the indicators except Lamp indicator blink fast when the projector detects an abnormal condition, or the filter cartridge is not installed properly (p.80).

**Fig.1** Filter warning icon



Filter warning icon appears on the screen at a set time.

✓ **Note:**

- *Fig.1 will not appear when the Display function is set to **Off** (p.52), or during "Freeze" (p.30) or "No show" (p.29).*
- *The filter cartridge is disposable. Do not clean and reuse the filter cartridge.*
- *Do not expose the filter cartridge to water or liquid, or it may cause a breakdown.*
- *Do not use the filter cartridge with other projector.*
- *Make sure that the projection lamp is turn off when you are replacing the filter cartridge. If you replace the filter cartridge when the projection lamp is turn on, the projector will be shut down automatically for safety purpose.*

## Replacing the Filter Cartridge

- 1 Turn off the projector, and unplug the AC power cord from the AC outlet.
- 2 First, clean up the dust on the projector and around the air vents.
- 3 Press ▼ downwards on the filter cover to release the latch and open the filter cover.
- 4 Pull out the filter cartridge. When taking out the filter cartridge, put your finger on the filter cartridge's tab and then pull.
- 5 Put the new one back into the position and close the filter cover. Make sure that the filter cartridge is properly and fully inserted.
- 6 Connect the AC power cord to the projector and turn on the projector.
- 7 Reset the filter counter (p.67).



### CAUTION

Make sure the filter cartridge is inserted in the projector. If the filter cartridge is not inserted, the projector cannot be turned on.

Do not put anything into the air vents. Doing so may result in malfunction of the projector.

### RECOMMENDATION

**We recommend avoiding dusty/smoky environments when operating the projector. Usage in these environments may cause a poor image quality.**

When using the projector under dusty or smoky conditions, dust may accumulate on a lens, liquid crystal panels, or optical elements inside the projector. Such condition may degrade the quality of the projected image.

When the symptoms above are noticed, contact your authorized dealer or service center for proper cleaning.

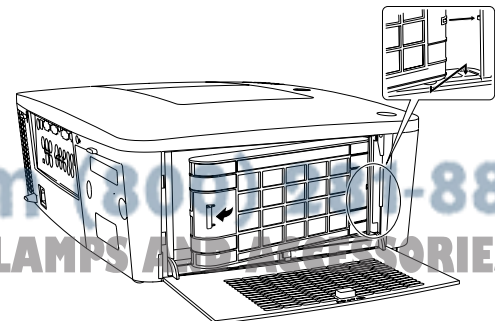
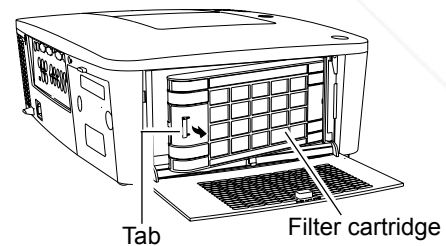
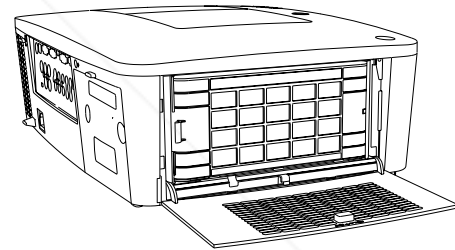
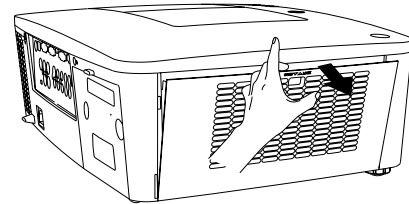
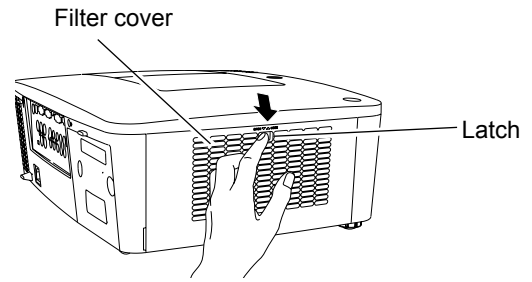

### ORDER REPLACEMENT FILTER CARTRIDGE

Replacement filter cartridge can be ordered through your dealer. When ordering, give the following information to the dealer.

- Model No. of your projector  
PLC-WM4500, PLC-WM4500L
- Replacement Filter Cartridge Type No.  
POA-FIL-081 (Service Parts No. 610 349 8317)

## Resetting the Filter Counter

Be sure to reset the Filter counter after cleaning or replacing the filter.

- 1 Press the MENU button to display the On-Screen Menu. Use the Point ▲▼ buttons to select **Setting** and then press the Point ► or the SELECT button.
- 2 Use the Point ▲▼ buttons to select **Filter counter** and then press the SELECT button. Use the Point ▲▼ buttons to select **Filter counter Reset** and then press the SELECT button. **Filter counter Reset?** appears. Select **Yes** to continue.
- 3 Another confirmation dialog box appears, select **Yes** to reset the Filter counter.

### Filter counter



**Filter counter Reset?** appears.

Select **Yes**, then another confirmation box appears.

Select **Yes** again to reset the Filter counter.

## Lamp Replacement

When the projection lamp of the projector reaches its end of life, the **Lamp replacement icon** appears on the screen and LAMP REPLACE indicator lights orange. Replace the lamp with a new one promptly. The timing when the LAMP REPLACE indicator should light is depending on the lamp mode.

### Top Panel

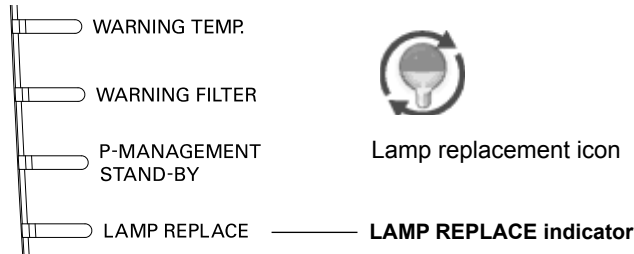

✓ **Note:**

The Lamp replacement icon will not appear when the Display function is set to **Off** (p.52), during "Freeze" (p.30) or "No show" (p.29).

Follow these steps to replace the lamp.

- 1 Turn off the projector and unplug the AC power cord. Let the projector cool for at least 45 minutes.
- 2 Loosen the screw and open the lamp cover. Loosen 3 screws of the lamp and pull out the lamp by using the built in handle.
- 3 Replace the lamp with a new one. Make sure that the lamp is properly and fully inserted.
- 4 Close the lamp cover and secure the screw.
- 5 Connect the AC power cord to the projector and turn on the projector.

✓ **Note:**

Be sure to insert the lamp in the correct direction.

## ⚠ CAUTION

When replacing the lamp because it has stopped illuminating, there is a possibility that the lamp may be broken.

If replacing the lamp of a projector which has been installed on the ceiling, you should always assume that the lamp is broken, and you should stand to the side of the lamp cover, not underneath it. Remove the lamp cover gently. Small pieces of glass may fall out when the lamp cover is opened.

If pieces of glass get into your eyes or mouth, seek medical advice immediately.

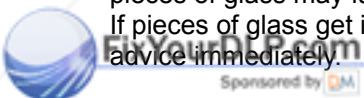
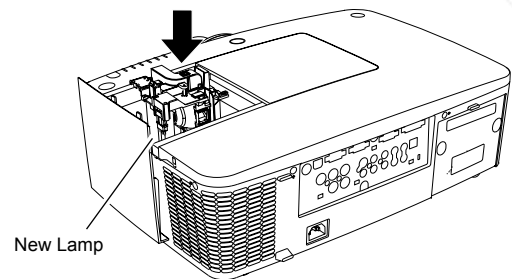
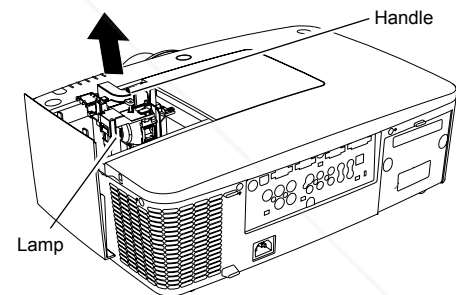
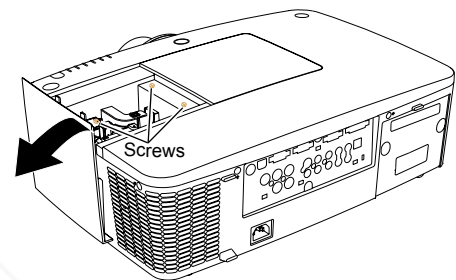
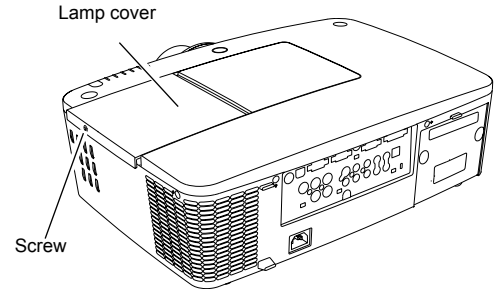

Discount-Merchant.com (800) 281-8860

⚠ CAUTION THE BEST SOURCE FOR PROJECTOR CAUTION ACCESSORIES

Allow a projector to cool for at least 45 minutes before you open the lamp cover. The inside of the projector can become very hot.

For continued safety, replace with a lamp of the same type. Do not drop the lamp or touch the glass bulb! The glass can shatter and may cause injury.



## LAMP HANDLING PRECAUTIONS

This projector uses a high-pressure lamp which must be handled carefully and properly. Improper handling may result in accidents, injury, or create a fire hazard.

- Lamp lifetime may differ from lamp to lamp and according to the environment of use. There is no guarantee of the same lifetime for each lamp. Some lamps may fail or terminate their lifetime in a shorter period of time than other similar lamps.
- If the projector indicates that the lamp should be replaced, i.e., if the LAMP REPLACE indicator lights up, replace the lamp with a new one IMMEDIATELY after the projector has cooled down. (Follow carefully the instructions in the Lamp Replacement section of this manual.) Continuous use of the lamp with the LAMP REPLACE indicator lighted may increase the risk of lamp explosion.
- Lamp may explode as a result of vibration, shock or degradation as a result of hours of use as its lifetime draws to an end. Risk of explosion may differ according to the environment or conditions in which the projector and lamp are being used.

### IF A LAMP EXPLODES, THE FOLLOWING SAFETY PRECAUTIONS SHOULD BE TAKEN.

If a lamp explodes, disconnect the projector's AC plug from the AC outlet immediately. Contact an authorized service center for a checkup of the unit and replacement of the lamp. Additionally, check carefully to ensure that there are no broken shards or pieces of glass around the projector or coming out from the cooling air circulation holes. Any broken shards found should be cleaned up carefully. No one should check the inside of the projector except those who are authorized trained technicians and who are familiar with projector service. Inappropriate attempts to service the unit by anyone, especially those who are not appropriately trained to do so, may result in an accident or injury caused by pieces of broken glass.

### **ORDER REPLACEMENT LAMP**

Replacement lamp can be ordered through your dealer. When ordering, give the following information to the dealer.

- **Model No. of your projector** : **PLC-WM4500, PLC-WM4500L**
- **Replacement Lamp Type No.** : **POA-LMP137**

(Service Parts No. 610 347 5158)



**Discount-Merchant.com (800) 281-8860**  
**THE TRUSTED SOURCE FOR PROJECTOR LAMPS AND ACCESSORIES**

### Cleaning the Projection Lens

Unplug the AC power cord before cleaning.

Gently wipe the projection lens with a cleaning cloth that contains a small amount of non-abrasive camera lens cleaner, or use a lens cleaning paper or commercially available air blower to clean the lens.

Avoid using an excessive amount of cleaner. Abrasive cleaners, solvents, or other harsh chemicals might scratch the surface of the lens.

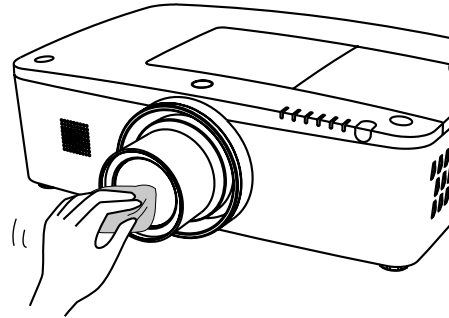

### Cleaning the Projector Cabinet

Unplug the AC power cord before cleaning.

Gently wipe the projector body with a soft dry cleaning cloth. When the cabinet is heavily soiled, use a small amount of mild detergent and finish with a soft dry cleaning cloth. Avoid using an excessive amount of cleaner. Abrasive cleaners, solvents, or other harsh chemicals might scratch the surface of the cabinet.

When the projector is not in use, put the projector in an appropriate carrying case to protect from dust and scratches.

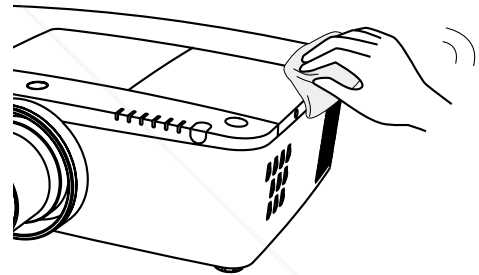

### CAUTION

Do not use any flammable solvents or air sprays on the projector and in its vicinity. The explosion or fire hazard may occur even after the AC power cord is unplugged because the temperature inside the projector is extremely high due to the lamps. In addition, there is a risk that the internal parts may be damaged not only by the flammable air spray but also by the cold air.

## Warning Indicators

The WARNING indicators show the state of the function which protects the projector. Check the state of the WARNING indicators and the POWER indicator to take proper maintenance.

### **The projector is shut down and the WARNING TEMP. indicator is blinking red.**

When the temperature inside the projector reaches a certain level, the projector will be automatically shut down to protect the inside of the projector. The POWER indicator is blinking while the projector is being cooled down. When the projector has cooled down enough (to its normal operating temperature), it can be turned on again by pressing the ON/STAND-BY button.

✓ **Note:**

*The WARNING TEMP. indicator continues to blink even after the temperature inside the projector returns to normal. When the projector is turned on again, the WARNING TEMP. indicator stops blinking.*

Top Panel

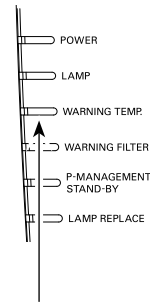

**WARNING TEMP. blinking red**

**Then check the matters below:**

- Did you provide appropriate space for the projector to be ventilated? Check the installing condition to see if the air vents of the projector are not blocked.
- Has the projector been installed near an Air-Conditioning/ Heating Duct or Vent? Move the installation of the projector away from the duct or vent.
- Is the filter clean? Replace the filter with a new one.

### **The projector is shut down and the LAMP indicator is lighting and other indicators are blinking.**

When the projector detects an abnormal condition, it will be automatically shut down to protect the inside of the projector and the LAMP indicator lights on and other indicators blink. In this case, unplug the AC power cord and plug it, and then turn on the projector once again to verify operation. If the projector cannot be turned on and these indicators are still lighting and blinking, unplug the AC power cord and contact the service center.

Top Panel

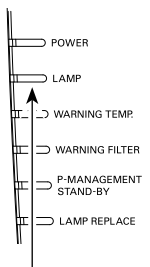

**LAMP indicator lights on and other indicators blink.**



**CAUTION**

DO NOT LEAVE THE PROJECTOR WITH THE AC POWER CORD CONNECTED UNDER AN ABNORMAL CONDITION. IT MAY RESULT IN FIRE OR ELECTRIC SHOCK.



# Appendix

## Troubleshooting

Before calling your dealer or service center for assistance, check the items below once again.

1. Make sure you have properly connected the projector to peripheral equipment as described on pages 19-21.
2. Check the cable connection. Make sure that all computers, video equipment, and power cords are properly connected.
3. Make sure that all power is switched on.
4. If the projector still does not produce an image, restart your computer.
5. If an image still does not appear, disconnect the projector from your computer and check your computer monitor's display. A problem may be noticed with your graphics controller rather than with the projector. (When you reconnect the projector, be sure to turn the computer and monitor off before you turn on the projector. Turn on equipment in the order of the projector and computer.)
6. If a problem still persists, check the following solutions.

Problem:	Solutions
<b>No power.</b>	<ul style="list-style-type: none"> <li>– Plug the power cord of the projector into the AC outlet.</li> <li>– Wait until the POWER indicator stops blinking to turn on the projector again. (See page 23)</li> <li>– Check the WARNING TEMP. indicator. If the WARNING TEMP. indicator is blinking, the projector cannot be turned on. (See page 71.)</li> <li>– Unlock the Key lock function for the projector. (See page 61)</li> <li>– See if the filter cartridge is inserted. (See page 66)</li> <li>– Check the projection lamp. (See page 68)</li> </ul>
<b>PIN code dialog box appears at start-up.</b>	<ul style="list-style-type: none"> <li>– PIN code lock is being set. Enter a PIN code; the “1234” or numbers you have set (See pages 23, 61-62)</li> </ul>
<b>The initial display is not shown.</b>	<ul style="list-style-type: none"> <li>– Make sure <b>Off</b> or <b>Countdown Off</b> is not chosen at Display function. (See “Setting” section on page 52)</li> </ul>
<b>The initial display is not same with the default one.</b>	<ul style="list-style-type: none"> <li>– Make sure <b>User</b> or <b>Off</b> is not chosen at Logo select function. (See “Setting” section on page 52)</li> </ul>
<b>When the projector is on and you press the input button, an icon other than the Lamp mode icon appears.</b>	<ul style="list-style-type: none"> <li>– That is the Filter warning icon. (See pages 64-65)</li> </ul>
<b>An icon other than Input mode or Lamp mode icon appears.</b>	<ul style="list-style-type: none"> <li>– That is the Lamp replacement icon or the Filter warning icon. (See pages 57, 64-65, 68)</li> </ul>
<b>No image</b>	<ul style="list-style-type: none"> <li>– Check the connection between your computer or video equipment and the projector.</li> <li>– See if the input signal is correctly output from your computer. Some laptop computers may need to be changed the setting for monitor output when connected to the projector. See your computer's instruction manual for the setting.</li> <li>– It takes about 30 seconds to display an image after turning on the projector.</li> <li>– See if the selected system is corresponding with your computer or video equipment.</li> <li>– Select correct input source once again through menu operation. (See pages 33-35)</li> <li>– Make sure the temperature is not out of Operating Temperature (41°F–104°F [5°C–40°C]).</li> <li>– When No show is operating, the image cannot be displayed. Press the NO SHOW button or any other button on the remote control.</li> </ul>
 <b>appears on the screen</b>	<ul style="list-style-type: none"> <li>– End of lamp life is approaching. Replace the lamp with a new one promptly. (See page 68)</li> </ul>

<p><b>The image is out of focus.</b></p>	<ul style="list-style-type: none"> <li>– Adjust the focus of the projector.</li> <li>– Check Projection Lens to see if it needs cleaning.</li> <li>✓ <b>Note:</b> <i>Moving the projector from a cool temperature location to a warm temperature location may result in moisture condensation on Projection Lens. In such cases, leave the projector OFF and wait until condensation evaporates.</i></li> <li>– Projecting from excessive slant angle to the screen may cause keystone distortion and partial imperfect focus.</li> <li>– Make sure the projection screen is at least 4.5' (1.4 m) away from the projector.</li> </ul>
<p><b>The image is not bright enough.</b></p>	<ul style="list-style-type: none"> <li>– Check if <b>Contrast</b> or <b>Brightness</b> is adjusted properly. (See pages 41, 47)</li> <li>– Check if <b>Image level</b> is selected properly. (See pages 40, 46)</li> <li>– Check the Lamp control function. ( See “Setting” section on page 57)</li> <li>– Check the LAMP REPLACE indicator. If it lights, the end of lamp life is approaching. Replace the lamp with a new one promptly. (See page 68)</li> </ul>
<p><b>The color is strange.</b></p>	<ul style="list-style-type: none"> <li>– Check the Input signal, color system, video system, or computer system mode.</li> <li>– Adjust the Image Level properly. (See pages 40, 46)</li> </ul>
<p><b>The image is Left/Right reversed.</b></p>	<ul style="list-style-type: none"> <li>– Check the Ceiling / Rear function. (See pages 44, 50)</li> </ul>
<p><b>The image is Top/Bottom reversed.</b></p>	<ul style="list-style-type: none"> <li>– Check the Ceiling function. (See pages 44, 50)</li> </ul>
<p><b>The image is distorted or runs off.</b></p>	<ul style="list-style-type: none"> <li>– Check PC adjust Menu or Screen Menu and adjust them.</li> </ul>
<p><b>Auto PC adjustment function does not work.</b></p>	<ul style="list-style-type: none"> <li>– Check the Input signal. Auto PC Adjustment function cannot work when <b>480p, 575p, 720p, 480i, 575i, 1035i, 1080i</b> or <b>1080p</b> is selected or when the digital signal is input into HDMI terminal. (See page 37)</li> </ul>
<p><b>Some displays are not seen during the operation.</b></p>	<ul style="list-style-type: none"> <li>– Check the Display function. (see page 52)</li> </ul>
<p><b>The setting does not remain after turning off power.</b></p>	<ul style="list-style-type: none"> <li>– Make sure you selected <b>Store</b> after adjusting settings. Some settings cannot be stored if not registered with Store function.</li> </ul>
<p><b>Power management function does not work.</b></p>	<ul style="list-style-type: none"> <li>– Power management function cannot work while Freeze or No show function is running.</li> </ul>
<p><b>Image disappears automatically.</b></p>	<ul style="list-style-type: none"> <li>– Check the power management function in the Setting. The power management is set to <b>On</b> at the factory.</li> </ul>
<p><b>Capture function does not work.</b></p>	<ul style="list-style-type: none"> <li>– Check the connection to see if there is signal.</li> <li>– Capture function is not available when the Picture in Picture function is set to User1-5.</li> </ul>
<p><b>Some menus cannot be selected.</b></p>	<ul style="list-style-type: none"> <li>– Each of the Video Input and Computer Input has a limit on selectable menus.</li> </ul>
<p><b>No sound</b></p>	<ul style="list-style-type: none"> <li>– Check the audio cable connection from audio input source.</li> <li>– Adjust the audio source.</li> <li>– Press the Volume + button. ( See page 28)</li> <li>– Press the Mute button. (See page 28)</li> <li>– Is the image projected? You will hear the sound only when the image is projected.</li> <li>– Check the Build-in SP function. (See page 28)</li> </ul>

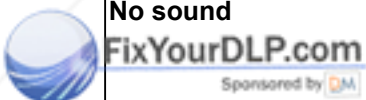

**Discount-Merchant.com (800) 281-8860**  
**THE TRUSTED SOURCE FOR PROJECTOR LAMPS AND ACCESSORIES**

<p><b>The power is turned off automatically.</b></p>	<ul style="list-style-type: none"> <li>– Power management function runs by initial setting. Check “Setting” section on page 59.</li> <li>– Do not cover the ventilation slots on the projector. (See pages 4, 6)</li> <li>– Projector may be used in high ambient temperature environment. Make sure the temperature is not out of Operating Temperature (41°F–104°F [5°C–40°C]). (See page 71)</li> </ul>
<p><b>You cannot operate with the side control.</b></p>	<ul style="list-style-type: none"> <li>– If the side control is locked at "Key lock" under "Security" of Setting menu, the side control is not available. Please check “Setting” section on page 61.</li> </ul>
<p><b>The Remote Control does not work.</b></p>	<ul style="list-style-type: none"> <li>– Check the batteries.</li> <li>– Check if the RC sensor is set properly. (See page 59)</li> <li>– Make sure no obstruction is between the projector and remote control.</li> <li>– Make sure you are not too far from the projector when using the remote control. Maximum operating range is 16.4' (5m). (See page 15)</li> <li>– Make sure that the remote control code conforms to the projector's code. (See “SETTING” section on page 58.)</li> <li>– Unlock the Key lock function for the remote control. (See page 61)</li> <li>– Wireless remote control does not work when the remote control cable is connected to the projector. (See page 15)</li> <li>– Check if the ALL-OFF switch on the remote control is set to “ON.”</li> <li>– Make sure that the simple mode in the remote control function is set to <b>Off</b> (See page 58).</li> </ul>
<p><b>Wireless mouse function does not work.</b></p>	<ul style="list-style-type: none"> <li>– Check the cable connection between the projector and your computer. (See pages 19, 32)</li> <li>– Check the mouse setting on your computer.</li> <li>– Turn on the projector before you turn on the computer.</li> </ul>
<p><b>Indicators blink or light.</b></p>	<ul style="list-style-type: none"> <li>– Check the status of the projector with referring to “Indicators and projector condition” on pages 78-80.</li> </ul>
<p> appears on the screen</p>	<ul style="list-style-type: none"> <li>– Your operation is invalid. Operate correctly.</li> </ul>
<p><b>Unable to unlock the Logo PIN code lock, Security key lock or Security PIN code lock.</b></p>	<ul style="list-style-type: none"> <li>– Contact the dealer where you purchased the projector or the service center.</li> </ul>
<p><b>Forget the Logo PIN code or Security PIN code.</b></p>	<ul style="list-style-type: none"> <li>– Contact the dealer where you purchased the projector or the service center.</li> </ul>

**WARNING:**  
High voltages are used to operate this projector. Do not attempt to open the cabinet.

If problems still persist after following all operating instructions, contact the dealer where you purchased the projector or the service center. Specify the model number and explain about the problem. We will advise you how to obtain service.

## Menu Tree

### Computer Input/ HDMI Input/Video Input

#### Input

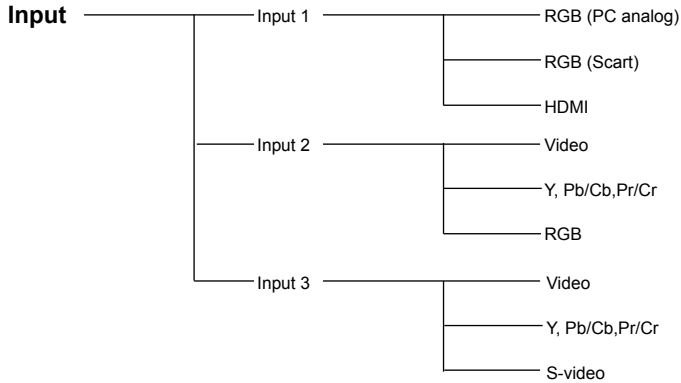

#### Sound

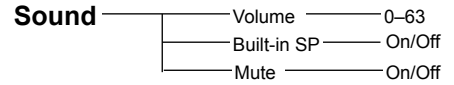

#### Information

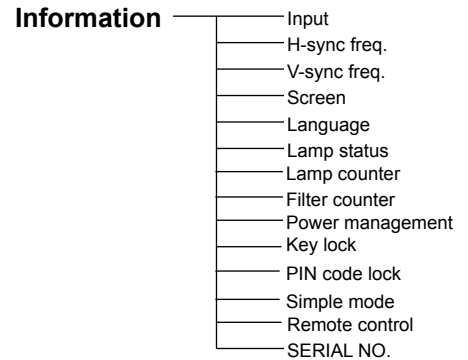

### Computer Input

#### SVGA1

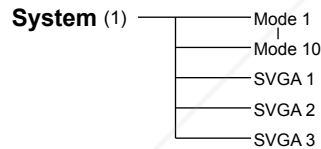

\* System displayed in the System Menu varies depending on the input signal.

#### Image select

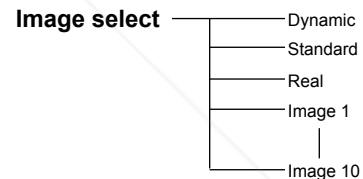

#### Image adjust

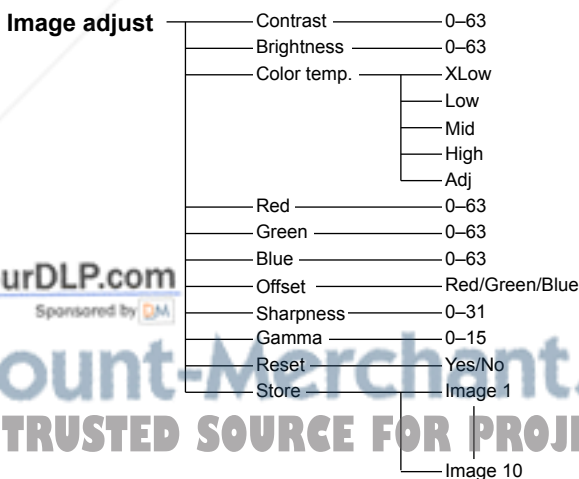

#### PC adjust

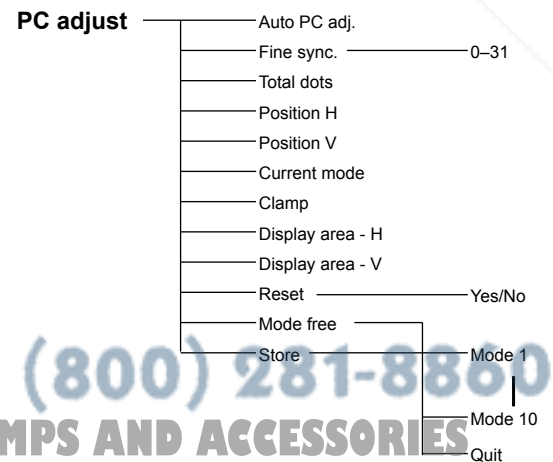

✓ **Note:**

The Menu display varies depending on the input signal.



Discount-Merchant.com (800) 281-8860

THE TRUSTED SOURCE FOR PROJECTOR LAMPS AND ACCESSORIES

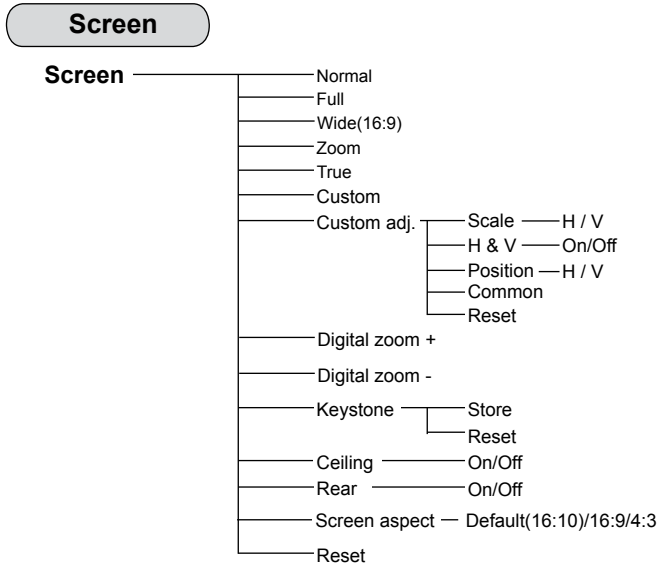

**HDMI Input/Video Input**

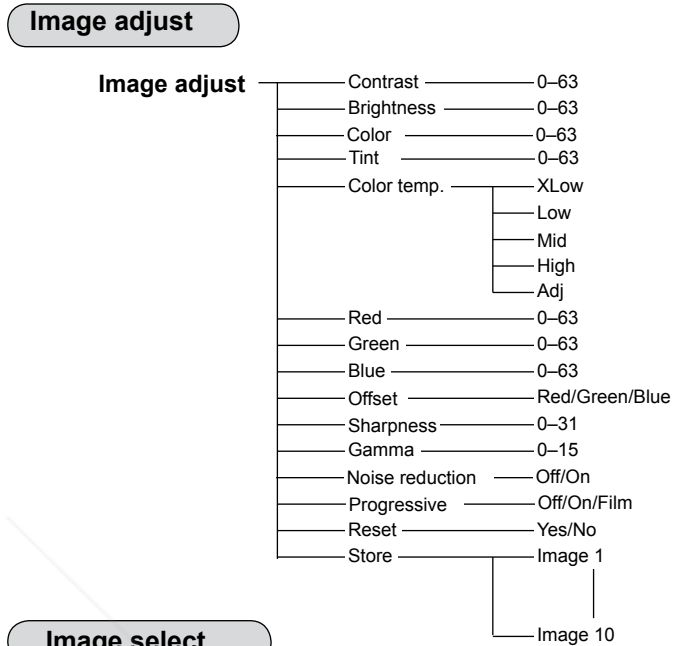

**Video Input**

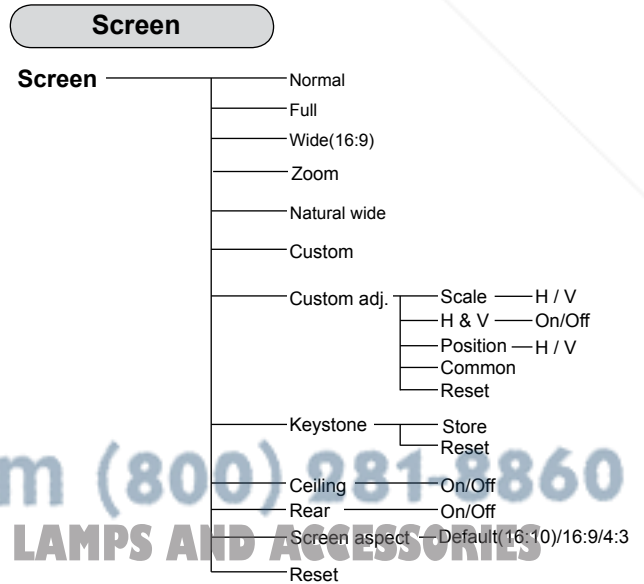
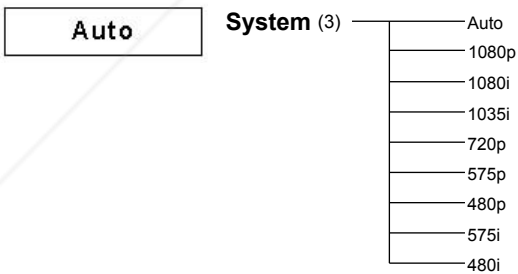
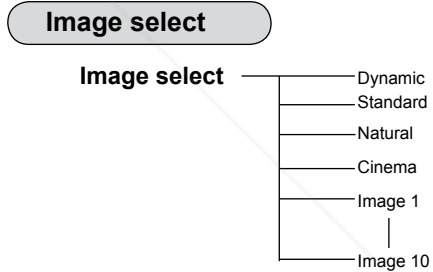
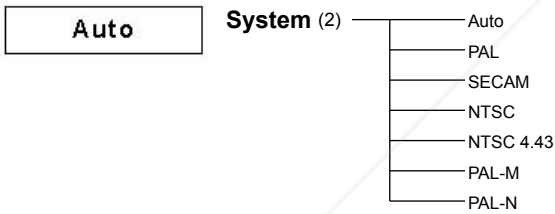

Discount-Merchant.com (800) 981-8860  
 THE TRUSTED SOURCE FOR PROJECTOR LAMPS AND ACCESSORIES

✓ **Note:**  
 The Menu display varies depending on the input signal.

**Computer Input/ HDMI Input/ Video Input**

**Setting**

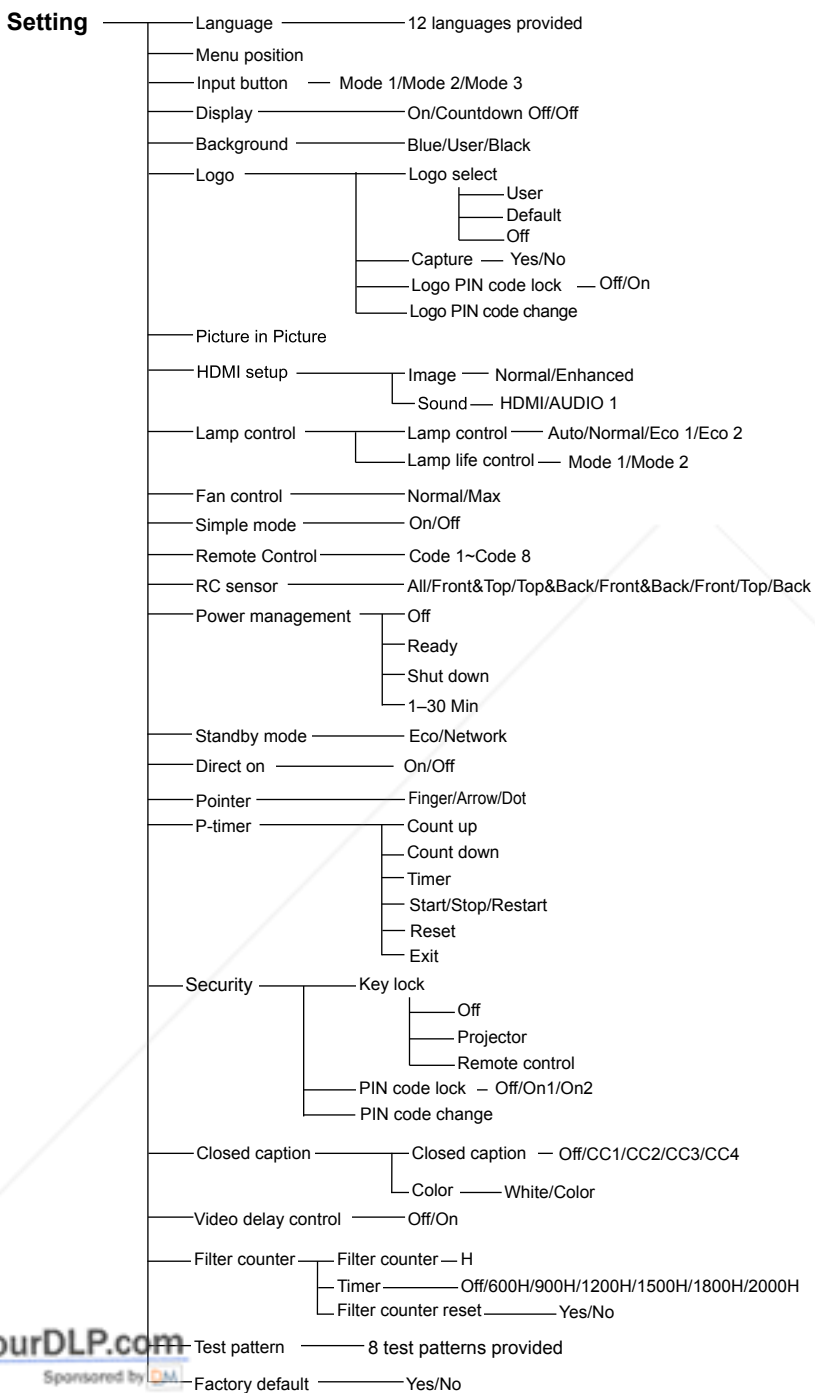

**Discount-Merchant.com (800) 281-8860**  
**THE TRUSTED SOURCE FOR PROJECTOR LAMPS AND ACCESSORIES**

## Indicators and Projector Condition

Check the indicators for the projector condition.

**The projector is operating normally.**

Indicators						Projector Condition
POWER green	LAMP red	WARNING TEMP. red	WARNING FILTER orange	P-MANAGEMENT STAND-BY blue	LAMP REPLACE orange	
●	●	●	●	●	●	The projector is off. (The AC power cord is unplugged.)
○	⊗	●	*	●	*	The projector is in stand-by mode. Press the ON/STAND-BY button to turn on the projector.
○	⊗	●	*	●	*	The projector is operating normally.
●	⊗	●	*	●	*	The projector is preparing for stand-by or the projection lamp is being cooled down. The projector cannot be turned on until cooling is completed and the POWER indicator lights green.
●	⊗	●	*	●	*	The projection lamp is being cooled down in the Power management mode.
●	⊗	●	*	⊗	*	The projector is in the Power management mode. Press the ON/STAND-BY button to turn on the projector.



⊗ ... on (red)

⊗ ... on (blue)

● ... dim

⊗ ... dim (red)

○ ... blinking at the normal rate (approx. 1 second ON, 1 second OFF)

⊗ ... blinking at the normal rate (blue and dim red) (approx. 1 second ON, 1 second OFF)

● ... off

\* ... Differ according to conditions.

⊗ ... blinking fast (approx. 0.5 seconds ON, 0.5 seconds OFF)

⊗ ... blinking fast (blue and dim red) (approx. 0.5 seconds ON, 0.5 seconds OFF)

⊗ ... blinking slow (approx. 2 seconds ON, 2 seconds OFF)

The projector is detecting abnormal condition.

Indicators						Projector Condition
POWER green	LAMP red	WARNING TEMP. red	WARNING FILTER orange	P-MANAGEMENT STAND-BY blue	LAMP REPLACE orange	
○	⊕	☀	*	●	*	The temperature inside the projector is elevated close to the abnormally high level.
●	⊕	☀	*	●	*	The temperature inside the projector is abnormally high. The projector cannot be turned on. When the projector is cooled down enough and the temperature returns to normal, the POWER indicator lights green and the projector can be turned on. (The WARNING TEMP. indicator keeps blinking.) Check and replace the filter.
○	⊕	☀	*	●	*	The projector has been cooled down enough and the temperature returns to normal. When turning on the projector, the WARNING TEMP. indicator stops blinking. Check and replace the filter.
●	⊕	●	*	●	☀	The lamp cannot light up. (The projector is preparing for stand-by or the projection lamp is being cooled down. The projector cannot be turned on until cooling is completed.)
○	⊕	●	*	●	☀	The lamp cannot light up. (The lamp has been cooled down enough and the projector is in stand-by mode and ready to be turned on with the ON/STAND-BY button.)
*	*	*	*	●	○	The lamp has been used overtime. Replace the lamp immediately.

**WARNING FILTER**

When the filter detects clogging, reaches a time set in the timer setting, the WARNING FILTER indicator lights orange. When this indicator lights orange, replace the filter cartridge with a new one promptly. Reset the Filter counter after replacing the filter cartridge (p.67).

**LAMP REPLACE**

When the projection lamp reaches its end of life, the LAMP REPLACE indicator lights orange. When this indicator lights orange, replace the projection lamp with a new one promptly. (p.68)

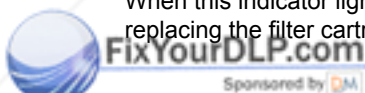

Sponsored by DM

Discount Merchant.com (800) 281-8860  
 THE TRUSTED SOURCE FOR PROJECTOR LAMPS AND ACCESSORIES



The projector is detecting abnormal condition.

Indicators						Projector Condition
POWER green	LAMP red	WARNING TEMP. red	WARNING FILTER orange	P-MANAGEMENT STAND-BY blue	LAMP REPLACE orange	
○	✱	●	○	●	✱	<p>If the Filter counter reached a time set in the timer setting, a Filter warning icon (Fig.1) appears on the screen and the WARNING FILTER indicator on the top panel lights up. Replace the filter cartridge as soon as possible.</p> <p>✓ <b>Note:</b>  <i>Fig.1 will not appear when the Display function is set to <b>Off</b> (p.52), during "Freeze" (p.30), or No show (p.29).</i></p>
 <p><b>Fig.1</b> Filter warning icon</p>						
⚡	⊕	⚡	⚡	⚡	⚡	<p>The filter cartridge is not installed in the projector. Check the filter compartment to see if the filter cartridge is installed in the projector. When the filter cartridge is installed and the indicators continue to light and blink, read the column below.</p> <p>The projector detects an abnormal condition and cannot be turned on. Unplug the AC power cord and plug it again to turn on the projector. If the projector is turned off again, unplug the AC power cord and contact the dealer or the service center. Do not leave the projector on. It may cause an electric shock or a fire hazard.</p>

## Compatible Computer Specifications

Basically this projector can accept the signal from all computers with the V- and H-Frequency mentioned below and less than 140 MHz of Dot Clock. When the input signal is Analog, refer to the chart below.

ON-SCREEN DISPLAY	RESOLUTION	H-Freq. (kHz)	V-Freq.(Hz)	ON-SCREEN DISPLAY	RESOLUTION	H-Freq. (kHz)	V-Freq.(Hz)
VGA 1	640x480	31.470	59.880	SXGA 13	1280x1024 (Interface)	50.000	86.000
VGA 2	720x400	31.470	70.090	SXGA 14	1280x1024 (Interface)	50.000	94.000
VGA 3	640x400	31.470	70.090	SXGA 15	1280x1024	63.370	60.010
VGA 4	640x480	37.860	74.380	SXGA 16	1280x1024	76.970	72.000
VGA 5	640x480	37.860	72.810	SXGA 17	1152x900	61.850	66.000
VGA 6	640x480	37.500	75.000	SXGA 18	1280x1024 (Interface)	46.430	86.700
VGA 7	640x480	43.269	85.000	SXGA 19	1280x1024	63.790	60.180
MAC LC13	640x480	34.970	66.600	SXGA 20	1280x1024	91.146	85.024
MAC 13	640x480	35.000	66.670	SXGA+ 1	1400x1050	63.970	60.190
480p	640x480	31.470	59.880	SXGA+ 2	1400x1050	65.350	60.120
575p	768x575	31.250	50.000	SXGA+ 3	1400x1050	65.120	59.900
575i	768x576 (Interface)	15.625	50.000	SXGA+ 4	1400x1050	64.030	60.010
480i	640x480 (Interface)	15.734	60.000	SXGA+ 5	1400x1050	62.500	58.600
SVGA 1	800x600	35.156	56.250	SXGA+ 6	1400x1050	64.744	59.948
SVGA 2	800x600	37.880	60.320	SXGA+ 7	1400x1050	65.317	59.978
SVGA 3	800x600	46.875	75.000	MAC 21	1152x870	68.680	75.060
SVGA 4	800x600	53.674	85.060	MAC	1280x960	75.000	75.080
SVGA 5	800x600	48.080	72.190	MAC	1280x1024	80.000	75.080
SVGA 6	800x600	37.900	61.030	WXGA 1	1366x768	48.360	60.000
SVGA 7	800x600	34.500	55.380	WXGA 2	1360x768	47.700	60.000
SVGA 8	800x600	38.000	60.510	WXGA 3	1376x768	48.360	60.000
SVGA 9	800x600	38.600	60.310	WXGA 4	1360x768	56.160	72.000
SVGA 10	800x600	32.700	51.090	WXGA 6	1280x768	47.776	59.870
SVGA 11	800x600	38.000	60.510	WXGA 7	1280x768	60.289	74.893
MAC 16	832x624	49.720	74.550	WXGA 8	1280x768	68.633	84.837
XGA 1	1024x768	48.360	60.000	WXGA 9	1280x800	49.600	60.050
XGA 2	1024x768	68.677	84.997	WXGA 10	1280x800	41.200	50.000
XGA 3	1024x768	60.023	75.030	WXGA 11	1280x800	49.702	59.810
XGA 4	1024x768	56.476	70.070	WXGA 12	1280x800	63.980	60.020
XGA 5	1024x768	60.310	74.920	WUXGA 1	1920x1200	74.556	59.885
XGA 6	1024x768	48.500	60.020	WUXGA 2	1920x1200	74.038	59.950
XGA 7	1024x768	44.000	54.580	WSXGA +1	1680x1050	65.290	59.954
XGA 8	1024x768	63.480	79.350	WXGA +1	1440x900	55.935	59.887
XGA 9	1024x768 (Interface)	36.000	87.170	WXGA +2	1440x900	74.918	60.000
XGA 10	1024x768	62.040	77.070	UXGA 1	1600x1200	75.000	60.000
XGA 11	1024x768	61.000	75.700	UXGA 2	1600x1200	81.250	65.000
XGA 12	1024x768 (Interface)	35.522	86.960	UXGA 3	1600x1200	87.500	70.000
XGA 13	1024x768	46.900	58.200	UXGA 4	1600x1200	93.750	75.000
XGA 14	1024x768	47.000	58.300	UXGA 5	1600x1200	106.250	85.000
XGA 15	1024x768	58.030	72.000	720p	1280x720	45.000	60.000
MAC 19	1024x768	60.240	75.080	720p	1280x720	37.500	50.000
SXGA 1	1152x864	64.200	70.400	1035i	1920x1035 (Interface)	33.750	60.000
SXGA 2	1280x1024	62.500	58.600	1080i	1920x1080 (Interface)	33.750	60.000
SXGA 3	1280x1024	63.900	60.000		1920x1080 (Interface)	28.125	50.000
SXGA 4	1280x1024	63.340	59.980		1920x1080	33.750	30.000
SXGA 5	1280x1024	63.740	60.010		1920x1080	28.125	25.000
SXGA 6	1280x1024	71.690	67.190		1920x1080	27.000	24.000
SXGA 7	1280x1024	81.130	76.107		1920x1080	67.500	60.000
SXGA 8	1280x1024	63.980	60.020		1920x1080	56.250	50.000
SXGA 9	1280x1024	79.976	75.025	1080psf/30	1920x1080	33.750	60.000
SXGA 10	1280x960	60.000	60.000	1080psf/25	1920x1080	28.125	50.000
SXGA 11	1152x900	61.200	65.200	1080psf/24	1920x1080	27.000	48.000
SXGA 12	1152x900	71.400	75.600				

✓ **Note:**

\* **True cannot be selected when \* is selected. (p.42)**

# Appendix

When an input signal is digital from the HDMI terminal, refer to the chart below.

ON-SCREEN DISPLAY	RESOLUTION	H-Freq. (kHz)	V-Freq.(Hz)	ON-SCREEN DISPLAY	RESOLUTION	H-Freq. (kHz)	V-Freq.(Hz)
D-VGA	640x480	31.470	59.940	D-720p	1280x720	45.000	60.000
D-480p	720x480	31.470	59.880	D-720p	1280x720	37.500	50.000
D-575p	720x575	31.250	50.000	D-1035i	1920x1035 (Interlace)	33.750	60.000
D-SVGA	800x600	37.879	60.320	D-1080i	1920x1080 (Interlace)	33.750	60.000
D-XGA	1024x768	43.363	60.000		1920x1080 (Interlace)	28.125	50.000
D-WXGA 1	1366x768	48.360	60.000	D-1080psf/30	1920x1080	33.750	60.000
D-WXGA 2	1360x768	47.700	60.000	D-1080psf/25	1920x1080	28.125	50.000
D-WXGA 3	1376x768	48.360	60.000	D-1080psf/24	1920x1080	27.000	48.000
D-WXGA 4	1360x768	56.160	72.000	D-1080p	1920x1080	33.750	30.000
D-WXGA 5	1366x768	46.500	50.000		1920x1080	28.125	25.000
D-WXGA 6	1280x768	47.776	59.870		1920x1080	27.000	24.000
D-WXGA 7	1280x768	60.289	74.893		1920x1080	67.500	60.000
D-WXGA 8	1280x768	68.633	84.837		1920x1080	56.250	50.000
D-WXGA 9	1280x800	49.600	60.050	D-480i	720 x 480	----	59.94/60
D-WXGA 10	1280x800	41.200	50.000	D-575i	720 x575	----	50.00
D-WXGA 11	1280x800	49.702	59.810	D-480p	720 x 480	----	59.94/60
D-WXGA 12	1280x800	63.980	60.020	D-575p	720 x575	----	50.00
D-SXGA 1	1280x1024	63.980	60.020	D-720p	1280 x 720	----	59.94/60
D-SXGA 2	1280x1024	60.276	58.069	D-720p	1280 x 720	----	50.00
D-SXGA+ 1	1400x1050	63.970	60.190	D-1080i	1920 x 1080	----	59.94/60
D-SXGA+ 2	1400x1050	65.350	60.120	D-1080i	1920 x 1080	----	50.00
D-SXGA+ 3	1400x1050	65.120	59.900	D-1080p	1920 x 1080	----	59.94/60
D-SXGA+ 4	1400x1050	64.030	60.010	D-1080p	1920 x 1080	----	50.000
D-SXGA+ 5	1400x1050	62.500	58.600	D-1080p	1920 x 1080	----	24.000
D-SXGA+ 6	1400x1050	64.744	59.948				
D-SXGA+ 7	1400x1050	65.317	59.978				
D-UXGA	1600x1200	75.000	60.000				
D-WUXGA 2	1920 x 1200	74.038	59.950				
D-WSXGA+ 1	1680 x 1050	65.290	59.954				
D-WXGA+ 1	1440x900	55.935	59.887				

✓ **Note:**

- Depending on the condition of signals and the type and length of cables, these signals may not be properly viewed.
- Specifications are subject to change without notice.
- You might be able to project images even when signals other than above are inputted, however the functions of the projector could be limited.
- Depending on your PC settings, the digital signals of your PC may not be projected correctly. In such a case, confirm your PC settings.
- When you project a DVI signal, connect the cables, turn the projector on, then select the input. Finally, turn on your PC. Be sure to follow this procedure, otherwise an image may not be projected on the screen. If an image is not projected correctly, restart your PC.
- Do not disconnect the cable while the projector is running. If the cable has been disconnected and then reconnected, an image may not be correctly projected.



The CE Mark is a Directive conformity mark of the European Community (EC).



This symbol on the nameplate means the product is Listed by Underwriters Laboratories Inc. It is designed and manufactured to meet rigid U.L. safety standards against risk of fire, casualty, and electrical hazards.

Licensed under USP 5,717,422 USP 6,816,141



Pixelworks ICs used.

## Technical Specifications

### Mechanical Information

Projector Type	Multi-media Projector
Dimensions (W x H x D)	PLC-WM4500L : 19.25" x 6.46" x 14.61" (489.5 mm x 164.0 mm x 371.1 mm) PLC-WM4500 : 19.25" x 6.46" x 17.12" (489.5 mm x 164.0 mm x 434.8 mm)
Net Weight	PLC-WM4500L : 18.74 lbs (8.5kg) PLC-WM4500 : 20.50 lbs (9.3 kg)
Feet Adjustment	0° to 4°

### Panel Resolution

LCD Panel System	0.75" TFT Active Matrix type, 3 panels
Panel Resolution	1,280 x 800 dots
Number of Pixels	3,072,000 (1,280 x 800 x 3 panels)

### Signal Compatibility

Color System	PAL, SECAM, NTSC, NTSC4.43, PAL-M, and PAL-N
SD/HD TV Signal	480i, 480p, 575i, 575p, 720p, 1035i, 1080i and 1080p
Scanning Frequency	H-sync. 15 kHz–100 kHz, V-sync. 48 Hz–100 Hz

### Optical Information

Projection Image Size (Diagonal)	Adjustable from 40" to 400" (PLC-WM4500)
Throw Distance	4.5' (1.4m) - 80.1' (24.4m) (PLC-WM4500)
Projection Lens	F1.7–2.3 lens with f=26.9 mm–45.4 mm with motor zoom and focus (PLC-WM4500)
Projection Lamp	275 W lamp

### Interface

Input 1	Digital (HDMI) x 1, Analog (Mini D-sub 15 pin) x 1
Input 2	BNC Type x 5 (G or Video/Y, B or Pb-Cb, R or Pr-Cr, H/HV and V)
Input 3	RCA Type x 3 (Video/Y, Pb/Cb, Pr/Cr), Mini DIN 4 pin x 1 (S-video)
Analog Out	Analog RGB (Mini D-sub 15 pin) Terminal x 1
Audio Out	Audio (Mini Type stereo) x 1
Audio In 1/2	Audio (Mini Type stereo) x 1
Audio In 3	RCA Type x 2
R/C Jack	Mini jack (Wired Remote) x 1
Control Port	D-sub 9 pin x 1
USB Connector	USB Series B x 1
LAN Connection Terminal	RJ45

### Audio

Internal Audio Amp	7.0 W RMS
Built-in Speaker	1 speaker, ø1.46" (37mm)

### Power

Voltage and Power Consumption	AC 100–120 V (4.4A Max. Ampere), 50/60 Hz (The U.S.A and Canada) AC 100–240 V (4.4-1.8A Max. Ampere), 50/60 Hz for other countries
-------------------------------	---

### Operating Environment

Operating Temperature	41°F–104°F (5°C–40°C)
Storage Temperature	14°F–140°F (-10°C–60°C)

### Remote Control

Battery	AAA or LR03 Type x 2
Operating Range	16.4' (5 m/±30°)
Dimensions	1.8" (W) x 1.0" (H) x 5.7" (D) (45 mm x 25 mm x 145 mm)
Net Weight	3.5 oz (99 g) (including batteries)

### Accessories

Owner's Manual (CD-ROM)	Lens Cap (for PLC-WM4500)
Quick Reference Guide	Lens Mount Cover (for PLC-WM4500L)
AC Power Cord	Lens Antitheft screw *
Remote Control and Batteries	VGA Cable
PIN Code Label	

\* Contact the dealer where you purchased the projector or the service center about the Lens Antitheft Screw.

- The specifications are subject to change without notice.
- LCD panels are manufactured to the highest possible standards. Even though 99.99% of the pixels are effective, a tiny fraction of the pixels (0.01% or less) may be ineffective by the characteristics of the LCD panels.

## Optional Parts

The parts listed below are optionally available. When ordering those parts, specify the item name and Model No. to the sales dealer.

	Model No.
<b>Standard Zoom Lens</b>	: LNS-S20
<b>Long Zoom Lens</b>	: LNS-T20
<b>Ultra Long Zoom Lens</b>	: LNS-T21
<b>Short Zoom Lens</b>	: LNS-W20
<b>Short Fixed Lens</b>	: LNS-W21
<b>SCART-VGA Cable</b>	: POA-CA-SCART

## Lens Replacement

The lens of this projector can be replaced with other optional lens. This feature enables you to use the projector for wide variety of uses.

For installation and replacement of the lens, always contact the sales dealer. The projector lens must be installed or replaced by well-trained sales or service engineers. Do not attempt to install and replace the lens by yourself as it may cause injury.



Do not hold the lens when carrying or lifting the projector. It may cause serious damage to the projector.

### To the sales and service engineers:

For the lens replacement and lens installation, refer to the installation manual of the optional lens. Before replacing and installing the lens, make sure that you are using the lens with the correct Type No.

## PJ Link Notice

This projector is compliant with PJLink Standard Class 1 of JBMA (Japan Business Machine and Information System Industries Association). The projector supports all commands defined by PJLink Class 1 and is verified conformance with PJLink Standard Class 1.

Projector Input		PJLink Input	Parameter
Input 1	RGB (PC analog)	RGB 1	11
	RGB (Scart)	RGB 2	12
	HDMI	DIGITAL 3	33
Input 2	Video	VIDEO 1	21
	Y, Pb/Cb,Pr/Cr	VIDEO 2	22
	RGB	RGB 3	13
Input 3	Video	VIDEO 3	23
	Y, Pb/Cb,Pr/Cr	VIDEO 4	24
	S-video	VIDEO 5	25



PJLink is a registered trademark of JBMA and pending trademark in some countries. **Discount Merchant.com (800) 281-8860**

**THE TRUSTED SOURCE FOR PROJECTOR LAMPS AND ACCESSORIES**



## Configurations of Terminals

### ANALOG/ MONITOR OUT (Mini D-sub 15 pin)

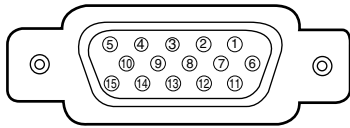

#### Input

1	Red Input	9	+5V Power
2	Green Input	10	Ground (Vert.sync.)
3	Blue Input	11	Ground
4	No Connect	12	DDC Data
5	Ground (Horiz.sync.)	13	Horiz. sync. Input (Composite H/V sync.)
6	Ground (Red)	14	Vert. sync. Input
7	Ground (Green)	15	DDC Clock
8	Ground (Blue)		

#### Output

1	Red Output	9	No Connect
2	Green Output	10	Ground (Vert.sync.)
3	Blue Output	11	No Connect
4	No Connect	12	No Connect
5	Ground (Horiz.sync.)	13	Horiz. sync. Output
6	Ground (Red)	14	Vert. sync. Output
7	Ground (Green)	15	No Connect
8	Ground (Blue)		

### HDMI (19 Pin Type A)

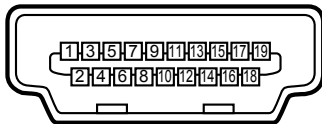

1	TMDS Data 2+ Input	11	Ground (TMDS Clock)
2	Ground (TMDS Data 2)	12	TMDS Clock- Input
3	TMDS Data 2- Input	13	-----
4	TMDS Data 1+ Input	14	-----
5	Ground (TMDS Data 1)	15	SCL
6	TMDS Data 1- Input	16	SDA
7	TMDS Data 0+ Input	17	Ground (DDC/CEC)
8	Ground (TMDS Data 0)	18	+5V Power
9	TMDS Data 0- Input	19	Plug insert detection
10	TMDS Clock+ Input		

### USB CONNECTOR (Series B)

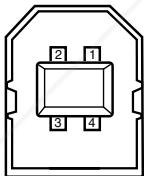

1	Vcc
2	- Data
3	+ Data
4	Ground

### LAN TERMINAL

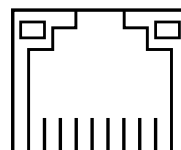

87654321

1	TX +	5	-----
2	TX -	6	RX -
3	RX +	7	-----
4	-----	8	-----

### CONTROL PORT CONNECTOR (D-sub 9 pin)

FixYourDLP.com

Sponsored by DM

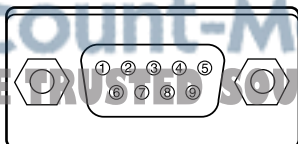

Serial	
1	-----
2	R X D
3	T X D
4	-----
5	SG
6	-----
7	RTS
8	CTS
9	-----

Discount-Merch.com (800) 281-8860  
THE TRUSTED SOURCE FOR PROJECTOR LAMPS AND ACCESSORIES

### PIN Code Number Memo

Write down the PIN code number in the column below and keep it with this manual securely. If you forgot or lost the number and unable to operate the projector, contact the service center.

**PIN Code Lock No.**

--	--	--	--

Factory default set No: 1 2 3 4\*

**Logo PIN Code Lock No.**

--	--	--	--

Factory default set No: 4 3 2 1\*

\* Should the four-digit number be changed, the factory set number will be invalid.

While the projector is locked with the PIN code...

Put the label below (supplied) on in a prominent place of the projector's body while it is locked with a PIN code.

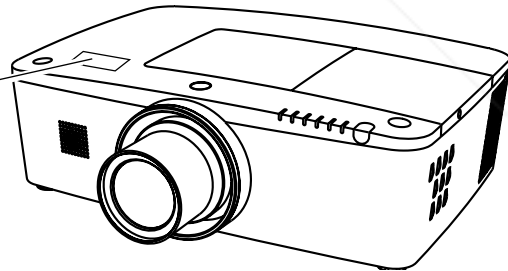

**Discount-Merchant.com (800) 281-8860**  
**THE TRUSTED SOURCE FOR PROJECTOR LAMPS AND ACCESSORIES**

Dimensions

Unit: inch (mm)  
 ↙ Screw Holes for Ceiling Mount  
 Screw: M6  
 Depth: 0.393 (10.0)

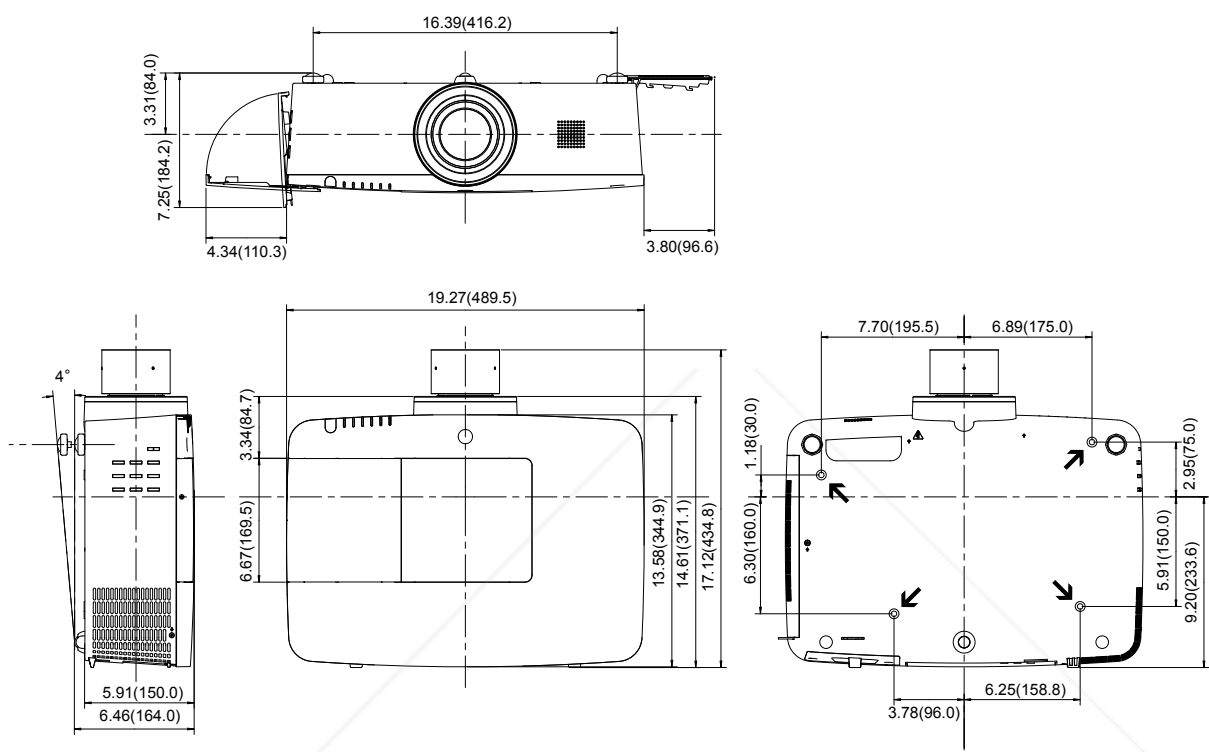

**Discount-Merchant.com (800) 281-8860**  
 THE TRUSTED SOURCE FOR PROJECTOR LAMPS AND ACCESSORIES



## List of Picture in Picture

Main Window	Sub Window	INPUT1			INPUT2			INPUT3		
		PC	SCART	HDMI	PC	YCbCr	VIDEO	YCbCr	VIDEO	S-VIDEO
INPUT1	PC	x	x	o	o	o	o	o	o	o
	SCART	x	x	o	o	o	x	o	x	x
	HDMI	o	o	x	o	o	o	o	o	o
INPUT2	PC	o	o	o	x	x	x	o	o	o
	YCbCr	o	o	o	x	x	x	o	o	o
	VIDEO	o	x	o	x	x	x	x	x	x
INPUT3	YCbCr	o	o	o	o	o	x	x	x	o
	VIDEO	o	x	o	o	o	x	x	x	x
	S-VIDEO	o	x	o	o	o	x	o	x	x

o : Picture in Picture combinations are enabled.  
 x : Picture in Picture combinations are disabled.

✓ **Note:**

- When the input signal(s) is/are incompatible, **X** mark will be displayed on the Main/Sub picture.
- Depending on the frequency or signal type of PC/AV input, the display resolution may be lowered or images may not be displayed on the Main/Sub picture.
  - <Display resolution is lowered when;>
    - Inputting PC analog signals: Between 100-140 MHz
  - <Images are not displayed and X mark appears when;>
    - Inputting PC analog signals: More than 140MHz
    - Inputting PC digital signals: More than 100MHz
    - Inputting AV digital signals: 1080p
  - <Picture in Picture is disabled when;>
    - Inputting signal formats: SXGA20, WUXGA 1, WUXGA 2, WSXGA+ 1, WXGA+2, UXGA 1, UXGA 2, UXGA 3, UXGA4, D-1080p

## Serial Control Interface

This projector provides a function to control and monitor the projector's operations by using the RS-232C serial port.

### Operation

- 1 Connect a RS-232C serial cross cable to CONTROL PORT on the projector and serial port on the PC. (See p.19)
- 2 Launch a communication software provided with PC and setup the communication condition as follows:

Baud rate	: 9600 / 19200 bps
Parity check	: none
Stop bit	: 1
Flow control	: none
Data bit	: 8

✓ **Note:**

*The default of the baud rate is set to **19200 bps**. If an error occurs in the communication, change the serial port and the communication speed (baud rate).*

- 3 Type the command for controlling the projector and then enter the "Enter" key.

**Example**

When you want to change the input to INPUT 2, Type 'C' '0' '6' 'Enter'.

✓ **Note:**

Enter with ASCII 64-byte capital characters and one-byte characters.



## Functional Execution Command

### Format

The command is sent from PC to the projector with the format below;

'C' [Command] 'CR'

Command: two characters (refer to the command table below.

-The projector decodes the command and returns the 'ACK' with the format below;

'ACK' 'CR'

-When the projector can not decode the command, it returns with format below.

'?' 'CR'

Command	Function
C00	Turn the projector ON
C01	Turn the projector OFF (immediately OFF)
C02	Turn the projector OFF
C05	Select Input 1
C06	Select Input 2
C07	Select Input 3
C09	Volume +
C0A	Volume -
C0B	Sound mute ON
C0C	Sound mute OFF
C0D	Video mute ON
C0E	Video mute OFF
C0F	Screen Normal Size
C10	Screen Full Size
C1C	Menu ON
C1D	Menu OFF
C20	Brightness UP
C21	Brightness DOWN
C23	Select Input 2 Video
C24	Select Input 2 Y, Pb/Cb,Pr/Cr
C25	Select Input 2 RGB
C28	Direct on ON
C29	Direct on OFF
C33	Select Input 3 Video
C34	Select Input 3 S-video
C35	Select Input 3 Y, Pb/Cb,Pr/Cr

Command	Function
C3A	Pointer RIGHT
C3B	Pointer LEFT
C3C	Pointer UP
C3D	Pointer DOWN
C3F	Enter
C46	Zoom DOWN
C47	Zoom UP
C4A	Focus DOWN
C4B	Focus UP
C4F	Select Input 1 HDMI
C50	Select Input 1 Analog RGB
C51	Select Input 1 SCART
C5D	Lens shift UP
C5E	Lens shift DOWN
C5F	Lens shift LEFT
C60	Lens shift RIGHT
C89	Auto PC adj.
C8E	Keystone UP
C8F	Keystone DOWN

## Status Read Command

### Format

The command is sent from PC to the projector with the format below;

'CR' [Command] 'CR'

Command: one character (refer to the command table below).

The projector decodes the command and returns the 'Character string' with the format below;

Command	Function	Projector Return	Projector status
CR0	Status Read	00	Power On
		80	Stand-by mode
		40	Countdown
		20	Cooling down
		10	Power Malfunction
		28	Cooling down at the temperature anomaly
		24	Cooling down at Power Management mode
		04	Power Management mode after Cooling down
		21	Cooling down after the projector is turned off when the lamps are out.
		81	Stand-by mode after Cooling down when the lamps are out.
88	Stand-by mode after Cooling down at the temperature anomaly.		
CR6	Temperature Read	S1 S2 S3	S1 = Temperature at Sensor 1 (°C) S2 = Temperature at Sensor 2 (°C) S3 = Temperature at Sensor 3 (°C) (ex.) S1 = 12.3°C, S2 = 23.4°C, S3 = 34.5°C --> The projector displays "12.3 23.4 34.5" (For each sensor, two digit and the tenth place numbers are displayed with a space between each temperature.)
		?	Communication failure



**Discount-Merchant.com (800) 281-8860**

**THE TRUSTED SOURCE FOR PROJECTOR LAMPS AND ACCESSORIES**

The tables on page 89 and 90 show the typical command lists for controlling the projector. Please consult your local dealer for further information of other commands.



**Discount-Merchant.com (800) 281-8860**  
**THE TRUSTED SOURCE FOR PROJECTOR LAMPS AND ACCESSORIES**



**SANYO Electric Co., Ltd.**



# Disclaimer

This user manual is provided as a free service by FixYourDLP.com. FixYourDLP is in no way responsible for the content of this manual, nor do we guarantee its accuracy. FixYourDLP does not make any claim of copyright and all copyrights remain the property of their respective owners.

About FixYourDLP.com

FixYourDLP.com (<http://www.fixyourdpl.com>) is the World's #1 resource for media product news, reviews, do-it-yourself guides, and manuals.

Informational Blog: <http://www.fixyourdpl.com>

Video Guides: <http://www.fixyourdpl.com/guides>

User Forums: <http://www.fixyourdpl.com/forum>

FixYourDLP's Fight Against Counterfeit Lamps:

<http://www.fixyourdpl.com/counterfeits>

## Sponsors:

RecycleYourLamp.org – Free lamp recycling services for used lamps:

<http://www.recycleyourlamp.org>

Lamp Research - The trusted 3rd party lamp research company:

<http://www.lampresearch.com>

Discount-Merchant.com – The worlds largest lamp distributor:

<http://www.discount-merchant.com>



**FixYourDLP.com**

Sponsored by 