



Disclaimer

This user manual is provided as a free service by FixYourDLP.com. FixYourDLP is in no way responsible for the content of this manual, nor do we guarantee its accuracy. FixYourDLP does not make any claim of copyright and all copyrights remain the property of their respective owners.

About FixYourDLP.com

FixYourDLP.com (<http://www.fixyourdpl.com>) is the World's #1 resource for media product news, reviews, do-it-yourself guides, and manuals.

Informational Blog: <http://www.fixyourdpl.com>

Video Guides: <http://www.fixyourdpl.com/guides>

User Forums: <http://www.fixyourdpl.com/forum>

FixYourDLP's Fight Against Counterfeit Lamps:

<http://www.fixyourdpl.com/counterfeits>

Sponsors:

RecycleYourLamp.org – Free lamp recycling services for used lamps:

<http://www.recycleyourlamp.org>

Lamp Research - The trusted 3rd party lamp research company:

<http://www.lampresearch.com>

Discount-Merchant.com – The worlds largest lamp distributor:

<http://www.discount-merchant.com>



FixYourDLP.com

Sponsored by 

HITACHI
Inspire the Next

Projector
PJ-TX300E

ENGLISH

FRANÇAIS

DEUTSCH

ESPAÑOL

ITALIANO

User's Manual - Operating Guide

Thank you for purchasing this projector.

Please read this user's manual thoroughly to ensure the proper use of this product.

Manuel d'utilisation - Guide d'utilisation

Merci d'avoir acheté ce projecteur.

Veillez lire ce manuel d'utilisation entièrement, pour vous assurer que vous utiliserez correctement ce produit.

Bedienungsanleitung - Benutzerhandbuch

Herzlichen Glückwunsch zum Kauf dieses Projektors.

Bitte lesen Sie sich diese Bedienungsanleitung sorgfältig durch, um richtige und sichere Verwendung dieses Produkts sicherzustellen.

Manual de usuario - Guía de funcionamiento

Muchas gracias por la adquisición de este proyector.

Lea detenidamente el manual del usuario para asegurarse de usar apropiadamente este producto.

Manuale d'istruzioni - Guida operativa

Vi ringraziamo per avere acquistato questo proiettore.

Per garantirne l'impiego corretto vi raccomandiamo di leggerne a fondo il manuale d'istruzioni.



Discount-Merchant.com (800) 288-8860
THE TRUSTED SOURCE FOR PROJECTOR LAMP AND ACCESSORIES

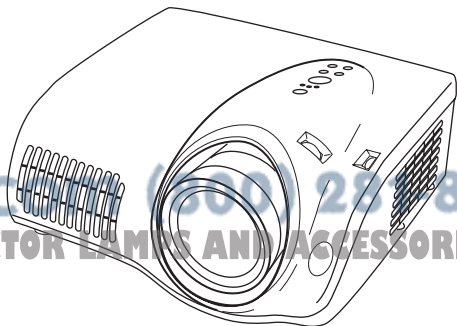

User's Manual - Safety Guide

Thank you for purchasing this projector.



⚠ WARNING • Before using, read these user's manuals of this projector to ensure correct usage through understanding. After reading, store them in a safe place for future reference. Incorrect handling of this product could possibly result in personal injury or physical damage. The manufacturer assumes no responsibility for any damage caused by mishandling that is beyond normal usage defined in these manuals of this projector.

NOTE • The information in this manual is subject to change without notice.

- The manufacturer assumes no responsibility for any errors that may appear in this manual.
- The reproduction, transmission or use of this document or contents is not permitted without express written authority.

About The Symbols

Various symbols are used in this manual, the user's manual and on the product itself to ensure correct usage, to prevent danger to the user and others, and to prevent property damage. The meanings of these symbols are described below. It is important that you read these descriptions thoroughly and fully understand the contents.

 WARNING	This symbol indicates information that, if ignored, could possibly result in personal injury or even death due to incorrect handling.
 CAUTION	This symbol indicates information that, if ignored, could result possibly in personal injury or physical damage due to incorrect handling.

Typical Symbols

 This symbol indicates an additional warning (including cautions). An illustration is provided to clarify the contents.



This symbol indicates a prohibited action. The contents will be clearly indicated in an illustration or nearby (the symbol to the left indicates that disassembly is prohibited).



This symbol indicates a compulsory action. The contents will be clearly indicated in an illustration or nearby (the symbol to the left indicates that the power plug should be disconnected from the power outlet).

Safety Precautions

WARNING

Never use the projector if a problem should occur.

Abnormal operations such as smoke, strange odor, no image, no sound, excessive sound, damaged casing or elements or cables, penetration of liquids or foreign matter, etc. can cause a fire or electrical shock.

In such case, immediately turn off the power switch and then disconnect the power plug from the power outlet. After making sure that the smoke or odor has stopped, contact your dealer. Never attempt to make repairs yourself because this could be dangerous.

- The power outlet should be close to the projector and easily accessible.

Use special caution for children and pets.

Incorrect handling could result in fire, electrical shock, injury, burn or vision problem.

Use special caution in households where children and pets are present.

Do not insert liquids or foreign object.

Penetration of liquids or foreign objects could result in fire or electrical shock.

Use special caution in households where children are present.

If liquids or foreign object should enter the projector, immediately turn off the power switch, disconnect the power plug from the power outlet and contact your dealer.

- Do not place the projector near water (ex. a bathroom, a beach, etc.).
- Do not expose the projector to rain or moisture. Do not place the projector outdoors.
- Do not place flower vases, pots, cups, cosmetics, liquids such as water, etc on or around the projector.
- Do not place metals, combustibles, etc on or around the projector.
- To avoid penetration of foreign objects, do not put the projector into a case or bag together with any thing except the accessories of the projector, signal cables and connectors.

Never disassemble and modify.

The projector contains high voltage components. Modification and/or disassembly of the projector or accessories could result in fire or electrical shock.

- Never open the cabinet.
- Ask your dealer to repair and clean insides.

Do not give the projector any shock or impact.

If the projector should be shocked and/or broken, it could result in an injury, and continued use could result in fire or electrical shock.

If the projector is shocked, immediately turn off the power switch, disconnect the power plug from the power outlet and contact your dealer.

Do not place the projector on an unstable surface.

If the projector should be dropped and/or broken, it could result in an injury, and continued use could result in fire or electrical shock.

- Do not place the projector on an unstable, slant or vibrant surface such as a wobbly or inclined stand.
- Use the caster brakes placing the projector on a stand with casters.
- Do not place the projector in the side up position, the lens up position or the lens down position.
- In the case of a ceiling installation or the like, contact your dealer before installation.



Disconnect the plug from the power outlet.



Do not disassemble.



Safety Precautions (continued)

WARNING

Be cautious of High temperatures of the projector.

High temperatures are generated when the lamp is lit. It could result in fire or burn. Use special caution in households where children are present.

Do not touch about the lens, air fans and ventilation openings during use or immediately after use, to prevent a burn. Take care of ventilation.

- Keep a space of 30 cm or more between the sides and other objects such as walls.
- Do not place the projector on a metallic table or anything weak in heat.
- Do not place anything about the lens, air fans and ventilation openings of the projector.
- Never block the air fan and ventilation openings.
- Do not cover the projector with a tablecloth, etc.
- Do not place the projector on a carpet or bedding.



Never look through the lens or openings when the lamp is on.

The powerful light could adversely affect vision.

Use special caution in households where children are present.

Use only the correct power cord and the correct power outlet.

Incorrect power supply could result in fire or electrical shock.

- Use only the correct power outlet depending on the indication on the projector and the safety standard.
- The enclosed power cord must be used depending on the power outlet to be used.



Be cautious of the power cord connection.

Incorrect connection of the power cord could result in fire or electrical shock.

- Do not touch the power cord with a wet hand.
- Check that the connecting portion of the power cord is clean (with no dust), before using. Use a soft and dry cloth to clean the power plug.
- Insert the power plug into a power outlet firmly. Avoid using a loose, unsound outlet or contact failure.



Be sure to connect with ground wire.

Connect the ground terminal of AC inlet of this unit with the ground terminal provided at the building using the correct power cord; otherwise, fire or electric shock can result.

- Don't take the core of power cord away.



Surely connect the ground wire.



Discount-Merchant.com (800) 281-8860
THE TRUSTED SOURCE FOR PROJECTOR LAMPS AND ACCESSORIES

Safety Precautions (continued)

WARNING

Be careful in handling the light source lamp.

The projector uses a high-pressure mercury glass lamp made of glass. The lamp can break with a loud bang, or burn out. When the bulb bursts, it is possible for shards of glass to fly into the lamp housing, and for gas containing mercury to escape from the projector's vent holes.



Please carefully read the section "Lamp".

Be careful in handling the power cord and external connection cables.

If you keep using a damaged the power cord or cables, it can cause a fire or electrical shock. Do not apply too much heat, pressure or tension to the power cord and cables.

If the power cord or cables is damaged (exposed or broken core wires, etc.), contact your dealer.



- Do not place the projector or heavy objects on the power cord and cables. Also, do not place a spread, cover, etc. over them because this could result in the inadvertent placing of heavy objects on the concealed power cord or cables.

- Do not pull the power cord and cables. When connecting and disconnecting the power cord or cables, do it with your hand holding the plug or connector.

- Do not place the cord near the heater.

- Avoid bending the power cord sharply.

- Do not attempt to work on the power cord.

Be careful in handling the battery of the remote control.

Incorrect handling of the battery could result in fire or personal injury. The battery may explode if not handled properly.

- Keep the battery away from children and pets. If swallowed consult a physician immediately for emergency treatment.

- Do not allow the battery in a fire or water.

- Avoid fire or high-temperature environment.

- Do not hold the battery with the metallic tweezers.

- Keep the battery in a dark, cool and dry place.

- Do not short circuit the battery.

- Do not recharge, disassemble or solder the battery.

- Do not give the battery a physical impact.

- Use only the battery specified in the other manual of this projector.

- Make sure the plus and minus terminals are correctly aligned when loading the battery.

- If you observe a leakage of the battery, wipe out the flower and then replace the battery. If the flower adheres your body or clothes, rinse well with water.

- Obey the local laws on disposing the battery.



Safety Precautions (continued)

CAUTION

Be careful in moving the projector.

Neglect could result in an injury or damage.

- Do not move the projector during use. Before moving, disconnect the power cord and all external connections, and close the slide lens door or attach the lens cap.
- Avoid any impact or shock to the projector.
- Do not drag the projector.
- For moving the projector, use the enclosed case or bag if provided.



Do not put anything on top of the projector.

Placing anything on the projector could result in loss of balance or falling, and cause an injury or damage. Use special caution in households where children are present.



Do not attach anything other than specified things to the projector.

Neglect could result in an injury or damage.

- Some projector has a screw thread in a lens part. Do not attach anything other than specified options (such as conversion lens) to the screw thread.



Avoid a smoky, humid or dusty place.

Placing the projector in a smoke, a highly humid, dusty place, oily soot or corrosive gas could result in fire or electrical shock.

- Do not place the projector near a smoky, humid or dusty place (ex. a smoking space, a kitchen, a beach, etc.). Do not place the projector outdoors.
- Do not use a humidifier near the projector.



Take care of the air filter to normal ventilate.

The air filter should be cleaned periodically. If the air filter becomes clogged by dust or the like, internal temperature rises and could cause malfunction. The projector may display the message such as "CHECK THE AIR FLOW" or turn off the projector, to prevent the internal heat level rising.

- When the indicators or a message prompts you to clean the air filter, clean the air filter as soon as possible.
- If the soiling will not come off the air filter, or it becomes damaged, replace the air filter.
- Use the air filter of the specified type only. Please order the air filter specified in the other manual of this projector to your dealer.
- When you replace the lamp, replace also the air filter. The air filter may be attached when you buy a replacement lamp for this projector.
- Do not turn on the projector without air filter.



Avoid a high temperature environment.

The heat could have adverse influence on the cabinet of the projector and other parts. Do not place the projector, the remote control and other parts in direct sunlight or near a hot object such as heater, etc.



Avoid Magnetism.

Manufacture strongly recommends to avoid any magnetic contact that is not shielded or protected on or near the projector itself. (ie., Magnetic Security Devices, or other projector accessory that contains magnetic material that has not been provided by the manufacture etc.) Magnetic objects may cause interruption of the projector's internal mechanical performance which may interfere with cooling fans speed or stopping, and may cause the projector to completely shut down.



Safety Precautions (continued)

CAUTION

Remove the power cord for complete separation.

- For safety purposes, disconnect the power cord if the projector is not to be used for prolonged periods of time.
- Before cleaning, turn off and unplug the projector. Neglect could result in fire or electrical shock.

Ask your dealer to cleaning inside of the projector about every year.

Accumulations of dust inside the projector cause result in fire or malfunction. Cleaning inside is more effective if performed before every humid periods such as rainy season.

- Do not clean inside yourself because it is dangerous.



Disconnect the plug from the power outlet.



NOTE

Do not give the remote control any physical impact.

A physical impact could cause damage or malfunction of the remote control.

- Take care not to drop the remote control.
- Do not place the projector or heavy objects on the remote control.

Take care of the lens.

- Close the slide lens door or attach the lens cap to prevent the lens surface being scratched when the projector is not used.
- Do not touch the lens to prevent fog or dirt of the lens that cause deterioration of display quality.
- Use commercially available lens tissue to clean the lens (used to clean cameras, eyeglasses, etc.). Be careful not to scratch the lens with hard objects.

Take care of the cabinet and the remote control.

Incorrect care could have adverse influence such as discoloration, peeling paint, etc.

- Use a soft cloth to clean the cabinet and control panel of the projector and the remote control. When excessively soiled dilute a neutral detergent in water, wet and wring out the soft cloth and afterward wipe with a dry soft cloth. Do not use undiluted detergent directly.
- Do not use an aerosol sprays, solvents, volatile substances or abrasive cleaner.
- Before using chemical wipes, be sure to read and observe the instructions.
- Do not allow long-term close contact with rubber or vinyl.

About bright spots or dark spots.

Although bright spots or dark spots may appear on the screen, this is a unique characteristic of liquid crystal displays, and such do not constitute or imply a machine defect.

Be careful of printing of the LCD panel.

If the projector continues projecting a still image, inactive images or 16:9 aspect images in case of 4:3 panel, etc., for long time, the LCD panel might possibly be printed.

Safety Precautions (continued)

NOTE

About consumables.

Lamp, LCD panels, polarizers and other optical components, and air filter and cooling fans have a different lifetime in each. These parts may need to be replaced after a long usage time.

- This product isn't designed for continuous use of long time. In the case of continuous use for 6 hours or more, or use for 6 hours or more every day (even if it isn't continuous), or repetitious use, the lifetime may be shortened, and these parts may need to be replaced even if one year has not passed since the beginning of using.
- Any inclining use beyond the adjustment range explained in these user's manuals may shorten the lifetimes of the consumables.

Before turning on the power, make the projector cool down adequately.

After turning the projector off, pushing the restart switch or interrupting of the power supply, make the projector cool down adequately. Operation in a high temperature state of the projector causes a damage of the electrode and un-lighting of the lamp.

Avoid strong rays.

Any strong ray (such as direct rays of the sun or room lighting) onto the remote control sensors could invalidate the remote control.

Avoid radio interference.

Any interfering radiation could cause disordered image or noises.

- Avoid radio generator such as a mobile telephone, transceiver, etc. around the projector.

About displaying characteristic.

The display condition of the projector (such as color, contrast, etc.) depends on characteristic of the screen, because the projector uses a liquid crystal display panel. The display condition can differ from the display of CRT.

- Do not use a polarized screen. It can cause red image.

Turn the power on/off in right order.

To prevent any trouble, turn on/off the projector in right order mentioned below unless specifying.

- Power on the projector before the computer or video tape recorder.
- Power off the projector after the computer or video tape recorder.

Take care not to fatigue your eyes.

Rest the eyes periodically.

Set the sound volume at a suitable level to avoid bothering other people.

- It is better to keep the volume level low and close the windows at night to protect the neighborhood environment.

Connecting with notebook computer

When connecting with notebook computer, set to valid the RGB external image output (setting CRT display or simultaneous display of LCD and CRT).

Please read instruction manual of the notebook for more information.

Lamp

WARNING



HIGH VOLTAGE



HIGH TEMPERATURE



HIGH PRESSURE

The projector uses a high-pressure mercury glass lamp. The lamp can **break with a loud bang, or burn out**, if jolted or scratched, handled while hot, or worn over time. Note that each lamp has a different lifetime, and some may burst or burn out soon after you start using them. In addition, when the bulb bursts, it is possible for **shards of glass** to fly into the lamp housing, and for **gas containing mercury** to escape from the projector's vent holes.

About disposal of a lamp • This product contains a mercury lamp; do not put in trash. Dispose of in accord with environmental laws.

For lamp recycling, go to www.lamprecycle.org. (in USA)

For product disposal, contact your local government agency or www.eiae.org (in the US) or www.epsc.ca (in Canada).

For more information, call your dealer.



Disconnect
the plug from
the power
outlet

- If the lamp should break (it will make a loud bang when it does), unplug the power cord from the outlet, and make sure to request a replacement lamp from your local dealer. Note that shards of glass could damage the projector's internals, or cause injury during handling, so please do not try to clean the projector or replace the lamp yourself.

- If the lamp should break (it will make a loud bang when it does), ventilate the room well, and make sure not to breathe the gas that comes out of the projector vents, or get it in your eyes or mouth.

- Before replacing the lamp, make sure the power switch is off and the power cable is not plugged in, then wait at least 45 minutes for the lamp to cool sufficiently. Handling the lamp while hot can cause burns, as well as damaging the lamp.



- Do not open the lamp cover while the projector is suspended from above. This is dangerous, since if the lamp's bulb has broken, the shards will fall out when the cover is opened. In addition, working in high places is dangerous, so ask your local dealer to have the lamp replaced even if the bulb is not broken.

- Do not use the projector with the lamp cover removed. At the lamp replacing, make sure that the screws are screwed in firmly. Loose screws could result in damage or injury.

- Use the lamp of the specified type only.

- If the lamp breaks soon after the first time it is used, it is possible that there are electrical problems elsewhere besides the lamp. If this happens, contact your local dealer or a service representative.

- Handle with care: jolting or scratching could cause the lamp bulb to burst during use.

- Using the lamp for long periods of time, could cause it dark, not to light up or to burst. When the pictures appear dark, or when the color tone is poor, please replace the lamp as soon as possible. Do not use old (used) lamps; this is a cause of breakage.



FixYourDLP.com

Sponsored by

Discount Projector Lamps (800) 281-8860
THE TRUSTED SOURCE FOR PROJECTOR LAMPS AND ACCESSORIES



Warranty And After-Service

Unless seen any abnormal operations (mentioned with the first paragraph of WARNING in this manual), when a problem occurs with the equipment, first refer to the “Troubleshooting” section of the “Operating Guide”, and run through the suggested checks. If this does not resolve the problem contact your dealer or service company. They will tell you what warranty condition is applied.



Discount-Merchant.com (800) 281-8860
THE TRUSTED SOURCE FOR PROJECTOR LAMPS AND ACCESSORIES

Projector

PJ-TX300E

User's Manual – Operating Guide

ENGLISH

Thank you for purchasing this projector.

⚠ WARNING ► Before using this product, please read the "User's Manual - Safety Guide" and related manuals to ensure the proper use of this product. After reading them, store them in a safe place for future reference.

NOTE • The information in this manual is subject to change without notice.
• The manufacturer assumes no responsibility for any errors that may appear in this manual.
• The reproduction, transfer or copy of all or any part of this document is not permitted without express written consent.

Trademark acknowledgment

- VGA and XGA are registered trademarks of International Business Machines Corporation.
 - Mac is registered trademarks of Apple Computer, Inc.
 - VESA and SVGA are trademarks of Video Electronics Standard Association.
 - Windows is a registered trademark of Microsoft Corporation.
 - HDMI, the HDMI logo and High-Definition Multimedia Interface are trademarks or registered trademarks of HDMI Licensing LLC.
- All other trademarks are the properties of their respective owners.



Discount-Merchant.com (800) 281-8860
THE TRUSTED SOURCE FOR PROJECTOR LAMPS AND ACCESSORIES

Content

Content



Before use	4
Projector features	4
About this manual.....	4
About contents of package.....	5
Part names	6
Projector	6
Controls buttons	7
Ports.....	7
Remote control.....	8
Preparations	9
Fastening the lens cover	9
Arrangement.....	10
Adjusting the projector's elevation.....	12
Connecting your devices	13
With a VCR/DVD player	13
For HDMI signal source	14
For DVI signal source.....	14
For a SCART RGB input	14
With a computer	15
Example of computer signal.....	16
Connecting a power supply	17
Loading batteries into the remote control	18
Using the remote control	19
Using the remote control button lights.....	19
Projection	20
Turning the power on.....	20
Selecting an input signal	21
Automatically adjusting the picture.....	21
Adjusting the display position	22
Adjusting the zoom.....	22
Adjusting the focus.....	22
Turning the power off.....	23
Basic operation	24
ASPECT	24
IRIS	25
MODE	26
BLACK	27
BRIGHTNESS, CONTRAST, COLOR.....	27
MY MEMORY	28
EASY MENU	30
EASY MENU operation	30



(EASY MENU)	30
EASY MENU functions	31
ASPECT	31
MODE, BLACK	32
BRIGHTNESS, CONTRAST, COLOR, TINT, SHARPNESS, MIRROR	33
RESET, LANGUAGE, Go To Advance Menu	34
Advanced Menu	35
Advanced Menu operation	35
PICTURE menu	37
BRIGHTNESS, CONTRAST, GAMMA	37
COLOR TEMP	39
COLOR, TINT, SHARPNESS	40
IRIS, BLACK, MY MEMORY	41
IMAGE menu	43
ASPECT, OVER SCAN	43
V POSITION, H POSITION, H PHASE, H SIZE, AUTO ADJUST	44
INPUT menu	45
PROGRESSIVE, COLOR SPACE	45
COMPONENT, VIDEO FORMAT, HDMI, FRAME LOCK	46
S-ASPECT, INFORMATION	47
SETUP menu	48
KEYSTONE, WHISPER, MIRROR	48
SCREEN menu	49
LANGUAGE, MENU POSITION, OSD BRIGHT	49
START UP, MyScreen	50
MyScreen Lock, MESSAGE	51
DIGITAL SHUTTER	52
OPTION menu	53
AUTO OFF, LAMP TIME, FILTER TIME	53
SERVICE (FAN SPEED, GHOST, STRIPE)	54
SERVICE (FILTER MESSAGE, FACTORY RESET)	55
Maintenance	56
Lamp	56
Air filter	58
Inside of the projector	60
Lens	60
Cabinet and remote control	60
Troubleshooting	61
Related message	61
Regarding the indicator lamps	62
Phenomena that may be easily mistaken as machine defects	64
Warranty and after-service	67
Specifications	67
Dimension diagram	68
Glossary	69

Before use

Before use

Projector features

This projector is used to project computer and NTSC/PAL/SECAM video signals onto a screen. It requires only a small amount of space for installation and projects a large image from even a short distance.

The following features will turn any room into a High Definition Theater.

- Super Focus ED (Extra-low dispersion) lenses are used for the highest possible image quality.
- 720P wide LCD panels are used for faithful reproduction of high definition images.
- Motorized iris control provides film-like images with a darker black.
- The 1.6x zoom lens and optical lens shift feature allow for flexibility of installation and viewing position.

About this manual

Various symbols are used throughout this manual. The meanings of these symbols are described below.

⚠ WARNING This symbol indicates information that, if ignored, could possibly result in personal injury or even death due to incorrect handling.

⚠ CAUTION This symbol indicates information that, if ignored, could possibly result in personal injury or physical damage due to incorrect handling.

NOTE To ensure proper use, please take special notice of information provided following this symbol.



See the pages noted after this symbol for more information about the current topic.



Discount-Merchant.com (800) 281-8860
THE TRUSTED SOURCE FOR PROJECTOR LAMPS AND ACCESSORIES

About contents of package

Your projector should come with the items shown below. Check to make sure that all the items are included. Contact your dealer immediately if anything is missing.

ENGLISH

(1) Projector.....

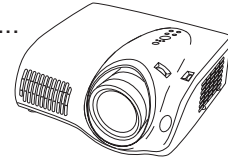

(2) Lens cover, rivet and strap.....

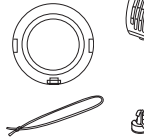

(3) Power cord.....

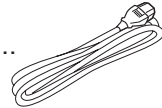

(4) Component video cable.....

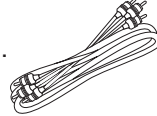

(5) Remote control and 2 AAA batteries.....

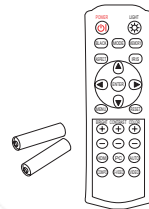

(6) User's manuals.....



⚠ WARNING ► Do not place the projector on an unstable surface.

NOTE • Keep the original packing materials for future reshipment.
Be sure to use the original packing material when moving the projector. Use special caution for the lens.
Use the original cushion for the lens.

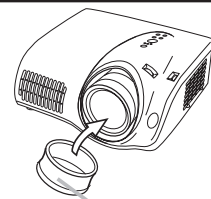

Cushion for the lens

Part names

Projector

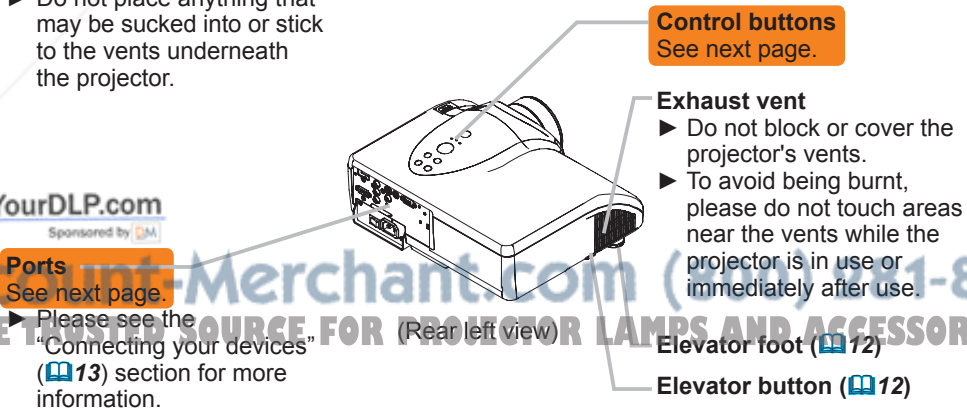
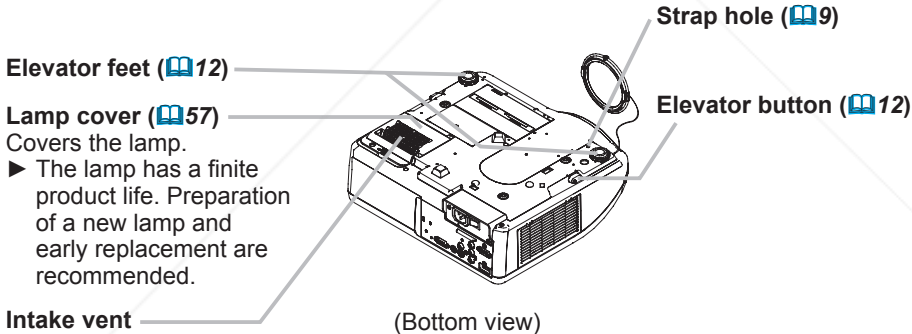
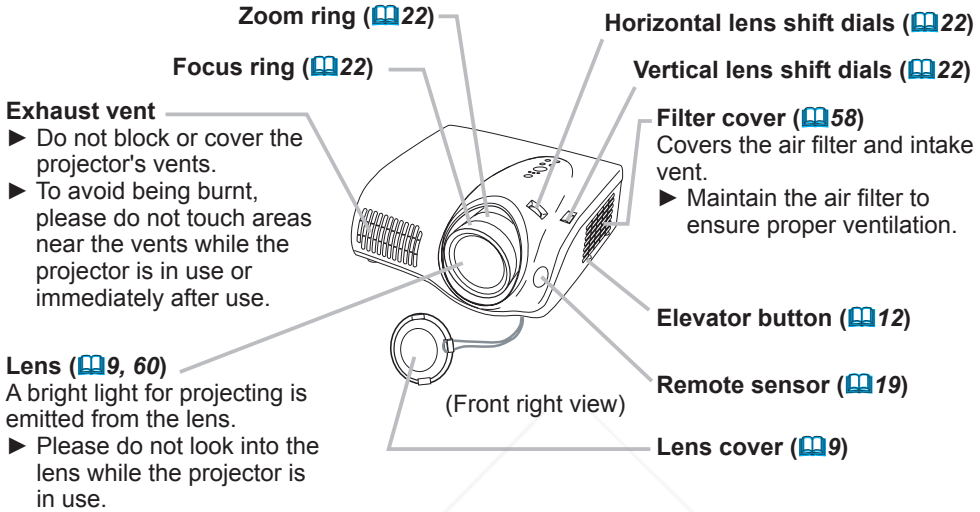

Control buttons

POWER indicator (📖20, 23, 62)

This indicator blinks while the projector is cooling down or warming up

- ▶ Note that a lit or blinking red indicator denotes a problem.

TEMP indicator (📖62)

- ▶ Note that a lit or blinking red indicator indicates a problem.

MENU button (📖30, 35)

Used to begin or end a menu operation.

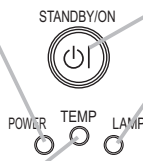

STANDBY/ON button (📖20, 23)

Used to turn the power on and off.

LAMP indicator (📖62)

- ▶ Note that a lit or blinking red indicator indicates a problem.



Cursor buttons ▲, ▼, ◀, ▶

Used to make adjustments and operate menus.



ENTER button (📖30, 35)

Used to proceed to the next stage in a menu operation.



RESET button (📖31, 36)

Used to cancel an adjustment.

INPUT button (📖21)

Used to select an input signal. Pressing this button toggles between input ports.

Ports

HDMI port (📖14)

COMPONENT VIDEO ports (📖13, 14)

This is a set of input ports composed of Y, C_B/P_B and C_R/P_R ports.

CONTROL port (📖15)

S-VIDEO port (📖13)

TRIGGER port

Restart switch (📖23, 64)

COMPUTER port (📖15)

Kensington lock slot

VIDEO port (📖13, 14)

AC inlet (📖17)

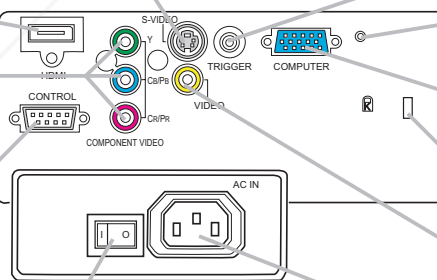

Power switch (📖20, 23)

NOTE • Use only an HDMI cable marked with the HDMI logo for HDMI connections.

The TRIGGER port (12V/25mA) is used to connect to a screen that can be controlled via a trigger signal from display equipment.

Before use

Remote control

POWER button (120, 23)

Used to turn the power on and off.

BLACK button (127)

Used to select a BLACK mode. Each mode adjusts the black setting to suit different conditions.

ASPECT button (124)

Used to select an aspect ratio.

Cursor buttons ▲, ▼, ◀, ▶

Used to make adjustments and operate menus.

MENU button (130, 35)

Used to begin or end a menu operation.

CONTRAST, BRIGHT, COLOR buttons (127)

Used to adjust the contrast, brightness and color tone.

PC, HDMI, COMPO, S-VIDEO, VIDEO buttons (121)

Used to select an input port.
PC button ⇒ COMPUTER port
HDMI button ⇒ HDMI port
COMPO button ⇒ COMPONENT VIDEO ports
S-VIDEO button ⇒ S-VIDEO port
VIDEO button ⇒ VIDEO port

MODE button (126)

Used to select a mode. Each mode is a combination of settings for gamma, color temperature and iris.

LIGHT button (119)

Used to make the buttons on the remote control light up for a short time.

MEMORY button (128)

Used to save and load user adjustment settings.

IRIS button (125)

Used to adjust the iris.

ENTER button (130, 35)

Used to proceed to the next stage in a menu operation.

RESET button (131, 36)

Used to cancel an adjustment.

AUTO button (121)

Used to enable the automatic adjustment function.

Battery cover (118)

The battery cover is on the back of the remote control.

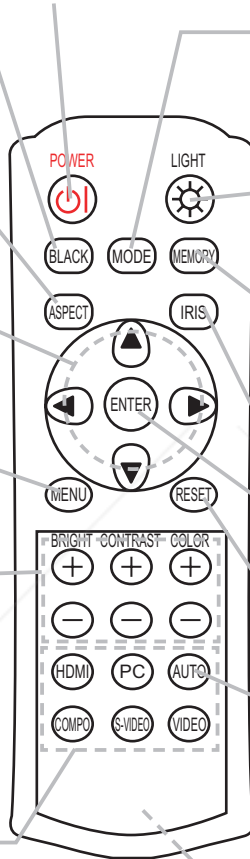

Preparations

Fastening the lens cover

Fasten the lens cover to the projector using the included strap to prevent it from becoming lost.

1. Fix the strap to the lens cover strap ring.

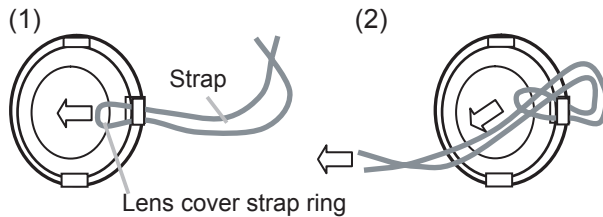

2. Put the strap into the groove on the rivet.

3. Press the rivet into the strap hole.

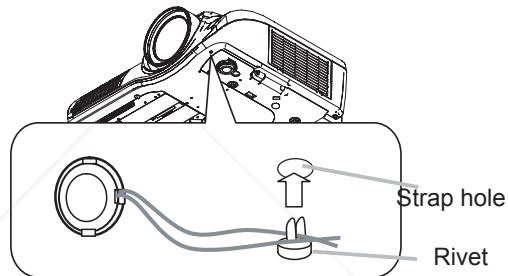

4. Put the lens cover on the lens of the projector.

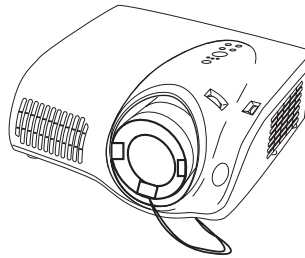

⚠ WARNING ► Do not fasten the lens cover during or immediately after use. Handling while the projector is hot could cause burn and/or projector malfunction.

⚠ CAUTION ► When the projector is not in use, be sure to close the lens cover to prevent the lens surface being scratched.

Preparations

Arrangement

Arrange the projector according to the manner in which you will use the projector and the environment the projector will be used in.

On a horizontal surface

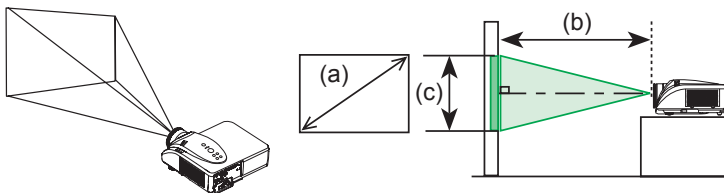

Suspended from the ceiling

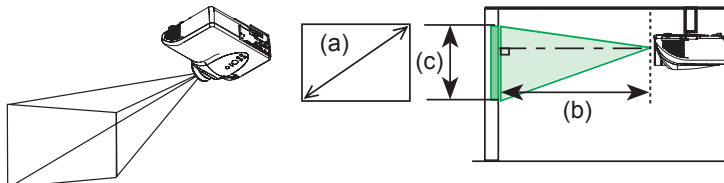

- ⚠ WARNING** ► Place the projector in a stable, horizontal position. If the projector falls or is knocked over it could result in injury and/or damage to the projector. Using a damaged projector could result in fire and/or electric shock.
- Do not place the projector on an unstable, slant or vibratory surface such as a wobbly or inclined stand.
 - Do not stand the projector on its side, front or rear faces.
 - Contact your dealer before ceiling installations and similar.
- Place the projector in a cool place, with adequate ventilation. The high operating temperature of the projector could cause burns, fire and/or projector malfunction if not properly placed.
- Do not block or cover the projector's vents.
 - Maintain a space of at least 30 cm between the sides of the projector and other objects such as walls.
 - Do not place the projector on metallic objects or objects susceptible to heat.
 - Do not place the projector on carpets, cushions or bedding.
 - Do not place the projector in direct sunlight or near heat sources, such as heaters.
 - Do not place anything on or near the projector's lens or vents. Do not place anything on top of the projector.
 - The projector also has intake vents on the bottom. Do not place anything that may be sucked into or stick to the vents underneath the projector.
- Do not place the projector any place where it may get wet. Placing the projector in a humid place or inserting liquid into the projector could cause fire, an electric shock and/or malfunction to the projector.
- Do not place the projector in a bathroom or outdoors.
 - Do not place anything containing liquid near the projector.

Refer to the illustrations and tables below to determine the screen size and projection distance.

The values shown in the table are calculated ($\pm 10\%$) for a full size screen at 1280x720.

For 16:9 screens

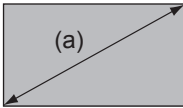

(a) Screen size		(b) Projection distance				(c) Screen height	
		min.		max.			
inch	(m)	m	(inch)	m	(inch)	cm	(inch)
30	(0.8)	0.8	(32)	1.3	(52)	37	(15)
40	(1.0)	1.1	(43)	1.8	(70)	50	(20)
50	(1.3)	1.4	(54)	2.3	(89)	62	(25)
60	(1.5)	1.7	(66)	2.7	(107)	75	(29)
70	(1.8)	2.0	(77)	3.2	(125)	87	(34)
80	(2.0)	2.2	(89)	3.6	(143)	100	(39)
90	(2.3)	2.5	(100)	4.1	(161)	112	(44)
100	(2.5)	2.8	(111)	4.6	(179)	125	(49)
120	(3.0)	3.4	(134)	5.5	(215)	149	(59)
150	(3.8)	4.3	(168)	6.9	(270)	187	(74)
200	(5.1)	5.7	(224)	9.2	(360)	249	(98)
250	(6.4)	7.1	(281)	11.5	(451)	311	(122)
300	(7.6)	8.6	(337)	13.8	(541)	374	(147)

For 4:3 screens

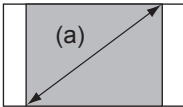

(a) Screen size		(b) Projection distance				(c) Screen height	
		min.		max.			
inch	(m)	m	(inch)	m	(inch)	cm	(inch)
30	(0.8)	1.0	(39)	1.6	(65)	46	(18)
40	(1.0)	1.4	(53)	2.2	(87)	61	(24)
50	(1.3)	1.7	(67)	2.8	(109)	76	(30)
60	(1.5)	2.1	(81)	3.3	(131)	91	(36)
70	(1.8)	2.4	(95)	3.9	(153)	107	(42)
80	(2.0)	2.8	(109)	4.5	(175)	122	(48)
90	(2.3)	3.1	(122)	5.0	(198)	137	(54)
100	(2.5)	3.5	(136)	5.6	(220)	152	(60)
120	(3.0)	4.2	(164)	6.7	(264)	183	(72)
150	(3.8)	5.2	(206)	8.4	(330)	229	(90)
200	(5.1)	7.0	(275)	11.2	(441)	305	(120)
250	(6.4)	8.7	(344)	14.0	(552)	381	(150)
300	(7.6)	10.5	(413)	16.8	(663)	457	(180)

⚠ CAUTION ► Avoid smoky, humid and dusty places (e.g. near a humidifier, a smoking area, a kitchen etc.) Placing the projector in such a place could cause fire, electric shock and/or projector malfunction.

► Adjust the position of the projector so that light does not shine directly on the projector's remote sensor.

► The manufacturer strongly recommends avoiding any magnetic contact that is not shielded or protected on or near the projector itself. (e.g. Magnetic Security Devices, or other projector accessories that contain magnetic material that has not been provided by the manufacture etc.) Magnetic objects may cause interruption of the projector's internal mechanisms which may interfere with cooling fan speed or cause the fans to stop, and may cause the projector to shut down completely.

Preparations

Adjusting the projector's elevation

The elevator feet can be used to make adjustments if the surface on which the projector is set is uneven or if the projection angle needs to be otherwise adjusted. The adjustment range of the elevator feet is 0 to 7 degrees.

1. Press and hold in the elevator buttons while holding the projector. There are elevator buttons and feet on the both sides of the projector.
2. Raise or lower the projector to the desired height and release the elevator buttons. When the elevator buttons are released, the elevator feet will lock into position.
3. If necessary, the elevator feet can be manually twisted to make more precise adjustments.

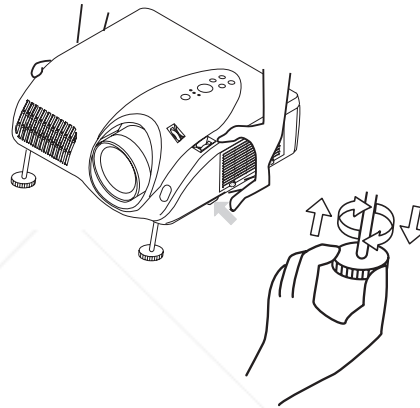
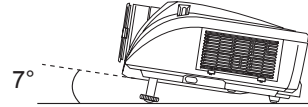

⚠ WARNING ► Do not adjust the elevation of the projector during or immediately after use. Handling while the projector is hot could cause burn and/or projector malfunction. Before adjusting the elevation, make sure that the power switch is off, that the power cord is unplugged, and that the projector is adequately cool.

⚠ CAUTION ► Using the elevator buttons without holding the projector could cause the projector to fall, overturn, or strike your fingers and possibly cause projector malfunction. To prevent damaging the projector and injuring yourself, always hold the projector whenever using the elevator buttons to adjust the elevator feet.

► Do not tilt the projector to the right or left. Also be sure not to raise the front or rear of the projector more than 7 degrees. Raising the projector more than 7 degrees could cause projector malfunction or shorten the lifetime of consumables.

► Other than raising the projector using the elevator feet, place the projector horizontally.

Connecting your devices

With a VCR/DVD player

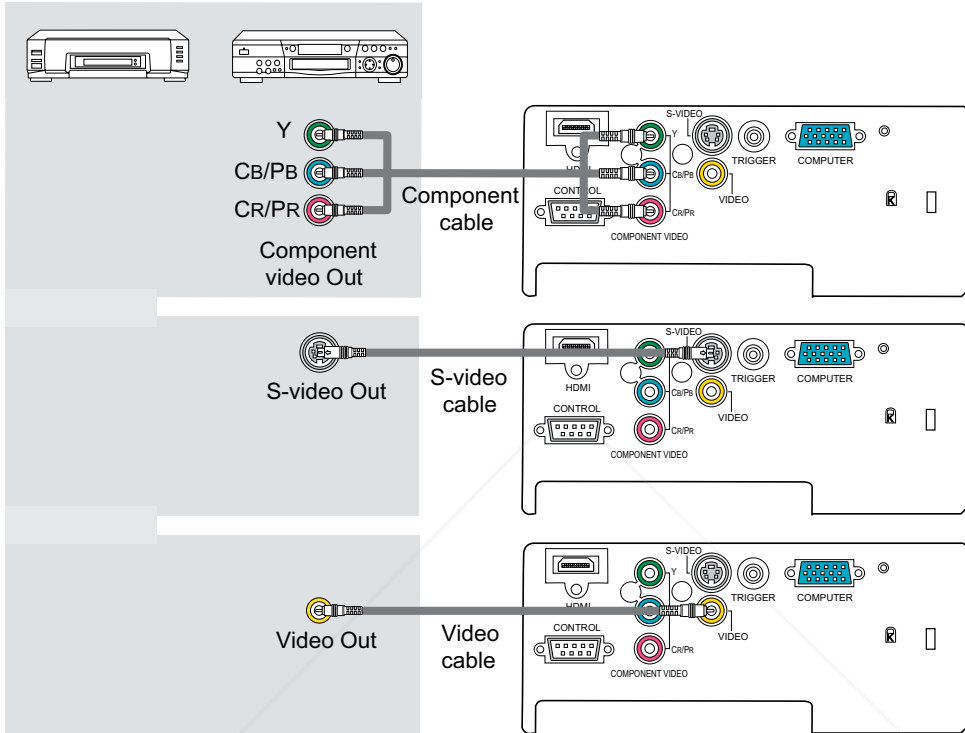

ENGLISH

⚠ CAUTION ▶ Turn off all devices prior to connecting them to the projector. Attempting to connect a live device to the projector may generate extremely loud noises or other abnormalities that may result in malfunction and/or damage to the device and/or projector.

▶ Use the accessory cables or a designated cable type to make connections. Some cables have to be used with a core. A cable that is too long may cause picture degradation. Please consult with your dealer for more information. For cables that have a core only at one end, connect the end with the core to the projector.

▶ Make sure that devices are connected to the correct port. An incorrect connection may result in malfunction and/or damage to the device and/or projector.

NOTE • Be sure to tighten the screws on connectors to secure.

• Automatic adjustment may not function correctly with some input signals.

Preparations

For an HDMI signal source

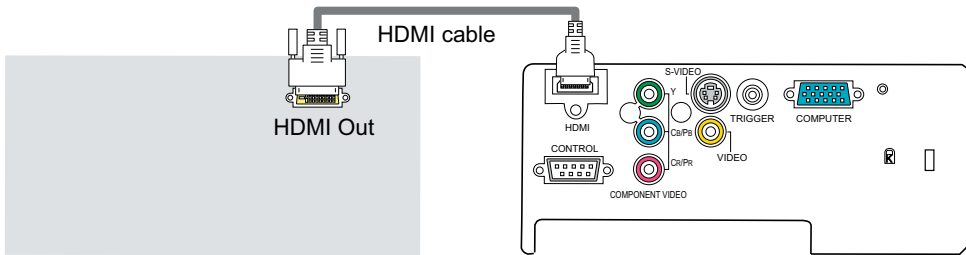

For a DVI signal source

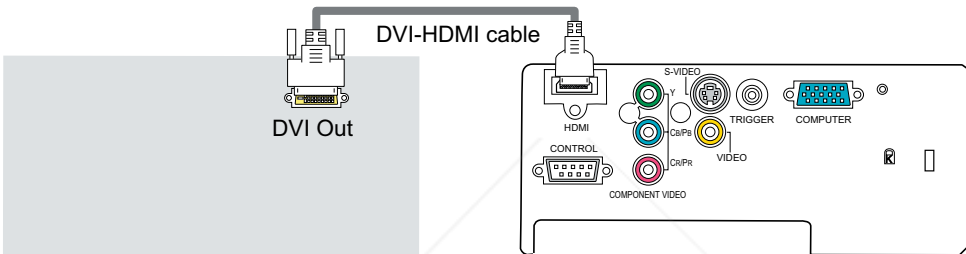

For an SCART RGB input

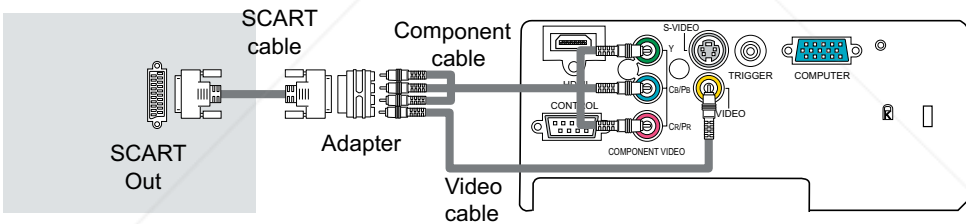

⚠ CAUTION ► Turn off all devices prior to connecting them to the projector. Attempting to connect a live device to the projector may generate extremely loud noises or other abnormalities that may result in malfunction and/or damage to the device and/or projector.

► Use the accessory cables or a designated cable type to make connections. Some cables have to be used with a core. A cable that is too long may cause picture degradation. Please consult with your dealer for more information. For cables that have a core only at one end, connect the end with the core to the projector.

► Make sure that devices are connected to the correct port. An incorrect connection may result in malfunction and/or damage to the device and/or projector.

With a computer

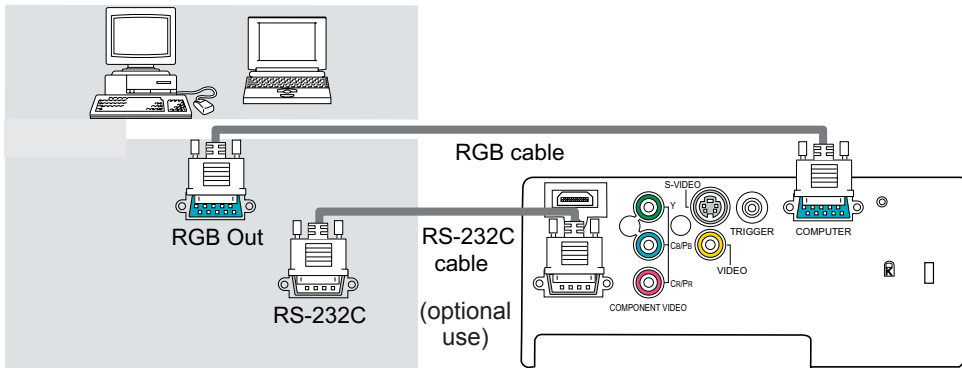

ENGLISH

- NOTE**
- Be sure to tighten the screws on connectors to secure.
 - Use only an HDMI cable marked with the HDMI logo for HDMI connections.
 - Use a DVI-HDMI cable or adapter when connecting to a DVI output device. In some cases however, a DVI input to the HDMI port may not work properly.
 - Whenever attempting to connect a laptop computer to the projector, be sure to activate the laptop's external RGB output (set the laptop to CRT display or to simultaneous LCD and CRT display). For more information please refer to the instruction manual of the laptop computer.
 - Be sure to check jack type, signal level, timing and resolution before connecting this projector to a computer.
 - Some computers may have multiple screen display modes. Some of these modes cannot be used with this projector.
 - The image may not be displayed correctly when the input signal is a composite sync or a sync on G signal.
 - For some computer signals the optional Mac adapter is necessary.
 - Automatic adjustment may not function correctly with some input signals.

Preparations

Computer signal examples

Resolution (HxV)	H. frequency (kHz)	V. frequency (Hz)	Rating	Signal mode
720 x 400	37.9	85.0	VESA	TEXT
640 x 480	31.5	59.9	VESA	VGA (60Hz)
640 x 480	37.9	72.8	VESA	VGA (72Hz)
640 x 480	37.5	75.0	VESA	VGA (75Hz)
640 x 480	43.3	85.0	VESA	VGA (85Hz)
800 x 600	35.2	56.3	VESA	SVGA (56Hz)
800 x 600	37.9	60.3	VESA	SVGA (60Hz)
800 x 600	48.1	72.2	VESA	SVGA (72Hz)
800 x 600	46.9	75.0	VESA	SVGA (75Hz)
800 x 600	53.7	85.1	VESA	SVGA (85Hz)
1024 x 768	48.4	60.0	VESA	XGA (60Hz)
1024 x 768	56.5	70.1	VESA	XGA (70Hz)
1024 x 768	60.0	75.0	VESA	XGA (75Hz)
1280 x 720	44.7	60.0	VESA	-
1280 x 1024	64.0	60.0	VESA	SXGA (60Hz)

NOTE • Full-size display may not be possible with some input signals. Refer to the resolutions above.

- Although the projector can display signals with resolution up to SXGA (1280x1024), signals will be converted to the projector's panel resolution before being displayed. The best display performance is achieved when the resolutions of the input signal and projector panel are identical.
- For some input types when the screen resolution is changed on a computer, the automatic adjustment function may take a long time or may not complete. If this happens, you may not be able to see the "Yes/No" check box to confirm the resolution change in Windows. The screen resolution will then be reset to the previous resolution. It is recommended to use a CRT or LCD monitor to change the resolution if this occurs.

About Plug-and-Play capability

Plug-and-Play is a system composed of a computer, its operating system and peripheral equipment (i.e. display devices). This projector is VESA DDC 2B compatible. Plug-and-Play can be used by connecting this projector to a computer that is VESA DDC (display data channel) compatible.

Take advantage of this feature by connecting an RGB cable to the COMPUTER port (DDC 2B compatible). Plug-and-Play may not work properly if any other type of connection is attempted.

- This projector behaves as a standard Plug-and-Play monitor and uses the standard monitor drivers provided with your operating system.

Connecting the power supply

Before connecting the power, make sure that the power switch is in the OFF position (the side marked "O").

1. Connect the power cord connector to the projector's AC inlet.
2. Plug the power cord's plug firmly into a power outlet.

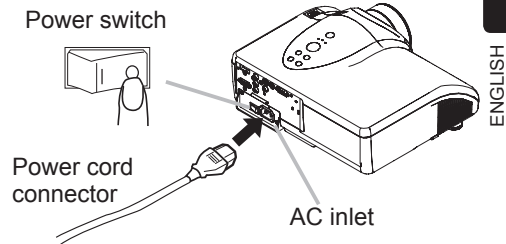

- ⚠ WARNING** ► Use extra caution when connecting the power cord as incorrect or faulty connections may result in fire and/or electrical shock.
- Use only the power cord that came with the projector. If it becomes damaged, contact your dealer for a new one.
 - Only plug the power cord into an outlet rated for use with the power cord's specified voltage range.
 - Never modify the power cord. Never attempt to defeat the ground connection of the three-pronged plug.
 - The power outlet should be close to the projector and easily accessible.
 - Do not touch the power cord with wet hands.
 - Check that the power cord connector is clean (no dust) before using. Use a soft, dry cloth to clean the power cord.
 - Insert the power plug into the power outlet firmly. Avoid using loose, unsound outlets and contact failures.

Preparations

Loading batteries into the remote control

Please load the batteries before using the remote control. If the remote control starts to malfunction, replace the batteries. If you will not use the remote control for an extended period, remove the batteries from the remote control and store them in a safe place.

1. Remove the battery cover. Slide the battery cover back in the direction of the arrow and remove.
2. Take old batteries out and/or put new batteries in. When putting batteries in, insert the two AAA batteries according to their plus and minus terminals as indicated on the remote control.
3. Close the battery cover. Replace the battery cover in the direction of the arrow and snap it back into place.

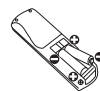

⚠ WARNING ► Always handle batteries with care and use them only as directed. Batteries may explode if mishandled. Mishandling may also result in cracking or leakage, which could in turn result in fire, injury and/or pollution of the surrounding environment.

- Do not recharge, short circuit, solder, disassemble or dispose of batteries in fire or water.
- Be sure to use only the batteries specified. Do not use different types of batteries together. Do not mix new and old batteries.
- Make sure the plus and minus terminals are correctly aligned when loading batteries.
- Keep batteries away from children and pets.
- Keep batteries in a dark, cool and dry place.
- Do not drop, hit or otherwise jar the battery in anyway.
- If you notice battery leakage, clean out the liquid and then replace the battery. If any of the liquid gets on your body or clothes, immediately rinse well with water.
- Obey local laws on battery disposal.

Using the remote control

The remote control works with the projector's remote sensor.

- The range of the remote sensor is 60-degrees (30-degrees to the left and right of the remote sensor) within 3 meters.
- The remote signal may also be able to be reflected off the screen etc. If it is difficult to send the remote signal to the sensor directly, try to reflect the signal.
- The remote control uses infrared light to send signals to the projector (Class1 LED), so be sure to use the remote control in an area free from obstacles that could block the remote control's signal to the projector.

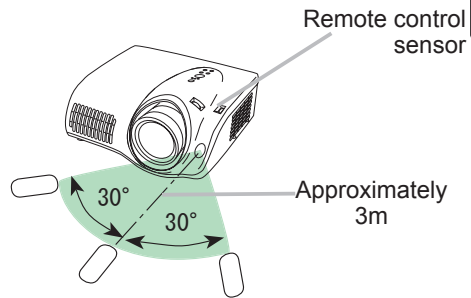

Using the remote control button lights

When using the remote control in the dark, the buttons of the remote control can light up.

1. Pressing the LIGHT button turns the remote control button lights on. The lights will automatically turn off after a short time.

LIGHT button

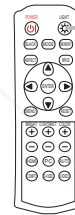

⚠ CAUTION ► Be careful when handling the remote control. Incorrect handling could cause damage and/or malfunction.

- Do not drop, hit or otherwise jar the remote control in anyway.
- Do not get the remote control wet or place it on wet objects.
- If you will not use the remote control for an extended period, remove the batteries from the remote control and store them in a safe place.

NOTE • If the remote control starts to malfunction, replace the batteries.
 • The remote control may not function correctly if strong light (such as direct sunlight) or light from an extremely close range (such as from an inverter fluorescent lamp) shines on the projector's remote sensor. Adjust the position of the projector so that light does not shine directly on the projector's remote sensor.

Projection

Projection

Turning the power on

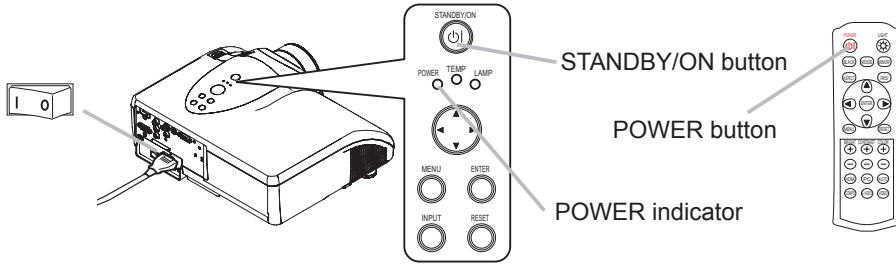

1. Make sure that the power cord is firmly and correctly connected to both the projector and power outlet.
2. Open the lens cover, and set the power switch to the ON position.
The power indicator will light a steady orange. Then wait several seconds because buttons may not function for the first several seconds the projector is turned on.
3. Press the STANDBY/ON button on the projector or the POWER button on the remote control.
The projector lamp will light up and the POWER indicator will begin blinking in green. When the power is completely on, the indicator will stop blinking and light a steady green.

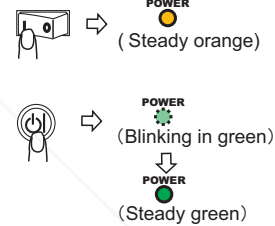

⚠ WARNING ► When the power is on, a strong light is emitted. Do not look into the projector lens or openings.

NOTE • Turn the power on in the correct order. Turn on the projector before the connected devices.

Adjusting the display position

The lens of this projector can be shifted horizontally and vertically to adjust the display position using the lens shift dials.

1. Use the vertical lens shift dial to shift the picture upward or downward.
2. Use the horizontal lens shift dial to shift the picture left or right.

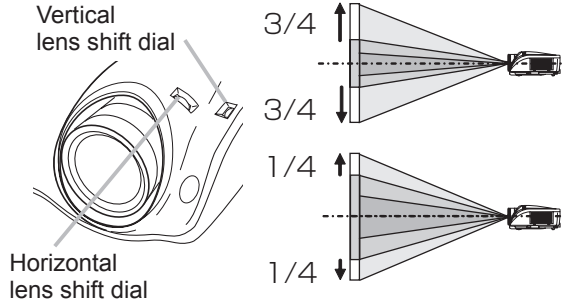

NOTE • The best picture quality is generally achieved when the lens shift is set to the center. Each lens shift dial clicks into place when set to the center.

Adjusting the zoom

Use the zoom ring on the projector to adjust the magnification of the picture.

1. Hold the knob of the zoom ring while turning the zoom ring.

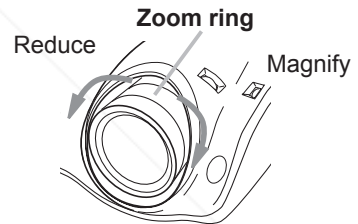

Adjusting the focus

Use the focus ring on the projector to focus the picture.

1. Hold the knob of the focus ring while turning the focus ring.

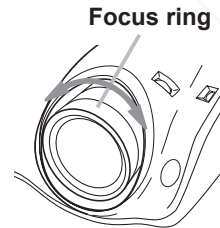

Turning the power off

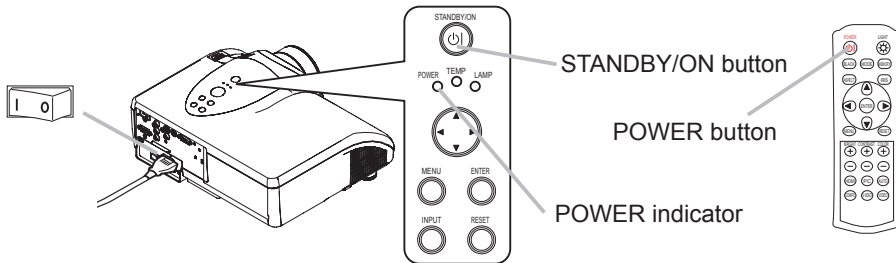

1. Press the STANDBY/ON button on the projector or the POWER button on the remote control. The message "Power off?" will appear on the screen for approximately 5 seconds.
2. Press the STANDBY/ON button on the projector or the POWER button on the remote control again when the "Power off?" message appears. The projector lamp will go off, and the POWER indicator will begin blinking in orange. Then the POWER indicator will stop blinking and light steady orange when the lamp is finished cooling down.
3. Make sure that the power indicator is lit a steady orange, and set the power switch to the OFF position. The POWER indicator will go off. Do not set the power switch to the OFF position while the POWER indicator is green or blinking.
4. Close the lens cover. For safety purposes, disconnect the power cord if the projector is not to be used for prolonged periods of time.

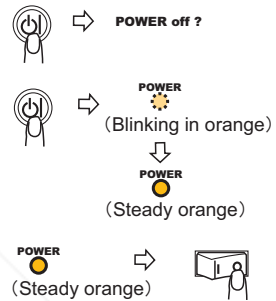

NOTE • Turn the power off in right order. Turn off the connected devices first and the projector last.

• Except for emergencies, whenever you turn the projector off be sure to follow the procedure explained in "Turning off the power", and do not disconnect the power cord until the procedure is complete. Neglect can cause damage to the electrode and/or prevent the lamp from lighting.

• This projector is controlled by an internal microprocessor. Under certain exceptional circumstances, the projector may not operate correctly even when turning off the power. If this occurs, please push the restart switch (7, 64) using a pin or similar object. Make sure that the power indicator is lit a steady orange, and set the power switch to the OFF position. Only use the restart switch in exceptional circumstances.

• If there is a power failure, or the restart switch is used, allow the projector to cool down for at least 10 minutes before turning on again.

Basic operation

Basic operation

The following functions are basic and useful. They can also be easily accessed using the remote control.

Some functions display dialogs to aid you. Although the dialogs automatically close after several seconds, the dialogs can be deactivated using the MESSAGE function in the SCREEN menu (49).

ASPECT

ASPECT refers to the aspect ratio modes. The following aspect ratio modes are available. Select a mode corresponding to the input signal to be used.

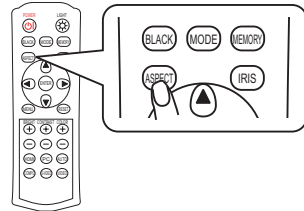

1. Press the ASPECT button.
 - Each time the button is pressed the mode will change and a dialog indicating the selected mode will be displayed.

■ For a computer (RGB) signal

NORMAL → 4:3 → 16:9



■ For an HDMI signal

NORMAL → 4:3 → 16:9 → WIDE → MOVIE1 → MOVIE2 → 14:9



■ For a video, s-video or component video signal

4:3 → 16:9 → WIDE → MOVIE1 → MOVIE2 → 14:9



■ For no signal or an unrecognized signal

16:9 (fixed)

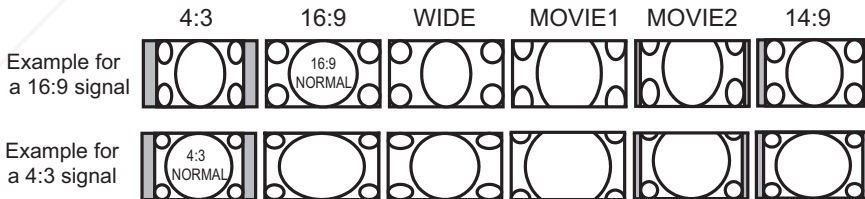

- NOTE** • The NORMAL mode uses the signal's original aspect ratio.
- Performing an automatic adjustment initializes the aspect ratio setting.
 - The ASPECT function can also be accessed via the EASY MENU (31) or the IMAGE menu in the Advanced Menu (43).

IRIS

The iris can be adjusted to suit the brightness of the surroundings and other conditions.

1. Press the IRIS button.
The projector will display a dialog to aid you in adjusting the iris.
2. Use the ▲/▼ cursor buttons to adjust the iris.

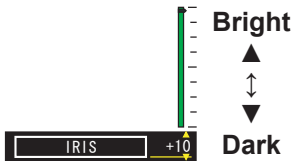
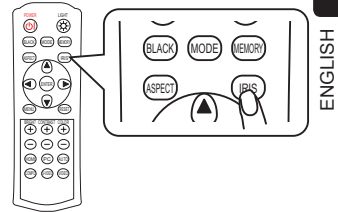

3. To close the dialog and end the operation press the IRIS button again. The dialog will automatically close after several seconds without user input.

NOTE • Pressing the RESET button while the dialog is displayed resets the adjustment.

• The IRIS function can also be accessed via the PICTURE menu in the Advanced Menu ([41](#)).

Basic operation

MODE

MODE refers to modes that are a combination of the GAMMA (📖37), COLOR TEMP (📖39), and IRIS (📖41) settings as shown in the table below. Select a mode corresponding to the input signal to be used.

1. Press the MODE button.
 - Each time the button is pressed the mode will change and a dialog indicating the selected mode will be displayed.

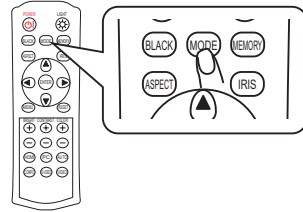

NORMAL → CINEMA LOW → CINEMA HIGH → MUSIC → SPORTS



MODE	GAMMA	COLOR TEMP	IRIS	Recommended source
NORMAL	STANDARD	7500K	7	For a wide range of sources at standard picture quality.
CINEMA LOW	LOW	6500K	5	Suitable for appreciating movies with film-like video.
CINEMA HIGH	HIGH	6500K	5	Suitable for appreciating movies with sharp, realistic video.
MUSIC	HIGH	7500K	7	Suitable for live concerts, music videos.
SPORTS	HI-CONTRAST	9300K	10	Suitable for video that emphasizes a feeling of contrast: high definition broadcasts, sports broadcasts.

NOTE • When the combination of the settings does not correspond with any pre-set modes, the dialog will display the mode as “CUSTOM”.
 • The MODE function can also be accessed via the EASY MENU (📖32).

BLACK

BLACK refers to the auto iris control modes as shown in the table below. The auto iris is automatically controlled to adjust the black level according to the mode selected.

1. Press the BLACK button.
 - Each time the button is pressed the mode will change and a dialog indicating the selected mode will be displayed.

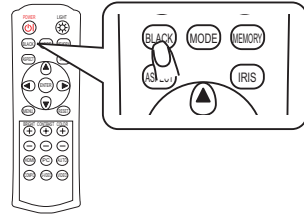

ENGLISH

TURN OFF → AUTO1 → AUTO2

BLACK	Mode characteristics
TURN OFF	The auto iris is always open.
AUTO1	The auto iris displays a better black for dark images.
AUTO2	The auto iris displays the best black for dark images.

NOTE • The screen may flicker when the AUTO1 or AUTO2 modes are selected.
 • The BLACK function can also be accessed via the EASY MENU (□32) or the PICTURE menu in the Advanced Menu (□41).

BRIGHTNESS, CONTRAST, COLOR

The brightness, contrast and color can be easily adjusted to suit your preferences.

1. On the remote control press either the ⊕ or ⊖ buttons under the item you want to adjust. The projector will then display a dialog to aid you in adjusting the item.
2. Use the ⊕ and ⊖ cursor buttons to adjust the item.

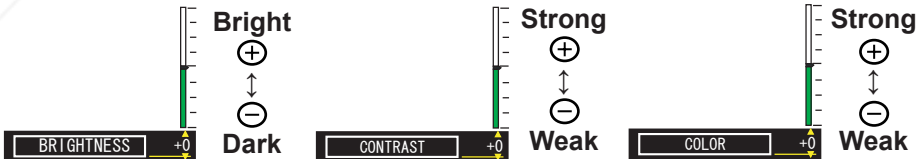
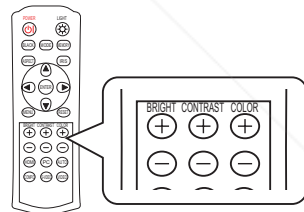

NOTE • Pressing the RESET button while the dialog is displayed resets the adjustment.
 • The BRIGHTNESS, CONTRAST and COLOR functions can also be accessed via the EASY MENU (□33) or the PICTURE menu in the Advanced Menu (□37, 40).
 • The COLOR function can only be used for video, s-video, component video or HDMI signals.

MY MEMORY

This projector provides 4 memories to save user adjustment settings. The brightness, contrast, color, tint, sharpness and iris adjustment settings, and selected modes for gamma, color temperature, black, whisper and digital shutter can be saved to each memory.

You can name and save a maximum of 4 sets of adjustment settings, and the saved adjustment settings can be named and reloaded later.

To load saved adjustment settings

Note that if the MESSAGE function (📖 51) is inactive, step 1 in the following procedure is skipped. The projector will not display any dialog, and will load saved adjustment settings as soon as the MEMORY button is pressed. Please see step 2.

1. Press the MEMORY button once.
 - The projector will display a dialog to indicate the current adjustment settings.
- When the current adjustment settings are from one of the saved memories a dialog shows which memory is being used.

1. CUSTOM-1

- When the current settings are not saved to memory the following dialog is displayed.

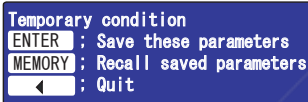

2. To load saved adjustment settings press the MEMORY button.
 - Each time you press the button, one of the saved adjustments is loaded, in the following order. Memories in which no data is saved are skipped.

1. CUSTOM-1 → 2. CUSTOM-2 → 3. CUSTOM-3 → 4. CUSTOM-4



- When there are no saved adjustment settings the following dialog is displayed.

No saved data

- NOTE** • Adjustment settings cannot be loaded when there are no saved adjustment settings.
- The numbers to the left of each memory cannot be changed but the name to the right can be changed.
 - The MY MEMORY function can also be accessed via the PICTURE menu in the Advanced Menu (📖 41).

To save adjustment settings

Note that if the MESSAGE function (📖 51) is inactive, the following procedure cannot be performed and the projector will load saved adjustment settings as soon as the MEMORY button is pressed.

When the MESSAGE function is inactive please use the MY MEMORY function in the PICTURE menu (📖 42) to save adjustment settings.

When the MESSAGE function is active, the MY MEMORY menu can be displayed using the following procedure. The MY MEMORY menu displayed is the same as in the PICTURE menu. You cannot only save adjustment settings but also change and rename previously saved adjustment settings via this menu.

1. Press the MEMORY button once.
 - The projector will display a dialog to indicate the current adjustment settings.
- When the current adjustment settings are from one of the saved memories a dialog shows which memory is being used.

1. CUSTOM-1

- When the current settings are not saved to memory the following dialog is displayed.

```
Temporary condition
ENTER : Save these parameters
MEMORY : Recall saved parameters
← : Quit
```

2. Press the ENTER button while the dialog is displayed to open the MY MEMORY menu and save to the currently selected memory.
3. Please refer to the MY MEMORY item under PICTURE menu (📖 42) for more information on using the MY MEMORY menu.

MY MEMORY		⊙ : SELECT
NAME	CUSTOM-1	▶
BRIGHTNESS	+0	
CONTRAST	+0	
GAMMA	STANDARD	
COLOR TEMP	6500K	
COLOR	+0	
TINT	+0	
SHARPNESS	+3	
IRIS	10	
BLACK	TURN OFF	
WHISPER	NORMAL	
DIGITAL SHUTTER	TURN OFF	
SAVE		
MENU		: QUIT

NOTE • The numbers to the left of each memory cannot be changed but the name to the right can be changed.
 • The MY MEMORY function can also be accessed via the PICTURE menu in the Advanced Menu (📖 42).

EASY MENU

EASY MENU

This projector has various functions intended to improve picture quality. The EASY MENU provides quick and easy access to the most useful of these functions.

EASY MENU operation

Follow the procedure below to use the EASY MENU.

- To display a menu when no menu is currently displayed**

Press the MENU button and a menu will be displayed. Alternatively, pressing one of the ▲/▼/◀/▶ cursor buttons will also display a menu.

The tall menu is the EASY MENU. The wide menu is the Advanced Menu.

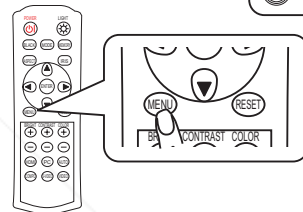
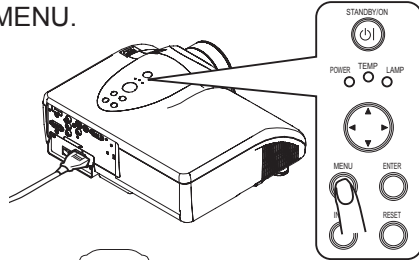

- To switch from the Advanced Menu to the EASY MENU**

 - If the yellow highlight bar is in the right column of the Advanced Menu, press the ◀ cursor button to move the yellow highlight bar to the left column.
 - Move the yellow highlight bar onto the “EASY MENU” item using the ▲/▼ cursor buttons, then press the ▶ cursor button or the ENTER button.

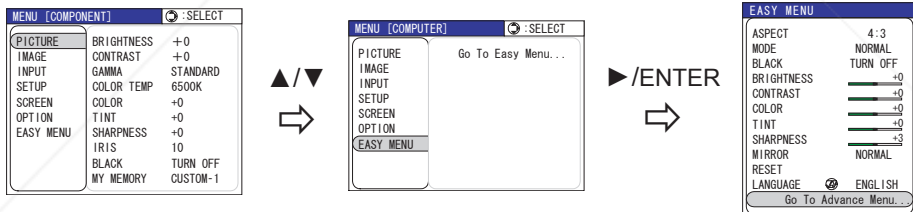

The EASY MENU item is always the bottom item in the left column of the Advanced Menu. Even if the menu is displayed in another language, choosing the bottom item in the left column will switch to the EASY MENU.

- To change the display language**

The display language can be changed using the LANGUAGE item in the EASY MENU (34).

Even if the menu is displayed in another language, the LANGUAGE item will always be the 2nd item from the bottom in the EASY MENU.

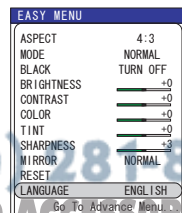



- To select an item**

Move the yellow highlight bar onto the item you want to select using the ▼/▲ cursor buttons.

5. **To operate the selected item**
Use the ◀/▶ cursor buttons to operate the item. For details please see the following descriptions.
6. **To reset the operation**
Press the RESET button while the item is selected.
(Does not reset the LANGUAGE item.)
7. **To close the menu**
Press the MENU button to close the menu. The menu will automatically close after several seconds without user input.

EASY MENU functions

The following functions are accessible via the EASY MENU. After selecting an item according to the procedure described in the preceding “EASY MENU operation” section, refer to the following table for details on operating the selected item.

Item	Description
ASPECT	<p>Using the ◀/▶ cursor buttons changes the aspect ratio.</p> <ul style="list-style-type: none"> ■ For a computer (RGB) signal NORMAL ⇄ 4:3 ⇄ 16:9 ↑ ■ For an HDMI signal NORMAL ⇄ 4:3 ⇄ 16:9 ⇄ WIDE ⇄ MOVIE1 ⇄ MOVIE2 ⇄ 14:9 ↑ ■ For a video, s-video or component video signal 4:3 ⇄ 16:9 ⇄ WIDE ⇄ MOVIE1 ⇄ MOVIE2 ⇄ 14:9 ↑ ■ For no signal or an unrecognized signal 16:9 (fixed) <p style="text-align: center;">4:3 16:9 WIDE MOVIE1 MOVIE2 14:9</p> <p>Example for a 16:9 signal</p>  <p>Example for a 4:3 signal</p>  <p>- NOTE -</p> <ul style="list-style-type: none"> • The NORMAL mode uses the signal's original aspect ratio. • Performing an automatic adjustment initializes the aspect ratio setting. • The ASPECT function can also be accessed using the ASPECT button on the remote control (▶ 24) or via the IMAGE menu in the Advanced Menu (▶ 43).

(Continued on next page)

EASY MENU

Item	Description
RESET	Using this function resets all items in the EASY MENU except the LANGUAGE item. Pressing the ► cursor button displays a confirmation dialog. To reset press the ▼ cursor button.
LANGUAGE	Using the ◀/▶ cursor buttons changes the display language. ENGLISH ⇔ FRANÇAIS ⇔ DEUTSCH ⇔ ESPAÑOL ↓ ITALIANO ⇔ NORSK ⇔ NEDERLANDS ⇔ PORTUGUÊS ↓ 日本語 ⇔ 简体中文 ⇔ 繁體中文 ⇔ 한글 ↓ SVENSKA ⇔ РУССКИЙ ⇔ SUOMI ⇔ POLSKI ⇔ TÜRKÇE ↓
Go To Advance Menu	Pressing the ► cursor button switches to the Advanced Menu.

- NOTE -

- The LANGUAGE function can also be accessed via the SCREEN menu in the Advanced Menu (49).

Advanced Menu

The Advanced Menu provides access to advanced features, grouped into 6 sub-menus (PICTURE, IMAGE, INPUT, SETUP, SCREEN and OPTION) for more precise picture control.

ENGLISH

Advanced Menu operation

Follow the procedure below to use the Advanced Menu.

- To display a menu when no menu is currently displayed**

Press the MENU button and a menu will be displayed. Alternatively, pressing one of the ▲/▼/◀/▶ cursor buttons will also display a menu.

The tall menu is the EASY MENU. The wide menu is the Advanced Menu.

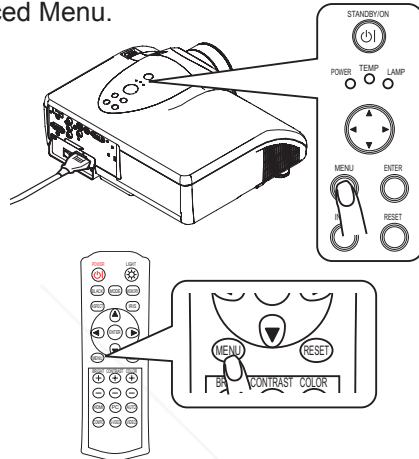

- To switch from the EASY MENU to the Advanced Menu**

Move the yellow highlight bar onto the “Go To Advanced Menu...” item using the ▲/▼ cursor buttons, then press the ▶ cursor button or the ENTER button.

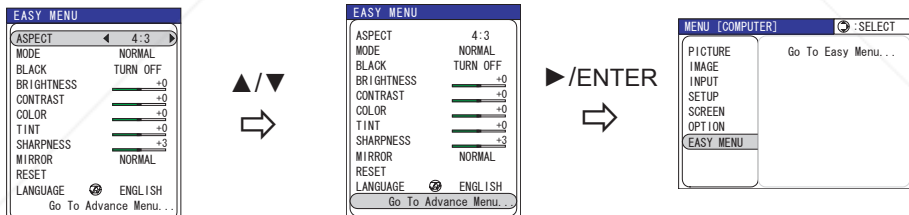

The “Go To Advance Menu...” item is always the bottom item in the EASY MENU. Even if the menu is displayed in another language, choosing the bottom item in the left column will switch to the Advanced Menu.

- To change the display language**

The display language can be changed using the LANGUAGE item on the SCREEN menu in the Advanced Menu (49).

Even if the menu is displayed in another language, the SCREEN menu will always be the 5th item from the top in the left column of the Advanced Menu and the LANGUAGE item will always be the top item in the SCREEN menu.

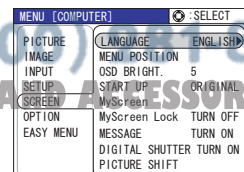

Advanced Menu

4. To select a menu

- (1) If the yellow highlight bar is in the right column of the Advanced Menu, press the ◀ cursor button to move the yellow highlight bar to the left column.
- (2) Move the yellow highlight bar onto the title of the menu you want to select using the ▼/▲ cursor buttons. The menu items will be shown in the right column of the Advanced Menu.
Then press the ▶ cursor button or ENTER button.

5. To reset the menu settings

- All the settings of the selected menu can be initialized at the same time, except settings where the current setting is always considered the default setting. (MY MEMORY, LANGUAGE, MyScreen Lock, LAMP TIME, FILTER TIME etc.)
- (1) Press the RESET button while yellow highlight bar is on the title of the menu and a confirmation dialog will be displayed.
 - (2) To reset press the ▲ cursor button.

6. To select an item

- (1) Move the yellow highlight bar onto the item you want to select using the ▼/▲ cursor buttons. Then press the cursor ▶ button or ENTER button, and a dialog or sub-menu will appear.

7. To operate the selected item

- (1) Use the ▲/▼/◀/▶ cursor buttons according to the dialog or sub-menu. For more details please see the following descriptions of each item.

8. To reset the operation

- (1) Press the RESET button while the dialog or sub-menu is displayed. (Except for MY MEMORY, AUTO ADJUST, INFORMATION, LANGUAGE, MyScreen Lock, LAMP TIME, FILTER TIME and SERVICE.)

9. To close the menu

- (1) Press the MENU button to close the menu. The menu will automatically close after several seconds without user input.

PICTURE menu

The following functions are accessible via the PICTURE menu. After selecting an item according to the procedure described in the preceding “Advanced Menu operation” section (35), refer to the following table for details on operating the selected item.

MENU [COMPONENT]		SELECT
PICTURE	BRIGHTNESS	+0
IMAGE	CONTRAST	+0
INPUT	GAMMA	STANDARD
SETUP	COLOR TEMP	6500K
SCREEN	COLOR	+0
OPTION	TINT	+0
EASY MENU	SHARPNESS	+0
	IRIS	10
	BLACK	TURN OFF
	MY MEMORY	CUSTOM-1

ENGLISH

Item	Description
BRIGHTNESS	<p>Using the ▲/▼ cursor buttons adjusts the picture.</p> <p>Brighter ⇄ Darker</p> <p>- NOTE -</p> <ul style="list-style-type: none"> The BRIGHTNESS function can also be accessed using the BRIGHT buttons on the remote control (27) or via the EASY MENU (33).
CONTRAST	<p>Using the ▲/▼ cursor buttons adjusts the picture.</p> <p>Stronger ⇄ Weaker</p> <p>- NOTE -</p> <ul style="list-style-type: none"> The CONTRAST function can also be accessed using the CONTRAST buttons on the remote control (27) or via the EASY MENU (33).
GAMMA	<p>This projector provides 4 pre-set modes and 4 custom gamma modes.</p> <p>To select a mode</p> <p>Using the ▲/▼ cursor buttons in the GAMMA menu changes the gamma mode. The mode that the yellow highlight bar is on is the currently selected mode.</p> <p>STANDARD ⇄ LOW ⇄ HIGH ⇄ Hi-CONTRAST</p> <p>CUSTOM-1 ⇄ CUSTOM-2 ⇄ CUSTOM-3 ⇄ CUSTOM-4</p> <p> </p> <ul style="list-style-type: none"> STANDARD Suitable for a wide range of sources. LOW This mode emphasizes the reproducibility of lower tones. HIGH This mode emphasizes the reality of the image. Hi-CONTRAST This mode emphasizes the contrast of the image. CUSTOM-1, CUSTOM-2, CUSTOM-3, CUSTOM-4 These modes can be customized based on one of the pre-set modes. <div style="text-align: right;"> </div>

(Continued on next page)

Advanced Menu (PICTURE menu)

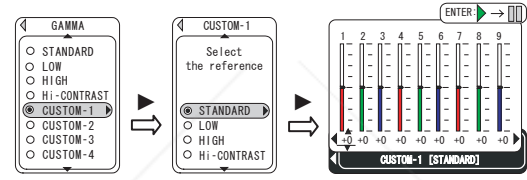
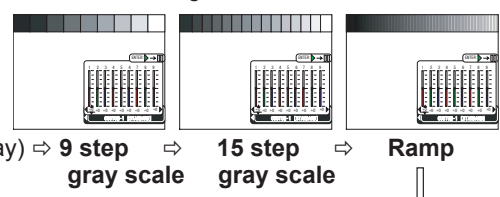
Item	Description
<p>Continuation of "GAMMA"</p>	<p>To adjust a CUSTOM mode</p> <p>(1) Select one of the CUSTOM modes to adjust using the ▲/▼ cursor buttons. Then press the ► cursor button to display the CUSTOM dialog.</p> <p>(2) Select the base mode to be adjusted using the ▲/▼ cursor buttons. Note that changing the base mode and pressing the ► cursor button in the CUSTOM dialog will erase the current settings of the selected mode. If you want to keep the settings, please press the ◀ cursor button to return to the preceding menu, and select a different CUSTOM mode. Then press the ► cursor button to display a dialog with 9 adjustment bars. Each bar corresponds to the tone of each of 9 gamma steps. The names of selected mode and the base mode are shown at the bottom of the dialog.</p>  <p>(3) Pressing the ENTER button while the dialog is displayed displays a test pattern to aid in adjusting. This projector has 3 types of test pattern. Each time you press the ENTER button, the test pattern is changed. Each part of the 9 step gray scale is linked to the corresponding adjustment bar in the dialog.</p>  <p>(4) Select the adjustment bar for the step to adjust using the ◀/► cursor buttons. Note that pressing the cursor ◀ button while the number 1 adjustment bar is selected closes the dialog and returns to the GAMMA menu.</p> <p>(5) Adjust the tone of the selected step using the ▲/▼ cursor buttons.</p>

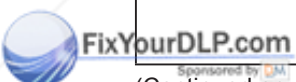

(Continued on next page)

Discount-Merchant.com (800) 281-8860
THE TRUSTED SOURCE FOR PROJECTOR LAMPS AND ACCESSORIES

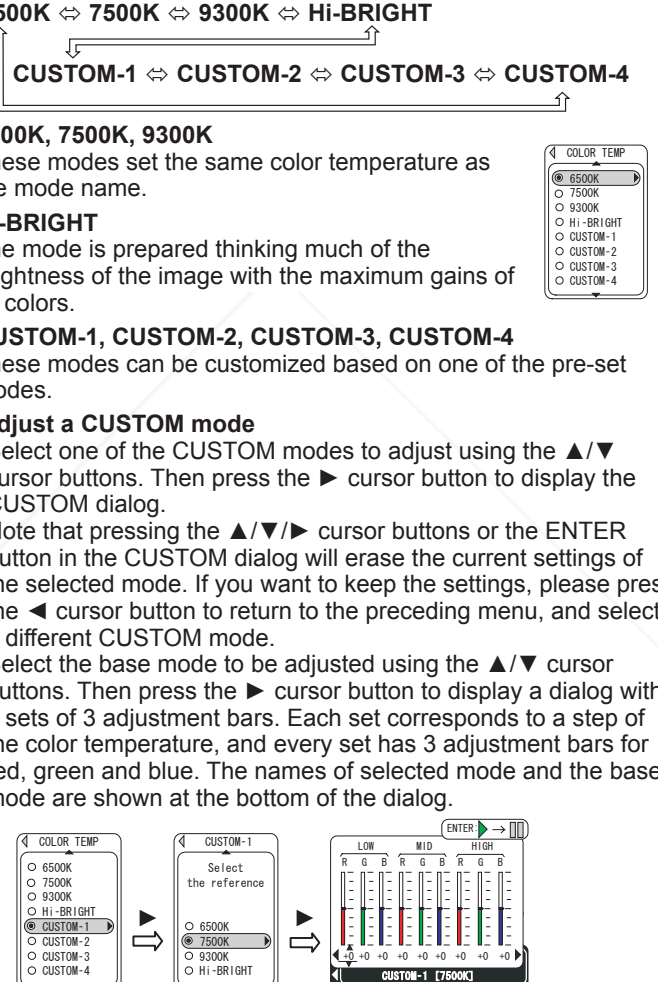
Item	Description
<p>COLOR TEMP</p>	<p>This projector provides 4 pre-set modes and 4 custom color temperature modes.</p> <p>To select a mode Using the ▲/▼ cursor buttons in the COLOR TEMP menu changes the color temperature mode. The mode that the yellow highlight bar is on is the currently selected mode.</p> <p>6500K ⇄ 7500K ⇄ 9300K ⇄ Hi-BRIGHT</p> <p>CUSTOM-1 ⇄ CUSTOM-2 ⇄ CUSTOM-3 ⇄ CUSTOM-4</p> <p>■ 6500K, 7500K, 9300K These modes set the same color temperature as the mode name.</p> <p>■ Hi-BRIGHT The mode is prepared thinking much of the brightness of the image with the maximum gains of all colors.</p> <p>■ CUSTOM-1, CUSTOM-2, CUSTOM-3, CUSTOM-4 These modes can be customized based on one of the pre-set modes.</p> <p>To adjust a CUSTOM mode</p> <p>(1) Select one of the CUSTOM modes to adjust using the ▲/▼ cursor buttons. Then press the ► cursor button to display the CUSTOM dialog.</p> <p>Note that pressing the ▲/▼/► cursor buttons or the ENTER button in the CUSTOM dialog will erase the current settings of the selected mode. If you want to keep the settings, please press the ◀ cursor button to return to the preceding menu, and select a different CUSTOM mode.</p> <p>(2) Select the base mode to be adjusted using the ▲/▼ cursor buttons. Then press the ► cursor button to display a dialog with 3 sets of 3 adjustment bars. Each set corresponds to a step of the color temperature, and every set has 3 adjustment bars for red, green and blue. The names of selected mode and the base mode are shown at the bottom of the dialog.</p> 



(Continued on next page)

Advanced Menu (PICTURE menu)

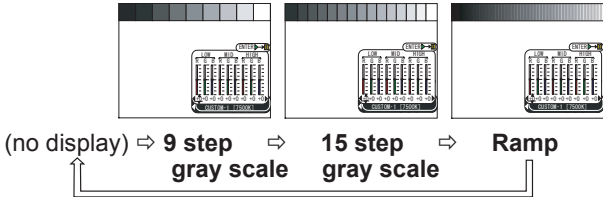
Item	Description
Continuation of "COLOR TEMP"	<p>(3) Pressing the ENTER button while the dialog is displayed displays a test pattern to aid in adjusting. This projector has 3 types of test pattern. Each time you press the ENTER button, the test pattern is changed. Each part of the 9 step gray scale is linked to the corresponding adjustment bar in the dialog.</p> <div style="text-align: center;">  <p>(no display) ⇒ 9 step gray scale ⇒ 15 step gray scale ⇒ Ramp</p> </div> <p>(4) Select the adjustment bar for the color element to adjust using the ◀/▶ cursor buttons. Note that pressing the cursor ◀ button while the adjustment bar of the LOW step's R is selected closes the dialog and turns it into the COLOR TEMP menu.</p> <p>(5) Adjust the tone of the selected step using the ▲/▼ cursor buttons.</p>
COLOR	<p>Using the ▲/▼ cursor buttons adjusts the picture. Stronger ⇔ Weaker</p> <p>- NOTE -</p> <ul style="list-style-type: none"> • The COLOR function can only be used for video, s-video, component video or HDMI signals. • The COLOR function can also be accessed using the COLOR buttons on the remote control (📄27) or via the EASY MENU (📄33).
TINT	<p>Using the ▲/▼ cursor buttons adjusts the picture. Greenish ⇔ Reddish</p> <p>- NOTE -</p> <ul style="list-style-type: none"> • The TINT function can only be used for video, s-video, component video or HDMI signals. • The TINT function can also be accessed via the EASY MENU (📄33).
SHARPNESS	<p>Using the ▲/▼ cursor buttons adjusts the picture. Stronger ⇔ Weaker</p> <p>- NOTE -</p> <ul style="list-style-type: none"> • The SHARPNESS function can also be accessed via the EASY MENU (📄33).

(Continued on next page)

Item	Description
IRIS	<p>Using the ▲/▼ cursor buttons adjusts the picture.</p> <p>Bright ⇄ Dark</p> <p>- NOTE -</p> <ul style="list-style-type: none"> The IRIS function can also be accessed using the IRIS button and ▲/▼ cursor buttons on the remote control (📖25).
BLACK	<p>Using the ▲/▼ cursor buttons changes the auto iris control mode as follows.</p> <p>TURN OFF ⇄ AUTO1 ⇄ AUTO2</p> <p style="text-align: center;">↑—————↑</p> <p>■ TURN OFF The auto iris is always open.</p> <p>■ AUTO1 The auto iris displays a better black for dark images.</p> <p>■ AUTO2 The auto iris displays the best black for dark images.</p> <p>- NOTE -</p> <ul style="list-style-type: none"> The screen may flicker when the AUTO1 or AUTO2 modes are selected. If this occurs, select TURN OFF. The BLACK function can also be accessed using the BLACK button and the ▲/▼ cursor buttons on the remote control (📖27) or via the EASY MENU (📖32).
MY MEMORY	<p>This projector provides 4 memories to save user adjustment settings. The brightness, contrast, color, tint, sharpness and iris adjustment settings, and selected modes for gamma, color temperature, black, whisper and digital shutter can be saved to each memory.</p> <p>To load saved adjustment settings</p> <p>Using the ▲/▼ cursor buttons in the MY MEMORY menu changes the memory to be adjusted, memories in which no data is saved are skipped. The mode that the yellow highlight bar is on is the currently selected mode. Then press the ► cursor button to load the selected mode.</p> <div style="float: right; border: 1px solid black; padding: 2px; text-align: center;"> <p>MY MEMORY</p> <p>1. CUSTOM-1</p> <p>2. CUSTOM-2</p> <p>3. CUSTOM-3</p> <p>4. CUSTOM-4</p> <p>SAVE</p> <p>MY MEMORY menu (small)</p> </div> <p style="text-align: center;">1. CUSTOM-1 ⇄ 2. CUSTOM-2 ⇄ 3. CUSTOM-3 ⇄ 4. CUSTOM-4 ⇄ SAVE</p> <p style="text-align: center;">↑—————↑</p> <p>- NOTE -</p> <ul style="list-style-type: none"> The numbers to the left of each memory cannot be changed but the name to the right can be changed. The SAVE item is not a memory but an item to display the MY MEMORY menu and save to the currently selected memory. Please refer to the following description about save. When a signal other than the signal used when the adjustment settings were registered is input, the saved adjustment settings may not display the signal image correctly.

(Continued on next page)

Advanced Menu (PICTURE menu)







Item	Description
<p>Continuation of "MY MEMORY"</p>	<p>To save adjustment settings</p> <p>(1) Load a base memory using the ▲/▼ cursor buttons in the MY MEMORY menu (small). When you want to use the current adjustment, do not load any other memories. Then press the ► cursor button to display the MY MEMORY menu (large).</p> <p>(2) The MY MEMORY menu (large) shows the name of the current memory and the adjustment settings to be saved. Check the adjustment settings, and go to step (5) to save if no adjustments are necessary.</p> <p>(3) If you want to adjust some of the items, please select an item to adjust using the ▲/▼ cursor buttons. Then press the ► cursor button to display the menu or dialog for adjusting the item. Make adjustments according to the description of each item. After making adjustments, press the ◀ cursor button to return to the MY MEMORY menu (large).</p> <p>(4) If you want to change the name of the memory, select the NAME item using the ▲/▼ cursor buttons. Then press the ► cursor button to display the NAME dialog. The current name is displayed on the 1st line in the menu. The letter in the name that the cursor is on can be changed using the ▲/▼/◀/► cursor buttons to move the cursor in the lower part of the menu. Press the ENTER button to move the cursor onto the next letter in the name, and press the RESET button to move the cursor onto the previous letter in the name.</p> <p>(5) Select the SAVE item in the MY MEMORY (large) menu using the ▲/▼ cursor buttons. Then press the ► cursor button to display the SAVE dialog. Confirm that the memory you want to save the adjustment settings to is selected. Use the ▲/▼ cursor buttons to change the selected memory. Press the ENTER button to save the current adjustment settings to the selected memory.</p>  

IMAGE menu

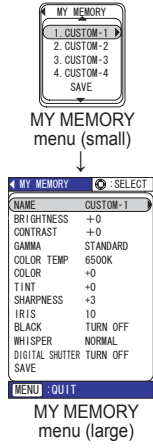
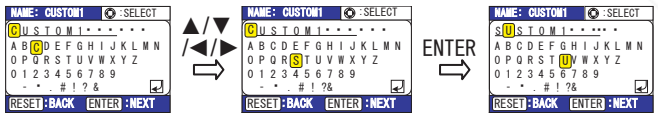
The following functions are accessible via the IMAGE menu. After selecting an item according to the procedure described in the preceding "Advanced Menu operation" section (35), refer to the following table for details on operating the selected item.

MENU [COMPUTER]		:SELECT
PICTURE	ASPECT	4:3
IMAGE	OVER SCAN	5
INPUT	V POSITION	25
SETUP	H POSITION	142
SCREEN	H PHASE	16
OPTION	H SIZE	1344
EASY MENU	AUTO ADJUST	

ENGLISH

Item	Description
ASPECT	<p>Using the ▲/▼ cursors buttons changes the aspect ratio.</p> <ul style="list-style-type: none"> For a computer (RGB) signal NORMAL ⇄ 4:3 ⇄ 16:9  For an HDMI signal NORMAL ⇄ 4:3 ⇄ 16:9 ⇄ WIDE ⇄ MOVIE1 ⇄ MOVIE2 ⇄ 14:9  For a video, s-video or component video signal 4:3 ⇄ 16:9 ⇄ WIDE ⇄ MOVIE1 ⇄ MOVIE2 ⇄ 14:9  For no signal or an unrecognized signal 16:9 (fixed) <div style="display: flex; justify-content: space-around; margin-top: 10px;"> 4:3 16:9 WIDE MOVIE1 MOVIE2 14:9 </div> <p>Example for a 16:9 signal </p> <p>Example for a 4:3 signal </p> <p>- NOTE -</p> <ul style="list-style-type: none"> The NORMAL mode uses the signal's original aspect ratio. Performing an automatic adjustment initializes the aspect ratio setting. The ASPECT function can also be accessed using the ASPECT button on the remote control (24) or via the EASY MENU (31).
	<p>Using the ▲/▼ cursor buttons adjusts the over-scan ratio.</p> <p>Large (Reduces the picture) ⇄ Small (Magnifies the picture)</p> <p>- NOTE -</p> <ul style="list-style-type: none"> The OVER SCAN function can only be used for video, s-video, component video or HDMI signals. When this adjustment is too large, certain degradation may appear on the border of the picture. If this occurs, readjust. The numbers displayed in the dialog and the IMAGE menu, are just for your reference, and might not be the exact display ratio.



Discount-Monitors.com 281-8860
 THE TRUSTED SOURCE FOR PROJECTOR LAMPS AND ACCESSORIES

(Continued on next page)

Advanced Menu (IMAGE menu)

Item	Description
V POSITION	Using the ▲/▼ cursor buttons adjusts the vertical position of the picture. Up ⇄ Down - NOTE - • The V POSITION cannot be adjusted for signals from the HDMI port.
H POSITION	Using the ▲/▼ cursor buttons adjusts the horizontal position of the picture. Left ⇄ Right - NOTE - • The H POSITION cannot be adjusted for signals from the HDMI port.
H PHASE	Using the ▲/▼ cursor buttons adjusts the horizontal phase to eliminate flicker. Right ⇄ Left - NOTE - • The H PHASE can be adjusted only for computer (RGB) signals excluding SCART RGB signals, or component video signals excluding 525i (480i) and 625i (576i) signals.
H SIZE	Using the ▲/▼ cursor buttons adjusts the horizontal size of the picture. Large ⇄ Small - NOTE - • The H SIZE can be adjusted only for computer (RGB) signals excluding SCART RGB signals. • When this adjustment is excessive, the picture may not be displayed correctly. If this occurs, please reset the adjustment by pressing the RESET button while using this item.
AUTO ADJUST	This function is performed as soon as the ► cursor button is pressed to select this item. ■ For a signal from the COMPUTER port The vertical position, the horizontal position, the horizontal phase, horizontal size and the aspect ratio are automatically adjusted. Make sure that the application window is set to its maximum size before attempting to use this feature. A dark picture may be incorrectly adjusted. Use a bright picture when adjusting. ■ For a signal from the HDMI port The aspect ratio is automatically adjusted. ■ For a signal from the COMPONENT VIDEO ports The vertical position, horizontal position and aspect ratio are automatically adjusted. The horizontal phase is also automatically adjusted except for 525i (480i), 625i (576i) and SCART RGB signals. ■ For a signal from the S-VIDEO or VIDEO port The video format best suited for the respective input signal is automatically selected. This function is available only when the VIDEO FORMAT item in the INPUT menu (46) is set to AUTO. The vertical position, horizontal position and aspect ratio are automatically adjusted. - NOTE - • The automatic adjustment operation takes approximately 10 seconds. Automatic adjustment may not function correctly with some input signals.

INPUT menu

The following functions are accessible via the INPUT menu. After selecting an item according to the procedure described in the preceding "Advanced Menu operation" section (35), refer to the following table for details on operating the selected item.

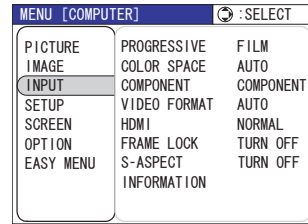

Item	Description
PROGRESSIVE	<p>Using the ▲/▼ cursor buttons in the PROGRESSIVE menu changes the interpolation mode of an interlaced signal.</p> <p>TV ⇄ FILM ⇄ TURN OFF</p> <p>↑</p> <ul style="list-style-type: none"> ■ TV This mode makes the screen image crisper. ■ FILM This mode makes the screen image crisper, and this mode can also be adapted to the 3-2 Pull-Down system. <p>- NOTE -</p> <ul style="list-style-type: none"> • The PROGRESSIVE function can only be used for interlaced video, s-video, or component video 525i (480i) or 625i (576i) 1125i (1080i) signals. • The TV and FILM modes may cause certain picture defects (ex., jagged lines). If this occurs, select TURN OFF, although the screen image may lose its crispness.
COLOR SPACE	<p>Using the ▲/▼ cursor buttons changes the color space mode.</p> <p>AUTO ⇄ RGB ⇄ SMPTE240 ⇄ REC709 ⇄ REC601</p> <p>↑</p> <ul style="list-style-type: none"> ■ AUTO Automatically selects an optimum mode. ■ RGB, SMPTE240, REC709, REC601 The selected color space is used. <p>- NOTE -</p> <ul style="list-style-type: none"> • The COLOR SPACE function can only be used for signals from the COMPUTER, HDMI or COMPONENT VIDEO ports excluding component video 525i (480i) or 625i (576i), or SCART RGB signals. • The AUTO mode may not work well for some signals. In this situation select a suitable mode other than AUTO.



(Continued on next page)

Discount-Merchant.com (800) 281-8860
THE TRUSTED SOURCE FOR PROJECTOR LAMPS AND ACCESSORIES

Item	Description
S-ASPECT	<p>Using the ▲/▼ cursor buttons turns the S-ASPECT function on and off.</p> <p>TURN ON ⇔ TURN OFF</p> <p>When the S-ASPECT function is enabled S2-video signals can be detected and an optimum aspect ratio automatically selected.</p> <p>- NOTE -</p> <ul style="list-style-type: none"> • When the ASPECT button on the remote control is used or the ASPECT item in the IMAGE menu ( 43) is used, this item is automatically disabled.
INFORMATION	<p>This function is performed as soon as the ► cursor button is pressed to select this item. It displays the INFORMATION dialog that shows the currently selected signal input.</p> <p>Example for computer (RGB) signals</p> <div style="display: flex; justify-content: space-around;"> <div style="border: 1px solid black; padding: 2px; text-align: center;">◀ INPUT - INFORMATION COMPUTER 1024x768 @85</div> <div style="border: 1px solid black; padding: 2px; text-align: center;">◀ INPUT - INFORMATION COMPUTER 1024x768 @60 FRAME LOCK</div> <div style="border: 1px solid black; padding: 2px; text-align: center;">◀ INPUT - INFORMATION COMPUTER 1080i @60</div> </div> <p>Example for an HDMI signal</p> <div style="display: flex; justify-content: space-around;"> <div style="border: 1px solid black; padding: 2px; text-align: center;">◀ INPUT - INFORMATION HDMI 1920x1080i @60</div> <div style="border: 1px solid black; padding: 2px; text-align: center;">◀ INPUT - INFORMATION HDMI 1920x1080i @60 FRAME LOCK</div> </div> <p>Example for a video, s-video and component video signal</p> <div style="display: flex; justify-content: space-around;"> <div style="border: 1px solid black; padding: 2px; text-align: center;">◀ INPUT - INFORMATION VIDEO NTSC AUTO</div> <div style="border: 1px solid black; padding: 2px; text-align: center;">◀ INPUT - INFORMATION S-VIDEO PAL AUTO</div> <div style="border: 1px solid black; padding: 2px; text-align: center;">◀ INPUT - INFORMATION COMPONENT 1080i @60</div> </div> <p>Example for a SCART RGB signal</p> <div style="border: 1px solid black; padding: 2px; text-align: center; margin: 0 auto; width: fit-content;">◀ INPUT - INFORMATION COMPONENT 576i @50 SCART RGB</div> <p>- NOTE -</p> <ul style="list-style-type: none"> • The INFORMATION function cannot be used when there is no signal.

SETUP menu

The following functions are accessible via the SETUP menu. After selecting an item according to the procedure described in the preceding "Advanced Menu operation" section (35), refer to the following table for details on operating the selected item.

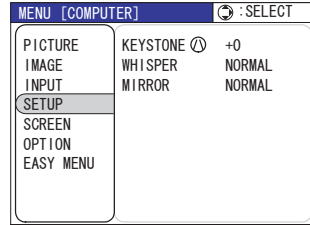

Item	Description
KEYSTONE	<p>Using the ▲/▼ cursor buttons adjusts the vertical keystone. Please make adjustments while checking the picture.</p> <p>Reduce top of the image ⇔ Reduce bottom of the image</p> <p>- NOTE -</p> <ul style="list-style-type: none"> The adjustable correction range will vary among different inputs. This function may not work well for some types of input. This function may not work well if the projector screen is angled up or down and the MIRROR item (34 Below) in the SETUP sub-menu is set to V:INVERT or H&V:INVERT.
WHISPER	<p>Using the ▲/▼ cursor buttons turns the WHISPER function on and off.</p> <p>NORMAL ⇔ WHISPER</p> <p>When WHISPER is selected, acoustic noise and screen brightness are reduced. It may take several minutes for the change in brightness to occur.</p> <p>- NOTE -</p> <ul style="list-style-type: none"> The WHISPER function cannot be used for several minutes after the projector lamp first lights up.
MIRROR	<p>Using the ▲/▼ cursor changes the mirror mode.</p> <div style="text-align: center;"> <p>NORMAL ⇔ H:INVERT ⇔ V:INVERT ⇔ H&V:INVERT</p> </div> <p>- NOTE -</p> <ul style="list-style-type: none"> The MIRROR function can also be accessed via the EASY MENU (33).

SCREEN menu

The following functions are accessible via the SCREEN menu. After selecting an item according to the procedure described in the preceding "Advanced Menu operation" section (35), refer to the following table for details on operating the selected item.





MENU [COMPUTER]		:SELECT
PICTURE	LANGUAGE	ENGLISH
IMAGE	MENU POSITION	
INPUT	OSD BRIGHT.	5
SETUP	START UP	ORIGINAL
SCREEN	MyScreen	
OPTION	MyScreen Lock	TURN OFF
EASY MENU	MESSAGE	TURN ON
	DIGITAL SHUTTER	TURN ON

ENGLISH

Item	Description
LANGUAGE	<p>Using the ▲/▼ cursor buttons changes the display language.</p> <p>ENGLISH ⇔ FRANÇAIS ⇔ DEUTSCH ⇔ ESPAÑOL</p> <p>ITALIANO ⇔ NORSK ⇔ NEDERLANDS ⇔ PORTUGUÊS</p> <p>日本語 ⇔ 简体中文 ⇔ 繁體中文 ⇔ 한글</p> <p>SVENSKA ⇔ РУССКИЙ ⇔ SUOMI ⇔ POLSKI ⇔ TÜRKÇE</p> <p>- NOTE -</p> <ul style="list-style-type: none"> The LANGUAGE function can also be accessed via the EASY MENU (34).
MENU POSITION	<p>Using the ▲/▼/◀/▶ cursor buttons adjusts the menu position. Please make adjustments while checking the picture.</p> <p>- NOTE -</p> <ul style="list-style-type: none"> Pressing the MENU button closes the dialog and returns to the SCREEN menu. Not operating the menu for about 50 seconds closes merely the dialog.
OSD BRIGHT.	<p>Using the ▲/▼ cursor buttons adjusts the brightness of the OSD. (OSD = On-Screen Display and refers to menus and dialogs.)</p> <p>Bright ⇔ Dark</p>

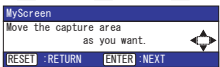
(Continued on next page)

Advanced Menu (SCREEN menu)



Item	Description
START UP	<p>Using the ▲/▼ cursor buttons changes the start up image that is displayed when no signal or an unsuitable signal is detected.</p> <p style="text-align: center;">MyScreen ↔ ORIGINAL ↔ TURN OFF</p> <p style="text-align: center;">↑—————↓</p> <ul style="list-style-type: none"> ■ MyScreen MyScreen is a feature which allows you to save a screenshot to use in place of the default screen. Please refer to the description of MyScreen (📖 Below) for information on saving a screen using the MyScreen function. Until a screenshot is registered a plain blue screen is displayed as the MyScreen image. ■ ORIGINAL When ORIGINAL is selected a factory pre-set start up screen is displayed. ■ TURN OFF When TURN OFF is selected a plain black screen is displayed. <p>- NOTE -</p> <ul style="list-style-type: none"> • To prevent burn-in (burned in afterimage) the MyScreen and ORIGINAL screens will switch to a plain black screen after several minutes.
MyScreen	<p>This projector has a MyScreen function which allows the user to save a portion of an image to be used as the START UP image by following the procedure below. See the description of START UP (📖 above) for information on selecting a START UP image.</p> <p>First, input the signal and display the image you wish to save. Then, in the SCREEN menu select the MyScreen item and press the ENTER button or the ► cursor button.</p> <p>(1) The "Do you start capturing this picture?" dialog will be displayed. Press the ENTER button and the dialog will change and a frame to select the portion of the image to save will appear..</p> <p>(2) Use the ▲/▼/◀/▶ cursor buttons to move the frame and select the portion of the image you wish to save, then press the ENTER button. The projector will then begin saving the image (may take several minutes).</p> <p>(3) When the operation ends, a dialog will appear informing you of the result.</p> <p style="text-align: center;">Registration successful screen: ...</p> <p style="text-align: center;">Error screen:</p> <p>- NOTE -</p> <ul style="list-style-type: none"> • The KEYSTONE cannot be adjusted while using the MyScreen function. <div style="display: flex; justify-content: space-between; align-items: flex-start;"> <div style="width: 60%;">  <p style="text-align: center;">↓</p>  <p style="text-align: center;">↓</p>  <p style="text-align: center;">↓</p>  <p style="text-align: center;">↓</p>  </div> <div style="width: 35%; font-size: small;"> <p>MyScreen</p> <p>Do you start capturing this picture? RESET NO ENTER YES</p> <p>MyScreen</p> <p>Move the capture area as you want. RESET RETURN ENTER NEXT</p> <p>MyScreen</p> <p>45%</p> <p>MyScreen registration is finished.</p> <p>A capturing error has occurred. Please try again.</p> </div> </div>

(Continued on next page)

Item	Description
MyScreen Lock	<p>Using the ▲/▼ cursor buttons turns the MyScreen Lock function on and off.</p> <p>TURN ON ⇔ TURN OFF</p> <p>When TURN ON is selected the MyScreen function is locked. Use this feature to protect the current MyScreen image.</p>
MESSAGE	<p>Using the ▲/▼ cursor buttons turns the MESSAGE function on and off.</p> <p>TURN ON ⇔ TURN OFF</p> <p>When TURN ON is selected, the following messages will be displayed. When you want to hide messages, select TURN OFF.</p> <ul style="list-style-type: none"> ■ The adjustment dialog that is displayed when the BRIGHTNESS, CONTRAST or COLOR is adjusted using the BRIGHTNESS, CONTRAST or COLOR buttons on the remote control ■ The dialogue that is displayed when the BLACK mode is changed using the BLACK button on the remote control ■ The dialogue that is displayed when the MODE is changed using the MODE button on the remote control ■ The "AUTO IN PROGRESS" message displayed during automatic adjustment ■ The "NO INPUT IS DETECTED" message displayed when no input is detected ■ The "SYNC IS OUT OF RANGE" message displayed when an improper input is detected ■ The "Detecting..." message displayed when the projector is detecting an input signal ■ The dialogue that is displayed when the input signal has been changed ■ The dialogue that is displayed when the aspect ratio has been changed

(Continued on next page)

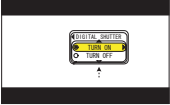
Advanced Menu (SCREEN menu)



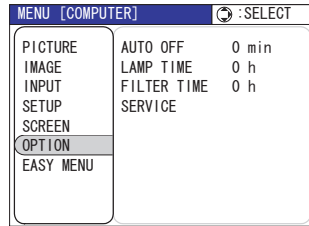

Item	Description
DIGITAL SHUTTER	<p>Using the ▲/▼ cursor buttons turns the DIGITAL SHUTTER function on and off.</p> <p>TURN ON ⇔ TURN OFF</p> <p>When TURN ON is selected, the black bars displayed mask the top and bottom of the screen, like a shutter. Use this function when you want to mask the top and bottom of the screen. Follow the procedure below to move the bars up and down.</p> <p>To move the black bars up and down</p> <ol style="list-style-type: none"> (1) Select TURN ON in the DIGITAL SHUTTER menu, then press the ► cursor button. The DIGITAL SHUTTER dialog will appear. (2) Using the ◀/▶ cursor buttons switches between the dialogs <div style="text-align: center;">  <p>↙ DIGITAL SHUTTER menu ↘ (one way)</p> <p>Dialog for the top bar ⇔ Dialog for the bottom bar</p> <div style="display: flex; justify-content: space-around;">   </div> </div> <ol style="list-style-type: none"> (3) Using the ▲/▼ cursor buttons in the dialogs moves the corresponding bar up or down. Note that the total height of the bars is limited.

OPTION menu

The following functions are accessible via the OPTION menu. After selecting an item according to the procedure described in the preceding "Advanced Menu operation" section (35), refer to the following table for details on operating the selected item.



ENGLISH

Item	Description
AUTO OFF	<p>Using the ▲/▼ cursor buttons adjusts the amount of time after which the projector off is automatically turned off.</p> <p>Long (max. 99 min.) ⇔ Short (min. 0 min.)</p> <div style="display: flex; justify-content: space-around;">   </div> <p>If no signal or an unsuitable signal is detected for the time set on this menu, the projector lamp will turn off and the power indicator will blink orange.</p> <p>Please see "Turning the power off" (23) to complete the process.</p>
LAMP TIME	<p>LAMP TIME is displayed in the OPTION menu as a reference value of the usage time of the lamp. The time displayed is the total time the lamp has been used since the LAMP TIME was last reset. Only reset the LAMP TIME item when you have replaced the lamp so that the LAMP TIME remains accurate.</p> <p>Pressing the ▲ cursor button in the LAMP TIME menu resets the LAMP TIME.</p> <div style="text-align: right;">  </div> <p>RESET ⇔ CANCEL</p> <p>- NOTE -</p> <ul style="list-style-type: none"> • Please see "Lamp" (57) for information on lamp replacement.
FILTER TIME	<p>FILTER TIME is displayed in the OPTION menu as a reference value of the usage time of the air filter. The time displayed is the total time the filter has been used since the FILTER TIME was last reset.</p> <p>Only reset the FILTER TIME item when you have cleaned or replaced the air filter so that the FILTER TIME remains accurate.</p> <p>Pressing the ▲ cursor button in the FILTER TIME menu resets the FILTER TIME.</p> <div style="text-align: right;">  </div> <p>RESET ⇔ CANCEL</p> <p>- NOTE -</p> <ul style="list-style-type: none"> • Please see "Air filter" (58) for information on cleaning and replacing the air filter. • The FILTER MESSAGE that prompts you to clean the air filter "REMINDER..." is displayed based on the FILTER TIME value. <p>Please reset the FILTER TIME when the filter is cleaned or changed so that the message displays correctly.</p>

(Continued on next page)

Advanced Menu (OPTION menu)

Item	Description
SERVICE	<p>The projector has some additional functions as follows.</p> <p>Select an item using the ▲/▼ cursor buttons in the SERVICE menu, and press the cursor ► button. Then a dialog or sub-menu will appear.</p> <p>FAN SPEED ⇔ GHOST ⇔ STRIPE</p> <p>⇕</p> <p>FACTORY RESET ⇔ FILTER MESSAGE</p> <p>FAN SPEED</p> <p>Using the ▲/▼ cursor buttons changes the rotation speed of the built-in cooling fans.</p> <p>HIGH ⇔ NORMAL</p> <p>The HIGH mode is for use at high elevations.</p> <p>- NOTE -</p> <ul style="list-style-type: none"> • HIGH mode may shorten the lifetime of the lamp. Except for use at high elevations, please use the NORMAL mode. • Note that the projector is noisier when HIGH is selected. <p>GHOST</p> <p>If a ghost image appears, the following adjustment may resolve it.</p> <p>(1) Select a color element using the ◀/▶ cursor buttons in the GHOST menu.</p> <p>R (Red) ⇔ G (Green) ⇔ B (Blue)</p> <p>(2) Adjust the selected color using ▲/▼ cursor buttons to remove the ghost image.</p> <p>STRIPE</p> <p>Vertical stripes may appear on the screen with some signals. This is not a hardware failure but a phenomenon common to LCD panels. The following procedure may improve the stripes, although it may not correct them completely.</p> <p>Make adjustments while referring to the test pattern displayed in the background of the menu or dialog.</p> <p>(1) Select a color element using the ▲/▼ cursor buttons in the STRIPE menu.</p> <p>R (Red) ⇔ G (Green) ⇔ B (Blue)</p> <p>(2) Press the ► cursor button and a dialog will appear.</p> <p>(3) Select H or L using the ◀/▶ cursor buttons.</p> <p>L (Dark side) ⇔ H (Bright side)</p> <p>(4) Adjust the tone of selected color using the ▼/▲ cursor buttons to improve the stripes.</p> <p>Be sure to make adjustments for every color element.</p>

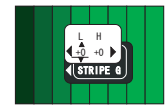
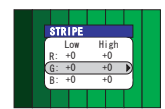
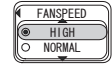
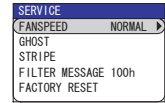

(Continued on next page)



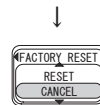
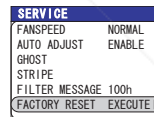
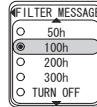



Item	Description
<p>Continuation of "SERVICE"</p>	<p>(Continuation of "STRIPE".)</p> <p>- NOTE -</p> <ul style="list-style-type: none"> KEYSTONE cannot be adjusted while using the STRIPE .function. <p>FILTER MESSAGE</p> <p>Using the ▲/▼ cursor buttons changes the amount of time til the projector will display the filter message ("REMINDER...") (61) that prompts you to clean the air filter.</p> <p>50h ⇄ 100h ⇄ 200h ⇄ 300h ⇄ TURN OFF</p> <p>When 50h, 100h, 200h or 300h is selected, the filter message will appear after the FILTER TIME (53) has reached the selected time.</p> <p>Choosing TURN OFF in the FILTER MESSAGE menu displays a confirmation dialog. Note that the filter message will not appear when TURN OFF is selected.</p> <p>Pressing the ENTER button selects TURN OFF.</p> <p>If you want to change the selection, press the RESET button while the dialog is displayed to return to the FILTER MESSAGE menu.</p> <p>- NOTE -</p> <ul style="list-style-type: none"> Check and clean the air filter periodically, even if no message is displayed. If the air filter becomes blocked by dust or other debris, the internal temperature will rise, which could cause projector malfunction, or reduce the lifetime of the projector. Please be careful of the operating environment of the projector and the condition of the air filter, especially when the 200h, 300h or TURN OFF options are selected. <p>FACTORY RESET</p> <p>This projector has a FACTORY RESET function to re-initialize all user settings simultaneously. Except where the current setting is always considered the default setting (LANGUAGE, MyScreen Lock, LAMP TIME, FILTER TIME etc.)</p> <p>Pressing the ▲ cursor button in the FACTORY RESET menu performs a FACTORY RESET.</p> <p>RESET ⇄ CANCEL</p>



ENGLISH

Maintenance

Lamp

 WARNING	 HIGH VOLTAGE	 HIGH TEMPERATURE	 HIGH PRESSURE
<p>► The projector uses a high-pressure mercury glass lamp. The lamp can <u>break with a loud bang, or burn out</u>, if jolted or scratched, handled while hot, or worn over time. Note that each lamp has a different lifetime, and some may burst or burn out soon after you start using them. In addition, when the bulb bursts, it is possible for <u>shards of glass</u> to fly into the lamp housing, and for <u>gas containing mercury</u> to escape from the projector's vent holes.</p>			
<p>► About disposal of a lamp • This product contains a mercury lamp; do not put it in a trash. Dispose of it in accordance with environmental laws. For lamp recycling, go to www.lamprecycle.org. (in the US) For product disposal, contact your local government agency or www.eiae.org (in the US) or www.epsc.ca (in Canada). For more information, call your dealer.</p>			
 <p>Disconnect the plug from the power outlet</p>	<ul style="list-style-type: none"> • If the lamp should break (it will make a loud bang when it does), unplug the power cord from the outlet, and make sure to request a replacement lamp from your local dealer. Note that shards of glass could damage the projector's internals, or cause injury during handling, so please do not try to clean the projector or replace the lamp yourself. • If the lamp should break (it will make a loud bang when it does), ventilate the room well, and make sure not to breathe the gas that comes out of the projector vents, or get it in your eyes or mouth. • Before replacing the lamp, turn the projector off and unplug the power cord, then wait at least 45 minutes for the lamp to cool sufficiently. Handling the lamp while hot can cause burns, as well as damaging the lamp. 		
	<ul style="list-style-type: none"> • Never unscrew except the appointed (marked by an arrow) screws. • Do not open the lamp cover while the projector is suspended from above. This is dangerous, since if the lamp's bulb has broken, the shards will fall out when the cover is opened. In addition, working in high places is dangerous, so ask your local dealer to have the lamp replaced even if the bulb is not broken. • Do not use the projector with the lamp cover removed. At the lamp replacing, make sure that the screws are screwed in firmly. Loose screws could result in damage or injury. 		
	<ul style="list-style-type: none"> • Use only the lamp of the specified type. • If the lamp breaks soon after the first time it is used, it is possible that there are electrical problems elsewhere besides the lamp. If this happens, contact your local dealer or a service representative. • Handle with care: jolting or scratching could cause the lamp bulb to burst during use. • Using the lamp for long periods of time, could cause it dark, not to light up or to burst. When the pictures appear dark, or when the color tone is poor, please replace the lamp as soon as possible. Do not use old (used) lamps, this is a cause of breakage. 		

A lamp has a finite product life. Using the lamp for long periods of the time could cause the picture to become darker or the color tone to become poor. Note that each lamp has a different lifetime, and some may burst or burn out soon after you start using them.

Preparation of a new lamp and early replacement are recommended. To purchase a new lamp, contact your dealer and tell the lamp type number = **DT00665**.

1. Turn the projector off, and unplug the power cord. Allow the projector to cool for at least 45 minutes.
2. Prepare a new lamp. If the projector is mounted on the ceiling, or if the lamp has broken, ask the dealer to replace the lamp.

Replacing the lamp by yourself

3. After making sure that the projector has adequately cooled, slowly turn the projector over so that the bottom is facing up.
4. Loosen the lamp cover screw (marked by the arrow), then slide and lift the lamp cover.
5. Loosen the 2 lamp screws (marked by the arrow), and slowly lift the lamp by the handles. Be careful when handling the lamp. Breaking the lamp could cause injury and the release of gas containing mercury.
6. Insert the new lamp, and retighten the screws that were loosened in the previous step to lock it in place.
7. Slide the lamp cover into place, and retighten the lamp cover screw loosened in step 4.
8. Please reposition and reconnect the projector (📖 12-17). Then turn the projector on (📖 20).
9. Reset the LAMP TIME in the OPTION menu (📖 53).
 - (1) Press the MENU button to display a menu. If you are using the Advanced Menu skip the next step (2).
 - (2) To switch from the EASY MENU to the Advanced Menu, select the "Go To the Advanced Menu ..." item in the EASY MENU using the ▲/▼ cursor buttons, then press the ► cursor button. The Advanced Menu will appear.
 - (3) Select the "OPTION" item in the left column of the Advanced Menu using the ▲/▼ cursor buttons then press the ► cursor button.

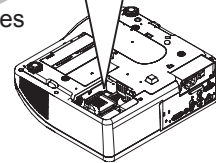
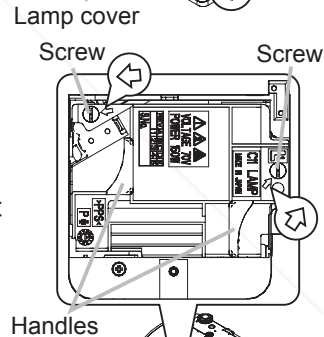
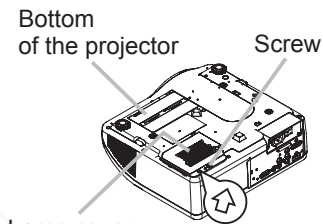

FixYourDLP.com
Sponsored by

DiscountMerchant.com (800) 281-8860
THE TRUSTED SOURCE FOR PROJECTOR LAMPS AND ACCESSORIES

Maintenance

- (4) Select the "LAMP TIME" item in the right column of the Advanced Menu using the ▲/▼ cursor buttons, then press the ► cursor button and the LAMP TIME menu will appear.
- (5) Pressing the ▲ cursor button in the menu resets the LAMP TIME.

NOTE • Only reset the LAMP TIME item when you have replaced the lamp so that the LAMP TIME remains accurate.

Air filter

If the air filter becomes clogged by dust or the like, internal temperatures will rise and could cause fire, burn and/or projector malfunction. When the indicators or a message prompts you to clean the air filter, make sure to clean it as soon as possible. Check and clean the air filter periodically, even if no message is displayed.

Please replace the air filter when it is damaged or too dirty to be cleaned. Preparation of a new air filter is recommended. To purchase a new air filter, contact your dealer and tell the air filter type number = **NJ22632**.

Replace the air filter when the lamp is replaced. An air filter of the specified type will be included with replacement lamps for this projector.

1. Turn the projector off, and unplug the power cord. Allow the projector to sufficiently cool down.
2. After making sure that the projector has cooled adequately, remove the filter cover and air filter. Hold the knobs while lifting.
3. Use a vacuum cleaner to clean the air filter vent, the air filter and filter cover. Please replace the air filter when it is damaged or too dirty to be cleaned.
4. Set the cleaned or new air filter into place, and press the point between the 2 knobs.
5. Turn the projector on (📖20).

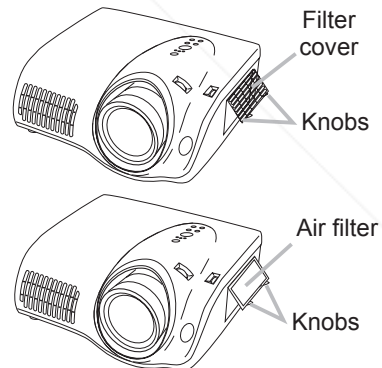

6. Reset the FILTER TIME in the OPTION menu (📖 53).
- (1) Press the MENU button to display a menu.
If you are using the Advanced Menu skip the next step (2).
 - (2) To switch from the EASY MENU to the Advanced Menu, select the “Go To the Advanced Menu ...” item in the EASY MENU using the ▲/▼ cursor buttons, then press the ► cursor button. The Advanced Menu will appear.
 - (3) Select the “OPTION” item in the left column of the Advanced Menu using the ▲/▼ cursor buttons then press the ► cursor button.
 - (4) Select the “FILTER TIME” item in the right column of the Advanced Menu using the ▲/▼ cursor buttons, then press the ► cursor button and the FILTER TIME menu will appear.
 - (5) Pressing the ▲ cursor button in the menu resets the FILTER TIME.

⚠ WARNING ► Do not maintain the projector during or immediately after use. Handling while the projector is hot could cause burn and/or projector malfunction. Before maintaining, make sure that the power switch is off, that the power cord is unplugged, and that the projector is adequately cool.

► Use only the specified air filter type. Do not use the projector with the air filter or the filter cover removed. Doing so could cause fire and/or projector malfunction.

► The air filter should be cleaned periodically. If the air filter becomes blocked by dust or other debris, the internal temperature will rise, which could cause burns, fire and/or projector malfunction, or reduce the lifetime of the projector.

NOTE • Please replace the air filter when it is damaged or too dirty to be cleaned, and also when the lamp is replaced.
• Only reset the FILTER TIME item when you have cleaned or replaced the air filter so that the FILTER TIME remains accurate (📖 53).
• The projector may display the message “CHECK THE AIR FLOW” or automatically turn the power off in order to prevent the internal heat level from rising.

Inside of the projector

In order to ensure the safety of your projector, please have it cleaned and inspected by your dealer about once a year.

Lens

In order to ensure the safety of your projector, please have it cleaned and inspected by your dealer about once a year.
If the lens is flawed, dirty or fogged, it could cause deterioration of display quality. Take special care of the lens and handle it carefully.

1. Turn the projector off, and unplug the power cord. Allow the projector to sufficiently cool down.
2. After making sure that the projector has adequately cooled, lightly wipe the lens with a commercially available lens-cleaning wipe. Do not touch the lens directly with your hand.

Cabinet and Remote control

Incorrect care could cause discoloration, peeling, etc.

1. Turn the projector off, and unplug the power cord. Allow the projector to sufficiently cool down.
2. After making sure that the projector has adequately cooled, lightly wipe with gauze or a soft cloth. If the projector is extremely dirty, dip a soft cloth in water or a neutral cleaner diluted in water, wring well, and wipe the projector lightly. Then, wipe lightly with a soft, dry cloth.

⚠ WARNING ▶ Do not maintain the projector during or immediately after use. Handling while the projector is hot could cause burn and/or projector malfunction. Before maintaining, make sure that the power switch is off, that the power cord is unplugged, and that the projector is adequately cool.

▶ Never try to maintain the inside of the projector yourself. Doing is so dangerous.

▶ Do not get the projector wet or insert liquids into the projector. It could result in fire, electric shock, and/or projector malfunction.

▶ Do not place anything containing liquid near the projector.

• Do not use aerosols or sprays on the projector.

⚠ CAUTION ▶ Properly maintain the projector according to the following. Incorrect care could cause injury, and/or discoloration, peeling, etc.

- Do not use cleaners or chemicals other than those specified in this manual.
- Do not polish or wipe the projector with hard objects.

Troubleshooting

Related messages

When the projector is turned on, the following messages may be displayed. When any such message is displayed on the screen, please follow the instructions described below. If the same message is displayed after trying the solutions below, or if a message other than the following appears, please contact your dealer or service company.

Although these messages will be automatically disappear after several minutes, they will reappear every time the power is turned on.

ENGLISH

Message	Description
<p>NO INPUT IS DETECTED ON ***</p>	<p>There is no input signal. Please confirm the input signal connection, and the status of the signal source.</p>
<p>SYNC IS OUT OF RANGE ON *** [fH] *****kHz [fV] *****Hz</p>	<p>The horizontal or vertical wavelength of the input signal is out of the response parameter range of this projector. Please confirm the specs for the projector and the signal source specs.</p>
<p>CHECK THE AIR FLOW</p>	<p>The internal temperature is high. Please turn the power off, and allow the projector to cool down for at least 20 minutes. After confirming the following items, please turn the power on again.</p> <ul style="list-style-type: none"> • Is there blockage of the air passage aperture? • Is the air filter dirty? • Does the peripheral temperature exceed 35°C? <p>If the same indication is displayed after trying the solutions above, please set the FAN SPEED of the SERVICE item in the OPTION menu to HIGH (M54).</p>
<p>REMINDER *** HRS PASSED AFTER THE LAST FILTER CHECK. FILTER MAINTENANCE IS ESSENTIAL TO REMOVE WARNING MESSAGE, RESET FILTER TIMER. SEE MANUAL FURTHER INFO</p>	<p>A note of precaution when cleaning the air filter. Please immediately turn the power off, and clean or change the air filter, according to the directions in "Air filter" (M58). After you have cleaned or changed the air filter, please be sure to reset the FILTER TIME (M53).</p>

Regarding the indicator lamps

The meanings of the lighting patterns of the POWER indicator, the LAMP indicator, and the TEMP indicator are described in the table below. Please follow the instructions within the table. If the same indication is displayed after trying the solutions below, or if an indication other than the following appears, please contact your dealer or service company.

POWER indicator	LAMP indicator	TEMP indicator	Description
Lit In Orange	Turned off	Turned off	The projector is in a standby state. Please refer to the “Turning the power on” (📖20) and “Turning the power off” (📖23).
<i>Blinking</i> Green	Turned off	Turned off	The projector is warming up. Please wait.
Lit In Green	Turned off	Turned off	The projector is on and ready. Ordinary operations may be performed.
<i>Blinking</i> Orange	Turned off	Turned off	The projector is cooling down. Please wait.
<i>Blinking</i> Red	(varies)	(varies)	The projector is cooling down. An error has been detected. Please wait until the POWER indicator finishes blinking, and then try the suggested solution, referring to the following error descriptions.
<i>Blinking</i> Red or Lit In Green	Lit In Red	Turned off	The lamp will not light, and there is a possibility that interior of the projector has overheated. Please turn the power off, and allow the projector to cool down for at least 20 minutes. After the projector has cooled down sufficiently, please confirm the following items, and then turn the power on again. <ul style="list-style-type: none"> • Is there blockage of the air passage aperture? • Is the air filter dirty? • Does the peripheral temperature exceed 35°C? If the same indication is displayed after trying the solutions above, please change the lamp according to the directions in “Lamp” (📖56, 57).

(Continued on next page)

Regarding the indicator lamps (continued)

POWER indicator	LAMP indicator	TEMP indicator	Description
Blinking Red or Lit In Red	Turned off	Blinking Red	<p>The cooling fan is not operating. Please turn the power off, and allow the projector to cool down for at least 20 minutes. After the projector has cooled down sufficiently, please confirm the following items, and then turn the power on again.</p> <ul style="list-style-type: none"> • Are any foreign objects caught in the fan? • Are there any magnetic objects on or near the projector? <p>Please ensure that installation configuration/usage of the projector does not allow any foreign materials to be caught, or disrupt the rotation of the cooling fans.</p>
Blinking Red or Lit In Red	Turned off	Lit In Red	<p>There is a possibility that the interior of the projector has overheated. Please turn the power off, and allow the projector to cool down for at least 20 minutes. After the projector has cooled down sufficiently, please confirm the following items, and then turn the power on again.</p> <ul style="list-style-type: none"> • Is there blockage of the air passage aperture? • Is the air filter dirty? • Does the peripheral temperature exceed 35°C? <p>If the same indication is displayed after trying the solutions above, please set the FAN SPEED of the SERVICE item in the OPTION menu to HIGH (📖54).</p>
Lit In Green	Alternative blinking Red		<p>There is a possibility that the interior of the projector has become too cool. Please use the projector within the usage temperature parameters (5°C to 35°C). After applying the solution set the power switch to ON.</p>
Lit In Green	Simultaneously blinking in Red		<p>It is time to clean the air filter. Please turn the power off immediately, and clean or change the air filter referring to the “Air Filter” (📖58) section. After cleaning or changing the air filter, please be sure to reset the filter timer. After applying the solution set the power switch to ON.</p>

ENGLISH

NOTE • When the interior of the projector overheats, the power source is automatically turned off for safety purposes, and the indicator lamps may also be turned off. If this occurs, set the power switch to the “O” (OFF) position, and wait at least 45 minutes. After the projector has cooled down sufficiently, please confirm that the lamp and lamp cover are properly fastened, and then turn the power on again.

Phenomena that may be easily mistaken as machine defects

Before requesting repair, please check the following chart. This will sometimes provide a solution to your problem.

If a situation cannot be resolved, the projector's microprocessor may need to be reset, or settings may be incorrect.

- To reset the microprocessor, turn the projector off once, and turn it on again (☞20). If the projector cannot be turned off, use the restart switch. Pressing the restart switch using a pin or similar object will restart the projector (☞7, 23).
- To reset all settings to the factory default, please use the FACTORY RESET item in the SERVICE menu which is in the OPTION menu (☞55).

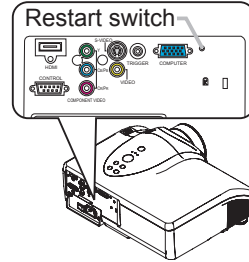

If the problem is not solved after performing maintenance, please contact your dealer or service company.

⚠ WARNING ► Never use the projector if there is any abnormality such as smoke, strange odor, excessive noise, damaged casing, elements or cables, penetration of liquids or foreign matter, etc. In such cases, immediately turn the power off and then disconnect the power plug from the power outlet. After making sure that the smoke or odor has stopped, contact your dealer or service company.

Phenomenon	Cases not involving a machine defect
Power does not come on.	The electrical power cord is not plugged in. Correctly connect the power cord (☞17).
	The power switch is not set to the on position. Set the power switch to [] (On position) (☞20).
	The main power source has been interrupted during operation by a power outage (blackout), etc. Please turn the power off (☞23), and allow the projector to cool down for at least 20 minutes. After the projector has cooled down sufficiently, please turn the power on again (☞20).
	Either the lamp or lamp cover has not been properly fastened. Please turn the power off (☞23), and allow the projector to cool down for at least 45 minutes. After the projector has sufficiently cooled down, confirm that the lamp and lamp cover are properly fastened (☞58). Then turn the power on again (☞20).
	The lens cover is closed. Remove the lens cover (☞6). The signal cables are not correctly connected. Correctly connect the connection cables (☞13-16).

(Continued on next page)

Phenomena that may be easily mistaken for machine defects (continued)

Phenomenon	Cases not involving a machine defect
No pictures are output.	<p>Signal source does not work correctly. Correctly set up the signal source device by referring to the manual for the source device.</p>
	<p>The brightness is adjusted to an extremely low level. Adjust the BRIGHTNESS (🔗27, 33, 37) to a higher level using the menu function or the remote control.</p>
	<p>The computer cannot detect the projector as a plug and play monitor. Confirm that the computer can detect a plug and play monitor using another plug and play monitor (🔗16).</p>
	<p>If the connected PC has a HDMI output, the driver software of the HDMI board is too old. Consult with your PC dealer to install new software.</p>
	<p>The signal source cannot output both a HDMI signal and a VGA signal simultaneously. Disconnect the VGA connection when you use the HDMI input (🔗14, 15).</p>
	<p>If the output signal can be selected on the PC, it is not selected properly. Check the settings. Select the digital output for HDMI connection.</p>
Colors have a faded-out appearance, or Color tone is poor.	<p>Color settings are not correctly adjusted. Perform picture adjustments by changing the COLOR TEMP (🔗39), COLOR (🔗27, 33, 40), TINT (🔗33, 40) and COLOR SPACE (🔗45).</p>
	<p>COLOR SPACE setting is not suitable. Change the COLOR SPACE (🔗45).</p>
Pictures appear dark.	<p>The brightness or contrast is adjusted to an extremely low level. Adjust the BRIGHTNESS (🔗27, 33, 37) and CONTRAST (🔗27, 33, 37) to a higher level.</p>
	<p>The WHISPER function is enabled. Set the WHISPER item (🔗48) in the SETUP menu to normal.</p>
	<p>The lamp is approaching the end of its product lifetime. Replace the lamp (🔗53, 57).</p>
Pictures appear blurry.	<p>Either the focus or horizontal phase setting is not properly adjusted. Check and adjust the focus (🔗22), and H PHASE (🔗44).</p>
	<p>The lens is dirty or fogged. Clean the lens according to the directions in "Lens" (🔗60).</p>

ENGLISH

(Continued on next page)



Discount-Merchant.com (800) 281-8860
THE TRUSTED SOURCE FOR PROJECTOR LAMPS AND ACCESSORIES

Troubleshooting

Phenomenon	Cases not involving a machine defect
Flicker appears on the screen.	AUTO1 or AUTO2 is selected for the BLACK mode. Please set the BLACK mode to TURN OFF using the BLACK button (🔑27) or the BLACK item in the PICTURE menu (🔑41).
	The WHISPER function is working. The WHISPER function may cause screen flicker. Set the WHISPER item (🔑48) in the SETUP menu to NORMAL.
Projector is very noisy.	The fan speed has been automatically changed. When the ambient temperature is, the projector will automatically raise the cooling fan speed to keep the internal temperature stable. Lower the ambient temperature. If you want to reduce noise more, set the WHISPER item (🔑48) in the SETUP menu to WHISPER.

NOTE • Although bright spots, dark spots, uneven color or misconvergence may appear on the screen, these are common characteristics of liquid crystal displays, and do not constitute or imply a machine defect.

Warranty and after-service

When a problem occurs with the equipment, first refer to “Troubleshooting” (62-66) and run through the suggested checks. If this does not resolve the problem, please contact your dealer or service company. They will tell you what warranty condition is applied.

ENGLISH

Specifications

Item		Specification
Product name		Liquid crystal projector
Liquid crystal panel	Panel size	1.8 cm (0.7 Type)
	Drive system	TFT active matrix
	Pixels	921,600 pixels (1280 horizontal x 720 vertical)
Lens		Zoom lens F=1.7 ~ 2.4 f = 20.0 ~ 31.9 mm
Lamp		150W UHB
Power Supply		AC100-120V/2.4A, AC220-240V/1.3A
Power Consumption		220W
Temperature range		5 ~ 35°C (Operating)
Size		340 (W) x 113 (H) x 299 (D) mm (Not including protruding parts)
Weight (mass)		4.7 kg
Ports		RGB input port: COMPUTER..... D-sub 15pin mini shrink jack x 1 Digital input port: HDMI HDMI connector x 1 Communication port: CONTROL D-sub 9pin plug x 1 Video input port: VIDEO RCA jack x 1 S-VIDEO Mini DIN 4pin jack x 1 COMPONENT VIDEO RCA jack x 3 Other port: TRIGGER (12V/25mA) x 1
Optional parts	Lamp	DT00665
	Air filter	NJ22632
	Others	• Please consult your dealer.

NOTE • These specifications are subject to change without notice.

Specifications

Dimension diagram

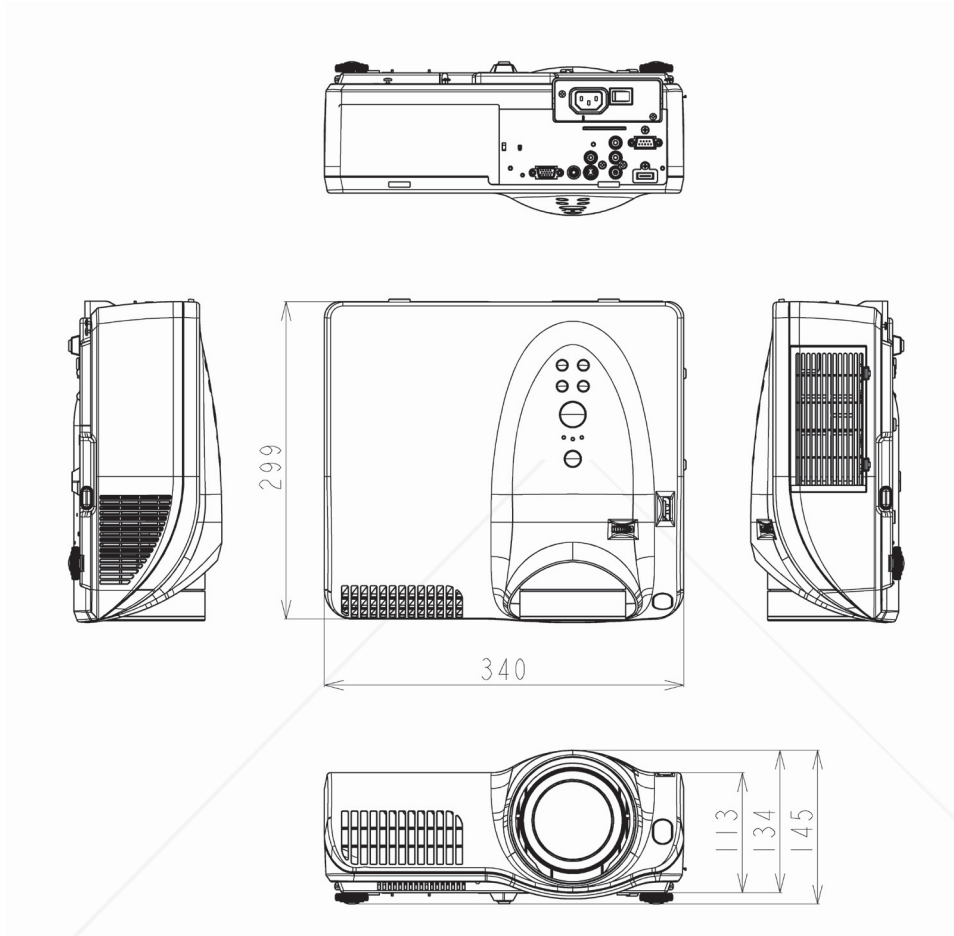

[unit: mm]

Glossary

Entry	Explanation	Page(s) in which the entry appears
3-2 Pull-Down	A system for converting a film source such as a movie into a video signal.	45
Color space	A standard for determining color value.	45
Color temperature	A system for expressing a color of light Refers to the luminance of white which a display device radiates. A higher color temperature expresses a more bluish color. A lower color temperature expresses a more reddish color.	28, 39, 41
Gamma	In this manual, "Gamma" refers to a gamma characteristic that is the state of brightness and darkness between the white level and the black level.	28, 37, 41
Ghost	A phenomenon where a double image is displayed. Generally caused by an RGB signal problem.	54
HDMI	HDMI stands for High Definition Multi-Media Interface which is an interface standard for transmission of digital images and audio signals.	1, 14, 15, 21, 24, 27, 31, 33, 40, 43, 44, 46, 47
Interlaced	Refers to interlaced scanning which is a system to scan twice alternately for one picture ↔ Progressive.	45
Iris	Refers to an iris diaphragm that is a mechanism to adjust the amount of light projected.	25, 27, 28, 41
Keystone	Trapezoidal image distortion. This manual refers to Keystone adjustment for the correction of trapezoidal image distortion caused by image projected onto a screen or wall which is not perpendicular to the projector lens.	48
NTSC	A standard for terrestrial analog broadcasting. Mainly adopted in Japan, North America, and South Korea.	46

(Continued on next page)



Sponsored by DM

Discount-Merchant.com (800) 281-8860
THE TRUSTED SOURCE FOR PROJECTOR LAMPS AND ACCESSORIES

Glossary

Entry	Explanation	Page(s) in which the entry appears
PAL	A standard for terrestrial analog broadcasting. Mainly adopted in UK, Germany, China, Australia, et al.	46
Progressive	Refers to progressive scanning which is a system to scan in order. ↔ Interlaced	45
RGB (signal)	Output image signaling that displays image based on three primary colors, Red, Green, and Blue. It is also called Analog RGB. Both D-sub 15 pin and BNC are connection types for RGB signals.	15, 16, 24, 31, 43, 44, 46, 47
S2-video	A standard for signal interface. S2-video signals can include a signal of a 4:3 image, squeezed 16:9 image or letterbox 4:3 image.	47
SCART	A type of audio-video equipment connector. 21 pin trapezoidal connector which is connected with an RGB signal, Video signal, or 2ch audio signal. Widespread in Europe.	14, 21, 44, 45, 46, 47
SECAM	A standard for terrestrial analog broadcasting. Mainly adopted in France, Russia, et al.	40, 46

HITACHI

Inspire the Next

Hitachi America, Ltd. Digital Media Div.

Hitachi Plaza 2000 Sierra Point Parkway
Brisbane, CA 94005-1835 **USA**
Tel: +1 -800-225-1741
Fax: +1 -650-244-7776

► <http://www.hitachi.us/digitalmedia>

Hitachi Canada, Ltd.

6740 Campobello Road, Mississauga
Ontario L5N2L8 **CANADA**
Tel: +1 -905-821-4545
Fax: +1 -905-821-1101

► <http://www.hitachi.ca>

Hitachi Europe Ltd.

Whitebrook Park, Lower Cookham Road
Maidenhead SL6 8YA, Berkshire **UK**
Tel: +44 1628 585000
Fax: +44 1628 643404

► <http://www.hitachidigitalmedia.com>

Hitachi Europe GmbH (Munich Office)

Dornacher Strasser 3.
85622 Feldkirchen bei Munchen **GERMANY**
Tel: +49 -89-991-80-0
Fax: +49 -89-991-80-224

SWITZERLAND

Hitachi Europe S.r.l.

Via T. Gulli, 39
20147 Milano **ITALY**
Tel: +39 -02-487861
Fax: +39 -02-48786381

Hitachi Europe S.A.S (Lyon Office)

B.P. 45
4 Allée des Sorbiers
69671 BRON CEDEX **FRANCE**
Tel: +33 -04-72-14-29-70
Fax: +33 -04-72-14-29-99

Hitachi Europe AB

Egebaekgaard, Egebaekvej 98
2850 Naerum **DENMARK**
Tel: +45 -43-43-60-50
Fax: +45 -43-43-60-51

Hitachi Europe S.A.

364 Klissias & 1 Delfon Str.
152 33 Chalandri **GREECE**
Tel: +30 -1-6837200
Fax: +30 -1-6835694

Hitachi Europe S.A.

Gran Via Carlos III, 86 planta 5ª
Edificios Trade - Torre Este
08028 Barcelona **SPAIN**
Tel: +34 -93-409-2550
Fax: +34 -93-491-3513

Hitachi Europe AB.

Haukadalsgatan 10
S-164 94 Kista **SWEDEN**
Tel: +46 -8-562-711-00
Fax: +46 -8-562-711-11

Hitachi Europe AB.

Strandveien 18
N-1366 Lysaker **NORWAY**
Tel: +47 -6-751-903-8
Fax: +47 -3-339-390-0

Hitachi Europe AB.

Lars Sonckin kaari 16
FIN-026000 ESPOO **FINLAND**
Tel: +358 10 8503085
Fax: +358 10 8503086

Hitachi Europe

Bergensesteenweg 421
1600 Sint-Pieters-Leeuw **BELGIUM**
Tel: +32 -236-39901
Fax: +32-236-39900

Hitachi Europe Ltd.

Na Sychrove 975/8
101 27 Praha 10- Bohdalec **CZECH REPUBLIC**
Tel: +420 -267-212-383
Fax: +420 -267-212-385

Hitachi Europe Ltd. (Moscow office)

Millenium House
12 Trubnaya Street
Moscow 103045 **RUSSIA**
Tel: +7 -95-787-4020
Fax: +7 -95-787-4021

Hitachi Home & Life Solutions, Inc.

Middle East Office

LOB 14-136,
PO BOX 18008
Jebel Ali Free Zone,
Dubai - **U.A.E.**
Tel: +30 -1-6837200
Fax: +30 -1-6835694



FixYourProjector.com

Disc.com Merchant.com (800) 281-8860

THE TRUSTED SOURCE FOR PROJECTOR LAMPS AND ACCESSORIES



Disclaimer

This user manual is provided as a free service by FixYourDLP.com. FixYourDLP is in no way responsible for the content of this manual, nor do we guarantee its accuracy. FixYourDLP does not make any claim of copyright and all copyrights remain the property of their respective owners.

About FixYourDLP.com

FixYourDLP.com (<http://www.fixyourdpl.com>) is the World's #1 resource for media product news, reviews, do-it-yourself guides, and manuals.

Informational Blog: <http://www.fixyourdpl.com>

Video Guides: <http://www.fixyourdpl.com/guides>

User Forums: <http://www.fixyourdpl.com/forum>

FixYourDLP's Fight Against Counterfeit Lamps:

<http://www.fixyourdpl.com/counterfeits>

Sponsors:

RecycleYourLamp.org – Free lamp recycling services for used lamps:

<http://www.recycleyourlamp.org>

Lamp Research - The trusted 3rd party lamp research company:

<http://www.lampresearch.com>

Discount-Merchant.com – The worlds largest lamp distributor:

<http://www.discount-merchant.com>



FixYourDLP.com

Sponsored by 