



# Disclaimer

This user manual is provided as a free service by FixYourDLP.com. FixYourDLP is in no way responsible for the content of this manual, nor do we guarantee its accuracy. FixYourDLP does not make any claim of copyright and all copyrights remain the property of their respective owners.

About FixYourDLP.com

FixYourDLP.com (<http://www.fixyourdlp.com>) is the World's #1 resource for media product news, reviews, do-it-yourself guides, and manuals.

Informational Blog: <http://www.fixyourdlp.com>

Video Guides: <http://www.fixyourdlp.com/guides>

User Forums: <http://www.fixyourdlp.com/forum>

FixYourDLP's Fight Against Counterfeit Lamps:

<http://www.fixyourdlp.com/counterfeits>

## Sponsors:

RecycleYourLamp.org – Free lamp recycling services for used lamps:

<http://www.recycleyourlamp.org>

Lamp Research - The trusted 3rd party lamp research company:

<http://www.lampresearch.com>

Discount-Merchant.com – The worlds largest lamp distributor:

<http://www.discount-merchant.com>



**FixYourDLP.com**

Sponsored by 

# HITACHI

Liquid Crystal Projector

## CP-X870

(CP-X870W)

### USER'S MANUAL Vol.2 Extended

Please read this user's manual thoroughly to ensure correct usage through understanding.

### BEDIENUNGSANLEITUNG Teil 2 Fortsetzung

Bitte lesen Sie diese Benutzerhandbuch zugunsten der korrekten Bedienung aufmerksam.

### MANUEL D'UTILISATION Vol.2 Développé

Nous vous recommandons de lire attentivement ce manuel pour bien assimiler le fonctionnement de l'appareil.

### MANUALE D'ISTRUZIONI Vol.2 Ampliato

Vi preghiamo voler leggere attentamente il manuale d'istruzioni in modo tale da poter comprendere quanto riportato ai fini di un corretto utilizzo del proiettore.

### MANUAL DE USUARIO Vol.2 Ampliado

Lea cuidadosamente este manual del usuario para poder utilizar correctamente el producto.

### GEBRUIKSAANWIJZING Vol.2 Uitgebreid

Lees voor het gebruik alstublieft deze handleiding aandachtig door, om volledig profijt te hebben van de uitgebreide mogelijkheden.

### BRUKERHÅNDBOK Vol.2 Utvidet

Vennligst les denne bruksanvisningen grundig for å være garantert driftssikker bruk.

### INSTRUÇÕES DO PROPRIETÁRIO Vol.2 Continuação

Para assegurar o uso correto do equipamento, por favor leia atentamente este manual do utilizador.

### 使用说明书 卷2 应用篇

请仔细阅读本《用户操作手册》，在理解的基础上正确使用。

### 취급 설명서 제2권 응용편

이 유저 매뉴얼을 잘 읽으시고, 이해하신 후 정확하게 사용해 주십시오.

ENGLISH

DEUTSCH

FRANÇAIS

ITALIANO

ESPAÑOL

NEDERLANDS

NORSK

PORTGÊS

中文

한국어

TECHNICAL

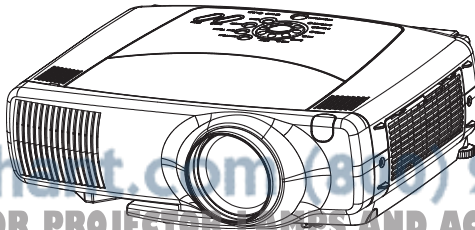

FixYourDLP.com  
Sponsored by DM

Discount-Merch.com (817) 281-050  
THE TRUSTED SOURCE FOR PROJECTOR LAMPS AND ACCESSORIES

Ⓐ

LCD Projector CP-X870

**USER'S MANUAL** Vol.1 (Basic)

Thank you for purchasing this projector.

**WARNING** • Please read the accompanying manual “SAFETY INSTRUCTIONS” and this “USER'S MANUAL” thoroughly to ensure correct usage through understanding. After reading, store this instruction manual in a safe place for future reference.

**NOTE** • The information in this manual is subject to change without notice.

- The manufacturer assumes no responsibility for any errors that may appear in this manual
- The reproduction, transmission or use of this document or contents is not permitted without express written authority.

**TRADEMARK ACKNOWLEDGEMENT :**

- PS/2, VGA and XGA are registered trademarks of the International Business Machines Corporation.
- Apple, Mac and ADB are registered trademarks of Apple Computer, Inc.
- VESA and SVGA are trademarks of the Video Electronics Standard Association.
- Windows is a registered trademark of Microsoft Corporation.
- All other trademarks are the property of their respective owners.

**CONTENTS**

	Page		Page
<b>PROJECTOR FEATURES</b> .....	2	<b>USING THE MAGNIFY</b>	
<b>PREPARATIONS</b> .....	2	<b>FEATURE</b> .....	22
<b>PART NAMES</b> .....	4	<b>FREEZING THE SCREEN</b> .....	22
<b>SETTING UP</b>		<b>ADJUSTING SCREEN WITH</b>	
<b>THE PROJECTOR</b> .....	6	<b>ONE-TOUCH</b> .....	23
<b>CONNECTING</b>		<b>SELECTING THE ASPECT</b>	
<b>YOUR DEVICES</b> .....	8	<b>RATIO</b> .....	24
<b>USING THE REMOTE</b>		<b>TEMPORARILY BLANKING</b>	
<b>CONTROL</b> .....	13	<b>THE SCREEN</b> .....	24
<b>TURNING ON THE POWER</b> .....	15	<b>DISPLAYING CHILD WINDOW</b>	
<b>TURNING OFF THE POWER</b> .....	17	<b>(P. IN. P: Picture in Picture)</b> .....	24
<b>ADJUSTING THE VOLUME</b> .....	18	<b>USING THE MENU</b>	
<b>TEMPORARILY MUTING</b>		<b>FUNCTIONS</b> .....	25
<b>THE SOUND</b> .....	18	<b>OPERATING THE PC SCREEN</b> .....	26
<b>ADJUSTING THE POSITION</b> .....	19	<b>THE LAMP</b> .....	27
<b>USING THE AUTOMATIC</b>		<b>THE AIR FILTER</b> .....	29
<b>ADJUSTMENT FEATURE</b> .....	20	<b>OTHER CARE</b> .....	31
<b>CORRECTING KEystone</b>			
<b>DISTORTIONS</b> .....	21		

## PROJECTOR FEATURES

This liquid crystal projector is used to project various computer signals as well as NTSC / PAL / SECAM video signals onto a screen. Little space is required for installation and large images can easily be realized.

### ● Ultra High Brightness

Crisp, ultra-bright presentations is achieved by using a UHB (ultra high brightness) lamp and a highly efficient optical system

### ● One Touch Function

Just press the ONE TOUCH button to automatically retrieve input signals, calibrate images, and correct keystone distortion

### ● Partial Magnification Function

Interesting parts of images can be magnified for closer viewing

## PREPARATIONS

Your projector should come with the items shown below. Check to make sure that all the items are included. Contact your dealer if anything is missing.

**NOTE** • Keep the original packing material for future reshipment.

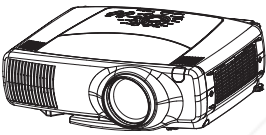

**Projector  
(with Lens Cap)**



**Power cord  
(US Type)**



**Power cord  
(UK Type)**

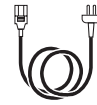

**Power cord  
(Europe Type)**



**User's Manuals  
(Vol.1/Vol.2)  
Safety Instructions**

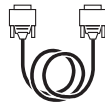

**RGB cable**



**Video/Audio cable**



**RS-232C  
adapter**



**Two AA batteries  
(for the remote  
control)**



**Remote control**



**Soft carrying case**



FixYourDLP.com

Sponsored by

Discount-Merch.com 1-800-81-8860

THE TRUSTED SOURCE FOR PROJECTOR LAMPS AND ACCESSORIES



**WARNING** Precautions to observe in regards to the power cord: Please use extra caution when connecting the projector's power cord as incorrect or faulty connections may result in FIRE AND/OR ELECTRICAL SHOCK. Please adhere to the following safety guidelines to insure safe operation of the projector:

- Only plug the power cord into outlets rated for use with the power cord's specified voltage range.
- Only use the power cord that came with the projector.
- NEVER ATTEMPT TO DEFEAT THE GROUND CONNECTION OF THE THREE-PRONGED PLUG!
- Make sure that you firmly connect the power cord to the projector and wall outlet.

## 1 Connect your devices to the projector

8 ~ 12

Connect your computer, VCR and/or other devices you will be using to the projector.

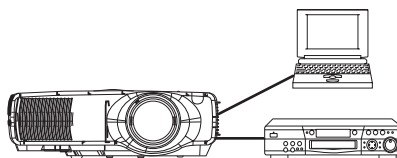

## 2 Insert the batteries into the remote control

13

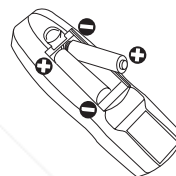

## 3 Connect the power cord

(1) Connect the connector of the electrical power cord to the AC inlet of the main unit.

(2) Firmly plug the power cord's plug into the outlet

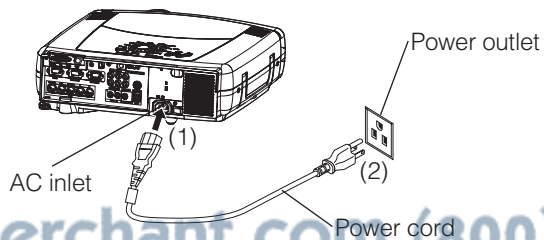

**PART NAMES**

**The Projector**

 Indicates the corresponding reference page

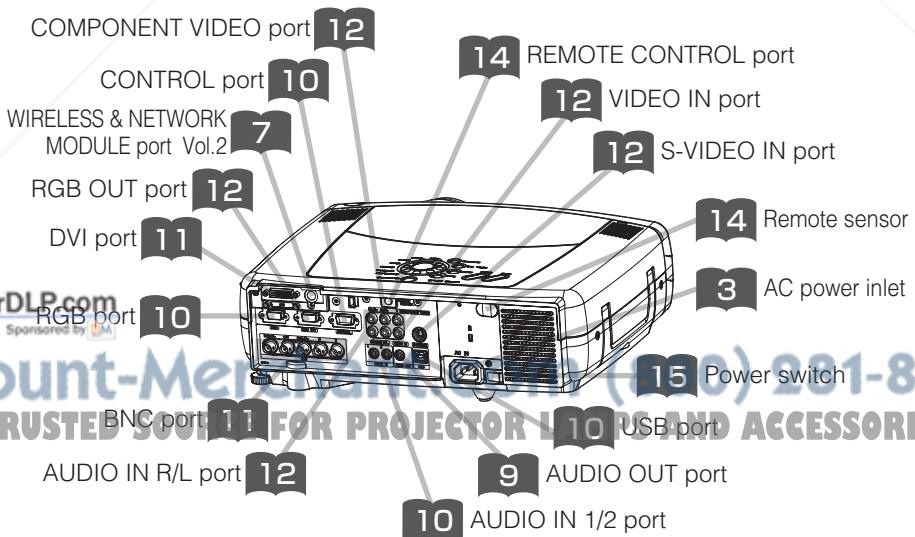
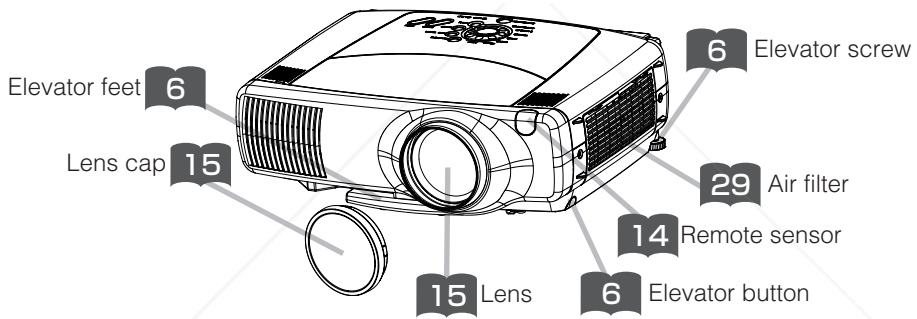
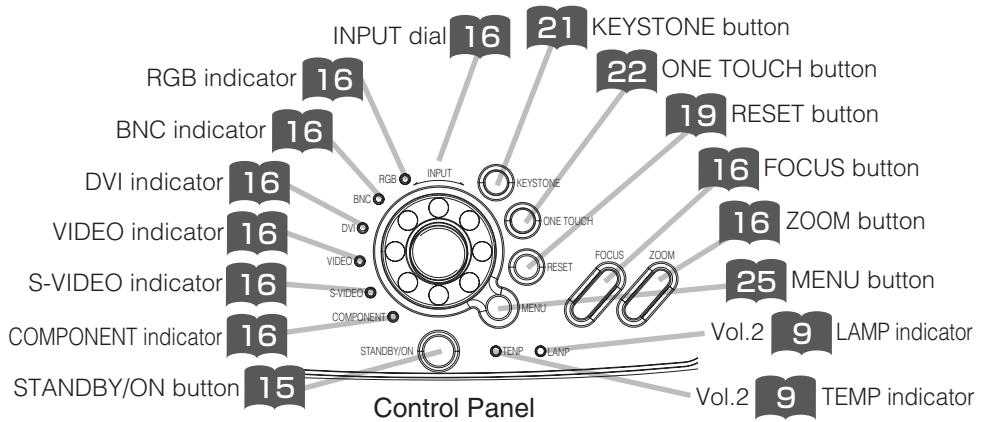

 FixYourDLP.com  
Sponsored by 

**Discount-Merchandise.com (800) 201-8860**  
**THE TRUSTED SOURCE FOR PROJECTOR PARTS AND ACCESSORIES**

# The Remote Control

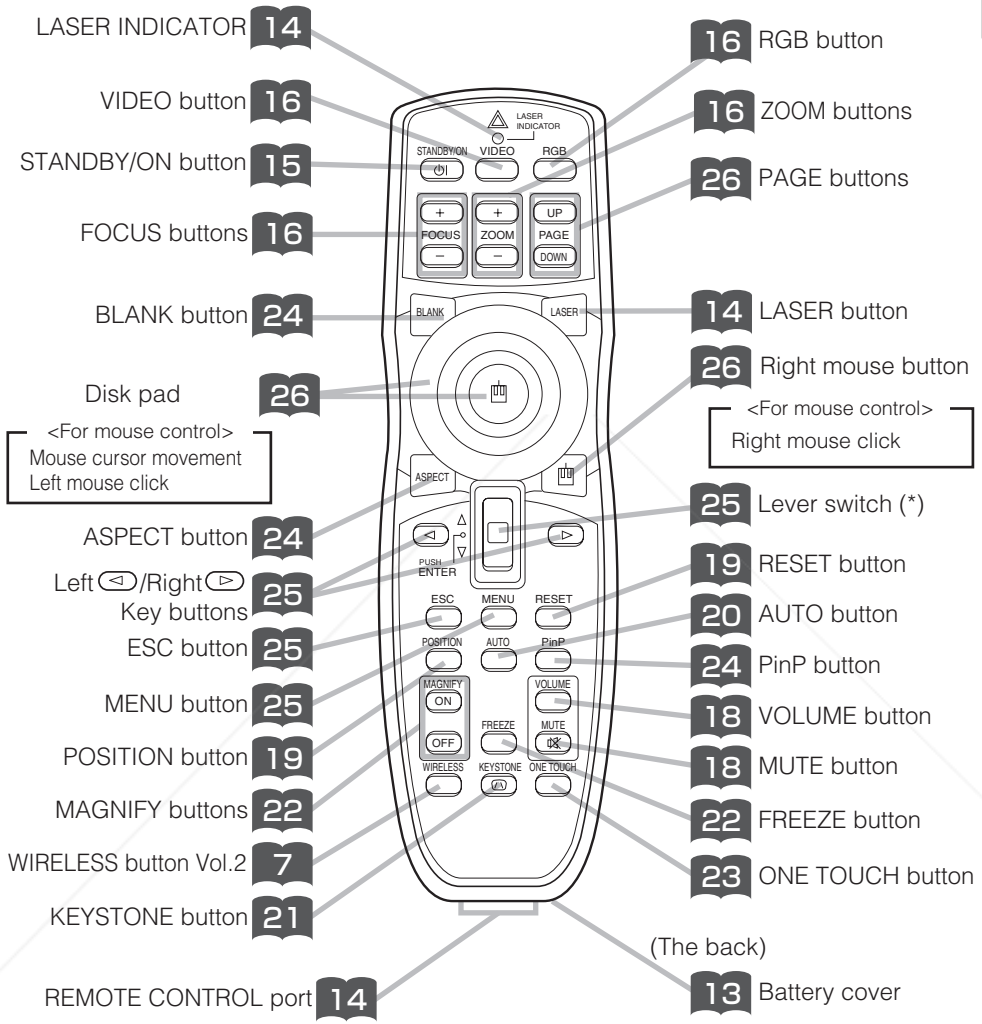

FixYourDLP.com

**\*Using the lever switch**

- Flip toward disk pad : Up (▲) key
- Flip toward MENU button : Down (▼) key
- Press in center : ENTER button

**Inside of the Battery cover**

**Laser switch**

- 1: enables the laser function.
- 2: disables the laser function.

## SETTING UP THE PROJECTOR

- CAUTION** • Install the projector in a suitable environment according to instructions of the accompanying manual "SAFETY INSTRUCTIONS" and this manual.
- If you press the elevator buttons without holding the projector, the projector might crash down, overturn, smash your fingers and possibly result in malfunction. To prevent damaging the projector and injuring yourself, ALWAYS HOLD THE PROJECTOR whenever using the elevator buttons to adjust the elevator feet.
  - An installation angle should be adjusted within the specified adjustment range. The adjustment beyond the range may become the cause of shortening the lamp life.

### Adjusting the Projector's Elevator Feet

If the surface on which the projector is placed, or the screen is tilted, use the elevator feet and elevator screw to adjust the projection angle of the main unit. The adjustment range of the elevator feet is 0 to 10 degrees.

#### 1 Press and hold in the elevator buttons

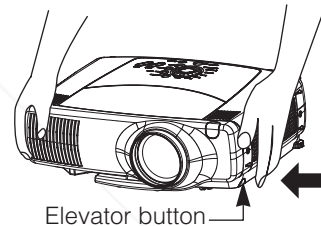

#### 2 Raise or lower the projector to the desired height and then release the elevator buttons

When you release the elevator buttons, the elevator feet will lock into position.

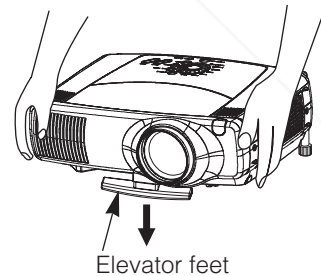

#### 3 Turn the elevator screw to fine tune.

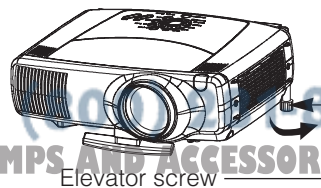

FixYourDLP.com

Sponsored by DM

Discount-Merchant.com (800) 2860

THE TRUSTED SOURCE FOR PROJECTOR LAMPS AND ACCESSORIES



## Adjusting the Screen Size and Projection Distance

Refer to the illustrations and tables below to determine the screen size and projection distance.

The values shown in the table are calculated for a full size screen

- a: Distance from the projector to the screen ( $\pm 10\%$ )
- b: Distance from the lens center to the bottom of the screen ( $\pm 10\%$ )
- c: Distance from the lens center to the top of the screen ( $\pm 10\%$ )

The screen

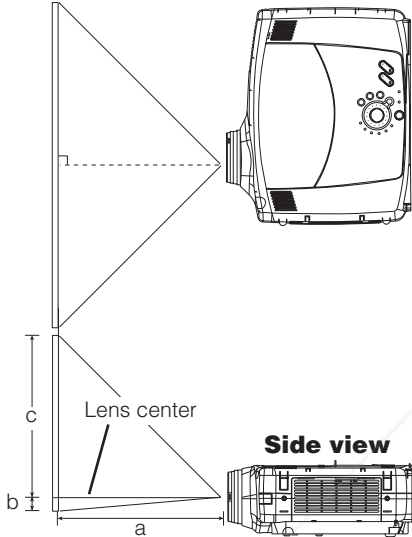

If 4:3 aspect ratio

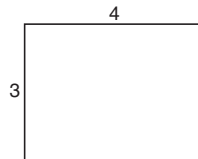

Screen Size [inch (m)]	a [inch (m)]		b [inch (cm)]	c [inch (cm)]
	Min.	Max.		
30 (0.8)	42 (1.1)	56 (1.4)	1 (2)	17 (44)
40 (1.0)	57 (1.4)	75 (1.9)	1 (3)	23 (58)
50 (1.3)	72 (1.8)	94 (2.4)	1 (4)	29 (73)
60 (1.5)	87 (2.2)	113 (2.9)	2 (4)	34 (87)
70 (1.8)	102 (2.6)	133 (3.4)	2 (5)	40 (102)
80 (2.0)	117 (3.0)	152 (3.9)	2 (6)	46 (116)
90 (2.3)	131 (3.3)	171 (4.3)	3 (7)	51 (131)
100 (2.5)	146 (3.7)	190 (4.8)	3 (7)	57 (145)
120 (3.0)	176 (4.5)	229 (5.8)	3 (9)	69 (174)
150 (3.8)	221 (5.6)	287 (7.3)	4 (11)	86 (218)
200 (5.0)	296 (7.5)	383 (9.7)	6 (15)	114 (290)
250 (6.3)	371 (9.4)	479 (12.2)	7 (18)	143 (363)
300 (7.5)	446 (11.3)	576 (14.6)	9 (22)	171 (435)

The screen

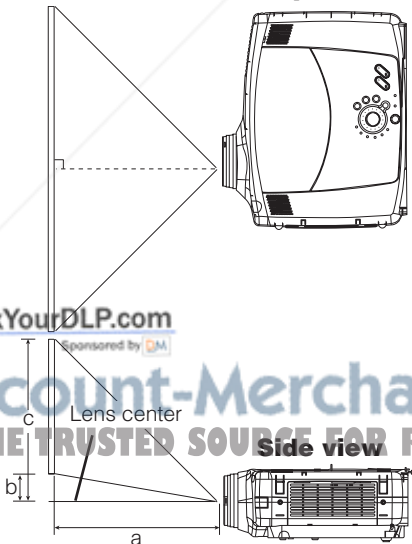

If 16:9 aspect ratio

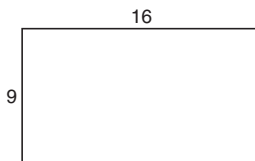

Screen Size [inch (m)]	a [inch (m)]		b [inch (cm)]	c [inch (cm)]
	Min.	Max.		
30 (0.8)	45 (1.2)	61 (1.5)	1 (4)	16 (41)
40 (1.0)	62 (1.6)	81 (2.1)	2 (5)	21 (54)
50 (1.3)	78 (2.0)	102 (2.6)	2 (6)	26 (67)
60 (1.5)	94 (2.4)	123 (3.1)	3 (7)	31 (79)
70 (1.8)	111 (2.8)	144 (3.7)	3 (8)	36 (92)
80 (2.0)	127 (3.2)	165 (4.2)	4 (9)	41 (105)
90 (2.3)	143 (3.6)	186 (4.7)	4 (11)	47 (119)
100 (2.5)	160 (4.1)	207 (5.3)	5 (12)	53 (135)
120 (3.0)	192 (4.9)	249 (6.3)	6 (14)	65 (166)
150 (3.8)	241 (6.1)	312 (7.9)	7 (18)	82 (207)
200 (5.0)	322 (8.2)	417 (10.6)	9 (24)	106 (270)
250 (6.3)	404 (10.3)	522 (13.3)	12 (29)	124 (315)
300 (7.5)	485 (12.3)	627 (15.9)	14 (35)	128 (324)

FixYourDLP.com  
Sponsored by DM

Discount-Merchant.com 866-860-8608  
THE TRUSTED SOURCE FOR PROJECTOR PARTS AND ACCESSORIES

## CONNECTING YOUR DEVICES

### ***Devices You Can Connect to the Projector (Refer to this section for planning your device configuration to use for your presentation.)***

**CAUTION** • Incorrect connecting could result in fire or electrical shock. Please read this manual and the separate "SAFETY INSTRUCTIONS".

- ATTENTION** Precautions to observe when connecting other devices to the projector
- Whenever attempting to connect other devices to the projector, please thoroughly read the manual of each device to be connected.
  - TURN OFF ALL DEVICES prior to connecting them to the projector. Attempting to connect a live device to the projector may generate extremely loud noises or other abnormalities that may result in malfunction and/or damage to the device and/or projector. Refer to the "TECHNICAL" of the USER'S MANUAL (Vol.2) for the pin assignment of connectors and RS-232C communication data.
  - Make sure that you connect devices to the correct port. Incorrect connection may result in malfunction and/or damage to the device and/or projector.
  - Some cables have to be used with core set. Use the accessory cable or a designated-type cable for the connection. For cables that have a core only at one end, connect the core to the projector.
  - Secure the screws on the connectors and tighten.

 Indicates the corresponding reference page

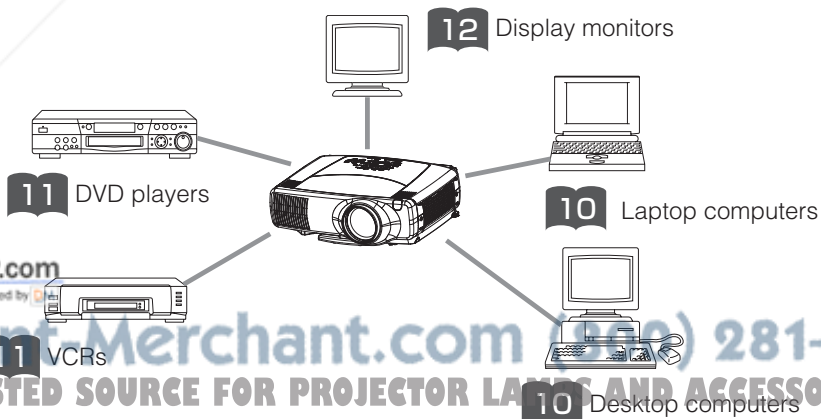

 FixYourDLP.com  
Sponsored by 

**Discount Merchant.com (800) 281-8860**  
THE TRUSTED SOURCE FOR PROJECTOR LAMP AND ACCESSORIES

## Ports and Cables

Refer to the table below to find out which projector port and cable to use for connecting a given device. Use this table for determining which cables to prepare.

Function	Projector Port	Connection Cables
Analog RGB input	RGB	RGB cable (With D-sub 15-pin shrink jack and inch thread screws)
	BNC(R/C <sub>R</sub> /P <sub>R</sub> )(G/Y)(B/C <sub>B</sub> /P <sub>B</sub> )(H)(V) • When BNC (RGB) is selected (*)	BNC cable
Analog output	RGB OUT	RGB cable (With D-sub 15-pin shrink jack and inch thread screws)
DVI input	DVI	DVI cable
Audio input from computer	AUDIO IN 1 • Linked to RGB or DVI port input	Audio/video cable (Stereo mini)
	AUDIO IN 2 • Linked to BNC (RGB) port input (*)	
USB mouse control	USB	USB cable
PS/2 mouse control	CONTROL	PS/2 mouse cable
ADB mouse control		ADB mouse cable
Serial mouse control		Serial mouse cable
RS-232C communications		RS-232C adapter + RS-232C cable
S video input	S-VIDEO IN	S-video cable (mini DIN 4-pin jack)
Video input	VIDEO IN	Audio/video cable
Component video input	COMPONENT(C <sub>R</sub> /P <sub>R</sub> )(C <sub>B</sub> /P <sub>B</sub> )(Y)	Component video cable
	BNC(R/C <sub>R</sub> /P <sub>R</sub> )(G/Y)(B/C <sub>B</sub> /P <sub>B</sub> ) • When BNC (COMPONENT) is selected (*)	
Audio input from video equipment	AUDIO IN R,L	Audio/video cable or audio cable (RCA jack)
Audio output	AUDIO OUT	Audio cable (Stereo mini)
Wired remote control signal input	REMOTE CONTROL	Audio cable (Stereo mini)

\* Before using the BNC port, change RGB input to component video input on the BNC menu item of the INPUT menu.

### NOTE: About Plug-and-Play Capability

- This projector is compatible with VESA DDC 1/2B. Plug-and-Play can be achieved by connecting this projector to computers that are VESA DDC (display data channel) compatible. Please take advantage of this function by connecting the accessory RGB cable to the RGB port (DDC 1/2B compatible). Plug-and-Play may not work properly if any other type of connection is attempted.
- Plug-and-Play is a system composed of the computer, its operating system and peripheral equipment (i.e. display devices).
- Please use the standard drivers as this projector is a Plug-and-Play monitor.

# CONNECTING YOUR DEVICES (continued)

## Connecting to a Computer

**ATTENTION** Whenever attempting to connect a laptop computer to the projector, be sure to activate the laptop's RGB external image output (set the laptop to CRT display or to simultaneous LCD and CRT display). For details on how this is done, please refer to the instruction manual of the corresponding laptop computer.

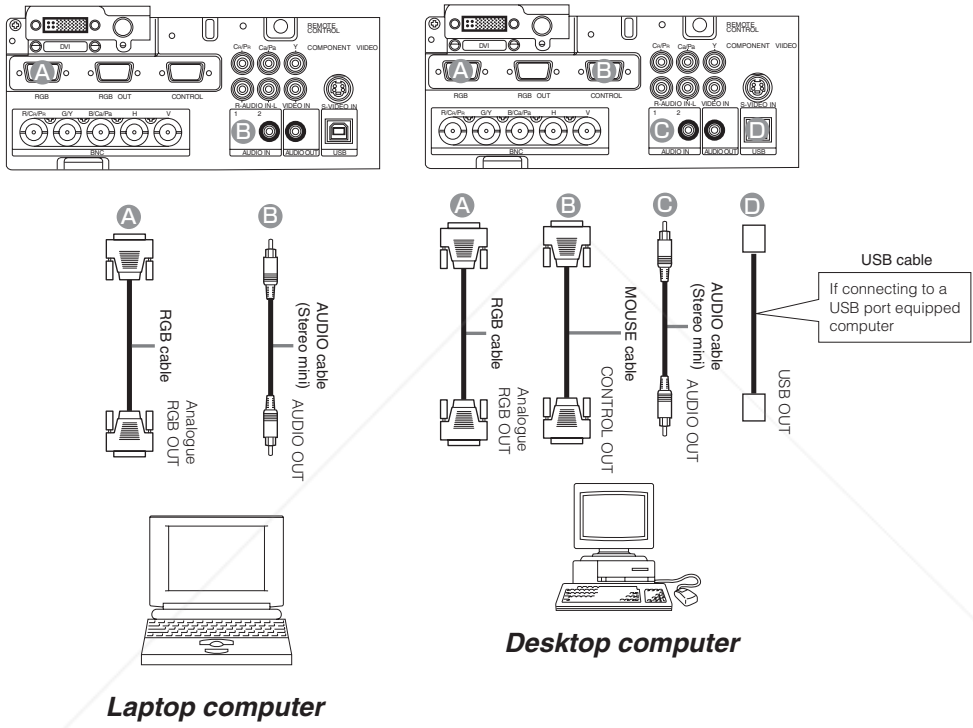

**NOTE**

- Some computers may have multiple display screen modes. Use of some of these modes will not be possible with this projector.
- For some RGB input modes, the optional Mac adapter is necessary.



**Discount-Merchant.com (800) 281-8860**  
THE TRUSTED SOURCE FOR PROJECTOR LAMPS AND ACCESSORIES

## Connecting to a Computer (continued)

### BNC Input

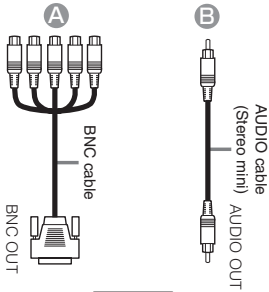
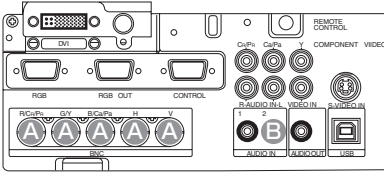

### DVI Input

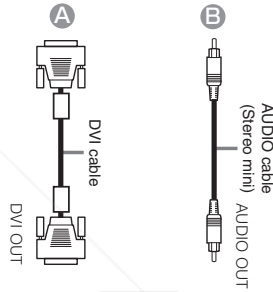
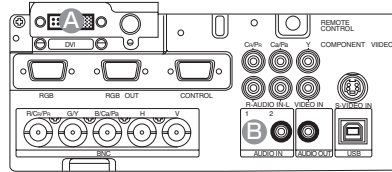

## CONNECTING YOUR DEVICES (continued)

### Connecting to a DVD Player

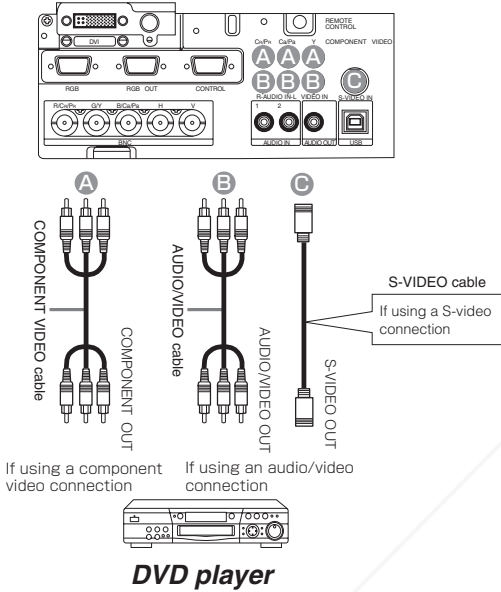

### Connecting to a VCR

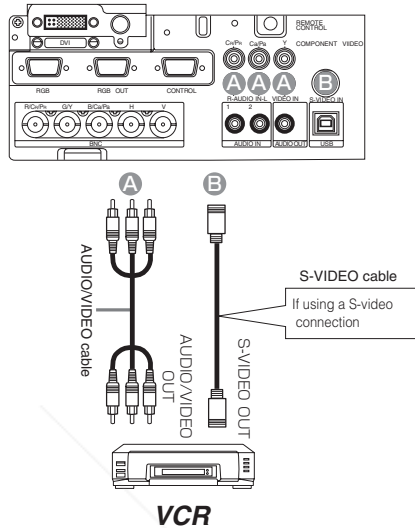

### Connecting to a Display Monitor

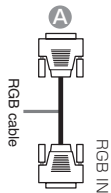
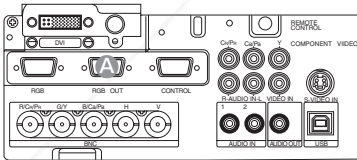

**Display monitor**

## USING THE REMOTE CONTROL

### **Putting batteries into the remote control unit**



#### **CAUTION** Precautions to observe in regards to the batteries

Always handle the batteries with care and use them only as directed. Improper use may result in battery cracking or leakage, which could result in fire, injury and/or pollution of the surrounding environment.

- Keep the battery away from children and pets.
- Be sure to use only the batteries specified for use with the remote control. Do not mix new batteries with used ones.
- When inserting batteries, verify that the plus and minus terminals are aligned correctly (as indicated in the remote control).
- When you dispose the battery, you should obey the law in the relative area or country.

**1**

#### **Remove the battery cover**

Slide back and remove the battery cover in the direction of the arrow.

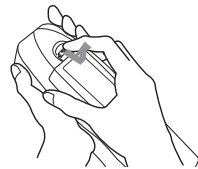
**2**

#### **Insert the batteries**

Align and insert the two AA batteries (that came with the projector) according to their plus and minus terminals (as indicated in the remote control).

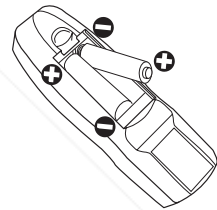
**3**

#### **Close the battery cover**

Replace the battery cover in the direction of the arrow and snap it back into place.

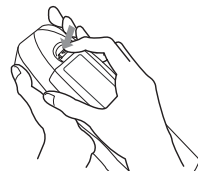

## USING THE REMOTE CONTROL (continued)

### Operating the remote control

- ⚠ **WARNING** • The laser pointer of the remote control transmitter is used in place of a finger or rod. Never look directly into the laser beam outlet or point the laser beam at other people. The laser beam can cause vision problems.
- ⚠ **CAUTION** • Use of controls or adjustments or performance of procedures other than those specified herein may result in hazardous radiation exposure.

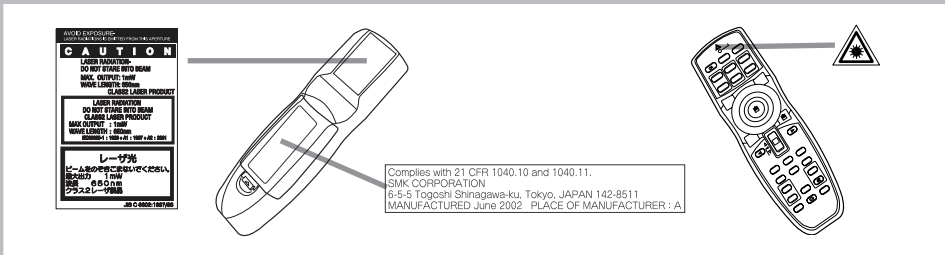

This remote control has the switch to disable the laser function. Refer to "The Remote Control".

- The remote control works with both the projector's front and rear remote sensors.
- The range of the remote sensor on the front is 3 meters with a 60-degree range (30 degrees to the left and right of the remote sensor), and back is 3 meters with a 40-degree range.
- Since the remote control uses infrared light to send signals to the projector (Class 1 LED), be sure to use the remote control in an area free from obstacles that could block the remote control's output signal to the projector.
- The wired remote control:

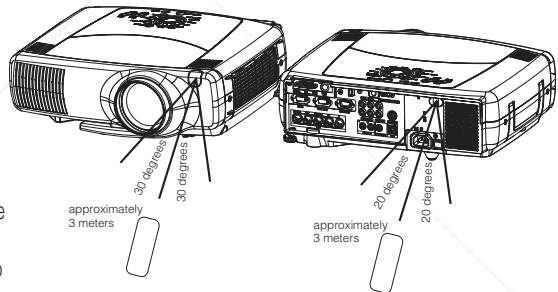

You can use the remote control as a wired remote control, by connecting the REMOTE CONTROL ports of the main unit and remote control via an audio cable (3.5 dia. stereo mini cable with plugs).

### ATTENTION Precautions to observe when using the remote control

- Do not disassemble the remote control.
- Do not drop or otherwise expose the remote control to physical impact.
- Do not get the remote control wet or place it on wet objects. Doing so may result in malfunction.
- Do not place the remote control near the projector's lens, fan, or vents.
- Remove the batteries from the remote control and store them in a safe place if you won't be using the remote control for an extended period.
- Replace the batteries whenever the remote control starts to malfunction.
- When strong light, such as direct sunlight or light from an extremely close range (such as from an inverter fluorescent lamp), hits the projector's remote sensor, the remote control may cease to function. Adjust the direction of the projector to keep light from directly hitting the projector's remote sensor.



## TURNING ON THE POWER

### Precautions

Connect all devices to be used to the projector prior to turning on the power.

8 ~ 12

**WARNING** When the power is ON, a strong light is emitted. Do not look into the lens.

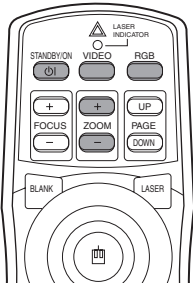

Control panel

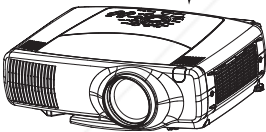
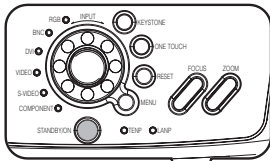

**NOTE** Turn the power on/off in right order.

- Power on the projector before the computer or video tape recorder.
- Power off the projector after the computer or video tape recorder.

### 1 Make sure that the power cord is firmly and correctly connected to the projector and outlet

3

### 2 Turn on the projector's power

Set the power switch to [ I ] (ON). The STANDBY/ON indicator will light to solid orange.

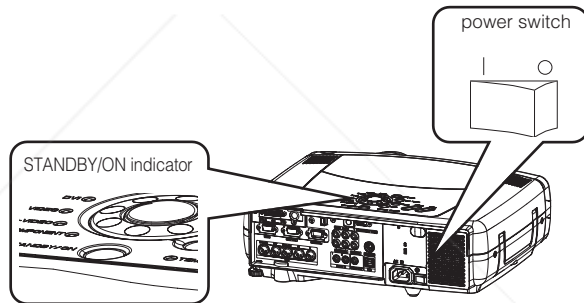

### 3 Press the STANDBY/ON button (control panel or remote control)

- The projector begins warming up and the STANDBY/ON indicator blinks green.
- The STANDBY/ON indicator stops blinking and lights to solid green once the projector's power is completely on.



### 4 Remove the lens cap

The picture is projected.

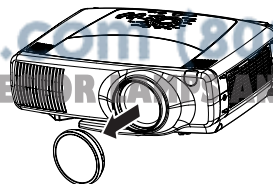

## TURNING ON THE POWER (continued)

### Selecting an Input Signal

#### 5 Using the remote control

##### If selecting RGB input Press the RGB button

Press this button to toggle between the devices connected to RGB IN 1 and 2. As illustrated below, each time you press the RGB button, the projector switches between RGB IN 1 and 2. Select the signal you wish to project.

- When BNC (RGB) is selected:

RGB → BNC(RGB) → DVI



- When BNC (COMPONENT) is selected:

RGB ↔ DVI

##### If selecting video input Press the VIDEO button

Press this button to toggle between the devices connected to VIDEO IN, S-VIDEO IN and COMPONENT VIDEO. As illustrated below, each time you press the VIDEO button, the projector switches between VIDEO IN, S-VIDEO IN and COMPONENT VIDEO. Select the signal you wish to project.



- When BNC (RGB) is selected:

VIDEO IN → S-VIDEO IN → COMPONENT VIDEO

- When BNC (COMPONENT) is selected:

VIDEO IN → S-VIDEO IN → COMPONENT VIDEO



#### Using the projector's control panel

##### Turn the INPUT dial

Turning the dial cycles through the inputs as shown below. Select the terminal to which the signal you want to project is input.

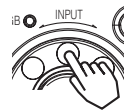

- When BNC (RGB) is selected:

RGB ↔ BNC(RGB) ↔ DVI  
↑ ↓  
COMPONENT VIDEO ↔ S-VIDEO ↔ VIDEO

- When BNC (COMPONENT) is selected:

RGB ↔ BNC(COMPONENT) ↔ DVI  
↑ ↓  
COMPONENT VIDEO ↔ S-VIDEO ↔ VIDEO

#### NOTE

Turn the INPUT dial and set it at the click point, otherwise input signal selection may be incorrect.

#### 6 Use the ZOOM (+) / (-) buttons to adjust the screen size



(Control panel)



(Remote control)

#### 7 Use the FOCUS (+) / (-) buttons to adjust the focus



(Control panel)



(Remote control)

## TURNING OFF THE POWER

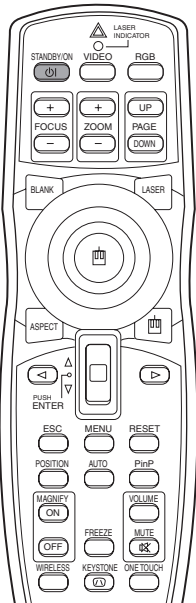

**Control panel**

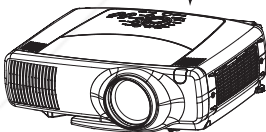
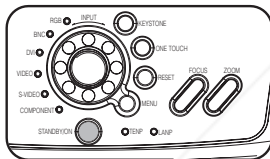

### NOTE

- Except in cases of emergency, do not turn off the power switch while the STANDBY/ON indicator is solid or flashing green. Doing so could shorten the lamp lifetime.

### 1 Press the **STANDBY/ON** button (control panel or remote control)

The message "Power off?" will appear on the screen for approximately 5 seconds.



### 2 Press the **STANDBY/ON** button again (control panel or remote control)

Press the STANDBY/ON button again while the "Power off?" message is visible. The projector lamp goes off and starts cooling down. While cooling, the STANDBY/ON indicator flashes orange. When in this state, pressing the STANDBY/ON button has no effect.

When lamp cooling is complete, the STANDBY/ON indicator stops flashing, and turning solid orange.



### 3 Check that the **STANDBY/ON** indicator stops blinking and lights to solid orange. Switch the power switch to [O] (OFF).

STANDBY/ON indicator

power switch

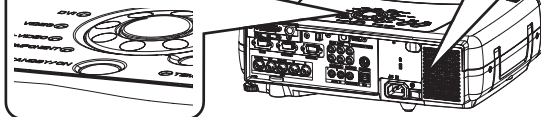

### 4 Confirm that the **STANDBY/ON** indicator has gone off and then attach the lens cap.

When the projector has completed powering down, the STANDBY/ON indicator will go off.

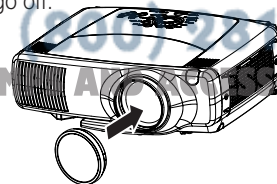

## ADJUSTING THE VOLUME

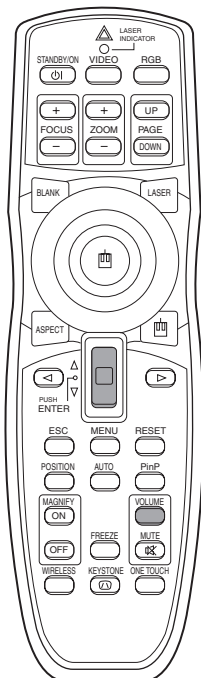

### 1 Press the **VOLUME** button

As illustrated on the right, a dialog will appear on the screen to aid you in adjusting the volume.

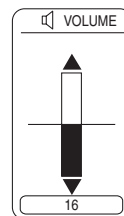

### 2 Use the lever switch / to adjust the volume

Press the VOLUME button again to close the dialog and complete this operation. (Even if you don't do anything, the dialog will automatically disappear after a few seconds.)

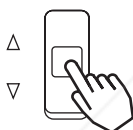

 Press this to increase the volume

 Press this to decrease the volume

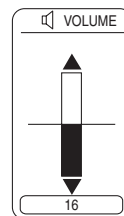

## TEMPORARILY MUTING THE SOUND

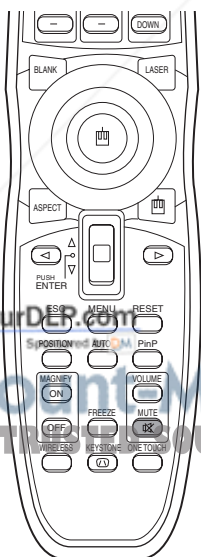

### 1 Press the **MUTE** button

As illustrated on the right, a dialog will appear on the screen indicating that you have muted the sound. Press the VOLUME button to close the dialog. (Even if you don't do anything, the dialog will automatically disappear after a few seconds.)

Press the MUTE button again to restore the sound.

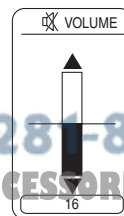

## ADJUSTING THE POSITION

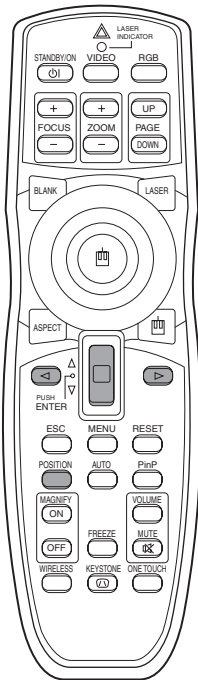

### 1 Press the **POSITION** button

As illustrated on the right, a dialog will appear on the screen to aid you in adjusting the position.



### 2 Use the **<**, **>**, **▲**, **▼** buttons to adjust the position

When you want to initialize the position, press the RESET button during adjustment.

Press the POSITION button again to close the dialog and complete this operation. (Even if you don't do anything, the dialog will automatically disappear after a few seconds.)

This function is only available for RGB/BNC (RGB) input.

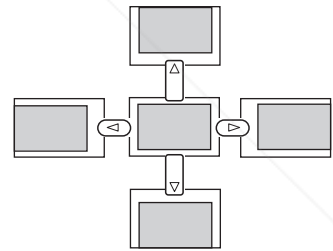
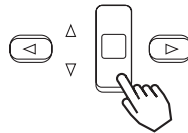

## USING THE AUTOMATIC ADJUSTMENT FEATURE

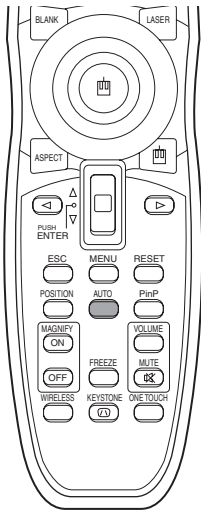

### 1 Press the **AUTO** button



#### **Automatic Adjustment for RGB Input**

Horizontal position (H. POSIT), vertical position (V. POSIT), clock phase (H. PHASE) and horizontal size (H. SIZE) are automatically adjusted.

Make sure that the application window is set to its maximum size prior to attempting to use this feature. Dark pictures may still be incorrectly adjusted. Use a bright screen when adjusting.

#### **Automatic Adjustment for Video Input**

The signal type best suited for the respective input signal is selected automatically.

This feature is available only if VIDEO is set to AUTO in the INPUT menu.

#### **NOTE**

The automatic adjustment operation requires approximately 10 seconds. Also, please note that it may not function correctly with some input signals.

## CORRECTING KEYSTONE DISTORTIONS

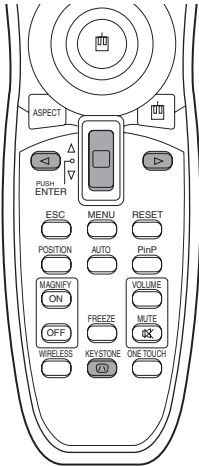

### 1 Press the **KEYSTONE** button

As illustrated on the right, a dialog will appear on the screen to aid you in correcting the distortion.

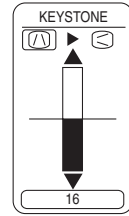

### 2 Use the **<**, **>** buttons to select the direction of distortion to correct (**▲**/**▼**)

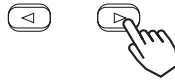

### 3 Use the lever switch **▲** / **▼** to correct distortion

Press the KEYSTONE button again to close the dialog and complete this operation. (Even if you don't do anything, the dialog will automatically disappear after a few seconds.)

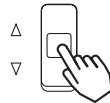

#### NOTE

- This function may not work well with some types of input signals.
- The adjustable range for correcting keystone distortions will vary with the type of input signal.

## USING THE MAGNIFY FEATURE

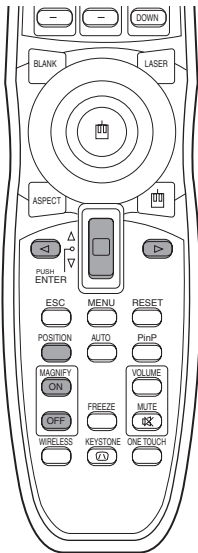

### 1 Press the **MAGNIFY (ON)** button

The projector enters MAGNIFY mode.



### 2 Press the **POSITION** button, then use the lever switch / , / to select the area to zoom. Press the **POSITION** button again to finalize the zoom area.

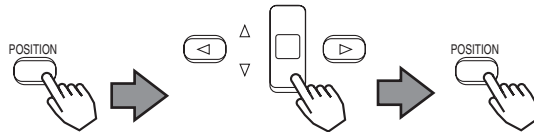

### 3 Use the lever switch / to adjust the zoom level

Press the MAGNIFY (OFF) button to exit MAGNIFY mode and restore the screen to normal. (The projector will also automatically exit MAGNIFY mode if there is a change in the input signal's state.)

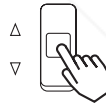

#### NOTE

The projector will automatically exit from MAGNIFY mode if either the INPUT SELECT, AUTO, ASPECT or VIDEO feature is used, or, if there is a change in the input signal's state.

## FREEZING THE SCREEN

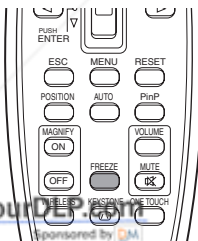

### 1 Press the **FREEZE** button

The [II] icon appears and the screen will freeze at the current image. Press the FREEZE button again and the [▶] appears as the projector exits FREEZE mode.



#### NOTE

- The projector will automatically exit from FREEZE mode if either the POSITION, VOLUME, MUTE, AUTO, BLANK ON/OFF or MENU ON/OFF feature is used, or, if there is a change in the input signal's state.
- If the projector continues projecting the same image for a long time (i.e. you forget to exit FREEZE mode), the image might possibly remain as an afterimage. Do not leave the projector in FREEZE mode for too long.



## ADJUSTING SCREEN WITH ONE-TOUCH

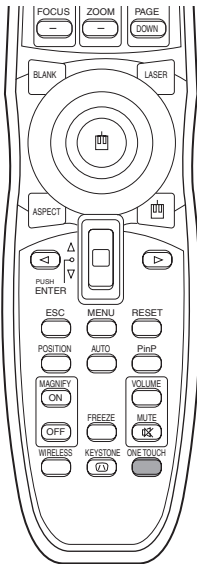

### 1

### Press the ONE TOUCH button

You can activate the following functions just by pressing the ONE TOUCH button:



(1) **Signal search:** Cycle through input signals, displaying the images of retrieved signals. If no signal is found, returns to the signal that was selected before the search was begun.

- When BNC (RGB) is selected:

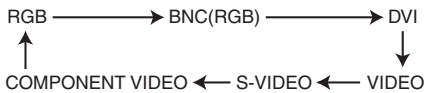

- When BNC (COMPONENT) is selected:

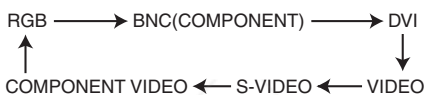

(2) **Automatic adjustment:** In RGB mode, automatically adjust the picture position and size; for VIDEO input, automatically select the signal mode. ( **20** )

(3) **Automatic keystone distortion correction:** This is only performed if ONE TOUCH of the AUTO menu is set to TURN ON. When performed, the unit automatically corrects vertical keystone distortion due to the (forward/backward) setup angle of the main unit. (Vol.2 **5**)

### NOTES

- May not function properly with some input signals.
- This function takes about 10 seconds to display an image.

## SELECTING THE ASPECT RATIO

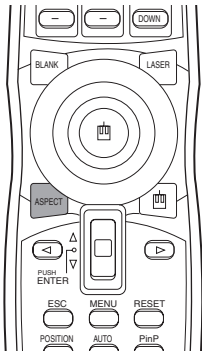

- 1 Press the ASPECT button**  
 RGB, DVI, COMPONENT VIDEO  
 (HDTV signals : 1125i (1035i/1080i), 750p)  
 4:3 ↔ 16:9  
 VIDEO IN, S-VIDEO IN, COMPONENT VIDEO  
 (Non-HDTV signals : 525i, 525p, 625i)  
 4:3 → 16:9 → SMALL



## TEMPORARILY BLANKING THE SCREEN

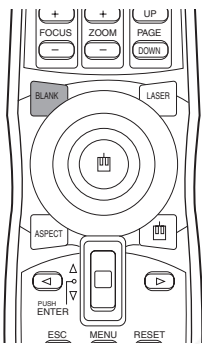

- 1 Press the BLANK button**  
 The input signal screen is shut off, and a blank screen appears. You can set the blank screen using the menu (from the SCREEN menu, select BLANK). Press the BLANK button again to remove the blank screen, and return to the input signal screen.



## DISPLAYING CHILD WINDOW (P. IN. P: Picture in Picture)

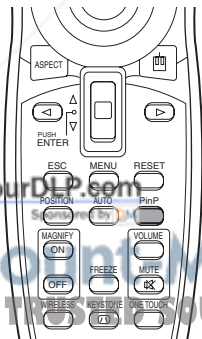

- 1 Press the P. in P. Button**  
 You can display the video input in a child window while displaying RGB, BNC, or DVI input.



Display child window (small) → Display child window (large) → No display

You can select the video input to display in the child window, and the position of the child window, from the INPUT menu. (Vol.2 4)

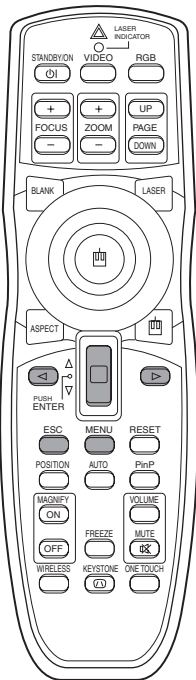
## USING THE MENU FUNCTIONS



### 1 Press the MENU button



The menu display appears on the screen. The projector has the following menus: MAIN, PICTURE-1, PICTURE-2, INPUT, AUTO, SCREEN, and OPTION, WIRELESS. When you select a menu name using the lever switch  / , the current settings of items that can be manipulated from that menu are displayed.



### 2 Use the lever switch / to select a menu, then press the or ENTER button

The display of the selected menu appears.

[ex. Adjusting SHARPNESS]

Use the lever switch  / , then press the  or ENTER button.

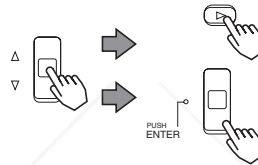



MENU		
MAIN	COLOR BAL R	-1
PICTURE-1	COLOR BAL B	+1
PICTURE-2	SHARPNESS	-1
INPUT	COLOR	+1
AUTO	TINT	-1
SCREEN		
OPTION		
WIRELESS		
[ENTER]: SELECT		

### 3 Use the lever switch / to select SHARPNESS, then press the or ENTER button

The operation display of the selected item appears. To adjust a numerical value, press the  or ENTER button again to switch to the single menu (small display showing only the operation display area).

[ex. Adjusting SHARPNESS]

Use the lever switch  / , then press the  or ENTER button.

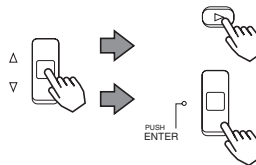

MENU		
MAIN	COLOR BAL R	-1
PICTURE-1	COLOR BAL B	+1
PICTURE-2	SHARPNESS	-1
INPUT	COLOR	+1
AUTO	TINT	-1
SCREEN		
OPTION		
WIRELESS		
[ENTER]: SELECT		

### 4 Use the lever switch / to adjust the level

Press the MENU button to hide the menu and finish your operation. Alternatively, press the  or ESC button to return to the previous display.

[ex. Adjusting SHARPNESS]

Use the lever switch  /  to adjust the sharpness.



#### NOTE

- For details about menu operations, see the separate "MULTI FUNCTIONAL SETTINGS" (Vol. 2).

## OPERATING THE PC SCREEN

You can use the remote control as a simplified mouse or keyboard.

**⚠ CAUTION** Caution: Mistaken use of the mouse/keyboard control could damage your equipment.

- Only connect to a PC.
- Before connecting, read the manuals of the device you will connect.
- Do not unplug the connector cables while the computer is operating.

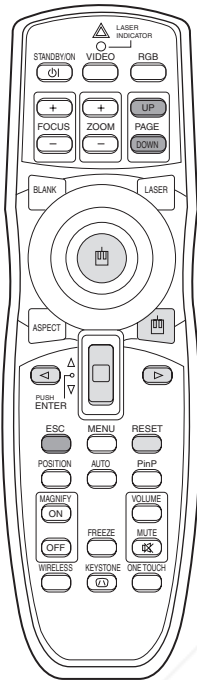

### PS/2, ADB, Serial Mouse Control

1. Turn off the projector and PC power, and connect the projector's CONTROL terminal to the computer via the mouse cable.
2. If a USB cable is connected, disconnect it. If a USB cable is connected, the USB control function is given priority, and mouse control from the CONTROL terminal will not function.
3. Turn on the projector power, then the computer.

The functions in the table below can be controlled. If you have difficulty with control, restart the computer (either from the software or by pressing the restart button).

Available Functions	Remote Control Operation
Move Pointer	Move using  on the disk pad
Left click with mouse	Press the center  of the disk pad
Right click with mouse	Press the right mouse button

### USB Mouse/Keyboard Control

1. Connect the projector's USB terminal to a PC using a USB cable. The functions in the table below can be controlled.

Available Functions	Remote Control Operation
Move Pointer	Move using  on the disk pad
Left click with mouse	Press the center  of the disk pad
Right click with mouse	Press the right mouse button
Press the keyboard's     keys	Press
Press the keyboard's ENTER key	Press the ENTER button
Press keyboard's PAGE UP key	Press PAGE UP button
Press keyboard's PAGE DOWN key	Press PAGE DOWN button
Press keyboard's ESC key	Press ESC button

### NOTES

- It may not be possible to control notebook PCs, and other computers with built-in pointing devices (e.g. track balls) using this remote control. In this case, before connecting go into BIOS (system setup) and select external mouse, and disable the pointing devices. In addition, the mouse may not function if the computer does not have the needed utility program. See your computer's hardware manual for details.
- The USB control can be used with Windows 95 OSR 2.1 or higher. It may not be possible to use the remote control, depending on the computer's configurations and mouse drivers.
- The USB control can only be used for the functions listed above. You cannot do things like press two buttons at once (for instance, pressing two buttons at the same time to move the mouse pointer diagonally).
- This function is not available while the lamp is warming up (the POWER indicator flashes green), while adjusting the volume and display, correcting for trapezoidal distortion, zooming in on the screen, using the BLANK function, or displaying the menu screen.

## THE LAMP



**HIGH VOLTAGE  
HIGH TEMPERATURE  
HIGH PRESSURE**

To replace the lamp, check the model number of the replacement lamp (sold separately) and contact your local dealer.

Replacement lamp model number: DT00571

If the projector is mounted on the ceiling, or if the lamp has broken, ask your dealer to replace the lamp. Lamp replacement is hazardous and should not be attempted by the user.

Before replacing the lamp, make sure the power switch is off and the power cable is not plugged in, then wait at least 45 minutes for the lamp to cool sufficiently. Handling the lamp while hot can cause burns, as well as damaging the lamp.

**⚠ WARNING** The LCD projector uses a glass lamp bulb. It is a mercury lamp with high internal pressure. High-pressure mercury lamps can break with a loud bang, or burn out, if jolted or scratched, or through wear over time. Each lamp has a different lifetime, and some may burst or burn out soon after you start using them. In addition, when the bulb bursts, it is possible for shards of glass to fly into the lamp housing, and for gas containing mercury to escape from the projector's vent holes.

- Do not open the lamp cover while the projector is suspended from above. This is dangerous, since if the lamp's bulb has broken, the shards will fall out when the cover is opened. In addition, working in high places is dangerous, so ask your local dealer to have the lamp replaced even if the bulb is not broken.
- Handle with care: jolting or scratching could cause the lamp bulb to burst during use.
- If the replace lamp indicator (see "Regarding the indicator Lamps" (Vol.2 )) comes on, replace the lamp as soon as possible. Using the lamp for long periods of time, or past the replacement date, could cause it to burst. Do not use old (used) lamps; this is a cause of breakage.
- If the lamp breaks soon after the first time it is used, it is possible that there are electrical problems elsewhere besides the lamp. If this happens, contact your local dealer or a service representative.
- If the lamp should break (it will make a loud bang when it does), ventilate the room well, and make sure not to breathe the gas that comes out of the projector vents, or get it in your eyes or mouth.
- If the lamp should break (it will make a loud bang when it does), unplug the power cord from the outlet, and make sure to request a replacement lamp from your local dealer. Note that shards of glass could damage the projector's internals, or cause injury during handling, so please do not try to clean the projector or replace the lamp yourself.
- Obey local ordinances when disposing of used lamps. In most cases, it is possible to dispose of used bulbs in the same manner as used glass bottles, but in some cases, bulbs are sorted separately.
- Do not use the projector with the lamp cover removed.

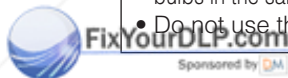

Sponsored by DM

**Discount-Merchant.com (800) 281-8860**  
**THE TRUSTED SOURCE FOR PROJECTOR LAMPS AND ACCESSORIES**

## THE LAMP (continued)

### Replacing the lamp

All projector lamps will wear out eventually. If used for long periods of time, the image could become darkened, and the color contrast could be impacted as well. We recommend that you replace your lamps early. If the LAMP indicator turns red, the lamp needs to be replaced. (See "Regarding the Indicator Lamps" (Vol.2 ) for details.)

- 1 Turn off the projector, and unplug the power cord. Allow the lamp bulb to cool for at least 45 minutes, and prepare a new lamp (serial number: DT00571)**

- 2 After making sure that the projector has cooled adequately, slide the knob of a lamp cover lock as shown in the figure. Then, one side of the lamp cover is raised. Pull up the lamp cover and remove it, as shown in the figure**

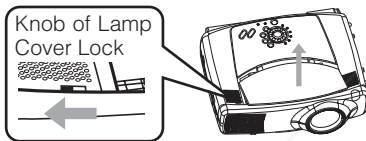

- 3 Unscrew the 3 screws, and slowly pull out the lamp by the handle**

- Be careful not to touch the inside of the lamp case.

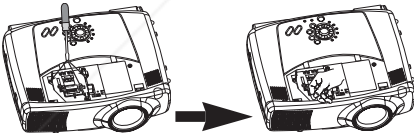

- 4 Insert the new lamp, and tighten the 3 screws firmly to lock it in place**

- 5 Interlocking the 2 tabs of the lamp cover to the projector, put the lamp cover on the projector. Then push the point of the lamp cover to fix it, as shown in the figure. Make sure that the lamp cover doesn't come up**

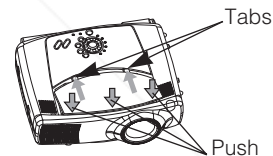

- 6 Turn on the projector power, and reset the lamp timer**

- To reset the lamp timer, from the OPTION menu, select the LAMP TIME. (Vol.2 )



- ATTENTION**
- Make sure that the screws are screwed in firmly. Loose screws could result in damage or injury.
  - Do not use with lamp cover removed.
  - Do not reset the lamp timer without replacing the lamp. Reset the lamp timer always when replacing the lamp.

**NOTE** • The LAMP indicator is also red when the lamp unit reaches high temperature.

Before replacing the lamp, switch power off, wait approximately 20 minutes, and switch power on again. If the LAMP indicator is still red, replace the lamp.

## THE AIR FILTER

### ***Caring for the air filter***

The air filter should be cleaned about every 100 hours. If the LAMP indicator and TEMP indicator blink red simultaneously, or a message prompts you to clean the air filter when you turn on the unit, the filter needs to be cleaned. (See "Related Messages" (Vol.2 ) and "Regarding the Indicator Lamps" (Vol.2 ) for details.)

#### **1 Turn off the projector, and unplug the power cord**

#### **2 Apply a vacuum cleaner to the top of the air filter cover to clean the air filter**

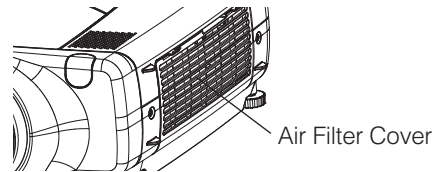

#### **3 Turn on the projector, and use the menu to reset the filter timer**

- To reset the air filter timer, from the OPTION menu, select FILTER TIME.

## THE AIR FILTER (continued)

### ***Replacing the air filter***

If the soiling will not come off the air filter, or it becomes damaged, then it needs to be replaced. Please contact your local dealer, after confirming the model of your separately sold replacement air filter.

Replacement air filter model: NJ07081

**1 Turn off the projector, and unplug the power cord. Prepare a new air filter (one specified for your projector)**

**2 Remove the air filter cover and air filter**

**3 Insert the new filter, and replace the filter cover**

**4 Turn on the projector power, and using the menu, reset the filter timer**

- To reset the filter timer, from the OPTION menu, select FILTER TIME.

**ATTENTION** • Make sure to turn off the power and unplug the power cord before caring for the unit. Please carefully read "Safety Instructions", in order to care for your projector correctly.

- Do not use with air filter cover removed.
- If the air filter becomes clogged by dust or the like, internal temperature rises and could cause malfunction. The power is automatically turned off in order to prevent the unit from overheating internally.

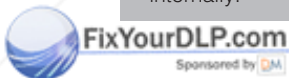

Sponsored by 

**Discount-Merchant.com (800) 281-8860**  
**THE TRUSTED SOURCE FOR PROJECTOR LAMPS AND ACCESSORIES**



## OTHER CARE

### Caring for the inside of the projector :

In order to ensure the safe use of your projector, please have it cleaned and inspected by your local dealer about once every 2 years. Never try to care for the inside of the unit yourself. Doing so is dangerous.

### Caring for the lens :

Lightly wipe the lens with a commercially available lens-cleaning wipe. Do not touch the lens directly with your hand.

### Caring for the cabinet and remote control transmitter :

Wipe lightly with gauze or a soft cloth. If soiling is severe, dip a soft cloth in water or a neutral cleanser diluted in water, and wipe lightly after wringing well. Then, wipe lightly with a soft, dry cloth.

**ATTENTION** • Make sure to turn off the power and unplug the power cord before caring for the unit. Please carefully read "Safety Instructions" in this manual, in order to care for your projector correctly.

- Do not use cleaners or chemicals other than those listed above, including benzene and paint thinner.
- Do not use aerosols or sprays.
- Do not polish or wipe with hard objects.



# Disclaimer

This user manual is provided as a free service by FixYourDLP.com. FixYourDLP is in no way responsible for the content of this manual, nor do we guarantee its accuracy. FixYourDLP does not make any claim of copyright and all copyrights remain the property of their respective owners.

About FixYourDLP.com

FixYourDLP.com (<http://www.fixyourdpl.com>) is the World's #1 resource for media product news, reviews, do-it-yourself guides, and manuals.

Informational Blog: <http://www.fixyourdpl.com>

Video Guides: <http://www.fixyourdpl.com/guides>

User Forums: <http://www.fixyourdpl.com/forum>

FixYourDLP's Fight Against Counterfeit Lamps:

<http://www.fixyourdpl.com/counterfeits>

## Sponsors:

RecycleYourLamp.org – Free lamp recycling services for used lamps:

<http://www.recycleyourlamp.org>

Lamp Research - The trusted 3rd party lamp research company:

<http://www.lampresearch.com>

Discount-Merchant.com – The worlds largest lamp distributor:

<http://www.discount-merchant.com>



**FixYourDLP.com**

Sponsored by 