



Disclaimer

This user manual is provided as a free service by FixYourDLP.com. FixYourDLP is in no way responsible for the content of this manual, nor do we guarantee its accuracy. FixYourDLP does not make any claim of copyright and all copyrights remain the property of their respective owners.

About FixYourDLP.com

FixYourDLP.com (<http://www.fixyourdlp.com>) is the World's #1 resource for media product news, reviews, do-it-yourself guides, and manuals.

Informational Blog: <http://www.fixyourdlp.com>

Video Guides: <http://www.fixyourdlp.com/guides>

User Forums: <http://www.fixyourdlp.com/forum>

FixYourDLP's Fight Against Counterfeit Lamps:

<http://www.fixyourdlp.com/counterfeits>

Sponsors:

RecycleYourLamp.org – Free lamp recycling services for used lamps:

<http://www.recycleyourlamp.org>

Lamp Research - The trusted 3rd party lamp research company:

<http://www.lampresearch.com>

Discount-Merchant.com – The worlds largest lamp distributor:

<http://www.discount-merchant.com>



FixYourDLP.com

Sponsored by 

BARCO

BARCO PROJECTION SYSTEMS

BARCO CiNE
9

R9002400
R9002401

 FixYourDLP.com
Sponsored by 

Discount-Merchant.com (800) 281-8860

OWNER'S MANUAL
THE TRUSTED SOURCE FOR PROJECTOR LAMPS AND ACCESSORIES

Date :
31012002

Rev. :
02

Art. No. :
R5976194

Due to constant research, the information in this manual is subject to change without notice.

Produced by BARCO NV, January 2002.
All rights reserved.

Trademarks are the rights of their respective owners.

Sponsored by 

BARCO n.v./Projection Systems

Noordlaan 5

B-8520 Kuumbe

Belgium

Tel: +32/56/368211

Fax: +32/56/351651

E-mail: sales.bps@barco.com

Visit Barco at the web: <http://www.barco.com>

Printed in Belgium



Direct-Print.com

Sponsored by 

Direct-Print-Merchant.com (800) 281-8860

TRUSTED SOURCE FOR PROJECTOR LAMPS AND ACCESSORIES



CONTENT

SAFETY INSTRUCTIONS	1-1
Safety Instructions	1-1
Notice on Safety	1-1
installation INSTRUCTIONS	1-1
OWNER'S RECORD	1-1
Safety indication on the product	1-1
Safety Warning	1-2
FEDERAL COMMUNICATION COMMISSION (FCC STATEMENT)	1-2
On Safety	1-2
Caution on Fire Hazard	1-3
On installation	1-3
On servicing	1-3
On cleaning	1-3
On repacking	1-4
On illumination	1-4
Note	1-4
Definition	1-4
CONNECTIONS	2-1
Power Connection to Projector	2-1
AC Power (mains) Cord Connection	2-1
Power Check	2-1
Switching On/Off	2-1
Source Connections	2-2
Input locations	2-2
Input facilities	2-2
Which source to which input	2-2
Composite Video source.	2-3
Which signals to the Video Input ?	2-3
Video input selection	2-3
Note on Loop-through	2-3
75 W Termination Switch for Video	2-3
S-Video or Video source to port 2	2-3
Which Signals to port 2	2-3
Pin configuration 4 pin connector	2-3
Input selection port 2	2-4
Input Priority setting	2-4
Note on Loop-through	2-4
75 W Termination Switch for port 2	2-4
RGB Analog source to port 3	2-5
Which signal to port 3	2-5
Pin configuration D9 connector of the Analog input.	2-5
RGB Analog source with composite sync to port 4/5.	2-5
Which signal to port 4/5	2-5
RGSB or RGSB input selection	2-5
RGB Analog source with Tri-level sync to port 4/5	2-6
Which signal to port 4/5	2-6
RGB3S or RG3sB input selection	2-6
Component Source to port 4/5.	2-6
Which signal to port 4/5	2-6
Component video input selection	2-6
RS232 Connection	2-6
RS232 input and RS232 output of the projector.	2-6
Communication port for communication with peripherals	2-6
Connecting a RCVDS 05 switcher to the projector.	2-6
GETTING STARTED	3-1
Remote Control & Local Keypad	3-1
Battery Installation in the RCU	3-1
How to replace the batteries in the RCU ?	3-1
Overview of Functions	3-2
Operating the Projector	3-3

Switching on	3-3
Start up in Operational Mode	3-3
Start up in Stand by Mode.....	3-3
Stationary Image Warning	3-3
RCU Commands to the Projector	3-4
Pointing the RCU to the reflective screen	3-4
Point the front of the RCU towards one of the IR sensors in the projector.	3-4
RCU used in a hardwired configuration.	3-4
Projector address	3-5
Why a projector address ?	3-5
Set up an Individual Projector Address	3-5
How to control the projector or projectors ?	3-5
Common Address	3-5
Before using the RCU	3-5
Display the Projector Address on the Screen.	3-5
How to program an address into the RCU?	3-5
Controlling the Projector	3-6
Input selection modes	3-6
When the source is selected	3-6
Picture controls	3-7
Sound controls	3-7
The Pause key.	3-7
The Freeze key.	3-7
START UP OF THE ADJUSTMENT MODE	4-1
Adjustment Mode	4-1
Start Up.....	4-1
Possible Paths	4-1
MAIN MENU	5-1
Main Menu	5-1
Overview Flowchart	5-1
Image Control	5-2
Starting Up	5-2
Line Multiplier	5-2
Why Line Multiplying	5-2
How to change the Multiplier Setting.....	5-2
Line Multiplier ON/OFF	5-2
Multiplier Mode	5-3
What can be selected within the multiplier mode ?	5-3
How to start up the Multiplier Mode menu ?	5-3
How to change the scan rate ?	5-3
Motion Processing	5-3
Why Motion Processing ?	5-3
How to activate ?	5-3
Video Equalizing	5-4
What can be done ?	5-4
How to select Video Equalizing ?	5-4
How to adjust the Video Equalizing ?	5-4
Noise Reduction	5-4
What can be done ?	5-4
How to select and adjust the Noise Reduction ?	5-4
Contrast Enhancement	5-4
What can be done ?	5-4
How to select and adjust the contrast enhancement ?	5-5
Color Adjust	5-5
What can be done ?	5-5
How to select 'Color Adjust' and to select a new color temperature?	5-5
Format Select	5-5
What can be done ?	5-5
How to select a 'Format' ?	5-5
How to add a name to a 'Format' ?	5-6
How to store the settings to a new 'Format' ?	5-6
IRIS control	5-6
Start Up.....	5-6
Note	5-6
IRIS Touch Up	5-6
What can be done ?	5-6
How to start up the IRIS Touch Up ?	5-7
IRIS Auto Converge	5-7
What can be done ?	5-7

FixYourDLP.com
 Discount Merchant.com (800) 281-8160
 THE TRUSTED SOURCE FOR PROJECTOR LAMPS AND ACCESSORIES

How to start up the IRIS Auto Converge ?	5-7
Sound Control	5-8
What can be done ?	5-8
How to start up and to select the Sound Control ?	5-8
Function Keys	5-8
What can be done ?	5-8
How to get an overview of the programmed keys ?	5-8
Service Menus	5-8
What can be done ?	5-8
How to enter the Service Menu ?	5-9
ENTERING THE SERVICE MENUS	6-1
Service menus	6-1
What is available in the Service menus ?	6-1
How to enter the Service Menus ?	6-1
Password Protection	6-1
Entering the password	6-1
RANDOM ACCESS ADJUSTMENT MODE	7-1
Random access adjustment mode.	7-1
Starting Up	7-1
Overview Flowchart	7-1
Selecting Setup Pattern	7-2
Set up of the Selected Setup Pattern ?	7-2
Note:	7-2
Internal Cross Hatch Pattern	7-3
When using the Internal Cross Hatch Pattern ?	7-3
Factory Preset Frequencies	7-3
Random access adjustment mode selection menu.	7-3
What is possible ?	7-3
Picture Tuning	7-4
Start up the Picture Tuning	7-4
Color Balance	7-4
What can be done ?	7-4
How to select the Color Balance ?	7-4
Fixed Color Balance	7-4
Custom Color Balance	7-4
Sync Fast/Slow Adjustment	7-5
What can be done ?	7-5
How to setup the sync function ?	7-5
Note	7-5
Peaking	7-6
What can be done ?	7-6
How to set up ?	7-6
Clamp Tuning	7-6
What can be done ?	7-6
How to set up ?	7-6
Port 2 : Video or S-Video	7-7
What can be done ?	7-7
How to configure port 2 ?	7-7
Line Multiplier	7-7
What can be done ?	7-7
How to select when a line multiplier is built in ?	7-7
Switching the multiplier ON/OFF	7-8
Motion Processing	7-8
Why Motion Processing ?	7-8
How to activate ?	7-8
Output Mode	7-9
What can be done ?	7-9
How to select a new scan rate ?	7-9
Video Equalizing	7-9
What can be done ?	7-9
How to select Video Equalizing ?	7-9
How to adjust the Video Equalizing ?	7-10
Noise Reduction	7-10
What can be done ?	7-10
How to select and adjust the Noise Reduction ?	7-10
Contrast Enhancement	7-10
What can be done ?	7-10
How to select and adjust the contrast enhancement ?	7-10



Advanced Settings	7-11
How to select the Advanced Settings ?	7-11
Time Base Correction	7-11
Luminance Delay	7-11
Clamp Gating	7-12
Vertical Sync Reference	7-12
Factory Preset	7-12
Limo Pro Options	7-13
Coring	7-13
LTI	7-13
CTI	7-14
Geometry Adjustments	7-14
What can be done ?	7-14
Start Up	7-14
Important	7-14
Horizontal Phase Adjustment	7-14
Start Up	7-14
Note	7-14
How to adjust ?	7-15
Raster Shift Adjustment	7-15
What has to be done ?	7-15
CAUTION	7-15
Start up	7-15
Note	7-15
Warning	7-15
Left-Right (east-west) Adjustments	7-16
What can be adjusted ?	7-16
Start up	7-16
Note	7-16
Which adjustment can be executed ?	7-16
How to enter an alignment ?	7-16
Warning	7-17
Seagull correction	7-17
Left Side Correction	7-18
What can be done ?	7-18
Warning	7-18
Start Up	7-18
Left Side Adjustments	7-18
Top-Bottom (north-south) Adjustments	7-19
What can be adjusted ?	7-19
Start Up	7-19
Note	7-19
Which adjustment can be executed ?	7-19
How to enter an alignment ?	7-19
Seagull correction	7-20
Horizontal Size Adjustment	7-21
What can be done ?	7-21
Start up	7-21
Hint	7-21
Vertical Linearity Adjustment	7-22
What can be done ?	7-22
Start Up	7-22
Vertical Size Adjustment	7-22
What can be done ?	7-22
Start up	7-22
Hint	7-22
Blanking Adjustments	7-23
What can be done ?	7-23
Start Up	7-23
How to adjust the Blanking ?	7-23
Convergence Adjustment	7-24
What has to be done ?	7-24
Note	7-24
Adjustment order	7-24
Start up	7-24
How to adjust ?	7-25
Focusing	7-25
What can be done ?	7-25
Start Up	7-25
Midpoint Focusing	7-26
Top Image Focusing	7-26
Bottom Image Focusing	7-26

FixYourDLP.com
Discount-Merchant.com (800) 281-8260
THE TRUSTED SOURCE FOR PROJECTOR LAMPS AND ACCESSORIES

Left Image Focusing	7-26
Right Image Focusing	7-27
Blue on Source	7-27
Color Select	7-27
What can be done ?	7-27
Start Up	7-27
SERVICE MODE	8-1
Service mode	8-1
Start Up	8-1
Overview flowchart	8-1
Projector Set-up	8-2
What can be done ?	8-2
Start up the Projector Set-Up	8-2
Identification	8-2
What can be seen ?	8-2
How to start up ?	8-3
Run Time	8-3
What can be displayed ?	8-3
Run Time Note	8-3
How to start up ?	8-3
How to Reset the CRT run times ?	8-3
Change password	8-4
What can be done ?	8-4
Note	8-4
How to select ?	8-4
How to enter a new password ?	8-4
Change Projector Address	8-4
What can be done ?	8-4
How to change that address ?	8-4
Change Baudrate	8-5
What can be set up ?	8-5
How to set up ?	8-5
Projector warm up	8-5
What can be done ?	8-5
How to select ?	8-5
Warm up ON/OFF	8-6
What can be done ?	8-6
How to install ?	8-6
Warm Up Frequency	8-6
What can be done ?	8-6
How to install a warm up frequency ?	8-6
Projector Warm Up Time	8-6
What can be done ?	8-6
How to program the warm up time ?	8-6
Power up mode	8-7
What can be done ?	8-7
How to change the mode ?	8-7
Common Address	8-7
What can be done ?	8-7
Why 2 different common address ?	8-7
How to change the common address ?	8-7
Memory management	8-8
What can be done ?	8-8
How to select ?	8-8
Copy a block	8-8
What can be done ?	8-8
How to copy ?	8-8
Copy softedge settings	8-9
What can be done ?	8-9
How to copy the softedge settings ?	8-9
Deletion of blocks	8-9
What can be done ?	8-9
Deleting block by block	8-9
What can be done ?	8-9
How to delete a Block ?	8-9
Deletion of all blocks	8-10
What can be done ?	8-10
How to delete all blocks ?	8-10
Set to midposition	8-10



Disc Merchant.com (800) 281-8860

THE TRUSTED SOURCE FOR PROJECTOR LAMPS AND ACCESSORIES

Table of Content

What can be done ?	8-10
How to Start Up ?	8-10
R & B convergence mid	8-10
What can be done ?	8-10
How to set convergence to midposition :	8-11
Undo R & B convergence mid	8-11
What can be done ?	8-11
How to Undo ?	8-11
Green convergence mid	8-11
What can be done ?	8-11
How to set Green settings to midposition ?	8-11
Undo green convergence mid	8-12
What can be done ?	8-12
How to undo ?	8-12
Undo Focus to Midposition	8-12
What can be done ?	8-12
How to undo the Focus to midposition ?	8-12
Focus to Midposition	8-12
What can be done ?	8-12
How to set the Focus settings to midposition ?	8-12
East-West to Midposition	8-13
What can be done ?	8-13
How to set the E-W settings to midposition ?	8-13
Undo East-West to midposition	8-13
What can be done ?	8-13
How to Undo the E-W to midposition ?	8-13
North-South settings to Midposition	8-13
What can be done ?	8-13
How to set the N-S settings to midposition ?	8-14
Undo North-South setting to midposition	8-14
What can be done ?	8-14
How to Undo the N-S to midposition ?	8-14
Digital Vertical Linearity to Midposition	8-14
What can be done ?	8-14
How to set the Digital Vertical Linearity to Midposition ?	8-14
Undo Digital Vertical Linearity to Midposition	8-15
What can be done ?	8-15
How to undo the digital vertical linearity to midposition ?	8-15
Digital Horizontal Linearity to midposition	8-15
What can be done ?	8-15
How to set the Digital Horizontal Linearity to Midposition ?	8-15
Undo Digital Horizontal Linearity to Midposition	8-15
What can be done ?	8-15
How to undo the digital vertical linearity to midposition ?	8-16
Astigmatism midposition	8-16
What can be done ?	8-16
How to set the Astigmatism to Midposition ?	8-16
Undo Astigmatism setting to midposition	8-16
What can be done ?	8-16
How to undo the Astigmatism settings to midposition ?	8-16
All settings to Midposition	8-17
What can be done ?	8-17
How to set to midposition ?	8-17
Undo all settings to midpos	8-17
What can be done ?	8-17
How to cancel 'Set to midposition' ?	8-17
Common Settings	8-18
What can be done ?	8-18
How to select ?	8-18
Dynaminc Astigmatism	8-18
What can be done ?	8-18
Start Up	8-19
How to adjust ?	8-19
Focusing on current source	8-19
Gamma Corrections	8-20
Gamma Corrections warning ?	8-20
Start Up	8-20
CRT run in cycle	8-20
What can be done ?	8-20

www.FixYourDLP.com
DiscWhit-Merchant.com (800) 281-8160
THE TRUSTED SOURCE FOR PROJECTOR LAMPS AND ACCESSORIES

How to select CRT run in cycle ?	8-20
CRT Drive Mode	8-21
What can be done ?	8-21
8-21	
Available drive modes	8-21
How to change the drive mode ?	8-21
CRT Drive mode warning	8-21
Memory banks	8-21
What can be done ?	8-21
How to select Memory Banks ?	8-21
How to create a new memory bank ?	8-22
How to recall a specific memorybank for the actual source ?	8-22
Flyback Turnover Point	8-22
What can be done ?	8-22
Set Up of the Flyback Turnover Point	8-22
Menu Position	8-22
What can be done ?	8-22
Voltage Diagnostics	8-23
What can be seen ?	8-23
How to start up ?	8-23
How to change the position ?	8-23
I2C Diagnostics	8-23
What can be seen ?	8-23
How to select ?	8-23
Projector Diagnostics	8-24
What can be seen ?	8-24
How to display the Projector Diagnostics ?	8-24
PROGRAMMABLE FUNCTION KEYS	9-1
Programmable Function Keys	9-1
What can be done with these keys	9-1
How can a Function Key be programmed ?	9-1
MESSAGES, WARNINGS AND FAILURES	10-1
ADJUSTMENT BLOCKS AND SOURCE NUMBERS 90 - 99	A-1
Adjustment Blocks (memory blocks)	A-1
What are adjustment block ?	A-1
Built up of block	A-1
Source numbers 90 - 99	A-1
Why used ?	A-1
How to create a second block ?	A-1



Discount-Merchant.com (800) 281-8860
THE TRUSTED SOURCE FOR PROJECTOR LAMPS AND ACCESSORIES



Discount-Merchant.com (800) 281-8860
THE TRUSTED SOURCE FOR PROJECTOR LAMPS AND ACCESSORIES

1

SAFETY INSTRUCTIONS

Safety Instructions

Notice on Safety

This equipment is built in accordance with the requirements of the international safety standards EN60950, UL 1950 and CSA C22.2 No.950, which are the safety standards of information technology equipment including electrical business equipment.

These safety standards impose important requirements on the use of safety critical components, materials and isolation, in order to protect the user or operator against risk of electric shock and energy hazard, and having access to live parts. Safety standards also impose limits to the internal and external temperature rises, radiation levels, mechanical stability and strength, enclosure construction and protection against the risk of fire.

Simulated single fault condition testing ensures the safety of the equipment to the user even when the equipment's normal operation fails.

INSTALLATION INSTRUCTIONS

Before operating this equipment please read this manual thoroughly, and retain it for future reference.

Installation and preliminary adjustments should be performed by qualified BARCO personnel or by authorized BARCO service dealers.

OWNER'S RECORD

The part number and serial number are located at the back side of the projector. Record these numbers in the spaces provided below. Refer to them whenever you call upon your BARCO dealer regarding this product.

PART NUMBER :

SER. NUMBER :

DEALER :

Safety indication on the product

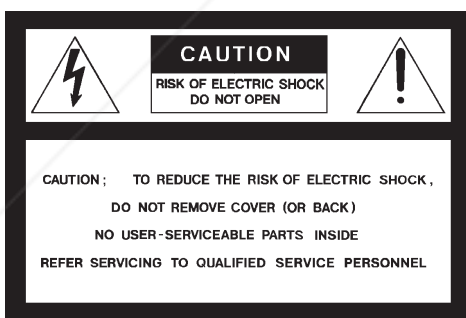

FixYourDLP.com
 Sponsored by DLP
 Discount-Merchant.com (800) 281-8860
 THE TRUSTED SOURCE FOR PROJECTOR LAMPS AND ACCESSORIES



The lightning flash with an arrowhead within a triangle is intended to tell the user that parts inside this product may cause a risk of electrical shock to persons.



The exclamation point within a triangle is intended to tell the user that important operating and/or servicing instructions are included in the technical documentation for this equipment.

Safety Warning

TOPREVENT FIRE OR ELECTRICAL SHOCK HAZARD, DO NOT EXPOSE THIS EQUIPMENT TO RAIN OR MOISTURE

FEDERAL COMMUNICATION COMMISSION (FCC STATEMENT)

This equipment has been tested and found to comply with the limits of a class A digital device, pursuant to Part 15 of the FCC Rules. These limits are designed to provide reasonable protection against harmful interference when the equipment is operated in a commercial environment. This equipment generates, uses and can radiate radio frequency energy and, if not installed and used in accordance with the instruction manual, may cause harmful interference to radio communications. Operation of this equipment in a residential area is likely to cause harmful interference in which case the user will be required to correct the interference at his own expense.

Note :

The use of shielded cables is required to comply within the limits of Part 15 of FCC rules and EN55022.

- * All the safety and operating instructions should be read before using this unit.
- * The safety and operating instructions manual should be retained for future reference.
- * All warnings on the equipment and in the documentation manuals should be adhered to.
- * All instructions for operating and use of this equipment must be followed precisely.

On Safety

1. This product should be operated from an AC power source. Power input is autoranging from 100 V(-10%) to 240V(+6%).
2. All equipment in the system is equipped with a 3-wire grounding plug, a plug having a third (grounding) pin. This plug will only fit into a grounding-type power outlet. This is a safety feature. If you are unable to insert the plug into the outlet, contact your electrician to replace your obsolete outlet. Do not defeat the purpose of the grounding-type plug.

WARNING FOR THE CUSTOMERS: THIS APPARATUS MUST BE GROUNDED (EARTHED) via the supplied 3 conductor AC power cable. (If the supplied power cable is not the correct one, consult your dealer.)

A. Mains lead (Power cord) with CEE 7 plug:

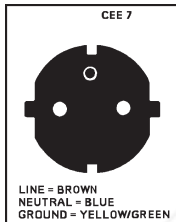

The wires of the mains lead are colored in accordance with the following code.

Green and yellow: earth (safety earth)
Blue: neutral
Brown: line (live)

B. Power cord with ANSI 73.11 plug:

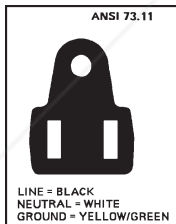

The wires of the power cord are colored in accordance with the following code.

Green/yellow: ground
White: neutral
Black: line (live)

3. Do not allow anything to rest on the power cord. Do not locate this product where persons will walk on the cord. To disconnect the cord, pull it out by the plug. Never pull the cord itself.
4. If an extension cord is used with this product, make sure that the total of the ampere ratings on the products plugged into the extension cord does not exceed the extension cord ampere rating.
5. Never push objects of any kind into this product through cabinet slots as they may touch dangerous voltage points or short out parts that could result in a risk of fire or electrical shock.
Never spill liquid of any kind on the product. Should any liquid or solid object fall into the cabinet, unplug the set and have it checked by qualified service personnel before resuming operations.
6. Lightning - For added protection for this video product during a lightning storm, or when it is left unattended and unused for long periods of time, unplug it from the wall outlet. This will prevent damage to the projector due to lightning and AC power-line surges.

Caution on Fire Hazard

Do not place flammable or combustible materials near projector !

BARCO large screen projection products are designed and manufactured to meet the most stringent safety regulations. This projector radiates heat on its external surfaces and from ventilation ducts during normal operation, which is both normal and safe.

Explosing flammable or combustible materials into close proximity of this projector could result in the spontaneous ignition of that material, resulting in a fire. For this reason, it is absolutely necessary to leave an "exclusion zone" around all external surfaces of the projector whereby no flammable or combustible materials are present. The exclusion zone must be not less than 10 cm (4") for Barco Retro Projectors. Do not cover the projector with any material while the projector is in operation.

Keep flammable and combustible materials away from the projector at all times. Mount the projector in a well ventilated area away from sources of ignition and out of direct sun light. Never expose the projector to rain or excessive moisture. In the event of fire, use sand, CO₂, or dry powder fire extinguishers; never use water on an electrical fire.

Always have service performed on this projector by authorized BARCO service personnel. Always insist on genuine BARCO replacement parts. Never use non-BARCO replacement parts as they may degrade the safety of this projector.

On installation

1. Do not place this equipment on an unstable cart, stand, or table. The product may fall, causing serious damage to it.
2. Do not use this equipment near water.
3. Slots and openings in the cabinet and the back or bottom are provided for ventilation; to ensure reliable operation of the product and to protect it from overheating, these openings must not be blocked or covered. The openings should never be blocked by placing the product on a bed, sofa, rug, or other similar surface. This product should never be placed near or over a radiator or heat register.

The projector should not be placed in a built-in installation or enclosure unless proper ventilation is provided.

4. Do not block the projector cooling fans or free air movement under and around the projector. Loose papers or other objects may not be nearer to the projector than 4" on any side.

On servicing

Do not attempt to service this product yourself, as opening or removing covers may expose you to dangerous voltage potentials and risk of electric shock!

Refer all servicing to qualified service personnel.

Unplug this product from the wall outlet and refer servicing to qualified service personnel under the following conditions:

- a. When the power cord or plug is damaged or frayed.
- b. If liquid has been spilled into the equipment.
- c. If the product has been exposed to rain or water.
- d. If the product does not operate normally when the operating instructions are followed.

Note : Adjust only those controls that are covered by the operating instructions since improper adjustment of the other controls may result in damage and will often require extensive work by a qualified technician to restore the product to normal operation.

- e. If the product has been dropped or the cabinet has been damaged.

- f. If the product exhibits a distinct change in performance, indicating a need for service.

Replacement parts - When replacement parts are required, be sure the service technician has used original BARCO replacement parts or authorized replacement parts which have the same characteristics as the BARCO original part. Unauthorized substitutions may result in degraded performance and reliability, fire, electric shock or other hazards. Unauthorized substitutions may void warranty.

Safety check - Upon completion of any service or repairs to this projector, ask the service technician to perform safety checks to determine that the product is in proper operating condition.

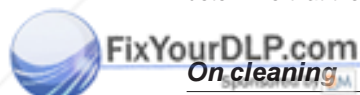

Unplug this product from the wall outlet before cleaning. Do not use liquid cleaners or aerosol cleaners. Use a damp cloth for cleaning.

- To keep the cabinet looking brand-new, periodically clean it with a soft cloth. Stubborn stains may be removed with a cloth lightly dampened with mild detergent solution. Never use strong solvents, such as thinner or benzine, or abrasive cleaners, since these will damage the cabinet.

- To ensure the highest optical performance and resolution, the projection lenses are specially treated with an anti-reflective coating, therefore, avoid touching the lens. To remove dust on the lens, use a soft dry cloth. Do not use a damp cloth, detergent solution, or thinner.

On repacking

Save the original shipping carton and packing material; they will come in handy if you ever have to ship your equipment. For maximum protection, repack your set as it was originally packed at the factory.

On illumination

In order to obtain the best quality for the projected image, it is essential that the ambient light which is allowed to fall on the screen be kept to an absolute minimum.

When installing the projector and screen, care must be taken to avoid exposure to ambient light directly on the screen. Avoid adverse illumination on the screen from direct sunlight or fluorescent lighting fixtures.

The use of controlled ambient lighting, such as incandescent spot light or a dimmer, is recommended for proper room illumination. Where possible, care should also be taken to ensure that the floors and walls of the room in which the projector is to be installed are non-reflecting, dark surfaces. Brighter surfaces will tend to reflect and diffuse the ambient light and hence reduce the contrast of the projected image on the screen.

Note

Definition

Service personnel: Persons having appropriate technical training and experience necessary to be aware of hazards to which they are exposed in performing a task and of measures to minimize the danger to themselves or other persons.



Discount-Merchant.com (800) 281-8860
THE TRUSTED SOURCE FOR PROJECTOR LAMPS AND ACCESSORIES

2

CONNECTIONS

Power Connection to Projector

AC Power (mains) Cord Connection

Use the supplied power cord to connect your projector to the wall outlet. Plug the female power connector into the male connector at the rear side of the projector.

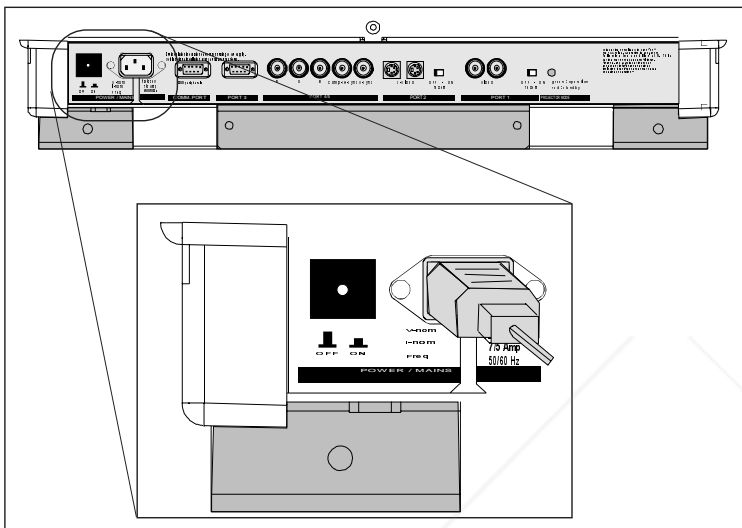

Power Check

The power voltage is autoranging between 100V(-10%) and 240V (+6%).

Switching On/Off

The projector is switched ON and OFF using the power (mains) switch ON/OFF.

Pressed : ON
 Not pressed : OFF

The projector can start in the 'operational mode' (image displayed) or in the 'stand by mode', depending on the power up setting in the service mode.

Stand by indication lamp :

No light up : projector switched off
 Green color : projector in Operational mode
 Red color : projector is in Standby mode.

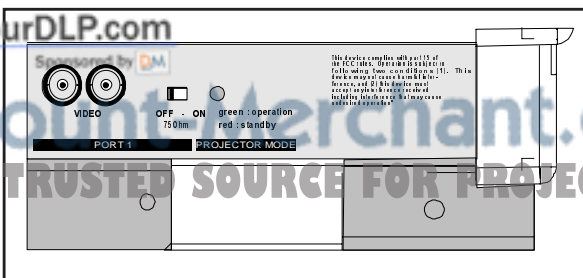

Connections

When starting up the projector, with the power switch or via the stand-by key, the projector can start up in two ways if the "CRT run in" cycle option is switched OFF.

- full white image (projector warm up) or
- immediate image display.

The way of starting up can be set in the service mode.

Source Connections

Input locations

Input facilities

The following source types can be connected to the inputs :

- Composite Video (only in R9002401)
- S-Video (only in R9002401)
- RGBS or RGsB
- RGB3S or RG3sB
- (R-Y)Y(B-Y)S or (R-Y)Ys(B-Y) [component input]
- (R-Y)Y(B-Y)3S or (R-Y)Y3s(B-Y) [component input]

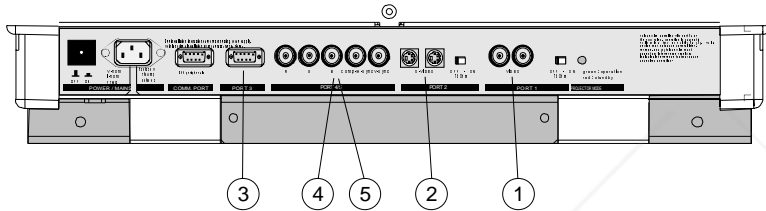

Which source to which input

Image 1 and tabel 1 give an overview of the relation between source type, input terminals and selection key on the RCU.

- 1 Input signal Y/C (luma/chroma)
- 2 Input signal : R, G and B with automatic sync detection between sepearte sync (separate composite sync or with separate Hor and Vert. sync) or sync on green (composite sync).
- 3 Input signal : R-Y, Y and B-Y with separate composite sync or with separate Hor and Vert. sync or with composite sync on Y.
- 4 Input signal : R, G and B with separate Tri level sync or with Tri-level sync on green (optional).
- 5 Input signal : R-Y, Y and B-Y with separate Tri level sync or with composite Tri-level sync (optional).
- * Video or S-Video : switchable in the Picture Tuning menu.

Source No	Projector input	Press digit button
1	Comp. Video*	1
2	S-Video/Comp. Video*	2
3	RGB	3
4/5	RGB	4 or 5
4/5	Component video*	6
4/5	RGB with Tri level sync	7
4/5	Component video* with Tri-level sync	8

*only in R9002401

Composite Video source.

Which signals to the Video Input ?

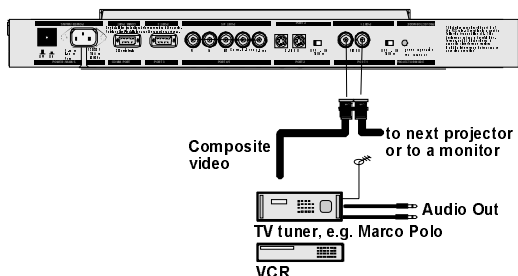

Composite video signals from a VCR, OFF air signal decoder, etc..

Video input selection

With the RCU : press digit button 1

Note on Loop-through

When using the loop-through Video output, then set the termination switch to the 'OFF' position.

75 Ω Termination Switch for Video

Terminate the video input of the projector using the 75 Ω switch next to the video input, when the projector operates alone or when the projector is the last unit in loop-through configuration.

The switch is set to 'ON' : signal terminated

The switch is set to 'OFF' : signal not terminated.

S-Video or Video source to port 2

Which Signals to port 2

Input as S-Video input :

Separate Y-luma/C-chroma signals for higher quality playback of Super VHS signals.

Input as Video input :

Composite video signals from a VCR, OFF air signal decoder, etc..

Pin configuration 4 pin connector

The following pin configuration can be used for S-Video signals and for Video signals.

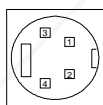

For S-video:

Pin 1: earth(ground) luminance

Pin 2: earth(ground) chrominance

Pin 3:luminance signal(Y)

300mVpp \pm 3dB

Pin 4:chrominance signal(C)

300mVpp \pm 3dB

For video:

Pin 1:earth(ground) video

Pin 2:not connected

Pin 3:video signal

Pin 4:not connected

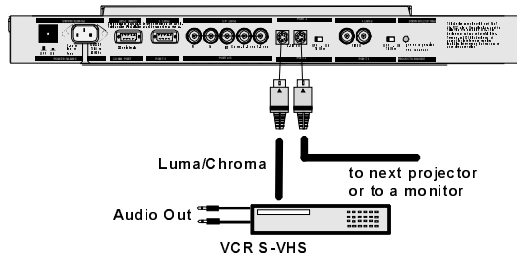

Input selection port 2

With the RCU, press digit button 2

Input Priority setting

Depending on the priority setting in the 'Picture Tuning menu', Video or S-Video can be displayed. If the setting is not correct, handle as follow :

- 1 Press **ADJUST** key to start up the adjustment mode. The 'Adjustment main menu' will be displayed (menu 1).
- 2 Select 'Random Access'.
- 3 Press **ENTER** to select. The 'Choose a setup pattern menu' will be displayed (menu 2).
- 4 Select 'Selected source'.
- 5 Press **ENTER** to display the 'Random Access' menu (menu 3).
- 6 Select 'Picture Tuning'.
- 7 Press **ENTER** to display the picture tuning menu (menu 4).
- 8 Select 'Port2 : Video'.
- 9 Press **ENTER** to toggle between VIDEO or S-VIDEO.
- 10 Press **ADJUST** to return to operational mode.

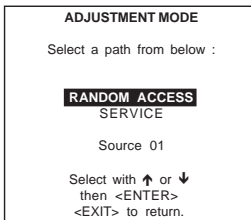

menu1

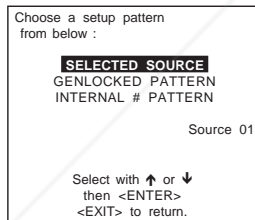

menu2

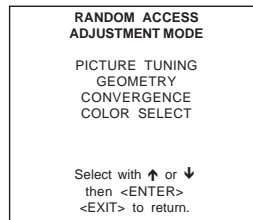

menu3

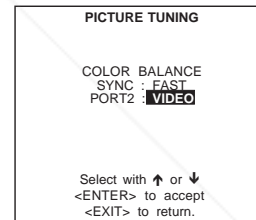

menu4

Note on Loop-through

When using the Port 2 loop-through output, set the Termination switch in the 'OFF' position.

75 Ω Termination Switch for port 2

Terminate the S-Video input of the projector using the 75 Ω switch next to the S-Video input, when the projector operates alone or when the projector is the last unit in loop-through configuration.

The switch is set to 'ON' : signal terminated
 The switch is set to 'OFF' : signal not terminated.

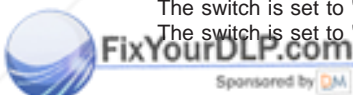

Discount-Merchant.com (800) 281-8860
THE TRUSTED SOURCE FOR PROJECTOR LAMPS AND ACCESSORIES

RGB Analog source to port 3

Which signal to port 3

Connect your RGB source with sync on green, composite or separate sync via an interface to Port 3. Always use an interface when a computer and local monitor have to be connected to the projector as the signal cable coming from the computer is limited to 60 cm due to interferences.

Pin configuration D9 connector of the Analog input.

1	Not connected
2	Ground RGBS
3	RED
4	GREEN
5	BLUE
6	Ground RGBS
7	Ground RGBS
8	Hor/comp. sync
9	Vert. sync

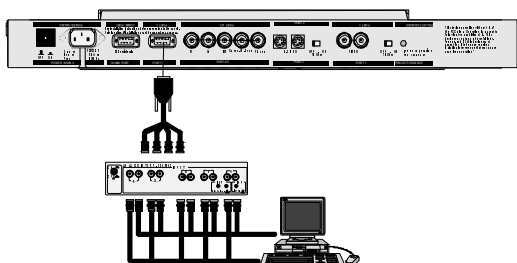

Input selection port 3

With the RCU, press digit button 3

RGB Analog source with composite sync to port 4/5.

Which signal to port 4/5

RGB analog input terminals with separate H and V sync inputs, composite sync input or with sync on green (BNC terminals). The projector detects automatically where the sync signal is located.

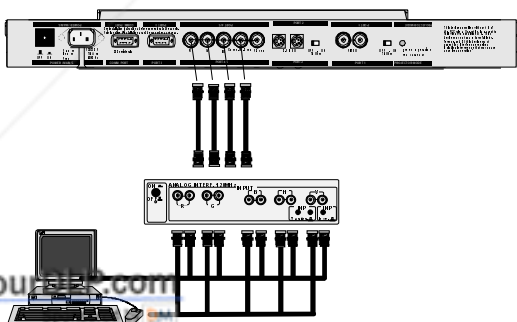

RGBS or RGsB input selection

With the RCU, press digit button 4 or 5.

- 4 when sync on green.
- 5 when separate sync

RGB Analog source with Tri-level sync to port 4/5.

Which signal to port4/5

RGB analog input terminals with Tri level sync input or with Tri-level sync on green (BNC terminals). The projector detects automatically where the sync signal is located.

RGB3S or RG3sB input selection

With the RCU, press digit button 7

Component source to port 4/5.

Which signal to port 4/5

(R-Y)Y(B-Y) analog input terminals with sync input or with sync on the luminance (Y) input (BNC terminals). The projector detects automatically where the sync signal is located.

Component video input selection

With the RCU, press digit button 6

RS232 Connection

RS232 input and RS232 output of the projector.

The projector is equipped with a RS232 port that allows them to communicate with a computer.

Applications

- a) remote control:
 - easy adjustment of the projector via a computer.
 - allow storage of multiple projector configurations and set ups.
 - wide range of control possibilities.
 - address range from 0 to 255.
- b) data communications:
 - sending data to the projector or copying the data from the projector to a hard memory device.

Set up of the Baud Rate for Communication with a Computer.

See 'Changing the baud rate' in chapter 'Service mode'.

Communication port for communication with peripherals

Connecting a RCVDS 05 switcher to the projector.

- Up to 10 inputs (20 inputs when video and S-video) with the RCVDS 05 switcher and up to 90 inputs when 10 RCVDS switchers are linked via the 5-cable output modules.
- Serial communication with the projector.
- Remote control buttons on the RCVDS to control the projector (source selection and analog settings)
- The selected source number will be displayed on a 2 digit display and the selected input modules will be indicated with a LED on the rear.



Discount-Merchant.com (800) 281-8860
THE TRUSTED SOURCE FOR PROJECTOR LAMPS AND ACCESSORIES

3

GETTING STARTED

Remote Control & Local Keypad

Battery Installation in the RCU

Two batteries are packed together with the RCU. Before using your RCU, install first these batteries.

- 1 Remove the battery cover on the backside by pushing the handle a little towards the bottom of the RCU.
- 2 Lift up the top side of the cover at the same time.
- 3 Insert the batteries as indicated in the RCU.
- 4 Put the battery cover on its place.

How to replace the batteries in the RCU ?

To replace the batteries :

- 1 Remove the battery cover on the backside by pushing the handle a little towards the bottom of the RCU.
- 2 Lift up the top side of the cover at the same time.
- 3 Push on the + side of the battery towards the - side
- 4 Lift up the battery at the same time.
- 5 Repeat for the second battery.
- 6 Insert the batteries as indicated in the RCU (battery type AA or LR6 or equivalent).
- 7 Put the battery cover on its place.

Note, only important if more than one projector is installed in the room :

1. the default address is zero (0) or (1). The standard RCU is setup for common address zero. To change the common address of the RCU, contact a BARCO service center. If it is necessary to program the projector address into the RCU, see 'Projector Address'.
2. projector address has to be reprogrammed everytime the battery is changed, the RCU will always switch to the default address.

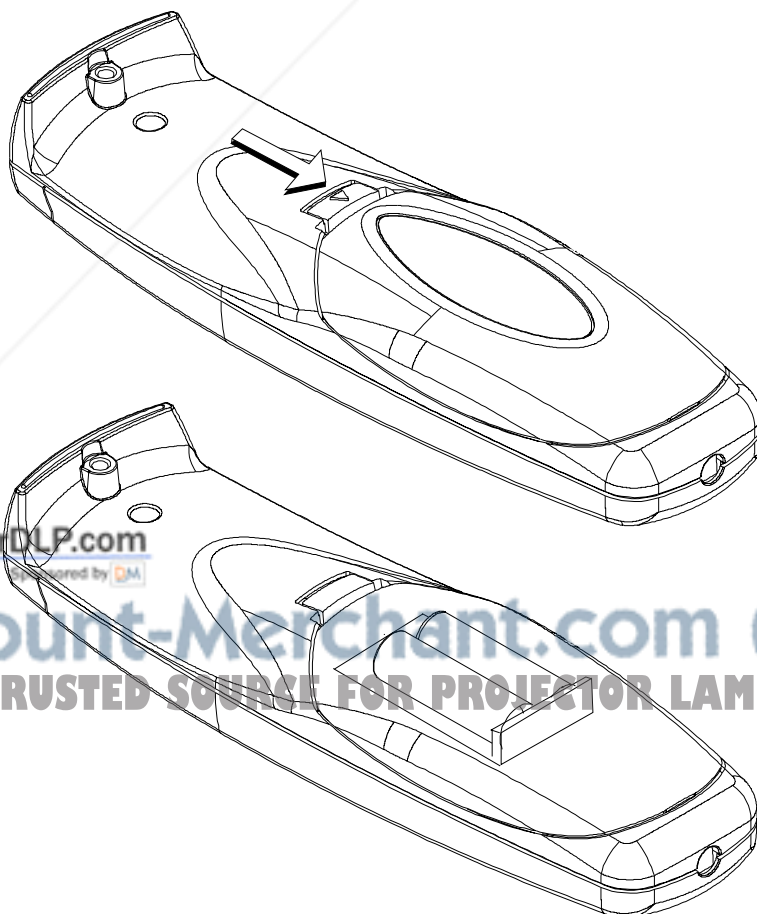

Overview of Functions





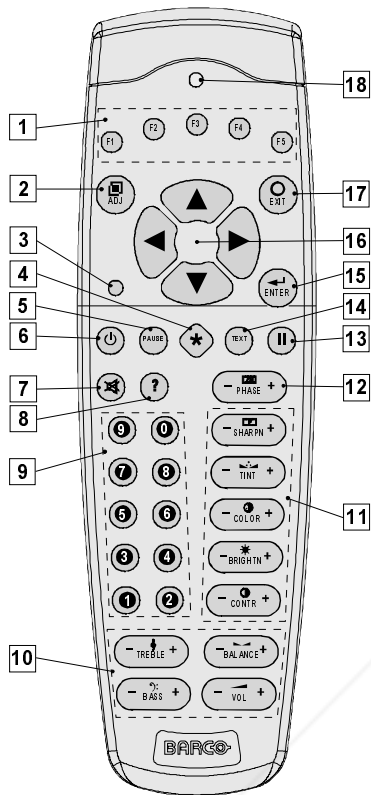

This remote control includes a battery powered infrared (IR) transmitter that allows the user to control the projector remotely. This remote control is used for source selection, control, adaptation and set-up. It includes automatic storing of :

- picture controls (Brightness, Sharpness,....)
- settings

Other functions on the control units are:

- switching between standby and operational modes
- switching to "pause" (blanked picture, full power for immediate restarting)
- direct access to all connected sources
- variable adjustment speed : when pushing continuously on the arrow keys or the picture keys, the adjustment will be executed in an accelerated fashion.



- stand-by 
- pause/park 
- sharpness 
- tint 
- color 
- brightness 
- contrast 

- 1 **Function keys** : user programmable keys with functions for direct access.
- 2 **ADJ.** : ADJUST key, to enter or exit the adjustment mode.
- 3 **Address key** (recessed key), to enter the address of the projector (between 0 and 9). Press the recessed address key with a pencil, followed by pressing one digit button between 0 and 9.
- 4 **Selection key** : no function for this projector
- 5 **PAUSE** : to stop projection for a short time, press 'PAUSE'. The image disappears but full power is retained for immediate restarting.
- 6 **STBY** : stand-by button, to start projector when the power switch is switched on and to switch off the projector without switching off the power switch.
- 7 **Mute** : no function in this projector
- 8 **Help** : on line help information (not yet available)
- 9 **Digit buttons** : direct input selection.
- 10 **Audio controls** : no function
- 11 **Picture controls** : use these buttons to obtain the desired picture analog level.
- 12 **PHASE** : not used.

FixYourDLP.com
Discount-Merchant.com (800) 281-8860
 THE TRUSTED SOURCE FOR PROJECTOR LAMPS AND ACCESSORIES

- 13 **FREEZ** : press to freeze the projected image.
- 14 **TEXT** : when adjusting one of the image controls, e.g. contrast, during a meeting, the displayed bar scale can be removed by pressing 'TEXT' key first. To re-display the bar scale on the screen, press 'TEXT' key again.
- 15 **ENTER** : to start up the adjustment mode or to confirm an adjustment or selection in the adjustment mode.
- 16 **Cursor Keys** : to make menu selections when in the adjustment mode.or to increase or decrease the analog level of the image controls when they are first selected.
- 17 **EXIT** : to leave the adjustment mode or to scroll upwards when in the adjustment mode.
- 18 **RC operating indication** : lights up when a button on the remote control is pressed. (This is a visual indicator to check the operation of the remote control)

Operating the Projector

Switching on

Use the power switch to switch on.

When not pressed, the projector is switched off.

When pressed, the projector is switched on.

When switching on with the power switch, the projector can start now in :

- Operational mode (picture displayed)
- Stand by mode

The way of start up depends on the 'Power up' setting in the service mode.

Start up in Operational Mode

The projector can start up with the selected source or the projector can start up with a warm up cycle message (menu 1).

When this warm up cycle message appears on the screen, the menu offers the possibility to start with a x minutes taking warm up periode (press ENTER) or to skip this cycle (press EXIT). The x minutes and the horizontal frequency can be programmed in the 'Service mode' under the item 'Projector Set Up'.

Note : This warm up periode is built in so that the projector can reach its maximum specifications and minimize all distortions.

When starting this warm up period, a full white image is shifted on the CRT faceplate to avoid a burn in. Every 30 seconds a text box will be displayed on another place on the screen with the remaining time to go.

The image dimensions can be adjusted with the cursor keys to avoid scanning on the edges of the CRT's.

PROJECTOR WARM UP
A FULL WHITE PATTERN WILL BE
GENERATED FOR x MIN.
FOR IMMEDIATE USE OF THE
PROJECTOR, PRESS <EXIT>
WARNING : SKIPPING THIS
PROCEDURE CAN REDUCE THE
INITIAL PICTURE QUALITY OF THE
PROJECTED IMAGE.
YOU CAN ADJUST THE IMAGE
DIMENSIONS WITH THE ARROW
KEYS TO AVOID SCANNING ON THE
EDGES OF THE CRT'S.
THIS OPTION CAN BE DISABLED IN
THE SERVICE MENU

with <ENTER>
<EXIT> to return

menu 1

To interrupt the warm up period, handle as follow :

- 1 Press EXIT, the warm up menu will be redisplayed with the remaining time indication.
- 2 Press EXIT again to quit the warm up cycle and to display the source.



Start Up in Stand by Mode

Sponsored by

The projector starts up in stand by.

Press a digit key corresponding to the desired source or press STBY key.

The projector displays the selected source or the warm up cycle message.

When this warm up message appears on the screen, handle as described in 'Start up in Operational Mode'.

Stationary Image Warning



Do not display a stationary image with full brightness and contrast for longer than 20 min., otherwise you risk damage to the CRT's.

RCU Commands to the Projector

Pointing the RCU to the reflective screen

Point the front of the RCU to the screen surface.

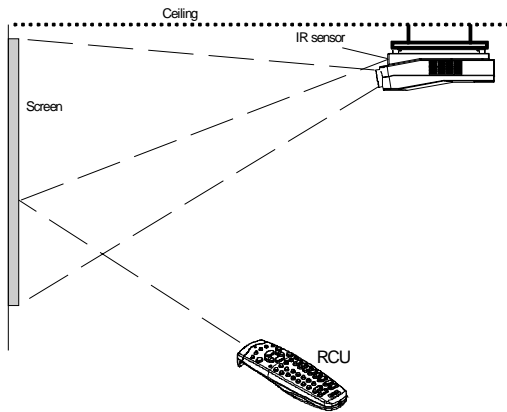

Point the front of the RCU towards one of the IR sensors in the projector.

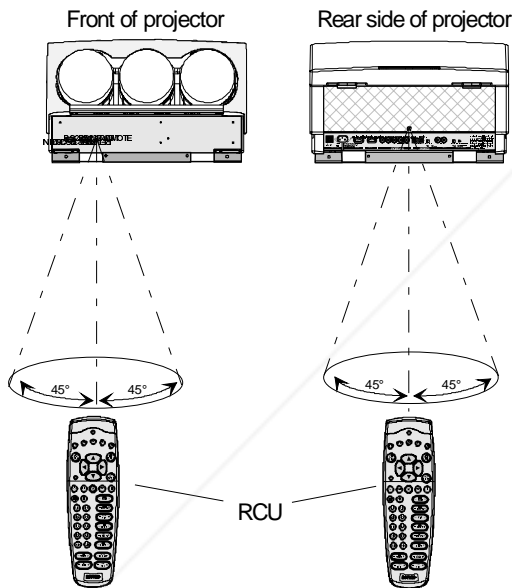

When using the wireless remote control, make sure you are within the effective operating distance (30m, 100ft in a straight line). The remote control unit will not function properly if strong light strikes the sensor window or if there are obstacles between the remote control unit and the projector's IR sensor.

RCU used in a hardwired configuration.

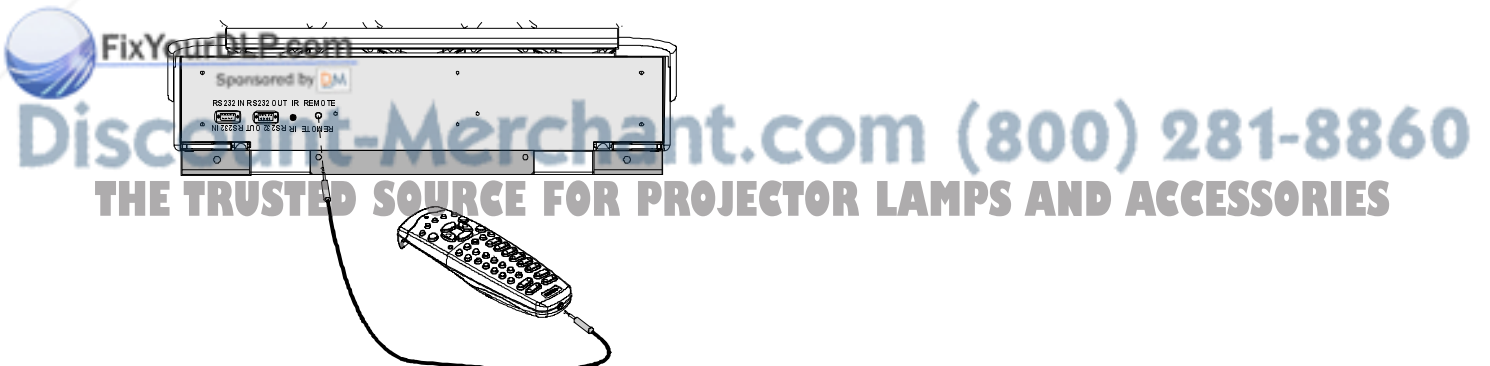

Plug one end of the remote cable in the connector on the bottom of the RCU and the second side in the connector in the rear panel of the projector labelled 'REMOTE'.

Projector address

Why a projector address ?

As more than one projector can be installed in a room, the separate projectors should be separately addressable with a RCU or a computer. So each projector has its own address.

Set up an Individual Projector Address

The set up of a projector address can be done via the software.
See 'Change Projector Address' in Chapter 'Service Mode'

How to control the projector or projectors ?

The projector's address may be set to any value between 0 and 255 which can be set in the Service Mode.
When the address is set, the projector can be controlled now with:

- the RCU for addresses between 0 and 9.
- the Computer, e.g. IBM PC (or compatible), Apple MAC, etc. for addresses between 0 and 255.

Note : A projector will respond to a RCU set to the common address ('0' or '1') regardless of what address is set in the projector itself.

Common Address

Every projector has a common address '0' or '1'. The choice between '0' and '1' can be selected in the Service mode.

Before using the RCU

The RCU is default programmed with address 0 or 1, 'common address'. With that 'common address' programmed into the RCU, every projector, with the same common address set up, will listen to the commands given by this RCU. If it is necessary to control a specific projector, then enter the projector address into the RCU (only when that address is between 0 and 9). The projector with the corresponding address will listen to that specific RCU.

Display the Projector Address on the Screen.

Press the **ADDRESS** key (recessed key on the RCU) with a pencil. The projector's address will be displayed in a 'Text box' (menu 1). This text box disappears after a few seconds.

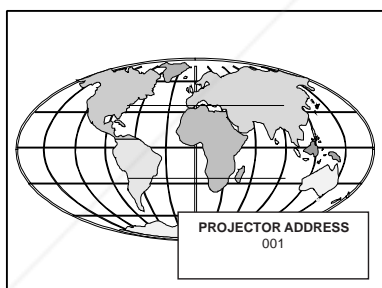

To continue using the RCU with that specific address, it is necessary to enter the same address with the digit buttons (address between 0 and 9) within 5 seconds after pushing the address key. For example : if the Address key displays projector address 003, then press "3" digit button on the RCU to set the RCU's address to match the projector's address. Do not press 003 digits. This will address the remote control to '0' and control all projectors in the room.

If the address is not entered within 5 seconds, the RCU returns to its default address (zero address) and control all projectors in the room.

How to program an address into the RCU?

Press the **ADDRESS** key (recessed key on the RCU) with a pencil and enter the address with the digit buttons within 5 seconds after pushing the address key. That address can be any digit between 0 and 9.

Controlling the Projector

Input selection modes

Source No	Projector input	Press button
1	Comp. Video	1
2	S-Video/Comp. Video	2
3	RGB	3
4/5	RGB (HV, SOG)	4 or 5
4/5	Component Video	6
4/5	RGB with Tri level sync	7
4/5	Component Video with Tri-level sync	8

Input Selection via the RCU.

With the digit buttons, it is possible to select one of the above input modes.

When the source is selected

When a valid and available source is selected, there will be information displayed on the screen about that source. This information includes :

- Source number
- Horizontal frequency
- Vertical frequency

Source 02
Fh= 15.6 kHz
Fv= 50 Hz

When the entry is a non valid source number, a warning appears on the screen : '*input not available*'.

WARNING
input not
available

When a valid source number is selected, the projector will display this source or it will wait on the selected source number until the source becomes available. A message 'source not available' will be displayed for a short time.

WARNING
source not
available

When a Video or S-Video source is selected and no decoder is installed, the projector displays the following message : 'Option not installed'.

WARNING
Option not
installed!

Picture controls

The control keys are located on the right side of the key panel of the RCU and indicated with the name of the control and an icon. When an image control is pressed, a text box with bar scale and the function name of the control, e.g. 'brightness...' appears on the screen (only if text is ON). The length of the bar scale indicates the current memorized setting for this source. The bar scale changes as the + or - side of the button of the control are pressed.

Brightness Control

A correct '*brightness*' setting is important for good image reproduction. Adjust the brightness with the + button and - button until the darkest parts of the picture appear black.

A bar scale gives a visual indication on the screen of the current brightness setting while pressing on the above indicated buttons. If the bar scale is not visible on the screen, press '**TEXT**' once and retry the above indicated buttons.

The bar scale increases when pressing on the + button (higher brightness) and decreases when pressing on the - button (lower brightness).

Contrast Control

A correct 'contrast' setting is important for good image reproduction.

Adjust the contrast to the level you prefer, according to room lighting conditions.

A bar scale gives a visual indication on the screen of the current contrast setting while pressing the + or - buttons . If the bar scale is not visible on the screen, press '**TEXT**' key once and retry the above indicated buttons.

The bar scale increases when pressing on the + button (higher contrast) and decreases when pressing on the - button (lower contrast).

Color Saturation Control

Color saturation is only active for Video and S-Video. Adjust the color saturation using the + and - buttons . A bar scale gives a visual indication on the screen of the current color setting while pressing on the above indicated buttons. If the bar scale is not visible on the screen, press '**TEXT**' key once and retry the above indicated buttons. The bar scale increases when pressing on the + button (richer colors) and decreases when pressing the - button (lighter colors).

Tint Control

Tint is only active for Video and S-Video. Tint control is effective only when using the NTSC 4.43 or NTSC 3.58 system. A bar scale gives a visual indication on the screen of the current tint setting while pressing the + or - buttons . If the bar scale is not visible on the screen, press the '**TEXT**' key once and retry the above indicated buttons.

The bar scale increases when pressing on the + button and decreases when pressing the - button.

Sharpness Control.

Sharpness control only active for Video and S-Video. A bar scale gives a visual indication on the screen of the current sharpness setting while pressing the + or - buttons. If the bar scale is not visible on the screen, press '**TEXT**' key once and retry the above indicated buttons.

The bar scale increases when pressing on the + button (sharper picture) and decreases when pressing on the - button (softer picture).

Sound controls

These keys have no function with this projector.

The Pause key.

When the Pause key is pressed, the image projection is stopped but the projector remains with full power for immediate restart.

To restart the image :

- 1 Press the Pause key,
- 2 Select a source number.

The Freeze key.

When the Freeze key is pressed, the image is frozen until this key is pressed again.



Discount-Merchant.com (800) 281-8860
THE TRUSTED SOURCE FOR PROJECTOR LAMPS AND ACCESSORIES

4

START UP OF THE ADJUSTMENT MODE

Adjustment Mode

Start Up

All picture adjustments are made while in the 'Adjustment mode'.

Press the **ADJUST** key.
The projector displays the 'Main menu' (menu 1).

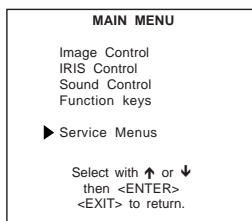

menu1

You are now in the '*Adjustment mode*'. The cursor keys are used to make menu selections and also vertical and horizontal adjustments. The **ENTER** and **EXIT** keys are used to move forward and backward through the menu structure. The **ADJUST** key can be used to terminate the adjustment mode while a path selection menu (head menu) is displayed.

Possible Paths

Depending on the projector configuration the following paths are possible with the 'Main menu'.

Image Control - Allows to change the color temperature of the image and to select another format (adjustment) for the image.

IRIS-Control - This control allows to align the projector automatically using the autoconvergence unit IRIS built into the projector.

Sound Control - Allows to select the sound mode (only when a sound unit is built in).

Function Keys - Gives an overview of the programmed function for each key.

Service Menus - Installation and adjustment menus to set up the projector. Before entering a warning will be displayed.



Discount-Merchant.com (800) 281-8860
THE TRUSTED SOURCE FOR PROJECTOR LAMPS AND ACCESSORIES

5 MAIN MENU

Main Menu

Overview Flowchart

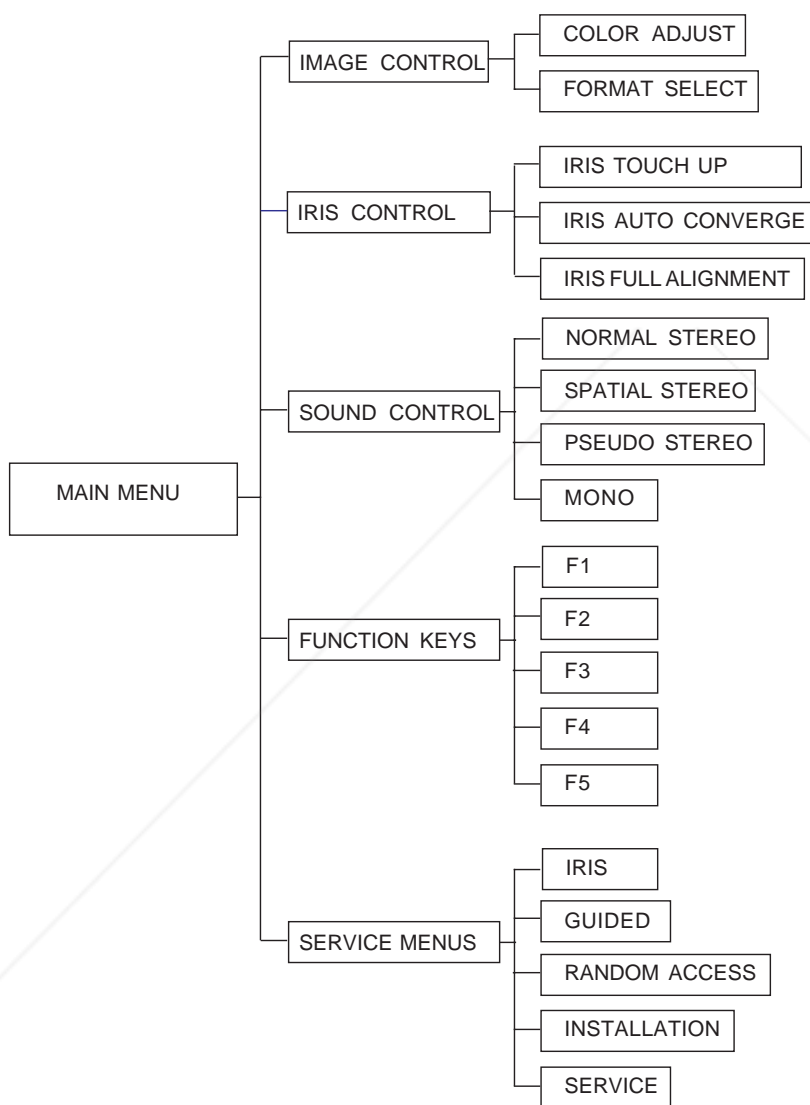

Discount-Merchant.com (800) 281-8860
THE TRUSTED SOURCE FOR PROJECTOR LAMPS AND ACCESSORIES

Image Control

Starting Up

- 1 Push the cursor keys **↑** or **↓** to select 'Image Control' (menu 1).
The selected item will change in color and a marker will be displayed in front of it.
- 2 Press **ENTER** to select.
The 'Image Control' menu will be displayed (menu 2a or 2b).

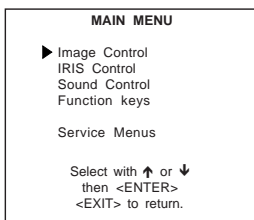

menu1

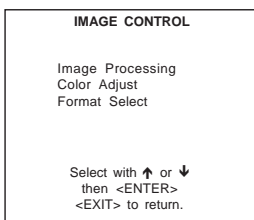

menu2a

Line Multiplier

Why Line Multiplying

If a line multiplier is built in and in the ON state, video images can be displayed with different line and frame rates. That will improve the video image quality.

How to change the Multiplier Setting

To set up the LIMO functions, handle as follow :

- 1 Push the cursor keys **↑** or **↓** to select 'Image Processing' (menu 1)
- 2 Press **ENTER** to select the 'Image Processing' menu.
The Image Processing menu will be displayed (menu 2).

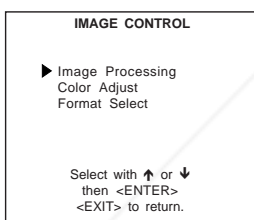

menu1

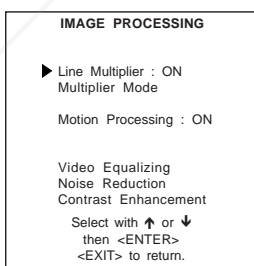

menu2

Line Multiplier ON/OFF

To switch the line multiplier on/off, handle as follow :

- 1 Push the cursor keys **↑** or **↓** to select 'Line Multiplier' (menu 1)
- 2 Press **ENTER** to toggle between ON and OFF.
When in the ON state, all multiplier functions are selectable.



menu1

Multiplier Mode

What can be selected within the multiplier mode ?

The multiplier menu makes it possible to select different scan rate for the connected video signal.

How to start up the Multiplier Mode menu ?

- 1 Push the cursor keys **↑** or **↓** to select 'Multiplier Mode' (menu 1).
- 2 Press **ENTER** to select and to display the Multiplier Mode menu (menu 2a or menu 2b)
Depending on the frequency of the input source, menu 2a or menu 2b will be displayed.

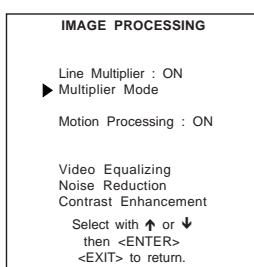

menu 1

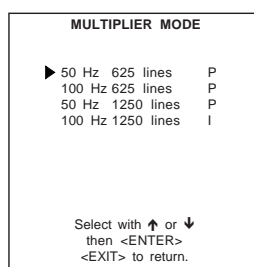

menu 2a

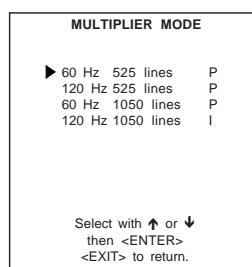

menu 2b

How to change the scan rate ?

- 1 Push the cursor keys **↑** or **↓** to select a new scan rate (menu 1).
- 2 Press **ENTER** to activate this scan rate.
e.g. 100 Hz 625 lines P ==>
Vertical frequency of the image : 100 Hz
Quantity of horizontal lines : 625 lines
Interlace mode : P = Non-interlaced image (progressive scan).

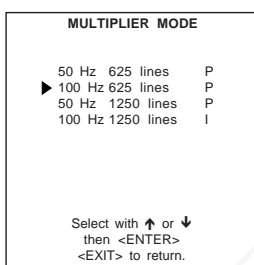

Motion Processing

Why Motion Processing ?

With this function it is possible to recognize whether the source material was originally film or video. That prevents the creation of motion artifacts.

How to activate ?

- 1 Push the cursor keys **↑** or **↓** to select 'Motion Processing' (menu 1).
- 2 Press **ENTER** to toggle between ON and OFF.

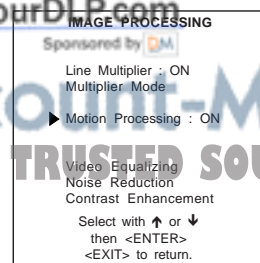

menu 1

Video Equalizing

What can be done ?

The sharpness of the image can be adjusted for 3 frequency ranges (low, medium and high) separately. To make it a little bit easy, 7 pre-programmed factory presets are available. The customer is also free to adjust its own sharpness for the 3 ranges.

How to select Video Equalizing ?

- 1 Push the cursor keys **↑** or **↓** to select 'Video Equalizing' (menu 1).
- 2 Press **ENTER** to display the adjustment menu (menu 2).

How to adjust the Video Equalizing ?

- 1 Push the cursor keys **←** or **→** to select 'Low' or 'Mid' or 'Hi.' or 'Factory Preset : x'
- 2 Push the cursor keys **↑** or **↓** to adjust the sharpness in the choosen band (low, mid, high) or to scroll through the factory preset

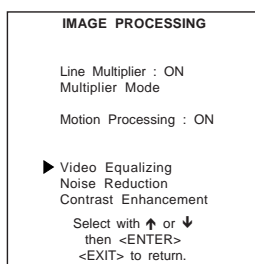

menu1

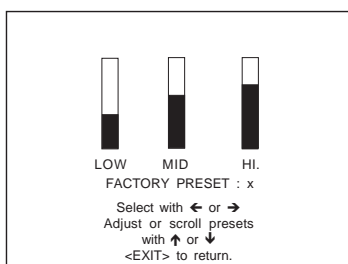

menu2

(x = 1 to 7).

Factory preset 8 is equal to the custom adjustment as made with low, mid and high.

Noise Reduction

What can be done ?

Noisy, lower quality video images can be ameliorated by use of the Noise Reduction feature.

How to select and adjust the Noise Reduction ?

- 1 Push the cursor keys **↑** or **↓** to select 'Noise Reduction' (menu 1).
- 2 Press **ENTER** to display the adjustment text box (menu 2).
- 3 Push the cursor keys **↑** or **↓** to adjust the noise.
- 4 Press **ENTER** to return to the 'Image Processing' menu.

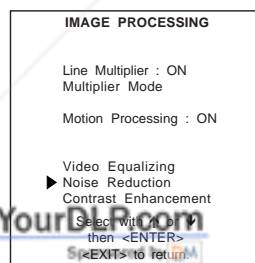

menu1

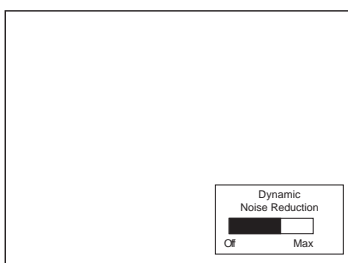

menu2

What can be done ?

Enhancing the contrast results in a more dynamic image.

How to select and adjust the contrast enhancement ?

- 1 Push the cursor keys **↑** or **↓** to select 'Contrast Enhancement' (menu 1).
- 2 Press **ENTER** to display the adjustment text box (menu 2).
- 3 Push the cursor keys **↑** or **↓** to adjust the contrast.
- 4 Press **ENTER** to return to the 'Image Processing' menu.

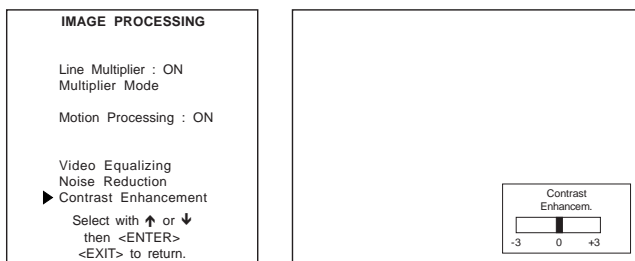

menu 1

menu 2

Color Adjust

What can be done ?

The color temperature of the image can be installed. The customer has the choice between 4 factory preset color temperatures and one custom. This custom color temperature has to be adjusted in the 'Random Access Adjustment Mode'.

How to select 'Color Adjust' and to select a new color temperature?

- 1 Push the cursor keys **↑** or **↓** to select 'Color Adjust' (menu 1).
- 2 Press **ENTER** to display the Color Adjust menu (menu 2).
- 3 Push the cursor keys **↑** or **↓** to select the desired color temperature.
- 4 Press **ENTER** to activate that color temperature.

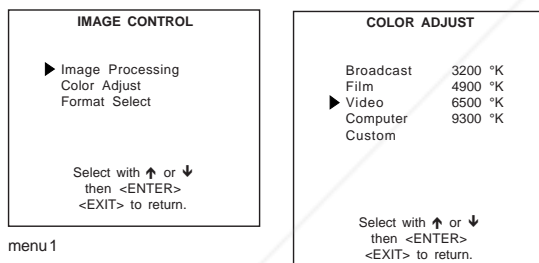

menu 1

menu 1

Format Select

What can be done ?

For one source, up to 8 different sets of settings can be stored. A set of settings is called 'Format'. A 'Format' can be 'available' or 'free'.

'Available' when settings are stored in this location.

'Free' when no setting are stored in this location. This location can be used for storing new adjustment settings for this source.

When 'available', a name of 8 characters can be programmed by the user.

How to select a 'Format' ?

- 1 Push the cursor keys **↑** or **↓** to select 'Format Select' (menu 1).
- 2 Press **ENTER** to display the Format List (menu 2).
- 3 Push the cursor keys **↑** or **↓** to select the desired 'Format'.
- 4 Press **ENTER** to select.

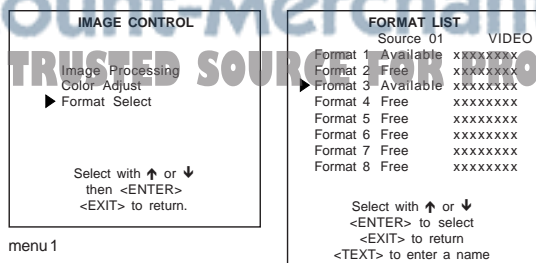

menu 1

menu 2

How to add a name to a 'Format' ?

- 1 Push the cursor keys **↑** or **↓** to select the Format to which a name has to be added (menu 1).
- 2 Press **TEXT** to display the compose menu (menu 2).
- 3 The position of the character which will be edited, will be indicated with a digit. Push the cursor keys **↑**, **↓**, **←** or **→** to select the first character.
- 4 Press **ENTER** to select the choosen character. This character will be inserted on the indicated position. The 'edit character' indication will be incremented with one.
- 5 Continue in the same way for the other characters.
- 6 When the name is completed, press **EXIT** to return to the 'Format List' menu (menu 3).

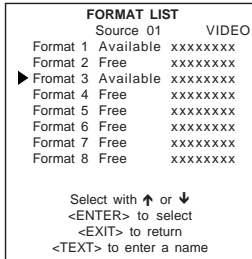

menu 1

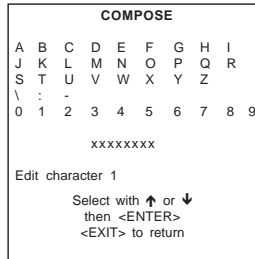

menu 2

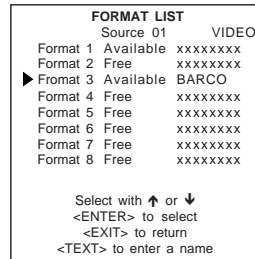

menu 3

How to store the settings to a new 'Format' ?

- 1 Push the cursor keys **↑** or **↓** to select a free format.
- 2 Press **ENTER** to activate.
- 3 Make any adjustment to the image.
- 4 Quit the adjustment mode by pressing **ADJUST**.
The selected format will change from free to available.

IRIS control

With the IRIS functions it is possible to ameliorate the convergence and alignment of the image.

Start Up

- 1 Push the cursor keys **↑** or **↓** to select 'IRIS control' (menu 1).
The selected item will change in color and a marker will be displayed in front of it.
- 2 Press **ENTER** to select.
The 'IRIS control' menu will be displayed (menu 2).

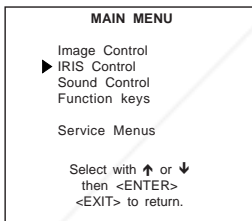

menu 1

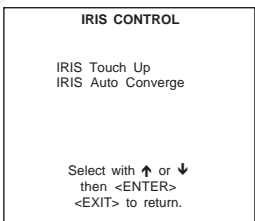

menu 2

Note

Before starting one of the IRIS functions, be sure the projector has warmed up for at least 20 min. Only after 20 min the projector has reached its full specifications.

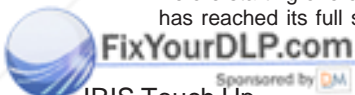

IRIS Touch Up

What can be done ?

If you discover in the middle of the image a convergence misalignment between red, green and blue, the static convergence of this currently selected source can be adjusted with the touch up function.



How to start up the IRIS Touch Up ?

- 1 Push the cursor keys **↑** or **↓** to select 'IRIS Touch Up' (menu 1).
- 2 Press **ENTER** to activate the touch up function.
The process starts and when successfully completed, the projector will return to image display of the current source.

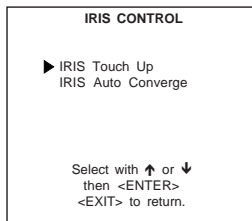

menu 1

IRIS Auto Converge

What can be done ?

The autoconvergence on the current source will be carried out automatically, starting from the existing settings. By projecting alternately red and blue lines, 25 convergence areas are aligned onto the green pattern.

How to start up the IRIS Auto Converge ?

- 1 Push the cursor keys **↑** or **↓** to select 'IRIS Auto Converge' (menu 1).
- 2 Press **ENTER** to activate the autoconvergence function.
The process starts and when successfully completed, the projector will return to image display of the current source.

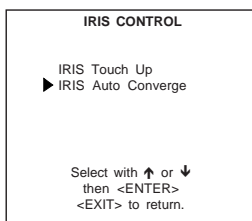

menu 1

Sound Control

What can be done ?

When the sound option is available, the following sound modes can be selected : normal stereo, spatial stereo, pseudo stereo or mono.

How to start up and to select the Sound Control ?

- 1 Push the cursor keys **↑** or **↓** to select 'Sound Control' (menu 1).
- 2 Press **ENTER** to select the Sound Control function.
The Sound Control menu will be displayed (menu 2).
- 3 Push the cursor keys **↑** or **↓** to select the desired sound mode (menu 2).
- 4 Press **ENTER** to activate the chosen sound mode.

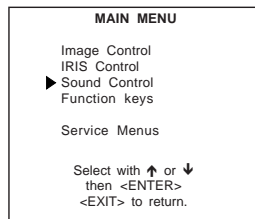

menu1

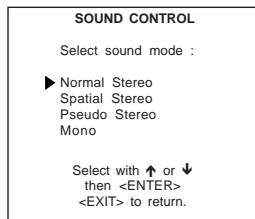

menu2

Function Keys

What can be done ?

Quick access keys to customer pre-programmed adjustments. Almost any adjustment can be added to a function key. To program a function key, it is necessary to enter into the 'Service Menu'. To activate a function key, just press the corresponding key.

The following functions are factory pre-programmed :

- F1 = IRIS Touch up
- F2 = Convergence Red on Green
- F3 = Convergence Blue on Green
- F4 = H & V Size
- F5 = Color Balance

How to get an overview of the programmed keys ?

- 1 Push the cursor keys **↑** or **↓** to select 'Function Keys' (menu 1).
- 2 Press **ENTER** to display an overview of the function keys (menu 2).
- 3 Press **EXIT** to return.

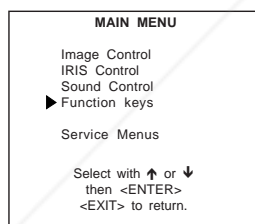

menu1

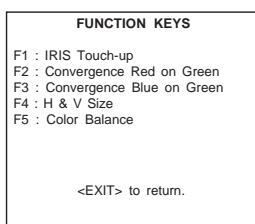

menu2

Service Menus

What can be done ?

With the complete set of Service menus such as IRIS, Guide, Random Access, Installation and Service it is possible to adjust the projector completely.

When entering the Service Menus, a warning will be displayed mentioning that only qualified service personnel may enter the Service menus.

How to enter the Service Menu ?

- 1 Push the cursor keys **↑** or **↓** to select 'Service Menus' (menu 1).
- 2 Press ENTER to select.
A warning will be displayed (menu 2). "Risk of incorrect adjustment of the projector. The following SERVICE menus are reserved to and to be performed only by qualified personnel ! If qualified, press <ENTER> to continue, or if not, <EXIT> to return.
- 3 If qualified, press **ENTER** (menu 3).
If not qualified, press **EXIT**

```

MAIN MENU
Image Control
IRIS Control
Sound Control
Function keys

▶ Service Menus

Select with ↑ or ↓
then <ENTER>
<EXIT> to return.

```

menu 1

```

WARNING

RISK OF INCORRECT
ADJUSTMENT OF THE
PROJECTOR.

The following
SERVICE menus
are reserved to,
and to be performed only
by qualified personnel !

If qualified, press
<ENTER> to continue, or
if not, <EXIT> to return.

```

menu 2

```

ADJUSTMENT MODE

Select a path from below :

IRIS
GUIDED
RANDOM ACCESS
INSTALLATION
SERVICE
Source 01

Select with ↑ or ↓
then <ENTER>
<EXIT> to return.

```

menu 3



Discount-Merchant.com (800) 281-8860
THE TRUSTED SOURCE FOR PROJECTOR LAMPS AND ACCESSORIES

6

ENTERING THE SERVICE MENUS

Service menus

What is available in the Service menus ?

A complete set of adjustments divided in different modes are available to adjust the projector

The different mode are :

IRIS : to autoalign and autoconverge the projector.

Guided : Guided should be selected if the user intends to perform a complete alignment of the projected image. All the necessary geometry and convergence adjustments are executed in a predetermined sequence.

Random Access : Random Access should be selected if the user intends to make only a few adjustments or if the user is highly qualified and knows the sequence of adjustments.

Installation : Installation should be selected if the projector has been relocated and/or a different screen size is desired.

Service : Service should be selected if the user intends to change predefined settings.

How to enter the Service Menus ?

- 1 Press the **ADJUST** key.
The projector displays the 'Main menu' (menu 1).
- 2 Push the cursor keys **↑** or **↓** to select 'Service Menus'
- 3 Press **ENTER** to select.
A warning will be displayed (menu 2).
- 4 If qualified, press **ENTER** to continue
The Service menus main menu will be displayed (menu 3).

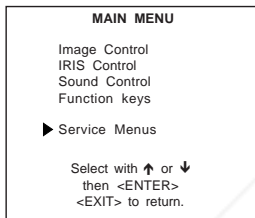

menu1

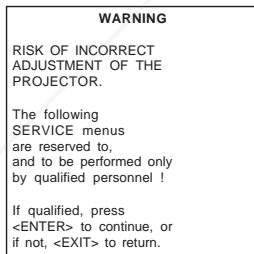

menu2

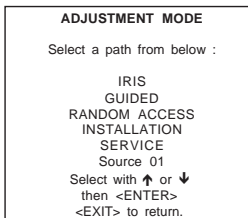

menu3

Password Protection

Some items in the Adjustment mode are password protected. While selecting such an item, the projector asks to enter your password. (Password protection is only available when the password strap on the controller module is ON. Contact a BARCO authorized technician when no password is requested during the adjustment procedure and password protection is desired.)



FixYourDrum.com **Entering the password**

Sponsored by DM

Your password contains 4 digits.

Enter the digits with the numeric keys on the RCU.

Example: 2 3 1 9

For each digit entered, a 'X' appears on the screen under the displayed text 'enter password'.

When the password is correct, you gain access to the selected item.

When the entered password is wrong, the error message 'wrong password !!!' will be displayed.

Discount-Merchant.com (800) 281-8860
THE TRUSTED SOURCE FOR PROJECTOR LAMPS AND ACCESSORIES

Entering the Service Menus

When the password is correct, you gain access to the selected item.

When the entered password is wrong, the error message 'wrong password !!!' will be displayed.

Remark :

When the password is correctly entered, all other password protected items are accessible without re-entering the password.

When re-entering the adjustment mode, it will be necessary to enter your password again when selecting a password protected item.



Discount-Merchant.com (800) 281-8860
THE TRUSTED SOURCE FOR PROJECTOR LAMPS AND ACCESSORIES

7

RANDOM ACCESS ADJUSTMENT MODE

Random access adjustment mode.

Starting Up

Push the cursor keys up or down to highlight "RANDOM ACCESS" and then press ENTER.

Some items in the Random access mode are password protected (when the password function is enabled). Enter your password to continue. All other password protected items are now also available if you stay in the adjustment mode.

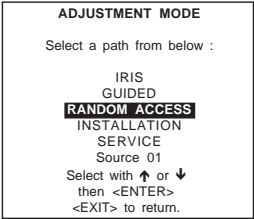

Overview Flowchart

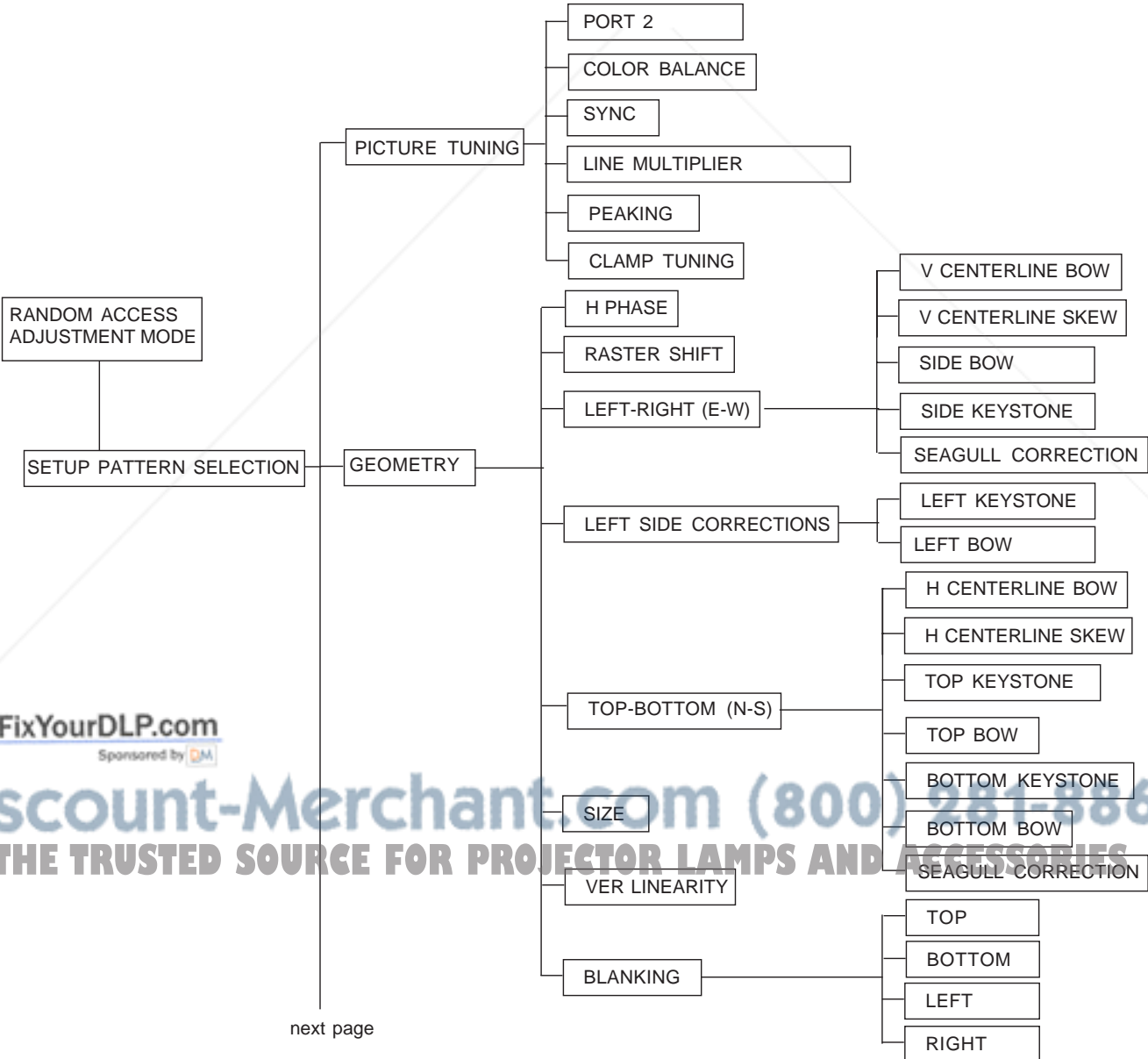

next page



Discount-Merchant.com (800) 251-5860
 THE TRUSTED SOURCE FOR PROJECTOR LAMPS AND ACCESSORIES

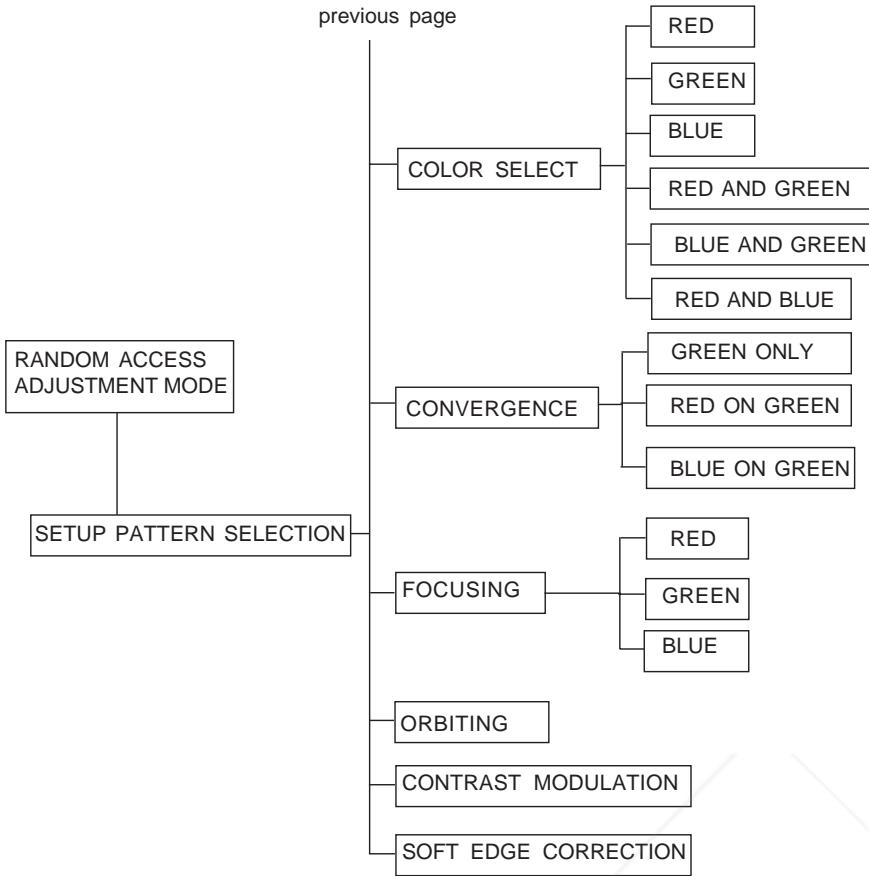

Selecting Setup Pattern

Set up of the Selected Setup Pattern ?

If an external source is connected to the projector, menu 1 will be displayed.

To select the desired setup pattern, handle as follow :

- 1 Push the cursor keys **↑** or **↓** to highlight the desired setup pattern
- 2 Press **ENTER** to select.

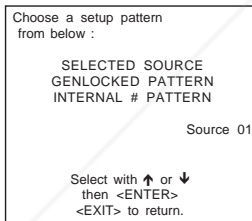

menu 1

Genlocked pattern : internally generated cross hatch pattern, locked on the external source.

Internal # pattern : internally generated cross hatch pattern and locked on internal generated sync signals. (No external source necessary)

If no external source is connected to the projector, the internal cross hatch pattern menu will be displayed.

Note:

The menus in this manual are created for an external source, connected to one of the inputs, and the 'Genlocked Pattern' is selected.

FixYourDLP.com
Sponsored by DM

Discount-Merchant.com (800) 281-8860
THE TRUSTED SOURCE FOR PROJECTOR LAMPS AND ACCESSORIES

Internal Cross Hatch Pattern

When using the Internal Cross Hatch Pattern ?

The Internal # pattern menu will be displayed if the internal cross hatch pattern has been selected or if no source is connected to the projector.

Factory Preset Frequencies

The table below lists the 8 fixed factory preset frequencies available. Another 8 blocks are custom programmable.

To select a desired cross hatch frequency, handle as follow :

- 1 Push the cursor keys **↑** or **↓** to highlight the desired cross hatch frequency (menu 1).
- 2 Push the cursor keys **←** or **→** to scroll to another page.
- 3 Press **ENTER** if the desired block is selected.

kHz/Hz	
15.6/50	PAL/SECAM
15.7/60	NTSC
31.2/50	EDTV
31.5/60	IDTV
31.2/50	HDTV EUREKA
31.5/60	HDTV ATV
33.7/60	HDTV HISION
15.8/60	EGA 1
21.8/60	EGA 2
61.0/76	VGA 1,2
35.5/87	VGA 4
44.2/70	Super VGA 2
48.5/60	Super VGA 1
61.0/76	Super VGA 3
72.1/67	Super VGA 4
89.3/67	SUN 3/260

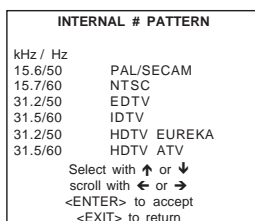

menu1

Random access adjustment mode selection menu.

What is possible ?

This is the main menu for the Random Access adjustment mode.

Through this menu, the following adjustments and features are accessible :

- Picture Tuning
 - Sync slow/fast(only for RGB inputs)
 - Color Balance
 - Peaking
 - Clamp Tuning
 - Port 2 : Video/S-Video
 - Line Doubler / Multiplier

- Geometry
- Convergence
- Focussing
- Color select

And also Orbiting, Contrast modulation, Soft Edge if these options are installed.

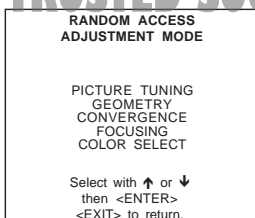

menu1

Picture Tuning

Start up the Picture Tuning

- 1 Push the cursor keys **↑** or **↓** to highlight *Picture tuning* (menu 1).
- 2 Press **ENTER**.
The Picture tuning menu will be displayed.
Depending on the input source, the 'Picture tuning' menu will display different items (menu 2).

- Color Balance
- Sync slow/fast
- Port 2 : Video/S-Video
- Line multiplier
- Peaking
- Clamp Tuning

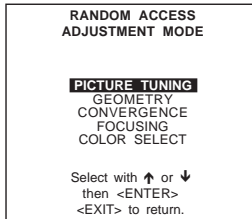

menu 1

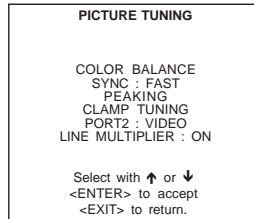

menu 2

Color Balance

What can be done ?

The Color Balance function is used to select or adjust the color temperature of white used by the projector. The Color Balance can be adjusted on two different ways :

- fixed color balance. You have the choice between 3200 K (reddish), 4900 K, 6500 K (white) or 9300 K (bluish).
- Custom white and black balance.

How to select the Color Balance ?

- 1 Push the cursor keys **↑** or **↓** to highlight 'Color Balance' (menu 1).
- 2 Press **ENTER** to select.
The color balance menu will be displayed (menu 2).

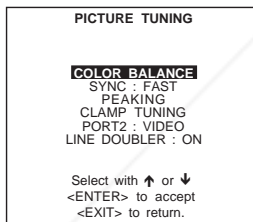

menu 1



menu 2

Fixed Color Balance

To select a fixed color balance, handle as follow :

1. Highlight one of the 4 preprogrammed color temperatures with the cursor keys and
2. press **ENTER** to display the image with the desired color balance.

Custom Color Balance.

The custom color balance adjustment can be divided in two parts, the 'gain' adjustment and the 'cut off' adjustment.

Gain adjustment

1. Push the cursor key **↑** or **↓** to select 'Custom Red & Blue gain' (menu 1).
2. Press **ENTER** to activate the adjustment.
3. Push the cursor key **↑** or **↓** to adjust the red gain
4. Push the cursor key **→** or **←** to adjust the blue gain.

- A bar scale indicates the amount of adjustment.
5. Press **ENTER** to return to the Color Balance menu.
 6. Push the cursor key **↑** or **↓** to select 'Custom Green Gain' (menu 2).
 7. Press **ENTER** to activate the adjustment.
 8. Push the cursor key **↑** or **↓** to adjust the green gain.
 9. Press **ENTER** to return to the Color Balance menu.

Cut Off adjustment

1. Push the cursor key **↑** or **↓** to select 'Custom Red & Blue Cut off' (menu 3).
2. Press **ENTER** to activate the adjustment.
3. Push the cursor key **↑** or **↓** to adjust the red cut-off
4. Push the cursor key **→** or **←** to adjust the blue cut-off.
5. Press **ENTER** to return to the Color Balance menu.
6. Push the cursor key **↑** or **↓** to select 'Custom Green cut off' (menu 4).
7. Press **ENTER** to activate the adjustment.
8. Push the cursor key **↑** or **↓** to adjust the green cut-off.
9. Press **ENTER** to return to the Color Balance menu.

When the color balance is adjusted, press **EXIT** to return.



menu1



menu2



menu3



menu4

Sync Fast/Slow Adjustment

What can be done ?

The sync function is used to minimize horizontal jittering or tearing at the top to the displayed image. The sync slow/fast function is only available for RGB sources.

How to setup the sync function ?

To change the Sync setting, handle as follow :

1. Push the cursor keys **↑** or **↓** to select Sync (menu 1)
2. Press **ENTER** to toggle between *FAST* and *SLOW*.

Note

SYNC is normally used in the SLOW position. The FAST position is used to compensate for unsteady sync pulses from older video playback equipment.

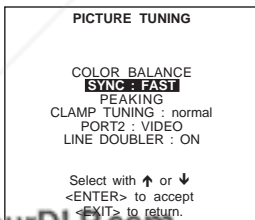

menu1

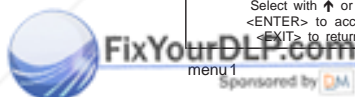

Discount-Merchant.com (800) 281-8860
THE TRUSTED SOURCE FOR PROJECTOR LAMPS AND ACCESSORIES

Peaking

What can be done ?

Peaking improves the contours in an projected image.

How to set up ?

To change the peaking setting, handle as follow :

1. Push the cursor key **↑** or **↓** to select Peaking (menu 1).
2. Press **ENTER** to display the peaking menu (menu 2).
During the creation of new settings for a RGB source the corresponding peaking is switched on as default.

The following frequency areas are available :

- 15 kHz - 45 kHz : Low frequency peaking.
- 45 kHz - 85 kHz : Mid frequency peaking.
- 85 kHz - 110 kHz : High frequency peaking.

If another peaking is desired or switch off, handle as follow :

1. Push the cursor key **↑** or **↓** to select to select the desired frequency area or off (menu 2).
2. Press **ENTER** to activate.

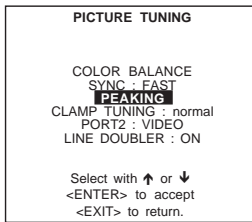

menu 1

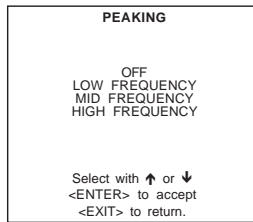

menu 2

Clamp Tuning

What can be done ?

The clamp tuning can be switch between 'Normal' and 'Restoration'.

Normal : for all standard sources and all sources with a backporch > 0.8 μ s or for sources with noise and spikes in the signal.
Restoration : for standard sources with a backporch between 0.4 μ s and 0.8 μ s or for sources with sync separate or sync on green.

How to set up ?

1. Push the cursor key **↑** or **↓** to select Clamp Tuning (menu 1).
2. Press **ENTER** to toggle between 'Normal' and 'Restoration'.
3. Press **EXIT** to return to the picture tuning menu.

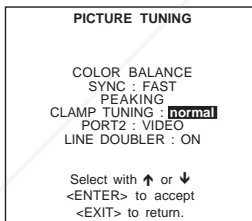

menu 1

Port 2 : Video or S-Video

What can be done ?

Port 2 can be used as a Video or S-Video input.

How to configure port 2 ?

To change the Port 2 setting, handle as follow :

1. Push the cursor key **↑** or **↓** to select Port 2 (menu 1).
2. Press **ENTER** to toggle between Video and S-Video.

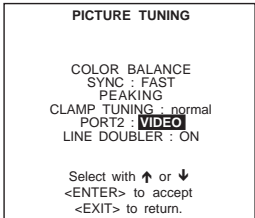

menu1

Line Multiplier*

What can be done ?

This menu item is only available when the projector is equipped with a line multiplier. Line multiplying is only possible for Video, S-Video, Component Video images on standard line frequency and RGB signals on 15 kHz.

- The multiplier eliminates the video line patterns and improves the image stability. In addition,
- the time base correction virtually eliminates the timing jitter caused by the common videocassette recorders.
 - de-interlacing gets rid of line flicker.
 - film mode processing makes sure that material that has been converted from 24 Hz cinema to video (2:2 and 3:2 pull down) is displayed without artifacts.
 - dynamic noise reduction can be used to improve noisy video sources.
 - static contrast enhancement allows the user to adjust the image contrast to personal taste.
 - several detail-enhancing filters bring out details.

The line multiplier when available is active.

The setting of the line multiplier will be saved together with the source number. Each time this source number is selected, the last saved version will be loaded.

How to select when a line multiplier is built in ?

1. Push the cursor key **↑** or **↓** to select Line Multiplier (menu 1).
2. Press **ENTER** to select.
 The line multiplier menu will be displayed (menu 2).

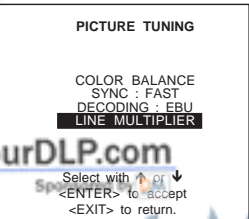

menu1

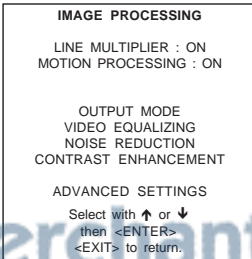

menu2

FixYourDLP.com

Discount-Merch.com (800) 281-8860

THE TRUSTED SOURCE FOR PROJECTOR LAMPS AND ACCESSORIES

* only in R9002401

Switching the multiplier ON/OFF

1. Push the cursor key **↑** or **↓** to select Line Multiplier (menu 1).
2. **ENTER** to toggle between 'Line Multiplier : ON' and 'Line Multiplier : OFF'.
When the line multiplier is on, all items in the menu are accessible.

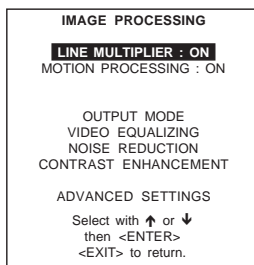

menu 1

Motion Processing

Why Motion Processing ?

With this function it is possible to recognize whether the source material was originally film or video. That prevents the creation of motion artifacts.

How to activate ?

1. Push the cursor keys **↑** or **↓** to select 'Motion Processing' (menu 1).
2. Press **ENTER** to toggle between ON and OFF.

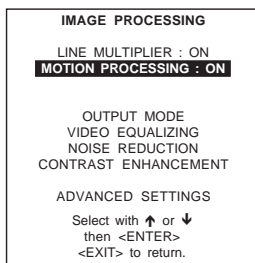

menu 1

Output Mode

What can be done ?

Within the output mode menu, it is possible to select a new output mode for a given input signal. The input signal can be line multiplied, interlaced or non-interlaced.

How to select a new scan rate ?

- 1 Push the cursor keys **↑** or **↓** to select 'Output Mode' (menu 1).
- 2 Press **ENTER** to display the output mode menu (menu 2a or 2b)
Depending on the frequency of the input source, menu 2a or 2b will be displayed.
If your input signal is PAL or SECAM signal, menu 2a will be displayed. If it is a NTSC signal, menu 2b will be displayed.

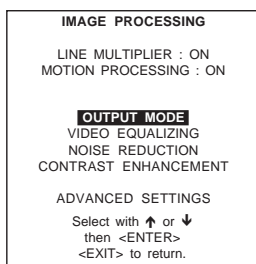

menu 1

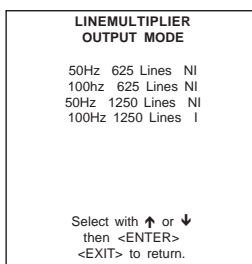

menu2a

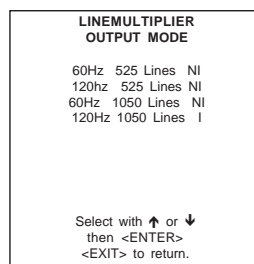

menu2b

- 3 Push the cursor keys **↑** or **↓** to select a new scan rate (menu 3).
- 4 Press **ENTER** to activate this scan rate.
e.g. 100 Hz 625 lines P ==>
Vertical frequency of the image : 50 Hz
Quantity of horizontal lines : 625 lines
Interlace mode : NI = Non-interlaced image (progressive scan).

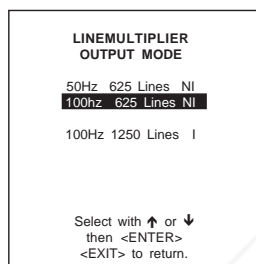

menu3

Video Equalizing

What can be done ?

The sharpness of the image can be adjusted for 3 frequency bands (low, medium and high) separately. In addition to the pre-programmed factory presets a customized adjustment of the sharpness for 3 ranges is also possible.

How to select Video Equalizing ?

- 1 Push the cursor keys **↑** or **↓** to select 'Video Equalizing' (menu 1).
- 2 Press **ENTER** to display the adjustment menu (menu 2).

How to adjust the Video Equalizing ?

- 1 Push the cursor keys ← or → to select 'Low' or 'Mid' or 'Hi.' or 'Factory Preset : x'
- 2 Push the cursor keys ↑ or ↓ to adjust the sharpness in the choosen band (low, mid, high) or to scroll through the factory preset (x = 1 to 7).
Factory preset 8 is equal to the custom adjustment as made with low, mid and high.

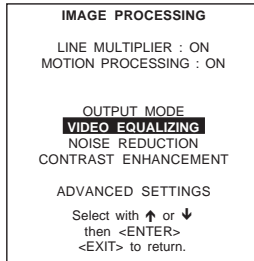

menu 1

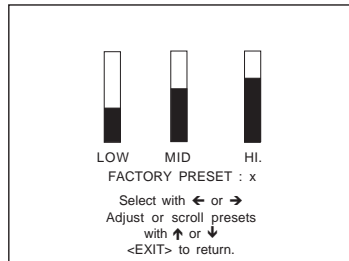

menu 2

Noise Reduction

What can be done ?

Noisy, lower quality video images can be ameliorated by use of the Noise Reduction feature.

How to select and adjust the Noise Reduction ?

- 1 Push the cursor keys ↑ or ↓ to select 'Noise Reduction' (menu 1).
- 2 Press **ENTER** to display the adjustment text box (menu 2).
- 3 Push the cursor keys ↑ or ↓ to adjust the noise.
- 4 Press **ENTER** to return to the 'Image Processing' menu.

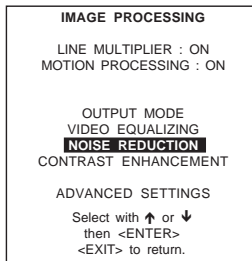

menu 1

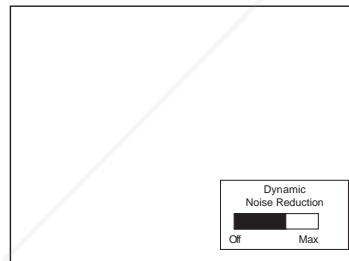

menu 2

Contrast Enhancement

What can be done ?

Enhancing the contrast results in a more dynamic image.

How to select and adjust the contrast enhancement ?

- 1 Push the cursor keys ↑ or ↓ to select 'Contrast Enhancement' (menu 1).
- 2 Press **ENTER** to display the adjustment text box (menu 2).
- 3 Push the cursor keys ↑ or ↓ to adjust the contrast.
- 4 Press **ENTER** to return to the 'Image Processing' menu.

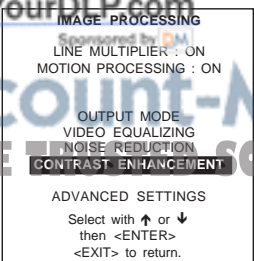

menu 1

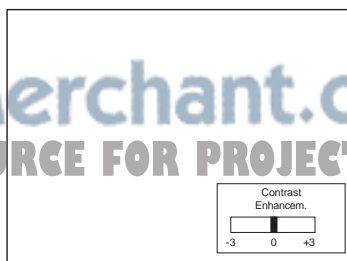

menu 2

Advanced Settings

How to select the Advanced Settings ?

1. Push the cursor key **↑** or **↓** to select 'Advanced Settings' (menu 1).
2. Press **ENTER** to select.
The advanced Settings menu will be displayed (menu 2).
A warning is displayed in the advanced settings menu : "Advanced adjustment should be performed only by qualified personnel".

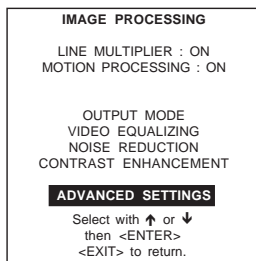

menu 1

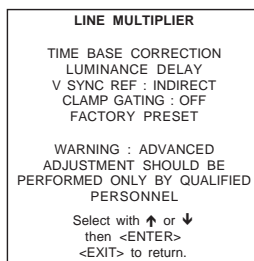

menu 2

Time Base Correction

Why Time Base Correction ?

With the Time Base Correction function it is possible to clean-up low quality videotape noise to obtain a more stable image.

How to activate ?

1. Push the cursor keys **↑** or **↓** to select 'Time Base Correction' (menu 1).
2. Press **ENTER** to toggle between ON and OFF.

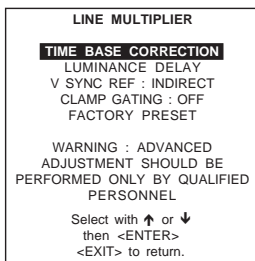

menu 1

Luminance Delay

When is it necessary ?

When a color shift is recognized on the screen. e.g. if color bars are projected and a line between the color is recognized.

How to adjust ?

1. Push the cursor key **↑** or **↓** to select 'Luminance delay' (menu 1).
2. Press **ENTER** to activate.
3. Push the cursor key **↑** or **↓** to adjust the luminance delay until the color shift is eliminated (menu 2).
4. Press **ENTER** to return to the 'Advanced Settings' menu.

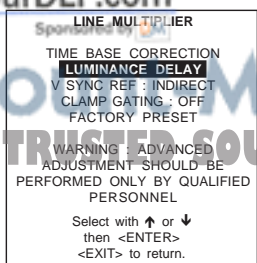

menu 1

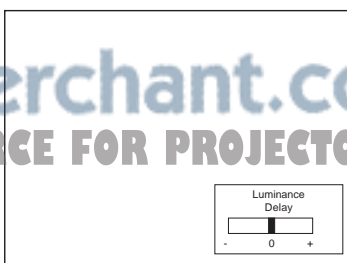

menu 2

Vertical Sync Reference

Why necessary ?

DIRECT: This sync processing has the disadvantage that glitches and other disturbances in the video signal sometimes get passed and hence may cause problems in the image.

INDIRECT: This sync processing throws away any disturbances that are not really sync signals. By source switching a rolling effect on the image can occur. This sync processing is preferred especially with low quality material.

How to change the vertical sync reference ?

1. Push the cursor key **↑** or **↓** to select 'V Sync Ref' (menu 1).
2. Press **ENTER** to toggle between 'direct' and 'indirect'.
Default position : indirect.

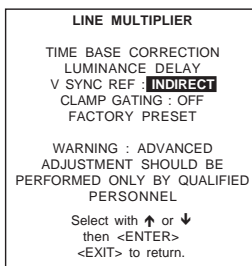

menu 1

Clamp Gating

Why necessary ?

Clamp Gating is useful when protection signals are present in the vertical interval of the video signal that would otherwise confuse the LiMoPro

How to change the Clamp Gating ?

1. Push the cursor key **↑** or **↓** to select 'Clamp Gating' (menu 1).
2. Press **ENTER** to toggle between ON and OFF.
Default position : OFF.

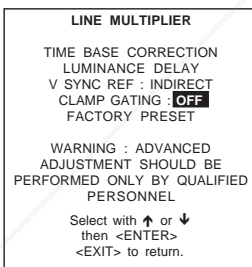

menu 1

Factory Preset

What can be done ?

All settings for the line multiplier can be set to factory preset settings.

What are the factory preset settings ?

The factory preset settings are :

Time base correction : on
Luminance delay : 0
Vertical sync reference : indirect
Clamp gating : off

Limo Pro Options

How to select the Limo Plus Options ?

1. Push the cursor key **↑** or **↓** to select 'Limo Plus Options' (menu 1).
2. Press **ENTER** to display the limo plus menu (menu 2).

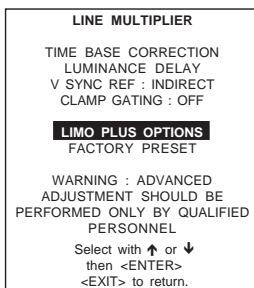

menu 1

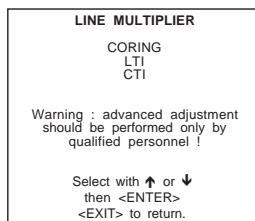

menu 2

Coring

What can be done ?

With coring, a noise threshold will be set for all filters.

How to set up ?

1. Push the cursor key **↑** or **↓** to select 'Coring' (menu 1).
2. Press **ENTER** to select coring.
3. Use the cursor keys to adjust the coring (noise threshold).

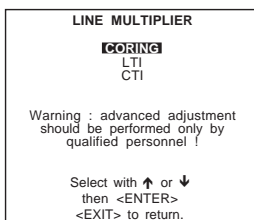

menu 1

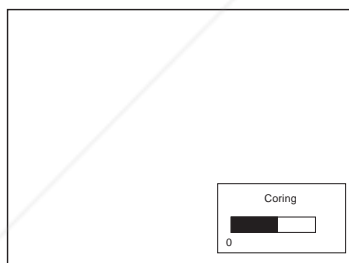

menu 2

LTI

What can be done ?

LTI = Luminance transient improvement.

This function makes the luminance transients sharper (from dark areas to highlight areas) without overshoot, undershoot or ringing.

How to set up ?

1. Push the cursor key **↑** or **↓** to select 'LTI' (menu 1).
2. Press **ENTER** to select.
3. Use the cursor keys to change the LTI value. Only 7 steps are possible.

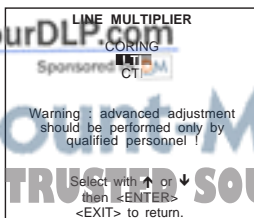

menu 1

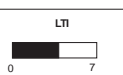

menu 2



Adjust LTI for max black and white transient improvement

CTI

What can be done ?

CTI = Chrominance (color) transient improvement.

This function makes the chrominance transients (from one color to another) sharper without overshoot, undershoot or ringing.

How to set up ?

1. Push the cursor key **↑** or **↓** to select 'CTI' (menu 1).
2. Press **ENTER** to select.
3. Use the cursor keys to change the CTI value. Only 7 steps are possible.

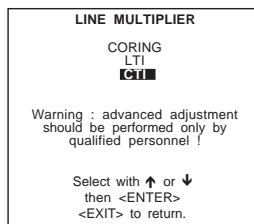

menu 1

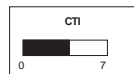

menu 2

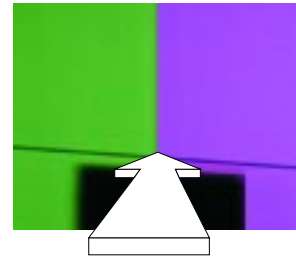
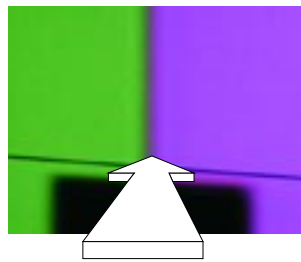

Adjust CTI for max colour transient improvement

Geometry Adjustments

What can be done ?

The geometry adjustments have to be done only on the green image. These adjustments are automatically implemented for the other color images. The following adjustments can be adjusted Left-right (EW) and Top-Bottom Corrections, Blanking, Horizontal Amplitude, Vertical Amplitude, Vertical Linearity and Horizontal Phase.

Start Up

To start up the geometry corrections, handle as follow :

1. Push the cursor key **↑** or **↓** to highlight 'Geometry' (menu 1).
 2. Press **ENTER** to select.
- The Geometry menu will be displayed on the screen (menu 2).

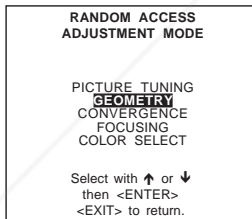

menu 1

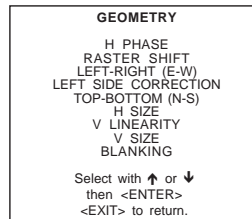

menu 2

Important

The convergence corrections are disabled during geometry corrections. The blanking corrections are only enabled during the blanking adjustments.



Horizontal Phase Adjustment

Start Up

1. Push the cursor key **↑** or **↓** to highlight 'H Phase' (menu 1).
2. Press **ENTER** to activate.

The external image with a text box in the middle will be projected.

Note

No horizontal phase adjustment is available on the internal # pattern.

How to adjust ?

If the raster shift is correctly adjusted, the H Phase text box is projected in the middle of the raster. At that moment, the "><" icon indicates the middle of the raster.

Adjust the H Phase control until the middle of the projected image is equal with the middle of >< icon.

Image 1 : Push the cursor key to the right to correct.

Image 2 : Push the cursor key to the left to correct.

Note : If the genlocked pattern was selected during the start up of the random access mode, the external source will be displayed.

A bar scale and a number indicator (between 0 and 100) on the screen give a visual indication of the horizontal phase adjustment.

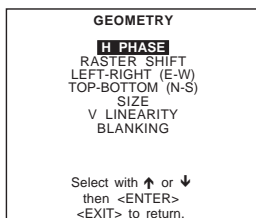

menu1

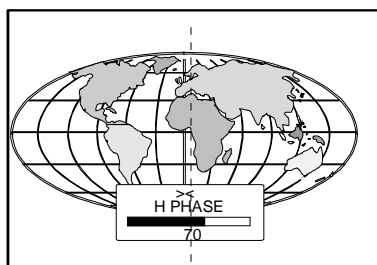

image 1

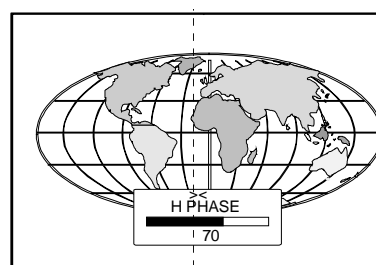

image 2

Raster Shift Adjustment

What has to be done ?

The green raster must be centered both horizontally and vertically on the center of the CRT surface. To center the green raster, look into the green lens and use the cursor keys to move the raster.

CAUTION

It is necessary to look into the lenses to perform these adjustments. To avoid eye discomfort while looking into the lenses, reduce the contrast and gradually increase the brightness level until the raster becomes visible on the face of the CRT.

Start up

To start the adjustment (image 1) :

1. push the cursor key ↑ or ↓ to highlight Raster Shift (menu 1).
2. press **ENTER** to display the coarse shift menu (menu 2)
3. Select first green horizontal and adjust.
4. Continue with green vertical.
5. Shift red and blue on green.

Note

Horizontal and Vertical shifts for Red and Blue should end up with a setting close to 50%. If these settings are significantly greater or lesser than 50%, contact a BARCO authorized service technician.

Warning

In order to ensure maximum CRT longevity and to avoid CRT damage, do not shift the raster outside the phosphor area of the CRT.

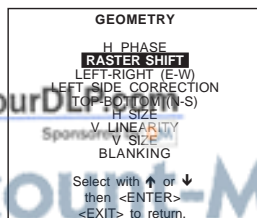

menu1

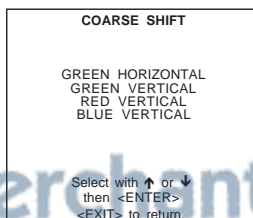

menu2

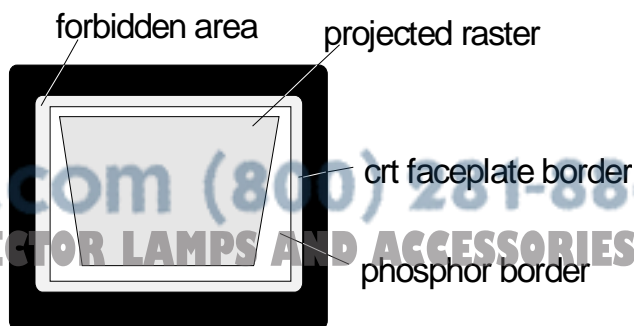

image 1

Left-Right (east-west) Adjustments

What can be adjusted ?

Left-right and center adjustments affect only the vertical lines of the projected image. The skew, the bow, the keystone and the seagull distortion can be adjusted.

Start up

To start up the left-right and center adjustments, follow the next procedure :

1. Push the cursor key **↑** or **↓** to highlight **LEFT-RIGHT (E-W)** (image 1).
2. Press **ENTER** to select.

The 'Left-Right' menu will be displayed (menu 2).

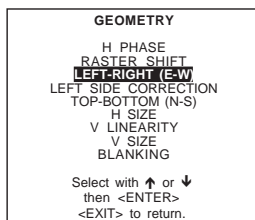

menu 1

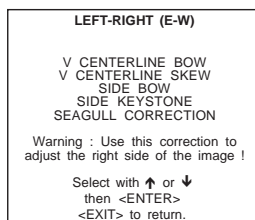

menu 2

Note

Only the green image is displayed while making left-right adjustments. The red and blue images will automatically be corrected in the same manner. Convergence corrections are automatically disabled for the duration of these adjustments.

Which adjustment can be executed ?

The following adjustments can be executed

- vertical centerline bow
- vertical centerline skew
- side keystone (left - right)
- side bow (left - right)

All adjustment are indicated on the screen with the function name, a bar scale and a number between 0 and 100. Adjust the next alignments until the vertical lines are straight.

How to enter an alignment ?

To enter an alignment :

1. Push the cursor key **↑** or **↓** to highlight a function
2. Press **ENTER** to activate this function.
3. Press **EXIT** to return.

Warning

Use this correction to adjust the right side of the image.

LEFT-RIGHT

V CENTERLINE BOW

V CENTERLINE SKEW

SIDE BOW

SIDE KEYSTONE

SEAGULL CORRECTION

Select with ↓ or ↑
then <ENTER>
<EXIT> to return.

Corrects for curvature of the vertical lines in the middle of the image.	
Corrects the tilting of the vertical lines in the middle of the image.	
Corrects for curvature of the vertical lines on the right side	
Corrects the keystone geometry correction of the vert. lines on the right side	
Correct by pushing the cursor keys to the right	Correct by pushing the cursor keys to the left

Seagull correction

What can be done ?

Use this correction only if, after adjusting the vertical lines with the side bow or side keystone, still a 'S' deformation is visible on the left and the right side of the image.
The default value on the bar scale for this correction is 50.

Start up

To correct the Seagull Correction :

1. Push the cursor key ↑ or ↓ to highlight SEAGULL CORRECTION (menu 1)
2. Press ENTER to activate.
Eliminate the deformation by pushing the cursor key ← or → until a straight line is obtained (image 1).

LEFT-RIGHT (E-W)

V CENTERLINE BOW

V CENTERLINE SKEW

RIGHT BOW

RIGHT KEYSTONE

LEFT BOW

LEFT KEYSTONE

SEAGULL CORRECTION

Select with ↑ or ↓
then <ENTER>
<EXIT> to return.



Image 1



FixYourDLP.com
Sponsor of

Discount-Merchant.com (800) 281-8860

THE TRUSTED SOURCE FOR PROJECTOR LAMPS AND ACCESSORIES

Left Side Correction

What can be done ?

Fine tuning on the left side of the image for bow and keystone correction.

Only the green image is displayed while making the left side adjustments. The red and blue images will automatically be corrected in the same manner.

The convergence corrections are automatically disabled for the duration of these adjustments.

Warning

Before starting the left side correction, insure that the side bow and keystone adjustments are done prior to these fine adjustments!

Start Up

1. Push the cursor key **↑** or **↓** to highlight 'Left Side Correction' (menu 1).
2. Press **ENTER** to display the Left Side Correction menu (menu 2).

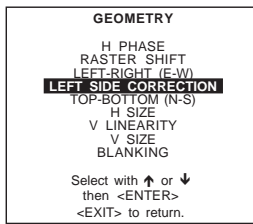

menu1

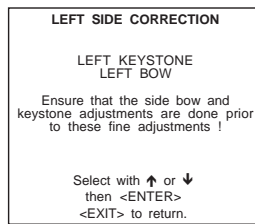

menu2

Left Side Adjustments

1. Push the cursor key **↑** or **↓** to highlight the desired correction (menu 1).
2. Press **ENTER** to start the adjustment.
3. Press **EXIT** to return when the adjustment is finished.

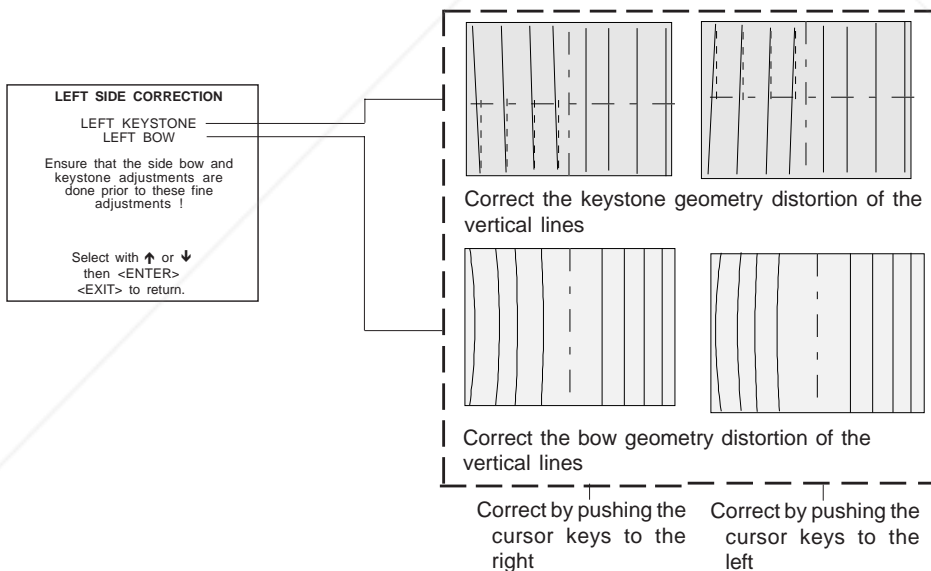

Top-Bottom (north-south) Adjustments

What can be adjusted ?

Top-Bottom and center adjustments affect only the horizontal lines of the projected image. The skew, the bow, the keystone and the seagull deviation can be adjusted.

Start Up

To start up the Top-Bottom and center corrections, follow the next procedure :

1. Push the cursor key **↑** or **↓** to highlight TOP-BOTTOM (N/S) (menu 1).
2. Press **ENTER** to select.
The Top-Bottom menu will be selected (menu 2).

```

GEOMETRY
H PHASE
RASTER SHIFT
LEFT-RIGHT (E-W)
LEFT SIDE CORRECTIONS
TOP-BOTTOM (N-S)
H SIZE
V LINEARITY
V SIZE
BLANKING

Select with ↑ or ↓
then <ENTER>
<EXIT> to return.

```

menu 1

```

TOP-BOTTOM (N-S)
H CENTERLINE BOW
H CENTERLINE SKEW
TOP KEYSTONE
TOP BOW
BOTTOM KEYSTONE
BOTTOM BOW
SEAGULL CORRECTION

Select with ↑ or ↓
then <ENTER>
<EXIT> to return.

```

menu 2

Note

Only the green image is displayed while making top-bottom adjustments. The red and blue images will automatically be corrected in the same manner. Convergence corrections are automatically disabled for the duration of these adjustments.

Which adjustment can be executed ?

The following adjustments can be executed

- horizontal centerline bow
- horizontal centerline skew
- Top bow
- Top keystone
- Bottom bow
- Bottom keystone

All adjustment are indicated on the screen with the function name, a bar scale and a number between 0 and 100. Adjust the next alignments until the horizontal lines are straight.

How to enter an alignment ?

To enter an alignment :

1. Push the cursor key **↑** or **↓** to highlight a function
2. Press **ENTER** to activate this function.
3. Press **EXIT** to return.

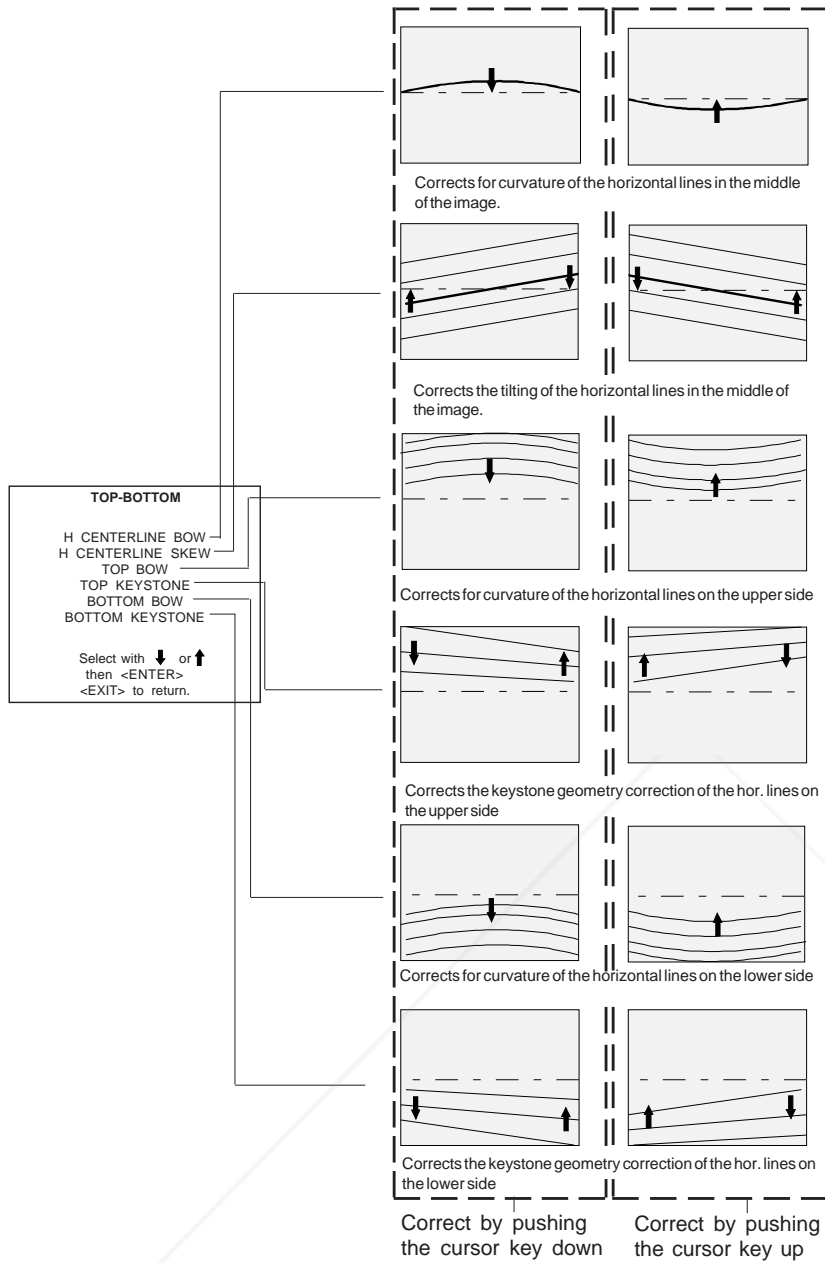

Seagull correction

What can be done ?

Use this correction after the image has been adjusted with top and bottom bow and keystone. If still a deformation (like a seagull) on top and bottom of the image is visible, proceed to the seagull correction. Due to interaction, it is possible that the top and bottom bow have to be readjusted after adjusting the seagull correction to obtain an improved image. The default value on the bar scale of this correction is 50.

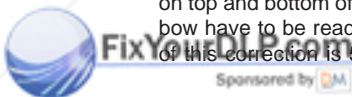

Sponsored by DM

Discount-Merchant.com (800) 281-8860
THE TRUSTED SOURCE FOR PROJECTOR LAMPS AND ACCESSORIES

Start up

To correct the Seagull Correction :

1. Push the cursor key \uparrow or \downarrow to highlight *SEAGULL CORRECTION* (menu 1)
2. Press **ENTER** to activate.

Eliminate the deformation by pushing the cursor key \uparrow or \downarrow until a straight line is obtained (image 1).

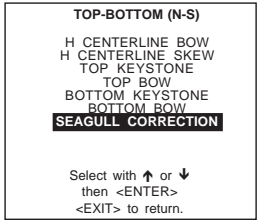

menu 1

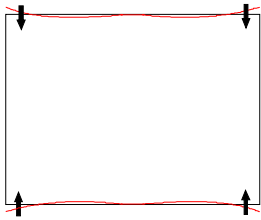

image 1

Horizontal Size Adjustment

What can be done ?

To adjust (correct) a little bit the horizontal picture size (when the projector is on its correct position) in regard with the installed screen

Start up

1. Push the cursor key \uparrow or \downarrow to highlight 'H Size' (menu 1).
2. Press **ENTER** to activate (menu 2).
3. Push the cursor key \leftarrow or \rightarrow until the exact image width is obtained (horizontal size) (image 1).

Note :

- If the internal # pattern was selected, this pattern remains on the screen.
- If the genlocked pattern was selected, the external source will be displayed.

A bar scale and a numeric indicator help to gauge the size adjustment.

Hint

In order to avoid loss of resolution in the projected image and to ensure maximum CRT longevity, do not use an excessively small horizontal size setting.

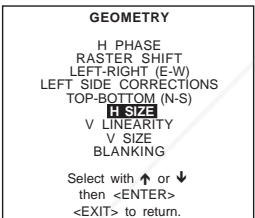

menu 1

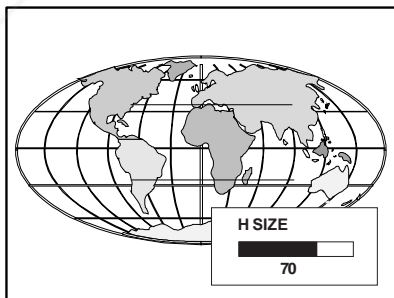

menu 2

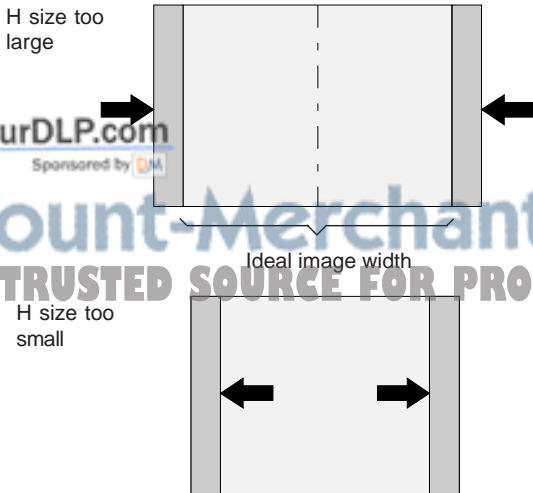

image 1

FixYourDLP.com
Sponsored by DLP

Discount-Merchant.com (800) 281-8860
THE TRUSTED SOURCE FOR PROJECTOR LAMPS AND ACCESSORIES

Vertical Linearity Adjustment

What can be done ?

The vertical linearity adjustment function corrects for vertical non-linearities which extend from the center of the image to the top and bottom of the image.

Start Up

To start up the vertical linearity adjustment :

1. push the cursor key **↑** or **↓** to highlight V Linearity (menu 1).
2. press **ENTER** to activate (menu 2).
Adjust the vertical linearity with the cursor keys until the distances between the horizontal lines of the set up pattern are equal from top to bottom (image 1).

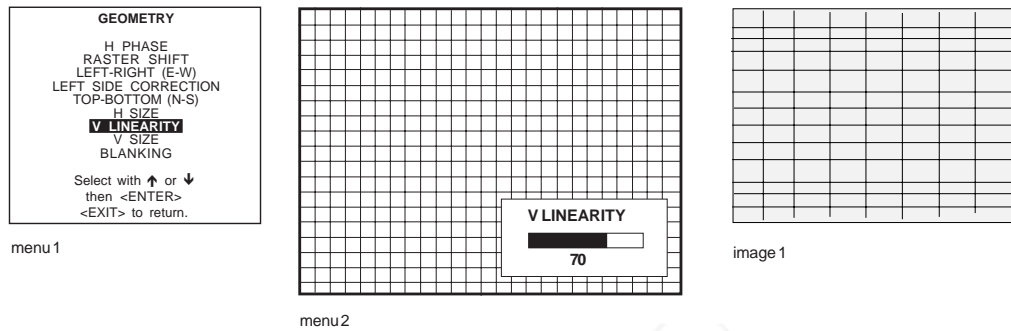

Vertical Size Adjustment

What can be done ?

To adjust (correct) a little bit the horizontal picture size (when the projector is on its correct position) in regard with the installed screen

Start up

1. Push the cursor key **↑** or **↓** to highlight 'V Size' (menu 1).
2. Press **ENTER** to activate (menu 2).
3. Push the cursor key **↑** or **↓** until the exact image height is obtained (vertical size) (image 1).

Note :

- If the internal # pattern was selected, this pattern remains on the screen.
- If the genlocked pattern was selected, the external source will be displayed.

A bar scale and a numeric indicator help to gauge the size adjustment.

Hint

In order to avoid loss of resolution in the projected image and to ensure maximum CRT longevity, do not use an excessively small horizontal size setting.

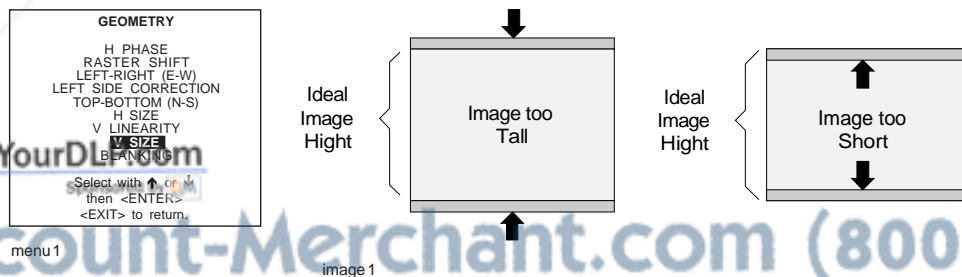

Blanking Adjustments

What can be done ?

Blanking adjustments affect only the edges of the projected image and are used to frame the projected image on to the screen and to hide or black out unwanted information (or noise). A 0% on the bar scale indicates no blanking. The following blanking adjustment are available : Top, Bottom, left and right blanking.

Start Up

To start up the Blanking adjustments, follow the next procedure :

1. Push the cursor key **↑** or **↓** to highlight Blanking (menu 1).
2. Press **ENTER** to display the blanking menu (menu 2).

Therefore :

- If the internal # pattern was selected, this pattern remains on the screen.
- If the genlocked pattern was selected, the external source will be displayed.

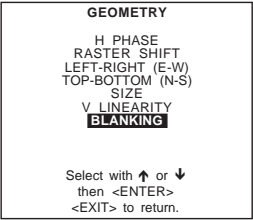

menu 1

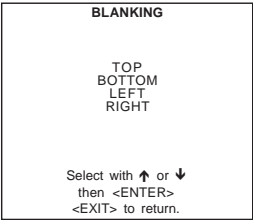

menu 2

How to adjust the Blanking ?

Adjust the next blanking alignments until the image is correctly framed or the unwanted information is blanked out (image 1).

To enter a blanking alignment :

1. Push the cursor key **↑** or **↓** to highlight the desired blanking position.
2. Press **ENTER** to select.
3. Press the cursor key **↑** or **↓** to adjust the blanking.
4. Press **ENTER** to continue.

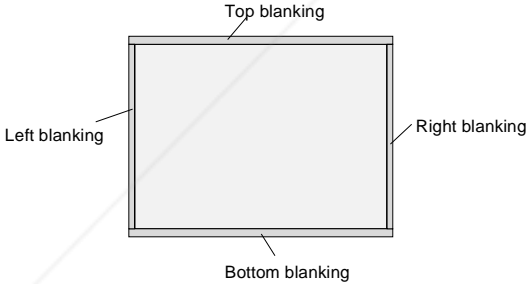
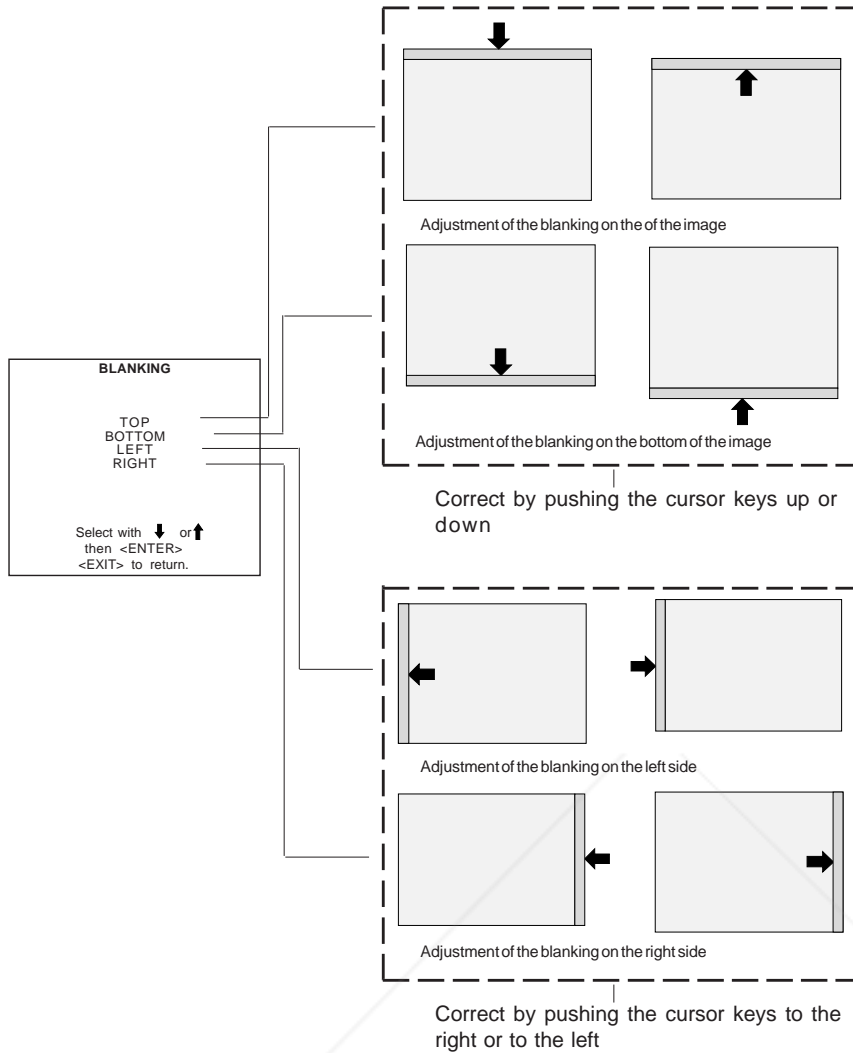

image 1



Discount-Merchant.com (800) 281-8860
THE TRUSTED SOURCE FOR PROJECTOR LAMPS AND ACCESSORIES



Convergence Adjustment

What has to be done ?

Convergence adjustments affect both the horizontal and vertical lines of the setup pattern. These adjustments are performed on the red image while superimposed on the green image and then on the blue image while superimposed on the green image. The screen is divided into 25 areas (image 1)

Note

The green convergence adjustments can be added as an option. When these are available, start always with 'green only'. This option will also be indicated on the convergence menu.

Adjustment order

Adjust first the 'green only' when available and continue with red on green and blue on green.

Start up

1. Push the cursor key ↑ or ↓ to select desired adjustment.
2. Press ENTER to activate.

FixYourDLR.com
Sponsored by DM

Discount-Merchant.com (800) 281-8860
THE TRUSTED SOURCE FOR PROJECTOR LAMPS AND ACCESSORIES

How to adjust ?

1. Use the cursor keys to move the box to the desired zone.
2. Press **ENTER** to begin the convergence adjustment.
Start the convergence adjustment with zone one and continue as mentioned in the image 1.
3. Use the cursor keys to make horizontal or vertical convergence adjustments in the selected zone (image 2).
4. Press **ENTER** to move to another zone.
5. Press **EXIT** to return to the convergence menu.

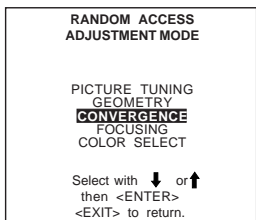

menu 1

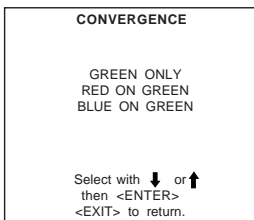

menu 2

25	23	9	15	17
24	22	8	14	16
5	4	1	2	3
20	18	6	10	12
21	19	7	11	13

image 1

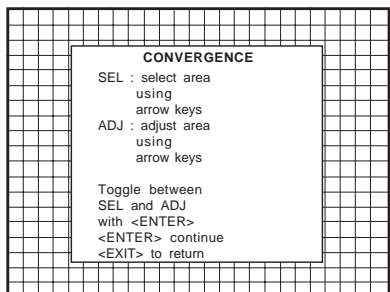

menu 3

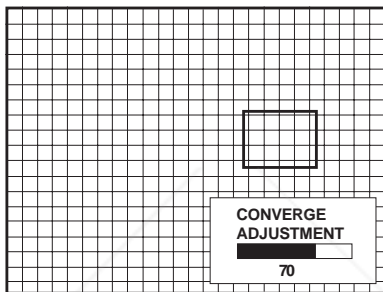

image 2

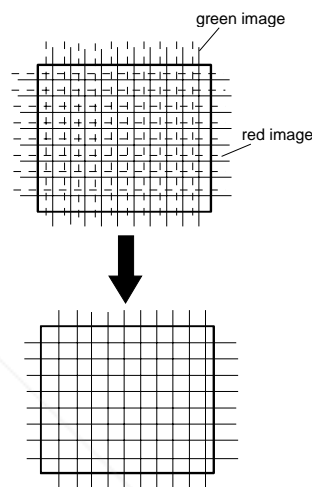

image 3

Focusing

What can be done ?

After the lenses are mechanically correct focused, the CRT's can be electromagnetic focused until the image is on each point.

Start Up

1. Push the cursor key **↑** or **↓** to highlight 'Focusing' (menu 1).
2. Press **ENTER** to display the focusing menu (menu 2).
The focusing has to be done for the three colors separately. Start with Green and continue with Red and Blue.
The following items can be adjusted per color (menu 3) :

- Midpoint focusing
- Top image focusing
- Bottom image focusing
- Left image focusing
- Right image focusing

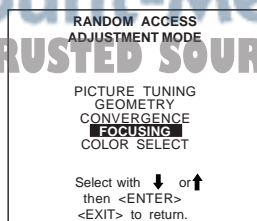

menu 1

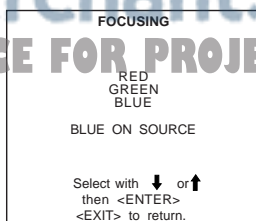

menu 2

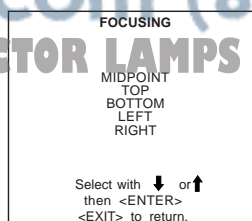

menu 3

FixYourDisplay.com
 Discount-Merchant.com (800) 281-8860
 THE TRUSTED SOURCE FOR PROJECTOR LAMPS AND ACCESSORIES

Midpoint Focusing

1. Push the cursor key **↑** or **↓** to highlight 'Midpoint' (menu 1).
2. Press ENTER to start up the midpoint focusing.
3. Push the cursor key **←** or **→** until the center of the image is sharp.
4. Press ENTER to return to the focusing menu.

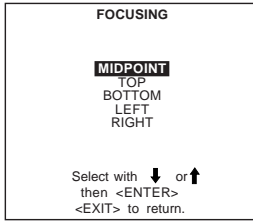

menu 1

Top Image Focusing

1. Push the cursor key **↑** or **↓** to highlight 'Top' (menu 1).
2. Press ENTER to start up the top image focusing.
3. Push the cursor key **←** or **→** until the upper part of the image is sharp.
4. Press ENTER to return to the focusing menu.

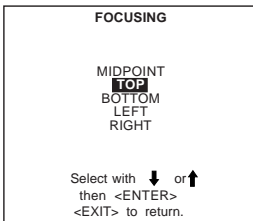

menu 1

Bottom Image Focusing

1. Push the cursor key **↑** or **↓** to highlight 'Bottom' (menu 1).
2. Press ENTER to start up the bottom image focusing.
3. Push the cursor key **←** or **→** until the lower part of the image is sharp.
4. Press ENTER to return to the focusing menu.

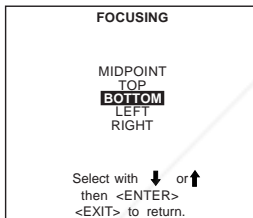

menu 1

Left Image Focusing

1. Push the cursor key **↑** or **↓** to highlight 'Left' (menu 1).
2. Press ENTER to start up the top image focusing.
3. Push the cursor key **←** or **→** until the left part of the image is sharp.
4. Press ENTER to return to the focusing menu.



menu 1

Right Image Focusing

1. Push the cursor key **↑** or **↓** to highlight 'Right' (menu 1).
2. Press **ENTER** to start up the right image focusing.
3. Push the cursor key **←** or **→** until the right part of the image is sharp.
4. Press **ENTER** to return to the focusing menu.

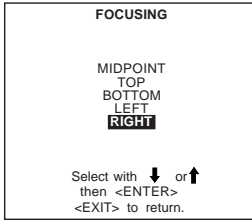

menu 1

Blue on Source

What can be done ?

After focusing the three colors, and a discoloring on a normal image is still visible, select blue on source and repeat the steps Midpoint, Top, Bottom, Left and Right.

Start Up

1. Push the cursor key **↑** or **↓** to highlight 'Blue on Source' (menu 1).
2. Press **ENTER** to start up.
Repeat the midpoint, top, bottom, left and right focusing.

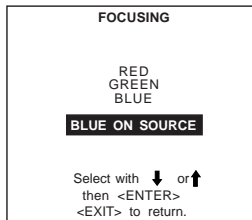

menu 1

Color Select

What can be done ?

Only one color (CRT) or a combination of colors can be switched on display the image.

Start Up

1. Push the cursor key **↑** or **↓** to highlight 'Color Select' (menu 1).
2. Press **ENTER** to display the color select menu (menu 2).
3. Select the desired color or color combination by pushing the cursor key **↑** or **↓**.
4. Press **ENTER** to select.
5. Exit returns to the color select menu.

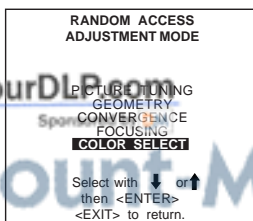

menu 1

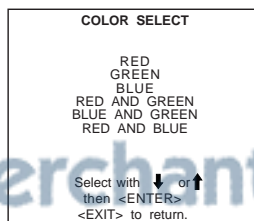

menu 2



Discount-Merchant.com (800) 281-8860
THE TRUSTED SOURCE FOR PROJECTOR LAMPS AND ACCESSORIES

8

SERVICE MODE

Service mode.

Start Up

1. Push the cursor key **↑** or **↓** to select to SERVICE (menu 1).
2. Press **ENTER** to select.
The service menu will be displayed (menu 2).
Some items in the Service mode are password protected (when the password function is active). Enter your password to continue.
All other password protected items are now also available if you stay in the adjustment mode.

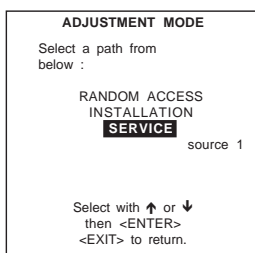

menu1

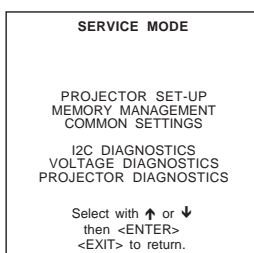

menu2

Overview flowchart

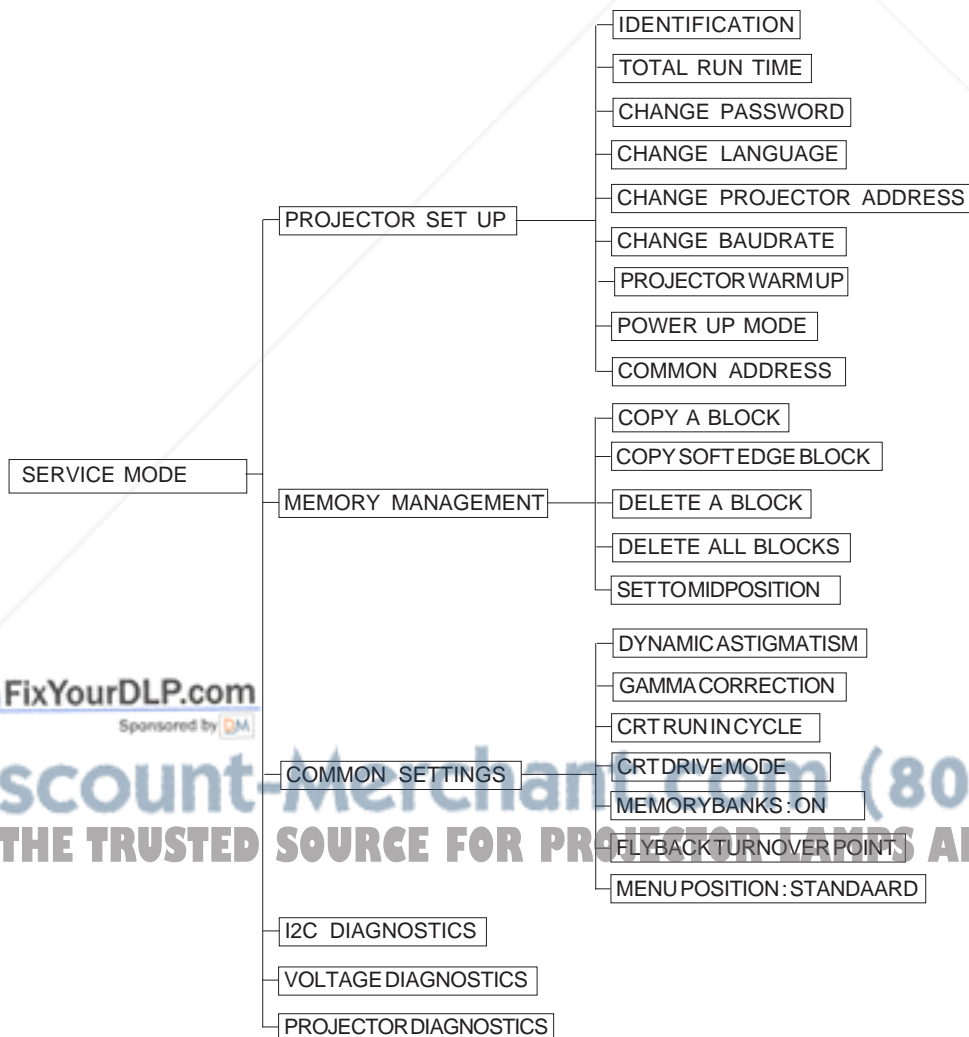

Discount-Merchants.com (800) 281-8860
 THE TRUSTED SOURCE FOR PROJECTOR LAMP AND ACCESSORIES

Projector Set-up

What can be done ?

Within the projector set-up menu, the following items can be consulted or set to the desired setting :

- Identification
- Total run time
- Change password
- Change projector address
- Change baudrate
- Projector warm up
- Power up mode
- Common address

Start up the Projector Set-Up

To select Projector Set-Up :

1. Push the cursor key **↑** or **↓** to highlight Projector Set Up (menu 1).
2. Press **ENTER** to display the Projector set up menu (menu 2).

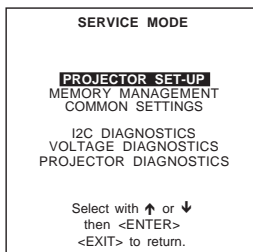

menu 1

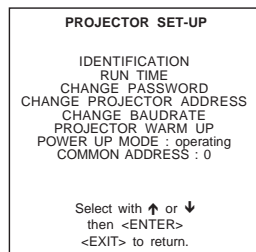

menu 2

Identification

What can be seen ?

The 'Identification' screen gives information concerning :

- Projector address. To change the address of your projector, contact a qualified service technician.
- Software version.
- Configuration.
 - Possible installations :
 - * Front-ceiling
 - * Front-table
 - * Rear-ceiling
 - * Rear-table
- Baud rate PC : transfer speed for communication with an IBM PC (or compatible) or MAC. The baud rate of the projector must be the same as the baud rate of the connected computer. When there is a difference, contact a qualified service technician to make the appropriate changes.
- Text ON/OFF
 - Indicates in operational mode if the bar scale and number indicator will be displayed and if warnings and failures will be displayed.
 - ON : displayed
 - OFF : not displayed
 - The status can be changed by pressing the 'TEXT' key once on the RCU.

- Serial no. : indicates the fabrication number of the projector. This number can be useful when calling for technical assistance.
- Projector Level : from 0 to 6. The higher the level the more software options installed. Contact your vendor for more information.

How to start up ?

To select Identification :

1. Push the cursor key **↑** or **↓** to highlight Identification (menu 1).
2. Press **ENTER** to select.
The identification screen will be displayed (menu 2).

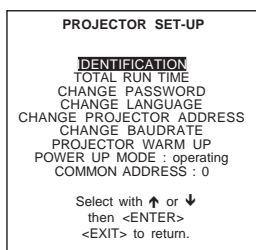

menu1



menu2

RunTime

What can be displayed ?

The total system run time since the first start up can be displayed plus the run time of the separate CRT's since the last reset.

Run Time Note

All projectors leave the factory after a burn-in period of approximately 100 hours.

How to start up ?

To select the different Run Times :

1. Push the cursor key **↑** or **↓** to highlight 'Run Time (menu 1).
2. Press **ENTER** to display the run time menu (menu 2)
The amount of time the projector has played since its first start up at the factory will be displayed as the system run time.
The CRT run times will be displayed next to the respective colors.

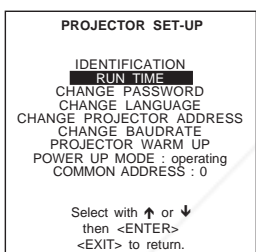

menu1

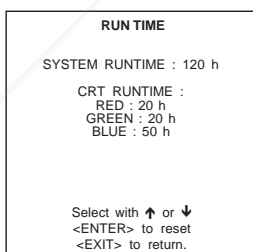

menu2

How to Reset the CRT run times ?

1. Push the cursor key **↑** or **↓** to highlight the color of the CRT for which the Run Time has to be reseted (menu 1).
2. Press **ENTER** to reset the run time.
3. Press **EXIT** to return to the Projector Set up menu.

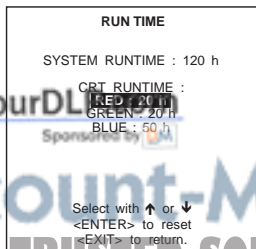

menu1

Change password

What can be done ?

The password code (4 digits) can be changed to a new one.
This item is password protected. First the actual password should be entered before continuing.

Note

Password function is only active if the jumper on the controller is in the 'ON' position.

How to select ?

To select Change Password :

1. Push the cursor key **↑** or **↓** to highlight 'Change Password' (menu 1).
2. Press **ENTER** to display the password menu (menu 2).
If it is the first time you enter a password protected item, enter your password and press **ENTER**.
The current password is displayed. The new password must consist of 4 digits between 0 and 9.

How to enter a new password ?

Handle as follow :

1. Push the cursor key **←** or **→** to select the digits to be changed (menu 2).
2. Press a numeric keys to enter the new digit.
3. Repeat for the other digits.
4. Press **ENTER** to save the new password.
Before saving the new password, a confirmation screen will be displayed (menu 3).
5. When the displayed password is correct, press **ENTER** to save.
6. If not correct, press **EXIT** to cancel the saving.

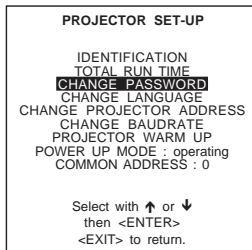

menu 1

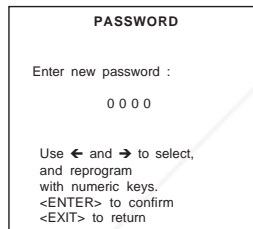

menu 2

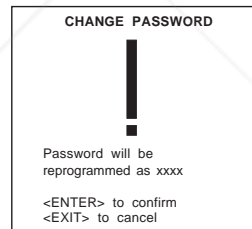

menu 3

Change Projector Address

What can be done ?

Every projector requires an individual address between 0 and 255. This address can be software installed.

How to change that address ?

To change that address, handle as follow :

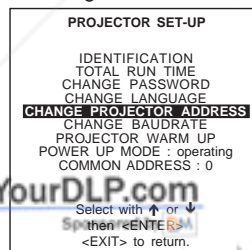

menu 1

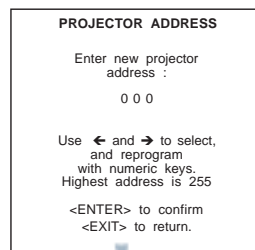

menu 2

1. Push the cursor key **↑** or **↓** to highlight 'Change Projector Address' (menu 1).
2. Press **ENTER** to select.
The Change Projector Address menu (menu 2) will be displayed and the actual address will be filled in. The first digit is highlighted.
3. Push the cursor key **←** or **→** to select the digit to be changed.
4. Reprogram with the digit keys on the RCU.
5. Press **ENTER** to confirm.

Change Baudrate

What can be set up ?

The communication speed between projector and computer has 8 possible speeds. The baud rate speed can be software set up. The following baud rates are available :

- 38400, 19200, 9600, 4800, 2400, 1200.

How to set up ?

To set up the baudrate :

1. Push the cursor key **↑** or **↓** to highlight 'Change Baudrate' (menu 1).
2. Press **ENTER** to select.
The actual baud rate will be highlighted (menu 2)
3. Push the cursor key **↑** or **↓** to select the desired baudrate.
4. Press **ENTER** to accept.

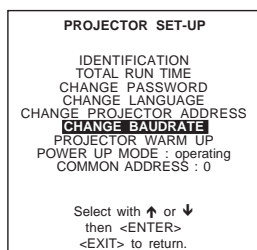

menu 1

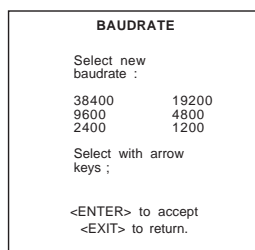

menu 2

Projector warm up

What can be done ?

When in the ON position (and the CRT run in cycle is OFF), the projector can start up with a warm up periode. The warm up time can be set up by the customer as well as the frequency of the warm up source.

During the start up a warm up menu will be displayed. This menu offers the possibility to skip the warm up periode anyway by pressing the **EXIT** key and offers the possibility to adjust the horizontal and vertical amplitude of this white image with the cursor keys. During this warm up period, a full white image is shifted on the CRT faceplate to avoid a burn in.

Every 30 seconds a text box will be displayed on another place on the screen with the remaining time to go.

When **EXIT** is pressed during this warm up periode, the warm up menu will be redisplayed with the remaining time indication. Press another time **EXIT** to interrupt the warm up cycle.

When the warm up option is OFF, when switching on the projector, it starts immediately with the projection of the selected source.

How to select ?

1. Push the cursor key **↑** or **↓** to highlight 'Projector Warm up' (menu 1).
2. Press **ENTER** to select.
The projector warm up menu will be displayed (menu 2).

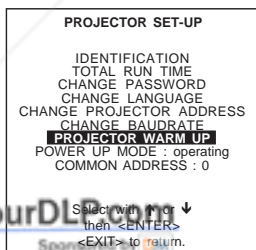

menu 1

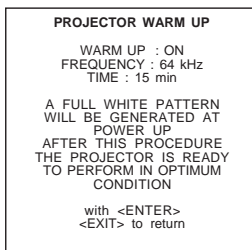

menu 2

Warm up ON/OFF

What can be done ?

The warm up option can be toggle between on and off.
 When in the on position, while starting up the projector, the warm up cycle will be executed.
 When in the off position, the projector starts up with immediate image projection.

How to install ?

1. Push the cursor key **↑** or **↓** to highlight 'Warm up' (menu 1).
2. Press **ENTER** to toggle between ON and OFF.

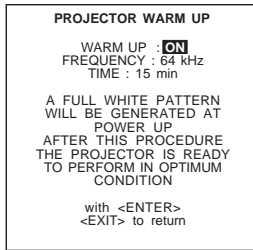

menu1

Warm Up Frequency

What can be done ?

The line frequency of the white pattern on which the warm up will be executed, can be entered by selecting out of the displayed list an available block.

How to install a warm up frequency ?

1. Push the cursor key **↑** or **↓** to highlight 'Frequency' (menu 1).
2. Press **ENTER** to display the projector warm up frequency selection menu (menu 2).
3. Select a block with the cursor keys.
4. Press **ENTER** to copy the settings of the selected block to the warm up block.
5. Press **EXIT** to return.

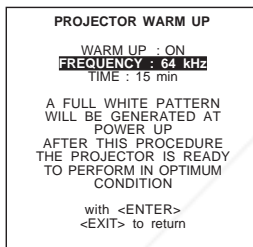

menu1

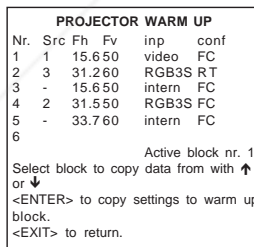

menu2

Projector Warm Up Time

What can be done ?

The warm up time can be programmed with the cursor keys.

How to program the warm up time ?

1. Push the cursor key **↑** or **↓** to highlight 'Time' (menu 1).
2. Press **ENTER** to display the projector warm up time menu (menu 2).
3. Use the cursor keys to select the first digit and reprogram with the numeric keys. Repeat for the other digits.
 The projector warm up time is given in minutes.

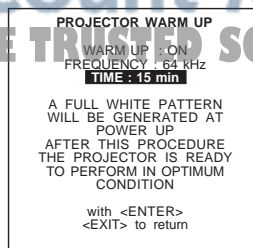

menu1

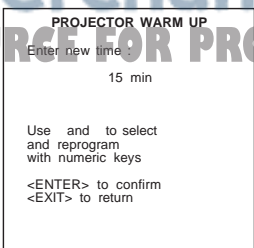

menu2

Power up mode

What can be done ?

When pressing the power switch, the projector can start up in 'operating mode' or in 'stand-by mode'.

Operating mode : the projector start up and displays image .

Stand-by mode : the projector start up in stand-by and waits until the stand-by button or a digit key is pressed.

How to change the mode ?

To change the Power up mode:

1. Push the cursor key **↑** or **↓** to highlight Power Up (menu 1).
2. Press **ENTER** to toggle between 'Operating' and 'Standby'.

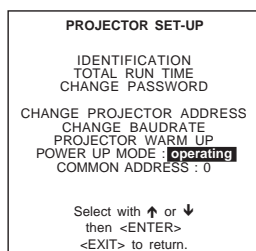

menu 1

Common Address

What can be done ?

Every projector listens to a common address. This common address can be set to '0' or '1'. When a RCU is programmed with that common address, every projector with that same common address will follow up the commands given by that RCU.

Why 2 different common address ?

The reason to have the choice to select between common addresses is, to avoid controlling of other IR controlled units, e.g. a TV set with standard common address 0.

How to change the common address ?

1. Push the cursor key **↑** or **↓** to highlight Common Address (menu 1).
2. Press **ENTER** to toggle between '0' and '1'.

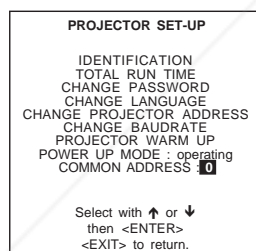

menu 1

Memory management

What can be done ?

Within the memory management menu, the following items can be consulted or executed :

- copy a block
- copy soft edge block
- delete a block
- delete all blocks
- set to midposition

How to select ?

To select Memory Management :

1. Push the cursor key **↑** or **↓** to highlight Memory Management (menu 1).
2. Press **ENTER** to select.
The memory management menu will be displayed (menu 2).

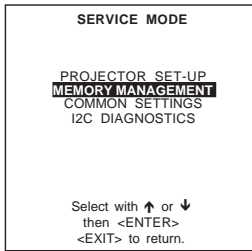

menu 1

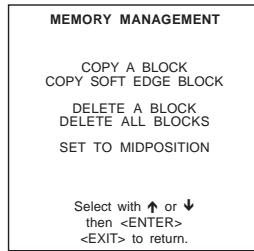

menu 2

Copy a block

What can be done ?

The copy a block function copies the settings of a selected block into the active block.

How to copy ?

To copy a block :

1. Push the cursor key **↑** or **↓** to highlight 'Copy a Block' (menu 1).
2. Press **ENTER** to select.
The copy menu will be displayed (menu 2).
To copy the settings of a closed block to the block you are working on (active block),
3. Push the cursor key **↑** or **↓** to select a block.
4. Press **ENTER** to copy the selected block.
All current settings will be overwritten with the settings of the block which is copied.
A confirmation screen will be displayed (menu 3).
5. **ENTER** to confirm.
EXIT cancels the copy procedure and returns without copying the block.

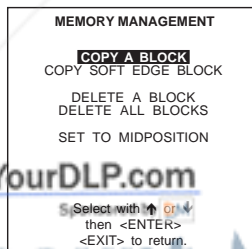

menu 1

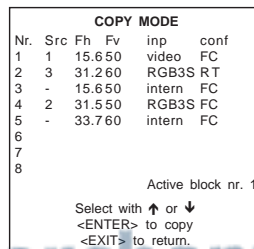

menu 2

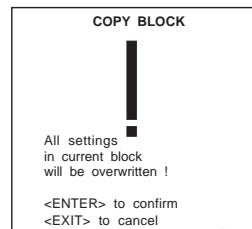

menu 3

Copy softedge settings

What can be done ?

The copy softedge settings copies the settings of the softedge of a selected block into the softedge settings of the active block.

How to copy the softedge settings ?

To copy the softedge settings :

1. Push the cursor key **↑** or **↓** to highlight 'Copy Softedge settings' (menu 1).
2. Press **ENTER** to select.
The copy softedge settings menu will be displayed (menu 2).
To copy the softedge settings of a closed block to the block you are working on (active block) :
3. Push the cursor key **↑** or **↓** to select a block.
4. Press **ENTER** to copy the softedge settings of the selected block.
All current soft edge settings will be overwritten with the soft edge settings of the block which is copied.
A confirmation screen will be displayed (menu 3).
5. **ENTER** to confirm.
EXIT cancels the copy procedure and returns without copying the softedge settings.

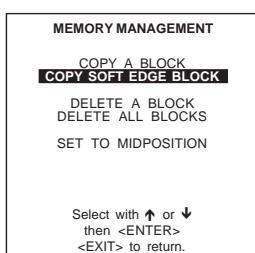

menu1

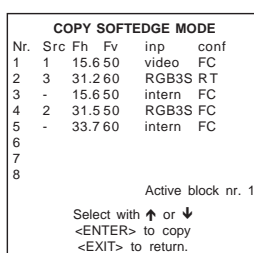

menu2

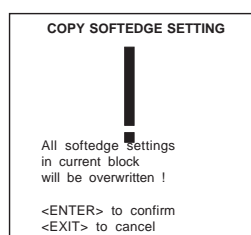

menu3

Deletion of blocks

What can be done ?

The delete function is used to clear all data (settings) from an adjustment block. A delete can be given :

- block by block
 - or
 - for all blocks.
- This item is password protected.

Deleting block by block

What can be done ?

The 'delete a block' function deletes the settings of a selected block.

How to delete a Block ?

1. Push the cursor key **↑** or **↓** to highlight Delete a Block (menu 1).
2. Press **ENTER** to display the delete mode (menu 2).
3. Push the cursor key **↑** or **↓** to select the desired adjustment block.
4. Press **ENTER** to delete the selected adjustment block.
A confirmation menu will be displayed (menu 3).
5. Press **ENTER** to confirm.
Press **EXIT** to cancel the deletion procedure

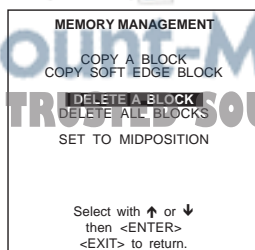

menu1

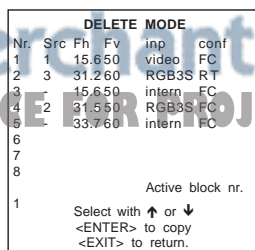

menu2

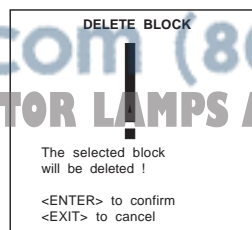

menu3

Deletion of all blocks

What can be done ?

All blocks (all settings) can be deleted at the same time.

How to delete all blocks ?

1. Push the cursor key **↑** or **↓** to highlight Delete all Blocks (menu 1).
2. Press **ENTER** to select.
A confirmation screen will be displayed (menu 2).
3. Press **ENTER** to confirm
Press **EXIT** to return without deleting any block.
Once **ENTER** is pressed, all block headers and adjustment settings are permanently removed and cannot be restored.

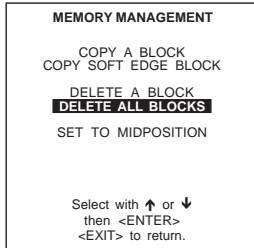

menu1

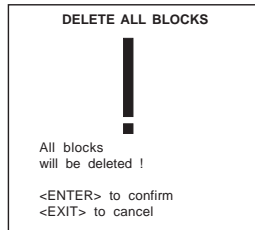

menu2

Set to midposition

What can be done ?

All adjustment settings (geometry and convergence) can be set to mid position.
Item is password protected.

How to Start Up ?

1. Push the cursor key **↑** or **↓** to highlight 'Set to Midposition' (menu 1).
2. Press **ENTER** to display the set to midposition menu (menu 2).

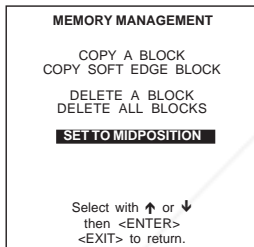

menu1

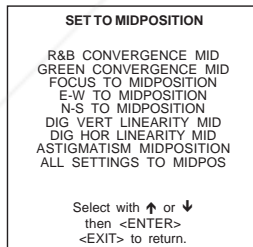

menu2

R & B convergence mid

What can be done ?

All convergence settings for red and blue are set to midposition.
Item is password protected.

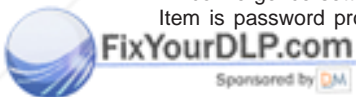

Discount-Merchant.com (800) 281-8860
THE TRUSTED SOURCE FOR PROJECTOR LAMPS AND ACCESSORIES

How to set convergence to midposition :

1. Push the cursor key **↑** or **↓** to highlight 'R & B Convergence Mid' (menu 1).
2. Press **ENTER** to select.
A confirmation screen will be displayed first (menu 2).
3. Press **ENTER** to confirm.

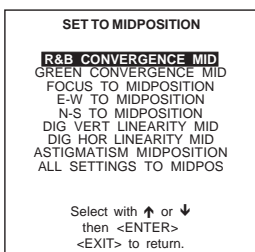

menu2

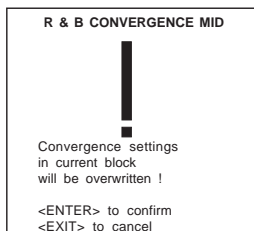

menu2

Undo R & B convergence mid

What can be done ?

When "R & B convergence mid" is selected, all convergence settings are set to their midposition. With the undo, it is possible to return to the previous settings as long as the projector is playing on the same source (= same adjustment block). 'Undo R & B convergence mid' is displayed in the Set Midposition menu in stead off 'R & B convergence mid' when this latter is pressed.

How to Undo ?

1. Push the cursor key **↑** or **↓** to highlight 'Undo R & B convergence mid' (menu 1).
2. Press **ENTER** execute the undo function.

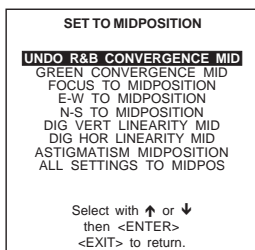

menu1

Green convergence mid

What can be done ?

The green convergence settings can be set to midposition. Only available when the projector is equipped with green convergence adjustments.

How to set Green settings to midposition ?

1. Push the cursor key **↑** or **↓** to highlight 'GR Convergence Mid' (menu 1).
2. Press **ENTER** to select.
A confirmation screen will be displayed first (menu 2).
3. Press **ENTER** to confirm.
Press **EXIT** to cancel the procedure to set the green convergence settings to their midposition.

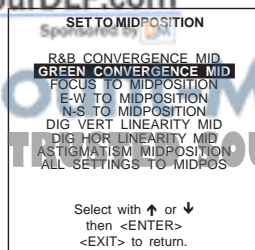

menu1



menu2

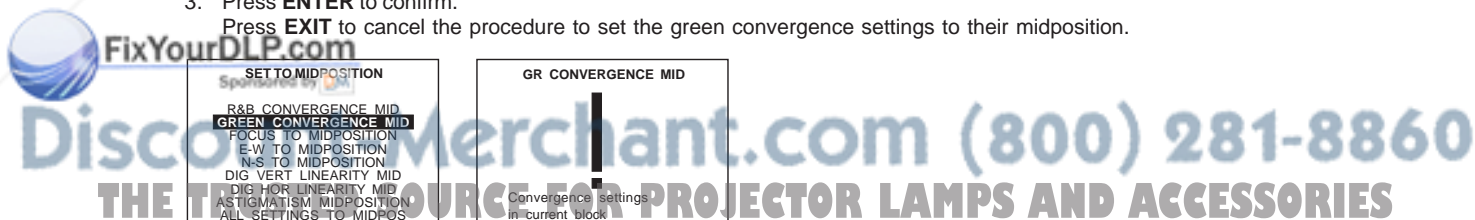

Undo green convergence mid

What can be done ?

'Undo Gr convergence mid' is displayed in the Set Midposition menu in stead off 'Gr convergence mid' when this latter is pressed. Only available when the projector is equipped with green convergence adjustments.

How to undo ?

1. Push the cursor key **↑** or **↓** to highlight 'Undo Gr convergence mid' (menu 1).
2. Press **ENTER** undo.

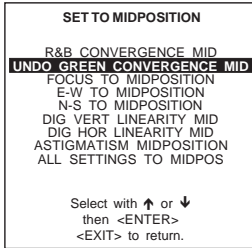

menu1

Focus to Midposition

What can be done ?

The focus settings can be set to midposition.

How to set the Focus settings to midposition ?

1. Push the cursor key **↑** or **↓** to highlight 'Focus to midposition' (menu 1).
2. Press **ENTER** to select.
A confirmation screen will be displayed first (menu 2).
3. Press **ENTER** to confirm.
Press **EXIT** to cancel the procedure to set the focus settings to their midposition.

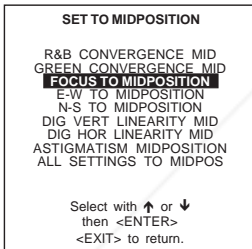

menu1

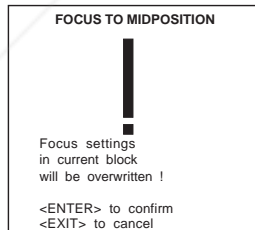

menu2

Undo Focus to Midposition

What can be done ?

'Undo Focus to Midposition' is displayed in the Set Midposition menu in stead off 'Focus to midposition' when this latter is pressed. As long the projector is running on the same source (= same adjustment block), undo the focus to midposition is possible.

How to undo the Focus to midposition ?

1. Push the cursor key **↑** or **↓** to highlight 'Undo Focus to midposition' (menu 1).
2. Press **ENTER** undo.

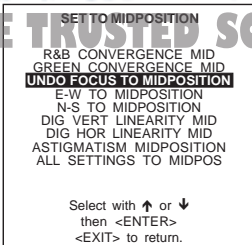

menu1

East-West to Midposition

What can be done ?

The east-west settings can be set to midposition.

How to set the E-W settings to midposition ?

1. Push the cursor key **↑** or **↓** to highlight 'E-W to midposition' (menu 1).
2. Press **ENTER** to select.
A confirmation screen will be displayed first (menu 2).
3. Press **ENTER** to confirm.
Press **EXIT** to cancel the procedure to set the E-W settings to their midposition.

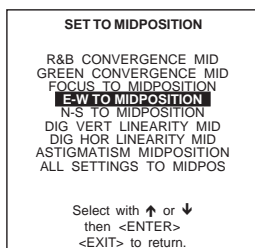

menu1

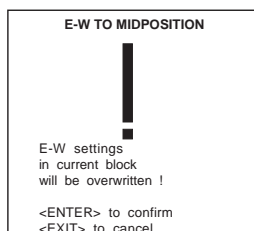

menu2

Undo East-West to midposition

What can be done ?

'Undo East-West to midposition' is displayed in the Set Midposition menu in stead off 'E-W to midposition' when this latter is pressed. The settings for the E-W can be returned to previous installed settings as long the projector is playing on the same source (= same adjustment block).

How to Undo the E-W to midposition ?

1. Push the cursor key **↑** or **↓** to highlight 'Undo E-W to midposition' (menu 1).
2. Press **ENTER** undo.

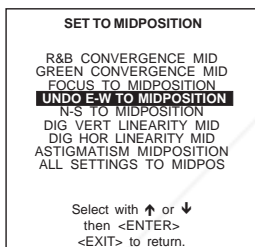

menu1

North-South settings to Midposition

What can be done ?

The north-south settings can be set to midposition.

How to set the N-S settings to midposition ?

1. Push the cursor key **↑** or **↓** to highlight 'N-S to midposition' (menu 1).
2. Press **ENTER** to select.
A confirmation screen will be displayed first (menu 2).
3. Press **ENTER** to confirm.
Press **EXIT** to cancel the procedure to set the N-S settings to their midposition.

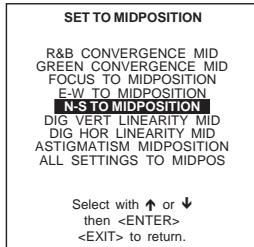

menu1

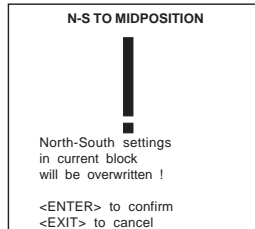

menu2

Undo North-South setting to midposition

What can be done ?

'Undo N-S to midposition' is displayed in the Set Midposition menu in stead off 'N-S to midposition' when this latter is pressed. The settings for the N-S can be returned to previous installed settings as long the projector is playing on the same source (= same adjustment block).

How to Undo the N-S to midposition ?

1. Push the cursor key **↑** or **↓** to highlight 'Undo N-S to midposition' (menu 1).
2. Press **ENTER** undo.

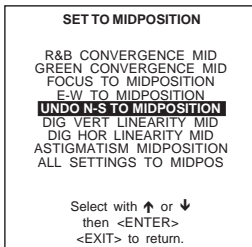

menu1

Digital Vertical Linearity to Midposition

What can be done ?

The digital vertical linearity settings for the different areas can be set to their midposition.

How to set the Digital Vertical Linearity to Midposition ?

1. Push the cursor key **↑** or **↓** to highlight 'Dig Vert Linearity mid' (menu 1).
2. Press **ENTER** to select.
A confirmation screen will be displayed first (menu 2).
3. Press **ENTER** to confirm.
Press **EXIT** to cancel the procedure to set the Digital vertical linearity to their midposition.

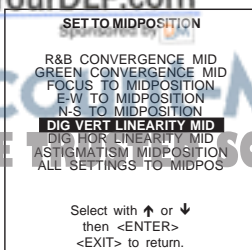

menu1

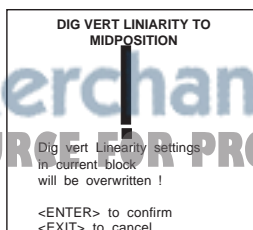

menu2

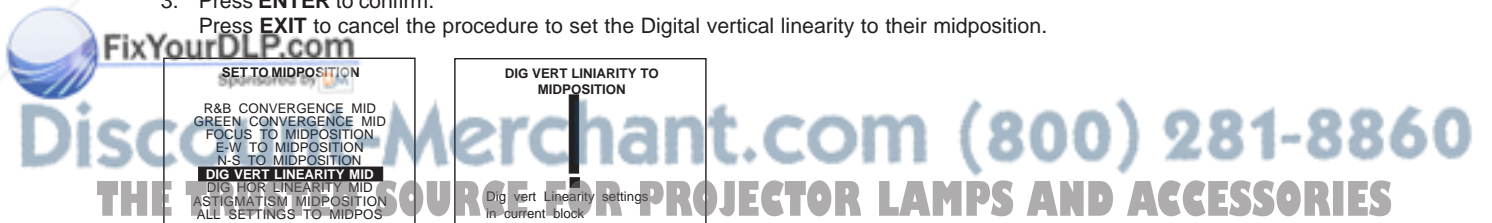

Undo Digital Vertical Linearity to Midposition

What can be done ?

'Undo digital vertical linearity to midposition' is displayed in the Set Midposition menu in stead off 'Dig Vert Linearity to midposition' when this latter is pressed.

The settings for the dig vert linearity can be returned to previous installed settings as long the projector is playing on the same source (= same adjustment block).

How to undo the digital vertical linearity to midposition ?

1. Push the cursor key **↑** or **↓** to highlight 'Undo dig vert linearity to midposition' (menu 1).
2. Press **ENTER** undo.

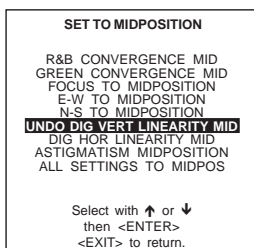

menu1

Digital Horizontal Linearity to midposition

What can be done ?

The digital horizontal linearity settings for the different areas can be set to their midposition.

How to set the Digital Horizontal Linearity to Midposition ?

1. Push the cursor key **↑** or **↓** to highlight 'Dig Hor Linearity mid' (menu 1).
2. Press **ENTER** to select.
A confirmation screen will be displayed first (menu 2).
3. Press **ENTER** to confirm.
Press **EXIT** to cancel the procedure to set the Digital horizontal linearity to their midposition.

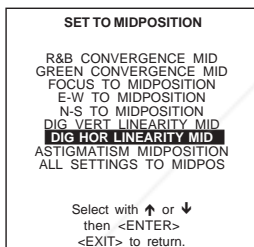

menu1

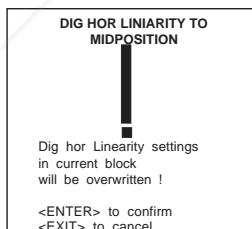

menu2

Undo Digital Horizontal Linearity to Midposition

What can be done ?

'Undo digital horizontal linearity to midposition' is displayed in the Set Midposition menu in stead off 'Dig Hor Linearity to midposition' when this latter is pressed.

The settings for the dig hor linearity can be returned to previous installed settings as long the projector is playing on the same source (= same adjustment block).

Discount-Merchant.com (800) 281-8860
 THE TRUSTED SOURCE FOR PROJECTOR LAMPS AND ACCESSORIES

How to undo the digital vertical linearity to midposition ?

1. Push the cursor key **↑** or **↓** to highlight 'Undo dig vert linearity to midposition' (menu 1).
2. Press **ENTER** undo.

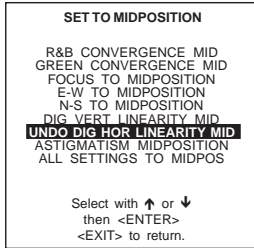

menu1

Astigmatism midposition

What can be done ?

The astigmatism settings for the different areas can be set to their midposition.

How to set the Astigmatism to Midposition ?

1. Push the cursor key **↑** or **↓** to highlight 'Astigmatism' (menu 1).
2. Press **ENTER** to select.
A confirmation screen will be displayed first (menu 2).
3. Press **ENTER** to confirm.
Press **EXIT** to cancel the procedure to set the Astigmatism to their midposition.

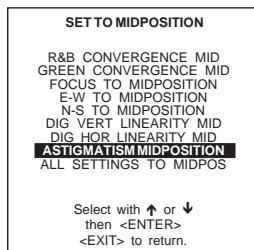

menu1



menu2

Undo Astigmatism setting to midposition

What can be done ?

'Undo Astigmatism midposition' is displayed in the Set Midposition menu instead of 'Astigmatism midposition' when this latter is pressed. The settings for the astigmatism can be returned to previous installed settings as long as the projector is playing on the same source (= same adjustment block).

How to undo the Astigmatism settings to midposition ?

1. Push the cursor key **↑** or **↓** to highlight 'Undo astigmatism midposition' (menu 1).
2. Press **ENTER** undo.

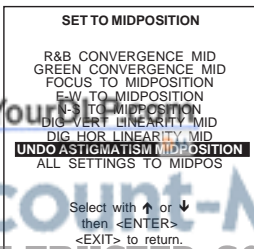

menu1

FixYourProjector.com
Discount-Merchant.com (800) 281-8860
THE TRUSTED SOURCE FOR PROJECTOR LAMPS AND ACCESSORIES

All settings to Midposition

What can be done ?

All adjustment settings can be set to midposition.

How to set to midposition ?

1. Push the cursor key **↑** or **↓** to highlight 'All Settings to Midposition' (menu 1).
2. Press **ENTER** to select.
A confirmation menu will be displayed first (menu 2).
3. Press **ENTER** to confirm.
Press **EXIT** to cancel the operation 'set all settings to their midposition'.

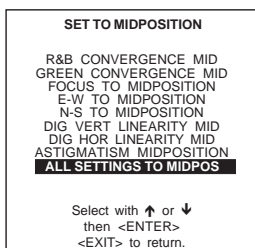

menu1

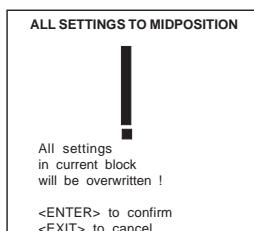

menu2

Undo all settings to midpos

What can be done ?

'Undo all settings to Midposition' is displayed in the Memory management menu in stead off 'All settings to midposition' when this latter is pressed.

An undo is possible as long as the projector is running on the same source (= same adjustment block) even when some adjustments as geometry or convergence are already readjusted. When undo is pressed all settings are reset to the previous settings.

How to cancel 'Set to midposition' ?

When "All settings to midpos" is selected, all settings are set to their midposition. To cancel this action :

1. Push the cursor key **↑** or **↓** to highlight 'Undo all settings to midpos' (menu 1).
2. Press **ENTER** to cancel the set to midposition action.

Press **EXIT** to cancel the procedure 'undo set to midposition'.

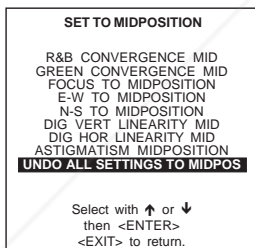

menu 1



Discount-Merchant.com (800) 281-8860
THE TRUSTED SOURCE FOR PROJECTOR LAMPS AND ACCESSORIES

Common Settings

What can be done ?

Within the common settings menu, the following items can be set up or executed :

- Dynamic Astigmatism
- Gamma Correction
- CRT run in cycle
- CRT Drive mode
- Memory banks : on/off
- Flyback turnover point
- Menu Position : standard/middle

How to select ?

1. Push the cursor key **↑** or **↓** to highlight 'Common Settings' (menu 1).
2. Press **ENTER** to select.
The common settings menu will be displayed (menu 2).

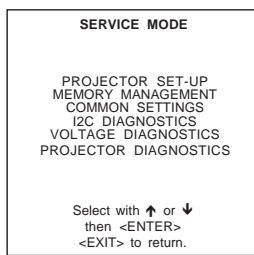

menu1

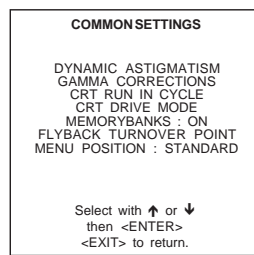

menu2

Dynaminc Astigmatism

What can be done ?

The spot shape adjustments correct the spot shape in 25 different areas on the screen for the three colors separately. The spot shape is adjusted according to the axial axes and the diagonal axes when using the cursor keys on the RCU. These adjustments have to be done on a dot pattern (external source or genlocked pattern).

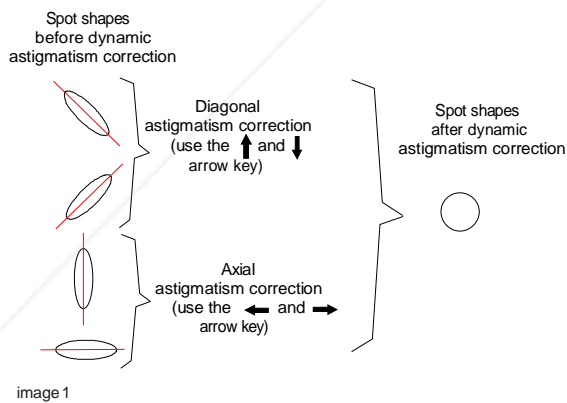

image 1

Start Up

To start up the dynamic astigmatism :

1. Push the cursor key **↑** or **↓** to highlight 'Dynamic Astigmatism' (menu 1).
2. Press **ENTER** to display the dynamic astigmatism menu (menu 2).

The dynamic astigmatism can be adjusted on the selected source or on pattern lock on the selected source (genlocked pattern). The way of adjusting is the same for both ways and for each color. The explanation will only be given for one color.

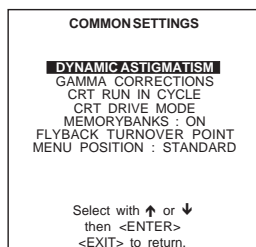

menu1

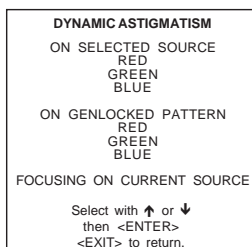

menu2

How to adjust ?

The adjustment of the dynamic astigmatism is done on the selected source or genlocked pattern and for each color separately. The menu will be displayed hereafter for a genlocked pattern on the green image.

To adjust, follow the next procedure :

1. Push the cursor key **↑** or **↓** to highlight 'green under Genlocked Pattern' (menu 1).
2. Press **ENTER** to display the dynamic astigmatism adjustment menu (menu 2).
The screen is divided into 25 areas (5 x 5) (menu 3). In each area, the spot shape can be adjusted.
3. Use the cursor keys to select the desired area.
4. Increase the contrast level using the Contrast Control to near maximum. Using that "+" Sharpness Key, defocus the image until the dots are large and easily visible.

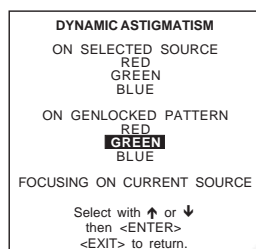

menu1

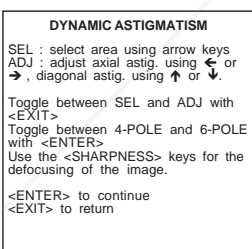



menu2

5. Press **EXIT** to toggle the cursor keys from selection keys to adjustment keys.
6. Adjust first the 4 pole correction.
Adjust the spot shape in the axial or diagonal direction, using the cursor keys. Adjust until the spot shape is circular. Use the cursor key **↑** or **↓** for the diagonal astigmatism adjustment and the cursor key **→** or **←** for the axial astigmatism adjustment.
7. Press **ENTER** to toggle from the 4 pole correction to the 6 pole correction or vice versa.
8. Adjust the spot shape again using the cursor keys.
9. Press **EXIT** to return to the area selection screen.
10. Repeat from step 3 as may times as necessary.

Focusing on current source

When selecting this function, the 'Focusing' menus from the random access will be displayed. For more explanation, see Random Access Adjustment mode § Focusing.

 FixYourDIP.com
 Sponsored by  DM

Discount-Merchant.com (800) 281-8860
THE TRUSTED SOURCE FOR PROJECTOR LAMPS AND ACCESSORIES

Gamma Corrections

Gamma Corrections warning ?

**'The Gamma Corrections are factory adjusted using an ACTAS colour analyser !
Therefore, only qualified installation or service personnel should perform these adjustments !'**

A warning will be displayed on the screen as there is a risk of incorrect adjustment of the projector..

Start Up

To start up the gamma corrections :

- 1. Push the cursor key **↑** or **↓** to highlight 'Gamma Corrections' (menu 1).
- 2. Press **ENTER** to start up.

A warning screen will be displayed (menu 2).

If you are qualified, press **ENTER** to continue. If not qualified, press **EXIT** to return to the Common Settings menu. Further description of the Gamma Corrections are given in the Installation manual, Appendix C.

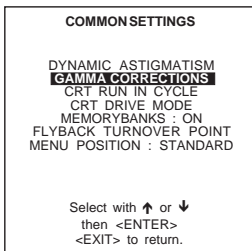

menu1

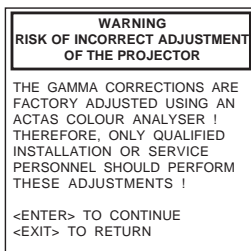

menu2

CRT run in cycle

What can be done ?

Only necessary when a new picture tube is installed.

The CRT run in cycle option can only be activated when memory blocks on an internal # pattern are available. When one or more such blocks are available, a flashing white image (5sec on, 5 sec off) is generated and that for 5 min on the first internal block. In the next 5 min, a second internal block will be used to generate the flashing white image. The image will also be shifted in a vertical way to prevent a CRT burn in. To quit the CRT run in cycle option, press EXIT.

How to select CRT run in cycle ?

- 1. Push the cursor key **↑** or **↓** to highlight 'CRT run in Cycle' (menu 1).
- 2. Press **ENTER** to start up.

If a memory block adjusted on an internal # pattern is available, the CRT run in cycle will start. If no such a block is available, the projector cannot run the CRT run in option and leaves the adjustment mode.

If you still want to run CRT run in cycle, create first a memory block on an internal # pattern and restart the CRT run in option.

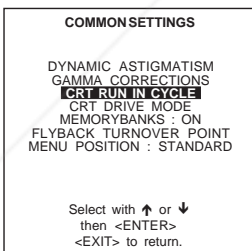

menu1

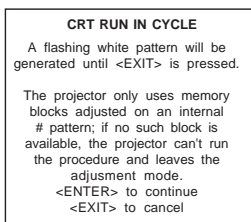

menu2



Discount-Merchant.com (800) 281-8860
THE TRUSTED SOURCE FOR PROJECTOR LAMPS AND ACCESSORIES

CRT Drive Mode

What can be done ?

The projector CRT's can be driven with the normal current (normal mode), a lower current (economic mode) or with a higher current (boost mode). The higher the current, the higher the light output but the lifetime will shorten.

Available drive modes

- Normal
- Economic : Lower drive current to the CRT's, the lifetime of the CRT's will enlarge but the light output will reduce.
- Temporary boost : Higher drive current to the CRT's, the lifetime of the CRT's will shorten but the light output will be higher. This situation is temporary, when restarting the projector, the drive mode is automatically set to normal.
- Permanent boost : Higher drive current to the CRT's, the lifetime of the CRT's will shorten but the light output will be higher. This setting will be saved in the EEPROM. When restarting the projector, it will start up in boost mode.

How to change the drive mode ?

To change the drive mode :

1. Push the cursor key **↑** or **↓** to highlight 'CRT Drive Mode' (menu 1).
2. Press **ENTER** to display the CRT Drive mode menu (menu 2).
3. Push the cursor key **↑** or **↓** to highlight the desired drive mode (menu 3).
2. Press **ENTER** to activate the selected drive mode.

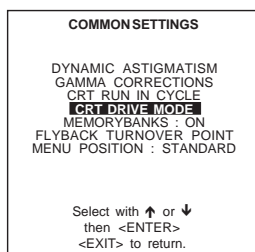

menu1

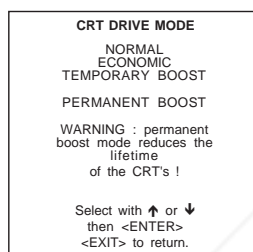

menu2

CRT Drive mode warning

A warning, permanent BOOST mode in use, will be displayed to inform the user. When text is on, this warning will be repeated every time a new source is selected.

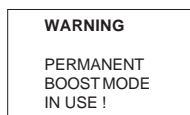

Memory banks

What can be done ?

The user has the possibility to create 8 different memory banks (formats) for each source. But, the maximum allowed quantity of memory banks for all sources together is 32. The option to create different memory banks for the same source can be switched ON or OFF.

How to select Memory Banks ?

1. Push the cursor key **↑** or **↓** to highlight 'Memory Banks' (menu 1).
2. Press **ENTER** to toggle between ON and OFF.

ON : different memory banks available.
OFF : only one memory bank available.

If different memory banks are available for a source and the memory bank option is toggled to OFF, only the first memory bank will be used to display the source.

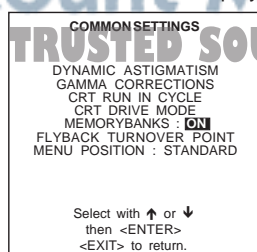

menu1

How to create a new memory bank ?

1. Select your source. The projector selects the last used memory bank.
2. Press **ENTER**
3. Push the corresponding digit (between 1 and 8) of a non existing memory bank. (The memory banks can be created in random order, e.g. first creating bank 5 and later bank 2.)
4. Make the necessary adjustments. When leaving the source, the new created memory bank will be saved for later use.

Example : When source 1, video 15.6 kHz /60Hz is create on bank 4 and the vertical frequency changes to 50Hz, the projector will create a new block (due to the vertical frequency change) with the same bank number 4.

How to recall a specific memorybank for the actual source ?

When the memory bank option is ON and a source is selected, this source will be displayed with the last used memory bank settings. An on-screen menu will give a indication of the memory bank nummer used (menu 1).

To switch to another memory bank :

1. Press **ENTER** to select the next memory bank in increasing order.
or
2. Enter the number of the desired memory bank with the digit keys.

In both cases, the on-screen indication will be update.

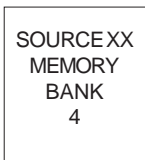

menu1

Flyback Turnover Point

What can be done ?

The horizontal flyback time for horizontal frequencies can be long or short. The turnover point from long to short can be installed by the user himself.

Set Up of the Flyback Turnover Point

To set up the flyback turnover point :

1. Push the cursor key **↑** or **↓** to highlight 'Flyback turnover point' (menu 1).
2. Press **ENTER** to display the flyback turnover point (menu 2).
The actual turnover point frequency will be filled in.
3. Select the digits with the left or right cursor keys and enter the new value with the digit keys on the RCU.
The flyback turnover point frequency should be somewhere between 90 kHz and 130 kHz.
4. Press **ENTER** to select.

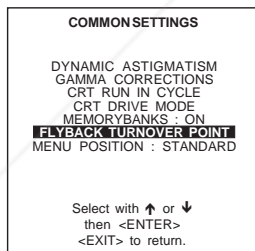

menu1

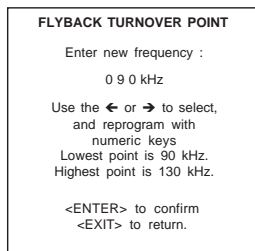

menu2

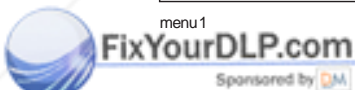

Menu Position

Discount-Merchant.com (800) 281-8860

THE TRUSTED SOURCE FOR PROJECTOR LAMPS AND ACCESSORIES

What can be done ?

The bar scale menu, warning and message boxes can be displayed in the right lower corner or in the middle of the screen.

How to change the position ?

To change the position :

1. Push the cursor key **↑** or **↓** to highlight 'Menu position' (menu 1).
2. Press **ENTER** to toggle between STANDARD or MIDDLE.

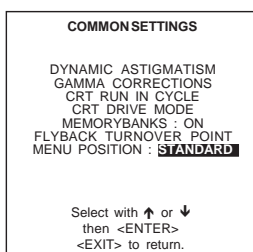

menu1

I2C Diagnostics

What can be seen ?

The I2C diagnostics menu gives an overview of the I2C failures inside the projector.

To scroll through the failure list, push the cursor key **↑** or **↓**.

The I2C address, IC number and module name will be given in I2C diagnostic menu.

When no errors are detected, the following message will appear on the screen :

"No errors on i2c-bus detected".

How to select ?

1. Push the cursor key **↑** or **↓** to highlight 'I2C Diagnostics' (menu 1).
2. Press **ENTER** to display the diagnostic menu (menu 2).

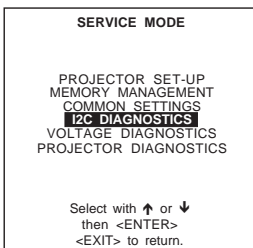

menu1

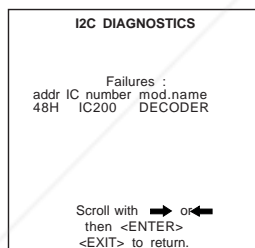

menu2

Voltage Diagnostics

What can be seen ?

The real value of the different voltages will be displayed on the voltage diagnostics menu.

How to start up ?

1. Push the cursor key **↑** or **↓** to highlight 'Voltage diagnostics' (menu 1).
2. Press **ENTER** to display the voltage diagnostic menu (menu 2).

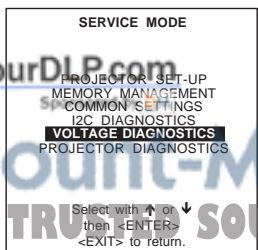

menu1

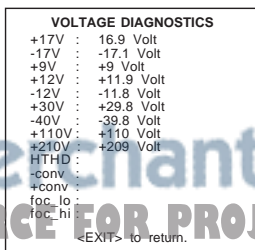

menu2

Projector Diagnostics

What can be seen ?

A log of the last 5 failures with the run time when the failure happened is consultable in the Projector Diagnostics.

How to display the Projector Diagnostics ?

1. Push the cursor key **↑** or **↓** to highlight 'Projector diagnostics' (menu 1).
2. Press **ENTER** to display the projector diagnostic menu (menu 2).
The last failure will be displayed.
3. Use the cursor keys to scroll through the failure log.
4. Press **ENTER** to switch to the voltage diagnostics (menu 3).
5. Press **EXIT** to return to the projector diagnostics menu.

```
SERVICE MODE

PROJECTOR SET-UP
MEMORY MANAGEMENT
COMMON SETTINGS
I2C DIAGNOSTICS
VOLTAGE DIAGNOSTICS
PROJECTOR DIAGNOSTICS

Select with ↑ or ↓
then <ENTER>
<EXIT> to return.
```

menu1

```
PROJECTOR DIAGNOSTICS
Failure nr : 2
Runtime : 180h 30 min
Projector block nr : 4
Coincidence : ON
Deflection : OFF
SF : yes EHT fail :no
SF vert : no HD EHT : no
SF hor : no Fan Fail : yes
IBCL fail :no

Arrow keys to scroll,
<ENTER> to see the voltages,
<EXIT> to return.
```

menu2

```
VOLTAGE DIAGNOSTICS
+17V : 16.9 Volt
-17V : -17.1 Volt
+9V : +9 Volt
+12V : +11.9 Volt
-12V : -11.8 Volt
+30V : +29.8 Volt
-40V : -39.8 Volt
+110V : +110 Volt
+210V : +209 Volt
HTHD :
-conv :
+conv :
foc_lo :
foc_hi :

<EXIT> to return.
```

menu3

9

PROGRAMMABLE FUNCTION KEYS

Programmable Function Keys

What can be done with these keys

The five function keys on top of the remote control can be programmed as short cut keys (quick access) to almost any adjustment function.

See list further in this chapter.

How can a Function Key be programmed ?

A function key can only be programmed when in the service menus.

Handle as follow :

1. Scroll through the menus until the desired function is on the menu.
2. Select this function by pushing the cursor keys up or down.
3. Press the desired function key for this function.
The following message : "Programming Function Key Fx" will be displayed.
The message will disappear automatically and the function key is programmed.
4. Leave the adjustment mode by pressing ADJUST.
5. The function key is available in the operational mode.

e.g. programming horizontal phase on key F4.

1. Press **ADJUST** to enter the main menu (menu 1).
2. Push the cursor keys **↑** or **↓** to select 'Service menu'.
3. Press **ENTER** to go into the adjustment menus.
A warning will be displayed (menu 2).
4. If qualified, press **ENTER** otherwise press **EXIT** and call for technical assistance.
5. Select Random by pushing the cursor keys **↑** or **↓**.
6. Press **ENTER** to display the Random Access mode menu (menu 3).
7. Push the cursor keys **↑** or **↓** to select 'Geometry'.
8. Press **ENTER** to display the Geometry menu (menu 4).
9. Push the cursor keys **↑** or **↓** to select H PHASE (menu 4).
10. Press 'F4' to program this key.
11. Press **ADJUST** to return to operational mode.

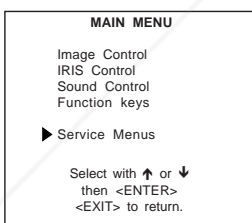

menu1

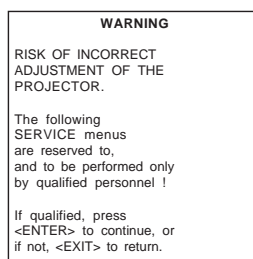

menu2

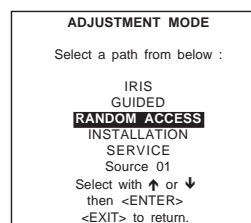

menu3

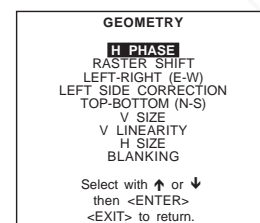

menu4



Discount-Merchant.com (800) 281-8860
THE TRUSTED SOURCE FOR PROJECTOR LAMPS AND ACCESSORIES

10

MESSAGES, WARNINGS AND FAILURES

<p>INPUT 01 RGB2 Fh= 15.6 kHz Fv= 050 Hz</p>	<p>When selecting a new source, information about this source will be displayed on the screen. Source number, horizontal and vertical frequencies of the displayed source.</p>	<p>WARNING: input not available</p>	<p>When using the projector with the RCVDS, this warning will be displayed when selecting an input slot of an RCVDS where the input board is missing.</p>
<p>SOURCE 01 RGB2</p>	<p>Announcement of the selected source.</p>	<p>WARNING: source not available</p>	<p>The input is a valid input but the source is not connected to the input terminals or the input source is switched off.</p>
<p>enter password x x x x</p>	<p>Message to enter your password. Password contains 4 digits.</p>	<p>WARNING: invalid key entry</p>	<p>When a wrong key is pressed on the RCU.</p>
<p>TEXT on SOURCE 01 RGB2 xxxkHz xxHz</p>	<p>These messages will be displayed on the screen when pushing the TEXT key.</p>	<p>WARNING: end of adjustment range</p>	<p>End of adjustment range.</p>
<p>TEXT off</p>	<p>Text ON : the 'bar scale indication' will be enabled during the change of an analog control in the 'operational mode' + all warnings and failures will be displayed.</p>	<p>WARNING: input no longer available</p>	<p>The input source is no longer available.</p>
<p>PROJECTOR ADDRESS: 003</p>	<p>Text OFF : the 'bar scale indication' will be disabled during the change of an analog control in the 'operational mode' + all warnings and failures will not be displayed.</p>	<p>WARNING: RCVDS not available</p>	<p>The input source selector is not available.</p>
<p>WRONG PASSWORD !!!</p>	<p>Indication of the projector address when activating the 'ADDRESS' button on the RCU with a pencil or other small object.</p>	<p>WARNING: invalid frequency input</p>	<p>The entered frequency or applied frequency of the source is out of the projector's range.</p>
<p>FixYourDLP.com Sponsored by </p>	<p>Message when the entered password is wrong.</p>	<p>WARNING: permanent BOOST mode in use !!!</p>	<p>The CRT drive mode is switched to permanent boost.</p>
<p>Discount-Merchant.com (800) 881-8860 THE TRUSTED SOURCE FOR PROJECTOR LAMPS AND ACCESSORIES</p>	<p>WARNING: Option not installed !</p>	<p>Option not installed. e.g. Video selected but no decoder installed.</p>	
<p>WARNING: Invalid Code Entry</p>	<p>The entered password is incorrect</p>	<p>The entered password is incorrect</p>	

FAILURE I2C error addr. : 7FH3	Hardware failure. Call a qualified service technician for repair.
FAILURE short circuit on I2C bus	Hardware failure. Call a qualified service technician for repair.
FAILURE RCVDS com- munication error	Serial communication error between the RCVDS and the projector.
FAILURE invalid input	input not valid
FAILURE PC communica- tion error	error in the communication between the projector and the PC.
FAN FAILED Projector will switch off	projector switched off due to a fan fail.
FAILURE IRIS II configuration failed	Error occurred while configuring the IRIS II module.



ADJUSTMENT BLOCKS AND SOURCE NUMBERS 90 - 99

Adjustment Blocks (memory blocks)

What are adjustment block ?

As the projector is digitally controlled, all geometry and convergence adjustments are stored in the projector's memory as numeric values. These numeric values are used to control digital potentiometers which in turn, control the projector. Each source connected to the projector has a unique set of adjustment data which is automatically downloaded into the projector's digital potentiometers once the source has been selected. This set of adjustment data is referred to as an "adjustment block".

An adjustment table is automatically created for a source when the source is first connected to the projector and the Adjustment mode is entered. If other sources have already been connected to the projector and geometry and convergence adjustments have been performed on these sources, the projector will use Linear Digital Interpolation to create a new block for the new source. This block will provide an initial set of adjustments for the new source that have been calculated by the projector from "previous experience".

The projector's memory has the capacity to store 32 adjustment blocks. The adjustment block consists of two parts, the block header and the data representing the values for all adjustments (eg. Convergence and Geometry) in the projector for the source the block corresponds to. The block header contains the basic characteristics of the source and the projector configuration used to display the source.

Built up of block

<i>Block Header</i>	<i>example of block header</i>
Block Number	01
Source Number	01
Horizontal Frequency	15.6 kHz
Vertical Frequency	50 Hz
Input Type	video
Scan Switch Configuration	Front/Ceiling

The data representing the various adjustments for the source follows the block header.

Source numbers 90 - 99

Why used ?

Source numbers 90 - 99 do not correspond to physical inputs to the projector or RCVDS. They are used to assign an additional adjustment block to a source. This additional adjustment block may contain different geometry and convergence settings, sync fast/slow positions and enhanced blue on/off settings. The relationship between source numbers 0 - 9 and 90 - 99 (projector with RCVDS) or 1 - 5 and 91 - 95 (stand-alone projector) is shown in the diagram below.

The alternate adjustment block for sources 0 - 9 (projector with RCVDS) or 1 - 5 (stand-alone projector) is activated by selecting the corresponding source number 0 - 9 (projector with RCVDS) or 1 - 5 (stand-alone projector). Once this source number is selected, the alternate block of adjustment data is in use and may be modified via the adjust mode of the projector. The alternate adjustment block is automatically stored.

How to create a second block ?

Follow the steps below to create a second adjustment block for a source between 0 and 9.

1. Select the source between 0 and 9 that the second adjustment block is to be created for.
2. Select the corresponding source number between 90 and 99. The adjustment block for the source number between 0 and 9 is copied to the corresponding source number between 90 and 99.
3. Enter the adjust mode and make any desired changes (geometry, convergence, sync fast/slow, enhanced blue on/off) to the second adjustment block.
4. Exit the adjust mode.

Note : the above also applies to source number 1 - 5 and 91 - 95 of a stand alone projector (no RCVDS)

source input 0 — source number 0 — Block header A
source input 0 — source number 90 — Block header A, different analog settings

source input 1 — source number 1 — Block header B
source input 1 — source number 91 — Block header B, different analog settings

source input 2 — source number 2 — Block header C
source input 2 — source number 92 — Block header C, different analog settings

•
•
•

source input 9 — source number 9 — Block header J
source input 9 — source number 99 — Block header J, different analog settings



Discount-Merchant.com (800) 281-8860
THE TRUSTED SOURCE FOR PROJECTOR LAMPS AND ACCESSORIES



Disclaimer

This user manual is provided as a free service by FixYourDLP.com. FixYourDLP is in no way responsible for the content of this manual, nor do we guarantee its accuracy. FixYourDLP does not make any claim of copyright and all copyrights remain the property of their respective owners.

About FixYourDLP.com

FixYourDLP.com (<http://www.fixyourdpl.com>) is the World's #1 resource for media product news, reviews, do-it-yourself guides, and manuals.

Informational Blog: <http://www.fixyourdpl.com>

Video Guides: <http://www.fixyourdpl.com/guides>

User Forums: <http://www.fixyourdpl.com/forum>

FixYourDLP's Fight Against Counterfeit Lamps:

<http://www.fixyourdpl.com/counterfeits>

Sponsors:

RecycleYourLamp.org – Free lamp recycling services for used lamps:

<http://www.recycleyourlamp.org>

Lamp Research - The trusted 3rd party lamp research company:

<http://www.lampresearch.com>

Discount-Merchant.com – The worlds largest lamp distributor:

<http://www.discount-merchant.com>



FixYourDLP.com

Sponsored by 