



Disclaimer

This user manual is provided as a free service by FixYourDLP.com. FixYourDLP is in no way responsible for the content of this manual, nor do we guarantee its accuracy. FixYourDLP does not make any claim of copyright and all copyrights remain the property of their respective owners.

About FixYourDLP.com

FixYourDLP.com (<http://www.fixyourdpl.com>) is the World's #1 resource for media product news, reviews, do-it-yourself guides, and manuals.

Informational Blog: <http://www.fixyourdpl.com>

Video Guides: <http://www.fixyourdpl.com/guides>

User Forums: <http://www.fixyourdpl.com/forum>

FixYourDLP's Fight Against Counterfeit Lamps:

<http://www.fixyourdpl.com/counterfeits>

Sponsors:

RecycleYourLamp.org – Free lamp recycling services for used lamps:

<http://www.recycleyourlamp.org>

Lamp Research - The trusted 3rd party lamp research company:

<http://www.lampresearch.com>

Discount-Merchant.com – The worlds largest lamp distributor:

<http://www.discount-merchant.com>



FixYourDLP.com

Sponsored by 

Projector

CP-X206/CP-X306

User's Manual (detailed) Operating Guide

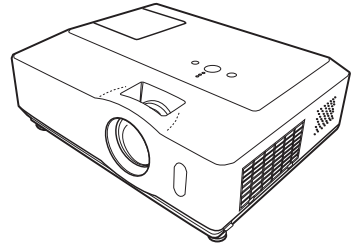

Thank you for purchasing this projector.

▲ WARNING ► Before using this product, please read all manuals for this product. Be sure to read "Safety Guide" first. After reading them, store them in a safe place for future reference.

About this manual

Various symbols are used in this manual. The meanings of these symbols are described below.

▲ WARNING This symbol indicates information that, if ignored, could possibly result in personal injury or even death due to incorrect handling.

▲ CAUTION This symbol indicates information that, if ignored, could possibly result in personal injury or physical damage due to incorrect handling.

 Please refer to the pages written following this symbol.

NOTE • The information in this manual is subject to change without notice.
• The manufacturer assumes no responsibility for any errors that may appear in this manual.
• The reproduction, transfer or copy of all or any part of this document is not permitted without express written consent.

Trademark Acknowledgment

- Mac is a registered trademark of Apple Inc.
- Microsoft and Windows are registered trademarks of Microsoft Corporation.
- VESA and DDC are trademarks of the Video Electronics Standard Association.
- PowerPC is a registered trademark of International Business Machines Corporation.

All other trademarks are the properties of their respective owners.

Contents

About this manual	1		PICTURE menu	26	
Contents	2		BRIGHTNESS, CONTRAST, GAMMA, COLOR TEMP, COLOR, TINT, SHARPNESS, MY MEMORY		
Projector features	3		IMAGE menu	29	
Preparations	3		ASPECT, OVER SCAN, V POSITION, H POSITION, H PHASE, H SIZE, AUTO ADJUST EXECUTE		
Contents of package	3		INPUT menu	31	
Fastening the lens cover	3		PROGRESSIVE, VIDEO NR, COLOR SPACE, COMPONENT, VIDEO FORMAT, FRAME LOCK, COMPUTER IN, RESOLUTION		
Part names	4		SETUP menu	34	
Projector	4		AUTO KEYSTONE  EXECUTE, KEYSTONE  , WHISPER, MIRROR, STANDBY MODE, MONITOR OUT		
Control panel	5		AUDIO menu	36	
Rear panel	5		VOLUME, SPEAKER, AUDIO		
Remote control	6		SCREEN menu	37	
Setting up	7		LANGUAGE, MENU POSITION, BLANK, START UP, MyScreen, MyScreen Lock, MESSAGE, SOURCE NAME, TEMPLATE		
Arrangement	7		OPTION menu	41	
Connecting your devices	10		AUTO SEARCH, AUTO KEYSTONE  ,		
Connecting power supply	12		AUTO ON, AUTO OFF, LAMP TIME, FILTER TIME, MY BUTTON, MY SOURCE, SERVICE, SECURITY		
Using the security bar and slot	12		NETWORK menu	54	
Remote control	13		SETUP, PROJECTOR NAME, MY IMAGE, INFORMATION, SERVICE		
Installing the batteries	13		C.C. (closed caption) menu	59	
About the remote control signal	13		DISPLAY, MODE, CHANNEL		
Changing the frequency of remote control signal	14		Maintenance	60	
Using as a simple PC mouse & keyboard	14		Replacing the lamp	60	
Power on/off	15		Cleaning and replacing the air filter	62	
Turning on the power	15		Replacing the internal clock battery	64	
Turning off the power	15		Other care	65	
Operating	16		Troubleshooting	66	
Adjusting the volume	16		Related messages	66	
Temporarily muting the sound	16		Regarding the indicator lamps	67	
Selecting an input signal	16		Shutting the projector down	68	
Searching an input signal	17		Resetting all settings	68	
Selecting an aspect ratio	17		Phenomena that may be easy to be mistaken for machine defects	69	
Adjusting the projector's elevator	18		Specifications	72	
Adjusting the zoom and focus	18				
Using the automatic adjustment feature	19				
Adjusting the position	19				
Correcting the keystone distortions	20				
Using the magnify feature	20				
Freezing the screen	21				
Temporarily blanking the screen	21				
Using the menu function	22				
EASY MENU	24				
ASPECT, AUTO KEYSTONE  EXECUTE, KEYSTONE  , PICTURE MODE, BRIGHTNESS, CONTRAST, COLOR, TINT, SHARPNESS, WHISPER, MIRROR, RESET, FILTER TIME, LANGUAGE, Go to Advanced Menu...					

Projector features

The projector provides you with the broad use by the following features.

- ✓ This projector has a variety of I/O ports that supposedly cover for any business scene.
- ✓ This projector realizes the large projection image, even if in a small space.
- ✓ The new double layer filter system is expected to function longer and offers you less maintenance frequency.
- ✓ This projector can be controlled and monitored via LAN connection.

Preparations

Contents of package

Please see the “Contents of package” section in the User’s Manual (concise) which is a book. Your projector should come with the items shown there. Contact immediately your dealer if anything is missing.

NOTE • Keep the original packing materials, for future reshipment. Be sure to use the original packing materials when moving the projector. Use special caution for the lens.

Fastening the lens cover

To avoid losing the lens cover, please fasten the lens cover to the projector using the enclosed strap.

1. Fix the strap to the strap hole of the lens cover.
Thread one end of the strap through the strap hole of the lens cover and make the loop at the end, and let the other end of the strap through the loop.
Do not have a knot in the strap at either end.

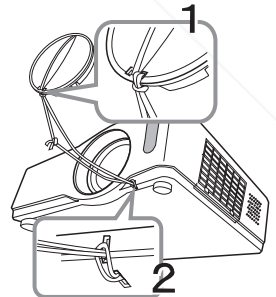

2. Fix the strap to the strap hole of the projector.
Thread the other end of the strap through the strap hole of the projector and make the loop there. Let the lens cover with the one end of strap through the loop.

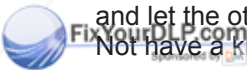

Discount-Merchant.com (800) 281-8860

Part names

Projector

- (1) Lamp cover (📖60)
The lamp unit is inside.
- (2) Focus ring (📖18)
- (3) Zoom ring (📖18)
- (4) Control panel (📖5)
- (5) Elevator buttons (x 2) (📖18)
- (6) Elevator feet (x 2) (📖18)
- (7) Remote sensor (📖13)
- (8) Lens (📖65)
- (9) Lens cover (📖3)
- (10) Intake vents
- (11) Filter cover (📖62)
The air filter and intake vent are inside.
- (12) Speaker (📖36)
- (13) Exhaust vent
- (14) **AC IN** (AC inlet) (📖12)
- (15) Power switch (📖15)
- (16) Rear panel (📖5)
- (17) Security bar (📖12)
- (18) Security slot (📖12)
- (19) Slot cover (📖64)
The internal clock battery is inside.

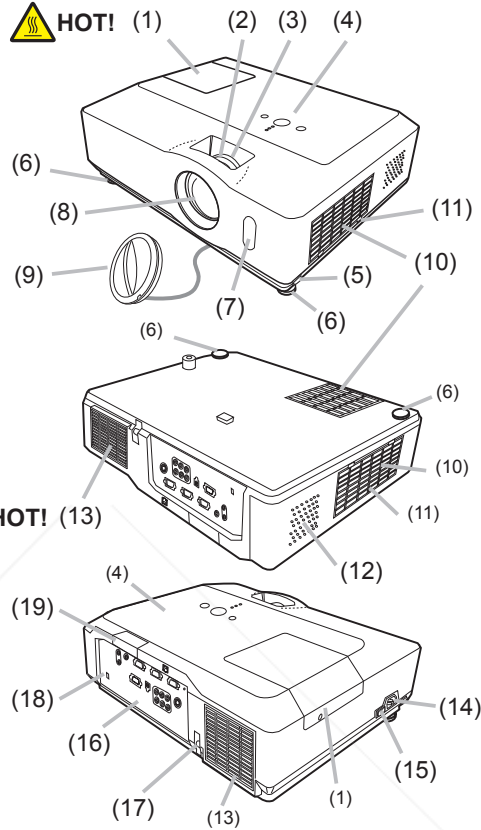

⚠ WARNING ►HOT! : Do not touch around the lamp cover and the exhaust vents during use or just after use, since it is too hot.

► Do not look into the lens or vents while the lamp is on, since the strong light is not good for your eyes.

► Do not handle the elevator buttons without holding the projector, since the projector may drop down.

⚠ CAUTION ► Maintain normal ventilation to prevent the projector from heating up. Do not cover, block or plug up the vents. Do not place anything that can stick or be sucked to the vents, around the intake vents. Clean the air filter periodically.

► Do not use the security bar and slot to prevent the projector from falling down, since it is not designed for it.

Control panel

- (1) **STANDBY/ON** button (📖 15)
- (2) **INPUT** button (📖 16, 22)
- (3) **MENU** button (📖 22)
It consists of four cursor buttons.
- (4) **POWER** indicator (📖 15, 67)
- (5) **TEMP** indicator (📖 67)
- (6) **LAMP** indicator (📖 67)

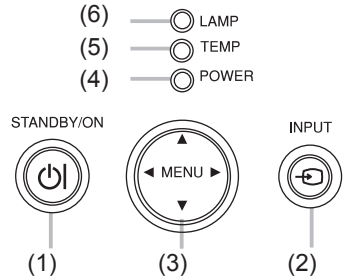

Rear panel (📖 10)

- (1) **AUDIO IN1** port
- (2) **AUDIO IN2** port
- (3) **AUDIO OUT** port
- (4) **COMPUTER IN1** port
- (5) **COMPUTER IN2** port
- (6) **MONITOR OUT** port
- (7) Shutdown switch (📖 68)
- (8) **CONTROL** port
- (9) **USB** port
- (10) **COMPONENT** (Y, Cb/Pb, Cr/Pr) ports
- (11) **VIDEO** port
- (12) **S-VIDEO** port
- (13) **AUDIO IN3 (L,R)** ports
- (14) **LAN** port

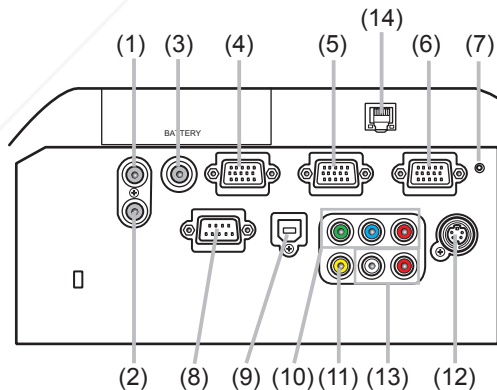

⚠ CAUTION ▶ Use the shutdown switch only when the projector is not turned off by normal procedure, since pushing this switch stops operation of the projector without cooling it down.

Remote control

- (1) VIDEO button (📖17)
- (2) COMPUTER button (📖16)
- (3) SEARCH button (📖17)
- (4) STANDBY/ON button (📖15)
- (5) ASPECT button (📖17)
- (6) AUTO button (📖19)
- (7) BLANK button (📖21)
- (8) MAGNIFY - ON button (📖20)
- (9) MAGNIFY - OFF button (📖14, 20)
- (10) MY SOURCE/DOC.CAMERA button (📖43)
- (11) VOLUME - button (📖16)
- (12) PAGE UP button (📖14)
- (13) PAGE DOWN button (📖14)
- (14) VOLUME + button (📖16)
- (15) MUTE button (📖16)
- (16) FREEZE button (📖21)
- (17) MY BUTTON - 1 button (📖43)
- (18) MY BUTTON - 2 button (📖43)
- (19) KEYSTONE button (📖20)
- (20) POSITION button (📖19, 22)
- (21) MENU button (📖22)
- (22) ▲/▼/◀/▶ cursor buttons (📖14, 22, 23)
- (23) ENTER button (📖14, 22, 23)
- (24) ESC button (📖14, 22)
- (25) RESET button (📖14, 22, 23)
- (26) Battery cover (📖13)

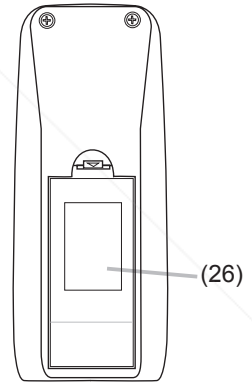
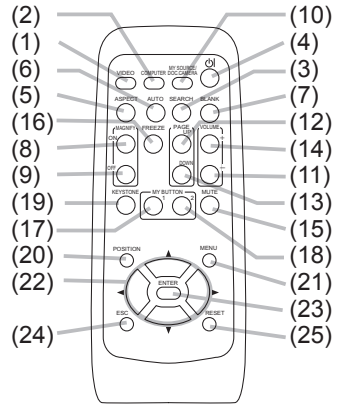

Back of the remote control

Setting up

Install the projector according to the environment and manner the projector will be used in.

Arrangement

Refer to the illustrations and tables below to determine screen size and projection distance.

<CP-X206>

The values shown in the table are calculated for a full size screen: 1024×768

- (a) Screen size (diagonal)
- (b) Projection distance ($\pm 10\%$)
- (c1), (c2) Screen height ($\pm 10\%$)

On a horizontal surface

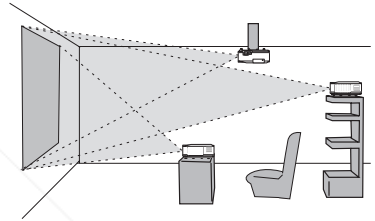
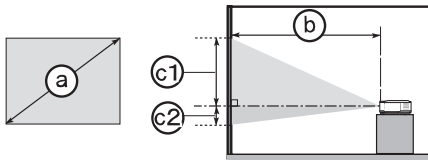

Suspended from the ceiling

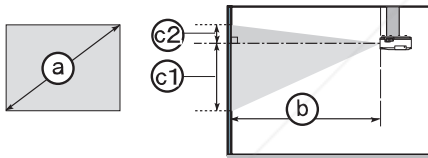

- Keep a space of 30 cm or more between the sides of the projector and other objects such as walls.
- Consult with your dealer before a special installation such as suspending from a ceiling.

(a) Screen size (diagonal)		4 : 3 screen								16 : 9 screen							
		(b) Projection distance				(c1) Screen height		(c2) Screen height		(b) Projection distance				(c1) Screen height		(c2) Screen height	
		min.		max.						min.		max.					
inch	m	m	inch	m	inch	cm	inch	cm	inch	m	inch	m	inch	cm	inch	cm	inch
30	0.8	0.9	34	1.1	41	41	16	5	2	1.0	38	1.1	45	39	15	-1	0
40	1.0	1.2	46	1.4	56	55	22	6	2	1.3	50	1.5	61	51	20	-2	-1
50	1.3	1.5	58	1.8	70	69	27	8	3	1.6	63	1.9	76	64	25	-2	-1
60	1.5	1.8	70	2.1	84	82	32	9	4	1.9	76	2.3	91	77	30	-2	-1
70	1.8	2.1	81	2.5	98	96	38	11	4	2.3	89	2.7	107	90	35	-3	-1
80	2.0	2.4	93	2.8	112	110	43	12	5	2.6	102	3.1	122	103	41	-3	-1
90	2.3	2.7	105	3.2	126	123	49	14	5	2.9	115	3.5	138	116	46	-4	-1
100	2.5	3.0	117	3.6	140	137	54	15	6	3.2	127	3.9	153	129	51	-4	-2
120	3.0	3.6	140	4.3	169	165	65	18	7	3.9	153	4.7	184	154	61	-5	-2
150	3.8	4.5	176	5.4	211	206	81	23	9	4.9	192	5.8	230	193	76	-6	-2
200	5.1	6.0	235	7.2	282	274	108	30	12	6.5	256	7.8	307	257	101	-8	-3
250	6.4	7.5	294	9.0	353	343	135	38	15	8.1	320	9.8	384	322	127	-10	-4
300	7.6	9.0	352	10.8	423	411	162	46	18	9.8	384	11.7	461	386	152	-12	-5

Arrangement (continued)

<CP-X306>

The values shown in the table are calculated for a full size screen: 1024×768

- (a) Screen size (diagonal)
- (b) Projection distance (±10%)
- (c1), (c2) Screen height (±10%)

On a horizontal surface

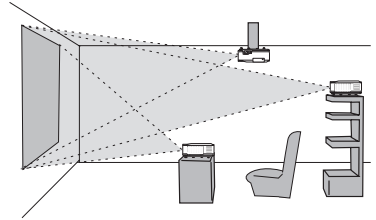
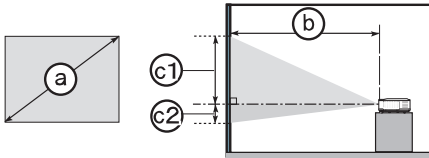

Suspended from the ceiling

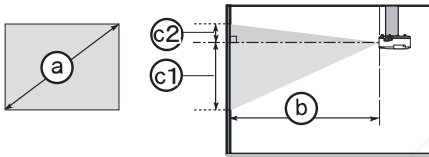

- Keep a space of 30 cm or more between the sides of the projector and other objects such as walls.
- Consult with your dealer before a special installation such as suspending from a ceiling.

(a) Screen size (diagonal)		4 : 3 screen								16 : 9 screen							
		(b) Projection distance				(c1) Screen height		(c2) Screen height		(b) Projection distance				(c1) Screen height		(c2) Screen height	
		min.		max.		cm		inch		min.		max.		cm		inch	
inch	m	m	inch	m	inch	cm	inch	cm	inch	m	inch	m	inch	cm	inch	cm	inch
30	0.8	0.9	35	1.1	43	41	16	5	2	1.0	39	1.2	47	39	15	-1	0
40	1.0	1.2	47	1.4	57	55	22	6	2	1.3	52	1.6	62	51	20	-2	-1
50	1.3	1.5	59	1.8	71	69	27	8	3	1.6	65	2.0	78	64	25	-2	-1
60	1.5	1.8	71	2.2	86	82	32	9	4	2.0	78	2.4	94	77	30	-2	-1
70	1.8	2.1	83	2.5	100	96	38	11	4	2.3	91	2.8	109	90	35	-3	-1
80	2.0	2.4	95	2.9	115	110	43	12	5	2.6	104	3.2	125	103	41	-3	-1
90	2.3	2.7	107	3.3	129	123	49	14	5	3.0	117	3.6	141	116	46	-4	-1
100	2.5	3.0	119	3.6	144	137	54	15	6	3.3	130	4.0	156	129	51	-4	-2
120	3.0	3.6	143	4.4	172	165	65	18	7	4.0	156	4.8	188	154	61	-5	-2
150	3.8	4.6	179	5.5	216	206	81	23	9	4.9	195	6.0	235	193	76	-6	-2
200	5.1	6.1	239	7.3	288	274	108	30	12	6.6	261	8.0	314	257	101	-8	-3
250	6.4	7.6	299	9.1	360	343	135	38	15	8.3	326	10.0	392	322	127	-10	-4
300	7.6	9.1	359	11.0	432	411	162	46	18	9.9	391	12.0	471	386	152	-12	-5

Arrangement (continued)

⚠ WARNING ► Place the projector in a stable horizontal position. If the projector falls or is knocked over, it could cause injury and/or damage to the projector. Using a damaged projector could then result in fire and/or electric shock.

- Do not place the projector on an unstable, slanted or vibrational surface such as a wobbly or inclined stand.
 - Do not place the projector on its side, front or rear position.
 - Consult with your dealer before a special installation such as suspending from a ceiling or somewhere else.
- Place the projector in a cool place, and ensure that there is sufficient ventilation. The high temperature of the projector could cause fire, burns and/or malfunction of the projector.
- Do not stop-up, block or otherwise cover the projector's vents.
 - Keep a space of 30 cm or more between the sides of the projector and other objects such as walls.
 - Do not place the projector on metallic thing or anything weak in heat.
 - Do not place the projector on carpet, cushions or bedding.
 - Do not place the projector in direct sunlight or near hot objects such as heaters.
 - Do not place anything near the projector lens or vents, or on top of the projector.
 - Do not place anything that may be sucked into or stick to the vents on the bottom of the projector. This projector has some intake vents also on the bottom.
- Do not place the projector anyplace where it may get wet. Getting the projector wet or inserting liquid into the projector could cause fire, electric shock and/or malfunction of the projector.
- Do not place the projector in a bathroom or the outdoors.
 - Do not place anything containing liquid near the projector.
- ⚠ CAUTION** ► Avoid placing the projector in smoky, humid or dusty place. Placing the projector in such places could cause fire, electric shock and/or malfunction of the projector.
- Do not place the projector near humidifiers, smoking spaces or a kitchen.
- Position the projector to prevent light from directly hitting the projector's remote sensor.

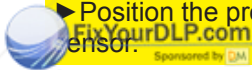

Discount-Merchant.com (800) 281-8860
THE TRUSTED SOURCE FOR PROJECTOR LAMPS AND ACCESSORIES

Connecting your devices

Be sure to read the manuals for devices before connecting them to the projector. Make sure that all the devices are suitable to be connected with this product, and prepare the cables required to connect. Please refer to the following illustrations to connect them.

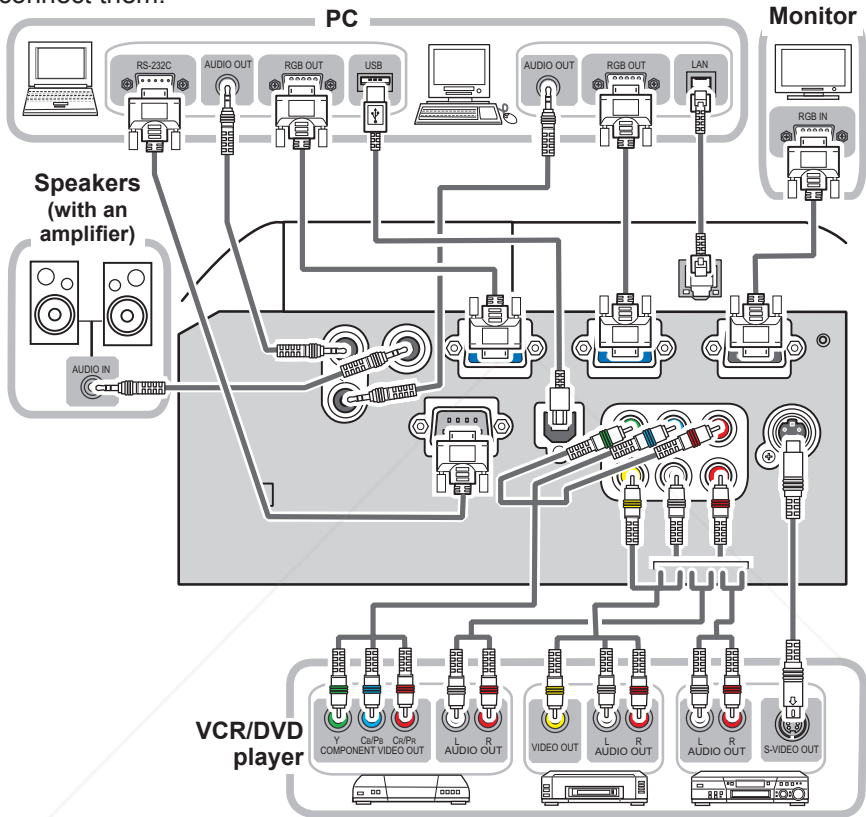

⚠ WARNING ▶ Do not disassemble or modify the projector and accessories.
▶ Be careful not to damage the cables, and do not use damaged cables.

⚠ CAUTION ▶ Turn off all devices and unplug their power cords prior to connecting them to projector. Connecting a live device to the projector may generate extremely loud noises or other abnormalities that may result in malfunction or damage to the device and the projector.

▶ Use appropriate accessory or designated cables. Ask your dealer about non-accessory cables which may be required a specific length or a ferrite core by the regulations. For cables with a core only at one end, connect the end with the core to the projector.

▶ Make sure that devices are connected to the correct ports. An incorrect connection may result in malfunction or damage to the device and the projector.

Connecting your devices (continued)

- NOTE** • Be sure to read the manuals for devices before connecting them to the projector, and make sure that all the devices are suitable to be connected with this product. Before connecting to a PC, check the signal level, the signal timing, and the resolution.
- Be sure to consult to the administrator of the network. Do not connect **LAN** port to any network that might have the excessive voltage.
 - Some signal may need an adapter to input this projector.
 - Some PCs have multiple screen display modes that may include some signals which are not supported by this projector.
 - Although the projector can display signals with resolution up to UXGA (1600X1200), the signal will be converted to the projector's panel resolution before being displayed. The best display performance will be achieved if the resolutions of the input signal and the projector panel are identical.
 - While connecting, make sure that the shape of the cable's connector fits the port to connect with. And be sure to tighten the screws on connectors with screws.
 - When connecting a laptop PC to the projector, be sure to activate the PC's external RGB output. (Set the laptop PC to CRT display or to simultaneous LCD and CRT display.) For details on how this is done, please refer to the instruction manual of the corresponding laptop PC.
 - When the picture resolution is changed on a PC depending on an input, automatic adjustment function may take some time and may not be completed. In this case, you may not be able to see a check box to select "Yes/No" for the new resolution on Windows. Then the resolution will go back to the original. It might be recommended to use other CRT or LCD monitors to change the resolution.
 - In some cases, this projector may not display a proper picture or display any picture on screen. For example, automatic adjustment may not function correctly with some input signals. An input signal of composite sync or sync on G may confuse this projector, so the projector may not display a proper picture.

About Plug-and-Play capability

Plug-and-Play is a system composed of a PC, its operating system and peripheral equipment (i.e. display devices). This projector is VESA DDC 2B compatible. Plug-and-Play can be used by connecting this projector to a PC that is VESA DDC (display data channel) compatible.

- Take advantage of this feature by connecting an RGB cable to the **COMPUTER IN1** port (DDC 2B compatible). Plug-and-Play may not work properly if any other type of connection is attempted.
- Please use the standard drivers in your PC as this projector is a Plug-and-Play monitor.

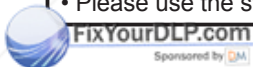

Discount-Merchant.com (800) 281-8860
THE TRUSTED SOURCE FOR PROJECTOR LAMPS AND ACCESSORIES

Connecting power supply

At first, make sure that the power switch of the projector is set to OFF position (marked “O”).

1. Put the connector of the power cord into the **AC IN** (AC inlet) of the projector.
2. Firmly plug the power cord's plug into the outlet.

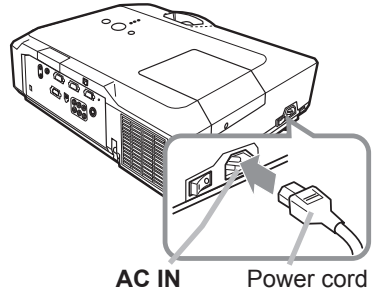

⚠ WARNING ▶ Please use extra caution when connecting the power cord, as incorrect or faulty connections may result in fire and/or electrical shock.

- Only use the power cord that came with the projector. If it is damaged, consult your dealer to get a new one.
- Only plug the power cord into an outlet whose voltage is matched to the power cord. The power outlet should be close to the projector and easily accessible. Remove the power cord for complete separation.
- Never modify the power cord.

Using the security bar and slot

A commercial anti-theft chain or wire up to 10 mm in diameter can be attached to the security bar on the projector.

Also this product has the security slot for the Kensington lock.

For details, see the manual of the security tool.

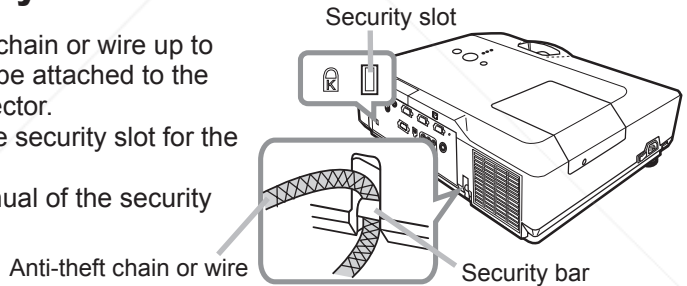

⚠ WARNING ▶ Do not use the security bar and slot to prevent the projector from falling down, since it is not designed for it.

⚠ CAUTION ▶ Do not place anti-theft chain or wire near the exhaust vents. It may become too hot.

NOTE • The security bar and slot is not comprehensive theft prevention measures. It is intended to be used as supplemental theft prevention measure.

Remote control

Installing the batteries

Please insert the batteries into the remote control before using it. If the remote control starts to malfunction, try to replace the batteries. If you will not use the remote control for long period, remove the batteries from the remote control and store them in a safe place.

1. Holding the hook part of the battery cover, remove it.
2. Align and insert the two AA batteries (**HITACHI MAXELL, Part No. LR6 or R6P**) according to their plus and minus terminals as indicated in the remote control.
3. Replace the battery cover in the direction of the arrow and snap it back into place.

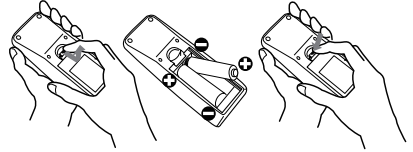

⚠ WARNING ▶ Always handle the batteries with care and use them only as directed. Improper use may result in battery explosion, cracking or leakage, which could result in fire, injury and/or pollution of the surrounding environment.

- Be sure to use only the batteries specified. Do not use batteries of different types at the same time. Do not mix a new battery with used one.
- Make sure the plus and minus terminals are correctly aligned when loading a battery.
- Keep a battery away from children and pets.
- Do not recharge, short circuit, solder or disassemble a battery.
- Do not place a battery in a fire or water. Keep batteries in a dark, cool and dry place.
- If you observe battery leakage, wipe out the leakage and then replace a battery. If the leakage adheres to your body or clothes, rinse well with water immediately.
- Obey the local laws on disposing the battery.

About the remote control signal

The remote control works with the projector's remote sensor. This projector has a remote sensor on the front. The sensor senses the signal within the following range when the sensor is active:
60 degrees (30 degrees to the left and right of the sensor)
within 3 meters about.

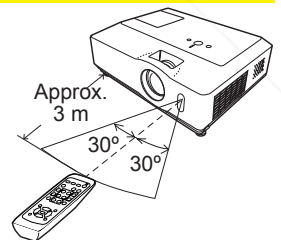

NOTE - The remote control signal reflected in the screen or the like may be available. If it is difficult to send the signal to the sensor directly, attempt to make the signal reflect.

- The remote control uses infrared light to send signals to the projector (Class 1 LED), so be sure to use the remote control in an area free from obstacles that could block the remote control's signal to the projector.
- The remote control may not work correctly if strong light (such as direct sun light) or light from an extremely close range (such as from an inverter fluorescent lamp) shines on the remote sensor of the projector. Adjust the position of projector avoiding those lights.

Changing the frequency of remote control signal

The accessory remote control has the two choices on signal frequency Mode 1:NORMAL and Mode 2:HIGH. If the remote control does not function properly, attempt to change the signal frequency. In order to set the Mode, please keep pressing the combination of two buttons listed below simultaneously for about 3 seconds.

- (1) Set to Mode 1:NORMAL... **VOLUME -** and **RESET** buttons
- (2) Set to Mode 2:HIGH... **MAGNIFY OFF** and **ESC** buttons

Please remember that the REMOTE FREQ. in the SERVICE item of the OPTION menu (45) of the projector to be controlled should be set to the same mode as the remote control.

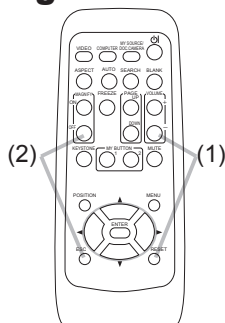

Using as a simple PC mouse & keyboard

The accessory remote control works as a simple mouse and keyboard of the PC, when the projector's **USB** port (B type) connects with the PC's USB port (A type) port via a mouse cable.

- (1) **PAGE UP** key: Press **PAGE UP** button.
- (2) **PAGE DOWN** key: Press **PAGE DOWN** button.
- (3) **Mouse left** button: Press **ENTER** button.
- (4) **Move pointer**: Use the cursor buttons **▲**, **▼**, **◀** and **▶**.
- (5) **ESC** key: Press **ESC** button.
- (6) **Mouse right** button: Press **RESET** button.

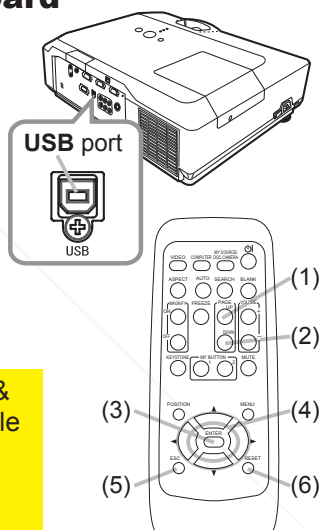

⚠ WARNING ▶ Improper use of the simple mouse & keyboard function could damage your equipment. While using this function, please connect this product only to a PC. Be sure to check your PC's manuals before connecting this product to the PC.

NOTE • When the simple mouse & keyboard function of this product does not work correctly, please check the following.

- When a USB cable connects this projector with a PC having a built-in pointing device (e.g. track ball) like a notebook PC, open BIOS setup menu, then select the external mouse and disable the built-in pointing device, because the built-in pointing device may have priority to this function.
- Windows 95 OSR 2.1 or higher is required for this function. And also this function may not work depending on the PC's configurations and mouse drivers.
- You cannot do things like press two buttons at once (for instance, pressing two buttons at the same time to move the mouse pointer diagonally).
- This function is activated only when the projector is working properly. This function is not available while the lamp is warming up (the **POWER** indicator blinks green), and while adjusting the volume and display, correcting for keystone, zooming in on the screen, using the **BLANK** function, or displaying the menu screen.

Power on/off

Turning on the power

1. Make sure that the power cord is firmly and correctly connected to the projector and the outlet.
2. Remove the lens cover, and set the power switch to ON position (marked "I").
The **POWER** indicator will light up in steady orange (📖67). Then wait several seconds because the buttons may not function for these several seconds.
3. Press **STANDBY/ON** button on the projector or the remote control.
The projection lamp will light up and **POWER** indicator will begin blinking in green. When the power is completely on, the indicator will stop blinking and light in steady green (📖67).

To display the picture, select an input signal according to the section "Selecting an input signal" (📖16).

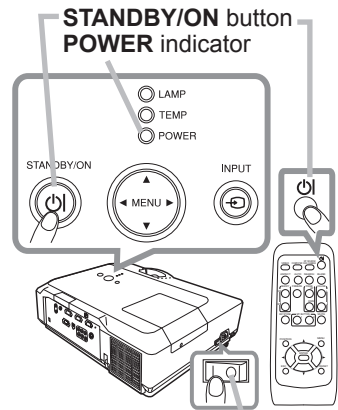

Power switch

Turning off the power

1. Press the **STANDBY/ON** button on the projector or the remote control. The message "Power off?" will appear on the screen for about 5 seconds.
2. Press the **STANDBY/ON** button again while the message appears.
The projector lamp will go off, and the **POWER** indicator will begin blinking in orange. Then **POWER** indicator will stop blinking and light in steady orange when the lamp cooling is complete (📖67).
3. Make sure that **POWER** indicator lights in steady orange, and set the power switch to OFF position (marked "O").
POWER indicator will go off. Attach the lens cover.

Do not turn the projector on for about 10 minutes or more after turning it off. Turning the projector on again too soon could shorten the lifetime of some consumable parts of the projector.



Power switch

⚠ WARNING ▶ A strong light is emitted when the projector's power is on. Do not look into the lens of the projector or look inside of the projector through any of the projector's openings.

▶ Do not touch around the lamp cover and the exhaust vents during use or just after use, since it is too hot.

NOTE • Turn the power on/off in right order. Please power on the projector prior to the connected devices.

- When the AUTO ON of the OPTION menu is set to the TURN ON, and the power was turned off by the power switch last time, turning the power switch on makes the projection lamp light on without pushing the **STANDBY/ON** button (📖41).
- Use the shutdown switch (📖68) only when the projector is not turned off by normal procedure.

Operating

Adjusting the volume

- Use the **VOLUME +/VOLUME -** buttons to adjust the volume.
 - A dialog will appear on the screen to aid you in adjusting the volume. If you do not do anything, the dialog will automatically disappear after a few seconds.
 - When \times is selected for current picture input port, the volume adjustment is disabled. Please see **AUDIO** item of **AUDIO** menu (36).
 - When the projector is in the standby mode, the volume can be adjusted if \times is not selected for the **AUDIO OUT STANDBY** of **AUDIO** (36).

VOLUME +/- button

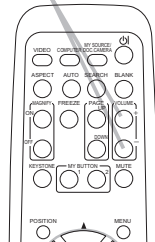

Temporarily muting the sound

- Press **MUTE** button on the remote control.
 - A dialog will appear on the screen indicating that you have muted the sound. To restore the sound, press the **MUTE**, **VOLUME +** or **VOLUME -** button. Even if you do not do anything, the dialog will automatically disappear after a few seconds.
 - When \times is selected for current picture input port, the sound is always muted. Please see **AUDIO** item of **AUDIO** menu (36).
 - When the sound is muted while a signal from **VIDEO**(NTSC), **S-VIDEO**(NTSC) or **COMPONENT**(480i@60)) port is selected, the C.C. (Closed Caption) is automatically activated if the **DISPLAY** item of the C.C. menu is set to **AUTO** and the input signal supports the C.C. feature (59).

MUTE button

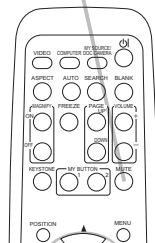

Selecting an input signal

- Press **INPUT** button on the projector.
 - Each time you press the button, the projector switches its input port from the current port as below.



- While **TURN ON** is selected for **AUTO SEARCH** item in **OPTION** menu (41), the projector will keep checking the ports in above order repeatedly till an input signal is detected.

INPUT button

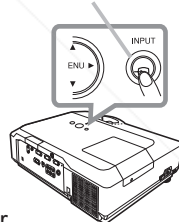

- Press **COMPUTER** button on the remote control.
 - Each time you press the button, the projector switches its input port from the current port as below.



- While **TURN ON** is selected for **AUTO SEARCH** item in **OPTION** menu, the projector will keep checking every port sequentially till an input signal is detected (41). If **COMPUTER** button is pushed when **VIDEO**, **S-VIDEO** or **COMPONENT** port is selected, the projector will check **COMPUTER IN1** port first.

COMPUTER button

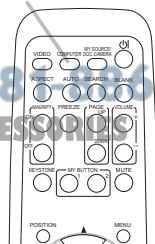

(continued on next page)

Selecting an input signal (continued)

1. Press **VIDEO** button on the remote control.
 - Each time you press the button, the projector switches its input port from the current port as below.

COMPONENT (Y, Cb/Pb, Cr/Pr) → S-VIDEO → VIDEO

- While TURN ON is selected for AUTO SEARCH item in OPTION menu, the projector will keep checking every port sequentially till an input signal is detected (41). If **VIDEO** button is pushed when **COMPUTER IN1** or **COMPUTER IN2** port is selected, the projector will check **COMPONENT** port first.

VIDEO button

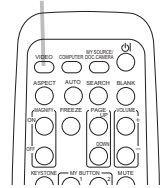

Searching an input signal

1. Press **SEARCH** button on the remote control.
 - The projector will start to check its input ports as below in order to find any input signals. When an input is found, the projector will stop searching and display the image. If no signal is found, the projector will return to the state selected before the operation.

COMPUTER IN 1 → COMPUTER IN 2
 VIDEO ← S-VIDEO ← COMPONENT (Y, Cb/Pb, Cr/Pr) ←

- While TURN ON is selected for AUTO SEARCH item in OPTION menu (41), the projector will keep checking the ports in above order repeatedly till an input signal is detected.

SEARCH button

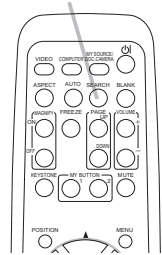

Selecting an aspect ratio

1. Press **ASPECT** button on the remote control.
 - Each time you press the button, the projector switches the mode for aspect ratio in turn.

- For a computer signal
 NORMAL → 4:3 → 16:9 → SMALL
- For a video signal, s-video signal or component video signal
 4:3 → 16:9 → 14:9 → SMALL
- For no signal
 4:3 (fixed)

ASPECT button

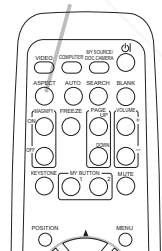

- **ASPECT** button does not work when no proper signal is inputted.
- **NORMAL** mode keeps the original aspect ratio setting.

FixYourDLP.com
 Discount-Merchant.com (800) 281-8860
 THE TRUSTED SOURCE FOR PROJECTOR LAMPS AND ACCESSORIES

Adjusting the projector's elevator

When the place to put the projector is slightly uneven to the left or right, use the elevator feet to place the projector horizontally.

Using the feet can also tilt the projector in order to project at a suitable angle to the screen, elevating the front side of the projector within 10 degrees.

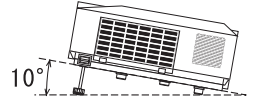

This projector has 2 elevator feet and 2 elevator buttons. An elevator foot is adjustable while pushing the elevator button on the same side as it.

1. Holding the projector, push the elevator buttons to loose the elevator feet.
2. Position the front side of the projector to the desired height.
3. Release the elevator buttons in order to lock the elevator feet.
4. After making sure that the elevator feet are locked, put the projector down gently.
5. If necessary, the elevator feet can be manually twisted to make more precise adjustments. Hold the projector when twisting the feet.

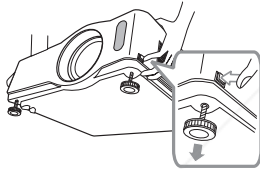

To loose an elevator foot, push the elevator button on the same side as it.

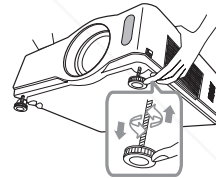

To finely adjust, twist the foot.

⚠ CAUTION ▶ Do not handle the elevator buttons without holding the projector, since the projector may drop down.

▶ Do not tilt the projector other than elevating its front within 10 degrees using the adjuster feet. A tilt of the projector exceeding the restriction could cause malfunction or shortening the lifetime of consumables, or the projector itself.

Adjusting the zoom and focus

1. Use the zoom ring to adjust the screen size.
2. Use the focus ring to focus the picture.



Using the automatic adjustment feature

1. Press **AUTO** button on the remote control.
 - Pressing this button performs the following.
 - **For a computer signal**
The vertical position, the horizontal position and the horizontal phase will be automatically adjusted. Make sure that the application window is set to its maximum size prior to attempting to use this feature. A dark picture may still be incorrectly adjusted. Use a bright picture when adjusting.
 - **For a video signal and s-video signal**
The video format best suited for the respective input signal will be selected automatically. This function is available only when the AUTO is selected for the VIDEO FORMAT item in the INPUT menu (📖32). The vertical position and horizontal position will be automatically set to the default.
 - **For a component video signal**
The vertical position, horizontal position and horizontal phase will be automatically set to the default.
 - The automatic adjustment operation requires approx. 10 seconds. Also please note that it may not function correctly with some input. When this function is performed for a video signal, a certain extra such as a line may appear outside a picture.
 - The items adjusted by this function may vary when the FINE or DISABLE is selected for the AUTO ADJUST item of the SERVICE item in the OPTION menu (📖44).

AUTO button

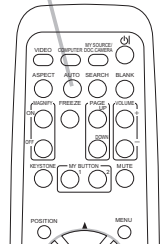

Adjusting the position

1. Press **POSITION** button on the remote control when no menu is indicated. The "POSITION" indication will appear on the screen.
2. Use the ▲/▼/◀/▶ cursor buttons to adjust the picture position. When you want to reset the operation, press **RESET** button on the remote control during the operation.

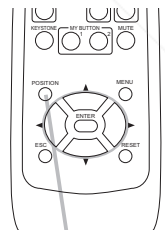

POSITION button

To complete this operation, press **POSITION** button again. Even if you do not do anything, the dialog will automatically disappear after a few seconds.

- When this function is performed on a video signal, s-video signal or component video signal, some image such as an extra-line may appear at outside of the picture.
- When this function is performed on a video signal, s-video signal or component video signal, the range of this adjustment depends on OVER SCAN in IMAGE menu (📖29) setting. It is not possible to adjust when OVER SCAN is set to 10.
- If **POSITION** button is pressed when a menu is indicated on screen, the displayed picture does not move its position but the menu does.

Correcting the keystone distortions

1. Press **KEYSTONE** button on the remote control. A dialog will appear on the screen to aid you in correcting the distortion.
2. Use the $\blacktriangle/\blacktriangledown$ cursor buttons to select **AUTO** or **MANUAL** operation, and press the \blacktriangleright button to perform the following.

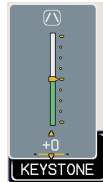
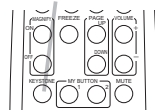

- (1) **AUTO** executes automatic vertical keystone correction.
- (2) **MANUAL** displays a dialog for keystone correction. Use the $\blacktriangle/\blacktriangledown$ buttons for adjustment.

To close the dialog and complete this operation, press **KEYSTONE** button again. Even if you do not do anything, the dialog will automatically disappear after a few seconds.

- The adjustable range of this correction will vary among inputs. For some input, this function may not work well.
- When V:INVERT or H&V:INVERT is selected to the MIRROR item in the SETUP menu, if the projector screen is inclined or angled downward, this function may not work correctly.
- When the zoom adjustment is set to the TELE (telephoto focus), the automatic keystone distortion correction may be excessive. This function should be used when the zoom adjustment is set to the full WIDE (wide-angle focus) whenever possible.
- When the projector is placed on the level (about $\pm 3^\circ$), the automatic keystone distortion correction may not work.
- When the projector is inclined to near ± 30 degree or over, this function may not work well.
- This function will be unavailable when Transition Detector is on (p.50).

Using the magnify feature

1. Press the **ON** button of **MAGNIFY** on the remote control. The "MAGNIFY" indication will appear on the screen and the projector will go into the MAGNIFY mode. When the **ON** button of **MAGNIFY** is pressed first after the projector is started, the picture will be zoomed twice. The indication will disappear in several seconds with no operation.
2. Use the $\blacktriangle/\blacktriangledown$ cursor buttons to adjust the zoom level. The picture of video, s-video or component video signal can be zoomed in up to 2 times, and the picture of computer signal can be zoomed in up to 4 times. To move the zoom area, press the **POSITION** button in the MAGNIFY mode, then use the $\blacktriangle/\blacktriangledown/\blacktriangleleft/\blacktriangleright$ cursor buttons to move the area. And to finalize the zoom area, press the **POSITION** button again.

MAGNIFY ON/OFF button

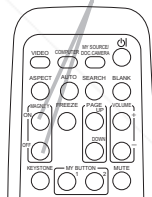

To exit from the MAGNIFY mode and restore the screen to normal, press the **OFF** button of **MAGNIFY** on the remote control.

- The projector automatically exits from the MAGNIFY mode when the input signal is changed or when the display condition is changed.
- In the MAGNIFY mode, the keystone distortion condition may vary, it will be restored when the projector exits from the MAGNIFY mode.

NOTE • The zoom level can be finely adjusted. Closely watch the screen to find the level you want.

Freezing the screen

1. Press the **FREEZE** button on the remote control.
 - The “FREEZE” indication will appear on the screen (however, the indication will not appear when the TURN OFF is selected for the MESSAGE item in the SCREEN menu (☐39)), and the projector will go into the FREEZE mode, which the picture is frozen.
 - To exit the FREEZE mode and restore the screen to normal, press the **FREEZE** button again.

FREEZE button

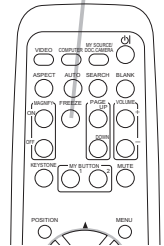

- The projector automatically exits from the FREEZE mode when some control buttons are pressed.
- If the projector continues projecting a still image for a long time, the LCD panel might possibly be burned in. Do not leave the projector in the FREEZE mode for too long.

Temporarily blanking the screen

1. Press **BLANK** button on the remote control.
 - The BLANK screen will be displayed instead of the screen of input signal. Please refer to BLANK item in SCREEN menu (☐37).
 - To exit from the BLANK screen and return to the input signal screen, press **BLANK** button again.

BLANK button

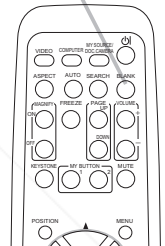

NOTE • The sound is not connected with the BLANK screen function. If necessary, set the volume or mute first.

Using the menu function

This projector has the following menus:

PICTURE, IMAGE, INPUT, SETUP, AUDIO, SCREEN, OPTION, NETWORK, C.C. and EASY MENU.

EASY MENU consists of functions often used, and the other menus are classified into each purpose and brought together as the Advanced Menu.

Each of these menus is operated using the same methods. The basic operations of these menus are as follows.

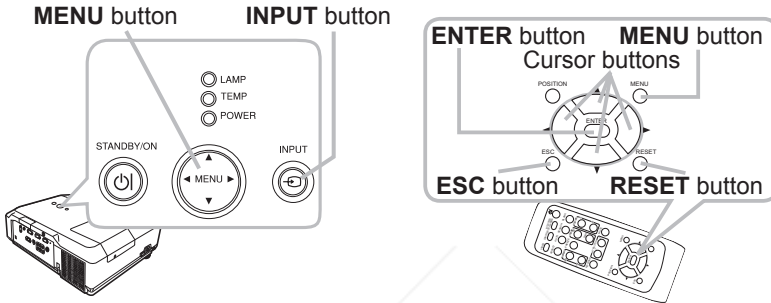

1. Press the **MENU** button on the remote control or the projector.
The Advanced Menu or EASY MENU, which has priority just after powered on will appear.
If you want to move the menu position, use the cursor buttons after pressing the **POSITION** button. While the projector is displaying any menu, the **MENU** button on the projector works as the cursor buttons.

In the EASY MENU

2. If you want to change it to the Advanced Menu, select the Go to Advanced Menu...
3. Use the **▲/▼** cursor buttons to select an item to operate.
4. Use the **◀/▶** cursor buttons to operate the item.



EASY MENU

Using the menu function (continued)

In the Advanced Menu

2. Use the ▲/▼ cursor buttons to select a menu. If you want to change it to the EASY MENU, select EASY MENU. Then press the ► cursor button, or **ENTER** button to select an item. The lower layer menu of the selected item will appear.



Advanced Menu

3. Use the ▲/▼ cursor buttons to select an item to operate. Then press the ► cursor button, or **ENTER** button to progress. The operation menu of the selected item will appear.
4. Use the ▲/▼ cursor buttons to operate the item.
 - Some functions cannot be performed when a certain input port is selected, or when a certain input signal is displayed.
 - When you want to reset the operation, press **RESET** button on the remote control during the operation. Note that some items (ex. LANGUAGE, H PHASE, VOLUME) cannot be reset.
 - In the Advanced Menu, when you want to return to the previous display, press the ◀ cursor button or **ESC** button on the remote control.
5. Press **MENU** button on the remote control again to close the menu and complete this operation. Even if you do not do anything, the dialog will automatically disappear after about 10 seconds.

EASY MENU

From the EASY MENU, items shown in the table below can be performed.

Select an item using the ▲/▼ cursor buttons. Then perform it according to the following table.



Item	Description																								
ASPECT	Using the ◀/▶ buttons switches the mode for aspect ratio. See the ASPECT item in IMAGE menu (📖 29).																								
AUTO KEYSTONE EXECUTE [↵]	Using the ▶ button executes the auto keystone function. See AUTO KEYSTONE [↵] EXECUTE item in SETUP menu (📖 34).																								
KEYSTONE [↵]	Using the ◀/▶ buttons corrects the vertical keystone distortion. See KEYSTONE [↵] item in SETUP menu (📖 34).																								
PICTURE MODE	<p>Using the ◀/▶ buttons switches the picture mode. The picture modes are combinations of GAMMA and COLOR TEMP settings. Choose a suitable mode according to the projected source.</p> <p> ↻ → NORMAL ↔ CINEMA ↔ DYNAMIC ↔ BOARD(BLACK) ↻ ↻ → DAYTIME ↔ WHITEBOARD ↔ BOARD(GREEN) ↻ </p> <table border="1"> <thead> <tr> <th></th> <th>COLOR TEMP</th> <th>GAMMA</th> </tr> </thead> <tbody> <tr> <td>NORMAL</td> <td>#2 MID</td> <td>#1 DEFAULT</td> </tr> <tr> <td>CINEMA</td> <td>#3 LOW</td> <td>#2 DEFAULT</td> </tr> <tr> <td>DYNAMIC</td> <td>#1 HIGH</td> <td>#3 DEFAULT</td> </tr> <tr> <td>BOARD(BLACK)</td> <td>#4 Hi-BRIGHT-1</td> <td>#4 DEFAULT</td> </tr> <tr> <td>BOARD(GREEN)</td> <td>#5 Hi-BRIGHT-2</td> <td>#4 DEFAULT</td> </tr> <tr> <td>WHITEBOARD</td> <td>#2 MID</td> <td>#5 DEFAULT</td> </tr> <tr> <td>DAYTIME</td> <td>#6 Hi-BRIGHT-3</td> <td>#6 DEFAULT</td> </tr> </tbody> </table> <ul style="list-style-type: none"> • When the combination of GAMMA and COLOR TEMP differs from pre-assigned modes above, the display on the menu for the PICTURE MODE is "CUSTOM". Please refer to GAMMA (📖 26) and COLOR TEMP (📖 27) items in PICTURE menu. • When this function is performed, a certain extra such as a line may appear. 		COLOR TEMP	GAMMA	NORMAL	#2 MID	#1 DEFAULT	CINEMA	#3 LOW	#2 DEFAULT	DYNAMIC	#1 HIGH	#3 DEFAULT	BOARD(BLACK)	#4 Hi-BRIGHT-1	#4 DEFAULT	BOARD(GREEN)	#5 Hi-BRIGHT-2	#4 DEFAULT	WHITEBOARD	#2 MID	#5 DEFAULT	DAYTIME	#6 Hi-BRIGHT-3	#6 DEFAULT
	COLOR TEMP	GAMMA																							
NORMAL	#2 MID	#1 DEFAULT																							
CINEMA	#3 LOW	#2 DEFAULT																							
DYNAMIC	#1 HIGH	#3 DEFAULT																							
BOARD(BLACK)	#4 Hi-BRIGHT-1	#4 DEFAULT																							
BOARD(GREEN)	#5 Hi-BRIGHT-2	#4 DEFAULT																							
WHITEBOARD	#2 MID	#5 DEFAULT																							
DAYTIME	#6 Hi-BRIGHT-3	#6 DEFAULT																							

(continued on next page)

EASY MENU (continued)

Item	Description
BRIGHTNESS	Using the ◀/▶ buttons adjusts the brightness. See BRIGHTNESS item in PICTURE menu (📖26).
CONTRAST	Using the ◀/▶ buttons adjusts the contrast. See CONTRAST item in PICTURE menu (📖26).
COLOR	Using the ◀/▶ buttons adjusts the strength of whole color. See COLOR item in PICTURE menu (📖27).
TINT	Using the ◀/▶ buttons adjusts the tint. See TINT item in PICTURE menu (📖27).
SHARPNESS	Using the ◀/▶ buttons adjusts the sharpness. See SHARPNESS item in PICTURE menu (📖28).
WHISPER	Using the ◀/▶ buttons turns off/on the whisper mode. See WHISPER item in SETUP menu (📖35).
MIRROR	Using the ◀/▶ buttons switches the mode for mirror status. See MIRROR item in SETUP menu (📖35).
RESET	Performing this item resets all of EASY MENU items except FILTER TIME and LANGUAGE. A dialog is displayed for confirmation. Selecting RESET using the ▲ button performs resetting.
FILTER TIME	The usage time of the air filter is shown in the menu. Performing this item resets the filter time which counts usage time of the air filter. A dialog is displayed for confirmation. Selecting RESET using the ▲ button performs resetting. See FILTER TIME item in OPTION menu (📖42).
LANGUAGE	Using the ◀/▶ buttons changes the display language. See LANGUAGE item in SCREEN menu (📖37).
Go to Advanced Menu...	Select Go to Advanced Menu... on the menu, and press the ▶ or ENTER button to use the menu of PICTURE, IMAGE, INPUT, SETUP, AUDIO, SCREEN, OPTION, NETWORK or C.C..

PICTURE menu

From the PICTURE menu, items shown in the table below can be performed.

Select an item using the ▲/▼ cursor buttons, and press the ► cursor button or **ENTER** button to execute the item. Then perform it according to the following table.

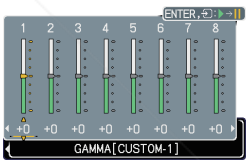

Item	Description
BRIGHTNESS	Using the ▲/▼ buttons adjusts the brightness. Light ⇄ Dark
CONTRAST	Using the ▲/▼ buttons adjusts the contrast. Strong ⇄ Weak
GAMMA	<p>Using the ▲/▼ buttons switches the gamma mode.</p> <p>#1 DEFAULT ⇄ #1 CUSTOM ⇄ #2 DEFAULT ⇄ #2 CUSTOM ⇕ ⇕ #6 CUSTOM #3 DEFAULT ⇕ ⇕ #6 DEFAULT #3 CUSTOM ⇕ ⇕ #5 CUSTOM ⇄ #5 DEFAULT ⇄ #4 CUSTOM ⇄ #4 DEFAULT</p> <p>To adjust CUSTOM</p> <p>Selecting a mode whose name includes CUSTOM and then pressing the ► button or the ENTER button displays a dialog to aid you in adjusting the mode. This function is useful when you want to change the brightness of particular tones.</p>  <p>Choose an item using the ◀/▶ buttons, and adjust the level using the ▲/▼ buttons.</p> <p>You can display a test pattern for checking the effect of your adjustment by pressing the ENTER button. Each time you press the ENTER button, the pattern changes as below.</p> <p>No pattern ⇄ Gray scale of 9 steps ⇐ ⇑ ⇐ Ramp ⇐ Gray scale of 15 steps</p> <p>The eight equalizing bars correspond to eight tone levels of the test pattern (Gray scale of 9 steps), except the darkest in the left end. If you want to adjust the 2nd tone from left end on the test pattern, use the equalizing adjustment bar "1". The darkest tone at the left end of the test pattern cannot be controlled with any of equalizing adjustment bar.</p> <ul style="list-style-type: none"> • When this function is performed, lines or other distortion may appear.

(continued on next page)

PICTURE menu (continued)

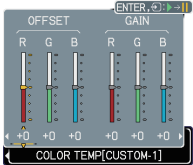
Item	Description
<p>COLOR TEMP</p>	<p>Using the ▲/▼ buttons switches the color temperature mode.</p> <p>#1 HIGH ⇔ #1 CUSTOM ⇔ #2 MID ⇔ #2 CUSTOM ⇕ #6 CUSTOM #3 LOW ⇕ #6 HI-BRIGHT-3 #3 CUSTOM ⇕ #5 CUSTOM ⇔ #5 HI-BRIGHT-2 ⇔ #4 CUSTOM ⇔ #4 HI-BRIGHT-1</p> <p>To adjust CUSTOM</p> <p>Selecting a mode whose name includes CUSTOM and then pressing the ► button or the ENTER button displays a dialog to aid you in adjusting the OFFSET and GAIN of the selected mode.</p>  <p>OFFSET adjustments change the color intensity on the whole tones of the test pattern.</p> <p>GAIN adjustments mainly affect color intensity on the brighter tones of the test pattern.</p> <p>Choose an item using the ◀/▶ buttons, and adjust the level using the ▲/▼ buttons.</p> <p>You can display a test pattern for checking the effect of your adjustment by pressing the ENTER button. Each time you press the ENTER button, the pattern changes as below.</p> <p>No pattern ⇔ Gray scale of 9 steps ⇐ ⇐ Ramp ⇔ Gray scale of 15 steps</p> <ul style="list-style-type: none"> • When this function is performed, lines or other distortion may appear.
<p>COLOR</p>	<p>Using the ▲/▼ buttons adjusts the strength of whole color.</p> <p>Strong ⇔ Weak</p> <ul style="list-style-type: none"> • This item can be selected only for a video signal, s-video or component video signal.
<p>TINT</p>	<p>Using the ▲/▼ buttons adjusts the tint.</p> <p>Greenish ⇔ Reddish</p> <ul style="list-style-type: none"> • This item can be selected only for a video signal, s-video or component video signal.

(continued on next page)

PICTURE menu (continued)

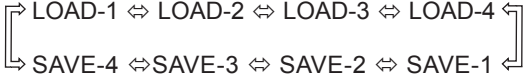
Item	Description
<p>SHARPNESS</p>	<p>Using the ▲/▼ buttons adjusts the sharpness. Strong ⇔ Weak</p> <ul style="list-style-type: none"> • There may be some noise and/or the screen may flicker for a moment when an adjustment is made. This is not a malfunction.
<p>MY MEMORY</p>	<p>This projector has 4 memories for adjustment data (for all the items of PICTURE menu). Selecting a function using the ▲/▼ buttons and pressing the ► or ENTER button performs each function.</p> <div style="text-align: center;">  <p>LOAD-1 ⇔ LOAD-2 ⇔ LOAD-3 ⇔ LOAD-4 SAVE-4 ⇔ SAVE-3 ⇔ SAVE-2 ⇔ SAVE-1</p> </div> <p><u>LOAD-1, LOAD-2, LOAD-3, LOAD-4</u></p> <p>Performing a LOAD function loads the data from the memory linked in the number included in the function's name, and adjusts the picture automatically depending on the data.</p> <ul style="list-style-type: none"> • The LOAD functions whose linked memory has no data are skipped. • Remember that the current adjusted condition will be lost by loading data. If you want to keep the current adjustment, please save it before performing a LOAD function. • There may be some noise and the screen may flicker for a moment when loading data. This is not malfunction. • You can perform the LOAD function using MY BUTTONS. Please see MY BUTTON item in OPTION menu (43). <p><u>SAVE-1, SAVE-2, SAVE-3, SAVE-4</u></p> <p>Performing a SAVE function saves the current adjustment data into the memory linked in the number included in the function's name.</p> <ul style="list-style-type: none"> • Remember that the current data being stored of a memory will be lost by saving a new data into the memory.



Discount-Merchant.com (800) 281-8860
 THE TRUSTED SOURCE FOR PROJECTOR LAMPS AND ACCESSORIES

IMAGE menu

From the IMAGE menu, items shown in the table below can be performed.

Select an item using the ▲/▼ cursor buttons, and press the ► cursor button or **ENTER** button to execute the item. Then perform it according to the following table.

MENU [COMPUTER 1]		SELECT
PICTURE	ASPECT	NORMAL
IMAGE	OVER SCAN	5
INPUT	V POSITION	35
SETUP	H POSITION	293
AUDIO	H PHASE	4
SCREEN	H SIZE	1344
OPTION	AUTO ADJUST	EXECUTE
NETWORK		
C.C.		
EASY MENU		

Item	Description
ASPECT	<p>Using the ▲/▼ buttons switches the mode for aspect ratio.</p> <p>For a computer signal NORMAL ⇔ 4:3 ⇔ 16:9 ⇔ SMALL ↑—————↑</p> <p>For a Video signal, S-video signal or Component video signal 4:3 ⇔ 16:9 ⇔ 14:9 ⇔ SMALL ↑—————↑</p> <p>For no signal 4:3 (fixed)</p> <ul style="list-style-type: none"> • The NORMAL mode keeps the original aspect ratio of the signal.
OVER SCAN	<p>Using the ▲/▼ buttons adjusts the over-scan ratio.</p> <p>Large (It reduces picture) ⇔ Small (It magnifies picture)</p> <ul style="list-style-type: none"> • This item can be selected only for a video, s-video and component video signal. • When this adjustment is too large, certain degradation may appear at the frame area of the picture. In such a case, please adjust small.
V POSITION	<p>Using the ▲/▼ buttons adjusts the vertical position.</p> <p>Up ⇔ Down</p> <ul style="list-style-type: none"> • Over-adjusting the vertical position may cause noise to appear on the screen. If this occurs, please reset the vertical position to the default setting. <p>Pressing RESET button when V POSITION is selected will reset V POSITION to the default setting.</p> <ul style="list-style-type: none"> • When this function is performed on a video signal, s-video signal, or component video signal, the range of this adjustment depends on OVER SCAN (above) setting. It is not possible to adjust when OVER SCAN is set to 10.



Discount-Merchant.com (800) 281-8860
 THE TRUSTED SOURCE FOR PROJECTOR LAMPS AND ACCESSORIES

(continued on next page)

IMAGE menu (continued)

Item	Description
<p>H POSITION</p>	<p>Using the ▲/▼ buttons adjusts the horizontal position. Left ⇔ Right</p> <ul style="list-style-type: none"> • Over-adjusting the horizontal position may cause noise to appear on the screen. If this occurs, please reset the horizontal position to the default setting. Pressing RESET button when H POSITION is selected will reset H POSITION to the default setting. • When this function is performed on a video signal, s-video signal, or component video signal, the range of this adjustment depends on OVER SCAN (📄29) setting. It is not possible to adjust when OVER SCAN is set to 10.
<p>H PHASE</p>	<p>Using the ▲/▼ buttons adjusts the horizontal phase to eliminate flicker. Right ⇔ Left</p> <ul style="list-style-type: none"> • This item can be selected only for a computer signal or component video signal.
<p>H SIZE</p>	<p>Using the ▲/▼ buttons adjusts the horizontal size. Large ⇔ Small</p> <ul style="list-style-type: none"> • This item can be selected only for a computer signal. • When this adjustment is excessive, the picture may not be displayed correctly. In such a case, please reset the adjustment by pressing the RESET button during this operation.
<p>AUTO ADJUST EXECUTE</p>	<p>Executing this item performs the automatic adjustment feature.</p> <p>For a computer signal The vertical position, the horizontal position and the horizontal phase (📄44) will be automatically adjusted. Make sure that the application window is set to its maximum size prior to attempting to use this feature. A dark picture may still be incorrectly adjusted. Use a bright picture when adjusting.</p> <p>For a video signal and s-video signal The video format best suited for the respective input signal will be selected automatically. This function is available only when the AUTO is selected for the VIDEO FORMAT item in the INPUT menu (📄32). The vertical position and horizontal position will be automatically set to the default.</p> <p>For a component video signal The vertical position, horizontal position and horizontal phase will be automatically set to the default.</p> <ul style="list-style-type: none"> • The automatic adjustment operation requires approx. 10 seconds. Also please note that it may not function correctly with some input. • When this function is performed for a video signal, a certain extra such as a line may appear outside a picture. • The items adjusted by this function may vary when the FINE or DISABLE is selected for the AUTO ADJUST item of the SERVICE item in the OPTION menu (📄44).



Discount- THE TRUSTED SOURCE FOR ALL YOUR DISCOUNTS (800) 881-8850

INPUT menu

From the INPUT menu, items shown in the table below can be performed.

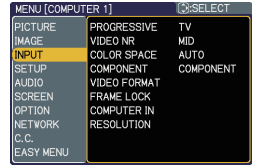

Select an item using the ▲/▼ cursor buttons, and press the ► cursor button or ENTER button to execute the item. Then perform it according to the following table.



Item	Description
PROGRESSIVE	<p>Using the ▲/▼ buttons switches the progress mode. TV ⇄ FILM ⇄ TURN OFF ↑</p> <ul style="list-style-type: none"> This function is performed only for an interlaced signal at the VIDEO or S-VIDEO input, and for 480i@60 or 576i@50 signal at the COMPONENT input. When TV or FILM is selected, the screen image will be sharp. FILM adapts to the 2-3 Pull-Down conversion system. But these may cause a certain defect (for example, jagged line) of the picture for a quick moving object. In such a case, please select TURN OFF, even though the screen image may lose the sharpness.
VIDEO NR	<p>Using the ▲/▼ buttons switches the noise reduction mode. HIGH ⇄ MID ⇄ LOW ↑</p> <ul style="list-style-type: none"> This function is performed only for the VIDEO or S-VIDEO input, and for 480i@60 or 576i@50 signal at the COMPONENT input. When this function is excessive, it may cause a certain degradation of the picture.
COLOR SPACE	<p>Using the ▲/▼ buttons switches the mode for color space. AUTO ⇄ RGB ⇄ SMPTE240 ⇄ REC709 ⇄ REC601 ↑</p> <ul style="list-style-type: none"> This item can be selected only for a computer signal or component video signal except SCART RGB signal. The AUTO mode automatically selects the optimum mode. The AUTO operation may not work well at some signals. In such a case, it might be good to select a suitable mode except AUTO.
COMPONENT	<p>Using the ▲/▼ buttons switches the function of the COMPONENT (Y, Cb/Pb, Cr/Pr) port. COMPONENT ⇄ SCART RGB</p> <p>When the SCART RGB is selected, COMPONENT (Y, Cb/Pb, Cr/Pr) and VIDEO ports will function as a SCART RGB port. A SCART cable is required for a SCART RGB input to the projector. For your reference, see the TECHNICAL part.</p>

(continued on next page)

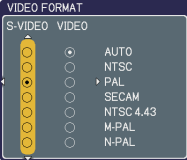
INPUT menu (continued)

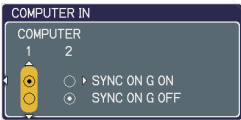
Item	Description
<p>VIDEO FORMAT</p>	<p>The video format for S-VIDEO port and VIDEO port can be set.</p> <p>(1) Use the ◀/▶ buttons to select the input port.</p> <p>(2) Using the ▲/▼ buttons switches the mode for video format.</p> <p>AUTO ⇄ NTSC ⇄ PAL ⇄ SECAM ↕ N-PAL ⇄ M-PAL ⇄ NTSC4.43 ↕</p> <ul style="list-style-type: none"> • This item is performed only for a video signal from VIDEO port or S-VIDEO port. • The AUTO mode automatically selects the optimum mode. • The AUTO operation may not work well for some signals. If the picture becomes unstable (e.g. an irregular picture, lack of color), please select the mode according to the input signal. 
<p>FRAME LOCK</p>	<p>Set the frame lock function on/off for each port.</p> <p>(1) Using the ▲/▼ buttons to select one of following ports.</p> <p>QUIT ⇄ COMPUTER(IN)1 ⇄ COMPUTER(IN)2 ↕ ↕</p> <p>(2) Using the ◀/▶ buttons to turns the frame lock function on/off.</p> <p>TURN ON ⇄ TURN OFF</p> <ul style="list-style-type: none"> • This item can be performed only on a signal with a vertical frequency of 50 to 60 Hz. • When the TURN ON is selected, the moving pictures are displayed more smoothly. • This function may cause a certain degradation of the picture. In such a case, please select TURN OFF. 
<p>COMPUTER IN</p>	<p>The computer input signal type for COMPUTER IN1 and IN2 ports can be set.</p> <p>(1) Use the ◀/▶ buttons to select the input port to be set.</p> <p>COMPUTER (IN)1 ⇄ COMPUTER (IN)2</p> <p>(2) Use the ▲/▼ buttons to select the computer input signal type.</p> <p>SYNC ON G ON ⇄ SYNC ON G OFF</p> <p>Selecting SYNC ON G ON allows reception of sync on G signal.</p> <ul style="list-style-type: none"> • When SYNC ON G ON is selected, the picture may be distorted with certain input signals. In such a case, remove the signal connector first and select SYNC ON G OFF on the menu, and then reconnect the signal. 



(continued on next page)

INPUT menu (continued)

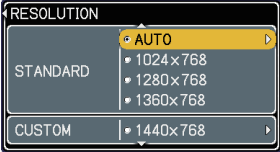
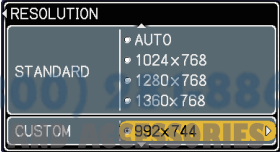
Item	Description
<p>RESOLUTION</p>	<p>The resolution for the COMPUTER IN1 and IN2 input signals can be set on this projector.</p> <p>(1) In the INPUT menu select the RESOLUTION using the ▲/▼ buttons and press the ► button. The RESOLUTION menu will be displayed.</p> <p>(2) In the RESOLUTION menu, select the resolution you wish to display using the ▲/▼ buttons. Selecting AUTO will set a resolution appropriate to the input signal.</p>  <p>(3) STANDARD Pressing the ► or ENTER button when selecting a STANDARD resolution will automatically adjust the horizontal and vertical positions, clock phase and horizontal size and automatically select an aspect ratio.</p> <p>(3) CUSTOM</p> <p>(3)-1 To set a custom resolution use the ▲/▼ buttons to select the CUSTOM and the CUSTOM RESOLUTION box will be displayed. Set the horizontal (HORZ) and vertical (VERT) resolutions using the ▲/▼ /◀/► buttons. It is not guaranteed to work this function properly on any resolutions.</p> <p>(3)-2 To save the setting place the cursor on the right-most digit and press the ► button. The horizontal and vertical positions, clock phase and horizontal size will be automatically adjusted.</p> <p>(3)-3 To revert back to the previous resolution without saving changes place the cursor on the left-most digit and press the ◀ button. The screen will then return to the RESOLUTION menu displaying the previous resolution.</p> <p>• For some pictures, this function may not work well.</p> <div style="display: flex; justify-content: space-around; align-items: center;"> <div style="text-align: center;"> <p>STANDARD</p> <p>↓</p> <div style="border: 1px solid black; padding: 5px; background-color: #f0f0f0;"> <p>COMPUTER 1 1280x768@60Hz</p> </div> </div> <div style="text-align: center;"> <p>CUSTOM</p> <p>↓</p> <div style="border: 1px solid black; padding: 5px; background-color: #333; color: white;"> <p>CUSTOM RESOLUTION</p> <p>(HORZ) × (VERT)</p> <p>◀ 0 9 9 2 × 0 7 4 4 ▶</p> <p>◀ QUIT SET ▶</p> </div> </div> <div style="text-align: center;"> <div style="border: 1px solid black; padding: 5px; background-color: #f0f0f0;"> <p>COMPUTER 1 992x744@60Hz</p> </div> </div> </div> 



Discount-Monitors.com (800) 708-8860
 THE TRUSTED SOURCE FOR PROJECTOR LAMPS

SETUP menu

From the SETUP menu, items shown in the table below can be performed.

Select an item using the ▲/▼ cursor buttons, and press the ► cursor button or the **ENTER** button to execute the item. Then perform it according to the following table.

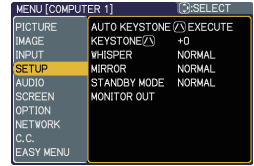

Item	Description
<p>AUTO KEYSTONE EXECUTE (Z)</p>	<p>Selecting this item performs the automatic keystone distortion correction. Projector automatically corrects vertical keystone distortion due to the (forward/backward) setup angle by itself.</p> <p>This function will be executed only once when selected in the menu. When the slant of the projector is changed, execute this function again.</p> <ul style="list-style-type: none"> • The adjustable range for correction will vary among inputs. For some input, this function may not work well. • When V:INVERT or H&V:INVERT is selected to the MIRROR item in the SETUP menu, if the projector screen is inclined or angled downward, this function may not work correctly. • When the zoom adjustment is set to the TELE (telephoto focus), this function may be excessive. This function should be used when the zoom adjustment is set to the full WIDE (wide-angle focus) whenever possible. • When the projector is placed on the level (about $\pm 3^\circ$), this function may not work. • When the projector is inclined to near ± 30 degree or over, this function may not work well. • This function will be unavailable when the Transition Detector is on (50).
<p>KEYSTONE (Z)</p>	<p>Using the ▲/▼ buttons corrects the vertical keystone distortion.</p> <p>Shrink the top of the image ⇔ Shrink the bottom of the image</p> <ul style="list-style-type: none"> • The adjustable range of this function will vary with the type of input signal. For some input, this function may not work well. • This function will be unavailable when the Transition Detector is on (50).

FixYourDLP.com
continued on next page)

Discount-Merchant.com (800) 281-8860
THE TRUSTED SOURCE FOR PROJECTOR LAMPS AND ACCESSORIES

AUDIO menu

From the AUDIO menu, items shown in the table below can be performed. Select an item using the ▲/▼ cursor buttons, and press the ► cursor button or the **ENTER** button to execute the item. Then perform it according to the following table.

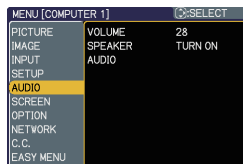

Item	Description
VOLUME	Using the ▲/▼ buttons adjusts the volume. High ⇔ Low
SPEAKER	Using the ▲/▼ buttons turns on/off the built-in speaker. TURN ON ⇔ TURN OFF When TURN OFF is selected, the built-in speaker does not work.
AUDIO	<p>The combination of a picture and audio input port can be arranged in the menu. The audio coming into the port selected in the (2) is output while an image from the port chosen in the (1) is on screen.</p> <p>(1) Choose a picture input port using the ▲/▼ buttons.</p> <p style="text-align: center;">QUIT ⇔ COMPUTER(IN)1 ⇔ COMPUTER(IN)2 ⇕ AUDIO OUT STANDBY ⇔ VIDEO ⇔ S-VIDEO ⇔ COMPONENT (Y, Cb/Pb, Cr/Pr)</p> <p>• Choose AUDIO OUT STANDBY, to select the audio output to the AUDIO OUT port in the standby mode. The built-in speaker does not work in the standby mode.</p> <p>• While QUIT is selected, pressing the ◀ button returns to the previous menu.</p> <p>(2) Select one of the AUDIO IN ports using ◀/▶ buttons.</p> <p style="text-align: center;">1 (AUDIO IN1) ⇔ 2 (AUDIO IN2) ⇔ 3 (AUDIO IN3) ⇔ ✕ ↑↑</p> <p>• ✕ disables the audio output.</p> <p>• When ✕ is selected to VIDEO, S-VIDEO or COMPONENT port, the C.C. (Closed Caption) is automatically activated, if the C.C. is set to AUTO in the DISPLAY menu of the C.C. menu and the signal from the input port supports the C.C. feature (59).</p>

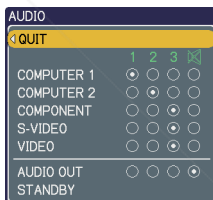

SCREEN menu

From the SCREEN menu, items shown in the table below can be performed.

Select an item using the ▲/▼ cursor buttons, and press the ► cursor button or **ENTER** button to execute the item. Then perform it according to the following table.

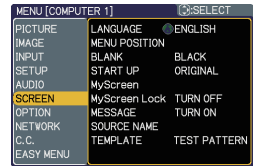



Item	Description								
LANGUAGE	<p>Using the ▲/▼ buttons switches the OSD (On Screen Display) language.</p> <p>ENGLISH ⇄ FRANÇAIS ⇄ DEUTSCH ⇄ ESPAÑOL ⇄ ITALIANO ⇄ TÜRKÇE ⇄ POLSKI ⇄ SUOMI ⇄ РУССКИЙ ⇄ SVENSKA ⇄ 한글 ⇄ 繁體中文 ⇄ 简体中文 ⇄ 日本語</p>								
MENU POSITION	<p>Using the ▲/▼/◀/▶ buttons adjusts the menu position. To quit the operation, press MENU button on the remote control or keep no operation for about 10 seconds.</p>								
BLANK	<p>Using the ▲/▼ buttons switches the mode for the BLANK screen. The BLANK screen is a screen for the temporarily blanking feature (📄21). It is displayed by pressing BLANK button.</p> <p>MyScreen ⇄ ORIGINAL ⇄ BLUE ⇄ WHITE ⇄ BLACK</p> <table border="1" style="margin-left: 40px;"> <thead> <tr> <th></th> <th>Feature</th> </tr> </thead> <tbody> <tr> <td>MyScreen</td> <td>Screen can be registered by the MyScreen item (📄38).</td> </tr> <tr> <td>ORIGINAL</td> <td>Screen preset as the standard screen.</td> </tr> <tr> <td>BLUE, WHITE, BLACK</td> <td>Plain screens in each color.</td> </tr> </tbody> </table> <p>• To avoid remaining as an afterimage, the MyScreen or ORIGINAL screen will change to the plain black screen after several minutes.</p>		Feature	MyScreen	Screen can be registered by the MyScreen item (📄38).	ORIGINAL	Screen preset as the standard screen.	BLUE, WHITE, BLACK	Plain screens in each color.
	Feature								
MyScreen	Screen can be registered by the MyScreen item (📄38).								
ORIGINAL	Screen preset as the standard screen.								
BLUE, WHITE, BLACK	Plain screens in each color.								

FixYourDLP.com
 (continued on next page)

Discount-Merchant.com (800) 281-8860
 THE TRUSTED SOURCE FOR PROJECTOR LAMPS AND ACCESSORIES

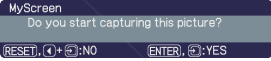
SCREEN menu (continued)

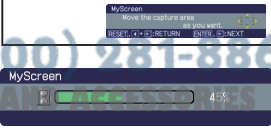
Item	Description								
<p>START UP</p>	<p>Using the ▲/▼ buttons switches the mode for the start-up screen. The start-up screen is a screen displayed when no signal or an unsuitable signal is detected.</p> <p>MyScreen ⇔ ORIGINAL ⇔ TURN OFF</p>  <table border="1" data-bbox="320 386 1016 528"> <thead> <tr> <th></th> <th>Feature</th> </tr> </thead> <tbody> <tr> <td>MyScreen</td> <td>Screen can be registered by the MyScreen item (see below).</td> </tr> <tr> <td>ORIGINAL</td> <td>Screen preset as the standard screen.</td> </tr> <tr> <td>TURN OFF</td> <td>Plain black screen.</td> </tr> </tbody> </table> <ul style="list-style-type: none"> • To avoid remaining as an afterimage, the MyScreen or ORIGINAL screen will change to the BLANK screen (see 37) after several minutes. If also the BLANK screen is the MyScreen or ORIGINAL, the plain black screen is instead used. • When the TURN ON is selected to the MyScreen PASSWORD of SECURITY item in OPTION menu (see 47), the START UP is fixed to MyScreen. 		Feature	MyScreen	Screen can be registered by the MyScreen item (see below).	ORIGINAL	Screen preset as the standard screen.	TURN OFF	Plain black screen.
	Feature								
MyScreen	Screen can be registered by the MyScreen item (see below).								
ORIGINAL	Screen preset as the standard screen.								
TURN OFF	Plain black screen.								
<p>MyScreen</p>	<p>This item allows you to capture an image for use as a MyScreen image which can be used as the BLANK screen and START UP screen. Display the image you want to capture before executing the following procedure.</p> <ol style="list-style-type: none"> 1. Selecting this item displays a dialog titled "MyScreen". It will ask you if you start capturing an image from the current screen.  <p>Please wait for the target image to be displayed, and press the ENTER button when the image is displayed. The image will freeze and the frame for capturing will appear. To stop performing, press the RESET or ESC button.</p> 2. Using the ▲/▼/◀/▶ buttons adjusts the frame position. Please move the frame to the position of the image which you want to use. The frame may not be able to be moved for some input signals. To start registration, press the ENTER button. To restore the screen and return to the previous dialog, press the RESET or ESC button. Registration takes several minutes. <p>(continued)</p>  								

(continued on next page)



FixYourDLP.com
Sponsored by DLP

Discount-Merchant.com (800) 281-8860
THE TRUSTED SOURCE FOR PROJECTOR LAMPS

SCREEN menu (continued)

Item	Description
MyScreen (continued)	<p>When the registration is completed, the registered screen and the following message are displayed for several seconds: “MyScreen registration is finished.”</p> <p>If the registration failed, the following message is displayed: “A capturing error has occurred. Please try again.”</p> <ul style="list-style-type: none"> • This function cannot be selected when the TURN ON is selected to the MyScreen Lock item (below). • This function cannot be selected when TURN ON is selected to the MyScreen PASSWORD of SECURITY item in OPTION menu (47).
MyScreen Lock	<p>Using the ▲/▼ buttons turns on/off the MyScreen lock function. TURN ON ⇔ TURN OFF</p> <p>When the TURN ON is selected, the MyScreen item is locked. Use this function for protecting the current MyScreen.</p> <ul style="list-style-type: none"> • This function cannot be selected when TURN ON is selected to the MyScreen PASSWORD of SECURITY item in OPTION menu (47).
MESSAGE	<p>Using the ▲/▼ buttons turns on/off the message function. TURN ON ⇔ TURN OFF</p> <p>When the TURN ON is selected, the following message function works. “AUTO IN PROGRESS” while automatically adjusting “NO INPUT IS DETECTED” “SYNC IS OUT OF RANGE” “Searching...” while searching for the input “Detecting...” while an input signal is detected The indication of the input signal displayed by changing The indication of the aspect ratio displayed by changing The indication of the PICTURE MODE displayed by changing The indication of the MY MEMORY displayed by changing The indication of “FREEZE” and “I” while the projector is in the FREEZE mode.</p> <ul style="list-style-type: none"> • If the projector goes into the FREEZE mode while the TURN OFF is selected, the picture on screen is frozen without any messages, which is not a malfunction (21).

(continued on next page)

SCREEN menu (continued)

Item	Description
<p>SOURCE NAME</p>	<p>Each input port for this projector can have a name applied to it.</p> <p>(1) Use the ▲/▼ buttons on the SCREEN menu to select SOURCE NAME and press the ► button. The SOURCE NAME menu will be displayed.</p> <p>(2) Use the ▲/▼ buttons on the SOURCE NAME menu to select the port to be named and press the ► button. Right side of the menu is blank until a name is specified. The SOURCE NAME dialog will be displayed.</p> <p>(3) The current name will be displayed on the first line. Use the ▲/▼/◀/▶ buttons and the ENTER or INPUT button to select and enter characters. The RESET button can be used to erase 1 character at a time. Also if you move the cursor to DELETE or ALL CLEAR on screen and push the ENTER or INPUT button, 1 character or all characters will be erased. The name can be a maximum of 16 characters.</p> <p>(4) To change an already inserted character, press the ▲ button to move the cursor to the first line, and use the ◀/▶ buttons to move the cursor on the character to be changed. After pressing the ENTER or INPUT button, the character is selected. Then, follow the same procedure as described at the item (3) above.</p> <p>(5) To finish entering text, move the cursor to the SAVE on screen and press the ENTER or INPUT button. To revert to the previous name without saving changes, move the cursor to the CANCEL on screen and press the ENTER or INPUT button.</p>
<p>TEMPLATE</p>	<p>Using ▲/▼ buttons switches the mode for the template screen. The selected template pattern can be displayed when the MY BUTTON allocated to the TEMPLATE function is pressed (43).</p> <p style="text-align: center;"> DOT-LINE4 ⇔ DOT-LINE3 ⇔ DOT-LINE2 ⇕ ⇕ TEST PATTERN ⇔ DOT-LINE1 </p>

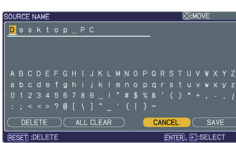

Discount-Merchant.com (800) 281-8860
 THE TRUSTED SOURCE FOR PROJECTOR LAMPS AND ACCESSORIES

OPTION menu

From the OPTION menu, items shown in the table below can be performed.

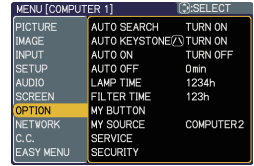

Select an item using the ▲/▼ cursor buttons, and press the ► cursor button or **ENTER** button to execute the item, except for the items LAMP TIME and FILTER TIME. Then perform it according to the following table.



Item	Description
AUTO SEARCH	<p>Using the ▲/▼ buttons turns on/off the automatic signal search function. TURN ON ⇔ TURN OFF</p> <p>When the TURN ON is selected, detecting no signal automatically cycles through input ports in the following order. The search is started from the current port. Then when an input is found, the projector will stop searching and display the image.</p> <p>COMPUTER IN1 ⇔ COMPUTER IN2 VIDEO ⇔ S-VIDEO ⇔ COMPONENT (Y, Cb/Pb, Cr/Pr)</p>
AUTO KEYSTONE [∇]	<p>Using the ▲/▼ buttons turns on/off the automatic keystone function. TURN ON ⇔ TURN OFF</p> <p>TURN ON : Automatic keystone distortion correction will be executed whenever changing the slant of the projector. TURN OFF : This function is disabled. Please execute the AUTO KEYSTONE [∇] EXECUTE in the SETUP Menu for automatic keystone distortion correction.</p> <ul style="list-style-type: none"> • When the projector is suspended from the ceiling this feature will not function properly so select the TURN OFF. • This function will be unavailable when the Transition Detector is on ([50]).
AUTO ON	<p>Using the ▲/▼ buttons turns on/off the AUTO ON function. TURN ON ⇔ TURN OFF</p> <p>When set to the TURN ON, the lamp in projector will be automatically turned on without the usual procedure ([15]), only when the projector is supplied with the power after the power was cut while the lamp was on.</p> <ul style="list-style-type: none"> • This function does not work as long as the power has been supplied to the projector while the lamp is off. • After turning the lamp on by the AUTO ON function, if neither input nor operation is detected for about 30 minutes, the projector is turned off, even though the AUTO OFF function ([42]) is disabled.

(continued on next page)

OPTION menu (continued)

Item	Description
<p>AUTO OFF</p>	<p>Using the ▲/▼ buttons adjusts the time to count down to automatically turn the projector off. Long (max. 99 minutes) ⇔ Short (min. 0 minute = DISABLE)</p> <div style="display: flex; justify-content: space-around; align-items: center;">   </div> <p>When the time is set to 0, the projector is not turned off automatically. When the time is set to 1 to 99, and when the passed time with no-signal or an unsuitable signal reaches at the set time, the projector lamp will be turned off.</p> <p>If one of the projector's buttons or the remote control buttons is pressed or one of the commands (except get commands) is transmitted to the CONTROL port during the corresponding time, projector will not be turned off.</p> <p>Please refer to the section "Turning off the power" (15).</p>
<p>LAMP TIME</p>	<p>The lamp time is the usage time of the lamp, counted after the last resetting. It is shown in the OPTION menu.</p> <p>Pressing RESET button or the ► button displays a dialog.</p> <p>To reset the lamp time, select RESET using the ▲ button.</p> <p>RESET ⇔ CANCEL</p> <ul style="list-style-type: none"> • Please reset the lamp time only when you have replaced the lamp, for a suitable indication about the lamp. • For the lamp replacement, see the section "Replacing the lamp" (60).
<p>FILTER TIME</p>	<p>The filter time is the usage time of the air filter, counted after the last resetting. It is shown in the OPTION menu.</p> <p>Pressing the RESET button or the ► button displays a dialog.</p> <p>To reset the filter time, select the RESET using the ▲ button.</p> <p>RESET ⇔ CANCEL</p> <ul style="list-style-type: none"> • Please reset the filter time only when you have cleaned or replaced the air filter, for a suitable indication about the air filter. • For the air filter cleaning, see the section "Cleaning and replacing the air filter" (62).





continued on next page)

OPTION menu (continued)

Item	Description
<p>MY BUTTON</p>	<p>This item is to assign one of the following functions to MY BUTTON 1 and 2 on the remote control (46). Choose 1 or 2 on the MY BUTTON menu using the ◀/▶ button first. Then using the ▲/▼ buttons sets one of the following functions to the chosen button.</p> <ul style="list-style-type: none"> • COMPUTER1: Sets port to COMPUTER IN1. • COMPUTER2: Sets port to COMPUTER IN2. • COMPONENT: Sets port to COMPONENT(Y, Cb/Pb, Cr/Pr) • S-VIDEO: Sets port to S-VIDEO. • VIDEO: Sets port to VIDEO. • INFORMATION: Displays the INPUT -INFORMATION- (45), NETWORK -INFORMATION- (58) or nothing. The displayed dialog is switched as below every time the MY BUTTON is pushed. When an input signal is found: ⇔ INPUT -INFORMATION- ⇨ NETWORK -INFORMATION- ⇨ OFF <p>When an input signal is not found: NETWORK -INFORMATION- ⇔ OFF</p> <ul style="list-style-type: none"> • AUTO KEYSTONE (7) : Performs automatic keystone distortion correction (34). • MY MEMORY: Loads one of adjustment data stored (28). When more than one data are saved, the adjustment changes every time the MY BUTTON is pushed. When no data is saved in memory, the dialog “No saved data” appears. When the current adjustment is not saved to memory, the dialog as shown in the right appears. <p>If you want to keep the current adjustment, please press the ◀ button to quit. Otherwise loading a data will lose the current adjusted condition.</p> <ul style="list-style-type: none"> • PICTURE MODE: Changes the PICTURE MODE (24). • FILTER RESET: Displays the filter time reset confirmation dialogue (42). • AV MUTE: Turns the picture and audio on/off. • TEMPLATE: Makes the template pattern selected to the TEMPLATE item (40) appear or disappear. • MY IMAGE: Displays the MY IMAGE menu (57).
<p>MY SOURCE</p>	<p>Using ▲/▼ buttons selects the picture input port to be selected with pressing the MY SOURCE/DOC.CAMERA button on the remote control. Select the picture input that is connected with a document camera.</p> <p>⇨ COMPUTER (IN)1 ⇨ COMPUTER (IN)2 ⇨ ⇨ VIDEO ⇨ S-VIDEO ⇨ COMPONENT(Y, Cb/Pb, Cr/Pr)</p>
<p>SERVICE</p>	<p>Selecting this item displays the SERVICE menu. Select an item using the ▲/▼ buttons, and press the ▶ button or the ENTER button to execute the item.</p> <p>FAN SPEED ⇔ AUTO ADJUST ⇔ GHOST ⇔ FILTER MESSAGE ⇔ KEY LOCK ⇨ FACTORY RESET ⇔ I NFORMATION ⇔ REMOTE FREQ. ⇨</p>



(continued on next page)

OPTION menu (continued)

Item	Description
<p>SERVICE (continued)</p>	<p>FAN SPEED</p> <p>Using the ▲/▼ buttons the rotation speed of the cooling fans. The HIGH is the mode for use at highlands etc. Note that the projector is noisier when the HIGH is selected.</p> <p>HIGH ⇔ NORMAL</p> 
	<p>AUTO ADJUST</p> <p>Using the ▲/▼ buttons to select one of the mode. When the DISABLE is selected, the automatic adjustment feature is disabled.</p> <p>FINE ⇔ FAST ⇔ DISABLE</p>  <p>FINE: Finer tuning including H.SIZE adjustment. FAST: Faster tuning, setting H.SIZE to prearranged data for the input signal.</p> <ul style="list-style-type: none"> Depending on conditions, such as input image, signal cable to the projector, environment around the projector, etc., the automatic adjustment may not work correctly. In such a case, please choose DISABLE to disable the automatic adjustment, and make adjustment manually.
	<p>GHOST</p> <ol style="list-style-type: none"> Select a color element of ghost using the ◀/▶ buttons. Adjust the selected element using the ▲/▼ buttons to disappear ghost. 
	<p>FILTER MESSAGE</p> <p>Use the ▲/▼ button to set the timer for the interval to show the message for cleaning up the air filter.</p> <p>500h ⇔ 1000h ⇔ 1500h ⇔ 2000h ⇔ TURN OFF</p> <p>After choosing an item except TURN OFF, the message "REMINDER *** HRS PASSED AFTER THE LAST FILTER CHECK" will appear after the timer reaches the interval time set by this feature (66).</p> <p>When the TURN OFF is chosen, the message will not appear. Utilize this feature to keep the air filter clean, setting the suitable time according to your environment of this projector.</p> <ul style="list-style-type: none"> Please check and clean the air filter periodically, even if there is no message. If the air filter becomes to be blocked by dust or others, the internal temperature will rise, which could cause malfunction, or reduce the lifetime of the projector. Please be careful with the operating environment of the projector and the condition of the air filter. 

(continued on next page)

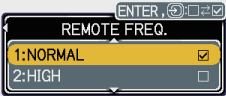
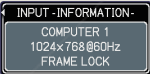
OPTION menu (continued)

Item	Description
<p>SERVICE (continued)</p>	<p>KEY LOCK Using the ▲/▼ buttons turns on/off the key lock feature. When TURN ON is selected, the buttons on the projector except the STANDBY/ON button are locked. TURN ON ⇔ TURN OFF</p> <ul style="list-style-type: none"> • Please use to avoid a mischief and touching accidentally. This function does not have any effect on the remote control.
	<p>REMOTE FREQ. Use the ▲/▼ button to change the projector's remote sensor setting. 1:NORMAL ⇔ 2:HIGH</p> <p>Items with a checkmark are on. The factory default setting is for both 1:NORMAL and 2: HIGH to be on. If the remote control does not function correctly, set this to either only 1 or only 2 (📖14). Neither can be turned off at the same time.</p> 
	<p>INFORMATION Selecting this item displays a dialog titled "INPUT -INFORMATION-". It shows the information about the current input.</p> <div style="display: flex; justify-content: space-around;">    </div> <ul style="list-style-type: none"> • The "FRAME LOCK" message on the dialog means the frame lock function is working (📖32). • The "SCART RGB" message means the COMPONENT port is working as a SCART RGB input port. Please refer to the COMPONENT item in INPUT menu (📖31). • This item can't be selected for no signal and sync out. • When the MY TEXT DISPLAY is set to TURN ON, the MY TEXT is displayed together with the input information in the INPUT -INFORMATION- box (📖52).
	<p>FACTORY RESET Selecting RESET using the button ▲ performs this function. By this function, all the items in all of menus will collectively return to the initial setting. Note that the items LAMP TIME, FILTER TIME, LANGUAGE, SECURITY and NETWORK settings are not reset. RESET ← CANCEL</p>

OPTION menu (continued)

Item	Description
<p style="text-align: center;">SECURITY</p>	<p>This projector is equipped with security functions. User registration is required before using the security functions. Please ask your local dealer.</p>
	<p>1. Using Security Features</p>
	<p>1.1 Inputting the PASSWORD</p>
	<p>1.1-1 Use the ▲/▼ buttons on the OPTION menu to select SECURITY and press the ► button. The ENTER PASSWORD box will be displayed.</p> <div data-bbox="800 422 1030 507" style="border: 1px solid black; padding: 5px; margin: 10px 0;"> <p style="text-align: center;">SECURITY ENTER PASSWORD</p> <p style="text-align: center;">● 0 0 0 0 ●</p> <p style="text-align: center;">◀ QUIT NEXT ▶</p> </div> <p>The factory default PASSWORD is 6971. This PASSWORD can be changed (1.2 Changing the PASSWORD (below)).</p> <ul style="list-style-type: none"> It is strongly recommended the factory default PASSWORD to be changed as soon as possible. <p>1.1-2 Use the ▲/▼/◀/▶ buttons to enter the registered PASSWORD. Move the cursor to the right side of the ENTER PASSWORD box and press the ► button to display the SECURITY menu.</p> <div data-bbox="772 635 1028 782" style="border: 1px solid black; padding: 5px; margin: 10px 0;"> <p style="text-align: center;">SECURITY</p> <p>SECURITY PASSWORD CHANGE</p> <p>MyScreen PASSWORD TURN OFF</p> <p>PIN LOCK TURN OFF ▶</p> <p>TRANSITION DETECTOR TURN OFF</p> <p>MY TEXT PASSWORD TURN OFF</p> <p>MY TEXT DISPLAY TURN OFF</p> <p>MY TEXT WRITING</p> </div> <p>If an incorrect PASSWORD is input, the ENTER PASSWORD box will be displayed again. If incorrect PASSWORD is input 3 times, the projector will turn off. Afterwards the projector will turn off every time an incorrect PASSWORD is input.</p>
<p>1.2 Changing the PASSWORD</p>	
<p>1.2-1 Use the ▲/▼ buttons on the SECURITY menu to select SECURITY PASSWORD CHANGE and press the ► button to display the ENTER NEW PASSWORD box.</p> <div data-bbox="800 928 1030 1013" style="border: 1px solid black; padding: 5px; margin: 10px 0;"> <p style="text-align: center;">SECURITY ENTER NEW PASSWORD</p> <p style="text-align: center;">● 0 0 0 0 ●</p> <p style="text-align: center;">◀ QUIT NEXT ▶</p> </div>	
<p>1.2-2 Use the ▲/▼/◀/▶ buttons to enter the new PASSWORD.</p>	
<p>1.2-3 Move the cursor to the right side of the ENTER NEW PASSWORD box and press the ► button to display the NEW PASSWORD AGAIN box, enter the same PASSWORD again.</p> <div data-bbox="800 1088 1030 1173" style="border: 1px solid black; padding: 5px; margin: 10px 0;"> <p style="text-align: center;">SECURITY NEW PASSWORD AGAIN</p> <p style="text-align: center;">● 0 0 0 0 ●</p> <p style="text-align: center;">◀ CANCEL OK ▶</p> </div>	
<p>1.2-4 Move the cursor to the right side of the NEW PASSWORD AGAIN box and press the ► button and the NOTE NEW PASSWORD box will be displayed for about 20 seconds, please make note of the PASSWORD during this time.</p> <div data-bbox="800 1225 1030 1310" style="border: 1px solid black; padding: 5px; margin: 10px 0;"> <p style="text-align: center;">SECURITY NOTE NEW PASSWORD</p> <p style="text-align: center;">● 0 0 0 0 ●</p> <p style="text-align: center;">[ENTER], [C];EXIT</p> </div> <p>Pressing the ENTER button will close the NOTE NEW PASSWORD box.</p> <ul style="list-style-type: none"> Please do not forget your PASSWORD. 	



Discount-Me... THE TRUSTED SOURCE FOR PROJECTOR LAMPS AND ACCESSORIES

(continued on next page)

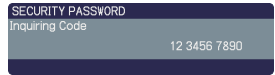

OPTION menu (continued)

Item	Description
<p>SECURITY (continued)</p>	<p>1.3 If you have forgotten your PASSWORD</p> <p>1.3-1 Follow the procedure in 1.1-1 to display the ENTER PASSWORD box.</p> <p>1.3-2 While the ENTER PASSWORD box is displayed, press and hold the RESET button for about 3 seconds, or press and hold the INPUT button for 3 seconds while pressing the ► button on the projector. The 10-digit Inquiring Code will be displayed.</p> <ul style="list-style-type: none"> • If there is no key input for about 55 seconds while the Inquiring Code is displayed, the menu will close. If necessary, repeat the process from 1.3-1. <p>1.3-3 Contact your dealer with the 10-digit Inquiring Code. Your PASSWORD will be sent after your user registration information is confirmed.</p>
	<p>2. Using the MyScreen PASSWORD Function</p> <p>The MyScreen PASSWORD function can be used to prohibit access to the MyScreen function and prevent the currently registered MyScreen image from being overwritten.</p> <p>2.1 Turning on the MyScreen PASSWORD Function</p> <p>2.1-1 Use the ▲/▼ buttons on the SECURITY menu to select MyScreen PASSWORD and press the ► button to display the MyScreen PASSWORD on/off menu.</p> <p>2.2 Setting the PASSWORD</p> <p>2.2-1 Display the MyScreen PASSWORD on/off menu using the procedure in 2.1-1.</p> <p>2.2-2 Use the ▲/▼ buttons on the MyScreen PASSWORD on/off menu to select TURN ON. The ENTER PASSWORD box (small) will be displayed.</p> <p>2.2-3 Use the ▲/▼/◀/▶ buttons to enter the PASSWORD. Move the cursor to the right side of the ENTER PASSWORD box (small) and press the ► button to display the PASSWORD AGAIN box, enter the same PASSWORD again.</p>



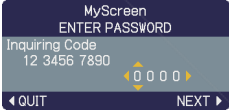

(continued on next page)

OPTION menu (continued)

Item	Description
<p>SECURITY (continued)</p>	<p>2.2-4 Move the cursor to the right side of the PASSWORD AGAIN box and press the ► button to display the PASSWORD for about 20 seconds, please make note of the PASSWORD during this time.</p>  <p>Pressing the ENTER button will return to MyScreen PASSWORD on/off menu.</p> <p>When a PASSWORD is set for MyScreen:</p> <ul style="list-style-type: none"> • The MyScreen registration function (and menu) will be unavailable. • The MyScreen Lock menu will be unavailable. • The START UP setting will be locked on MyScreen (and the menu will be unavailable). <p>Turning the MyScreen PASSWORD off will allow normal operation of these functions.</p> <ul style="list-style-type: none"> • Please do not forget your MyScreen PASSWORD. <p>2.3 Turning the PASSWORD off</p> <p>2.3-1 Follow the procedure in 2.1-1 to display the MyScreen PASSWORD on/off menu.</p> <p>2.3-2 Select TURN OFF to display the ENTER PASSWORD box (large). Enter the registered PASSWORD and the screen will return to the MyScreen on/off menu.</p> <p>If an incorrect PASSWORD is input, the menu will close. If necessary, repeat the process from 2.3-1.</p> <p>2.4 If you have forgotten your PASSWORD</p> <p>2.4-1 Follow the procedure in 2.1-1 to display the MyScreen PASSWORD on/off menu.</p> <p>2.4-2 Select TURN OFF to display the ENTER PASSWORD box (large). The 10-digit Inquiring Code will be displayed inside the box.</p>  <p>2.4-3 Contact your dealer with the 10-digit Inquiring Code. Your PASSWORD will be sent after your user registration information is confirmed.</p>
	<p>3. Using the PIN LOCK Function</p> <p>PIN LOCK is a function which prevents the projector from being used unless a registered Code is input.</p> <p>3.1 Registering the PIN Code</p> <p>3.1-1 Use the ▲/▼ buttons on the SECURITY menu to select PIN LOCK and press the ► button or the ENTER button to display the PIN LOCK on/off menu.</p> 

(continued on next page)

OPTION menu (continued)

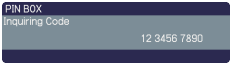
Item	Description
<p>SECURITY (continued)</p>	<p>3.1-2 Use the ▲/▼ buttons on the PIN LOCK on/off menu to select TURN ON and the PIN BOX will be displayed.</p>  <p>3.1-3 Input a 4 part PIN Code using the ▲, ▼, ◀, ▶, COMPUTER and INPUT buttons. A PIN Code again box will appear. Reenter the same PIN Code. This will complete the PIN Code registration.</p>  <ul style="list-style-type: none"> • If there is no key input for about 55 seconds while the PIN BOX or the PIN Code again box are displayed, the menu will close. If necessary, repeat the process from 3.1-1. <p>Afterwards, anytime the projector is restarted after AC power is turned off the PIN BOX will be displayed. Enter the registered PIN Code. The projector can be used after entering the registered PIN Code. If an incorrect PIN Code is input, the PIN BOX will be displayed again. If an incorrect PIN Code is input 3 times, the projector will turn off. Afterwards the projector will turn off every time an incorrect PIN Code is input. The projector will also turn off if there is no key input for about 5 minutes while the PIN BOX is displayed. This function will activate only when the projector is started after AC power is turned off.</p> <ul style="list-style-type: none"> • Please do not forget your PIN Code.
	<p>3.2 Turning Off the PIN LOCK Function</p> <p>3.2-1 Follow the procedure in 3.1-1 to display the PIN LOCK on/off menu. Use the ▲/▼ buttons to select TURN OFF and the PIN BOX will be displayed. Enter the registered PIN Code to turn the PIN LOCK function off. If an incorrect PASSWORD is input 3 times, the menu will close.</p>
	<p>3.3 If you have forgotten your PIN Code</p> <p>3.3-1 While the PIN BOX is displayed, press and hold the RESET button on the remote control for 3 seconds, or press and hold the INPUT button for 3 seconds while pressing the ▶ button on the projector. The 10-digit Inquiring Code will be displayed.</p>  <ul style="list-style-type: none"> • If 5 minutes pass after the PIN BOX is displayed, the projector will turn off. <p>3.3-2 Contact your dealer with the 10-digit Inquiring Code. Your PASSWORD will be sent after your user registration information is confirmed.</p>





FixYourDLP.com
Sponsored by DM

Discount-Merchant.com (800) 281-8860
THE TRUSTED SOURCE FOR PROJECTOR PARTS AND ACCESSORIES

(continued on next page)

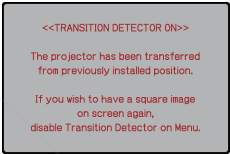
OPTION menu (continued)

Item	Description
<p>SECURITY (continued)</p>	<p>4. Using the Transition Detector Function</p> <p>While the Transition Detector function is ON, when power switch is started to supply to the projector, it might react as below.</p> <ul style="list-style-type: none"> • Transition Detector alarm shown below might appear on screen, if the projector has been moved or re-installed. • Transition Detector alarm might appear on screen, if the MIRROR setting has been changed. • Keystone adjustment feature has been prohibited as long as the Transition Detector function is ON. <p>4.1 Turning On the Transition Detector Function</p> <p>4.1-1 Use the ▲/▼ buttons on the SECURITY menu to select TRANSITION DETECTOR and press the ► or the ENTER button to display the TRANSITION DETECTOR on/off menu. Select TURN ON and the current angle and mirror setting will be recorded.</p> <ul style="list-style-type: none"> • This feature may not function properly if the projector is not in a stable position when TURN ON is selected. <p>4.1-2 If this function is set to TURN ON when the vertical angle of the projector or mirror setting at which the projector is turned on is different than the previously recorded, the Transition Detector alarm will be displayed and the projector will not display the input signal.</p> <p>Set the Transition Detector off in the SECURITY menu to display the input signal.</p> <p>If the Transition Detector alarm is displayed for about 5 minutes, the lamp will turn off. This function will activate only when the projector is started after turning off the AC power.</p> <p>4.2 Setting the Transition Detector PASSWORD</p> <p>4.2-1 Use the ▲/▼ buttons on the SECURITY menu to select TRANSITION DETECTOR and press the ► or the ENTER button to display the TRANSITION DETECTOR on/off menu.</p> <p>4.2-2 Use the ▲/▼ buttons on the TRANSITION DETECTOR on/off menu to select TURN ON. The ENTER PASSWORD box (small) will be displayed.</p> <p>4.2-3 Use the ▲/▼/◀/▶ buttons to enter a PASSWORD. Move the cursor to the right side of the ENTER PASSWORD box (small) and press the ► button to display the PASSWORD AGAIN box, enter the same PASSWORD again.</p>
	   

(continued on next page)

OPTION menu (continued)

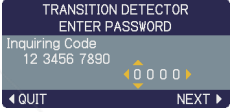
Item	Description
<p>SECURITY (continued)</p>	<p>4.2-4 Move the cursor to the right side of the PASSWORD AGAIN box and press the ► button to display the PASSWORD for about 20 seconds, please make note of the PASSWORD during this time.</p>  <p>Pressing the ENTER button will return to the TRANSITION DETECTOR on/off menu.</p> <ul style="list-style-type: none"> • Please do not forget your Transition Detector PASSWORD.
	<p>4.3 Setting the Transition Detector off</p>
	<p>4.3-1 Follow the procedure in 4.1-1 to display the TRANSITION DETECTOR on/off menu.</p>
	<p>4.3-2 Select TURN OFF to display the ENTER PASSWORD box (large). Enter the registered PASSWORD and the screen will return to the TRANSITION DETECTOR on/off menu. If an incorrect PASSWORD is input, the menu will close. If necessary, repeat the process from 4.3-1.</p>
	<p>4.4 If you have forgotten your PASSWORD</p>
<p>4.4-1 Follow the procedure in 4.1-1 to display the TRANSITION DETECTOR on/off menu.</p>	
<p>4.4-2 Select TURN OFF to display the ENTER PASSWORD box (large). The 10-digit Inquiring Code will be displayed inside the box.</p> 	
<p>4.4-3 Contact your dealer with the 10-digit Inquiring Code. Your PASSWORD will be sent after your user registration information is confirmed.</p>	

(continued on next page)



Discount-Merchant.com (800) 281-8860
THE TRUSTED SOURCE FOR PROJECTOR LAMPS AND ACCESSORIES

OPTION menu (continued)

Item	Description
<p>SECURITY (continued)</p>	<p>5. Using the MY TEXT PASSWORD function This item allows you to display your own message (MY TEXT) on the START UP screen and INPUT-INFORMATION. It can be protected by a password to prevent it from being overwritten.</p> <p>5.1 Writing the MY TEXT</p> <p>(1) Use the ▲/▼ buttons on the SECURITY menu to select the MY TEXT WRITING menu and press the ► button. The MY TEXT WRITING dialog will be displayed.</p> <p>(2) The current MY TEXT will be displayed on the first 3 lines. If not yet written, the lines will be blank. Use the ▲/▼/◀/▶ buttons and the ENTER or INPUT button to select and enter characters. The RESET button can be used to erase 1 character at a time. Also if you move the cursor to DELETE or ALL CLEAR on screen and push the ENTER or INPUT button, 1 character or all characters will be erased. The MY TEXT can be input up to 24 characters on each line.</p> <p>(3) To change an already inserted character, press the ▲/▼ button to move the cursor to one of the first 3 lines, and use the ◀/▶ buttons to move the cursor on the character to be changed. After pressing the ENTER or INPUT button, the character is selected. Then, follow the same procedure as described at the item (2) above.</p> <p>(4) To finish entering text, move the cursor to the SAVE on screen and press the ENTER or INPUT button. To revert to the previous MY TEXT without saving changes, move the cursor to the CANCEL on screen and press the ENTER or INPUT button.</p> <ul style="list-style-type: none"> • The MY TEXT WRITING function is available only when the MY TEXT PASSWORD function is set to TURN OFF.
	<p>5.2 Displaying the MY TEXT</p> <p>(1) Use the ▲/▼ buttons on the SECURITY menu to select the MY TEXT DISPLAY menu and press the ► button to display the MY TEXT DISPLAY on/off menu.</p> <p>(2) Use the ▲/▼ buttons on the MY TEXT DISPLAY on/off menu to select on or off.</p> <p>TURN ON ⇔ TURN OFF When it is set TURN ON, the MY TEXT will be displayed on the START UP screen and the INPUT-INFORMATION- dialog (45).</p> <ul style="list-style-type: none"> • This function is available only when the MY TEXT PASSWORD function is set to the TURN OFF.

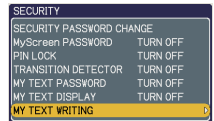

MY TEXT DISPLAY on/off menu

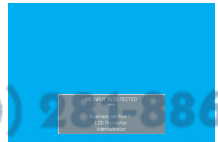

(continued on next page)

OPTION menu (continued)

Item	Description
<p>SECURITY (continued)</p>	<p>5.3 Turning on the MY TEXT PASSWORD The MY TEXT PASSWORD function can prevent the MY TEXT from being overwritten.</p> <p>5.3-1 Turning on the MY TEXT PASSWORD function</p> <p>(1) Use the ▲/▼ buttons on the SECURITY menu to select the MY TEXT PASSWORD menu and press the ► button to display the MY TEXT PASSWORD on/off menu.</p>
	<p>5.3-2 Setting the MY TEXT PASSWORD</p> <p>(1) Display the MY TEXT PASSWORD on/off menu using the procedure in 5.3-1</p> <p>(2) Use the ▲/▼ buttons on the MY TEXT PASSWORD menu to select TURN ON. The ENTER PASSWORD BOX (small) will be displayed.</p>
	<p>(3) Use the ▲/▼/◀/▶ buttons to enter the PASSWORD. Move the cursor to the right side of the ENTER PASSWORD BOX (small) and press the ► button to display the PASSWORD AGAIN BOX, and then enter the same PASSWORD again.</p>
	<p>(4) Move the cursor to the right side of the PASSWORD AGAIN BOX and press ► button to display the PASSWORD for about 20 seconds, then please make note of the PASSWORD during this time.</p> <p>Pressing the ENTER button on the remote control or INPUT button on the projector will return to the MY TEXT PASSWORD on/off menu. When the PASSWORD is set for the MY TEXT;</p> <ul style="list-style-type: none"> • The MY TEXT DISPLAY menu will be unavailable, which can prohibit changing the DISPLAY setting. • The MY TEXT WRITING menu will be unavailable, which can prevent the MY TEXT from being overwritten.
	<p>5.3-3 Turning the MY TEXT PASSWORD off</p> <p>(1) Follow the procedure in 5.3-1 to display the MY TEXT PASSWORD on/off menu.</p> <p>(2) Select TURN OFF to display the ENTER PASSWORD BOX (large). Enter the registered PASSWORD and the screen will return to the MY TEXT PASSWORD on/off menu.</p>
<p>5.3.4 If you have forgotten your PASSWORD</p> <p>(1) Follow the procedure in 5.3-1 to display the MY TEXT PASSWORD on/off menu.</p> <p>(2) Select TURN OFF to display the ENTER PASSWORD BOX (large). The 10 digit inquiring code will be displayed inside the box.</p> <p>(3) Contact your dealer with the 10 digit inquiring code. Your PASSWORD will be sent after your user registration information is confirmed.</p>	



MY TEXT PASSWORD



ENTER PASSWORD BOX (small)



PASSWORD AGAIN BOX



NOTE PASSWORD BOX

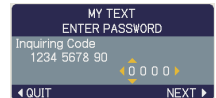

ENTER PASSWORD BOX (large)



Discount-www.FixYourDLP.com (800) 281-8800
THE TRUSTED SOURCE FOR PROJECTOR PARTS AND ACCESSORIES

NETWORK Menu

Remember that incorrect network settings on this projector may cause trouble on the network. Be sure to consult with your network administrator before connecting to an existing access point on your network.

From the NETWORK menu, items shown in the table below can be performed.

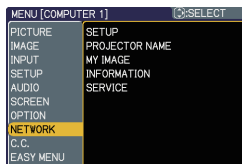

Select an item using the ▲/▼ cursor buttons, and press the ► cursor button or **ENTER** button to execute the item. Then perform it according to the following table.

See the User's Manual - Network Guide for details of NETWORK operation.

NOTE • If you are not utilizing SNTP ([📖 Date/Time Settings of the User's Manual - Network Guide](#)), then you must set the DATE AND TIME ([📖55](#)) during the initial installation.

• The network communication control is disabled while the projector is in standby mode if the STANDBY MODE item of SETUP menu is set to SAVING. Please connect the network communication to the projector after setting the STANDBY MODE to NORMAL ([📖35](#)).

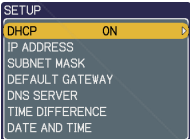
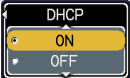
Item	Description	
<p>SETUP</p>	<p>Selecting this item displays the SETUP Menu for the network. Use the ▲/▼ buttons to select an item, and the ► or ENTER button on the remote control to perform the item.</p> 	
	<p>DHCP (Dynamic Host Configuration Protocol)</p>	<p>Use the ▲/▼ buttons to turn DHCP on/off. ON ⇔ OFF</p> <p>Select OFF when the network does not have DHCP enabled.</p> <ul style="list-style-type: none"> • When the “DHCP” setting changes to “ON”, it takes a little time to obtain IP address from DHCP server. • Auto IP function will be assigned an IP address if the projector could not obtain an IP address from server even if DHCP is “ON”. 







Discount-Merch.com (800) 281-8860

THE TRUSTED SOURCE FOR PROJECTOR LAMPS AND ACCESSORIES

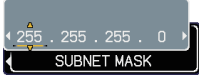
(continued on next page)

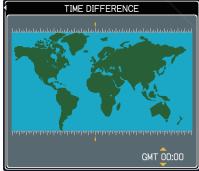
NETWORK Menu (continued)

Item	Description	
<p>SETUP (continued)</p>	<p>IP ADDRESS</p>	<p>Use the ▲/▼/◀/▶ buttons to enter the IP ADDRESS. This function can only be used when DHCP is set to OFF.</p>  <ul style="list-style-type: none"> • The IP ADDRESS is the number that identifies this projector on the network. You cannot have two devices with the same IP ADDRESS on the same network. • The IP ADDRESS "0.0.0.0" is prohibited.
	<p>SUBNET MASK</p>	<p>Use the ▲/▼/◀/▶ buttons to enter the same SUBNET MASK used by your PC. This function can only be used when DHCP is set to OFF.</p>  <ul style="list-style-type: none"> • The SUBNET MASK "0.0.0.0" is prohibited.
	<p>DEFAULT GATEWAY</p>	<p>Use the ▲/▼/◀/▶ buttons to enter the DEFAULT GATEWAY (a node on a computer network that serves as an access point to another network) address. This function can only be used when DHCP is set to OFF.</p> 
	<p>DNS SERVER</p>	<p>Use the ▲/▼/◀/▶ buttons to input the DNS SERVER address. The DNS SERVER is a system to control domain names and IP addresses on the Network.</p> 
	<p>TIME DIFFERENCE</p>	<p>Use the ▲/▼ buttons to enter the TIME DIFFERENCE. Set the same TIME DIFFERENCE as the one set on your PC. If unsure, consult your IT manager. Use the ◀ button to return to the menu after setting the TIME DIFFERENCE.</p> 
	<p>DATE AND TIME</p>	<p>Use the ▲/▼/◀/▶ buttons to enter the Year (last two digits), Month, Date, Hour and Minute.</p>  <p>The projector will override this setting and retrieve DATE AND TIME information from the Time server when SNTP is enabled. (📖 Date/Time Settings of the User's Manual - Network Guide)</p>

(continued on next page)

NETWORK Menu (continued)

Item	Description
<p>PROJECTOR NAME</p>	<p>(1) Use the ▲/▼ buttons on the NETWORK Menu to select the PROJECTOR NAME menu and press the ► button. The PROJECTOR NAME dialog will be displayed.</p>
	<p>(2) The current PROJECTOR NAME will be displayed on the first 3 lines. If not yet written, the lines will be blank. Use the ▲/▼/◀/► buttons and the ENTER or INPUT button to select and enter characters. The RESET button can be used to erase 1 character at a time. Also if you move the cursor to DELETE or ALL CLEAR on screen and push the ENTER or INPUT button, 1 character or all characters will be erased. The PROJECTOR NAME can be input up to 64 characters.</p>
	<p>(3) To change an already inserted character, press the ▲/▼ button to move the cursor to one of the first 3 lines, and use the ◀/► buttons to move the cursor on the character to be changed. After pressing the ENTER or INPUT button, the character is selected. Then, follow the same procedure as described at the item (2) above.</p>
	<p>(4) To finish entering text, move the cursor to the SAVE on screen and press the ENTER or INPUT button. To revert to the previous PROJECTOR NAME without saving changes, move the cursor to the CANCEL on screen and press the ENTER or INPUT button.</p>

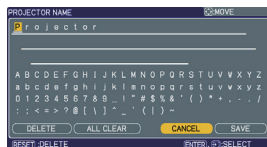

(Continued on next page) **Discount Merchant.com (800) 281-8860**
THE TRUSTED SOURCE FOR PROJECTOR LAMPS AND ACCESSORIES

NETWORK Menu (continued)

Item	Description
<p>MY IMAGE</p>	<p>Selecting this item displays the MY IMAGE menu.</p> <p>The application software “PImage” is required to store image(s) into the projector.</p> <p>Use the ▲/▼ buttons to select an item which is a still image by the MY IMAGE (📄 MY IMAGE (Still Image Transfer) Display of the User’s Manual - Network Guide) and the ► or ENTER button to display the image.</p> <ul style="list-style-type: none"> • The item without image stored cannot be selected. • The image names are each displayed in 16 characters or less. <p>To switch the image displayed Use the ▲/▼ buttons.</p> <p>To return to the menu Press the ◀ or ESC button on the remote control.</p> <p>To erase the image displayed and its source file in the projector.</p> <p>(1) Press the RESET button on the remote control while displaying an image to display the MY IMAGE - RESET menu.</p> <p>(2) Press the ENTER button on the remote control or the INPUT button on the projector to perform to erase. To stop erasing, press the ESC button on the remote control or the ◀ button on the projector.</p>



(continued on next page)



Discount-Merchant.com (800) 281-8860
THE TRUSTED SOURCE FOR PROJECTOR LAMPS AND ACCESSORIES

NETWORK Menu (continued)





Item	Description																
<p>INFORMATION</p>	<p>Selecting this item displays the NETWORK -INFORMATION- dialog for confirming the network settings.</p> <div data-bbox="434 311 927 561" style="border: 1px solid black; padding: 5px; margin: 10px 0;"> <p style="text-align: center; border-bottom: 1px solid black;">NETWORK -INFORMATION-</p> <table style="width: 100%; border-collapse: collapse;"> <tr><td style="padding: 2px;">PROJECTOR NAME</td><td style="padding: 2px;"></td></tr> <tr><td style="padding: 2px;">IP ADDRESS</td><td style="padding: 2px;">192.168.1.254</td></tr> <tr><td style="padding: 2px;">SUBNET MASK</td><td style="padding: 2px;">255.255.255.0</td></tr> <tr><td style="padding: 2px;">DEFAULT GATEWAY</td><td style="padding: 2px;">0.0.0.0</td></tr> <tr><td style="padding: 2px;">DNS SERVER</td><td style="padding: 2px;">0.0.0.0</td></tr> <tr><td style="padding: 2px;">MAC ADDRESS</td><td style="padding: 2px;">00-00-87-56-AC-7C</td></tr> <tr><td style="padding: 2px;">TIME DIFFERENCE</td><td style="padding: 2px;">GMT 00:00</td></tr> <tr><td style="padding: 2px;">DATE AND TIME</td><td style="padding: 2px;">2000/1/1 8:15</td></tr> </table> </div> <ul style="list-style-type: none"> • The PROJECTOR NAME is displayed in the “PROJECTOR NAME” field. Nothing (blank) is shown in the “PROJECTOR NAME” field until you setup the item (56). • When the voltage level of the battery for the built in clock decreases, the set time may become incorrect even though accurate date and time are input. Replace the battery suitably (64). • IP ADDRESS, SUBNET MASK and DEFAULT GATEWAY indicate “0.0.0.0” when DHCP is ON and the projector has not gotten address from DHCP server. 	PROJECTOR NAME		IP ADDRESS	192.168.1.254	SUBNET MASK	255.255.255.0	DEFAULT GATEWAY	0.0.0.0	DNS SERVER	0.0.0.0	MAC ADDRESS	00-00-87-56-AC-7C	TIME DIFFERENCE	GMT 00:00	DATE AND TIME	2000/1/1 8:15
PROJECTOR NAME																	
IP ADDRESS	192.168.1.254																
SUBNET MASK	255.255.255.0																
DEFAULT GATEWAY	0.0.0.0																
DNS SERVER	0.0.0.0																
MAC ADDRESS	00-00-87-56-AC-7C																
TIME DIFFERENCE	GMT 00:00																
DATE AND TIME	2000/1/1 8:15																
<p>SERVICE</p>	<p>Executing this item restarts and initializes the network functions. Choose the RESTART using the button ►.</p> <div data-bbox="430 911 665 983" style="border: 1px solid black; padding: 5px; margin: 10px 0;"> <p style="text-align: center; border-bottom: 1px solid black;">SERVICE</p> <p style="text-align: center; border: 1px solid black; background-color: #f0f0f0;">RESTART ►</p> </div> <p>Then use the button ▲ to execute.</p> <div data-bbox="430 1046 611 1139" style="border: 1px solid black; padding: 5px; margin: 10px 0;"> <p style="text-align: center; border-bottom: 1px solid black;">RESTART</p> <p style="text-align: center; border: 1px solid black; background-color: #f0f0f0;">EXECUTE ▲</p> <p style="text-align: center; border: 1px solid black; background-color: #f0f0f0;">CANCEL ▼</p> </div> <p>Network will be once cut off when choose restart. If DHCP is selected ON, IP address may be changed. After selecting RESTART, NETWORK Menu may not be controlled approx. 30 seconds.</p>																

C.C. (Closed Caption) menu

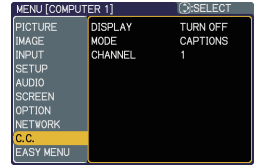
The closed caption setting can be changed through C.C. menu in the advance menu. Please select the item that you will change using ▲/▼ cursor buttons.

• The C.C. (Closed Caption) is the function that displays a transcript or dialog of the audio portion of a video, files or other presentation or other relevant sounds. It is required to have NTSC format video or 480i@60 format component video source supporting C.C. feature to utilize this function.



Item	Description
<p>DISPLAY</p>	<p>Select Closed Caption DISPLAY setting from following options using ▲/▼ buttons.</p> <p>TURN OFF ⇄ TURN ON ⇄ AUTO</p>  <p>TURN OFF: Closed Caption is OFF TURN ON: Closed Caption is ON AUTO: Closed Caption automatically displays when the volume is muted.</p> <ul style="list-style-type: none"> • The caption is not displayed when the OSD menu is active. • The Closed Caption is the function to display the dialogue, narration, and / or sound effects of a television program or other video sources. The Closed Caption availability is depending upon broadcaster and/or content. • It may not work properly, depending on equipment or signal source. In this case, please turn off the Closed Caption. 
<p>MODE</p>	<p>Select Closed Caption MODE setting from following options using ▲/▼ buttons.</p> <p>CAPTIONS ⇄ TEXT</p> <p>CAPTIONS: Display Closed Caption TEXT: Display Text data, which is for additional information such as news reports or a TV program guide. The information covers the entire screen. Not all of the C.C. program has Text information.</p> 
<p>CHANNEL</p>	<p>Select Closed Caption CHANNEL from following options using ▲/▼ buttons.</p> <p>1 ⇄ 2 ⇄ 3 ⇄ 4</p>  <p>1: Channel 1, primary channel / language 2: Channel 2 3: Channel 3 4: Channel 4</p> <p>The channel data may vary, depending on the content. Some channel might be used for secondary language or empty.</p> 



FixYourDLP.com
Sponsored by DM

Discount-Merchant.com (800) 999-9950
THE TRUSTED SOURCE FOR PROJECTOR LAMPS AND ACCESSORIES

Maintenance

Replacing the lamp

A lamp has finite product life. Using the lamp for long periods of time could cause the pictures darker or the color tone poor. Note that each lamp has a different lifetime, and some may burst or burn out soon after you start using them. Preparation of a new lamp and early replacement are recommended. To prepare a new lamp, make contact with your dealer and tell the lamp type number.

Type number : DT00841

Replacing the lamp

1. Turn the projector off, and unplug the power cord. Allow the projector to cool for at least 45 minutes.
2. Prepare a new lamp. If the projector is mounted on a ceiling, or if the lamp has broken, also ask the dealer to replace the lamp.

In case of replacement by yourself, follow the following procedure.

3. Loosen the screw (marked by arrow) of the lamp cover and then slide the lamp cover to the side to remove it.
4. Loosen the 2 screws (marked by arrow) of the lamp, and slowly pick up the lamp by the handles.
5. Insert the new lamp, and retighten firmly the 2 screws of the lamp that are loosened in the previous process to lock it in place.
6. Slide the lamp cover back in place and firmly fasten the screw of the lamp cover.
7. Turn the projector on and reset the lamp time using the LAMP TIME item in the OPTION menu.
 - (1) Press the **MENU** button to display a menu.
 - (2) Point at the Go to Advanced Menu ... in the menu using the **▼/▲** button, then press the **▶** button.
 - (3) Point at the OPTION in the left column of the menu using the **▼/▲** button, then press the **▶** button.
 - (4) Point at the LAMP TIME using the **▼/▲** button, then press the **▶** button. A dialog will appear.
 - (5) Press the **▲** button to select RESET on the dialog. It performs resetting the lamp time.

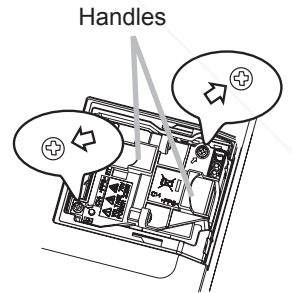
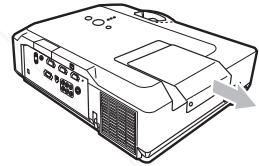
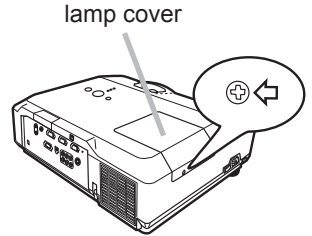

⚠ CAUTION ▶ Do not touch any inner space of the projector, while the lamp is taken out.

NOTE • Please reset the lamp time only when you have replaced the lamp, for a suitable indication about the lamp.

Replacing the lamp (continued)

Lamp warning

 **HIGH VOLTAGE**  **HIGH TEMPERATURE**  **HIGH PRESSURE**

WARNING ▶ The projector uses a high-pressure mercury glass lamp. The lamp can break with a loud bang, or burn out, if jolted or scratched, handled while hot, or worn over time. Note that each lamp has a different lifetime, and some may burst or burn out soon after you start using them. In addition, when the bulb bursts, it is possible for shards of glass to fly into the lamp housing, and for gas containing mercury to escape from the projector's vent holes.

▶ **About disposal of a lamp:** This product contains a mercury lamp; do not put it in a trash. Dispose of it in accordance with environmental laws.

- For lamp recycling, go to www.lamprecycle.org (in the US).
- For product disposal, consult your local government agency or www.eiae.org (in the US) or www.epsc.ca (in Canada).

For more information, call your dealer.



Disconnect
the plug
from the
power
outlet

- If the lamp should break (it will make a loud bang when it does), unplug the power cord from the outlet, and make sure to request a replacement lamp from your local dealer. Note that shards of glass could damage the projector's internals, or cause injury during handling, so please do not try to clean the projector or replace the lamp yourself.
- If the lamp should break (it will make a loud bang when it does), ventilate the room well, and make sure not to breathe the gas that comes out of the projector vents, or get it in your eyes or mouth.
- Before replacing the lamp, turn the projector off and unplug the power cord, then wait at least 45 minutes for the lamp to cool sufficiently. Handling the lamp while hot can cause burns, as well as damaging the lamp.



- Never unscrew except the appointed (marked by an arrow) screws.
- Do not open the lamp cover while the projector is suspended from a ceiling. This is dangerous, since if the lamp's bulb has broken, the shards will fall out when the cover is opened. In addition, working in high places is dangerous, so ask your local dealer to have the lamp replaced even if the bulb is not broken.
- Do not use the projector with the lamp cover removed. At the lamp replacing, make sure that the screws are screwed in firmly. Loose screws could result in damage or injury.

• Use only the lamp of the specified type.

• If the lamp breaks soon after the first time it is used, it is possible that there are electrical problems elsewhere besides the lamp. If this happens, consult your local dealer or a service representative.

- Handle with care: jolting or scratching could cause the lamp bulb to burst during use.
- Using the lamp for long periods of time, could cause it dark, not to light up or to burst. When the pictures appear dark, or when the color tone is poor, please replace the lamp as soon as possible. Do not use old (used) lamps; this is a cause of breakage.

Cleaning and replacing the air filter

The air filter unit of this projector consists of a filter cover, two kinds of filters, and a filter frame. The new double large filters system is expected to function longer. However, please check and clean it periodically to keep ventilation needed for normal operation of the projector.

When the indicators or a message prompts you to clean the air filter, comply with it as soon as possible. Replace the filters when they are damaged or too soiled. To prepare new filters, make contact with your dealer and tell the following type number.

Type number : MU05611

When you replace the lamp, please replace the air filter. An air filter of specified type will come together with a replacement lamp for this projector.

1. Turn the projector off, and unplug the power cord. Allow the projector to sufficiently cool down.
2. Use a vacuum cleaner on and around the filter cover.
3. Pull the filter cover knobs while lifting it, to take the filter unit off.
4. Use a vacuum cleaner for the filter vent of the projector and both sides of the filter unit.

If the filters are damaged or too soiled, replace them according to the following procedure number 5 to 7. Otherwise, please jump to the procedure number 8.

5. Pull the filter frame's knob up while holding the filter cover to remove the filter frame, then take the filters out.
6. Set new filters where former filters were. Put the larger meshed filter into a filter cover first. Then put the finer meshed filter on the larger meshed one.
7. Put the filter frame back where it was.

8. Put the filter unit back into the projector.

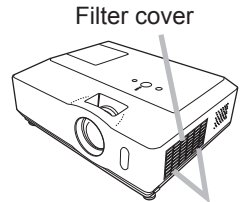

Filter cover knobs



Filter unit



Filter frame



Filter (finer meshed)



Filter (larger meshed)



Filter cover

(continued on next page)

Cleaning and replacing the air filter (continued)

9. Turn the projector on and reset the filter time using the FILTER TIME item in the EASY MENU.
- (1) Press the **MENU** button to display a menu.
 - (2) Point at the FILTER TIME using the ▼/▲ button, then press the ► button. A dialog will appear.
 - (3) Press the ▲ button to select RESET on the dialog. It performs resetting the filter time.

⚠ WARNING ► Before taking care of the air filter, make sure the power switch is off and the power cable is not plugged in, then allow the projector to cool sufficiently. Taking care of the air filter in a high temperature state of the projector could cause an electric shock, a burn or malfunction to the projector.

► Use only the air filter of the specified type. Do not use the projector without the air filter or the filter cover. It could result in a fire or malfunction to the projector.

► Clean the air filter periodically. If the air filter becomes clogged by dust or the like, internal temperatures rise and could cause a fire, a burn or malfunction to the projector.

NOTE • Please replace the air filter when it is damaged or too soiled.

- When you replace the projection lamp, please replace the air filter. An air filter of specified type will come together with a replacement lamp for this projector.
- Please reset the filter time only when you have cleaned or replaced the air filter, for a suitable indication about the air filter.
- The projector may display the message such as “CHECK THE AIR FLOW” or turn off the projector, to prevent the internal heat level rising.

Replacing the internal clock battery

This projector has internal clock that uses a battery. When the clock of the network function does not work correctly, please try solution by replacement of the battery:

HITACHI MAXELL, part number **CR2032**.

1. Turn the projector off, and unplug the power cord. Allow the projector to cool sufficiently.
2. After making sure that the projector has cooled adequately, pull the slot cover forward, pushing slightly its edge up, and remove it from the projector.
3. Remove the battery case. Hold the battery case gutter by finger nail or other thing and pull out the battery case slowly from the battery slot. While the projector is installed upside down, such as a ceiling mount, please remember the battery will drop down as soon as pulling the battery case out.
4. Take the old battery out from the battery case.
5. Replace a new battery. Put a new battery into battery case. Please make sure that the + is facing upward. Insert the battery case slowly into the battery slot until you hear the snap.
6. Close the slot cover. Replace the slot cover by reversing the procedure used when removing the cover.

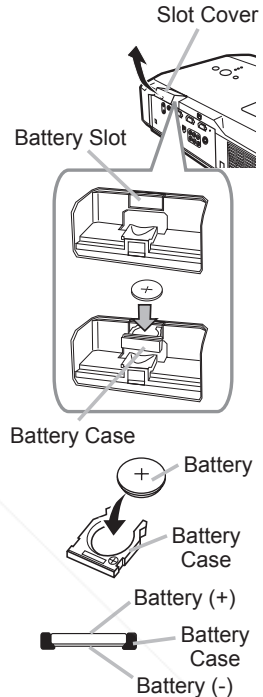

NOTE • The internal clock will be initialized by removing the battery. For setting the clock, see the User's Manual - Network Guide.

⚠ WARNING ► Be careful of handling a battery, as a battery can cause explosion, cracking or leakage, which could result in a fire, an injury, and environment pollution.

- Use only the specified and perfect battery. Do not use a battery with damage, such as a scratch, a dent, rust or leakage.

- When a battery leaked, wipe the leakage out well with a waste cloth. If the leakage adhered to your body, immediately rinse it well with water. When a battery leaked in the battery holder, replace the batteries after wiping the leakage out.

- Make sure the plus and minus terminals are correctly aligned when loading a battery.

- Do not work on a battery; for example recharging or soldering.

- Keep a battery in a dark, cool and dry place. Never expose a battery to a fire or water.

- Keep a battery away from children and pets.

- Obey the local laws on disposing a battery.

Other care

Inside of the projector

In order to ensure the safe use of your projector, please have it cleaned and inspected by your dealer about once every year.

Caring for the lens

If the lens is flawed, soiled or fogged, it could cause deterioration of display quality. Please take care of the lens, being cautious of handling.

1. Turn the projector off, and unplug the power cord. Allow the projector to cool sufficiently.
2. After making sure that the projector is cool adequately, lightly wipe the lens with a commercially available lens-cleaning wipe. Do not touch the lens directly with your hand.

Caring for the cabinet and remote control

Incorrect care could have adverse influence such as discoloration, peeling paint, etc.

1. Turn the projector off, and unplug the power cord. Allow the projector to cool sufficiently.
2. After making sure that the projector is cool adequately, lightly wipe with gauze or a soft cloth.
If the projector is extremely dirty, dip soft cloth in water or a neutral cleaner diluted in water, and wipe lightly after wringing well. Then, wipe lightly with a soft, dry cloth.

⚠ WARNING ▶ Before caring, make sure the power cord is not plugged in, and then allow the projector to cool sufficiently. The care in a high temperature state of the projector could cause a burn and/or malfunction to the projector.

▶ Never try to care for the inside of the projector personally. Doing is so dangerous.

▶ Avoid wetting the projector or inserting liquids in the projector. It could result in a fire, an electric shock, and/or malfunction to the projector.

• Do not put anything containing water, cleaners or chemicals near the projector.
Do not use aerosols or sprays.

⚠ CAUTION ▶ Please take right care of the projector according to the following. Incorrect care could cause not only an injury but adverse influence such as discoloration, peeling paint, etc.

▶ Do not use cleaners or chemicals other than those specified in this manual.

▶ Do not polish or wipe with hard objects.

Troubleshooting

If an abnormal operation should occur, stop using the projector immediately.





⚠ WARNING ▶ Never use the projector if abnormal operations such as smoke, strange odor, excessive sound, damaged casing or elements or cables, penetration of liquids or foreign matter, etc. should occur. In such cases, immediately turn off the power switch and then disconnect the power plug from the power outlet. After making sure that the smoke or odor has stopped, contact to your dealer or service company.

Otherwise if a problem occurs with the projector, the following checks and measures are recommended before requesting repair.

If this does not resolve the problem, please contact your dealer or service company. They will tell you what warranty condition is applied.

Related messages

When some message appears, check and cope with it according to the following table. Although these messages will be automatically disappeared around several minutes, it will be reappeared every time the power is turned on.

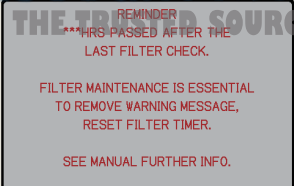
Message	Description
 <p>NO INPUT IS DETECTED ***</p>	<p>There is no input signal. Please confirm the signal input connection, and the status of the signal source.</p>
 <p>SYNC IS OUT OF RANGE *** fv **kHz fv **Hz</p>	<p>The horizontal or vertical frequency of the input signal is not within the specified range. Please confirm the specs for your projector or the signal source specs.</p>
 <p>INVALID SCAN FREQ. ***</p>	<p>An improper signal is input. Please confirm the specs for your projector or the signal source specs.</p>
 <p>CHECK THE AIR FLOW FixYourDLP.com Sponsored by DLP</p>	<p>The internal temperature is rising. Please turn the power off, and allow the projector to cool down at least 20 minutes. After having confirmed the following items, please turn the power ON again.</p> <ul style="list-style-type: none"> • Is there blockage of the air passage aperture? • Is the air filter dirty? • Does the peripheral temperature exceed 35°C? <p>If the same indication is displayed after the remedy, please set FAN SPEED of the SERVICE item in the OPTION menu to HIGH.</p>
 <p>REMINDER ***HRS PASSED AFTER THE LAST FILTER CHECK. FILTER MAINTENANCE IS ESSENTIAL TO REMOVE WARNING MESSAGE, RESET FILTER TIMER. SEE MANUAL FURTHER INFO.</p>	<p>A note of precaution when cleaning the air filter. Please immediately turn the power off, and clean or change the air filter referring to the “Cleaning and replacing the air filter” section of this manual. After you have cleaned or changed the air filter, please be sure to reset the filter timer (62).</p>

Regarding the indicator lamps

When operation of the **LAMP**, **TEMP** and **POWER** indicators differs from usual, check and cope with it according to the following table.

POWER indicator	LAMP indicator	TEMP indicator	Description
Lighting In Orange	Turned off	Turned off	The projector is in a standby state. Please refer to the section "Power on/off".
<i>Blinking</i> In Green	Turned off	Turned off	The projector is warming up. Please wait.
Lighting In Green	Turned off	Turned off	The projector is in an on state. Ordinary operations may be performed.
<i>Blinking</i> In Orange	Turned off	Turned off	The projector is cooling down. Please wait.
<i>Blinking</i> In Red	(discretionary)	(discretionary)	The projector is cooling down. A certain error has been detected. Please wait until POWER indicator finishes blinking, and then perform the proper measure using the item descriptions below.
<i>Blinking</i> In Red or Lighting In Red	Lighting In Red	Turned off	The lamp does not light, and there is a possibility that interior portion has become heated. Please turn the power off, and allow the projector to cool down at least 20 minutes. After the projector has sufficiently cooled down, please make confirmation of the following items, and then turn the power on again. <ul style="list-style-type: none"> • Is there blockage of the air passage aperture? • Is the air filter dirty? • Does the peripheral temperature exceed 35°C? If the same indication is displayed after the remedy, please change the lamp referring to the section "Lamp".
<i>Blinking</i> In Red or Lighting In Red FixYourDLP.com <small>Sponsored by DM</small>	<i>Blinking</i> In Red	Turned off	The lamp cover has not been properly fixed. Please turn the power off, and allow the projector to cool down at least 45 minutes. After the projector has sufficiently cooled down, please make confirmation of the attachment state of the lamp cover. After performing any needed maintenance, turn the power on again. If the same indication is displayed after the remedy, please contact your dealer or service company.
<i>Blinking</i> In Red or Lighting In Red	Turned off	<i>Blinking</i> In Red	The cooling fan is not operating. Please turn the power off, and allow the projector to cool down at least 20 minutes. After the projector has sufficiently cooled down, please make confirmation that no foreign matter has become caught in the fan, etc., and then turn the power on again. If the same indication is displayed after the remedy, please contact your dealer or service company.

(Continued on next page)

Regarding the indicator lamps (continued)

POWER indicator	LAMP indicator	TEMP indicator	Description
Blinking In Red or Lighting In Red	Turned off	Lighting In Red	<p>There is a possibility that the interior portion has become heated.</p> <p>Please turn the power off, and allow the projector to cool down at least 20 minutes. After the projector has sufficiently cooled down, please make confirmation of the following items, and then turn the power on again.</p> <ul style="list-style-type: none"> • Is there blockage of the air passage aperture? • Is the air filter dirty? • Does the peripheral temperature exceed 35°C? <p>If the same indication is displayed after the remedy, please set FAN SPEED of SERVICE item in OPTION menu to HIGH (☐44).</p>
Lighting In Green	Simultaneous blinking in Red		<p>It is time to clean the air filter.</p> <p>Please immediately turn the power off, and clean or change the air filter referring to the section “Cleaning and replacing the air filter”. After cleaning or changing the air filter, please be sure to reset the filter timer.</p> <p>After the remedy, reset the power to ON.</p>
Lighting In Green	Alternative blinking in Red		<p>There is a possibility that the interior portion has become overcooled.</p> <p>Please use the unit within the usage temperature parameters (5°C to 35°C).</p> <p>After the treatment, reset the power to ON.</p>
Blinking in Green for approx. 3 seconds	Turned off	Turned off	<p>At least 1 Power ON schedule is saved to the projector.</p> <p>Please refer to Schedule Settings section of User’s Manual-Network Guide.</p>

NOTE • When the interior portion has become overheated, for safety purposes, the projector is automatically shut down, and the indicator lamps may also be turned off. In such a case, disconnect the power cord, and wait at least 45 minutes. After the projector has sufficiently cooled down, please make confirmation of the attachment state of the lamp and lamp cover, and then turn the power on again.

Shutting the projector down

Only when the projector can not be turned off by usual procedure (☐75), please push the shutdown switch using a pin or similar, and disconnect the power plug from the power outlet. Before turning it on again, wait at least 10 minutes to make the projector cool down enough.

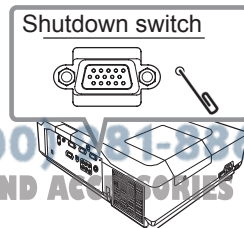

Resetting all settings

When it is hard to correct some wrong settings, the FACTORY RESET function of SERVICE item in OPTION menu (☐45) can reset all settings(except LANGUAGE, FILTER TIME, LAMP TIME, FILTER MESSAGE, NETWORK settings and etc.) to the factory default.

Phenomena that may be easy to be mistaken for machine defects

About the phenomenon confused with a machine defect, check and cope with it according to the following table.

Phenomenon	Cases not involving a machine defect	Reference page
Power does not come on.	The electrical power cord is not plugged in. Correctly connect the power cord.	12
	The main power source has been interrupted during operation such as by a power outage (blackout), etc. Please disconnect the power plug from the power outlet, and allow the projector to cool down at least 10 minutes, then turn the power on again.	12, 15
	Either there is no lamp and/or lamp cover, or either of these has not been properly fixed. Please turn the power off and disconnect the power plug from the power outlet, and allow the projector to cool down at least 45 minutes. After the projector has sufficiently cooled down, please make confirmation of the attachment state of the lamp and lamp cover, and then turn the power on again.	60, 61
Neither sounds nor pictures are outputted.	The signal cables are not correctly connected. Correctly connect the connection cables.	10
	Signal source does not correctly work. Correctly set up the signal source device by referring to the manual of the source device.	–
	The input changeover settings are mismatched. Select the input signal, and correct the settings.	16, 17
	The BLANK function for pictures and the MUTE function for sounds are working. AV MUTE may be active. Refer to the item “Sound does not come out” and “No pictures are displayed” on the next page to turn off the MUTE and BLANK functions.	43, 16, 21

(Continued on next page)

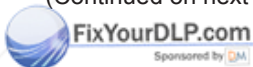

Discount-Merchant.com (800) 281-8860
THE TRUSTED SOURCE FOR PROJECTOR LAMPS AND ACCESSORIES

Phenomena that may be easy to be mistaken for machine defects (continued)

Phenomenon	Cases not involving a machine defect	Reference page
Sound does not come out.	The signal cables are not correctly connected. Correctly connect the audio cables.	10
	The MUTE function is working. Restore the sound pressing MUTE or VOLUME +/- button on the remote control.	16
	The volume is adjusted to an extremely low level. Adjust the volume to a higher level using the menu function or the remote control.	16
	The AUDIO/SPEAKER setting is not correct. Correctly set the AUDIO/SPEAKER in AUDIO menu.	36
No pictures are displayed.	The lens cover is attached. Remove the lens cover.	4, 15
	The signal cables are not correctly connected. Correctly connect the connection cables.	10
	The brightness is adjusted to an extremely low level. Adjust BRIGHTNESS to a higher level using the menu function.	25, 26
	The computer cannot detect the projector as a plug and play monitor. Make sure that the computer can detect a plug and play monitor using another plug and play monitor.	11
	The BLANK screen is displayed. Press BLANK button on the remote control.	21

(Continued on next page)



Discount-Merchant.com (800) 281-8860
THE TRUSTED SOURCE FOR PROJECTOR LAMPS AND ACCESSORIES

Phenomena that may be easy to be mistaken for machine defects (continued)

Phenomenon	Cases not involving a machine defect	Reference page
Video screen display freezes.	The FREEZE function is working. Press FREEZE button to restore the screen to normal.	21
Colors have a faded- out appearance, or Color tone is poor.	Color settings are not correctly adjusted. Perform picture adjustments by changing the COLOR TEMP, COLOR, TINT and/or COLOR SPACE settings, using the menu functions.	25, 27, 31
	COLOR SPACE setting is not suitable. Change the COLOR SPACE setting to AUTO, RGB, SMPTE240, REC709 or REC601.	31
Pictures appear dark.	The brightness and/or contrast are adjusted to an extremely low level. Adjust BRIGHTNESS and/or CONTRAST settings to a higher level using the menu function.	25, 26
	The WHISPER function is working. Select NORMAL for WHISPER item in the SETUP menu.	25, 35
	The lamp is approaching the end of its product lifetime. Replace the lamp.	60, 61
Pictures appear blurry.	Either the focus and/or horizontal phase settings are not properly adjusted. Adjust the focus using the focus ring, and/or H PHASE using the menu function.	18, 30
	The lens is dirty or misty. Clean the lens referring to the section "Caring for the lens".	65
RS-232C does not work.	The SAVING function is working. Select NORMAL for STANDBY MODE item in the SETUP menu.	35
Network does not work.		



Discount-Merchant.com (800) 281-8860
THE TRUSTED SOURCE FOR PROJECTOR LAMPS AND ACCESSORIES

NOTE • Although bright spots or dark spots may appear on the screen, this is a unique characteristic of liquid crystal displays, and it does not constitute or imply a machine defect.

Specifications

Specification

Item		Specification
Product name		Liquid crystal projector
Liquid Crystal Panel	Panel size	1.6 cm (0.63 type)
	Drive system	TFT active matrix
	Pixels	786,432 pixels (1024 horizontal x 768 vertical)
Lens		Zoom lens, <div style="display: flex; justify-content: space-around;"> <div style="text-align: center;"> <p><CP-X206> F=1.7 ~ 1.9 f = 18.9~ 22.6 mm</p> </div> <div style="text-align: center;"> <p><CP-X306> F=1.7 ~ 1.9 f = 19.5~ 23.4 mm</p> </div> </div> <p style="text-align: right;">(approximately)</p>
Lamp		220W UHB
Audio output		7 W
Power supply		AC 100-120V/3.5A, AC220-240V/1.5A
Power consumption		320 W
Temperature range		5 ~ 35°C (Operating)
Size		340 (W) x 117 (H) x 270 (D) mm * Not including protruding parts. Please refer to the following figure.
Weight (mass)		approx. 4.0 kg
Ports		<p>Computer input port COMPUTER IN1D-sub 15 pin mini x1 COMPUTER IN2D-sub 15 pin mini x1</p> <p>Computer output port MONITOR OUTD-sub 15 pin mini x1</p> <p>Video input port Y, Cb/Pb, Cr/Pr (Component video) RCA x3 S-VIDEO mini DIN 4 pin x1 VIDEO RCA x1</p> <p>Audio input/output port AUDIO IN1Stereo mini x1 AUDIO IN2Stereo mini x1 AUDIO IN3 RCA x2 AUDIO OUTStereo mini x1</p> <p>Others USBUSB-B x1 CONTROL D-sub 9 pin x1 LANRJ45 x1</p>
Optional parts		<p>Lamp: DT00841 Air filter: MU05611</p> <p>* For more information, please consult your dealer.</p>



Discount-Market.com (800) 281-8860
 THE TRUSTED SOURCE FOR PROJECTOR LAMPS AND ACCESSORIES

Specifications (continued)

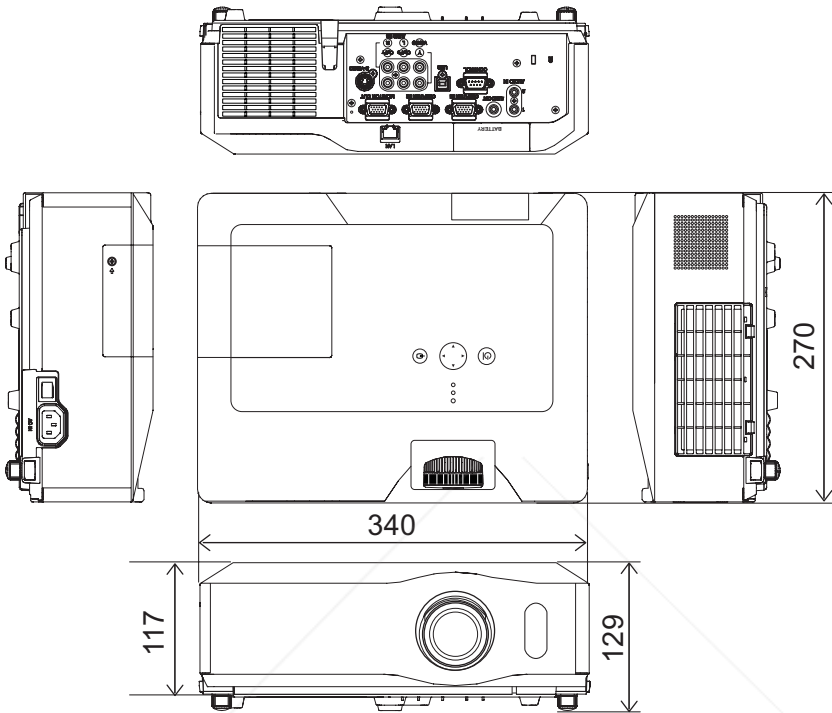

[unit: mm]



Discount-Merchant.com (800) 281-8860
THE TRUSTED SOURCE FOR PROJECTOR LAMPS AND ACCESSORIES



Disclaimer

This user manual is provided as a free service by FixYourDLP.com. FixYourDLP is in no way responsible for the content of this manual, nor do we guarantee its accuracy. FixYourDLP does not make any claim of copyright and all copyrights remain the property of their respective owners.

About FixYourDLP.com

FixYourDLP.com (<http://www.fixyourdpl.com>) is the World's #1 resource for media product news, reviews, do-it-yourself guides, and manuals.

Informational Blog: <http://www.fixyourdpl.com>

Video Guides: <http://www.fixyourdpl.com/guides>

User Forums: <http://www.fixyourdpl.com/forum>

FixYourDLP's Fight Against Counterfeit Lamps:

<http://www.fixyourdpl.com/counterfeits>

Sponsors:

RecycleYourLamp.org – Free lamp recycling services for used lamps:

<http://www.recycleyourlamp.org>

Lamp Research - The trusted 3rd party lamp research company:

<http://www.lampresearch.com>

Discount-Merchant.com – The worlds largest lamp distributor:

<http://www.discount-merchant.com>



FixYourDLP.com

Sponsored by 