



Disclaimer

This user manual is provided as a free service by FixYourDLP.com. FixYourDLP is in no way responsible for the content of this manual, nor do we guarantee its accuracy. FixYourDLP does not make any claim of copyright and all copyrights remain the property of their respective owners.

About FixYourDLP.com

FixYourDLP.com (<http://www.fixyourdpl.com>) is the World's #1 resource for media product news, reviews, do-it-yourself guides, and manuals.

Informational Blog: <http://www.fixyourdpl.com>

Video Guides: <http://www.fixyourdpl.com/guides>

User Forums: <http://www.fixyourdpl.com/forum>

FixYourDLP's Fight Against Counterfeit Lamps:

<http://www.fixyourdpl.com/counterfeits>

Sponsors:

RecycleYourLamp.org – Free lamp recycling services for used lamps:

<http://www.recycleyourlamp.org>

Lamp Research - The trusted 3rd party lamp research company:

<http://www.lampresearch.com>

Discount-Merchant.com – The worlds largest lamp distributor:

<http://www.discount-merchant.com>



FixYourDLP.com

Sponsored by 



LC COLOR VIDEO PROJECTOR

MODEL **LC-300**

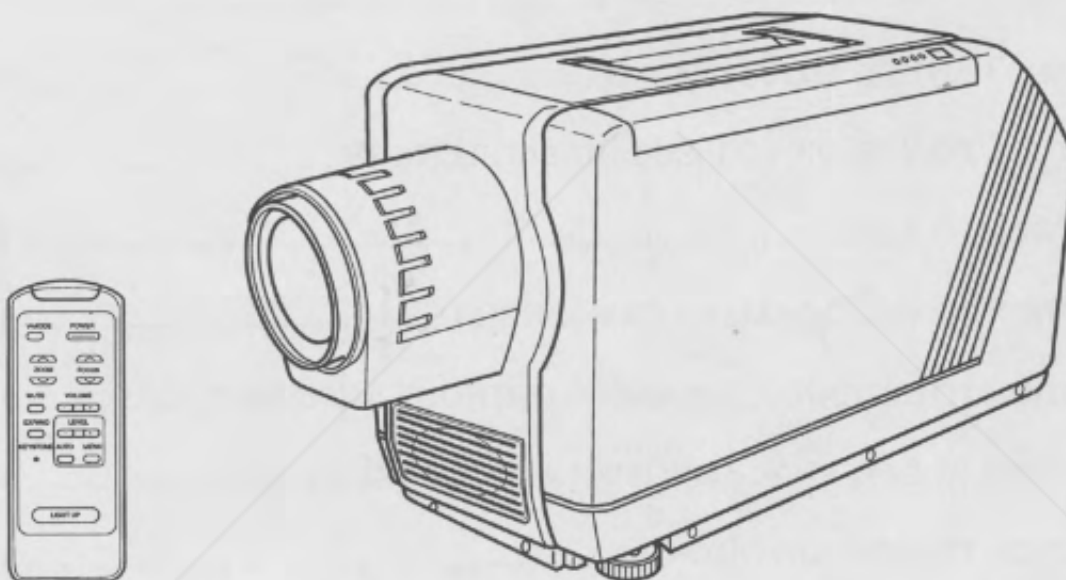

OWNER'S INSTRUCTION MANUAL

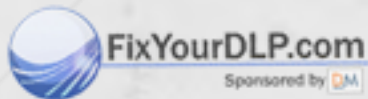

FixYourDLP.com

Sponsored by 

Discount-Merchant.com (800) 281-8860

THE TRUSTED SOURCE FOR PROJECTOR LAMPS AND ACCESSORIES

TABLE OF CONTENTS

	PAGE
1. SAFETY PRECAUTIONS	1
2. IMPORTANT SAFETY INSTRUCTIONS	2
3. DESCRIPTION	3
4. OPERATION OF CONTROLS	4 – 5
5. REMOTE CONTROL UNIT OPERATION	6 – 7
6. SETTING-UP THE PROJECTOR	8
7. USING THE PROJECTOR	9 – 11
8. COLOR AND PICTURE ADJUSTMENTS	12
9. CONNECTION TO VCR, VIDEO DISC AND SATELLITE TV	13
10. CONNECTION TO S-VHS VCR	14
11. CONNECTION TO VIDEO CAMERA/CAMCORDER	14
12. CONNECTION TO EXTERNAL SPEAKERS (WITHOUT AMPLIFIER)	15
13. CONNECTION TO EXTERNAL AMPLIFIER AND SPEAKERS	16
14. CONNECTION TO MONITOR OUTPUT	16
15. AIR FILTER CARE AND CLEANING	17
16. LAMP REPLACEMENT/TEMPERATURE INDICATORS	17
17. TROUBLE SHOOTING GUIDE	18
18. TECHNICAL SPECIFICATIONS	19

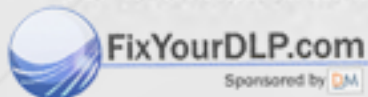

Discount-Merchant.com (800) 281-8860
THE TRUSTED SOURCE FOR PROJECTOR LAMPS AND ACCESSORIES

INFORMATION TO THE USER

NOTE: This equipment has been tested and found to comply with the limits for a Class A digital device, pursuant to Part 15 of the FCC Rules. These limits are designed to provide reasonable protection against harmful interference when the equipment is operated in a commercial environment. This equipment generates, uses, and can radiate radio frequency energy and, if not installed and used in accordance with the instruction manual, may cause harmful interference to radio communications. Operation of this equipment in a residential area is likely to cause harmful interference in which case the user will be required to correct the interference at his own expense.

1 SAFETY PRECAUTIONS

WARNING:

TO REDUCE THE RISK OF FIRE OR ELECTRIC SHOCK, DO NOT EXPOSE THIS APPLIANCE TO RAIN OR MOISTURE.

The LC color video projector has a grounding-type AC line plug. This is a safety feature to be sure that the plug will fit into the power outlet. Do not defeat this safety feature.

Intense light source. Do not stare directly into the projection lens as possible eye damage could result. Be especially careful that children do not stare directly into the beam.

If the LC color video projector will not be used for an extended time, unplug the LC color video projector from the power outlet.

READ AND KEEP THIS OWNER'S INSTRUCTION MANUAL FOR LATER USE.

	CAUTION RISK OF ELECTRIC SHOCK DO NOT OPEN	
CAUTION: TO REDUCE THE RISK OF ELECTRIC SHOCK, DO NOT REMOVE COVER (OR BACK). NO USER-SERVICEABLE PARTS INSIDE. REFER SERVICING TO QUALIFIED SERVICE PERSONNEL.		
 THIS SYMBOL INDICATES THAT DANGEROUS VOLTAGE CONSTITUTING A RISK OF ELECTRIC SHOCK IS PRESENT WITHIN THIS UNIT.	 THIS SYMBOL INDICATES THAT THERE ARE IMPORTANT OPERATING AND MAINTENANCE INSTRUCTIONS IN THE OWNER'S MANUAL WITH THIS UNIT.	

IMPORTANT:

For your protection in the event of theft or loss of this LC color video projector, please record the Model Number and Serial Number located on the rear of unit and retain this information. Refer to these numbers whenever you call upon your Eiki dealer regarding this product.

Model No: LC-300

Serial No: _____

 **Discount-Merchant.com (800) 281-8860**
THE TRUSTED SOURCE FOR PROJECTOR LAMPS AND ACCESSORIES

2 IMPORTANT SAFETY INSTRUCTIONS

Read all of the instructions given here and retain them for later use. Unplug this projector from AC power supply before cleaning. Do not use liquid or aerosol cleaners. Use a damp cloth for cleaning.

Do not use attachments not recommended by the manufacturer as they may cause hazards.

Do not place this projector on an unstable cart, stand, or table. The projector may fall, causing serious injury to a child or adult, and serious damage to the projector. Use only with a cart or stand recommended by the manufacturer, or sold with the projector. Wall or shelf mounting should follow the manufacturer's instructions, and should use a mounting kit approved by the manufacturer.

Do not expose this unit to rain or use near water... for example, in a wet basement, near a swimming pool or the like.

Slots and openings in the cabinet and the back or bottom are provided for ventilation, to insure reliable operation of the equipment and to protect it from overheating.

The openings should never be covered with cloth or other material, and the bottom opening should not be blocked by placing the projector on a bed, sofa, rug, or other similar surface. This projector should never be placed near or over a radiator or heat register.

This projector should not be placed in a built-in installation such as a bookcase unless proper ventilation is provided.

This projector should be operated only from the type of power source indicated on the marking label. If you are not sure of the type of power supplied, consult your Eiki dealer or local power company.

Do not overload wall outlets and extension cords as this can result in fire or electric shock. Do not allow anything to rest on the power cord. Do not locate this projector where the cord will be abused by persons walking on it.

Never push objects of any kind into this projector through cabinet slots as they may touch dangerous voltage points or short out parts that could result in a fire or electric shock. Never spill liquid of any kind on the projector.

Do not attempt to service this projector yourself as opening or removing covers may expose you to dangerous voltage or other hazards. Refer all servicing to qualified service personnel.

Unplug this projector from wall outlet and refer servicing to qualified service personnel under the following conditions:

- a. When the power cord or plug is damaged or frayed.
- b. If liquid has been spilled into the projector.
- c. If the projector has been exposed to rain or water.
- d. If the projector does not operate normally by following the operating instructions. Adjust only those controls that are covered by the operating instructions as improper adjustment of other controls may result in damage and will often require extensive work by a qualified technician to restore the projector to normal operation.
- e. If the projector has been dropped or the cabinet has been damaged.
- f. When the projector exhibits a distinct change in performance - this indicates a need for service.

When replacement parts are required, be sure the service technician has used replacement parts specified by the manufacturer that have the same characteristics as the original part. Unauthorized substitutions may result in fire, electric shock, or injury to persons.

Upon completion of any service or repairs to this projector, ask the service technician to perform routine safety checks to determine that the projector is in safe operating condition.



This projector is equipped with a grounding type AC line plug. Should you be unable to insert the plug into the outlet, contact your electrician. Do not defeat the safety purpose of this grounding type plug.

Follow all warnings and instructions marked on the projectors.

For added protection for the projector during a lightning storm, or when it is left unattended and unused for long periods of time, unplug it from the wall outlet. This will prevent damage due to lightning and powerline surges.



An appliance and cart combination should be moved with care. Quick stops, excessive force, and uneven surfaces may cause the appliance and cart combination to overturn.

FixYourDLP.com
Sponsored by DM

DirectMail.com (800) 281-8860
THE TRUSTED SOURCE FOR PROJECTOR LAMPS AND ACCESSORIES

3 DESCRIPTION

FRONT

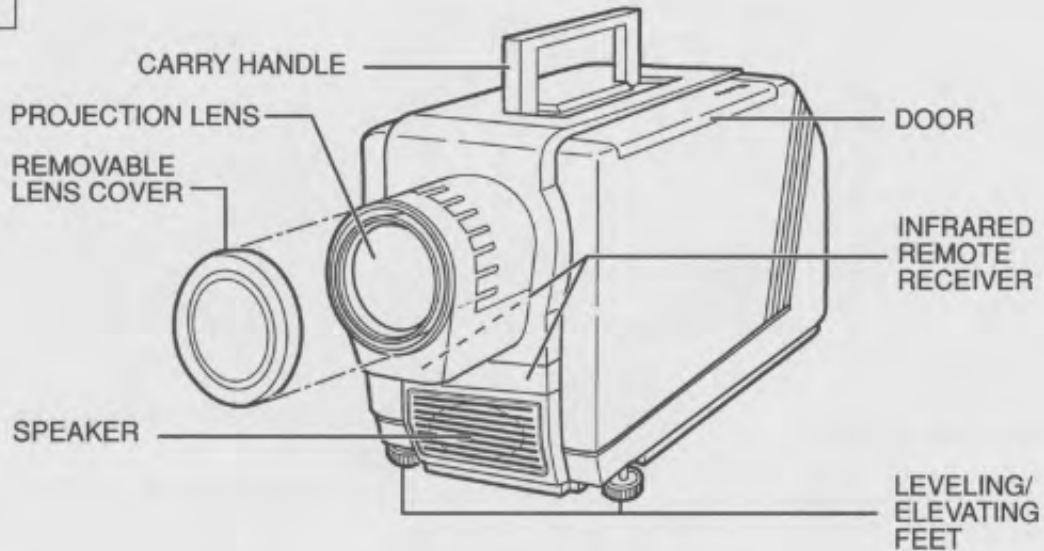

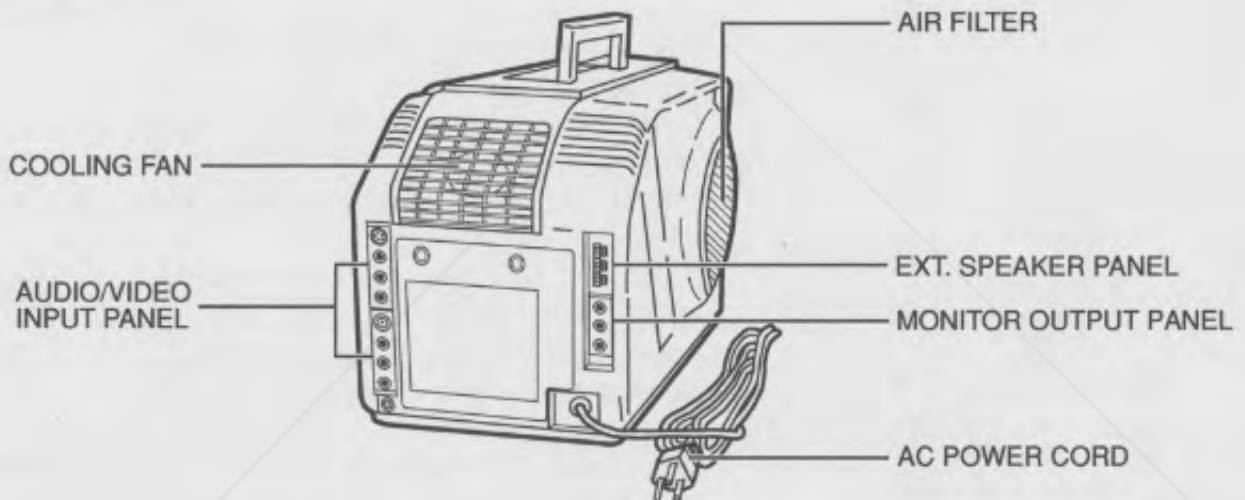

REAR



MOVING THE PROJECTOR

Use the carry handle when moving the projector.



 **FixYourDLP.com**
Sponsored by 

Discount-Merchants.com (800) 281-8860

THE TRUSTED SOURCE FOR PROJECTOR LAMPS AND ACCESSORIES

Replace the lens cover when moving the projector to prevent damage to the lens.

4 OPERATION OF CONTROLS

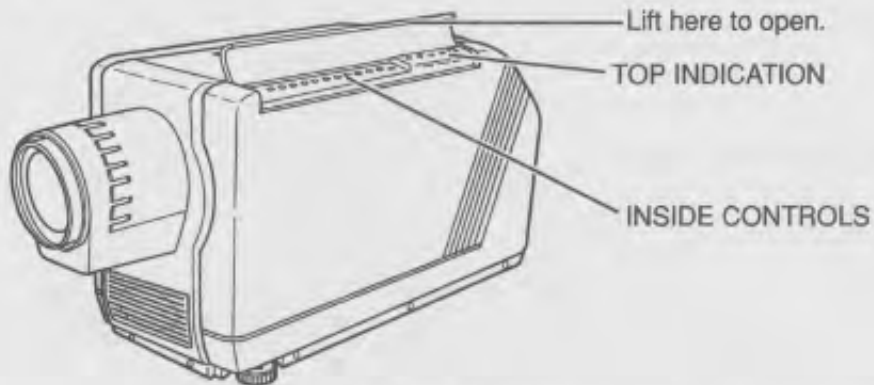

INSIDE CONTROLS

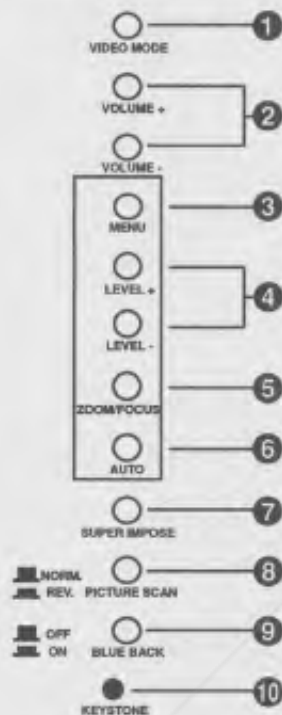

TOP INDICATION

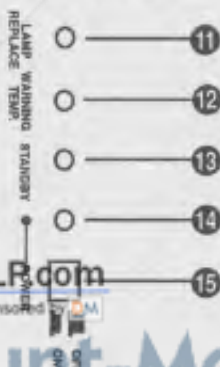

- 1 VIDEO MODE BUTTON
Press to select video source. (Video Input-1 or Video Input-2)
- 2 VOLUME BUTTONS
Used to increase or decrease sound level.
- 3 MENU BUTTON
Used to select on-screen adjustment displays for color, tint, brightness, contrast and sharpness. Press repeatedly to cycle.
- 4 LEVEL CONTROL BUTTONS
Used to adjust zoom, focus, color, tint, brightness, contrast, sharpness and keystone by pressing + or - button.
- 5 ZOOM/FOCUS BUTTON
Used to select power zoom lens or focus system.
- 6 AUTO BUTTON
Used to reset to normal factory set picture adjustment.
- 7 SUPERIMPOSE BUTTON
Pressing this button produces white character and lines on a blue background.
- 8 REVERSE PICTURE SCANNING BUTTON
Automatically reverses the projected screen image.
- 9 BLUE BACK BUTTON
Used to project the blue image without video noise on the screen when the video source is unplugged or turned off.
- 10 KEYSTONE BUTTON
Used to select the keystone position.
- 11 LAMP REPLACEMENT INDICATOR
Lights orange when projection lamp is nearing end of service life.
- 12 TEMPERATURE WARNING INDICATOR
Lights red when internal projector temperature is too high.
- 13 STANDBY INDICATOR
Lights green when projector is ready to be turned on.
- 14 POWER INDICATOR
When the POWER indicator lights, the projector is on.
When the POWER indicator is dim, the projector is standby mode.
- 15 POWER ON/OFF BUTTON
Press to turn power and projection lamp on or off.



FixYourDLR.com

Sponsored by

Discount-Merchant.com (800) 281-8860

THE TRUSTED SOURCE FOR PROJECTOR LAMPS AND ACCESSORIES

BACK OF THE PROJECTOR

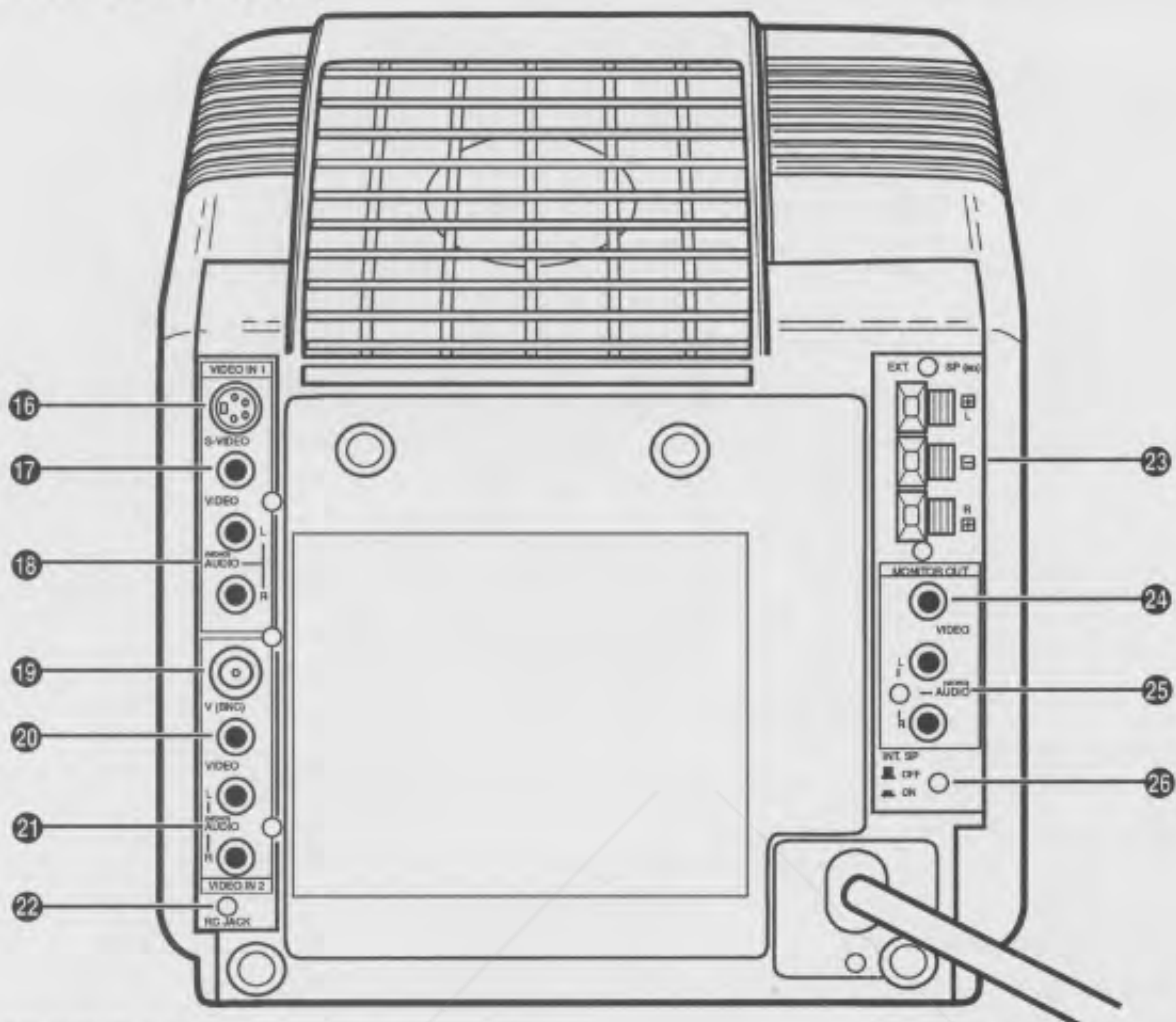

- 16 S-VIDEO INPUT JACK
Used to connect S-VHS video source to the projector.
- 17 VIDEO INPUT-1 Jack
Used to connect a video source to the projector.
- 18 AUDIO INPUT-1 JACKS
Used to connect an audio input to the projector.
- 19 VIDEO INPUT-2 (BNC) JACK
Used to connect a video source to the projector.
- 20 VIDEO INPUT-2 JACK
Used to connect a video source to the projector.
- 21 AUDIO INPUT-2 JACKS
Used to connect an audio input to the projector.
- 22 WIRED REMOTE JACK
When using the wired remote control, connect the remote cable to this jack.



EXTERNAL SPEAKER TERMINALS

When using the external speakers, connect the speaker cable to this terminal.

- 24 VIDEO MONITOR OUTPUT JACK
Permits video connection to a monitor.
- 25 AUDIO MONITOR OUTPUT JACKS
Permits audio connection to a monitor.
- 26 INT. SPEAKER ON/OFF BUTTON
Turns the internal speaker on or off.

DiscountMerchant.com (800) 281-8860

THE TRUSTED SOURCE FOR PROJECTOR LAMPS AND ACCESSORIES

5 REMOTE CONTROL OPERATION

REMOTE CONTROL UNIT

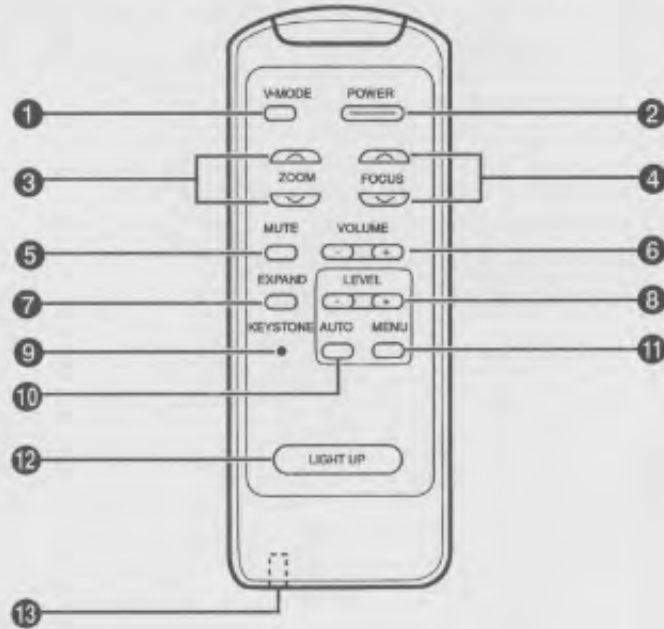

- 1 VIDEO MODE BUTTON
Press to select video source. (Video Input-1 or Video Input-2)
- 2 POWER ON/OFF BUTTON
Press to turn power and projection lamp on or off.
- 3 ZOOM BUTTONS
Used to operate power zoom lens.
- 4 FOCUS BUTTONS
Used to operate power focus system.
- 5 VOLUME MUTE BUTTON
Used to mute volume.
- 6 VOLUME BUTTONS
Used to adjust volume.
- 7 EXPAND BUTTON
Press to expand the center portion of the image twice. This function is cancelled when any other function button is pressed.
- 8 LEVEL CONTROL BUTTONS
Used to adjust zoom, focus, color, tint, brightness, contrast, sharpness and keystone by pressing + or – button.
- 9 KEYSTONE BUTTON
Used to select the keystone position.
- 10 AUTO BUTTON
Used to reset to normal factory set picture adjustment.
- 11 MENU BUTTON
Press to display the on screen adjustment displays for color, tint, brightness, contrast and sharpness.
Press repeatedly to cycle.
- 12 LIGHT UP BUTTON
Press to light the illumination for function buttons on the remote control unit for 5 seconds, and press any other function button during the lighting to light for another 5 seconds.
- 13 WIRED REMOTE JACK
When using the wired remote control, connect the remote cable to this jack.



FixYourDLP.com
DiscoDLP.com (800) 281-8860

THE TRUSTED SOURCE FOR PROJECTOR LAMPS AND ACCESSORIES

REMOTE CONTROL BATTERY INSTALLATION

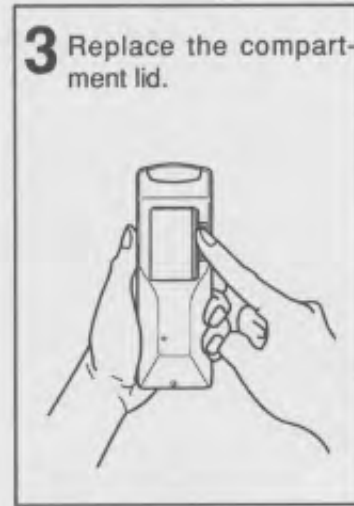
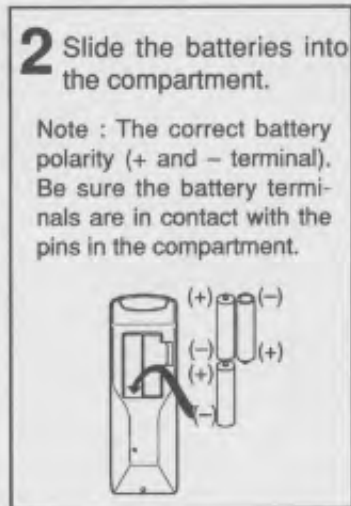

The remote control unit can be used as wireless and wired remote control.

USING THE REMOTE CONTROL UNIT (wireless)

Point the remote control toward the front of the projector (Receiver window) whenever pressing the buttons. Maximum operating range for the remote control is about 16.4' (5m) and 150° from the front of the projector.

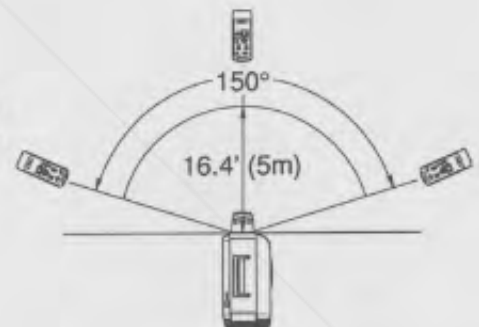

USING THE REMOTE CONTROL UNIT (wired)

Connect a remote control cable to RC jacks located on the remote control unit and the back of the projector.

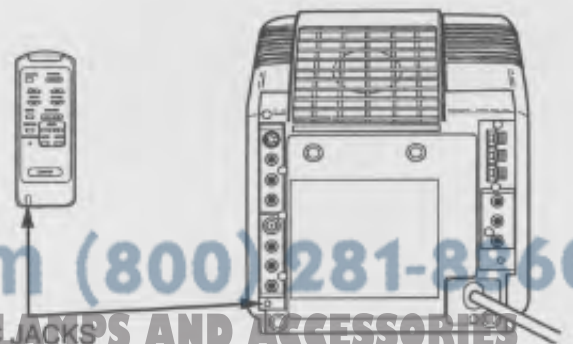

For more information, please observe the following precautions:

- Use (3) AA type batteries.
- Change three batteries at the same time.
- Do not use a new battery with a used battery.
- Avoid contact with water.
- Do not drop the remote control unit.

Discount Merchant.com (800) 281-8360
THE TRUSTED SOURCE FOR PROJECTOR LAMPS AND ACCESSORIES

6 SETTING-UP THE PROJECTOR

POSITIONING:

- This projector is basically designed to project on a flat projection surface. If the projector is not placed at 90° angle to the screen, the projected image will keystone. (See page 11 KEYSTONE CORRECTION.)
- This projector can be focused from 7.5' (2.3m) - 44' (13.4m).
- Use the illustration below as an example when positioning the projector to the screen.

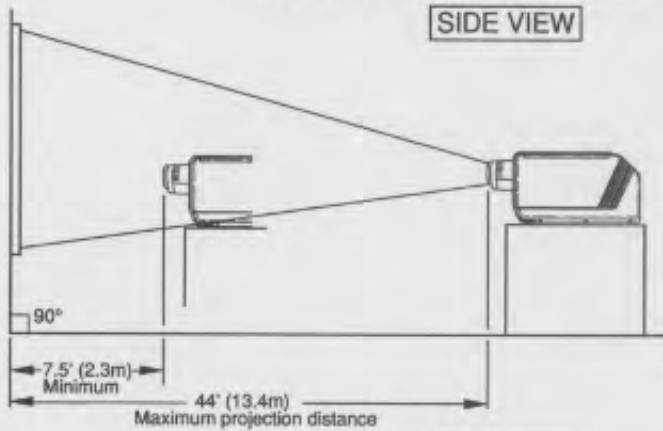

ROOM LIGHT

The projector should ideally be placed in a room with very limited light. Picture quality will be directly affected by lighting conditions.

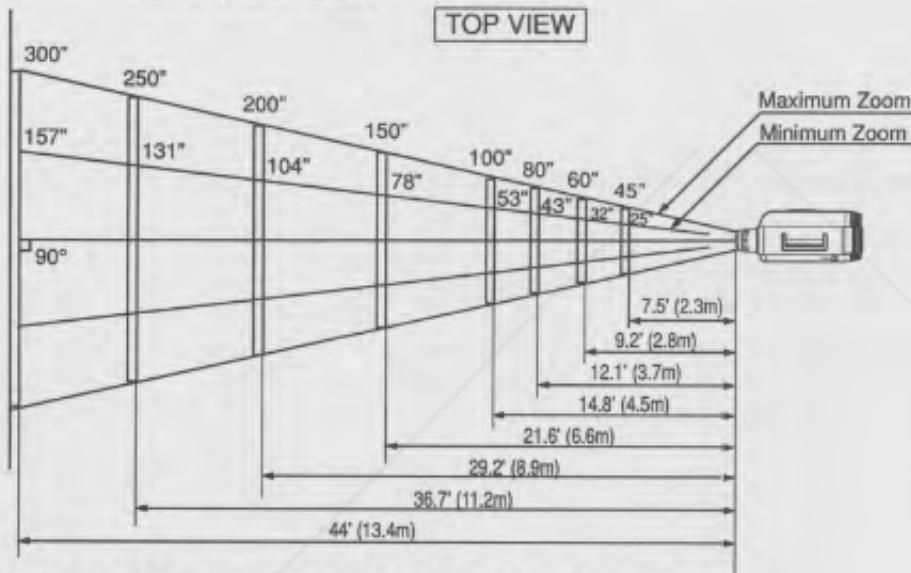

LEVELING AND ELEVATING ADJUSTMENTS

Picture adjustments can be made with the two leveling/elevating feet. Adjustments of 5° up are possible by rotating the feet on the bottom of the projector. Adjustments of 5° down are possible by raising up the stand.

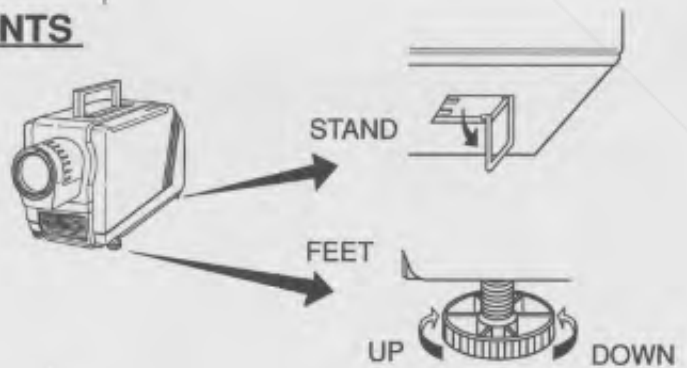

FiYourDLP.com
 Sponsored by  DM

Discount-Merchant.com (800) 221-8860
 THE TRUSTED SOURCE FOR PROJECTOR LAMPS AND ACCESSORIES



7 USING THE PROJECTOR

TO TURN ON THE PROJECTOR

Connect the projector to a video source (VCR, Video Camera, Video Disc Player, etc.) using the appropriate terminals on the back of the projector (See page 13 - 16).

Connect the projector's AC power cord into a wall outlet. The STANDBY indicator will light GREEN.

NOTE: AFTER YOU TURN OFF THE PROJECTOR YOU MUST WAIT ONE MINUTE BEFORE YOU CAN TURN THE PROJECTOR ON AGAIN. DO NOT UNPLUG THE PROJECTOR UNTIL THE COOLING FAN STOPS OPERATING.

Press the POWER ON/OFF button on the projector to ON. The POWER INDICATOR will light bright and the cooling fan will operate. The standby display (STANDBY and numeral 30) appears on the screen and the count-down starts (30-29-28-...1). The signal from the video source appears after 30 seconds. Now the remote control can be activated, and all functions may be used.

STANDBY

30

NOTE 1 : This projector use a metal-halide arc lamp. If you turn on the lamp, do not turn it off for at least 5 minutes, so as not to shorten its life.

NOTE 2 : If the TEMPERATURE WARNING INDICATOR flashes red, the projector will automatically turn off. Wait at least 5 minutes before turning the projector on.

NOTE 3 : If the TEMPERATURE WARNING INDICATOR continue to flash, follow the procedures below:

- (1). Press POWER ON/OFF button to OFF.
- (2). Check the air filter for dust accumulation.
- (3). Remove dust with vacuum cleaner (See air filter care and cleaning on page 17.)
- (4). Press POWER ON/OFF button to ON.

After checking of the above procedure, if the TEMPERATURE WARNING INDICATOR still continues to flash, call your authorized distributor for service.

TO TURN OFF THE PROJECTOR (with the remote control unit)

Press the POWER ON/OFF button on the remote control unit to OFF. The POWER indicator will light dim and STANDBY indicator will turn off. The cooling fan will operate for 1 minute after the projector is turned off. (During this "cooling down" period, the projector can not be turned on.)

After 1 minute, the STANDBY indicator will light green again and the projector may be turned on by pressing the POWER ON/OFF button on the remote control unit.

NOTE: Remote control can be activated only when POWER ON/OFF button on the projector is pressed to ON.

TO TURN OFF THE PROJECTOR (without the remote control unit)

Press the POWER ON/OFF button on the projector to OFF. The POWER and STANDBY indicator will turn off. The cooling fan will operate for 1 minute after the projector is turned off. (During this "cooling down" period, the projector can not be turned on.)

After 1 minute, the STANDBY indicator will light green again and the projector may be turned on by pressing the POWER ON/OFF button on the projector.

NOTE: If the projector is turned off by the remote control unit, it can be turned back on without the remote by pressing the POWER ON/OFF button on the projector twice.

ADJUST THE PROJECTOR

VIDEO MODE SELECT

Press VIDEO MODE button located on projector or remote control unit to select Video Input-1 or Video Input-2, and "AV1" or "AV2" appears on the screen display.

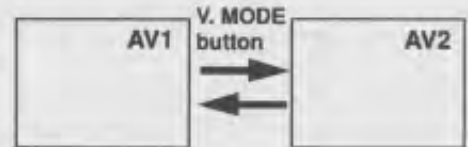

VOLUME ADJUSTMENT

Press INT. SPEAKER button to ON(IN) position when the INT. SPEAKER is used.

Press VOLUME buttons on the projector, or on the remote control unit to adjust the volume. The screen display will appear.

Pressing (+) will increase volume and the green indicator will increase to the right on the screen.

Pressing (-) will decrease volume and the green indicator will decrease to the left on the screen.

Press INT. SPEAKER button to OFF (OUT) position, will disengage the internal speaker on the projector.

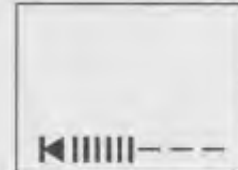

MUTE ADJUSTMENT

Pressing MUTE button on the remote control unit will mute audio (Red screen display will appear). Press MUTE button again to restore audio to its previous level.

ZOOM ADJUSTMENT (Without remote control unit)

Press ZOOM/FOCUS button until zoom display will appear on the screen, and press LEVEL(+) or (-) to obtain your desired picture size. (The zoom display will appear for 5 seconds.) For the larger size, press (+) and for the smaller size, press (-).



ZOOM ADJUSTMENT (With remote control unit)

Press ZOOM (^) or (v) to obtain your desired picture size. (The zoom display will appear for 5 seconds.) For the larger size, press (^) and for the smaller size, press (v).

FOCUS ADJUSTMENT (Without remote control unit)

Press ZOOM/FOCUS button until focus display will appear on the screen, and press LEVEL (+) or (-) for sharper, crisper picture. (The focus display will appear for 5 seconds.)

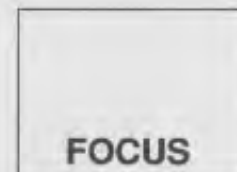

FOCUS ADJUSTMENT (With remote control unit)

Press FOCUS (^) or (v) for sharper, crisper picture. (The focus display will appear for 5 seconds.)

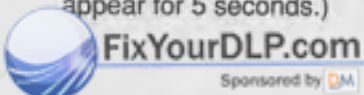

COLOR AND PICTURE ADJUSTMENT

The normal color setting is factory preset on the projector and can be obtained anytime by pressing the AUTO button on the projector, or on the remote control unit.

The color adjustment can be made by using the MENU and LEVEL buttons on the projector, or on the remote control unit.

Discount-Merchant.com (800) 281-8860
THE TRUSTED SOURCE FOR PROJECTOR LAMPS AND ACCESSORIES

OTHER FEATURES

SUPERIMPOSE

Pressing SUPERIMPOSE button on the projector produces white character and lines on a blue background.

BLUE BACK

Pressing BLUE BACK button on the projector to project the blue image without video noise on the screen when the video source is unplugged or turned off.

EXPAND

Press EXPAND button on the remote control unit to expand the center portion of the image twice. This function is cancelled when any other function is pressed.

REVERSE PICTURE SCANNING

The versatile left/right picture reverse capability lets you project onto the screen from in front or behind.

- Press the REVERSE PICTURE SCANNING button on the projector, if required.

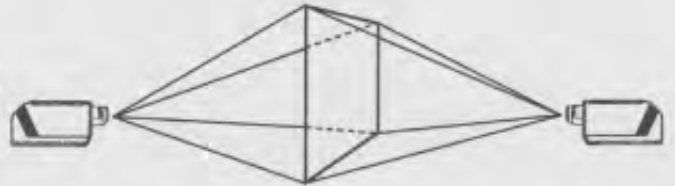

KEystone CORRECTION

When the projector is used at upper or lower position, the keystone appears on the bottom or top of the screen. The keystone can be corrected as follows:

• LOW MOUNT PROJECTION

If the projector is mounted low, the keystone will appear at the top of the screen. Press keystone button on the projector, or remote control unit using the tip of a ball-point pen until the bar appears on the top of the screen. Press the level (-) button until the keystone is corrected.



• HIGH MOUNT PROJECTION

If the projector is mounted high, the keystone will appear at the bottom of the screen. Press keystone button on the projector, or remote control unit using the tip of a ball-point pen until the bar appears on the bottom of the screen. Press the level (-) button until the keystone is corrected.



TOP KEystone CORRECTION DISPLAY

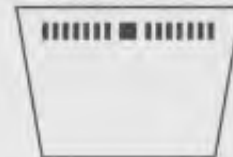

PRESS (-) LEVEL BUTTON



PRESS (+) LEVEL BUTTON



BOTTOM KEystone CORRECTION DISPLAY



PRESS (-) LEVEL BUTTON



PRESS (+) LEVEL BUTTON

 FixYourDLP.com
Sponsored by 

Discount-Merchant.com (800) 281-8860

THE TRUSTED SOURCE FOR PROJECTOR LAMPS AND ACCESSORIES

NOTE: The projector is equipped with a built-in memory feature that eliminates the need to readjust the keystone each time the projector is turned off and the AC power cord is disconnected.

8 COLOR AND PICTURE ADJUSTMENTS

INSIDE CONTROLS OF THE PROJECTOR

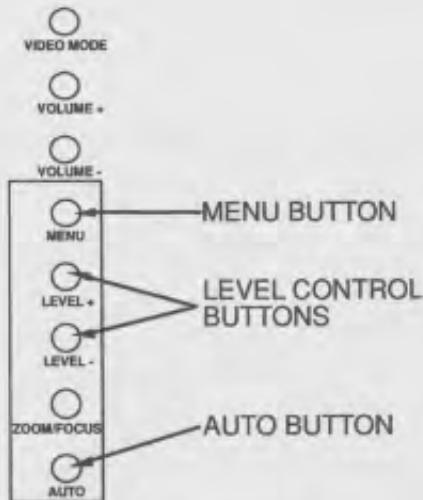

REMOTE CONTROL UNIT

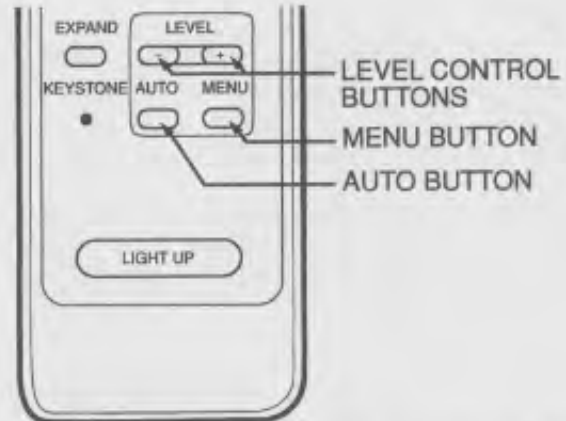

Color and picture adjustments have been preset at the factory to quality standards. However, with the MENU and LEVEL buttons located on projector, or on the remote control unit, the color and picture adjustments can be made.

1. To adjust the following functions (COLOR, TINT, CONTRAST, BRIGHTNESS, and SHARPNESS) press the MENU button.
2. Pressing the MENU button once, puts you in the color adjustment mode. The word COLOR should be appear on the screen. Proceed to adjust the color to your preference by pressing the LEVEL CONTROL (+) to increase color or the (-) to decrease color.

	PRESS LEVEL CONTROL (-)	PRESS LEVEL CONTROL (+)
	←-----■-----→	
	• Press the LEVEL CONTROL buttons to make adjustments. Refer to the picture control chart below.	
COLOR	DECREASES	INCREASES
TINT	MORE PURPLE	MORE GREEN
CONTRAST	SOFTER	SHARPER
BRIGHTNESS	DARKER	BRIGHTER
SHARPNESS	SOFTER	SHARPER

By Your Discount Merch.com
 After pressing the MENU button, the other functions (TINT, CONTRAST, BRIGHTNESS and SHARPNESS) will appear in order. Use the same procedure to adjust other functions according to your preference.

4. The ON-SCREEN display will disappear automatically in 8 seconds.

NOTE: The projector is equipped with a built-in memory feature that can maintain the color adjustment to set on AV1 and AV2 respectively even if the projector is turned off and AC power cord is disconnected. If AUTO button is pressed, the projector will revert back to factory preset colors.

Discount Merchant.com (800) 281-8860

THE TRUSTED SOURCE FOR PROJECTOR LAMPS AND ACCESSORIES

9 CONNECTION TO VCR, VIDEO DISC PLAYER AND SATELLITE TV TUNER

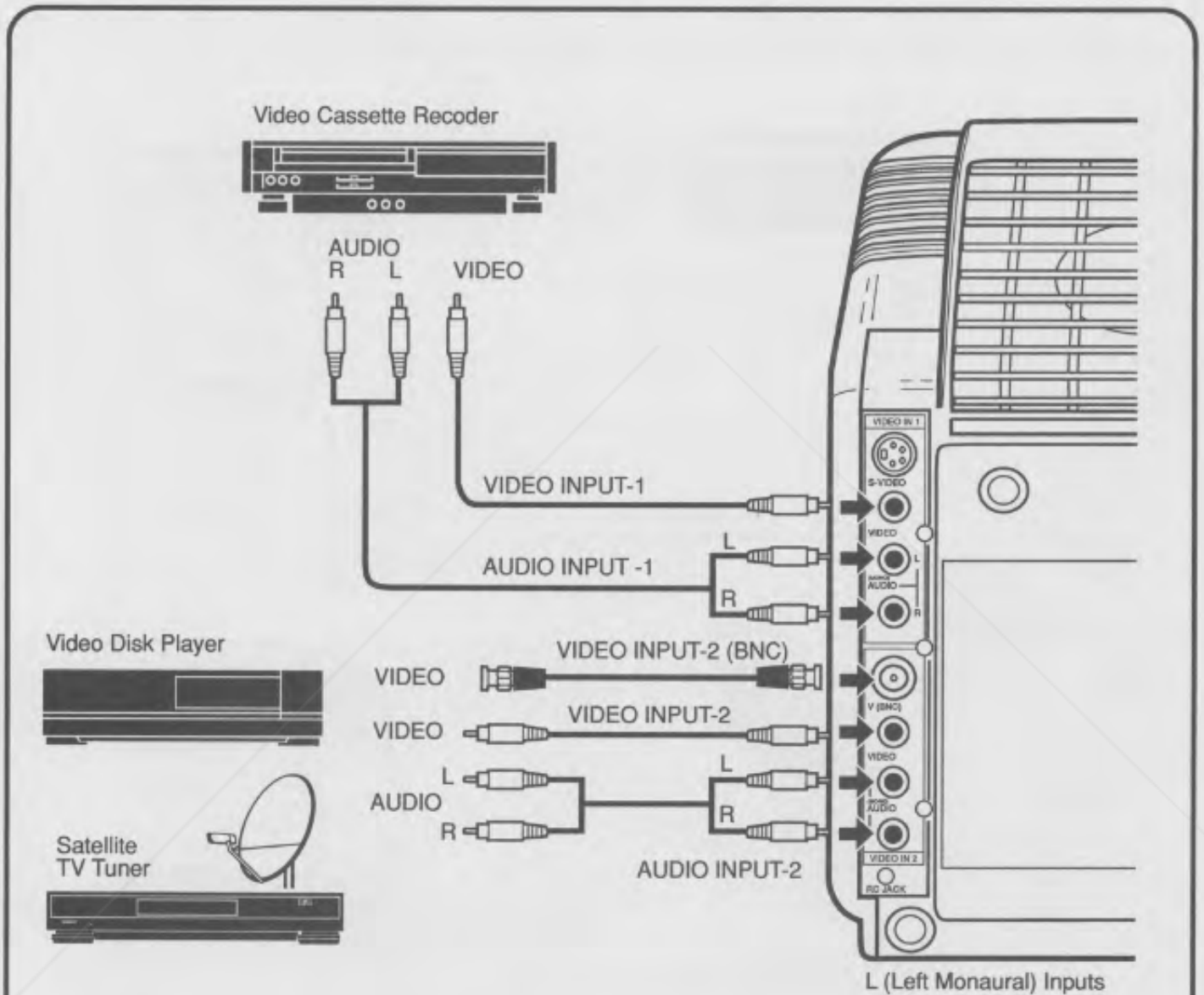
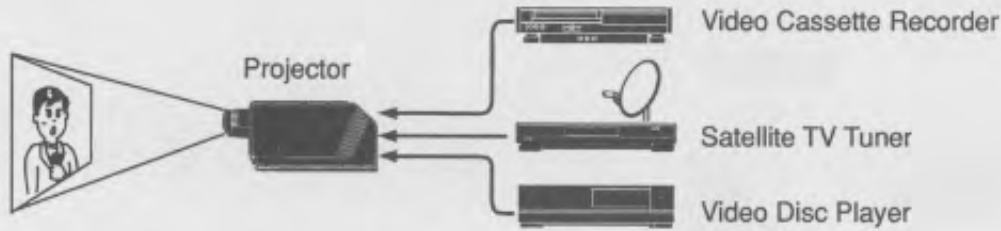

FixYourDLP.com

NOTE: Use composite video out for Satellite TV connection.

Do not connect the video sources to the VIDEO IN 2 (RCA) together with the BNC jack. Use one video input only for VIDEO IN 2.



DiscountMerchant.com (800) 281-8860

THE TRUSTED SOURCE FOR PROJECTOR LAMPS AND ACCESSORIES

10 CONNECTION TO S-VHS VCR

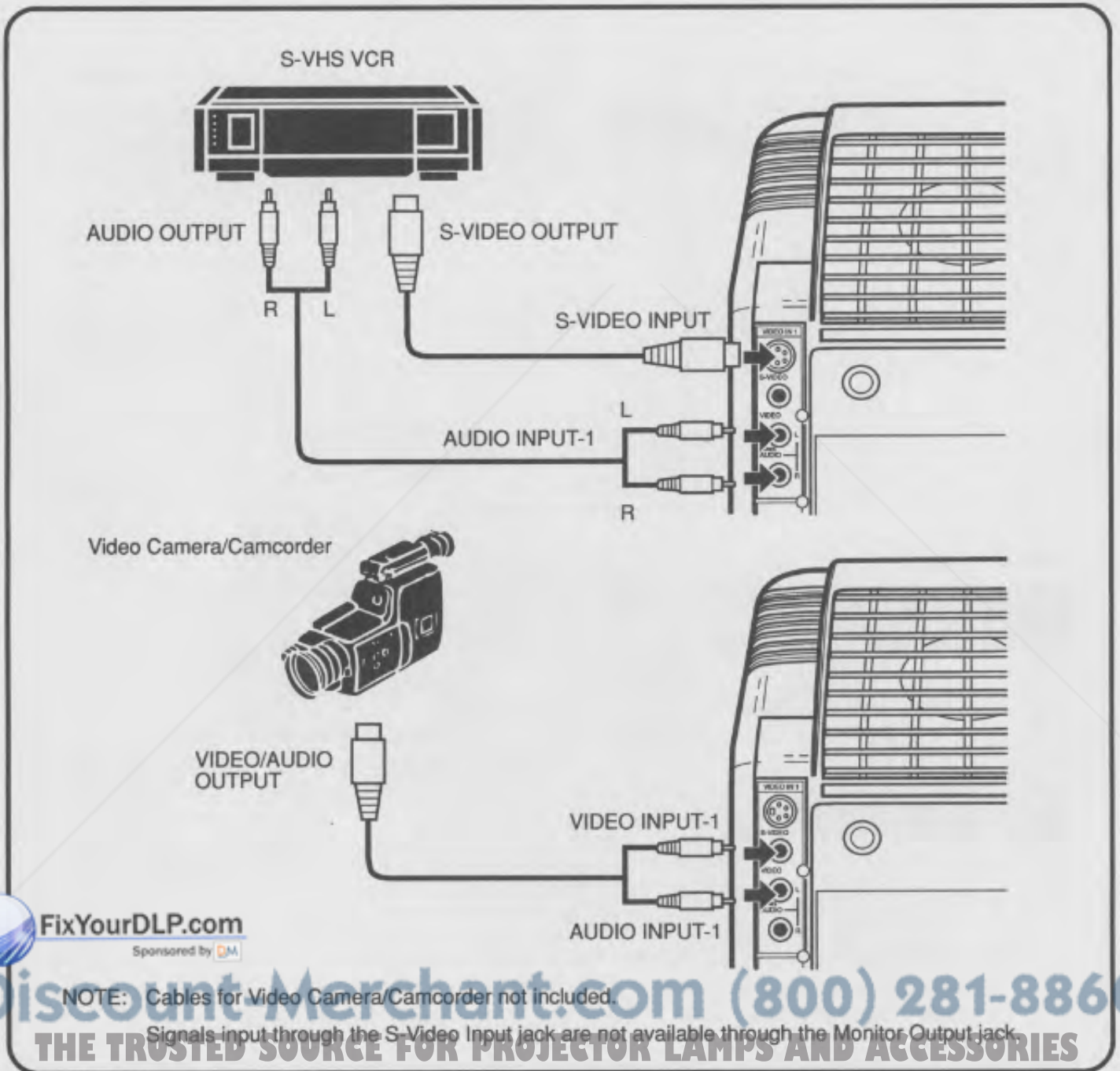
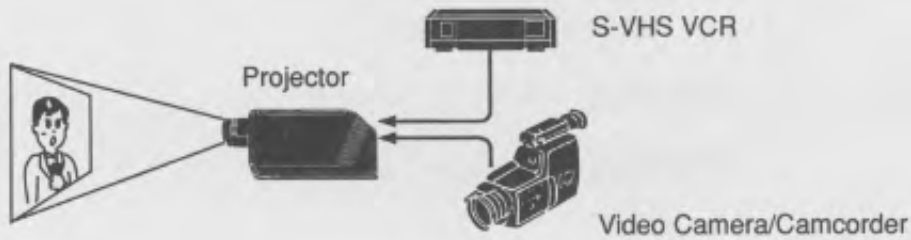
11 CONNECTION TO VIDEO CAMERA/CAMCORDER



 FixYourDLP.com
Sponsored by 

NOTE: Cables for Video Camera/Camcorder not included.

Signals input through the S-Video Input jack are not available through the Monitor Output jack.

Discount Merchant.com (800) 281-8860
THE TRUSTED SOURCE FOR PROJECTOR LAMPS AND ACCESSORIES

12 CONNECTION TO EXTERNAL SPEAKERS (WITHOUT AMPLIFIER)

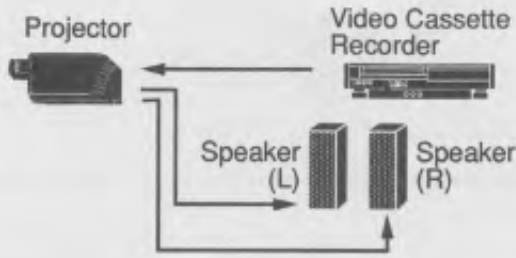

Video Cassette Recorder



AUDIO R L VIDEO OUT



This projector is provided with external speaker terminals. Connect the left speaker to the terminal marked LEFT (+) and the right speaker to the terminal marked RIGHT (+) and two (-) ground wires should be twisted together and connect to the (-) terminal on the projector.

RECOMMENDATION

Use five watts, 8 ohms speaker as external speaker.

Speaker (L)



Speaker (R)

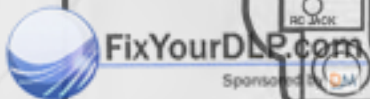

Discount-Merchant.com (800) 281-8860

THE TRUSTED SOURCE FOR PROJECTOR LAMPS AND ACCESSORIES

13 CONNECTION TO EXTERNAL AMPLIFIER & SPEAKERS

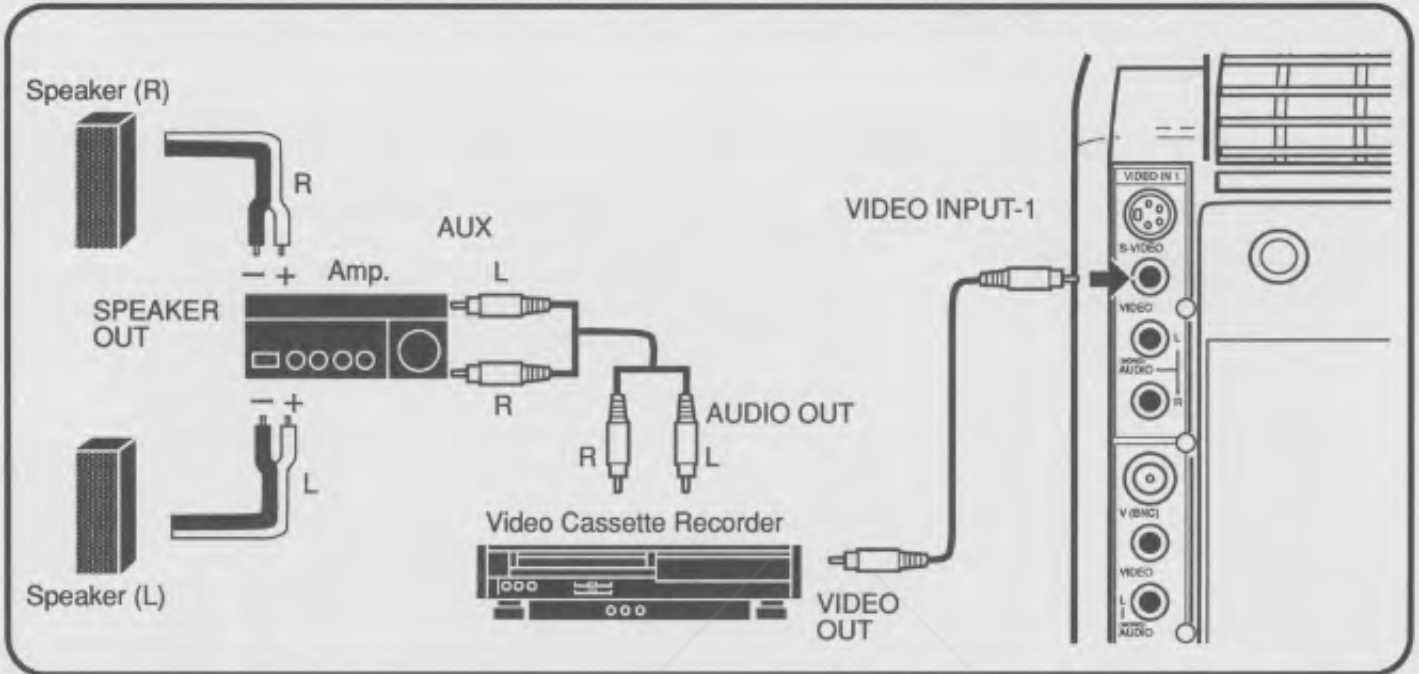
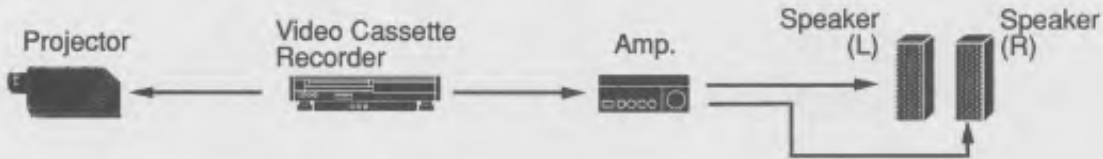

14 CONNECTION TO MONITOR OUTPUT

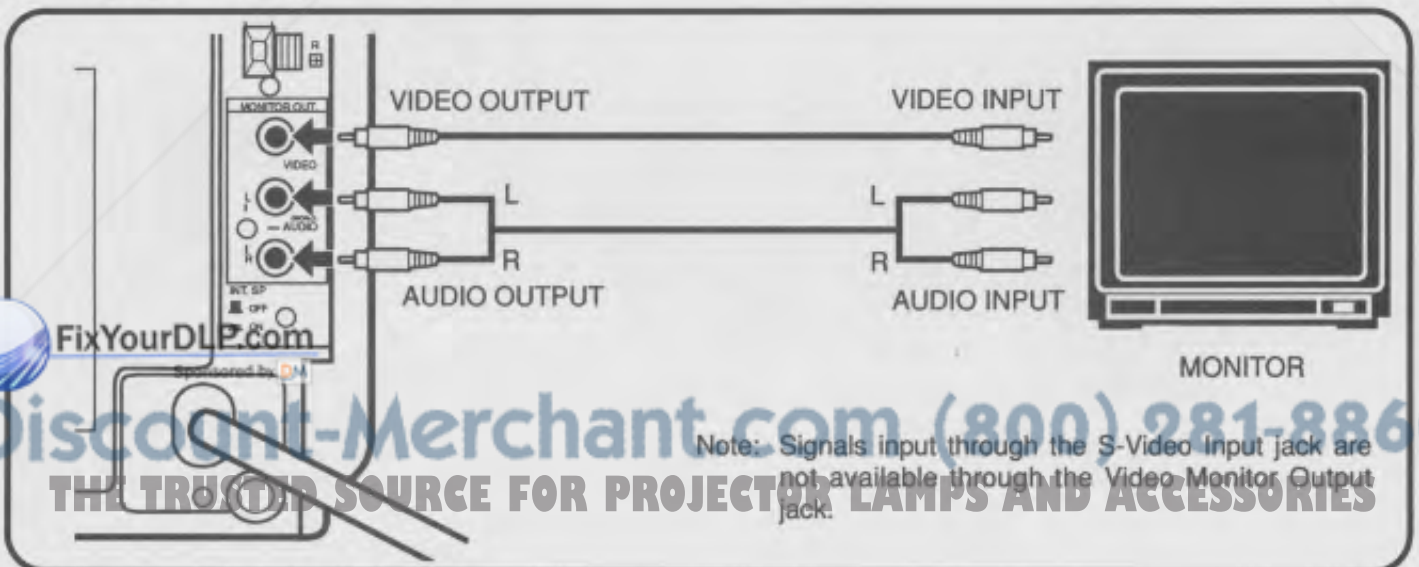
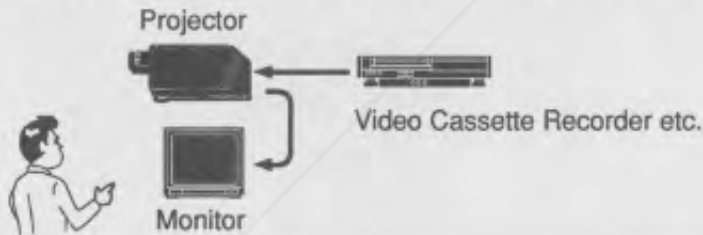

15 AIR FILTER CARE AND CLEANING

The removable air filter prevents dust from accumulating on the surface of the projection lens and projection mirror. Should the air filter become clogged with dust particles, it will reduce the cooling fan's effectiveness and may result in internal heat built up and reduced lamp life.

To clean the air filter, follow the cleaning procedures below:

1. Turn the POWER ON/OFF button OFF.
2. Remove the air filter cover from the side of the projector.
3. Remove the air filter and sponge from the filter cover.
4. Clean the air filter with a vacuum cleaner.
5. Replace the air filter. Make sure that it is fully inserted.

 Do not clean with water. Doing so may damage the air filter.
Do not operate the projector with air filter removed.

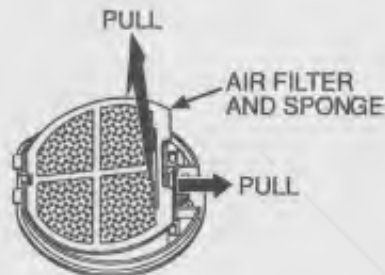
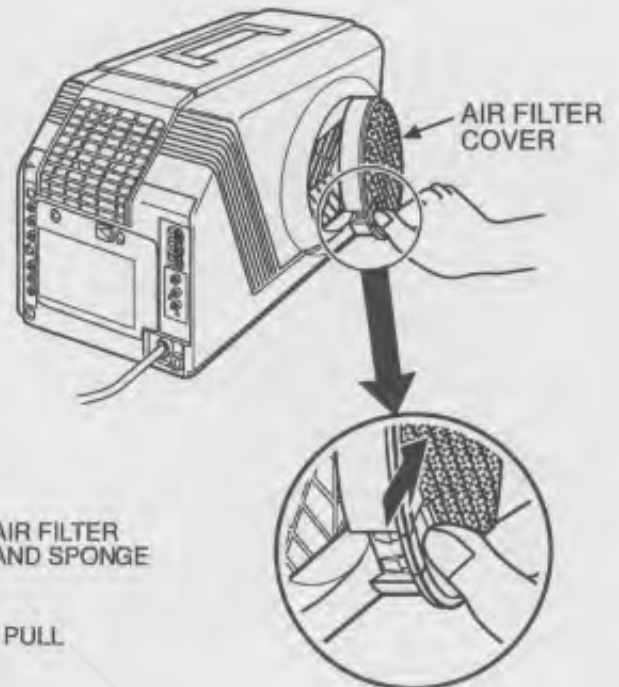

16 LAMP REPLACEMENT & TEMPERATURE WARNING INDICATORS

LAMP REPLACEMENT INDICATORS

When the lamp nears the end of its service life the picture quality and color quality will deteriorate and the lamp replacement indicator will light orange.

 DO NOT ATTEMPT TO REMOVE OR CHANGE THE PROJECTION LAMP. THE LAMP CAN ONLY BE CHANGED BY QUALIFIED SERVICE PERSONNEL.

TEMPERATURE WARNING INDICATOR

The TEMPERATURE WARNING INDICATOR lights red when the internal temperature of the projector exceeds the normal temperature.

Possible causes for the temperature warning may be:

1. Ventilation slots at the rear or bottom of the projector are blocked. In such an event, reposition the projector so that ventilation slots are not obstructed.

Air filter is clogged with dust particles. Remove dust from the air filter by following instructions in the Air Filter Care and Cleaning section above.

If temperature warning indicator remains on after performing the checks listed above, cooling fan/internal circuits may have malfunctioned. Request service from an authorized Eiki dealer or service station.

THE TRUSTED SOURCE FOR PROJECTOR LAMPS AND ACCESSORIES

17 TROUBLE SHOOTING GUIDE

Please perform these simple checks before calling for service.

SYMPTOMS	PROCEDURES
No power	<ul style="list-style-type: none">• Plug the projector into an AC outlet.• If STANDBY INDICATOR does not light green, check to be sure AC power is being supplied to the outlet.• Press the POWER ON/OFF button to ON.
No sound from internal speaker	<ul style="list-style-type: none">• Press the VOLUME (▲) and (▼) to (▲).• Press the INT. SPEAKER button to ON.• Check audio cable connection with audio input source.
Picture is reversed	<ul style="list-style-type: none">• Press the REVERSE PICTURE SCANNING button.
Picture blurred or color faded	<ul style="list-style-type: none">• Adjust the FOCUS control.• Adjust the ZOOM control.• Make sure the projector is at a 90° angle to the projection screen.• Move the projector closer to the screen. <p>NOTE: Moving the projector from a cool temperature location to a warm temperature location may result in moisture condensation on the lens. In such an event, leave the projector OFF and wait until condensation disappears.</p>



This symbol on the nameplate means the product is Listed by Underwriters' Laboratories Inc. It is designed and manufactured to meet rigid U.L. safety standards against fire, casualty and electrical hazards.

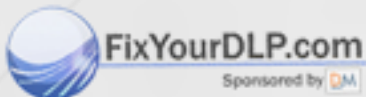

Discount-Merchant.com (800) 281-8860
THE TRUSTED SOURCE FOR PROJECTOR LAMPS AND ACCESSORIES

18 TECHNICAL SPECIFICATIONS

SPECIFICATIONS

Projector Type	Portable LC color video projector
Dimensions (H x W x D)	10" (253mm) x 8.9" (226mm) x 22.5" (572mm)
Net Weight	26.4 lbs. (12.0kg)
LCD Panel System	3.1" TFT Active Matrix type (Thin Film Transistor) x 3
Number of Pixels	331,350 (110,450 x 3)
Projection Image Size(Diagonal)	Adjustable from 25" to 300"
Contrast Ratio	100 : 1
Horizontal Resolution	450 TV lines
Projection Lens	f4.2 ~ 4.5 lens with 5.31" ~ 10.09" Motor-drive zoom and focus
Lens Aperture	2.64" (67mm)
Throw Distance	7.5' (2.3m)~ 44' (13.4m)
Projection Lamp	Metal Halide, 160 watt
Projection Mirror	Dichroic mirror system
NTSC Video Input Jacks	RCA type x 2, BNC type x 1,DIN 4 pin (S-Video) x 1
Monitor Video Output Jack	RCA type x 1
Line Audio Input Jacks	RCA type x 2
Monitor Audio Output Jack	RCA type x 1
External Speakers Jack	Stereo 3 pin type x 1
Internal Speaker	1.97" (50mm) x 3.54" (90mm) oval x 1
Amplifier	INT. SP. Monaural, 3 watt RMS (T.H.D. 10%) EXT.SP.Stereo, 5 watt/ch RMS (T.H.D. 10%)
Operating/Image Controls	Projection unit: Power ON/OFF, Volume, Zoom/Focus, Auto, Menu, Level Control, Video Mode, Superimpose, Picture Scanning, Blue Back ON/OFF, Keystone and INT. Speaker ON/OFF Remote Control unit: Power ON/OFF, Video Mode Volume, Volume Mute, Zoom, Focus, Auto, Menu Level Control, Expand and Keystone
LED Indicators	Power ON/OFF, Standby, Temperature Warning, Lamp Replacement
Image Elevation Adjustment	Up 5°, Down 5°
Rating Power Supply	120V AC, 50/60Hz
Power Consumption	250 Watts
AC Power Cord	Min. 10' (3m), SJT 3P-Grounding type plug
Operating Temperature	5°C ~ 35°C
Storage Temperature	-10°C ~ 60°C
Remote Control Battery	(3) AA type
Standard Accessories	Remote Control Unit, R/C Cable 5' (1.5m), Owner's Instruction Manual, Protective Dust Cover

FixYourDLP.com
 Operating Temperature
 Storage Temperature
 Remote Control Battery
 Standard Accessories

Discount-Merchant.com (800) 281-8860
THE TRUSTED SOURCE FOR PROJECTOR LAMPS AND ACCESSORIES

EIKI

Audio Visual/Video Products

EIKI INTERNATIONAL, INC.

26794 Vista Terrace Drive, Lake Forest, CA. 92630-8113
TEL (714) 457-0200 FAX (714) 457-7878

IN CANADA, EIKI CANADA
101 Thorncliffe Park Drive, Toronto, Ont. M4H 1M2
TEL (416) 467-1161 FAX (416) 467-6070



FixYourDLP.com

Sponsored by 

Discount-Merchant.com (800) 281-8860

THE TRUSTED SOURCE FOR PROJECTOR LAMPS AND ACCESSORIES

Printed in Japan

Part No. 610 239 9431 (4AA6P100565A-G8BA-A)

©1991 Eiki International, Inc.



Disclaimer

This user manual is provided as a free service by FixYourDLP.com. FixYourDLP is in no way responsible for the content of this manual, nor do we guarantee its accuracy. FixYourDLP does not make any claim of copyright and all copyrights remain the property of their respective owners.

About FixYourDLP.com

FixYourDLP.com (<http://www.fixyourdlp.com>) is the World's #1 resource for media product news, reviews, do-it-yourself guides, and manuals.

Informational Blog: <http://www.fixyourdlp.com>

Video Guides: <http://www.fixyourdlp.com/guides>

User Forums: <http://www.fixyourdlp.com/forum>

FixYourDLP's Fight Against Counterfeit Lamps:

<http://www.fixyourdlp.com/counterfeits>

Sponsors:

RecycleYourLamp.org – Free lamp recycling services for used lamps:

<http://www.recycleyourlamp.org>

Lamp Research - The trusted 3rd party lamp research company:

<http://www.lampresearch.com>

Discount-Merchant.com – The worlds largest lamp distributor:

<http://www.discount-merchant.com>



FixYourDLP.com

Sponsored by 