



# Disclaimer

This user manual is provided as a free service by FixYourDLP.com. FixYourDLP is in no way responsible for the content of this manual, nor do we guarantee its accuracy. FixYourDLP does not make any claim of copyright and all copyrights remain the property of their respective owners.

About FixYourDLP.com

FixYourDLP.com (<http://www.fixyourdlp.com>) is the World's #1 resource for media product news, reviews, do-it-yourself guides, and manuals.

Informational Blog: <http://www.fixyourdlp.com>

Video Guides: <http://www.fixyourdlp.com/guides>

User Forums: <http://www.fixyourdlp.com/forum>

FixYourDLP's Fight Against Counterfeit Lamps:

<http://www.fixyourdlp.com/counterfeits>

## Sponsors:

RecycleYourLamp.org – Free lamp recycling services for used lamps:

<http://www.recycleyourlamp.org>

Lamp Research - The trusted 3rd party lamp research company:

<http://www.lampresearch.com>

Discount-Merchant.com – The worlds largest lamp distributor:

<http://www.discount-merchant.com>



**FixYourDLP.com**

Sponsored by 

# EIKI

**INTERACTIVE PROJECTOR**

---

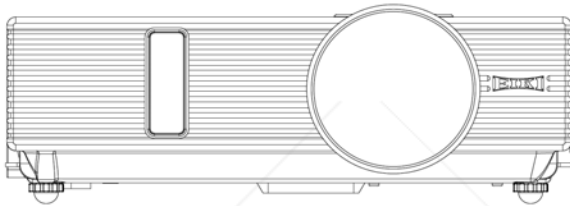

## LC-XIP2600

# OWNER'S MANUAL



**Discount-Merchant.com (800) 281-8860**

**THE TRUSTED SOURCE FOR PROJECTOR LAMPS AND ACCESSORIES**

## Projector

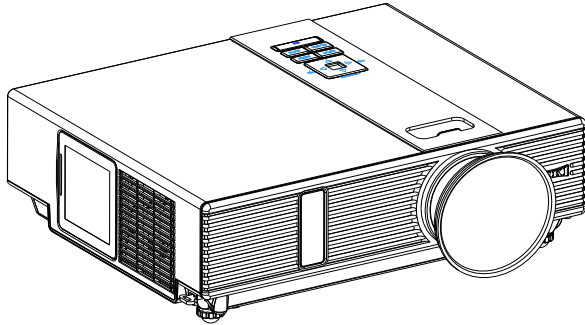

### About the Owner's Manual

Please read the owner's manual thoroughly to ensure correct usage of the projector and its features.

After reading, store the owner's manual in a safe place for future reference.

### Features

1. Dress up Design
2. Designed for tough environment
3. Side change lamp
4. Side change filter
5. Quick power off
6. Advanced Anti-theft features
7. Five auto features (Auto Search, Auto Sync, Auto Ceiling, Auto Keystone and Auto Filter Alert)
8. Seven display modes (Natural, Cinema, Daylight, Green board, White Board, Black Board and User)
9. Built-in 8W speaker
10. Logo capture
11. Image freeze function
12. Digital zoom adjustment
13. Built-in interactive smart function.
14. Extreme Short Throw Distance.

The content of this manual is subject to change without prior notice.

All rights reserved.

Issue of edition 0901.05\_01

# Contents

## About Owner's Manual

<b>Contents .....</b>	<b>1</b>
<b>Contents of Your Box .....</b>	<b>3-A</b>
<b>Safety Instructions .....</b>	<b>4</b>
<b>Safety Labels.....</b>	<b>8</b>
<b>Part Names .....</b>	<b>9</b>
Projector.....	9
Control Panel.....	10
Rear.....	11
<b>Setting Up .....</b>	<b>12</b>
Arrangement.....	12
Power ON / OFF.....	13
Setting Up The Projector .....	14
Ceiling Mounted Installation Guide .....	15
Adjusting The Projector's Elevation .....	16
How To Connect.....	17
<b>Remote Control .....</b>	<b>19</b>
<b>Menu Operation.....</b>	<b>21</b>
How To Operate On-Screen Display .....	21
<b>MENU (PC Mode).....</b>	<b>22</b>
Picture Menu (PC Mode).....	22
Audio Menu (PC Mode).....	23
Setting Menu (PC Mode).....	24
<b>MENU (Video Mode) .....</b>	<b>25</b>
Picture Menu (Video Mode).....	25
Audio Menu (Video Mode) .....	26
Setting Menu (Video Mode).....	27



FixYourDLP.com

Discount-Merchant.com (800) 281-8860

THE TRUSTED SOURCE FOR PROJECTOR LAMPS AND ACCESSORIES

# Contents

<b>MENU .....</b>	<b>28</b>
Advanced Menu.....	28
Presentation Menu.....	31
Security Menu.....	33
PIN Key In Operation.....	36
<b>Network Control Software Application .....</b>	<b>37</b>
<b>Before Use .....</b>	<b>38</b>
Before Using Network Control Software .....	38
Projector Auto Search.....	39
Modify the Projector Setting .....	41
<b>Registering And Configuring the Projector.....</b>	<b>42</b>
Delete.....	42
Projector Setting .....	43
System Setting.....	44
Monitor / Default Setting / Auto Scan Timer.....	45
Link.....	47
<b>Control Panel Window Introduction.....</b>	<b>48</b>
Power Control / Input Source / Function Key .....	48
Function Key / Projector Status.....	49
Network Control Window Introduction.....	50
<b>Maintenance Of Projector .....</b>	<b>51</b>
Air Filter / Replacing the Air Filter .....	51
Lamp / Replacing New Lamp.....	53
Other Care.....	55
<b>Troubleshooting.....</b>	<b>56</b>
Indicator.....	56
Error For Machine Defects.....	57
List of Supported Monitor Displays .....	59
<b>Appendix</b>	
Please refer "Interactive Function Manual" regarding the "Interactive Function".	

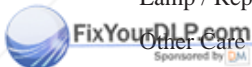

Discount-Merchant.com (800) 281-8850

THE TRUSTED SOURCE FOR PROJECTOR LAMPS AND ACCESSORIES

# Contents of Your Box

Please make sure that following items are included in the box. If any items are missing, contact your dealer please..

## 1. Projector

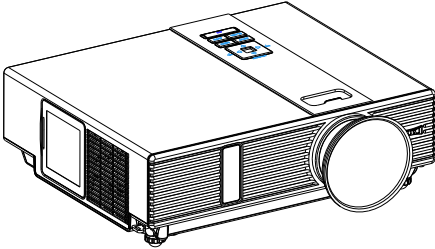

## 2. Computer cable

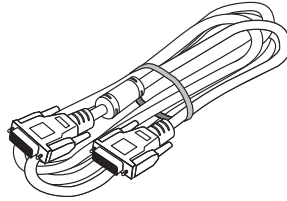

## 3. Power cord

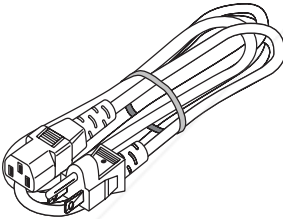

## 4. Quick Start Guide

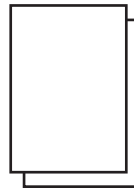

## 5. Owner's Manual CD



## 6. Remote control



Discount-Merchant.com (800) 281-8860  
THE TRUSTED SOURCE FOR PROJECTOR PARTS AND ACCESSORIES

## Contents of Your Box

### 7. USB Cable

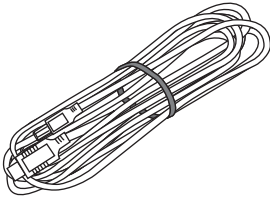

### 8. Interactive Kit

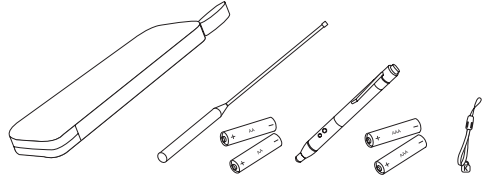

**Discount-Merchant.com (800) 281-8860**  
**THE TRUSTED SOURCE FOR PROJECTOR LAMPS AND ACCESSORIES**

## Safety Instructions

The projector is designed and tested to meet the latest standards for safety of information technology equipment. However, to ensure safe use of this product, it is important that you follow the instructions mentioned in this manual and marked on the product.



### **WARNING**

This symbol indicates information that, if ignored, could possibly result in personal injury or even death.



### **CAUTION**

This symbol indicates information that, if ignored, could result in personal injury or physical damage.

## Typical Symbols



This symbol indicates an additional warning (including cautions). An illustration is provided to clarify the contents (for example: the illustration to the left indicates danger of electrical shock).



This symbol indicates a prohibited action. The contents will be clearly indicated in an illustration or description near the symbol (for example: the symbol to the left indicates that disassembly is prohibited).



This symbol indicates a compulsory action. The contents will be clearly indicated in an illustration or description near the symbol (for example: the symbol to the left shows that the power plug should be disconnected from the power outlet).



**Discount-Merchant.com (800) 281-8860**  
**THE TRUSTED SOURCE FOR PROJECTOR LAMPS AND ACCESSORIES**



## Safety Instructions

### **WARNING**

#### **If a problem should occur**

If smoke or strange odors arise, continued use could result in fire or electrical shock. In such case, immediately turn off the power switch and then disconnect the power plug from the power outlet. After making sure that the smoke or odor has stopped, contact your dealer for repairs. Never attempt to make repairs yourself because this is dangerous.

Do not use this projector if there is no image or sound, or if the sound is distorted. Continued use could result in fire or electrical shock. In such case, immediately turn off the power switch; disconnect the power plug from the power outlet and contact your dealer.

If water would enter the inside of this projector, immediately turn off the power switch, disconnect the power plug from the power outlet and contact your dealer.

#### **Do not install on an unstable surface.**

Do not install this projector on an unstable surface such as a wobbly stand or incline because this could result in the projector falling and causing injury.



#### **Do not open the cabinet.**

Never open the cabinet. There is high voltage inside which can cause electrical shock. Contact your dealer for internal inspection, adjustment and repair.



#### **Do not modify.**

Do not modify this projector because this could result in fire or electrical shock.



Do not place the projector upon either side to project an image.

**NO SIDEWARD**



Do not point the projector down to project an image.

**NO DOWNWARD**

#### **Do not use in the bathroom or near water site.**

Do not expose this unit to rain or use near water... for example, in the bathroom, a wet basement, near a swimming pool, etc...

#### **Do not insert objects into the Projector.**

Do not insert metal objects through the ventilation openings, etc., of this projector or drop such objects inside because this could result in fire or electrical shock.

**If a foreign object should enter this projector, immediately turn off the power switch, disconnect the power plug from the power outlet and contact your dealer.**

Continued use could result in fire or electrical shock. Use special caution in household and where children are present.

## Safety Instructions

### **WARNING**

#### **Do not look through the lens when the lamp is on.**

Never look through the lens when the lamp is on. The powerful light could adversely affect vision. Use special caution in households where children are present.



#### **Avoid shock or impact on the projector.**

If the projector should fall, resulting in damage to the cabinet, immediately turn off the power switch, disconnect the power plug from the power outlet and contact your dealer.



Continued use could result in fire or electrical shock.

#### **Do not place this projector in a container containing liquid. Do not place flower vases, flowerpots, cups, cosmetics, liquids such as water, etc., on top of this projector.**

#### **Do not use any power cable except those supplied with the projector.**

The use of any other power cable could result in fire or electrical shock.

#### **Do not shine the laser beam onto yourself or other.**

The laser pointer function of projector remote control emits class II laser beam.

Do not look directly into the laser beam outlet or direct the laser beam at other people.

Vision can be impaired if the laser beam enters the eyes. Especially pay attention if children are present.

#### **High temperatures are generated when the lamp is lit; so do not place objects in front of the lens.**

Allowing the proper amount of space on the top, sides, and rear of the projector cabinet is critical for proper air circulation and cooling of the unit.

The dimension shown here indicate the minimum space required. If the projector is to be built into a compartment or similarly enclosed, these minimum distances must be maintained.



Side and Top

Rear

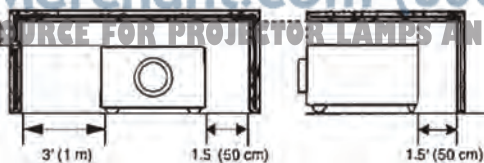

## Safety Instructions



### CAUTION

Placing heavy objects on top of this projector could result in loss of balance or falling and cause personal injury or damage the projector.



**Do not block the ventilation openings.**

**Do not block the ventilation openings of this projector.**

Blocking ventilation could lead to internal overheating which could result in fire.

Do not place this projector on its side during use or push it into a small, poorly ventilated location.

Do not place this projector on a carpet or bedding or cover it with a tablecloth, etc.

### Care and maintenance.

For safety purposes, disconnect the power plug from the power outlet before starting the care and maintenance of this projector.



### Battery usage.

**Replace the batteries with the same type only.**

Do not mix old and new batteries; this could result in fire or personal injury due to battery cracking or leakage.

**Make sure the plus and minus terminals are correctly aligned when loading the batteries.**

Incorrect loading could result in personal injury or contamination of the surroundings due to battery cracking or leakage.



**Have the projector interior cleaned regularly.**

**Contact your dealer to arrange for the service.**

Accumulations of dust inside the projector can result in fire or malfunction if not cleaned for an extended period.

Ask your dealer for details about internal cleaning.

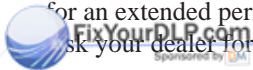

Discount-Merchant.com (800) 281-8860

THE TRUSTED SOURCE FOR PROJECTOR LAMPS AND ACCESSORIES



# Safety Labels

Safety labels are used on or within the projector to alert you to items or areas requiring your attention.

## WARNING LABEL

 <b>WARNING</b> 	 <b>WARNUNG</b> 	 <b>AVIS</b> 
<ul style="list-style-type: none"> <li>• BEFORE OPERATING, PLEASE READ USER'S MANUAL.</li> <li>• BEFORE REMOVING SCREWS, DISCONNECT POWER CABLE.</li> <li>• DO NOT BLOCK VENTING OPENINGS.</li> </ul>	<ul style="list-style-type: none"> <li>• VOR DEM EINSATZ DIE BEWECHENSANLEITUNG LESEN.</li> <li>• VOR DEM ENTFERNEN DER SCHRAUBEN DAS NETZKABEL ABTRENENNEN.</li> <li>• LÜFTUNGSÖFFNUNGEN NICHT BLOCKIEREN.</li> </ul>	<ul style="list-style-type: none"> <li>• VEUILLEZ LIRE LE MODE D'EMPLOI AVANT L'USAGE.</li> <li>• DÉBRANCHER LE CÂBLE D'ALIMENTATION AVANT DE RETIRER LES VIS.</li> <li>• NE BOUCHEZ PAS LES ORIFICES DE VENTILATION.</li> </ul>
<ul style="list-style-type: none"> <li>• この製品は、高圧のランプを内蔵しています。誤ってランプを取り出すと、高圧電圧が危険な場合があります。</li> <li>• ランプ交換を行う前に、必ず電源プラグをコンセントから抜いてください。</li> </ul>	<ul style="list-style-type: none"> <li>• 操作時、過熱部を直接触ると怪我の原因となります。</li> <li>• 高圧電圧が危険な場合があります。</li> <li>• ランプは、同じタイプのものを交換してください。誤った取り扱いをしたときに、高圧ランプが破裂する恐れがあります。</li> <li>• 水や油で汚れないでください。</li> <li>• フリカをはずした状態で電源を入れないでください。</li> <li>• 如果不正当地处理灯具也会产生故障。</li> <li>• 请勿用水或清洗剂清洗透镜。</li> <li>• 请勿乱摸透镜。请勿操作投影机。</li> </ul>	<ul style="list-style-type: none"> <li>• 操作時、過熱部を直接触ると怪我の原因となります。</li> <li>• 高圧電圧が危険な場合があります。</li> <li>• ランプは、同じタイプのものを交換してください。誤った取り扱いをしたときに、高圧ランプが破裂する恐れがあります。</li> <li>• 水や油で汚れないでください。</li> <li>• フリカをはずした状態で電源を入れないでください。</li> <li>• 如果不正当地处理灯具也会产生故障。</li> <li>• 请勿用水或清洗剂清洗透镜。</li> <li>• 请勿乱摸透镜。请勿操作投影机。</li> </ul>
<p><small>USA ONLY: This product contains mercury. Disposal of mercury may be regulated due to environmental considerations. For disposal/recycling information, please contact your local authorities or the Electronic Industries Alliance: www.eia.org.</small></p>		

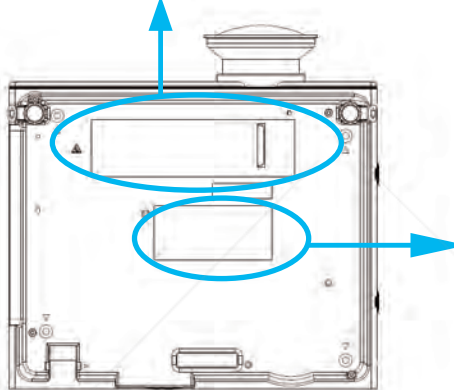

## EMI Label



## LAMP DOOR WARNING LABEL

 <b>CAUTION HOT</b>	 <b>ATTENTION CHAUD</b>
<p>TURN THE POWER OFF AND WAIT 1 HOUR BEFORE CHANGING THE LAMP.</p> <p><b>WARNING HEISS!</b> SCHALTEN SIE DAS GERÄT AUS UND WARTEN SIE 1 STUNDE BIS SIE DIE LAMPE WECHSELN.</p>	<p>COUPER L'ALIMENTATION ET ATTENDRE 1 HEURE AVANT DE CHANGER LA LAMPE.</p> <p><b>高温注意</b> ランプ交換は、電源を切った後、1時間待ってから行ってください。 关闭投影机电源后，必须冷却至少1小时后才进行更换灯泡。</p>
 <b>CAUTION</b>	 <b>ATTENTION</b>
<p>SPONSORED BY  <b>FixYourDLP.com</b></p> <p>HIGH-PRESSURE LAMP MAY EXPLODE IF IMPROPERLY HANDLED.</p> <p>REPLACE WITH SAME TYPE NUMBER LAMP. DO NOT CLEAN THE AIR FILTER WITH WATER OR ANY LIQUID.</p> <p>DO NOT OPERATE THE PROJECTOR WITH THE LAMP DOOR OPEN.</p> <p><b>VORSICHT!</b> DIE HOCHDRUCKLAMPE KANN BEI FALSCHER HANDHABUNG EXPLODIEREN. NUR MIT EINER LAMPE DES GLEICHEN TYPES AUSTAUSCHEN; VERWENDEN SIE ZUR REINIGUNG DES LÜFTFILTERS WEDER WASSER NOCH ANDERE FLÜSSIGKEITEN. BETRIEBEN SIE IHREN PROJEKTOR NICHT OHNE DEN LÜFTFILTERS.</p>	<p>LA LAMPE À HAUTE PRESSION PEUT EXPLOSER SI ELLE EST MANIPULÉE INCORRECTEMENT.</p> <p>REMPLEZ PAR UNE LAMPE AVEC UN NUMÉRO DE TYPE IDENTIQUE.</p> <p>N'UTILISEZ PAS D'EAU NI D'AUTRE LIQUIDE POUR NETTOYER LE FILTRE À AIR. NE FAITES PAS FONCTIONNER VOTRE PROJETEUR AVEC LA PORTÉE DE LA LAMPE OUVERTE.</p> <p>高圧のランプを交換する際は、必ず電源を切った後、1時間待ってから行ってください。 关闭投影机电源后，必须冷却至少1小时后才进行更换灯泡。</p> <p>如果不正当地处理灯具也会产生故障。</p> <p>请勿用水或清洗剂清洗透镜。</p> <p>请勿乱摸透镜。请勿操作投影机。</p>

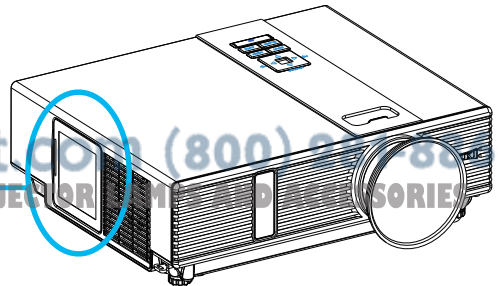

# Projector

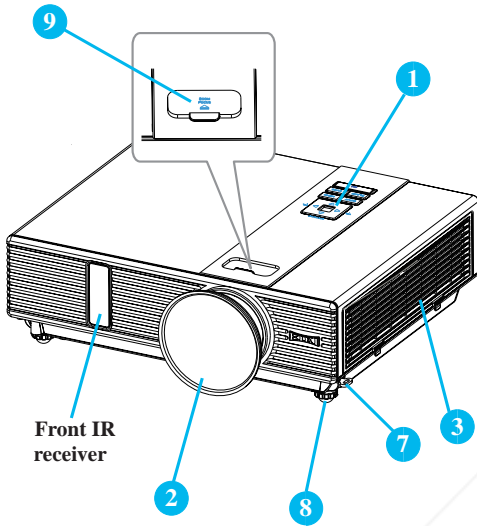

Front IR receiver

**1 Control panel**

Operating system.

**2 Lens Cover**

Attach when not using to protect the lens from becoming dirty or damaged.

**3 Filter cover**

Prevents dust and other foreign particles from being drawn into projector.

Remove the filter cover to clean the air filter.

**4 Focus ring**

Use the focus ring to focus the projector image.

Rotate the focus ring until the image is clear.

**5 Zoom ring**

Use the zoom ring to adjust the size of the projected image.

Rotate the zoom ring until the image is the desired size.

**6 Lamp door**

The lamp unit is inside.

**7 Foot adjust button**

Lock / unlock the adjustable foot.

**8 Front adjustable foot**

Extend and retract to adjust the projection angle.

**9 Gate Plate**

Dustproof function.

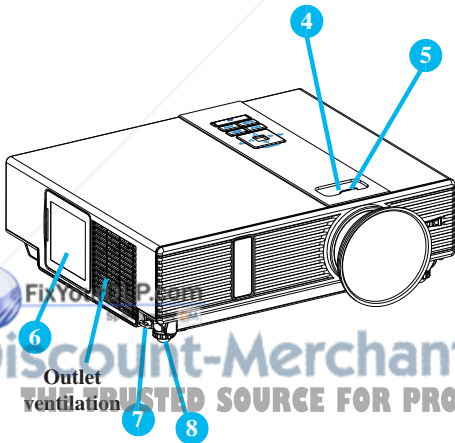

Outlet ventilation

## Control Panel

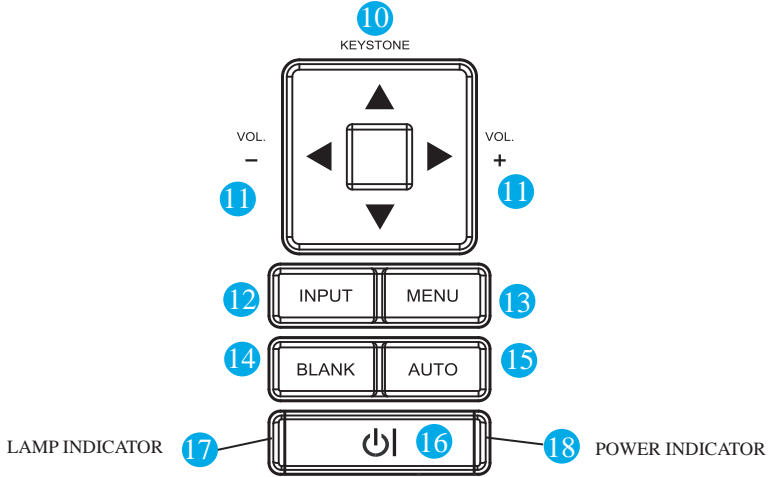

### 10 KEystone

Adjust the vertical keystone.

### 11 VOLUME + / -

Sound louder or lower.

### 12 INPUT

Select input source:



**Note :**

If the projector can not be captured the signals within 15 minutes, it will be shut down automatically.

### 13 MENU

Display or hide the OSD main menu.

### 14 BLANK

Blank the projected image. The time of Blank mode can be set in 15 minutes, 30 minutes or 60 minutes. The projector will shut down automatically after passing each set time.

### 15 AUTO

Automatically adjust the setting to match the current input.

### 16 (POWER)

Power On / Off.

### 17 LAMP INDICATOR

Indicate a status in the projector.

### 18 POWER INDICATOR

Light on or flash to indicate the operating status of the projector.

Rear

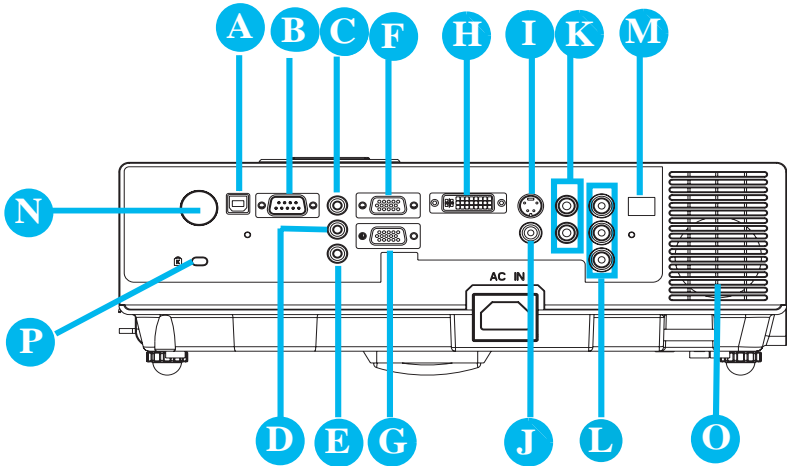

**A USB**

Connect the USB cable to a computer to utilize the Interactive functions.

**B RS232**

Serial data port for controlling the projector with a computer or other RS-232 control device.

**C AUDIO IN 1 & D AUDIO IN 2**

Mini jack port corresponds to computer input. (RGB IN→AUDIO IN 1, DVI-1 IN→AUDIO IN 2)

**E AUDIO OUT**

This jack outputs the audio signal from computer signal to external audio equipment.

**F RGB IN**

Input analog RGB signal from a computer.

**G RGB OUT**

Connect an external monitor to this connection to view the "RGB IN" input.

**H DVI-I IN**

Input digital DVI-I signal from a computer.

**I S-VIDEO**

S-Video signal from a video source.

**J VIDEO**

Composite video signal from a video source.

**K AUDIO IN 3, R / L**

RCA type corresponds to video input.

**L COMPONENT ( Y, Pb, Pr / Y, Cb, Cr)**

Input Component signal from a DVD player.

**M LAN**

Please see page 37 Network Control Application for details.

**N REAR IR RECEIVER**

**O SPEAKER**

**P Slot for Kensington Micro Saver Security System**

**Built-in Security Slot**

This security slot supports the MicroSaver® Security System. MicroSaver® is a registered trademark of Kensington Microware Inc. The logo is trademarked and owned by Kensington Microware Inc.

## Setting Up

### Arrangement

1. Before installation, make sure that the projector is turned off and the power cord is disconnected.
2. Do not set up and move the projector, while it is hot.
3. The distance between the projector and screen determines the actual image size. Refer to the table below to determine the screen size at a given distance.

**Note: The dimensions in the table below are approximate.**

Screen size (diagonal)		Distance (m)		Distance (feet)	
inch	m	Tele	Wide	Tele	Wide
40	1.0	0.95	0.77	3.13	2.53
60	1.5	1.45	1.18	4.74	3.88
70	1.8	1.69	1.39	5.55	4.56
80	2.0	1.94	1.59	6.36	5.23
100	2.5	2.43	2.01	7.98	6.58
150	3.8	3.67	3.03	12.03	9.95
200	5.1	4.90	4.06	16.07	13.32
250	6.4	6.13	5.09	20.12	16.69
300	7.6	7.37	6.12	24.16	20.06

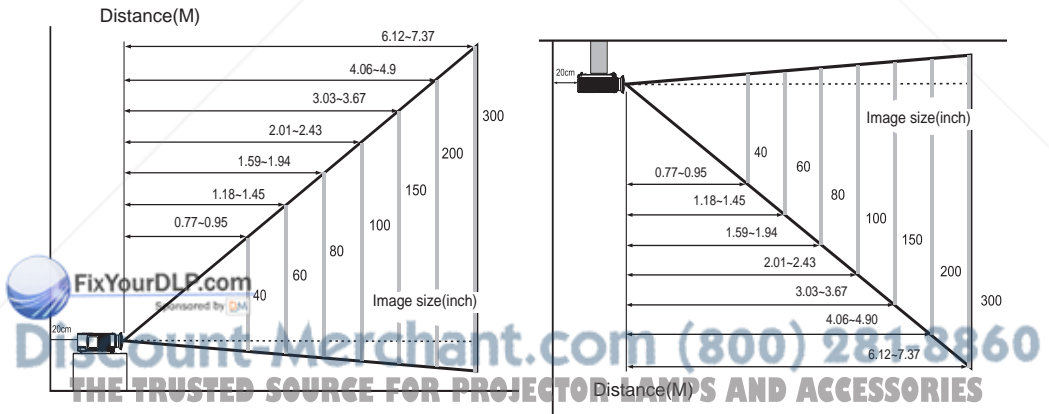

When installed against a wall, leave about 20cm (7.9in.) between the projector and the wall.



## Setting Up

### Power ON / OFF

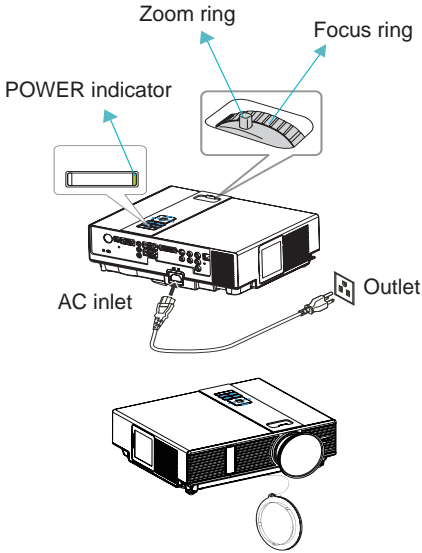

### Turning On The Power

1. Make sure that power cord is firmly and correctly connected to the projector.
2. The green Power indicator blinks slowly.
3. Remove the lens cover.
4. Press POWER button on the control panel or the remote control to turn on the projector.
5. Rotate the zoom ring to adjust the screen size.
6. Rotate the focus ring to adjust the focus.

#### ! WARNING

- ★ A strong light is emitted when the projector's power is on. Do not look into the lens of the projector or look inside of the projector through any of the projector's openings.

1.



2.

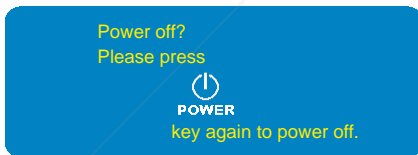

3.-4.



5.

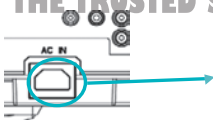

### Turning Off The Power

1. Press the POWER button on the control panel or the remote control. The "power off" confirmation message will appear.
2. Press the POWER button again while the message is shown on the screen.
3. When the projector enters "Standby" mode, the green Power indicator blinks slowly.
4. The projector cannot be turned on while red "Lamp indicator" is blinking slowly in cooling mode.
5. If you don't use the projector for a long time, remove power cord.

#### ! WARNING

- ★ Do not touch around the lamp cover and the exhaust vents during use or just after use, since it is too hot.

#### ! CAUTION

- ★ Do not turn off the AC power for 60 seconds after the lamp is turned on. Doing so could cause premature lamp failure.

## Setting Up

### Setting Up The Projector

The projector supports the following four different projection methods.

#### 1. Front projection

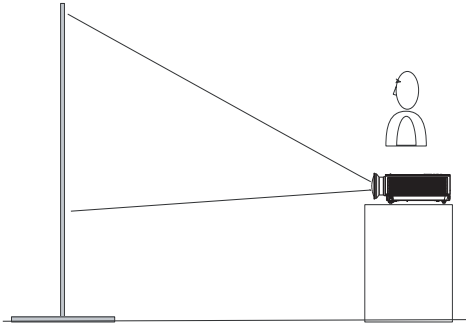

#### 3. Rear ceiling projection

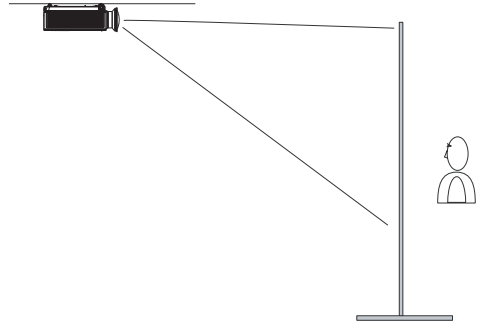

#### 2. Rear projection

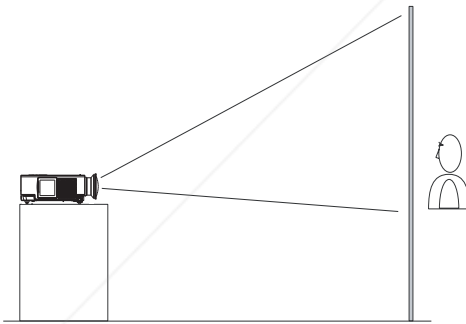

#### 4. Front ceiling projection

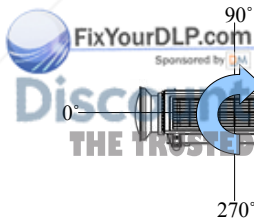
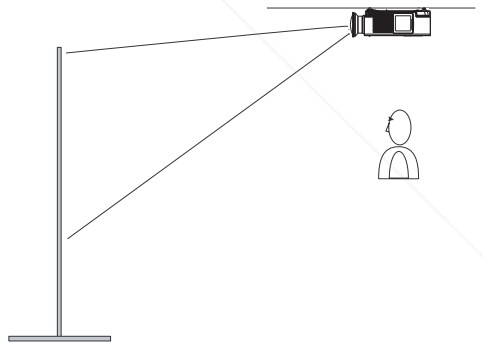

The projector can be installed pitched by any angle (360 degree) without any setting in fan mode. As for rolling it must be within 10 degree.

Special installation is required in order to suspend the projector from the ceiling. Please ask your dealer for details.

### Ceiling Mounted Installation Guide

Attach ceiling mount at four-suspension bracket fixing points when suspending from a ceiling. Special installation is required in order to suspend the projector from the ceiling. Please ask your dealer for details.

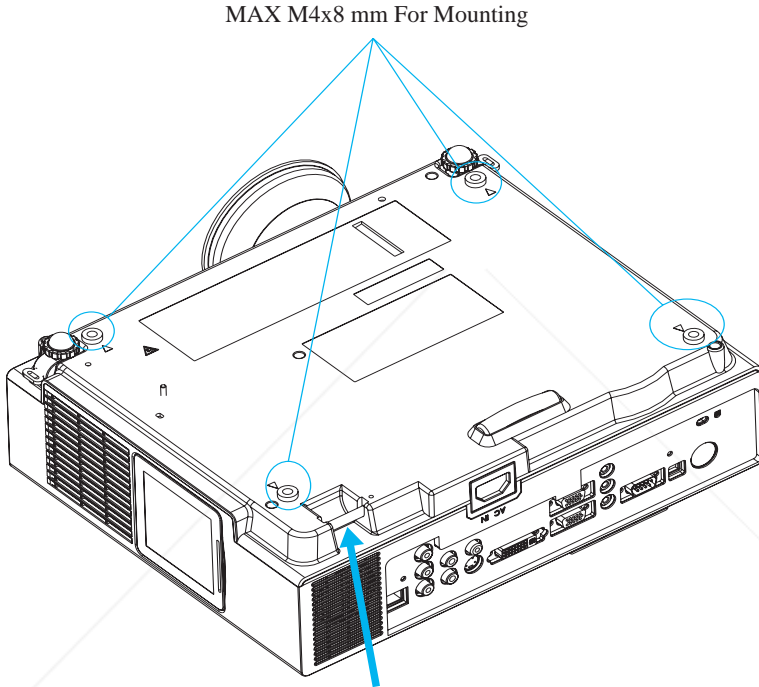

#### Security Anchor

The product is equipped with security anchor and PIN LOCK (See page 33 for details) functions to help prevent unauthorized removal of the projector.



Discount-Merchant.com (800) 281-8860



#### WARNING

- ▶ Do not grasp the security anchor to carry projector, since it is not designed for it.
- ▶ The security anchor is not for comprehensive theft prevention measures. It is intended to be used as supplemental theft prevention measure.

### Adjusting The Projector's Elevation

Use the adjustable foot at the front of the projector to set the image height.

- 1 Holding the projector, push the foot adjust buttons to loosen the front adjustable foot.
- 2 Position the front side of the projector to the desired height.
- 3 Release the foot adjust buttons in order to lock the front adjustable feet.
- 4 Please make sure that the front adjustable feet are locked.
- 5 Please rotate the adjustable feet when fine adjustment of tilt is needed.

#### CAUTION

- \* The adjustment range of front adjustable foot is 0 to 8.5 degrees.
- \* When the foot is adjusted, it may cause the shape of the projected image to become distorted. Use the keystone correction function to correct this distortion.

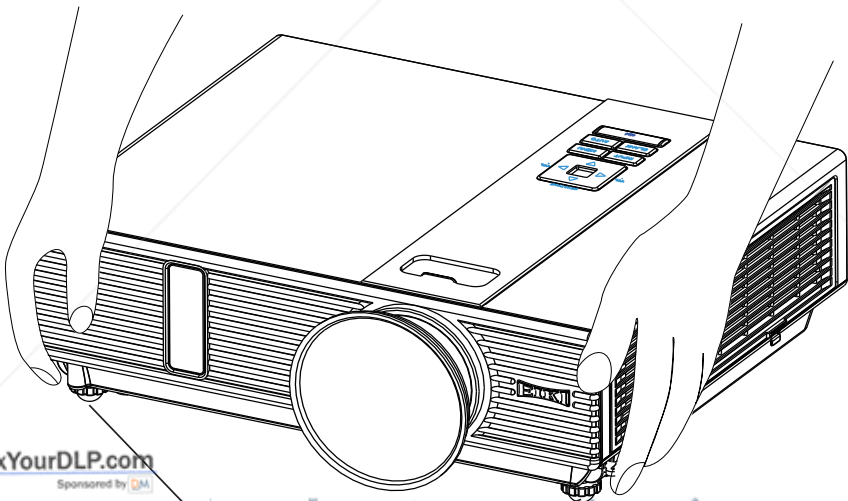

## How To Connect

Laptop or desktop computer

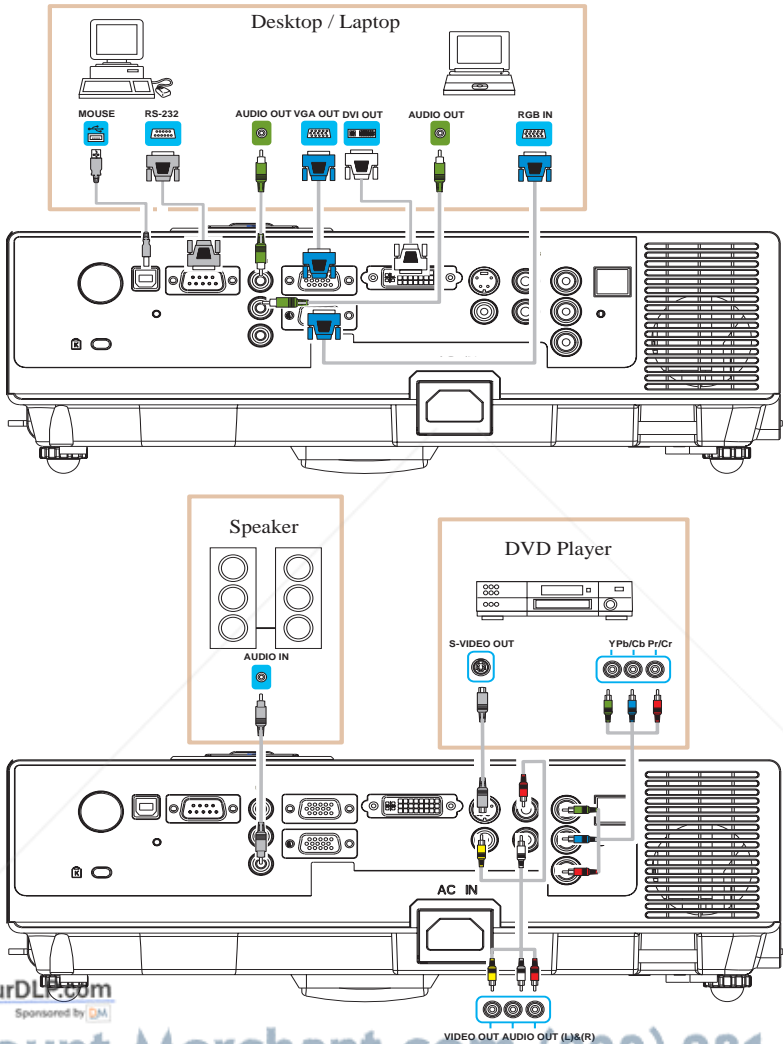

Before starting, make sure that the projector and computer are both turned off.

**THE TRUSTED SOURCE FOR PROJECTOR LAMPS AND ACCESSORIES**

### Connect the computer

Connect the computer cable from the computer to the projector's RGB IN or DVI-I IN. Connect a computer cable from the MONITOR OUT to an external monitor to view the signal on RGB IN or DVI-I IN. Tighten the screw on all connectors.

### How To Connect

Laptop or desktop computer

#### Connect the audio cable if necessary

1. Please connect the audio cable to the AUDIO IN 1 if the computer cable is connected to the projector's RGB IN.
2. Please connect the audio cable to the AUDIO IN 2 if the computer cable is connected to the projector's DVI-I IN.
3. Please connect the audio cable to the AUDIO IN 3 if the video cables are connected to the VEDIO / S-VIDEO / Component port of the projector.

☞ If the selected video image is not displayed after the projector is turned on and the correct video source has been selected, please check whether the video source device is turned on and operating correctly. Also check whether the signal cables have been connected correctly.

☞ Many laptop computers may need to change the setting for monitor output when connecting to the projector. Usually a key combination like **Fn + F3** or CRT/LCD key turns the external display on / off. Locate a function key labeled CRT/LCD or a function key with a monitor symbol on the laptop. Press Fn and the labeled function key simultaneously. Refer to your laptop's documentation to find out your laptop's key combination.



**Discount-Merchant.com (800) 281-8860**  
THE TRUSTED SOURCE FOR PROJECTOR LAMPS AND ACCESSORIES

### Remote Control Batteries Installation

1. Remove the battery cover.
2. Load the batteries.  
Make sure the poles are correctly oriented.
3. Close the battery cover.

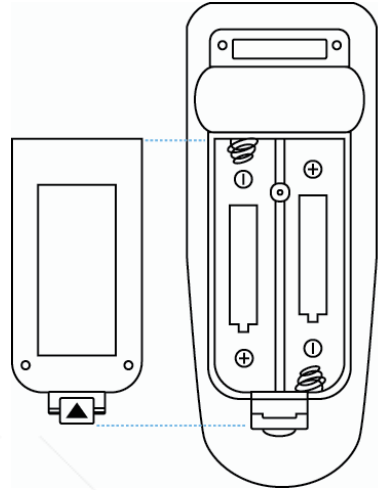

#### Caution

- ▶ Avoid excessive heat and humidity.
- ▶ Do not drop the remote control.
- ▶ If the remote control will not be used for an extended period, remove the batteries.
- ▶ Do not expose the remote control to water or moisture. This could result in malfunction.
- ▶ Replace the battery when remote control operation becomes sluggish or unresponsive.
- ▶ Do not place the remote control close to the exhaust ventilation opening of the projector, because the exhaust air is hot.
- ▶ Do not use batteries of different types at the same time.
- ▶ Do not mix a new battery with used one. Make sure the plus and negative terminals are correctly aligned when loading batteries.
- ▶ Dispose of batteries in accordance with environmental laws of your area.
- ▶ Do not disassemble the remote control. If the remote control needs service, please contact your dealer.

## Remote Control

### POWER

Power on / operation mode, Standby mode, Cool down mode.

### INPUT

Select input source :





### Note :

If the projector can not be captured the signals within 15 minutes, it will be shut down automatically.

### MENU

Display or hide the On-Screen Display main menu page.



Press  or  to select On-Screen Display menu item.



Press  or  to select and adjust the function of On-Screen Display menu item or value.

### LASER

Aim the remote control at the screen, press and hold button to activate the laser pointer.

### MUTE

Mute audio.

### Keystone +/-

Adjusts the vertical keystone function.

### Vol +/-

Sound louder or lower.

### AUTO

Refresh the current image.

### BLANK

Hide the current image, become black color on the screen.

### ESC

Press "ESC" button, it will close "Menu" picture.

### Still

Keep the current image on the Screen.

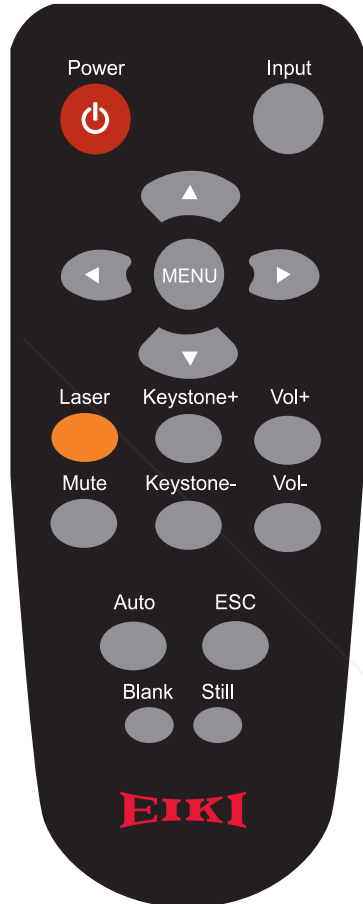



## Menu Operation

### How To Operate On-Screen Display

1. Press "Menu" button. Following menu will appear.
2. Press up / down / left / right button on control panel or remote control to select item or adjust value.



Up / Down / Right / Left button

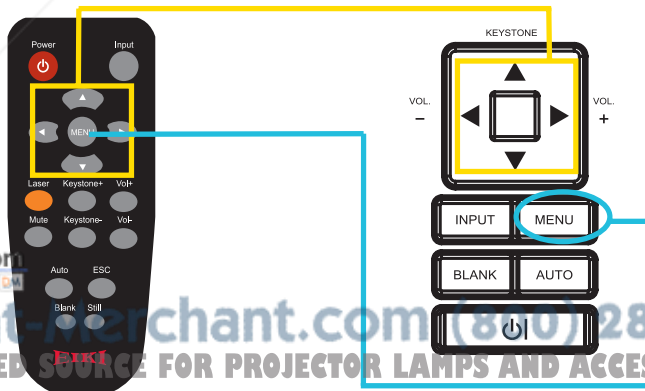

Menu button

## MENU (PC Mode)

### Picture Menu

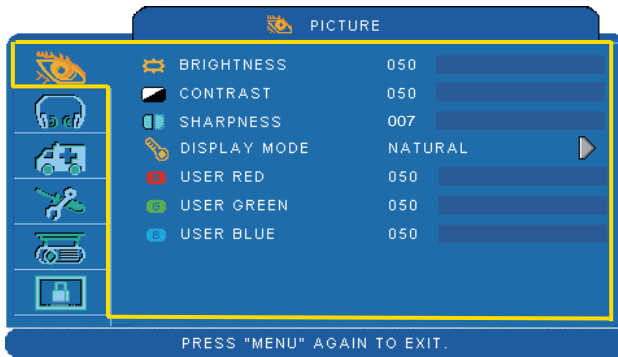

#### Step:

1. Use the ▲ / ▼ buttons to select an item.
2. Use the ◀ / ▶ cursor buttons to select an item or adjust the value.

Item	Selection	Description
BRIGHTNESS	000/100	Adjust the image brightness level.
CONTRAST	000/100	Adjust the image contrast level.
SHARPNESS	000/015	Adjust the image sharpness.
DISPLAY MODE	NATURAL	Natural color.
	CINEMA	Enhance contrast ratio when displaying DVD contents.
	DAYLIGHT	Suitable when ambient light is strong.
	GREEN BOARD WHITE BOARD BLACK BOARD	Adjust the color settings to make the projected image on a (green, white, black) board more visible.
	USER	User Red 000/100 User Green 000/100 User Blue 000/100

\*Only in USER mode in Display mode USER RED/GREEN/BLUE can be adjusted.  
 The setting data in this Picture Menu is not shown correctly if no signal is fed and projected.

Discount-Merchant.com (800) 281-8860  
 THE TRUSTED SOURCE FOR PROJECTOR LAMPS AND ACCESSORIES

## Audio Menu

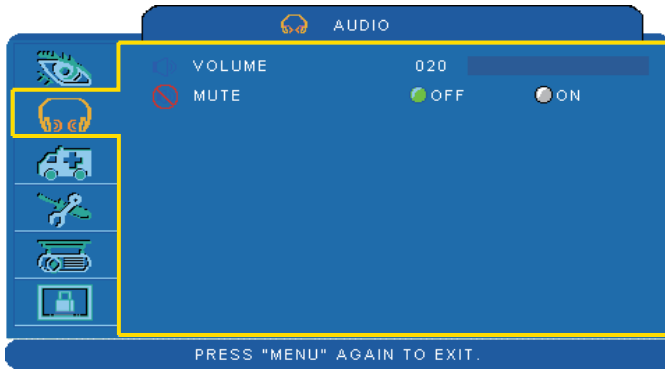

### Step:

1. Use the ▲ / ▼ buttons to select an item.
2. Use the ◀ / ▶ buttons to select an item or adjust the value.

Item	Selection	Description
VOLUME	00/40	Adjust the volume.
MUTE	OFF/ON	Mute the volume OFF / ON.

## Setting Menu



### Step:

1. Use the ▲ / ▼ buttons to select an item.
2. Use the ◀ / ▶ buttons to select an item or adjust the value.

Item	Selection	Description
H POSITION	000/100	Move the image position horizontally. This function can be used under computer signal input only.
V POSITION	000/100	Move the image position vertically. This function can be used under computer signal input only.
PHASE	000/100	Adjust the image sharpness.
FREQUENCY	000/200	Set the horizontal scanning frequency.
AUTO KEYSTONE	OFF/ON	Correct keystone distortion in image automatically.
KEYSTONE V	-70/+70	Correct vertical keystone distortion in image manually.
AUTO SYNC	EXECUTE	Set all of the above setting automatically.
AUTO SEARCH	OFF/ON	Search signal source manually or automatically.

FixYourDLP.com

H POSITION, V POSITION, PHASE, FREQUENCY and AUTO SYNC does not work for Digital RGB signal.

\* The setting data in this Setting Menu is not shown correctly if no signal is fed and projected.

## MENU (Video Mode)

### Picture Menu

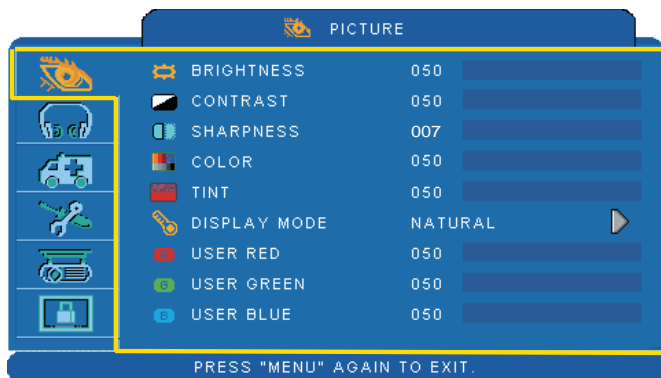

#### Step:

1. Use the ▲ / ▼ buttons to select an item.
2. Use the ◀ / ▶ cursor buttons to select an item or adjust the value.

Item	Selection	Description
BRIGHTNESS	000/100	Adjust the image brightness level.
CONTRAST	000/100	Adjust the image contrast level.
SHARPNESS	000/015	Adjust the image sharpness.
COLOR	000/100	Adjust the strength of whole color. This function can be used under video signal, S-Video signal, or component video signal input only.
TINT	000/100	Adjust the image tint. This function can be used under video signal, S-Video signal, or component video signal.
DISPLAY MODE	NATURAL	Natural color.
	CINEMA	Enhance contrast ratio when displaying DVD contents.
	DAYLIGHT	Suitable when ambient light is strong.
USER	GREEN BOARD	Adjust the color settings to make the projected image on a (green, white, black) board more visible.
	WHITE BOARD	
	BLACK BOARD	
	User Red 000/100	
	User Green 000/100	
	User Blue 000/100	

\*Only in USER mode in Display mode USER RED/GREEN/BLUE can be adjusted.

\*The setting data in this Picture Menu is not shown correctly if no signal is fed and projected.

## Audio Menu

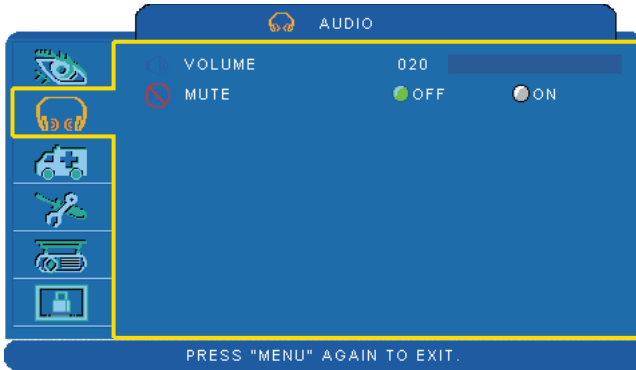

### Step:

1. Use the ▲ / ▼ buttons to select an item.
2. Use the ◀ / ▶ buttons to select an item or adjust the value.

Item	Selection	Description
VOLUME	00/40	Adjust the volume.
MUTE	OFF/ON	Mute the volume OFF / ON.

## Setting Menu

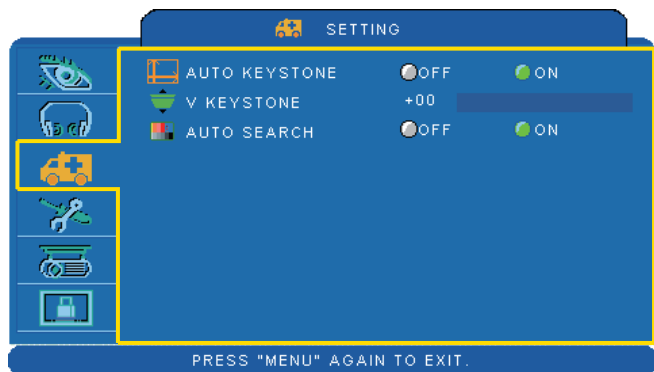

### Step:

1. Use the ▲ / ▼ buttons to select an item.
2. Use the ◀ / ▶ buttons to select an item or adjust the value.

Item	Selection	Description
AUTO KEYSTONE	OFF/ON	Automatically Correct keystone distortion in image.
V KEYSTONE	-70/+70	Correct vertical keystone distortion in image manually.
AUTO SEARCH	OFF/ON	Search signal source manually or automatically.

## Advanced Menu



### Step:

1. Use the ▲ / ▼ buttons to select an item.
2. Use the ◀ / ▶ buttons to select an item or adjust the value.

Item	Selection	Description
ZOOM / PAN	EXECUTE	Execute digital zoom and pan function.
FREEZE	OFF/ON	Freeze the current image on the screen.
BLANK	OFF/ON	Hide the image. Display on the screen turns into black.
BLANK POWER OFF	15/30/60 Minute	Set power off time after "Blank".
RESET	EXECUTE	Reset all menu function to their factory default values.
RESIZE		4:3, 16:9, 1:1
LANGUAGE	ENGLISH	Select the language of the menu and on screen display message. ▶ English ▶ 繁體中文 ▶ 简体中文 ▶ 日本語 ▶ 한국어 ▶ Italiano ◀ Deutsch ◀ Français ◀ Dutch ◀ ▶ Polski ▶ Português ▶ Русский ▶ Español ◀ العربية ◀ ไทย ◀ Українська ◀ Svenska ◀
SELECT SOURCE	EXECUTE	Select the input source from: ▶ RGB 1 ▶ RGB 2 ▶ DVI-I ◀ S-Video ◀ Video ◀ Y,Pb,Pr ◀ The search starts from the current port. When an input is found, the projector will stop searching and display the image.
LOGO SETTING	EXECUTE	Customize the start-up logo.  <b>IMPORTANT:</b> To implement Logo setting function, please enter PIN code first. Without inputting the PIN code, you cannot modify Logo setting function.



## Advanced Menu



### LOGO SETTING

This function allows you to customize the start-up logo.

In order to access this page PIN code is required.

Item	Selection	Description
LOGO MODE	DEFAULT	Select Mode( ► cursor button)
	USER	The factory logo.
	OFF	The image you captured. The blank image. You can select color with background function.
LOGO CAPTURE	EXECUTE	Start to capture the image.(PC mode only)
BACKGROUND	BLACK BLUE WHITE	Set background color.
LOGO SIZE	ORIGINAL FULL	Display the captured image in original size and put in the center of the screen. Expand the image to full screen.

## Advanced Menu

### Logo Capture

How to use this function?

- 1 Select Logo Capture item in the logo setting menu, then press ► button.
- 2 Red frame will appear to select captures area.
- 3 Use 4 direction buttons to adjust the position of the frame.
- 4 Press "MENU" to start capturing and display a dialog.

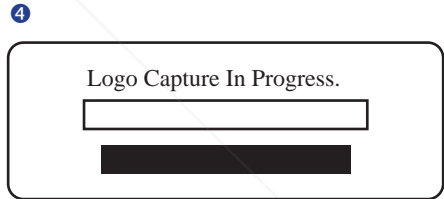
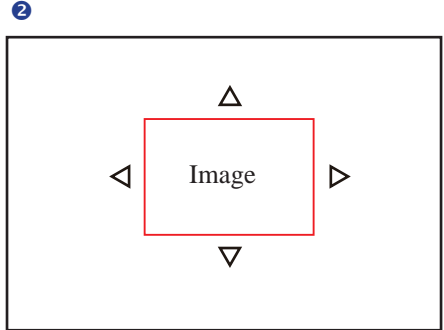

**NOTE** ► You can capture an image only in computer mode.  
 ► The area that can be captured is 512 x 384 dots.

## Presentation Menu

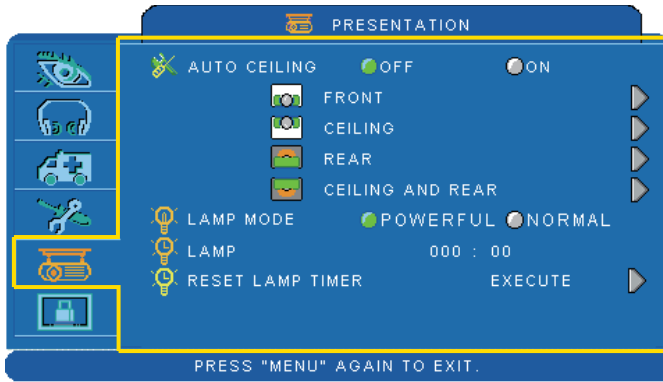

### Step:

1. Use the ▲ / ▼ buttons to select an item.
2. Use the ◀ / ▶ buttons to select an item or adjust the value.

Item	Selection	Description
AUTO CEILING	OFF / ON	Automatically invert the image when the projector is turned upside down, i.e. when the projector is mounted on the ceiling.
FRONT	EXECUTE	Normal projection mode.
CEILING	EXECUTE	Mirror the image vertically, only for the projector mounted upside down.
REAR	EXECUTE	Mirror the image horizontally, only for projecting onto rear projection screen.
CEILING AND REAR	EXECUTE	Mirror the image horizontally and vertically. Projecting onto a rear projection screen while projector is upside down.
LAMP MODE	POWERFUL / NORMAL	The lamp mode default is normal. If you would like to make more bright image, Please change the lamp mode to Powerful.
LAMP		Show lamp use time.
RESET LAMP TIMER	EXECUTE	After changing a new lamp, execute this function to reset the lamp timer.

## Presentation Menu

---

### Reset Lamp Timer

The lamp timer is the time counted after the last resetting. The usage time of the lamp is shown in the PRESENTATION Menu. Pressing the RESET button or the ► button displays a dialog.

To reset the lamp time, select the RESET using the ► button.

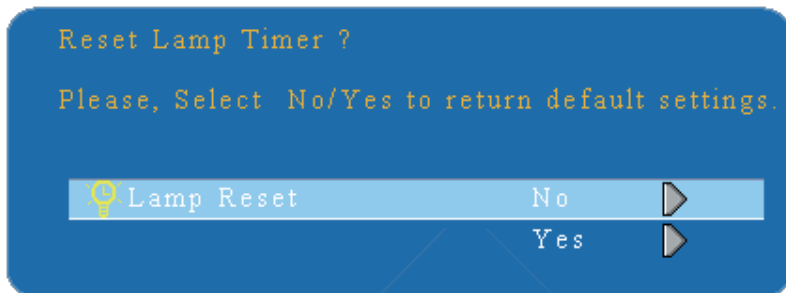

#### NOTE

- The replacement warning message is set to appear after about 3000 hours of lamp use in order to maintain the initial brightness. When replacement message appears, replace the lamp with a new one as soon as possible, even if the lamp is still workable.

# Security Menu

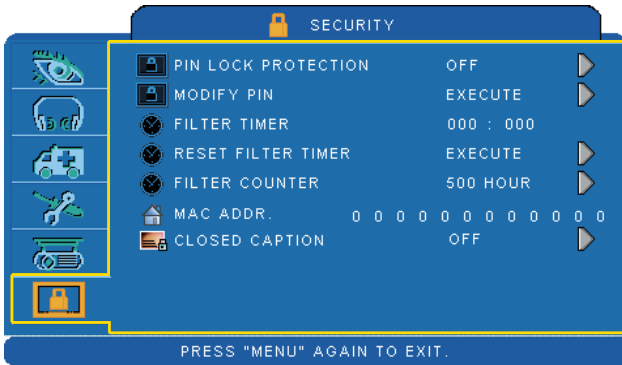

**Step:**

1. Use the ▲ / ▼ buttons to select an item.
2. Use the ◀ / ▶ buttons to select an item or adjust the value.

Item	Selection	Description
PIN LOCK PROTECTION	OFF ON 1 ON 2	<p>OFF: Turn off PIN lock protection.</p> <p>ON 1: After plugging in AC power, you need to key in PIN code at the first time of use. If the AC power stays unplugged, you do not need to key in PIN code next time when you use the projector.</p> <p>ON 2: You need to key in PIN code every time when you turn on the projector.</p> <div style="border: 1px solid black; padding: 5px;"> <p><b>⚠ CAUTION:</b> Once the PIN code had been set, the projector cannot be used unless you enter the correct PIN code.</p> </div>
MODIFY PIN	EXECUTE	<ol style="list-style-type: none"> <li>1. Press " MENU " on the projector or remote control.</li> <li>2. Use the ▶ button to select the MODIFY PIN item in the SECURITY category.</li> <li>3. Press the ▶ button to change PIN LOCK PROTECTION mode.</li> <li>4. Please enter the original PIN code.               <ol style="list-style-type: none"> <li>(a) If the PIN is correct, system will allow you to change a new PIN code.</li> <li>(b) If the PIN is incorrect, a " Code Error " message will appear.</li> </ol> </li> <li>5. Please enter a new PIN code. And then enter again to confirm.</li> </ol> <div style="border: 1px solid black; padding: 5px;"> <p><b>NOTE:</b>                (1) To change the PIN lock protection state, you must enter the PIN code first.                (2) Please enter: 0000 for first-time use.                (3) To avoid unnecessary trouble, if you activate the [PIN Lock Protection], it is highly recommended that you write down the PIN code and store it in a safe place.</p> </div>

## Security Menu

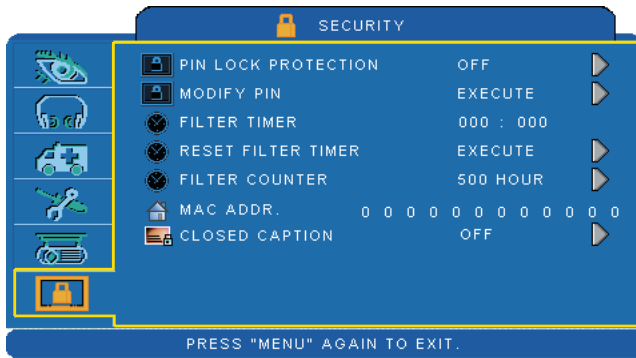

### Step:

1. Use the ▲ / ▼ buttons to select an item.
2. Use the ◀ / ▶ buttons to select an item or adjust the value.

Item	Selection	Description
FILTER TIMER		Show the filter use time.
RESET FILTER TIMER	EXECUTE	Reset the filter timer after cleaning / changing filter.
FILTER COUNTER	500 hours 800 hours 1000 hours	Select (500 / 800 / 1000 hours) depending on the environment.(default : 500 hours). Please see next page.
MAC ADDR.		For LAN control module, "MAC ADDR." will be shown in "SECURITY" Menu. MAC address stands for unique Media Access Control address of LAN control module and displays with six groups of two hexadecimal digits.
CLOSED CAPTION	OFF(Default) C.C1 C.C2 C.C3 C.C4 T1 T2 T3 T4	The Closed Caption function intimates the sound effects, dialogue, and narration in the content of the television program or video source. Caption (C.C1~C.C4) : Display closed caption Text (T1~T4) : Display text data, which is for additional information such as news reports or a TV program guide. <b>NOTE</b> : This function is available only in Video / S-Video source.



**Discount-Merchant.com (800) 281-8860**  
THE TRUSTED SOURCE FOR PROJECTOR LAMPS AND ACCESSORIES

### Auto Filter Alert

Auto Filter Alert in SECURITY category shows the air filter use time and alerts user to change filter. When the operating time reaches the set time, a warning message will appear on the screen to remind user of filter cleaning /replacing.

Filter Replace...

Filter has been used for more than 500 hours.

#### NOTE

► Please reset the Filter time only when you replace the filter.



**Discount-Merchant.com (800) 281-8860**  
**THE TRUSTED SOURCE FOR PROJECTOR LAMPS AND ACCESSORIES**

## PIN Key In Operation

When the projector is turned on and the PIN LOCK PROTECTION is set to [ON], the image will show as on the right side.

1. Press the MENU button on the projector or remote control. Enter PIN code by keypad or remote control.
2. How to enter a PIN code?  
You can use control panel or remote control.

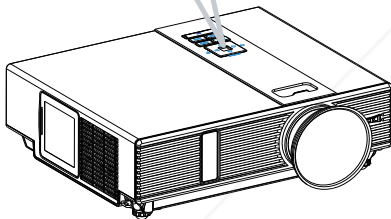
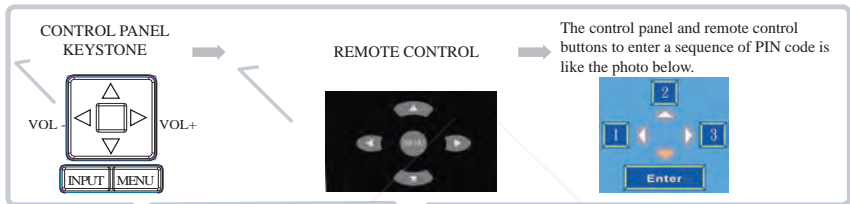
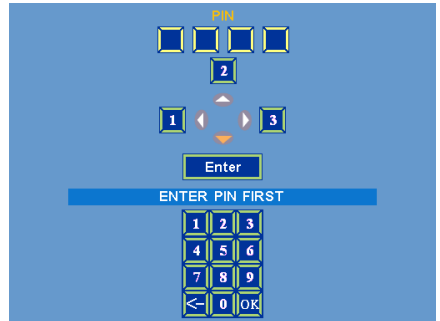

Refer to photo below to enter a sequence of PIN code by control panel or remote control buttons.

- (1) Press ◀ button: Select the [ 1 ]
- (2) Press ▲ button: Select the [ 2 ]
- (3) Press ▶ button: Select the [ 3 ]
- (4) Press ▼ button: Select the [ Enter ] to move to next row. (4~6, 7~9, ◀~OK)
- (5) Press ◀ (backspace) item:  
In case of enter a wrong digit, select ◀ to delete the wrong digit you entered.
- (6) Press OK item:  
Once all four digits of the PIN are entered, select OK to confirm.

### NOTE

- (1) Please enter: 0000 for first-time use.
- (2) If the PIN is incorrect, a "Enter new code" message will be shown. Please try again. If the PIN code input is incorrect for three times, a warning message will show up and the projector will shut itself down in 30 seconds.
- (3) If you have no idea about the PIN, please contact your dealer for help.



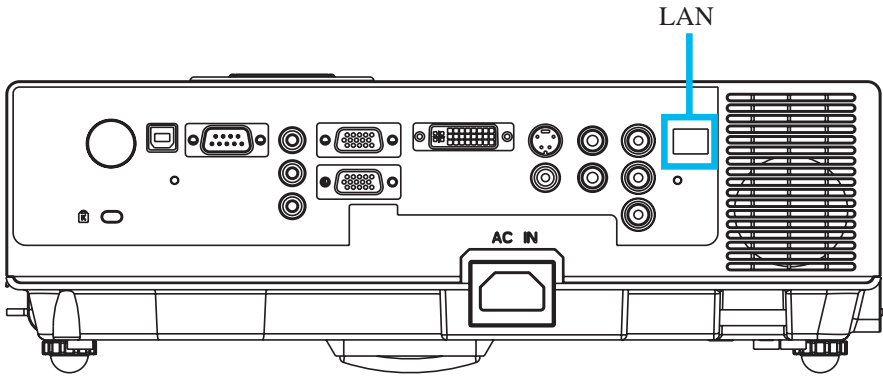

## Procedure to utilize this function

- 1 Register the projector(s) to be controlled only for the first time.  
"Auto Search" finds and lists up the projectors in the network.  
Assign Projector name and Group name for ease.
- 2 Save the setting as a Project file.  
By opening the Project file the setting can be recovered easily from next time.
- 3 Monitor the status of registered projectors up to 255 units.  
Status of Power, Temperature and System and Input selection, used hours of Lamp and Filter can be monitored.  
For used hours the limit for alert can be set.
- 4 Control registered projector one by one.  
By using "Link" of Network Control Software each projector can be controlled.

### NOTE

To monitor and control the projector(including stand-by mode), the following conditions are needed to be ready:

- (1) Projector is powered on or in stand-by mode.
- (2) Projector is connected to network.
- (3) LED light of the projector network port shows normal. (Green light on, Orange twinkling)

## Before Use

### Before Using Network Control Software

- 1 Copy and paste the "Network Control Software" folder in the CD-ROM of the Owner's Manual to the PC.
- 2 Create and put the short-cut icon for "Network Control.exe" on the desktop.
- 3 Confirm that AC is supplied to the projector and the projector and the PC are connected to each other with LAN cable (through the network).

### Activate Network Control Software

- 1 Execute the Network Control Software.

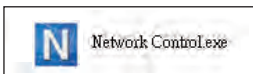

- 2 Monitor window below appears.

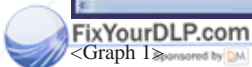
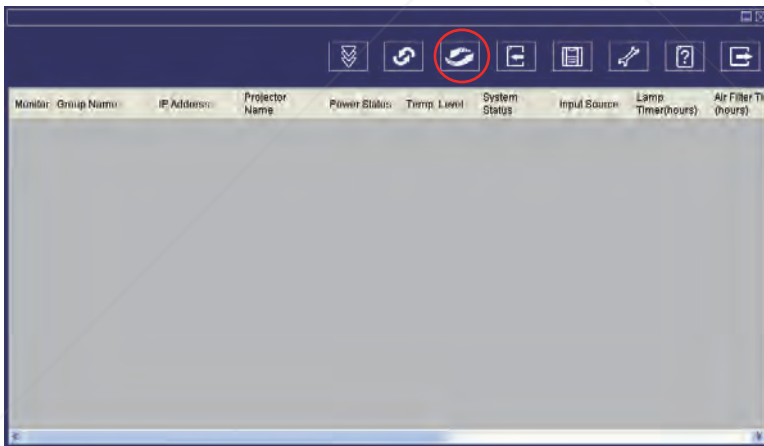

**Discount-Merchant.com (800) 281-8860**  
**THE TRUSTED SOURCE FOR PROJECTOR LAMPS AND ACCESSORIES**

## Before Use

### Projector Auto Search.

- 1 Click the  (Projector search), then the Search Window below appears.

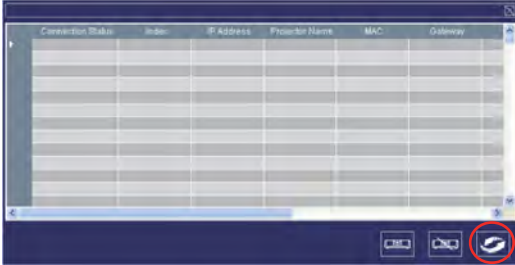

<Graph 2>

### NOTE

If the security warning window appears, please select "Unblock" to allow the Network Control software to work.

- 2 Click  (search again), then the target projectors will be listed as follows.

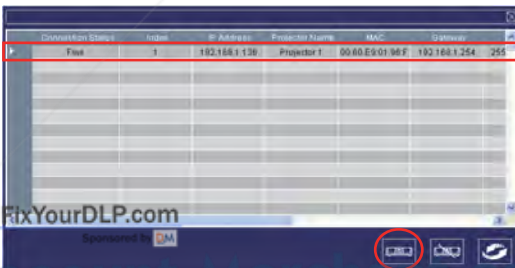

<Graph 3>

### Modify The Projector Setting

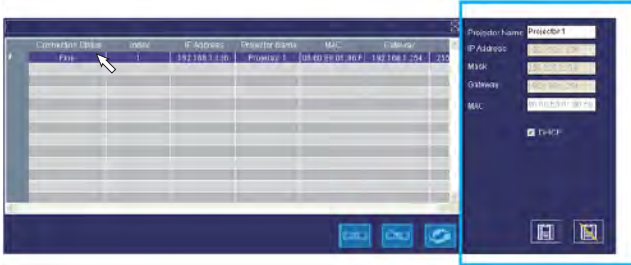

- 1 If you need to modify the projector's setting, please move mouse cursor to the table on the left and press button on the column. The contents of the setting will appear on the right side table.



< Graph 5 > : Register Table.

#### Note

When DHCP setting is changed, in order to make the change effective AC power to the projector needs to be disconnected and reconnected.

- 2 After changing the projector setting, you can save the data by clicking  button or cancel by clicking  button.

Item	Description
Projector name	Show the Host name. (16 characters at most in ASCII.)
IP Address	Show the IP Address.
Mask	Show the Subnet Mask.
Gateway	Show the Gateway.
MAC	Show up the MAC Address. (The default value can not be modified.)
DHCP	Capture IP address from network Server automatically.

< Table 1 > : Setting Windows.

- 3 Click  (register projector), then the projectors will be shown in the Monitor Window as shown below.

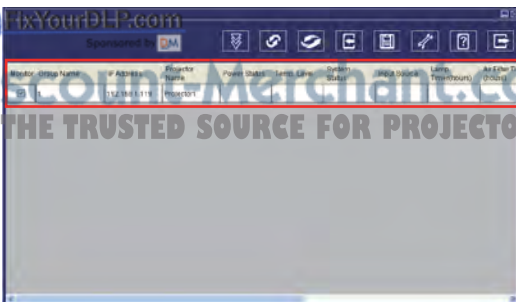

<Graph > Monitor window

## Before Use

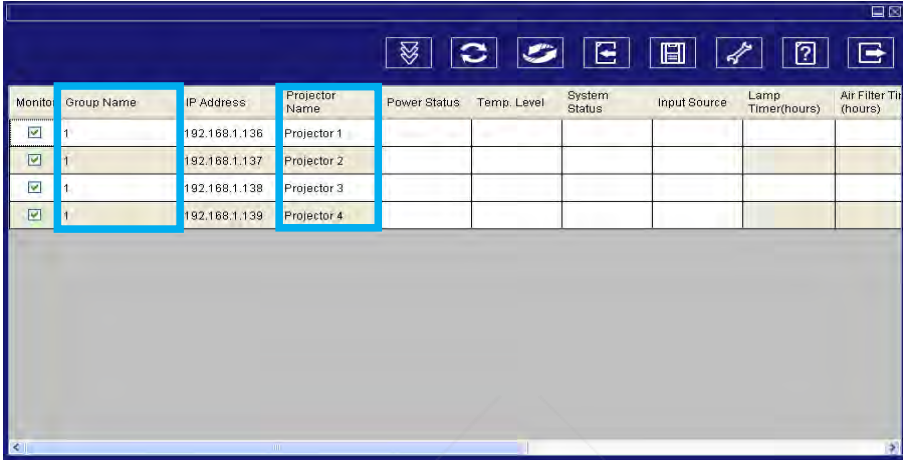

### Sorting the projectors

- Projector can be sorted easily by clicking the monitor window title (Group Name) or (Projector Name).



Monitor	Group Name	IP Address	Projector Name	Power Status	Temp. Level	System Status	Input Source	Lamp Timer(hours)	Air Filter Tilt(hours)
<input checked="" type="checkbox"/>	1	192.168.1.136	Projector 1						
<input checked="" type="checkbox"/>	1	192.168.1.137	Projector 2						
<input checked="" type="checkbox"/>	1	192.168.1.138	Projector 3						
<input checked="" type="checkbox"/>	1	192.168.1.139	Projector 4						

<Graph >

- After registering, you can click  button (Data single capture) in the tool bar or click  button (Start Auto Scan) to update the status.

### NOTE

While Auto Scan is running to update the status, the scroll bar for the window is grayed out and the hidden column can not be shown. Therefore before starting Auto Scan place the column in the window by using drag-drop or scroll bar in advance.

### Meaning of Status Icons

The following table can be displayed by pressing "  " Help button.



Power Status	Other Message	Input Source
Standby Projector On Cooling	Can't Get Data Data Update NG	RGB1 DVI Video S-Video YPbPr
System Status	Temp. Level	
No warnings Fan Error High Temp.	Lamp Error Lamp Cover Door Error	
Low Medium Normal Temp.	High Temp. Warning Extreme High Temp.	

## Registering And Configuring The Projector

### Delete

- 1 Select the registered projector in monitor window. Click mouse right key and select "Delete" to erase the registered projector data.

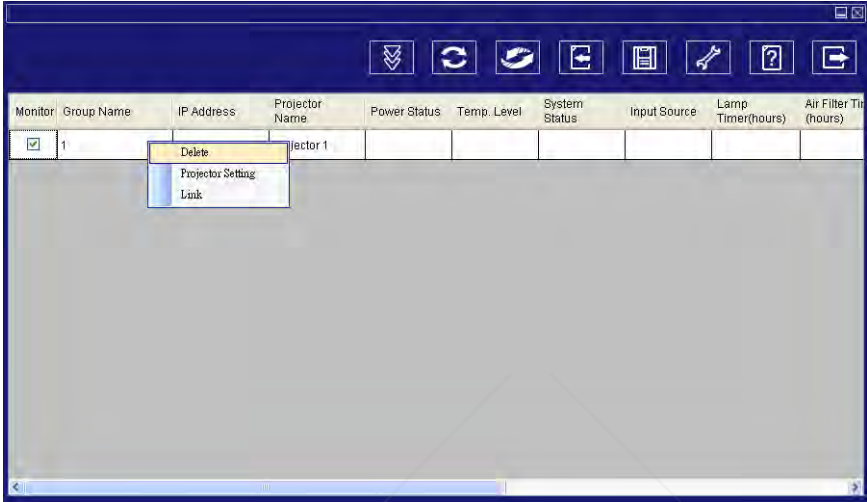



< Graph 6 > : Register Table.



**Discount-Merchant.com (800) 281-8860**  
THE TRUSTED SOURCE FOR PROJECTOR LAMPS AND ACCESSORIES

## Registering And Configuring The Projector

### Projector Setting (Setting for individual projector)

- 1 Select the registered projector in monitor window. Click mouse right key and select "projector setting" to modify the registered projector data. After finishing the setting, you can save by clicking  button or cancel by clicking  button.

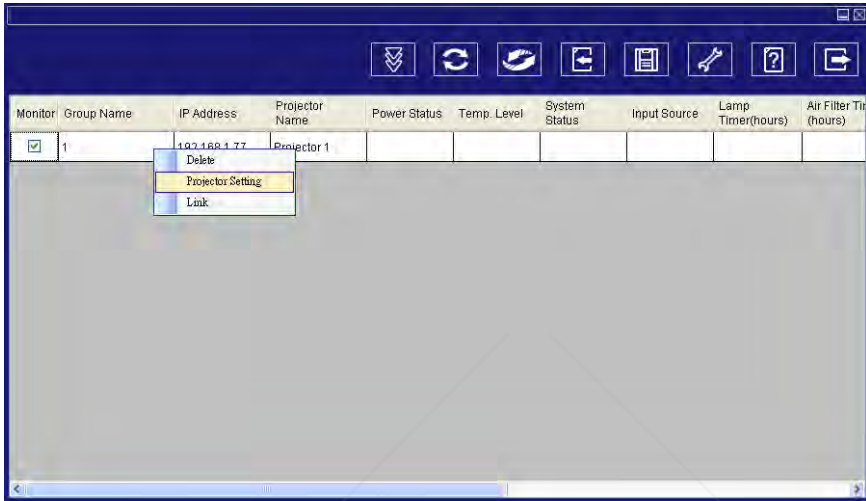

< Graph 7 > : Register table.



The screenshot shows a "Projector Setting" dialog box with the following fields and values:

- Group Name: 1
- Projector Name: Projector 1
- IP Address: 192.168.1.77
- Mask: 255.255.255.0
- Gateway: 192.168.1.254
- MAC: 00:60:E9:01:C9:85
- Monitor:  Air Filter Alert (hours): 500
- DHCP:  Lamp Timer.Alert (hours): 1500

At the bottom, there are two buttons: a save icon and a cancel icon.

< Graph 8 > :Setting table.

# Registering And Configuring The Projector

## System Setting (Setting for all projectors)

2 Click  button (system setting) to modify system alert setting.

### Saving the setting

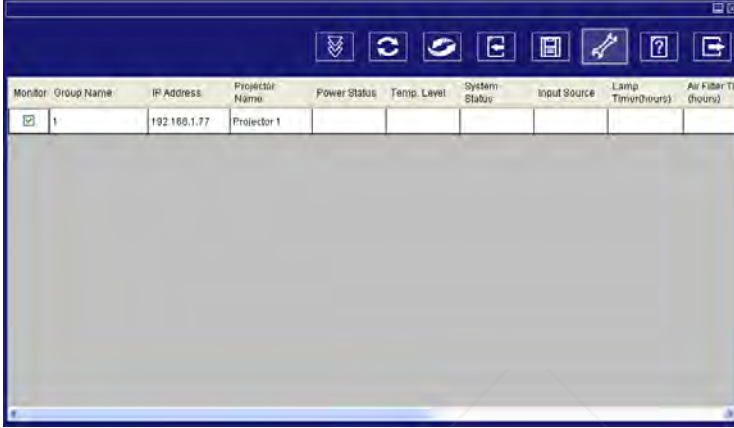

< Graph 9 >

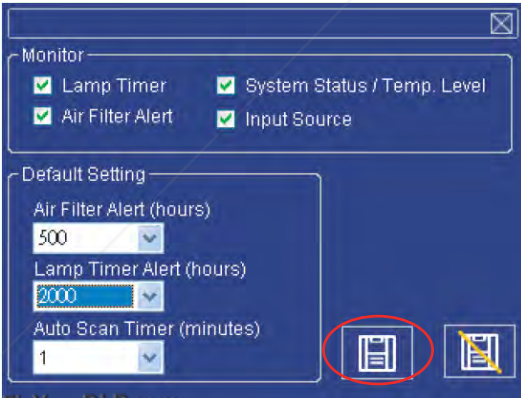

<Graph 10>

### Note:

Alert setting in System Setting vs Projector Setting

Whenever the  Save button is pressed in System Setting, the value becomes effective for all the projectors registered.

After this if the value in Projector Setting is changed and saved, the value becomes effective only for the projector.



## Registering And Configuring The Projector

### System Setting

#### Monitor

Item	Description
Lamp Timer	Read lamp use time from projector.
Air Filter Alert	Read Air Filter Timer from projector.
System Status/ Tempeture Level	Read System Status and Temperature from projector in Power On status.
Input Source	Read Input Source Selection from projector in Power ON status.

< Table 2 >

#### Default Setting

Item	Description
Lamp Timer Alert (Hr.)	Default Setting Includes 1000/1500/2000/3000 Hours. When Lamp Timer reaches alert target, window will show lamp timer in red color to remind user to replace the lamp.
Air Filter Alert (Hr.)	Default setting includes 500/1000/1500/2000/2500 Hours. When Filter Timer reaches alert target, window will show filter timer in red color to remind user to replace the filter.
Auto Scan Timer (minutes)	Auto Detect setting. Default setting includes 1/3/5/10 minutes; user can set the optimal default listed in Table 4.

< Table 3 >

#### Auto Scan Timer

Projector Number (Sets)	Timer Interval (Minutes)
1~25	1/3/5/10
26~50	3/5/10
51~100	5/10
101~255	10<

\* The maximum quantity of projector monitored is 255.

< Table 4 >

## Registering And Configuring The Projector

### Saving the Project File

Save the Configuration above as Project File by clicking the save button in the Tool bar in the Monitor window before closing Network Control Software.

If it is not saved, all the configuration above will be lost.

From next time after starting this Network Control Software the configuration can be recovered easily by opening the Project File.

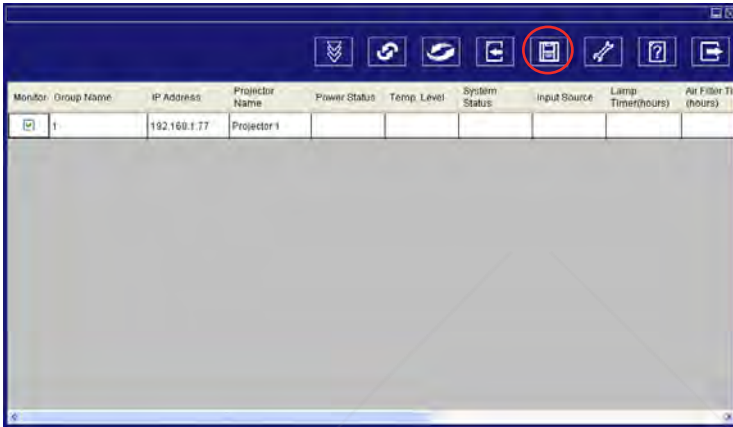

**Discount-Merchant.com (800) 281-8860**  
**THE TRUSTED SOURCE FOR PROJECTOR LAMPS AND ACCESSORIES**

## Registering And Configuring The Projector

### Link(Controlling Projector)

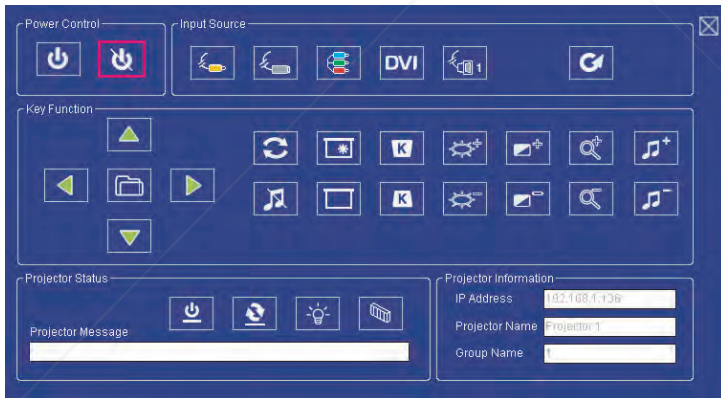
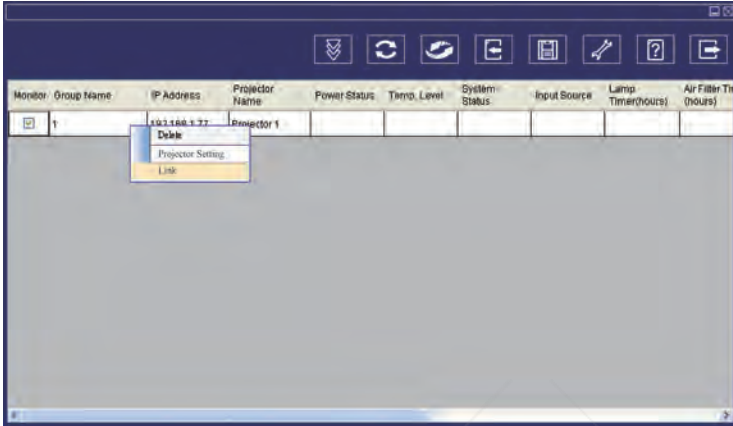

- 3 Select the registered projector in monitor window. Click mouse right key and select "Link" to show the control panel table and the projector connecting status.









< Graph 12 > : The control panel table

## Control Panel Window Introduction















### 1 Power Control

Icon	Name
	Power on
	Power off

### 2 Input Source





Icon	Name
	Video
	S-Video
	Y, Pb, Pr / Y, Cb, Cr
	DVI-I
	RGB 1
	Change Input Source

### 3 Function Key





Icon	Name	Icon	Name
	Up		Freeze
	Down		Blank
	Left		Keystone Correction +
	Right		Keystone Correction -
	Menu		Increase Brightness
	Auto Sync		Decrease Brightness
	Mute		Higher Contrast

## Control Panel Window Introduction

### 3 Function Key











Icon	Name
	Lower Contrast
	Zoom In
	Zoom Out
	Volume Up
	Volume Down

### 4 Projector Status

Icon	Name
	System Status
	Input Source Status
	Lamp Timer
	Air Filter Timer

## Control Panel Window Introduction

### 1 Network Control Window introduction

Icon	Name	Description
	Scan all	Capture the all registered projectors' information one time only.
	Start Auto Scan	According to the system setting, get the projector information automatically.
	Stop Auto Capture	Stop scanning the projector information.
	Auto Search	Search the projector in the same network to register and modify the setting.
	Open Project File	Open project file which was saved.
	Save Project File	Save the registered projector in this project.
	System Setting	Setting the projector system reminder message.
	About	Icon content description.
	Exit	Exit the Network software.
	Register projector	Register projector's information.
	Exit	Cancel registered information.

## Maintenance of Projector

### Filter

Keep the air filters clean by cleaning them periodically.

By using Filter Counter the projector can remind you of the timing.

There are 2 types of air filters in this projector, one is black sponge attached just back side of the filter cover and the other is the filter assembly called Anti-dust filter(consists of a white folded cloth and black frame).

### How to clean or replace the filters

Turn off the projector, and unplug the power cord. Wait to allow the projector to cool down sufficiently.

1. Push up 2 white stoppers of the Filter cover and remove it from the side of projector as shown below.
2. Remove the Anti-dust filter from the Filter cover by pushing and sliding it as shown below. (There is >ABS< sign on the top the black frame of the Anti-dust filter.)
3. Clean the filters with a vacuum cleaner except for the back side of the sponge, because the vacuum cleaner may suck it. Brush the sponge gently by a brush. (Do not clean the filters with water.)

\*If the Anti-dust filter is too dirty to clean, please replace it with new one.  
The part number of the Anti-dust filter is "13340233".

1

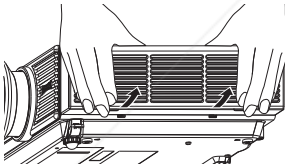

2

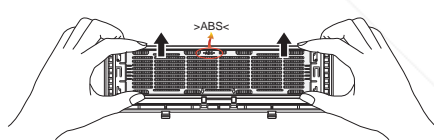

3

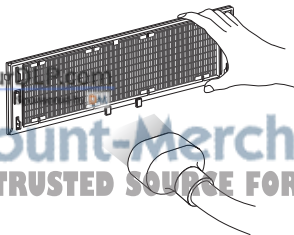

Sponge filter

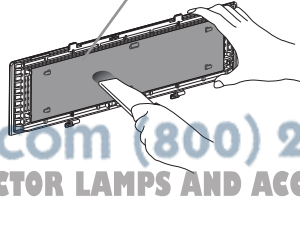

## Maintenance of Projector

4. Install the Anti-dust filter to the filter cover.
  - (a) Place the Filter cover so as the sponge filter faces you.  
(There is >PC< sign on the top middle of the Filter cover.)
  - (b) Place the Anti-dust filter on it so as the 4 white hooks show up through the openings in the corners.  
(There is >ABS< sign on the top of the black frame.)
  - (c) Slide down the Anti-dust filter so that the two black hooks of the Anti-dust filter go into the slots on the bottom of the Filter cover.  
(you shall hear a "click" sound)  
Make sure that all of 4 white hooks of the Filter cover are well hooked on the frame.
5. Insert the projected parts of the Filter cover to the side of the projector first and then close the Filter cover by pushing 2 white stoppers. Make sure that the Filter cover is well closed.
6. Reset the Filter Timer.(P.34)

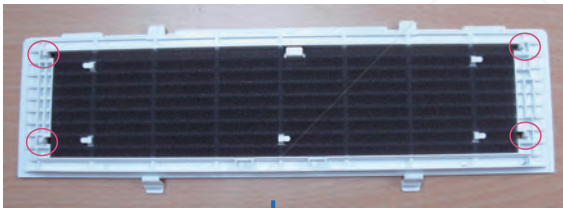



## Maintenance of Projector

### Lamp

Please turn off the projector and unplug the AC power cord. And then, let the projector cool down at least 60 minutes.

#### Replacing New Lamp(Part Number:23040021)

1. Remove the lamp door.
2. Loosen 2 screws of the lamp holder. Hold the handle on the top of the lamp, pull out the lamp straight off the projector.
3. Insert new lamp, lock the lamp door firmly with 2 screws.
4. Put the lamp door on.
5. Please reset the lamp timer after replacing lamp. (P.32)

When changing lamp, it is recommended that you change the filter at the same time.

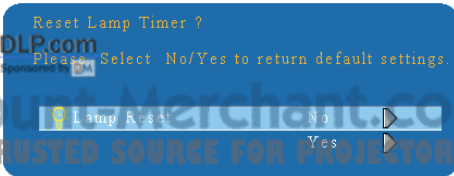
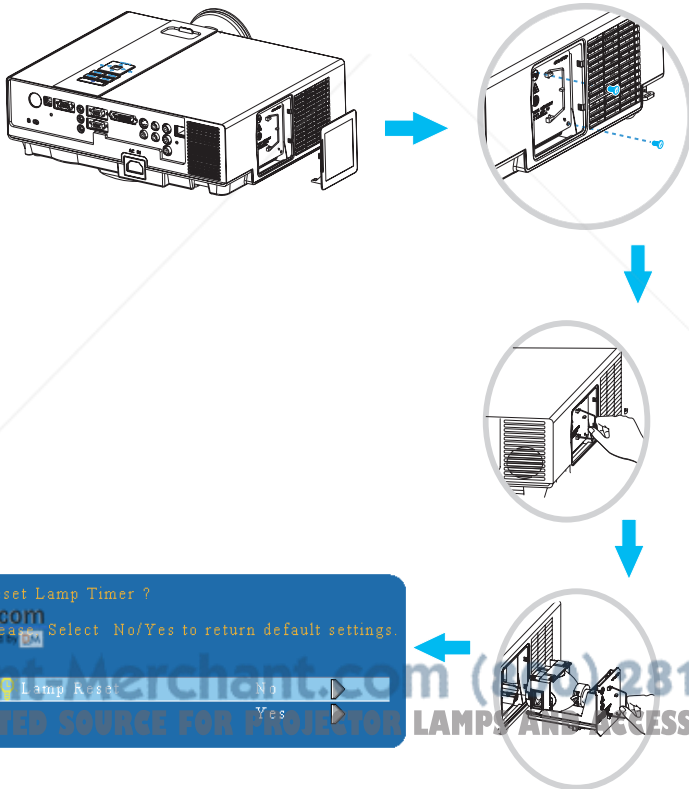

FixYourDLP.com  
DiscountMerchant.com (800) 281-8860  
THE TRUSTED SOURCE FOR PROJECTOR LAMP AND ACCESSORIES

## Maintenance of Projector



### WARNING

The projector uses a high-pressure mercury lamp.

The explosion of lamp with a loud bang or burn out could possibly cause injury or a fire.

When the bulb bursts, it is possible for shards of glass to fly into the lamp housing; and for gas containing mercury to escape from the projector's vent holes.

If the lamp has broken, do not check the inside of the projector. Please ventilate the room immediately.

Do not touch or bring your face close to the broken pieces since it might get into your eyes or mouth. In case of injury, seek medical advice immediately.

### Disposal of a Lamp

Dispose of a lamp in accordance with the local recycling laws.

Do not put it to your trash.

Recycling Lamp's laws of the USA, go to [www.lamprecycle.org](http://www.lamprecycle.org).

Recycling Product's laws of USA, go to [www.eiae.org](http://www.eiae.org).

Recycling Product's laws of Canada, go to [www.epsc.ca](http://www.epsc.ca).

For more information about recycling laws, please contact local government agency or dealer.

### CAUTION HOT

Before replacing the Lamp unit, pay attention to the following items:

1. The Lamp is optional part. Contact the dealer for replacement lamp.
2. The lamp becomes very hot when in use. Turn the power off and disconnect the power cord.
3. Wait for 1 Hour before replacing the lamp.
4. Do not use old lamp unit.



**Discount-Merchant.com (800) 281-8860**  
**THE TRUSTED SOURCE FOR PROJECTOR LAMPS AND ACCESSORIES**

## Maintenance of Projector

### **Additional**

- In order to ensure the safe use of your projector, please contact your dealer to inspect about once a year.
- Before maintenance, make sure the power cable is unplugged, allow the projector to cool sufficiently. The high temperature state of the projector could cause a burn in and/or malfunction to the projector.
- Never try to maintain the inside of the projector by yourself.



**Discount-Merchant.com (800) 281-8860**  
**THE TRUSTED SOURCE FOR PROJECTOR LAMPS AND ACCESSORIES**

## Troubleshooting



### Indicator

The power and lamp indicators show the status of the projector. Before requesting repair, check the projector status using the chart below. If the problem cannot be resolved, contact your dealer.

#### *In normal status~~~*

POWER	LAMP	CONDITIONS	DESCRIPTION
Blinking In <i>Green</i>	Off	Stand by mode	Projector is ready to be turned on.
Lighting In <i>Green</i>	Off	On mode	Projector is on and operating.
Lighting In <i>Green</i>	Blinking In <i>Red</i> ( Slow )	Cool down mode	Projector is in cool down mode and will not respond to user input.
Lighting In <i>Green</i>	Blinking In <i>Red</i> ( Fast )	Cool down mode	When the projector is turned on in 5 minutes after it was turned off.

#### *In abnormal status~~~*

POWER	LAMP	CONDITIONS	DESCRIPTION
Blinking In <i>Green</i>	Blinking In <i>Red</i> ( Fast )	Fan fault mode	The projector has detected a problem of a slow internal fan speed. The lamp will shut off automatically. Contact your dealer.
Blinking In <i>Green</i>	Lighting In <i>Red</i>	Lamp cover open	The lamp cover is open or there is a problem with the lamp. If the lamp door is closed and replacing the lamp does not correct the issue, contact your dealer.
 FixYourDLP.com <small>Sponsored by</small>  Blinking In <i>Green</i> (Fast)	Blinking In <i>Red</i> ( Fast )	High temperature	The projector has overheated and shut itself down. Correct the over temperature condition immediately. 1. Check that the ventilation slots are free from obstructions. 2. Check the cleanliness of the air filter.
Blinking In <i>Green</i> (Slow)	Blinking In <i>Red</i> (Slow)	Lamp fail	The lamp does not light. Come back to "stand by mode", and press the power button.

## Troubleshooting

### Error For Machine Defects

The following problems may be confused with a machine defect. Check and follow the table. If it couldn't be improved, contact your dealer.

Symptom	Cause / Remedy
Projector power does not turn on	<b>The power cord is disconnected.</b> Plug the power cord into an AC outlet.
	<b>Intending to turn on the projector again during the cool down mode.</b> Wait until the cool down mode has completed.
	<b>There is no lamp and/or lamp cover is not firmly closed.</b> Please turn off the power and disconnect the power plug from the power outlet. Check if the lamp is installed or the lamp cover is firmly closed and turn on the power again.
	<b>Power cord has impaired.</b> When you touch the power cord, the indicator goes on then off, please remove the power cord and connect it again. If the situation is repeated, remove the power cord and contact your dealer.
No Image	<b>The input is not connected correctly.</b> Select the appropriate input source.
	<b>No signal input.</b> Connect correctly.
	<b>The lens cover is attached to the lens.</b> Remove the lens cover.
Colors are pale	<b>Color density and color matching are not adjusted correctly.</b> Adjust the RGB setting.
	<b>Color lose.</b> Caused by poor VGA cable connection.
Abnormal brightness & contrast	<b>Brightness and contrast are not adjusted correctly.</b> Adjust the brightness and contrast setting.
	<b>The lamp is near the end of its service life.</b> Replace with a new lamp.
Image is blurred	<b>The projection lens is not focused.</b> Adjust the focus using the focus ring.
	<b>The lens is dirty or misty.</b> Clean the lens.

## Troubleshooting

### Error For Machine Defects

Symptom	Cause / Remedy
No audio	<b>The projector is not connected correctly.</b> Check audio cable if connect correctly.
	<b>The volume is set to minimum.</b> Adjust the volume.
	<b>Mute is turned on.</b> Press the MUTE button.
Remote control is not working	<b>No battery.</b> Before using the remote control, please check the battery of remote control.
	<b>Remote signal is obstructed.</b> Remove the obstacle between projector and remote control.



**Discount-Merchant.com (800) 281-8860**  
**THE TRUSTED SOURCE FOR PROJECTOR LAMPS AND ACCESSORIES**

## Troubleshooting

### List of Supported Monitor Displays

<b>Computer mode / DVI-I mode</b>		
<b>Signal</b>	<b>Refresh Rate (Hz)</b>	<b>Resolution (dots)</b>
VGA	60	640x480
VESA	60 / 72 / 75 / 85	640x480
SVGA	56 / 60 / 72 / 75 / 85	800x600
XGA	60 / 70 / 75 / 85	1024x768
SXGA	70 / 75	1152x864
SXGA	60 / 75	1280x960
SXGA	60	1280x1024
WXGA	60 / 75	1280x800
WXGA+	60 / 75 / 85	1440x900
SXGA +	60 / 75	1400x1050
UXGA	60	1600x1200
WSXGA+	60	1680x1050
MAC	67	1280x1024 / 640x480
MAC	75	832x624
MAC	75	1024x768
MAC	75	1152x870
<b>Component (Y, Pb, Pr/ Y, Cb, Cr)</b>		
<b>Signal</b>	<b>Refresh Rate (Hz)</b>	<b>Resolution (dots)</b>
SDTV(480i / 576i)	30 / 25	720x480 / 720x576
SDTV(480p / 576p)	60 / 50	720x480 / 720x576
HDTV(720p)	60	1280x720
HDTV(1080i / 1080p)	30 / 60	1920x1080
<b>Composite / S-Video</b>		
<b>Signal</b>	<b>Refresh Rate (Hz)</b>	<b>Resolution (dots)</b>
TV(NTSC)	60	720x480
TV(PAL, SECAM)	50	720x576

# Appendix

## Menu Tree (PC Mode)

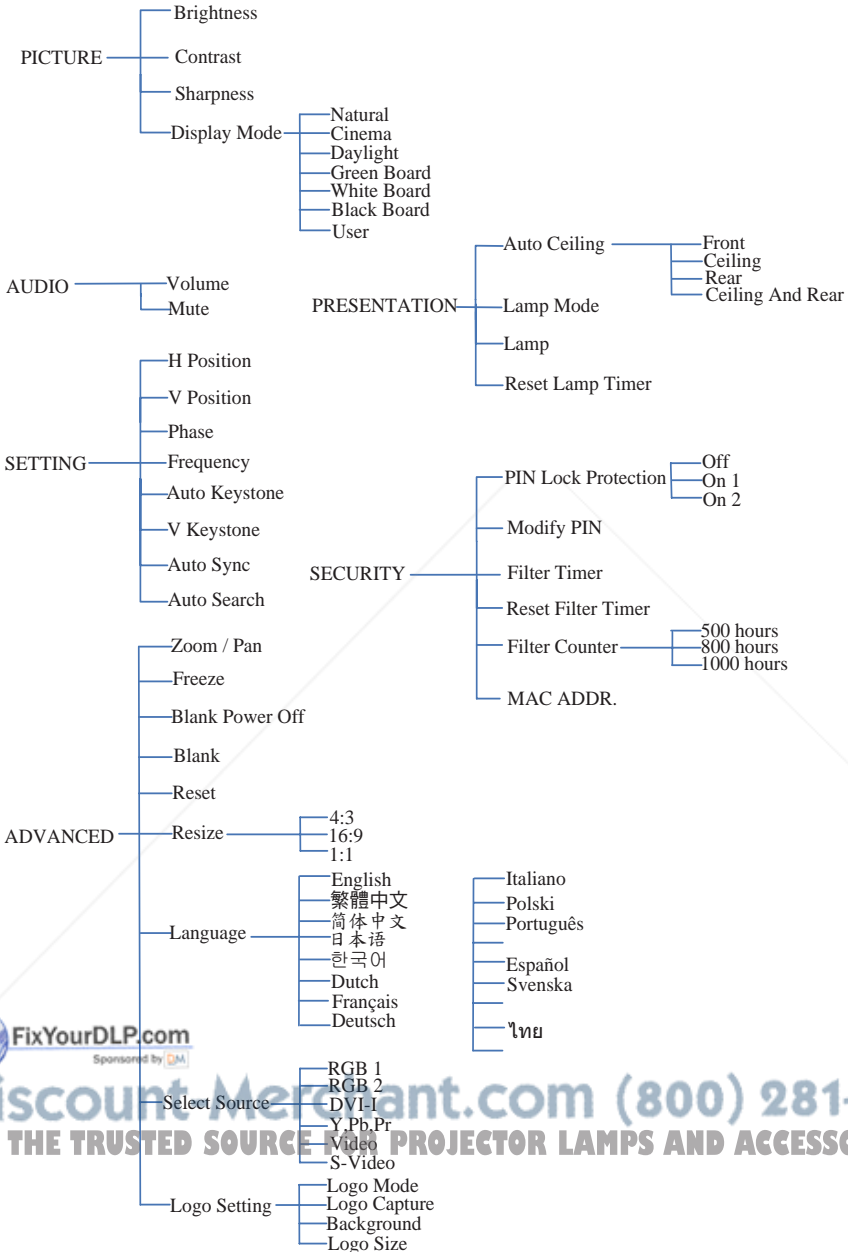

Discount Merchant.com (800) 281-8860  
 THE TRUSTED SOURCE FOR PROJECTOR LAMPS AND ACCESSORIES

\*DVI doesn't support H / V POSITION, PHASE, FREQUENCY, AUTO SYNC function.



# Appendix

## Menu Tree (Video Mode)

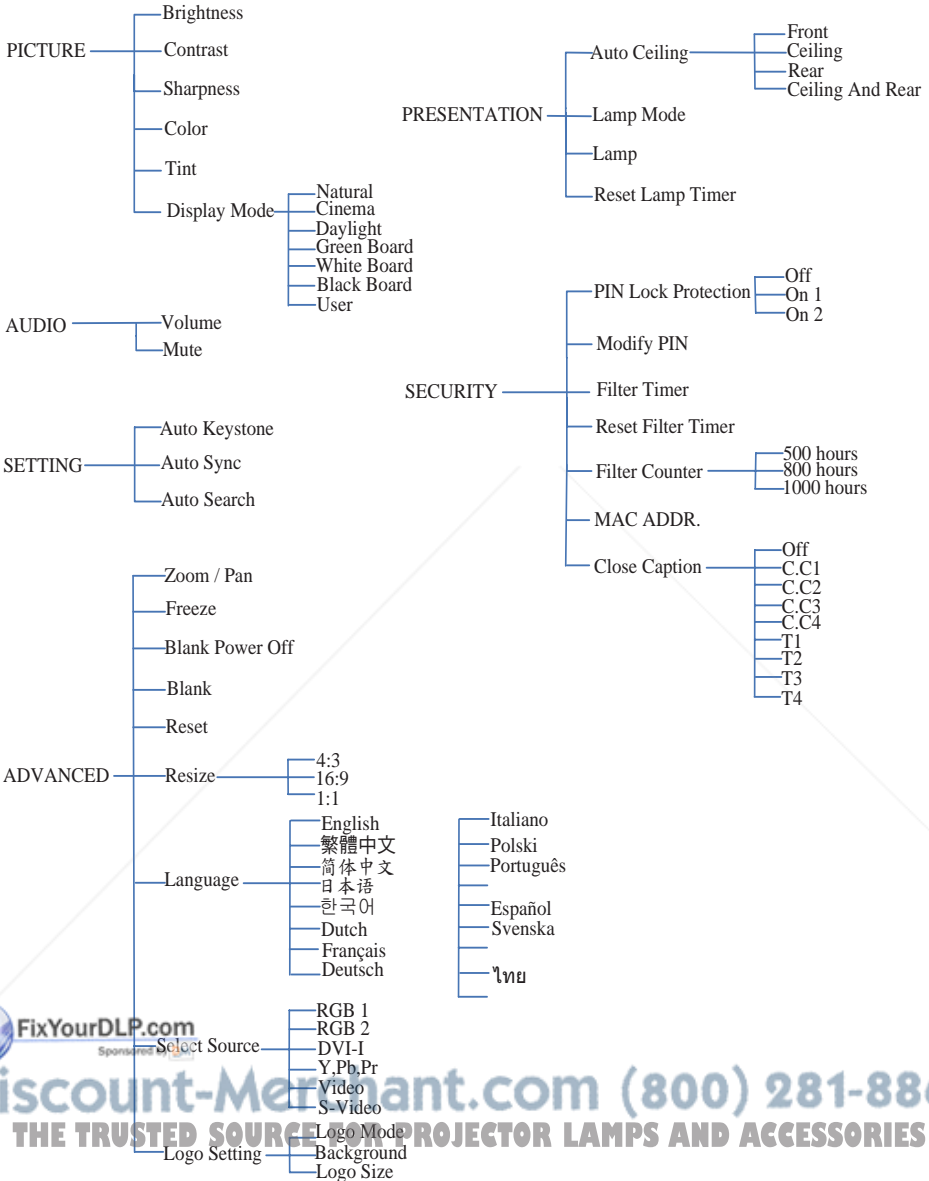

# Appendix

## Appearance

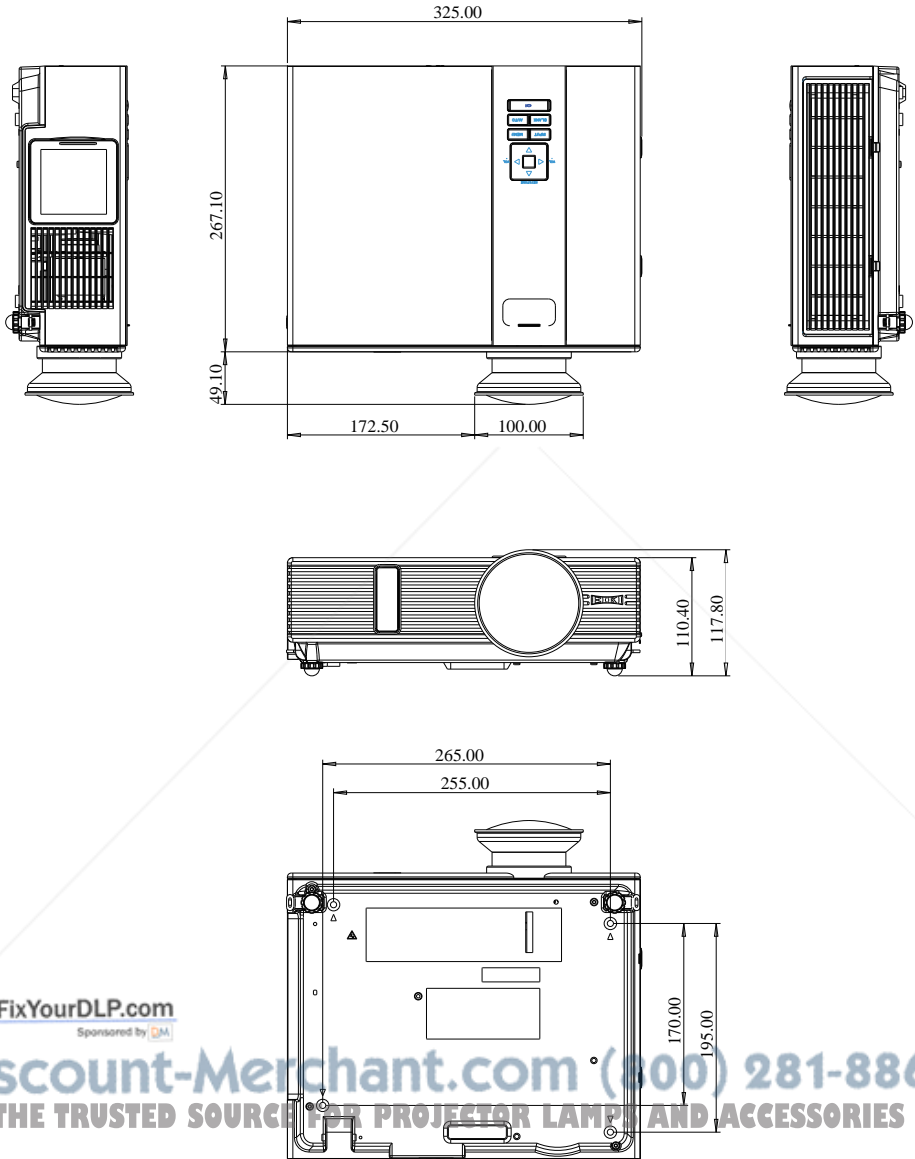

FixYourDLP.com  
Sponsored by D.M.

Discount-Merchant.com (800) 281-8860  
THE TRUSTED SOURCE FOR PROJECTOR LAMP AND ACCESSORIES

Screw for Ceiling Mounted M4x8mm 4pcs

## Appendix

### Configurations of Terminal

#### Analog RGB Input/Output

##### (1) Connections(15P HD-Sub)

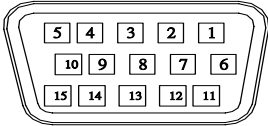

##### (2) Pin Number Define

Pin NO.	Signal Name	Connection
1	R signal Input	R
2	G signal Input	G/Sync. On G
3	B signal Input	B
4	N.C.	N.C.
5	GND	GND
6	R return(GND)	GND
7	G return(GND)	GND
8	B return(GND)	GND
9	N.C.	N.C.
10	N.C.	GND
11	Signal return(GND)	N.C.
12	DDC data	DDC/SDA
13	HSYNC/TTL/Comp.sync	H
14	VSYNC	V
15	DDC clock	DDC/SCL

##### (3) Connector

15P HD-Sub  
) Input signal polarity

- Video signal (RGB): Positive
- Sync: Positive, Negative

(5) Input level

- Signal: 0.7V  $\pm$ 0.2V p-p 75 $\Omega$  terminate, NRZ
- Sync: TTL

(6) Composite Sync.

- TTL: Negative

# Appendix

## Digital Visual Intergrace(DVI-I)

### (1) Connections

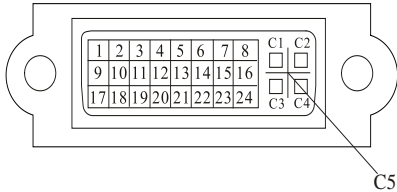

### (2) Pin Number Define

Pin NO.	Signal Name	Pin NO.	Signal Name	Pin NO.	
1	T.M.D.S. Data2-	9	T.M.D.S. Data1-	17	T.M.D.S. Data0-
2	T.M.D.S. Data2+	10	T.M.D.S. Data1+	18	T.M.D.S. Data0+
3	T.M.D.S. Data2/4 Shield	11	T.M.D.S. Data1/3 Shield	19	T.M.D.S. Data0/5 Shield
4	T.M.D.S. Data4-	12	T.M.D.S. Data3-	20	T.M.D.S. Data5-
5	T.M.D.S. Data4+	13	T.M.D.S. Data3+	21	T.M.D.S. Data5+
6	DDC Clock/CLOCK	14	5V Power	22	T.M.D.S. Clock Shield
7	DDC Data	15	Ground(for +5V)	23	T.M.D.S. Clock+
8	No Connect	16	Hot Plug Detect	24	T.M.D.S. Clock-
C1	Analog red	C2	Analog green	C3	Analog blue
C4	Analog horizontal sync	C5	Analog ground (Analog R,G,B return)		

# Appendix

## Component(Y,Pb,Pr/Y,Cb,Cr)

### (1) Connections

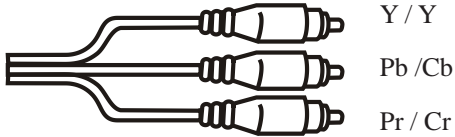

### (2) Pin Number Define

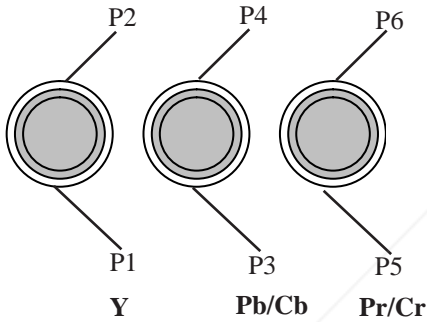

Pin NO.	Signal Name	Connection
2	Y	Y
4	Pb/Cb	Cb
6	Pr/Cr	Cr
1	Signal return(GND)	GND
3	Signal return(GND)	GND
5	Signal return(GND)	GND

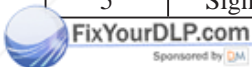

(3) Connector:RCA Jack

**DiscountMerchant.com (800) 281-8860**  
**THE TRUSTED SOURCE FOR PROJECTOR LAMPS AND ACCESSORIES**

## Appendix

### Composite Video Signal

#### (1) Connections

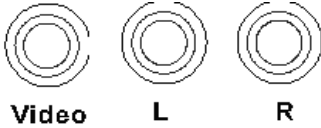

#### (2) Pin Number Define

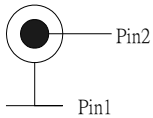

Pin NO.	Signal Name	Connection
1	Video Signal(GND)	GND
2	Video Input	V

(3) Connector: RCA jack

(4) Input signal polarity: Composite signal, Sync: Negative

(5) Input level: Video signal:  $1.0V \pm 0.2V$  p-p  $75\Omega$  terminate, NRZ

## Appendix

### S-Video Signal

#### (1) S-Video Connections and Connector

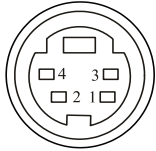

#### (2) Pin Number Define

Pin NO.	Signal Name	Connection
1	Y Signal(GND)	GND
2	C Signal(GND)	GND
3	Y Signal Input	Y
4	C Signal Input	C

#### (3) Input signal polarity

- Composite signal sync: Negative

#### (4) Input level

- Y Signal: 1.0V  $\pm$ 0.2V p-p 75 $\Omega$  terminate, NRZ
- Sync: 0.286V  $\pm$ 0.1V p-p
- Chromatic: 75 $\Omega$  terminate, NRZ
- Burst: 0.286V  $\pm$ 20%



**Discount-Merchant.com (800) 281-8860**  
THE TRUSTED SOURCE FOR PROJECTOR LAMPS AND ACCESSORIES

## Appendix

### RS232 Control

#### Communication Protocol

Items	Specification
Standard Baud rate	9600 bps
Data length	8 bits
Parity	None
Stop bit	1 bit
Flow Control	None

#### RS232 Cable Define

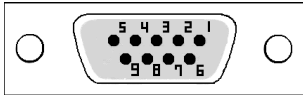

PC Side	Projector side with D-Sub Pin
RX 2	RX 3
TX 3	TX 2
GND 5	GND 5

### USB Connector

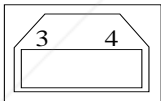

FkYourDLP.com  
Sponsored by 

Pin NO.	Signal Name
1	Data+
2	GND
3	Data-
4	VCC

Discount-Merchant.com (800) 281-8860  
THE TRUSTED SOURCE FOR PROJECTOR LAMPS AND ACCESSORIES



# EIKI

## **U.S.A.**

---

EIKI International, Inc.  
30251 Esperanza  
Rancho Santa Margarita  
CA 92688-2132  
U.S.A.  
Tel: 800-242-3454 (949)-457-0200  
Fax: 800-457-3454 (949)-457-7878  
E-Mail: usa@eiki.com

## **Canada**

---

EIKI CANADA - Eiki International, Inc.  
P.O. Box 156, 310 First St. - Unit 2,  
Midland, ON, L4R 4K8, Canada  
Tel: 800-563-3454 (705)-527-4084  
Fax: 800-567-4069 (705)-527-4087  
E-Mail: canada@eiki.com

## **Deutschland & Österreich**

---

EIKI Deutschland GmbH  
Am Frauwald 12  
65510 Idstein  
Deutschland  
Tel: 06126-9371-0  
Fax: 06126-9371-14  
E-Mail: info@eiki.de

## **Eastern Europe**

---

EIKI CZECH SPOL. s.r.o.  
Nad Cementárnou 1163/4a  
Paraha 4, Podolí  
147 00  
Czech Republic  
Tel: +42 02 4141 0928  
+42 02 4140 3095  
Fax: +42 02 4140 9435  
E-Mail: easterneurope@eiki.de

## **China**

---

EIKI (Shanghai) Co., Ltd.  
LAKESIDE OASIS MIDDLE RING  
BUSINESS CENTRE  
Block 10, #16-07,  
1628, Jin Sha Jiang Road  
Shanghai, 200333  
CHINA  
Tel: 86-21-3251-3993  
Service Hot line: 86-21-3251-3995  
Fax: 86-21-3251-3997  
E-mail: info@eiki-china.com

## **South East Asia**

---

EIKI Industrial (M) Sdn Bhd  
No. 3A-2C, 4th Floor, Jalan PJU 8/3A,  
Perdana Business Centre,  
Bandar Damansara Perdana,  
47820 Petaling Jaya, Selangor  
Malaysia  
Tel: +603-7722-4362  
Fax: +603-7722-4392  
E-Mail: sales@eiki.my

## **Japan & Worldwide**

---

EIKI Industrial Company Limited.  
4-12 Banzai-Cho, Kita-Ku, Osaka,  
530-0028 Japan  
Tel: +81-6-6311-9479  
Fax: +81-6-6311-8486

WorldWide Website <http://www.eiki.com>

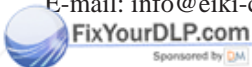

**Discount-Magnets.com (800) 281-8860**  
**THE TRUSTED SOURCE FOR PROJECTOR LAMPS AND ACCESSORIES**



# Disclaimer

This user manual is provided as a free service by FixYourDLP.com. FixYourDLP is in no way responsible for the content of this manual, nor do we guarantee its accuracy. FixYourDLP does not make any claim of copyright and all copyrights remain the property of their respective owners.

About FixYourDLP.com

FixYourDLP.com (<http://www.fixyourdpl.com>) is the World's #1 resource for media product news, reviews, do-it-yourself guides, and manuals.

Informational Blog: <http://www.fixyourdpl.com>

Video Guides: <http://www.fixyourdpl.com/guides>

User Forums: <http://www.fixyourdpl.com/forum>

FixYourDLP's Fight Against Counterfeit Lamps:

<http://www.fixyourdpl.com/counterfeits>

## Sponsors:

RecycleYourLamp.org – Free lamp recycling services for used lamps:

<http://www.recycleyourlamp.org>

Lamp Research - The trusted 3rd party lamp research company:

<http://www.lampresearch.com>

Discount-Merchant.com – The worlds largest lamp distributor:

<http://www.discount-merchant.com>



**FixYourDLP.com**

Sponsored by 