



# Disclaimer

This user manual is provided as a free service by FixYourDLP.com. FixYourDLP is in no way responsible for the content of this manual, nor do we guarantee its accuracy. FixYourDLP does not make any claim of copyright and all copyrights remain the property of their respective owners.

About FixYourDLP.com

FixYourDLP.com (<http://www.fixyourdlp.com>) is the World's #1 resource for media product news, reviews, do-it-yourself guides, and manuals.

Informational Blog: <http://www.fixyourdlp.com>

Video Guides: <http://www.fixyourdlp.com/guides>

User Forums: <http://www.fixyourdlp.com/forum>

FixYourDLP's Fight Against Counterfeit Lamps:

<http://www.fixyourdlp.com/counterfeits>

## Sponsors:

RecycleYourLamp.org – Free lamp recycling services for used lamps:

<http://www.recycleyourlamp.org>

Lamp Research - The trusted 3rd party lamp research company:

<http://www.lampresearch.com>

Discount-Merchant.com – The worlds largest lamp distributor:

<http://www.discount-merchant.com>



**FixYourDLP.com**

Sponsored by 

Portable Projector

# **VT695/VT595/VT590/VT490/VT59/VT49**

---

**User's Manual**



 **FixYourDLP.com**  
Sponsored by 

**Discount-Merchant.com** (800) 581-360

**THE TRUSTED SOURCE FOR PROJECTOR LAMPS AND ACCESSORIES**

- IBM is a trademark or registered trademark of International Business Machines Corporation.
- Macintosh, Mac OS X and PowerBook are trademarks of Apple Computer, Inc., registered in the U.S. and other countries.
- Windows, Windows 98, Windows Me, Windows XP or Windows 2000 are trademarks or registered trademarks of Microsoft Corporation.

Other product and company names mentioned in this user's manual may be the trademarks or registered trademarks of their respective holders.

 FixYourDLP.com  
**Discount-Merchant.com (800) 281-8860**

#### **NOTES**

- (1) The contents of this user's manual may not be reprinted in part or whole without permission.
- (2) The contents of this user's manual are subject to change without notice.
- (3) Great care has been taken in the preparation of this user's manual; however, should you notice any questionable points, errors or omissions, please contact us.
- (4) Notwithstanding article (3), NEC will not be responsible for any claims on loss of profit or other matters deemed to result from using the Projector.

# Important Information

## Safety Cautions

### Precautions

Please read this manual carefully before using your NEC VT695/VT595/VT590/VT490/VT59/VT49 projector and keep the manual handy for future reference. Your serial number is located on the bottom of your projector. Record it here:

#### CAUTION



To turn off main power, be sure to remove the plug from power outlet.  
The power outlet socket should be installed as near to the equipment as possible, and should be easily accessible.

#### CAUTION



TO PREVENT SHOCK, DO NOT OPEN THE CABINET.  
THERE ARE HIGH-VOLTAGE COMPONENTS INSIDE.  
REFER SERVICING TO QUALIFIED SERVICE PERSONNEL.



This symbol warns the user that uninsulated voltage within the unit may be sufficient to cause electrical shock. Therefore, it is dangerous to make any kind of contact with any part inside of the unit.



This symbol alerts the user that important information concerning the operation and maintenance of this unit has been provided.  
The information should be read carefully to avoid problems.

**WARNING:** TO PREVENT FIRE OR SHOCK, DO NOT EXPOSE THIS UNIT TO RAIN OR MOISTURE.  
DO NOT USE THIS UNIT'S PLUG WITH AN EXTENSION CORD OR IN AN OUTLET UNLESS ALL THE PRONGS CAN BE FULLY INSERTED.

### DOC Compliance Notice (for Canada only)

This Class B digital apparatus meets all requirements of the Canadian Interference-Causing Equipment Regulations.

### Machine Noise Information Regulation - 3. GPSGV,

The highest sound pressure level is less than 70 dB (A) in accordance with EN ISO 7779.

#### CAUTION



Avoid displaying stationary images for a prolonged period of time.  
Doing so can result in these images being temporarily sustained on the surface of the LCD panel.  
If this should happen, continue to use your projector. The static background from previous images will disappear.

### Disposing of your used product



EU-wide legislation as implemented in each Member State requires that used electrical and electronic products carrying the mark (left) must be disposed of separately from normal household waste. This includes projectors and their electrical accessories or lamps. When you dispose of such products, please follow the guidance of your local authority and/or ask the shop where you purchased the product.

After collecting the used products, they are reused and recycled in a proper way. This effort will help us reduce the wastes as well as the negative impact such as mercury contained in a lamp to the human health and the environment at the minimum level.

The mark on the electrical and electronic products only applies to the current European Union Member States.

### WARNING TO CALIFORNIA RESIDENTS:

Handling the cables supplied with this product will expose you to lead, a chemical known to the State of California to cause birth defects or other reproductive harm. *WASH HANDS AFTER HANDLING.*

### RF Interference (for USA only)

#### WARNING

The Federal Communications Commission does not allow any modifications or changes to the unit EXCEPT those specified by NEC Corporation of America in this manual. Failure to comply with this government regulation could void your right to operate this equipment. This equipment has been tested and found to comply with the limits for a Class B digital device, pursuant to Part 15 of the FCC Rules. These limits are designed to provide reasonable protection against harmful interference in a residential installation. This equipment generates, uses, and can radiate radio frequency energy and, if not installed and used in accordance with the instructions, may cause harmful interference to radio communications. However, there is no guarantee that interference will not occur in a particular installation.

If this equipment does cause harmful interference to radio or television reception, which can be determined by turning the equipment off and on, the user is encouraged to try to correct the interference by one or more of the following measures:

- Reorient or relocate the receiving antenna.
- Increase the separation between the equipment and receiver.
- Connect the equipment into an outlet on a circuit different from that to which the receiver is connected.
- Consult the dealer or an experienced radio / TV technician for help.

For UK only: In UK, a BS approved power cable with moulded plug has a Black (five Amps) fuse installed for use with this equipment. If a power cable is not supplied with this equipment please contact your supplier.

### Important Safeguards

These safety instructions are to ensure the long life of your projector and to prevent fire and shock. Please read them carefully and heed all warnings.

#### Installation

- Do not place the projector in the following conditions:
  - on an unstable cart, stand, or table.
  - near water, baths, or damp rooms.
  - in direct sunlight, near heaters, or heat radiating appliances.
  - in a dusty, smoky or steamy environment.
  - on a sheet of paper or cloth, rugs or carpets.
- If you wish to have the projector installed on the ceiling:
  - Do not attempt to install the projector yourself.
  - ~~The projector must~~ be installed by qualified technicians in order to ensure proper operation and reduce the risk of bodily injury.
  - In addition, the ceiling must be strong enough to support the projector and the installation must be in accordance with any local building codes.
  - Please consult your dealer for more information.

### Place the projector in a horizontal position

The tilt angle of the projector should not exceed 10 degrees, nor should the projector be installed in any way other than the desktop and ceiling mount, otherwise lamp life could decrease dramatically.



### ⚠ Fire and Shock Precautions ⚡

- Ensure that there is sufficient ventilation and that vents are unobstructed to prevent the build-up of heat inside your projector. Allow at least 4 inches (10cm) of space between your projector and a wall.
- Do not try to touch the ventilation outlet on the left front (when seen from the front) as it can become heated while the projector is turned on and immediately after the projector is turned off.
- Prevent foreign objects such as paper clips and bits of paper from falling into your projector. Do not attempt to retrieve any objects that might fall into your projector. Do not insert any metal objects such as a wire or screwdriver into your projector. If something should fall into your projector, disconnect it immediately and have the object removed by a qualified service personnel.
- Do not place any objects on top of the projector.
- Do not touch the power plug during a thunderstorm. Doing so can cause electrical shock or fire.
- The projector is designed to operate on a power supply of 100-240V AC 50/60 Hz. Ensure that your power supply fits this requirement before attempting to use your projector.
- Do not look into the lens while the projector is on. Serious damage to your eyes could result.
- Keep any items such as magnifying glass out of the light path of the projector. The light being projected from the lens is extensive, therefore any kind of abnormal objects that can redirect light coming out of the lens, can cause unpredictable outcome such as fire or injury to the eyes.
- Do not cover the lens with the black lens cap or equivalent while the projector is on. Doing so can lead to melting of the cap and possibly burning your hands due to the heat emitted from the light output.
- Do not place any objects, which are easily affected by heat, in front of the projector lens or a projector exhaust vent. Doing so could lead to the object melting or getting your hands burned from the heat that is emitted from the light output and exhaust.
- Handle the power cable carefully. A damaged or frayed power cable can cause electric shock or fire.
  - Do not use any power cables than the supplied one.
  - Do not bend or tug the power cable excessively.
  - Do not place the power cable under the projector, or any heavy object.
  - Do not cover the power cable with other soft materials such as rugs.
  - Do not heat the power cable.
  - Do not handle the power plug with wet hands.
- Turn off the projector, unplug the power cable and have the object removed by a qualified NEC service personnel under the following conditions:
  - When the power cable or plug is damaged or frayed.
  - If liquid has been spilled into the projector, or if it has been exposed to rain or water.
  - If the projector does not operate normally when you follow the instructions described in this user's manual.
  - If the projector has been dropped or the cabinet has been damaged.
  - If the projector exhibits a distinct change in performance, indicating a need for service.
  - If the projector is not to be used for an extended period of time.
- Disconnect the power cable and any other cables before carrying the projector.
- Turn off the projector and unplug the power cable before cleaning the cabinet or replacing the lamp.

### CAUTION

- Do not use the tilt-foot for purposes other than originally intended. Misuses such as gripping the tilt-foot or hanging on the wall can cause damage to the projector.
- Do not send the projector in the soft case by parcel delivery service or cargo shipment. The projector inside the soft case could be damaged.
- When carrying the projector by the carrying handle, make sure the two screws that attach the carrying handle to the projector cabinet are tight.  
Insufficient tightening of the two screws could result in the projector falling and causing injury.
- Select [High] in Fan mode if you continue to use the projector for consecutive days. (From the menu, select [Setup] → [Options] → [Fan Mode] → [High].)
- Do not turn off the AC power by pressing the main power switch or by unplugging the power cable when the projector is powered on.
- Do not turn off the AC power for 60 seconds after the lamp is turned on and while the POWER indicator is blinking green. Doing so could cause premature lamp failure.

### Remote Control Precautions

- Handle the remote control carefully.
- If the remote control gets wet, wipe it dry immediately.
- Avoid excessive heat and humidity.
- Do not heat, take apart, or throw batteries into fire.
- If you will not be using the remote control for a long time, remove the batteries.
- Ensure that you have the batteries' polarity (+/-) aligned correctly.
- Do not use new and old batteries together, or use different types of batteries together.
- Dispose of used batteries according to your local regulations.

### Lamp Replacement

- To replace the lamp, follow all instructions provided on page 52.
- Be sure to replace the lamp when the message **[The lamp has reached the end of its usable life. Please replace the lamp.]** appears. If you continue to use the lamp after the lamp has reached the end of its usable life, the lamp bulb may shatter, and pieces of glass may be scattered in the lamp case. Do not touch them as the pieces of glass may cause injury.

If this happens, contact your dealer for lamp replacement.

### A Lamp Characteristic

The projector has a high-pressure mercury lamp as a light source.

The lamp has a characteristic that its brightness gradually decreases with age. Also repeatedly turning the lamp on and off will increase the possibility of its lower brightness.

### CAUTION:

When removing the lamp from a ceiling-mounted projector, make sure that no one is under the projector. Glass fragments could fall if the lamp has been burned out.

# Table of Contents

<b>Important Information</b> .....	<b>i</b>
<b>1. Introduction</b> .....	<b>1</b>
<b>1</b> What's in the Box? .....	1
<b>2</b> Introduction to the Projector .....	2
<b>3</b> Part Names of the Projector .....	3
Attaching the supplied carrying handle (VT695, VT595, VT590 and VT490 only) .....	4
Top Features .....	5
Terminal Panel Features .....	6
<b>4</b> Part Names of the Remote Control .....	7
Battery Installation .....	8
Remote Control Precautions .....	8
Operating Range for Wireless Remote Control .....	8
<b>2. Installation and Connections</b> .....	<b>9</b>
<b>1</b> Setting Up the Screen and the Projector .....	9
Selecting a Location (VT695) .....	9
Selecting a Location (VT595/VT590/VT490/VT59) .....	10
Selecting a Location (VT49) .....	10
Throw Distance and Screen Size .....	11
<b>2</b> Making Connections .....	13
Enabling the computer's external display .....	13
Connecting Your PC or Macintosh Computer .....	13
When Viewing a DVI Digital Signal (VT695/VT595) .....	14
Using Two Analog COMPUTER Inputs Simultaneously (VT695/VT595) .....	15
Connecting an External Monitor .....	16
Connecting Your DVD Player with Component Output .....	17
Connecting Your VCR or Laser Disc Player .....	18
Connecting the Supplied Power Cable .....	19
<b>3. Projecting an Image (Basic Operation)</b> .....	<b>20</b>
<b>1</b> Turning on the Projector .....	20
Note on Startup screen (Menu Language Select screen) .....	21
<b>2</b> Selecting a Source .....	22
<b>3</b> Adjusting the Picture Size and Position .....	23
<b>4</b> Correcting Keystone Distortion .....	25
<b>5</b> Optimizing RGB Picture Automatically .....	27
<b>6</b> Turning Up or Down Volume .....	27
<b>7</b> Turning off the Projector .....	28
<b>8</b> After Use .....	29



FixYourDLP.com  
Sponsor

Discount-Merchant.com (800) 281-8880  
THE TRUSTED SOURCE FOR PROJECTOR LAMPS AND ACCESSORIES



<b>4. Convenient Features -----</b>	<b>30</b>
<b>①</b> Turning off the Image and Sound -----	30
<b>②</b> Freezing a Picture -----	30
<b>③</b> Enlarging a Picture -----	30
<b>④</b> Changing Lamp Mode -----	31
<b>⑤</b> Preventing the Unauthorized Use of the Projector -----	31
<b>⑥</b> Using the Optional Remote Mouse Receiver (NP01MR) -----	34
<b>5. Using On-Screen Menu -----</b>	<b>36</b>
<b>①</b> Using the Menu -----	36
<b>②</b> Menu Elements -----	38
<b>③</b> List of Menu Items -----	39
<b>④</b> Menu Descriptions & Functions [Picture] -----	41
<b>⑤</b> Menu Descriptions & Functions [Image Options] -----	42
<b>⑥</b> Menu Descriptions & Functions [Setup] -----	44
<b>⑦</b> Menu Descriptions & Functions [Information] -----	48
<b>⑧</b> Menu Descriptions & Functions [Reset] -----	49
<b>6. Maintenance -----</b>	<b>50</b>
<b>①</b> Cleaning or Replacing the Filters -----	50
<b>②</b> Cleaning the Cabinet and the Lens -----	51
<b>③</b> Replacing the Lamp -----	52
<b>7. Appendix -----</b>	<b>55</b>
<b>①</b> Troubleshooting -----	55
<b>②</b> Specifications -----	58
<b>③</b> Cabinet Dimensions -----	61
<b>④</b> Pin Assignments of D-Sub COMPUTER Input Connector -----	62
<b>⑤</b> Compatible Input Signal List -----	63
<b>⑥</b> PC Control Codes and Cable Connection -----	64
<b>⑦</b> Troubleshooting Check List -----	66
<b>⑧</b> TravelCare Guide -----	68



**Discount-Merchant.com (800) 281-8860**  
**THE TRUSTED SOURCE FOR PROJECTOR LAMPS AND ACCESSORIES**

# 1. Introduction

## ① What's in the Box?

Make sure your box contains everything listed. If any pieces are missing, contact your dealer. Please save the original box and packing materials if you ever need to ship your projector.

Projector

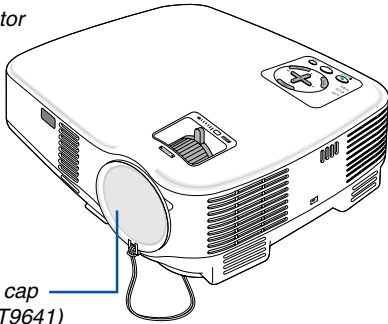

Lens cap  
(24FT9641)

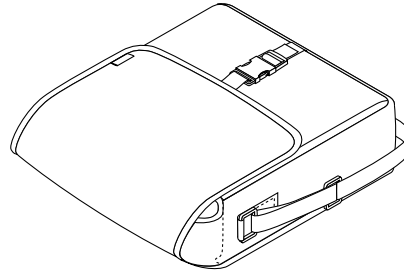

Soft case  
(24BS7582)

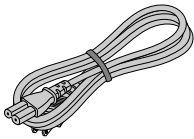

Power cable  
(US: 7N080220)  
(EU: 7N080015)

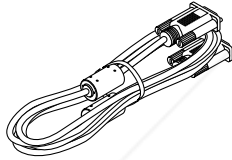

VGA signal cable  
(7N520052)

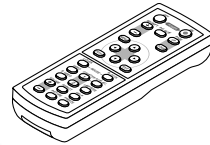

Remote control  
(7N900731)

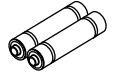

Batteries (AAA × 2)

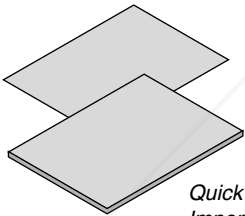

Quick Setup Guide  
Important Information

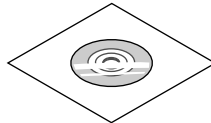

CD-ROM  
User's manual

**For North America only**  
Registration card  
Limited warranty  
**For Europe only**  
Guarantee policy

**For VT695, VT595, VT590  
and VT490 only**

FixYourDLP.com

Sponsored by

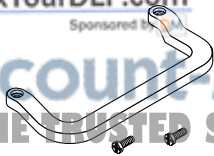

Carrying handle (24FT9651)  
Screw (M4 × 2: 24V00411)

**For VT695 and VT595 only**



DVI to VGA adapter (7N960231)

Discount Merchant (800) 281-8860  
THE TRUSTED SOURCE FOR PROJECTOR LAMPS AND ACCESSORIES

## 2 Introduction to the Projector

This section introduces you to your new projector and describes the features and controls.

### Congratulations on Your Purchase of the Projector

This projector is one of the very best projectors available today. The projector enables you to project precise images up to 300 inches across (measured diagonally) from your PC or Macintosh computer (desktop or notebook), VCR, DVD player, document camera, or a laser disc player.

You can use the projector on a tabletop or cart, you can use the projector to project images from behind the screen, and the projector can be permanently mounted on a ceiling\*<sup>1</sup>. The remote control can be used wirelessly.

\*<sup>1</sup> Do not attempt to mount the projector on a ceiling yourself.

The projector must be installed by qualified technicians in order to ensure proper operation and reduce the risk of bodily injury.

In addition, the ceiling must be strong enough to support the projector and the installation must be in accordance with any local building codes. Please consult your dealer for more information.

### Features you'll enjoy:

- Auto vertical keystone correction up to +/- 30 degrees (VT695 and VT595 only)
- Built-in Wall Color Correction presets provide for adaptive color correction when projecting onto non-white screen material

- Quick start & quick cool down

Eight seconds after turning on the power, the projector is ready to display PC or video images.

Powering down; The fans stop 30 seconds after turning off the power from the remote control or cabinet control panel. The projector can be put away immediately after the projector is powered down.

Also, the main power of the projector can be turned off by pressing the main power switch or unplugging the power cable even during the cool down period after the projector is turned off.

- DVI input connector (DVI-I 29 Pin) with HDCP compatible (VT695 and VT595 only)
- HDTV (1080i, 720p) and SDTV (576p, 480p) compatibility
- Color Management system
- Short focal length lens
- Display popular wide screen and full screen aspect ratios – 16:9 and 4:3
- Built-in speaker for an integrated audio solution
- High resolution display - up to UXGA compatible, XGA native resolution (SVGA: VT490 and VT49).
- Multiple video mode selections (depending on your source)
- Security feature prevents unauthorized individuals from displaying images.
- You can control the projector with a PC or control system using the PC Control port.
- Easy set up and operation

The contemporary cabinet design is light, compact and complements any office, boardroom Auditorium.

You can use the supplied wireless remote control and the optional remote mouse receiver to operate your PC mouse from across the room. The optional remote mouse receiver (NP01MR) supports almost any PC using a USB connection.

### About this user's manual

The fastest way to get started is to take your time and do everything right the first time. Take a few minutes now to review the user's manual. This may save you time later on. At the beginning of each section of the manual you'll find an overview. If the section doesn't apply, you can skip it.

### 3 Part Names of the Projector

#### Front/Top

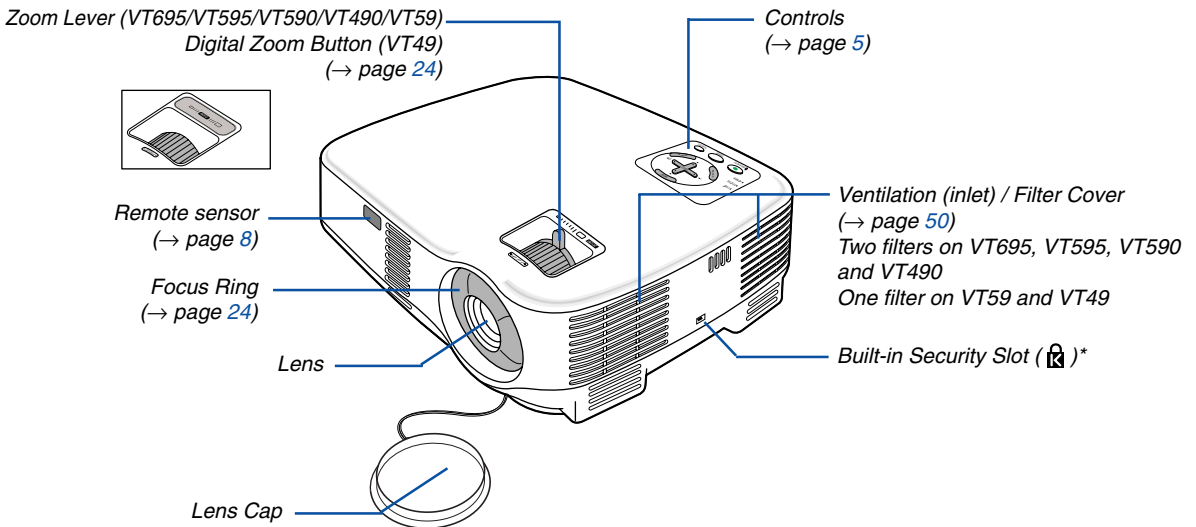

\* This security slot supports the MicroSaver® Security System. MicroSaver® is a registered trademark of Kensington Microware Inc. The logo is trademarked and owned by Kensington Microware Inc.

#### Rear

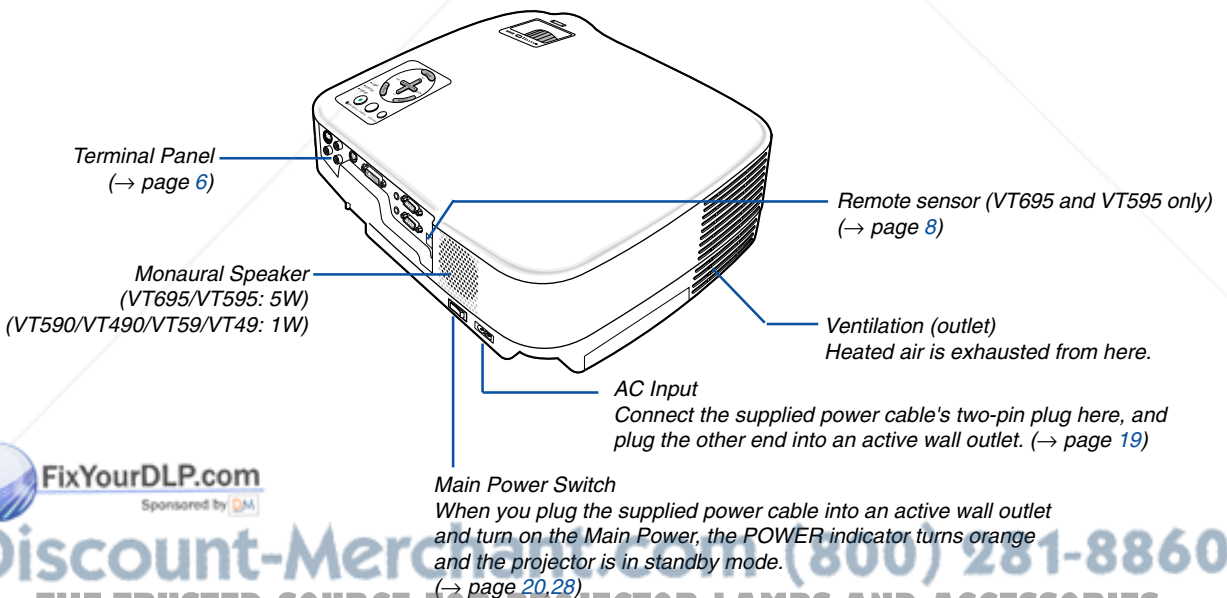

Discount-Merch.com (800) 281-8860  
THE TRUSTED SOURCE FOR PROJECTOR LAMPS AND ACCESSORIES

**Bottom**

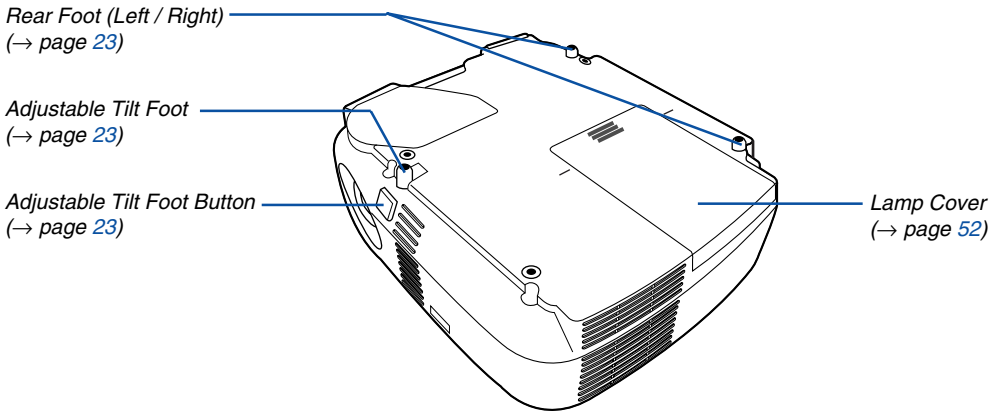

**Attaching the supplied carrying handle (VT695, VT595, VT590 and VT490 only)**

You can carry the projector by attaching the supplied carrying handle securely to the projector. To attach the supplied carrying handle, use a Phillips-head screwdriver and the supplied two screws. Place a soft cloth on the working surface before turning the projector over to prevent scratching the top cover. Make sure that the carrying handle is attached with correct orientation as shown below.

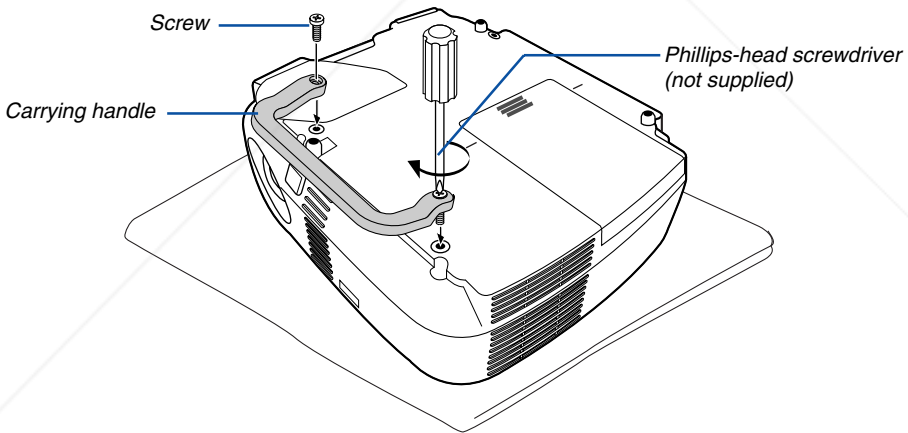

**CAUTION**

When carrying the projector by the carrying handle, make sure the two screws that attach the carrying handle to the projector cabinet are tight.



FixYourDLP.com  
Sponsored by DM

**Discount-Merchant.com (800) 281-8860**  
**THE TRUSTED SOURCE FOR PROJECTOR LAMPS AND ACCESSORIES**

Top Features

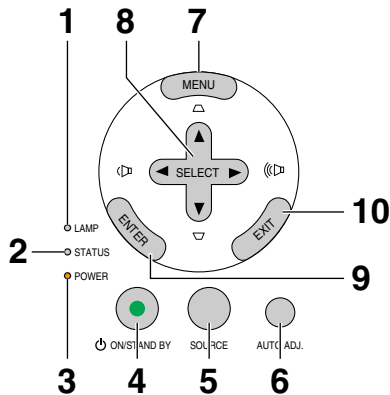

- 1. LAMP Indicator (→page 52,55)
- 2. STATUS Indicator (→page 55)
- 3. POWER Indicator (→page 20,28,55)
- 4. POWER Button (ON / STAND BY) (⏻)  
(→page 20,28)
- 5. SOURCE Button (→page 22)
- 6. AUTO ADJ. Button (→page 27)
- 7. MENU Button (→page 36)
- 8. SELECT ▲▼◀▶ / Volume Buttons ◀▶ /  
Keystone Buttons ▲▼ (→page 25,27)
- 9. ENTER Button
- 10. EXIT Button



**Discount-Merchant.com (800) 281-8860**  
**THE TRUSTED SOURCE FOR PROJECTOR LAMPS AND ACCESSORIES**

## Terminal Panel Features

## VT695/VT595

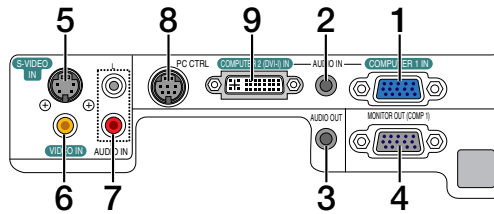

## VT590/VT490/VT59/VT49

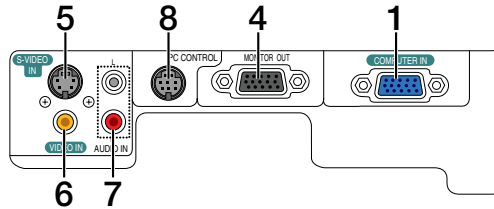

1. **COMPUTER 1 IN/ Component Input Connector (Mini D-Sub 15 Pin)**  
(VT695/VT595) (→page 13,15)  
**COMPUTER IN/ Component Input Connector (Mini D-Sub 15 Pin)**  
(VT590/VT490/VT59/VT49) (→page 13,17)
2. **AUDIO IN Mini Jack (Stereo Mini)** (→page 13,14,17)  
(VT695/VT595)
3. **AUDIO OUT Mini Jack (Stereo Mini)** (→page 16)  
(VT695/VT595)
4. **MONITOR OUT Connector (Mini D-Sub 15 Pin)**  
(→page 16)
5. **S-VIDEO IN Connector (Mini DIN 4 Pin)**  
(→page 18)
6. **VIDEO IN Connector (RCA)** (→page 18)
7. **AUDIO Input Jacks L/R (RCA)** (→page 13,17,18)
8. **PC CONTROL Port (DIN 8 Pin)** (→page 64,65)  
Use this port to connect a PC or control system.  
This enables you to control the projector using serial communication protocol. If you are writing your own program, typical PC control codes are on page 64.
9. **COMPUTER 2 (DVI-I) IN (DVI-I 29 Pin)** (→page 14,15)  
(VT695/VT595)

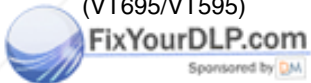

**Discount-Merchant.com (800) 281-8860**  
THE TRUSTED SOURCE FOR PROJECTOR LAMPS AND ACCESSORIES

## 4 Part Names of the Remote Control

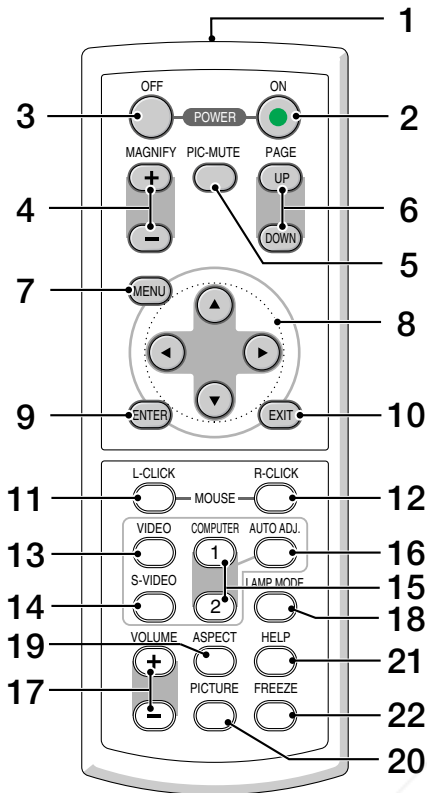

**1. Infrared Transmitter**

(→ page 8)

**2. POWER ON Button**

(→ page 20)

**3. POWER OFF Button**

(→ page 28)

**4. MAGNIFY (+)(-) Button**

(→ page 30)

**5. PIC-MUTE Button**

(→ page 30)

**6. PAGE UP/DOWN Button\***

(→ page 34,35)

**7. MENU Button**

(→ page 36)

**8. SELECT ▲▼▶◀ Button**

**9. ENTER Button**

**10. EXIT Button**

**11. MOUSE L-CLICK Button\***

(→ page 34,35)

**12. MOUSE R-CLICK Button\***

(→ page 34,35)

**13. VIDEO Button**

(→ page 22)

**14. S-VIDEO Button**

(→ page 22)

**15. COMPUTER 1/2 Button**

(The **COMPUTER 2** button is not available on VT590, VT490, VT59 and VT49)

(→ page 22)

**16. AUTO ADJ. Button**

(→ page 27)

**17. VOLUME (+)(-) Button**

(→ page 27)

**18. LAMP MODE Button** (→ page 31)

**19. ASPECT Button**

(→ page 42)

**20. PICTURE Button**

(→ page 41,42)

**21. HELP Button**

(→ page 48)

**22. FREEZE Button**

(→ page 30)

\* The PAGE UP/DOWN, MOUSE L-CLICK and MOUSE R-CLICK buttons work only when the optional remote mouse receiver is connected with your computer.



## Battery Installation

**1** Press firmly and slide the battery cover off.

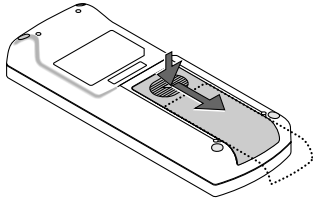

**2** Install new batteries (AAA). Ensure that you have the batteries' polarity (+/-) aligned correctly.

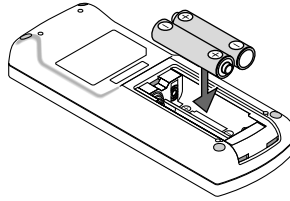

**3** Slip the cover back over the batteries until it snaps into place. Do not mix different types of batteries or new and old batteries.

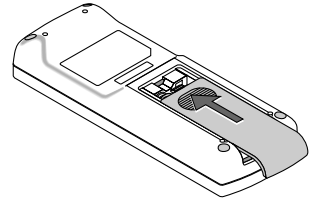

## Remote Control Precautions

- Handle the remote control carefully.
- If the remote control gets wet, wipe it dry immediately.
- Avoid excessive heat and humidity.
- Do not heat, take apart, or throw batteries into fire.
- If you will not be using the remote control for a long time, remove the batteries.
- Ensure that you have the batteries' polarity (+/-) aligned correctly.
- Do not use new and old batteries together, or use different types of batteries together.
- Dispose of used batteries according to your local regulations.

## Operating Range for Wireless Remote Control

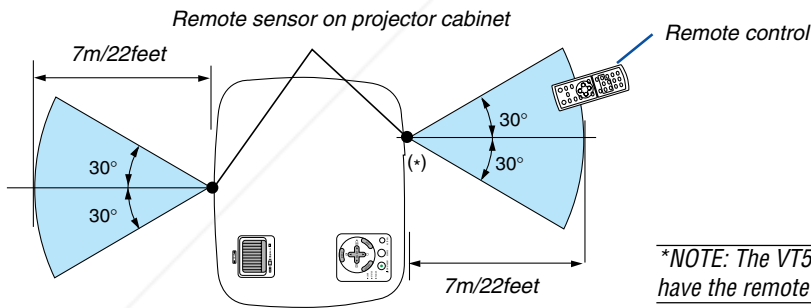

- The infrared signal operates by line-of-sight up to a distance of about 22 feet/7 m and within a 60-degree angle of the remote sensor on the projector cabinet.
- The projector will not respond if there are objects between the remote control and the sensor, or if strong light falls on the sensor. Weak batteries will also prevent the remote control from properly operating the projector.

# 2. Installation and Connections

This section describes how to set up your projector and how to connect video and audio sources. Your projector is simple to set up and use. But before you get started, you must first:

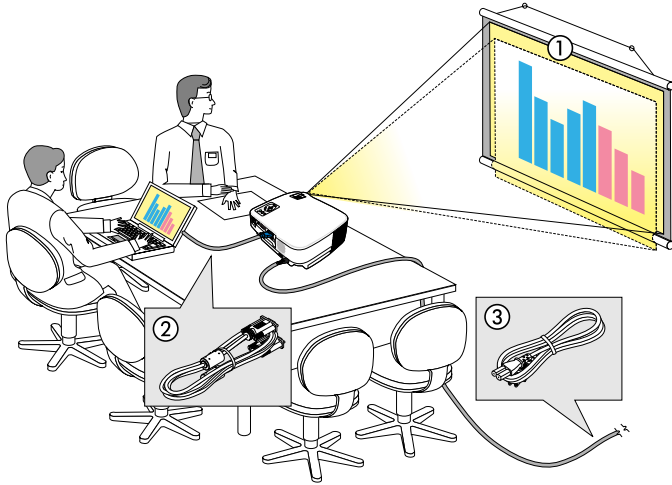

- 1 Set up a screen and the projector.
- 2 Connect your computer or video equipment to the projector.  
(→ page 13, 14, 15, 16, 17, 18)
- 3 Connect the supplied power cable.  
(→ page 19)

**NOTE:** Ensure that the power cable and any other cables are disconnected before moving the projector. When moving the projector or when it is not in use, cover the lens with the lens cap.

## 1 Setting Up the Screen and the Projector

### Selecting a Location (VT695)

The further your projector is from the screen or wall, the larger the image. The minimum size the image can be is approximately 21" (0.53 m) measured diagonally when the projector is roughly 38 inches (1.0 m) from the wall or screen. The largest the image can be is 300" (7.6 m) when the projector is about 389 inches (9.9 m) from the wall or screen.

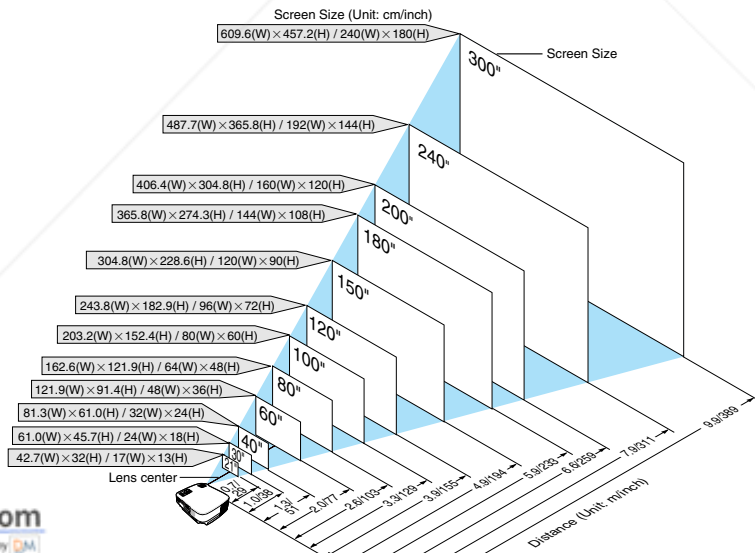

Discount-Merchant.com (800) 281-8860

**TIP: THE TRUSTED SOURCE FOR PROJECTOR LAMPS AND ACCESSORIES**

- The distances are indicated by intermediate values between tele and wide. Use as a rule of thumb.
- The Zoom lever adjusts the image size +/- 10%
- For more details on throw distance, see page 11.

### Selecting a Location (VT595/VT590/VT490/VT59)

The further your projector is from the screen or wall, the larger the image. The minimum size the image can be is approximately 21" (0.53 m) measured diagonally when the projector is roughly 30 inches (0.8 m) from the wall or screen. The largest the image can be is 300" (7.6 m) when the projector is about 400 inches (10 m) from the wall or screen.

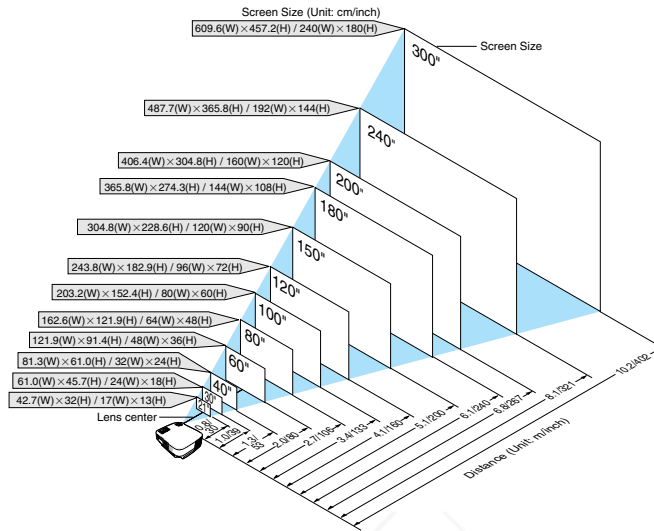

**TIP:**

- The distances are indicated by intermediate values between tele and wide. Use as a rule of thumb.
- The Zoom lever adjusts the image size +/-10%
- For more details on throw distance, see page 11.

### Selecting a Location (VT49)

The further your projector is from the screen or wall, the larger the image. The minimum size the image can be is approximately 25" (0.64 m) measured diagonally when the projector is roughly 35 inches (0.9 m) from the wall or screen. The largest the image can be is 300" (7.6 m) when the projector is about 434 inches (11.0 m) from the wall or screen. Use the drawing below as a guide.

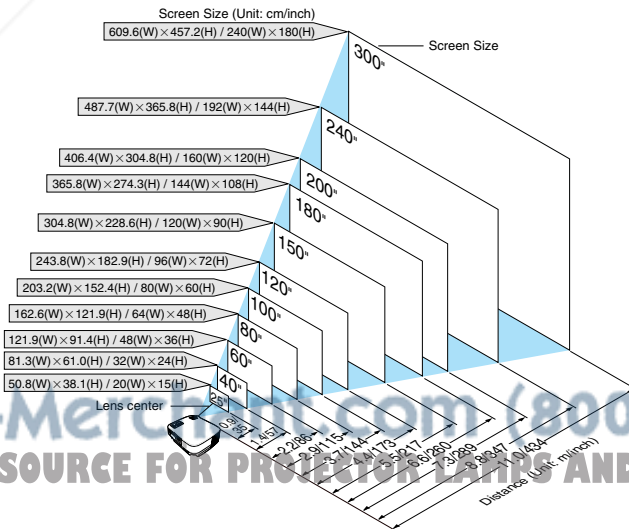

Discount-Merch.com (800) 281-8860  
 THE TRUSTED SOURCE FOR PROJECTOR LAMP AND ACCESSORIES

**TIP:**

- The distances are indicated by intermediate values between tele and wide. Use as a rule of thumb.
- Digital Zoom can result in a blurry image due to the electronic zoom.
- The Zoom button adjusts the image size -10%
- For more details on throw distance, see next page.

## 2. Installation and Connections

### Throw Distance and Screen Size

The following shows the proper relative positions of the projector and screen. Refer to the table to determine the position of installation.

#### Distance Chart

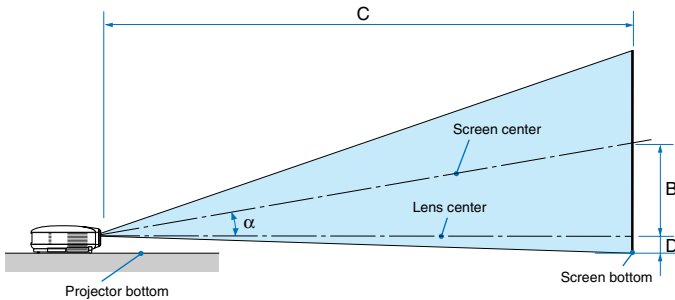

- B = Vertical distance between lens center and screen center
- C = Throw distance
- D = Vertical distance between lens center and screen bottom (top of screen for ceiling application)
- $\alpha$  = Throw angle

*NOTE: Distances may vary +/-5%.*

#### VT695

Diagonal		Screen Size				B		C				D		$\alpha$			
		Width		Height				wide		tele				wide	tele		
inch	mm	inch	mm	inch	mm	inch	mm	inch	mm	-	inch	mm	inch	mm	degree	-	degree
21	533	17	427	13	320	4	110	-	-	-	29	730	-2	-50	-	-	8.6
25	635	20	508	15	381	5	130	28	720	-	34	870	-2	-60	10.3	-	8.6
30	762	24	610	18	457	6	160	34	870	-	41	1050	-3	-70	10.2	-	8.5
40	1016	32	813	24	610	8	210	46	1170	-	56	1410	-4	-100	10.1	-	8.4
60	1524	48	1219	36	914	12	310	70	1770	-	84	2130	-6	-140	10.1	-	8.4
72	1829	58	1463	43	1097	15	380	84	2130	-	101	2560	-7	-170	10.0	-	8.4
80	2032	64	1626	48	1219	17	420	93	2370	-	112	2850	-8	-190	10.0	-	8.4
84	2134	67	1707	50	1280	17	440	98	2490	-	118	2990	-8	-200	10.0	-	8.4
90	2286	72	1829	54	1372	19	470	105	2670	-	126	3210	-8	-210	10.0	-	8.4
100	2540	80	2032	60	1524	21	520	117	2970	-	141	3570	-9	-240	10.0	-	8.3
120	3048	96	2438	72	1829	25	630	141	3570	-	169	4290	-11	-290	10.0	-	8.3
150	3810	120	3048	90	2286	31	790	176	4470	-	211	5370	-14	-360	10.0	-	8.3
180	4572	144	3658	108	2743	37	940	211	5370	-	254	6450	-17	-430	10.0	-	8.3
200	5080	160	4064	120	3048	41	1050	235	5970	-	282	7170	-19	-480	10.0	-	8.3
210	5334	168	4267	126	3200	43	1100	247	6270	-	296	7530	-20	-500	10.0	-	8.3
240	6096	192	4877	144	3658	50	1260	282	7170	-	339	8610	-23	-570	9.9	-	8.3
270	6858	216	5486	162	4115	56	1410	318	8070	-	381	9690	-25	-640	9.9	-	8.3
300	7620	240	6096	180	4572	62	1570	353	8970	-	424	10770	-28	-710	9.9	-	8.3

#### VT595/VT590/VT490/VT59

Diagonal		Screen Size				B		C				D		$\alpha$			
		Width		Height				wide		tele				wide	tele		
inch	mm	inch	mm	inch	mm	inch	mm	inch	mm	-	inch	mm	inch	mm	degree	-	degree
21	533	17	427	13	320	4	110	-	-	-	30	750	-2	-50	-	-	8.6
25	635	20	508	15	381	5	140	29	740	-	35	900	-2	-60	10.3	-	8.5
30	762	24	610	18	457	6	160	35	900	-	43	1090	-3	-70	10.2	-	8.5
40	1016	32	813	24	610	9	220	48	1210	-	57	1460	-3	-90	10.1	-	8.4
60	1524	48	1219	36	914	13	320	72	1830	-	87	2200	-5	-130	10.1	-	8.4
72	1829	58	1463	43	1097	15	390	87	2200	-	104	2650	-6	-160	10.0	-	8.4
80	2032	64	1626	48	1219	17	430	96	2450	-	116	2940	-7	-180	10.0	-	8.4
84	2134	67	1707	50	1280	18	450	101	2570	-	122	3090	-7	-190	10.0	-	8.4
90	2286	72	1829	54	1372	19	490	109	2760	-	131	3310	-8	-200	10.0	-	8.4
100	2540	80	2032	60	1524	21	540	121	3070	-	145	3690	-9	-220	10.0	-	8.3
120	3048	96	2438	72	1829	26	650	145	3690	-	174	4430	-10	-270	10.0	-	8.3
150	3810	120	3048	90	2286	32	810	182	4620	-	218	5540	-13	-330	10.0	-	8.3
180	4572	144	3658	108	2743	38	970	218	5540	-	262	6660	-16	-400	10.0	-	8.3
200	5080	160	4064	120	3048	43	1080	243	6160	-	291	7400	-17	-440	10.0	-	8.3
210	5334	168	4267	126	3200	45	1140	255	6470	-	306	7770	-18	-460	10.0	-	8.3
240	6096	192	4877	144	3658	51	1300	291	7400	-	350	8890	-21	-530	9.9	-	8.3
270	6858	216	5486	162	4115	57	1460	328	8330	-	394	10000	-24	-600	9.9	-	8.3
300	7620	240	6096	180	4572	64	1620	365	9260	-	438	11120	-26	-660	9.9	-	8.3

VT49

Diagonal		Screen Size				B		C		D		α
		Width		Height								
inch	mm	inch	mm	inch	mm	inch	mm	inch	mm	inch	mm	degree
25	635	20	508	15	381	5	140	35	890	-2	-60	8.7
30	762	24	610	18	457	6	160	42	1070	-3	-70	8.6
40	1016	32	813	24	610	9	220	57	1440	-3	-90	8.5
60	1524	48	1219	36	914	13	320	86	2180	-5	-130	8.5
72	1829	58	1463	43	1097	15	390	103	2620	-6	-160	8.4
80	2032	64	1626	48	1219	17	430	115	2920	-7	-180	8.4
84	2134	67	1707	50	1280	18	450	121	3060	-7	-190	8.4
90	2286	72	1829	54	1372	19	490	129	3290	-8	-200	8.4
100	2540	80	2032	60	1524	21	540	144	3650	-9	-220	8.4
120	3048	96	2438	72	1829	26	650	173	4390	-10	-270	8.4
150	3810	120	3048	90	2286	32	810	217	5500	-13	-330	8.4
180	4572	144	3658	108	2743	38	970	260	6610	-16	-400	8.4
200	5080	160	4064	120	3048	43	1080	289	7340	-17	-440	8.4
210	5334	168	4267	126	3200	45	1140	304	7710	-18	-460	8.4
240	6096	192	4877	144	3658	51	1300	347	8820	-21	-530	8.4
270	6858	216	5486	162	4115	57	1460	391	9930	-24	-600	8.4
300	7620	240	6096	180	4572	64	1620	434	11030	-26	-660	8.4

**WARNING**

- \* Installing your projector on the ceiling must be done by a qualified technician. Contact your NEC dealer for more information.
- \* Do not attempt to install the projector yourself.
- Only use your projector on a solid, level surface. If the projector falls to the ground, you can be injured and the projector severely damaged.
- Do not use the projector where temperatures vary greatly. The projector must be used at temperatures between 41°F (5°C) and 104°F (40°C) (Eco mode selected automatically at 95°F to 104°F/35°C to 40°C).
- Do not expose the projector to moisture, dust, or smoke. This will harm the screen image.
- Ensure that you have adequate ventilation around your projector so heat can dissipate. Do not cover the vents on the side or the front of the projector.

**Reflecting the Image**

Using a mirror to reflect your projector's image enables you to enjoy a much larger image when a smaller space is required. Contact your NEC dealer if you need a mirror system. If you're using a mirror system and your image is inverted, use the MENU and SELECT buttons on your projector cabinet or your remote control to correct the orientation. (→ page 45)



**Discount-Merchant.com (800) 281-8860**  
**THE TRUSTED SOURCE FOR PROJECTOR LAMPS AND ACCESSORIES**



## 2. Installation and Connections

### When Viewing a DVI Digital Signal (VT695/VT595)

To project a DVI digital signal, be sure to connect the PC and the projector using a DVI cable (not supplied) before turning on your PC or projector. Turn on the projector first and select Computer 2 (Digital) from the source menu before turning on your PC.

Failure to do so may not activate the digital output of the graphics card resulting in no picture being displayed. Should this happen, restart your PC.

Do not disconnect the DVI cable while the projector is running. If the signal cable has been disconnected and then re-connected, an image may not be correctly displayed. Should this happen, restart your PC.

#### NOTE:

- Use a DVI cable or the one compliant with DDWG (Digital Display Working Group) DVI (Digital Visual Interface) revision 1.0 standard. The DVI cable should be within 5 m (196") long. Both single and dual types of DVI cable can be used.
- The DVI (DIGITAL) connector accepts VGA (640x480), SVGA (800x600), 1152x864, XGA (1024x768) and SXGA (1280x1024 @ up to 60Hz).

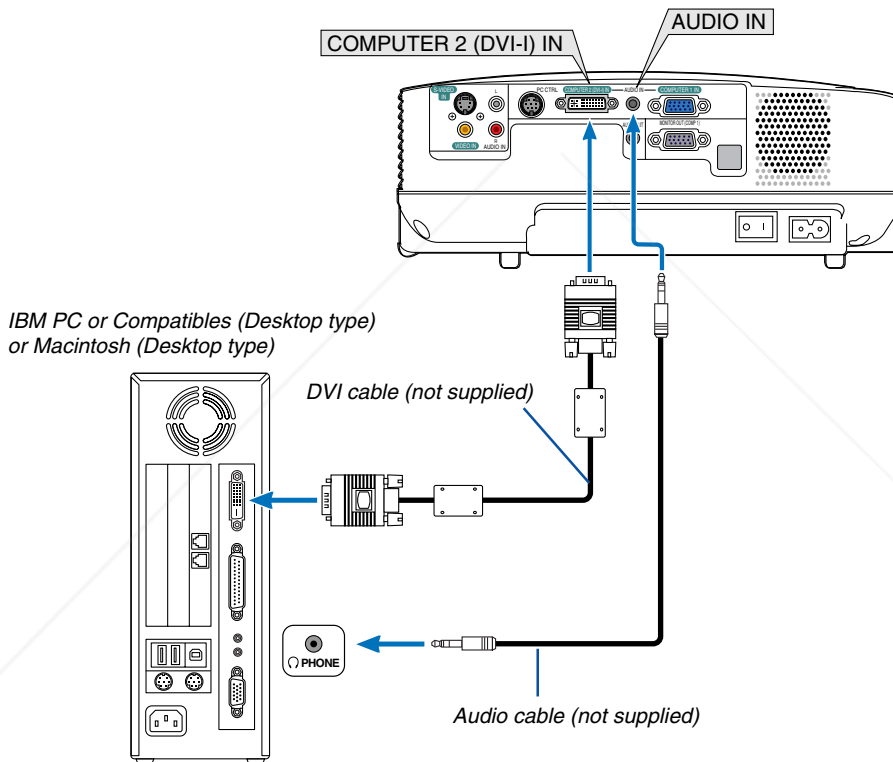

## 2. Installation and Connections

### Using Two Analog COMPUTER Inputs Simultaneously (VT695/VT595)

If you need to use two analog COMPUTER inputs simultaneously, connect a VGA signal cable as shown below.

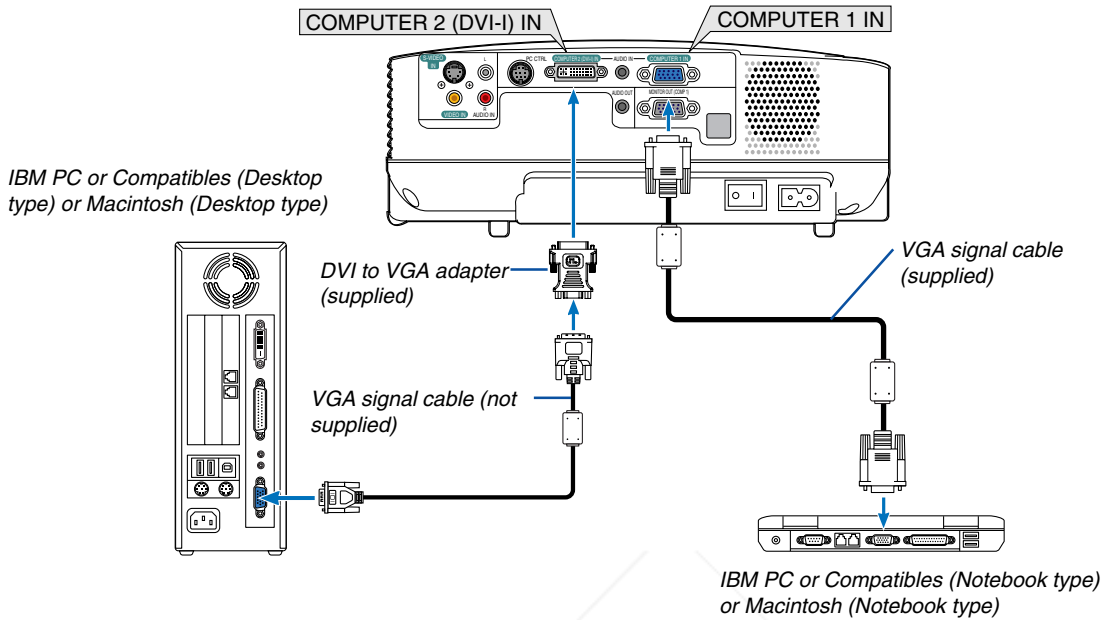

**NOTE:** When the DVI to VGA adapter is not to be used for an extended period of time, remove it from the projector. Failure to do so may cause damage to the connector of the projector.



### Connecting an External Monitor

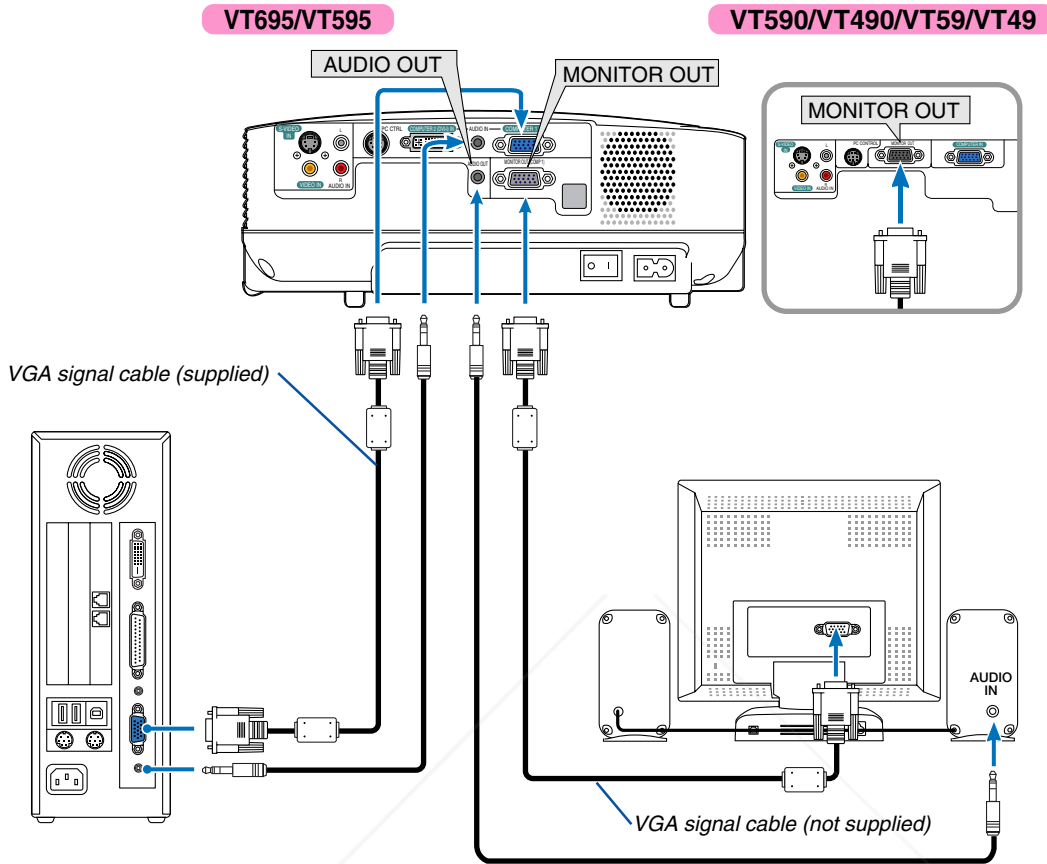

You can connect a separate, external monitor to your projector to simultaneously view on a monitor the RGB analog image you're projecting.

#### NOTE:

- Daisy chain connection is not possible.
- The signal from the COMPUTER 2 IN connector cannot be output from the MONITOR OUT connector on VT695 and VT595.
- When the DVI Digital signal is selected, no signals will be output from the MONITOR OUT connector on VT695 and VT595.
- The VT590/VT490/VT59/VT49 do not have the AUDIO OUT connector.

## 2. Installation and Connections

### Connecting Your DVD Player with Component Output

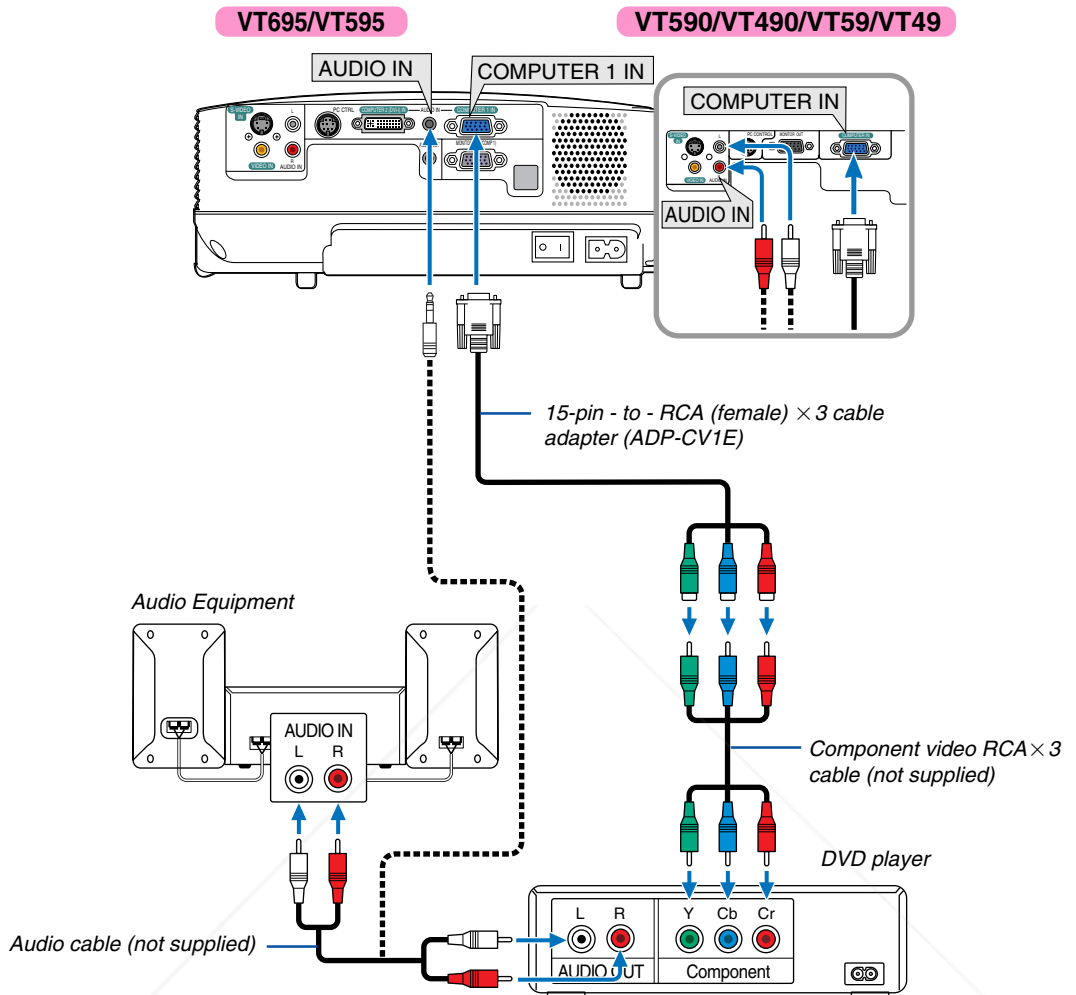

A component signal will be automatically displayed. If not, from the menu, select [Setup] → [Options] → [Signal Select] → [Computer 1 ([Computer] on VT590/VT490/VT59/VT49)], and then place a check mark in the Component radio button.

*NOTE: Refer to your DVD player's owner's manual for more information about your DVD player's video output requirements.*

## 2. Installation and Connections

### Connecting Your VCR or Laser Disc Player

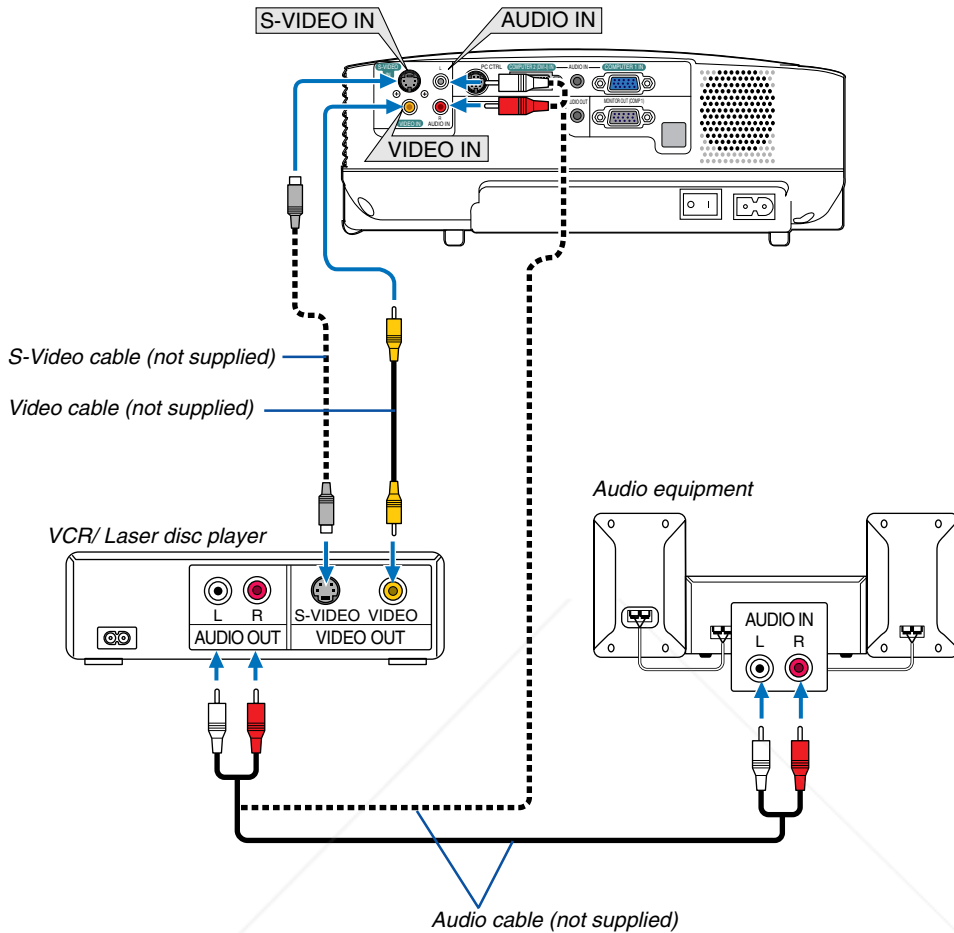

*NOTE: The AUDIO IN L/MONO and R jacks (RCA) are shared between the Video and S-Video inputs.*

*NOTE: Refer to your VCR or laser disc player owner's manual for more information about your equipment's video output requirements.*

*NOTE: An image may not be displayed correctly when a Video or S-Video source is played back in fast-forward or fast-rewind via a scan converter.*

## 2. Installation and Connections

### Connecting the Supplied Power Cable

Connect the supplied power cable to the projector.

First connect the supplied power cable's two-pin plug to the AC IN of the projector, and then connect the other plug of the supplied power cable in the wall outlet.

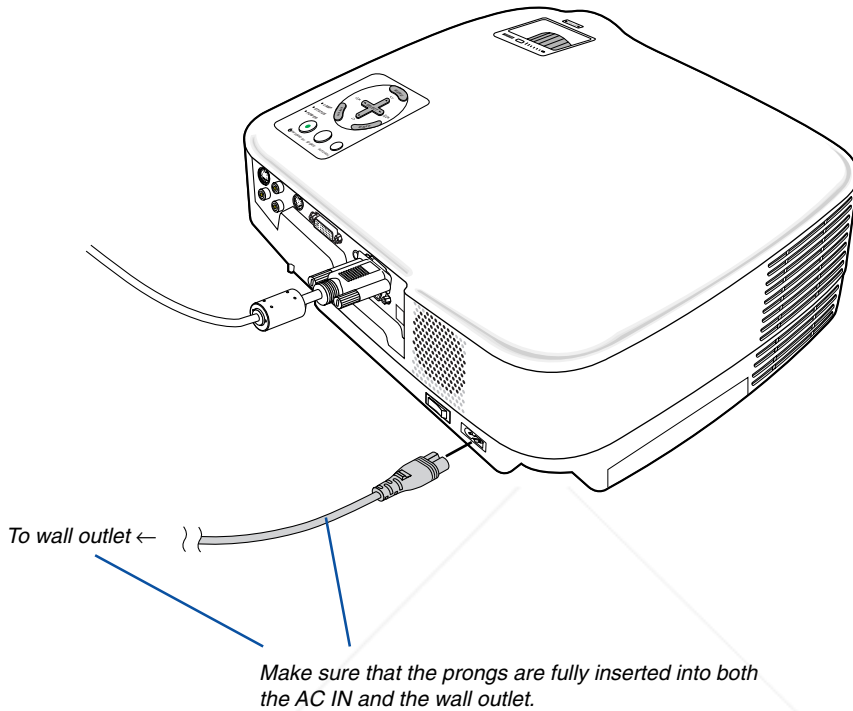

#### **⚠ CAUTION:**

Do not try to touch the ventilation outlet on the left front (when seen from the front) as it can become heated while the projector is turned on and immediately after the projector is turned off.

#### **⚠ CAUTION:**

Do not turn off the AC power by pressing the main power switch or by unplugging the power cable when the projector is powered on. Doing so can cause damage to the projector.

*TIP: The projector can be turned off (by either the main power switch or by unplugging the power cable) during its cool down period after it is turned off using the remote control or via the power button on the control panel.*



**Discount-Merchant.com (800) 281-8860**  
**THE TRUSTED SOURCE FOR PROJECTOR LAMPS AND ACCESSORIES**

# 3. Projecting an Image (Basic Operation)

This section describes how to turn on the projector and to project a picture onto the screen.

## 1 Turning on the Projector

### NOTE:

- The projector has two power switches: a main power switch and a POWER (ON/STAND BY) button (POWER ON and OFF on the remote control).
- When plugging in or unplugging the supplied power cable, make sure that the main power switch is pushed to the off (O) position. Failure to do so may cause damage to the projector.

### 1. To turn on the main power to the projector, press the Main Power switch to the on position (I).

The POWER indicator will light orange.  
See the Power Indicator section.(→ page 55)

### 2. Remove the lens cap

### 3. Press the POWER (ON/STAND BY) button on the projector cabinet or the POWER ON button on the remote control for 1 second.

The POWER indicator will turn to green and the projector will become ready to use.  
After you turn on your projector, ensure that the computer or video source is turned on and that your lens cap is removed.

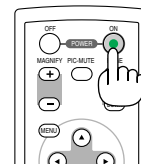
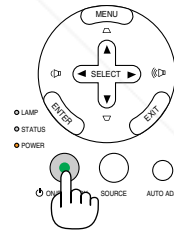
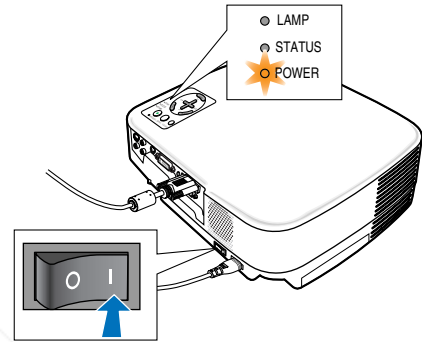

**NOTE:** When no signal is available, a blue screen is displayed at the factory default.

When the projector displays a blue, black, or logo screen, the projector will automatically switch to the Eco mode.

The projector will return to the Normal mode once a signal is connected.

**NOTE:** If you turn on the projector immediately after the lamp is turned off or when the temperature is high, the fans run without displaying an image for some time and then the projector will

display the image.  
www.youelp.com  
Sponsored by

**CAUTION:**  
The projector cannot be turned off for 60 seconds after the lamp is turned on and while the POWER indicator is blinking green. Doing so could cause premature lamp failure.

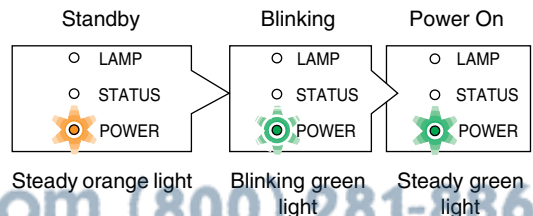

(→ page 55)

### 3. Projecting an Image (Basic Operation)

#### Note on Startup screen (Menu Language Select screen)

When you first turn on the projector, you will get the Startup menu. This menu gives you the opportunity to select one of the 8 menu languages.

To select a menu language, follow these steps:

1. Use the **SELECT ▲ or ▼** button to select one of the 8 languages from the menu.

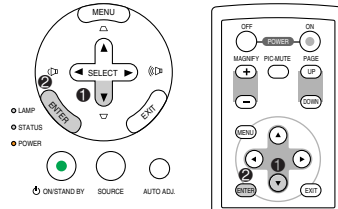
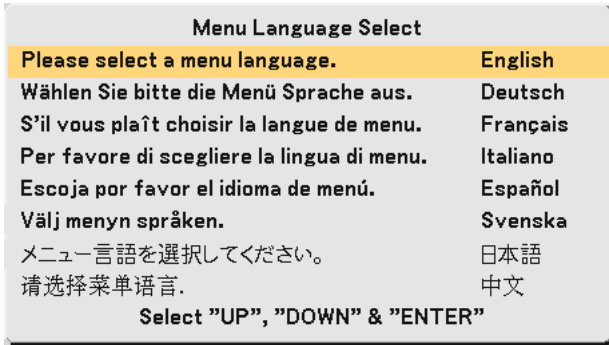

2. Press the **ENTER** button to execute the selection.

After this has been done, you can proceed to the menu operation.

If you want, you can select the menu language later.

(→ [Language] on page 39 and 44)

---

*NOTE: Immediately after turning on the projector, screen flicker may occur. This is normal. Wait 3 to 5 minutes until the lamp lighting is stabilized.*

---

When the Lamp mode is set to Eco, the LAMP indicator will light green.

If one of the following things happens, the projector will not turn on.

- If the internal temperature of the projector is too high, the projector detects abnormal high temperature. In this condition the projector will not turn on to protect the internal system. If this happens, wait for the projector's internal components to cool down.
- When the lamp reaches its end of usable life, the projector will not turn on. If this happens, replace the lamp.
- If the lamp fails to light, and if the STATUS indicator flashes on and off in a cycle of six times, wait a full minute and then turn on the power.



**Discount-Merchant.com (800) 281-8860**  
**THE TRUSTED SOURCE FOR PROJECTOR LAMPS AND ACCESSORIES**

## 2 Selecting a Source

### Selecting the computer or video source

*NOTE: Turn on the computer or video source equipment connected to the projector.*

#### Selecting from Source List

Press and quickly release the SOURCE button on the projector cabinet to display the Source list. Each time the SOURCE button is pressed, the input source will change as follows: "Computer 1", "Computer 2 (Digital / Analog)" (VT695/VT595 only), "Video" (VCR or laser disc player), "S-Video". To display the selected source, allow 1 second to elapse.

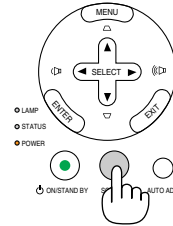

#### Detecting the Signal Automatically

Press and hold the SOURCE button for a minimum of 2 seconds, the projector will search for the next available input source. Each time you press and hold the SOURCE button for a minimum of 2 seconds, the input source will change as follows:

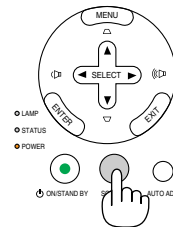

#### VT695/VT595

Computer1 → Computer2 (Digital) → Computer2 (Analog) → Video → S-Video → Computer1 → ...

#### VT590/VT490/VT59/VT49

Computer → Video → S-Video → Computer → ...

#### TIP:

*If no input signal is present, the input will be skipped.*

#### Using the Remote Control

Press any one of the COMPUTER 1/2, VIDEO, S-VIDEO buttons.

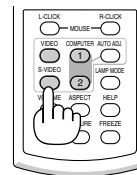

*NOTE: the COMPUTER 2 button is not available on the VT590, VT490, VT59 and VT49.*

*TIP: The COMPUTER 2 button on the remote control toggles the Computer 2 source between [Computer 2 (Digital)] and [Computer 2 (Analog)].*

#### Selecting Default Source

You can set a source as the default source so that it will be displayed each time the projector is turned on.

**Select [Setup] → [Options] → [Default Source Select] from the menu.**

The [Default Source Select] screen will be displayed.

**2. Select a source as the default source, and press the ENTER button.**

**3. Press the EXIT button a few times to close the menu.**

**4. Restart the projector.**

The source you selected in step 2 will be projected.

(→ page 47)

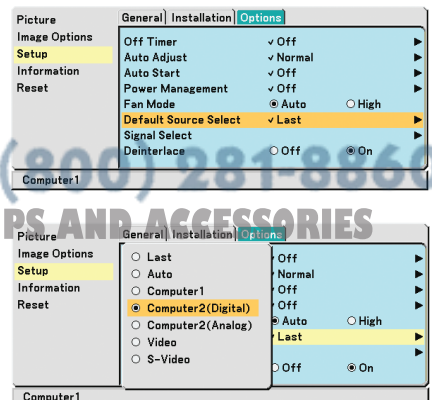

## ③ Adjusting the Picture Size and Position

Place your projector on a flat level surface and ensure that the projector is square to the screen.

Lift the front edge of the projector to center the image vertically.

\* If the projected image does not appear square to the screen then use the Keystone feature for proper adjustment. (→ page 25)

Move the projector left to center the image horizontally on the screen.

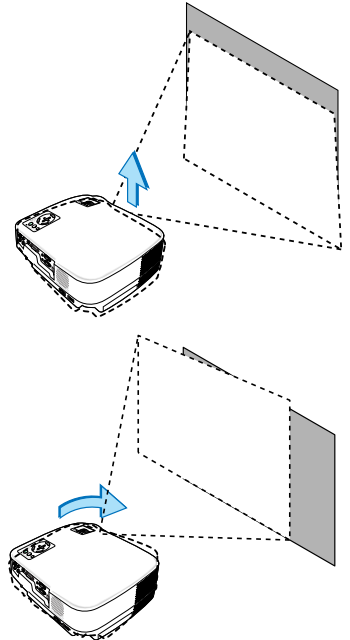

### Adjust the Tilt Foot

#### 1. Lift the front edge of the projector.

#### ⚠ CAUTION:

Do not try to touch the ventilation outlet during Tilt Foot adjustment as it can become heated while the projector is turned on and during its cool down period after it is turned off.

#### 2. Push and hold the Adjustable Tilt Foot Button on the front of the projector to extend the adjustable tilt foot.

#### 3. Lower the front of the projector to the desired height.

#### 4. Release the Adjustable Tilt Foot Button to lock the Adjustable tilt foot.

There is approximately 10 degrees (up) of adjustment for the front of the projector.

The rear foot height can be adjusted up to 0.4 inch/10 mm.

Rotate the rear foot to the desired height in order to square the image on the projection surface, but the vertical distance from the bottom to the desk or floor should be 0.4 inch /10mm to make the projector horizontal on the flat surface.

Adjustable Tilt Foot Button

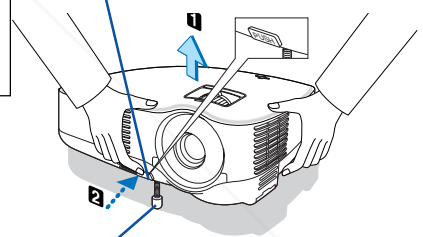

Adjustable Tilt Foot

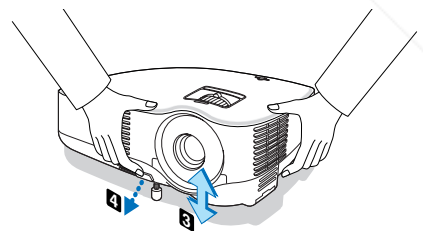

E. Rotating the rear foot too much may cause the foot to come out of the projector.

#### ⚠ CAUTION:

- Do not use the tilt-foot for purposes other than originally intended. Misuses such as using the tilt foot to carry or hang (from the wall or ceiling) the projector can cause damage to the projector.

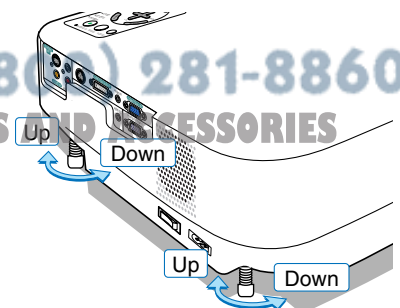



### 3. Projecting an Image (Basic Operation)

#### Zoom

VT695/VT595/VT590/VT490/VT59

Use the ZOOM lever to adjust the image size on the screen.

VT695/VT595/VT590/VT490/VT59

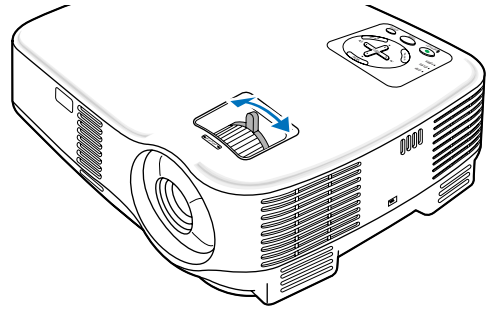

#### VT49

Use the Digital ZOOM button on the projector cabinet to electronically enlarge or reduce the image size.

*NOTE: Digital Zoom can result in a blurry image due to the electronic zoom.*

VT49

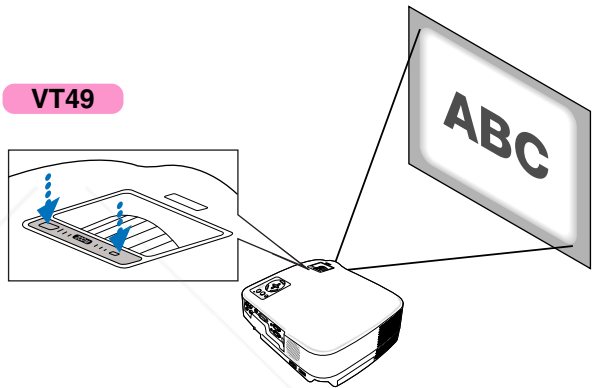

#### Focus

Use the FOCUS ring to obtain the best focus.

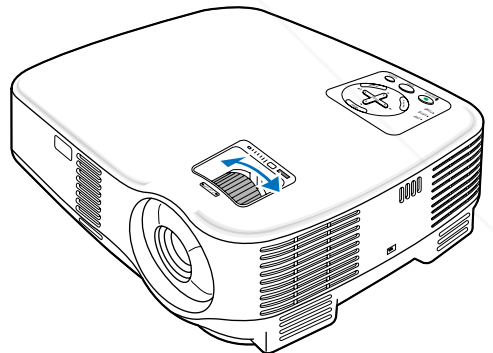

## 4 Correcting Keystone Distortion

### Correcting Keystone Distortion

If the screen is tilted vertically, keystone distortion becomes large. Proceed with the following steps to correct keystone distortion

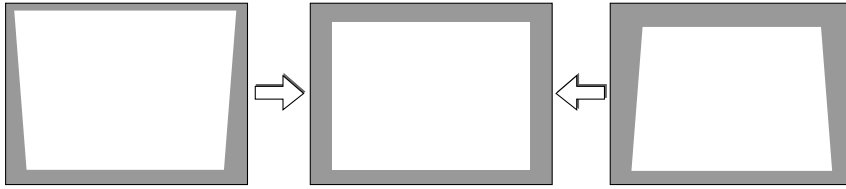

*NOTE: The Keystone correction can cause an image to be slightly blurred because the correction is made electronically.*

*NOTE: The Keystone correction range can be made narrower, depending on a signal or its aspect ratio selection.*

### Adjusting with buttons on the cabinet

1. Press the **SELECT ▲** or **▼** button with no menus displayed

The keystone bar will be displayed.



2. Use the **SELECT ▲** or **▼** to correct the keystone distortion.

The keystone bar will be closed after a period of time.

*NOTE: When the menu is displayed, the above operation is not available. When the menu is displayed, press the MENU button to close the menu and start the Keystone correction.*

*From the menu, select [Setup] → [General] → [Keystone]. The changes can be saved with [Keystone Save]. (→page 44)*

### Adjusting with the Remote Control

1. Press the **MENU** button.

The menu will be displayed.

2. Press the **SELECT ▼** button to select [Setup] and press the **ENTER** button.

3. Press the **SELECT ▼** button to select [Keystone].

4. Press the **SELECT ◀** or **▶** button.

Adjust so that the image is rectangular.

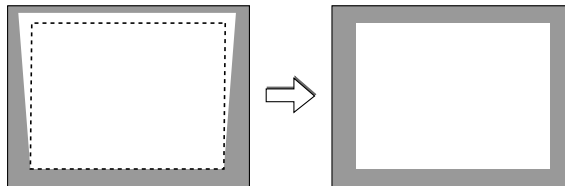

5. Press the **MENU** button.

The menu will be closed.

*NOTE: The Keystone correction can cause an image to be slightly blurred because the correction is made electronically.*

*TIP: The changes can be saved with [Keystone Save]. (→page 44)*

### 3. Projecting an Image (Basic Operation)

#### Adjusting with the Auto Keystone Function (VT695 and VT595 only)

The Auto Keystone correction feature will correct the vertical distortion of a projected image on the screen. No special operation required. Just put the projector on a flat surface.

---

*TIP: Even when the menu setting for [Auto Keystone] is turned on, [Keystone] can be adjusted manually.*

---

To turn on [Auto Keystone], proceed the following steps.

**1. Press the MENU button**

The menu will be displayed.

**2. Press the SELECT ▼ button to select [Setup] and press the ENTER button.**

The [General] tab will be highlighted.

**3. Press the SELECT ▼ button.**

The [Auto Keystone] will be highlighted.

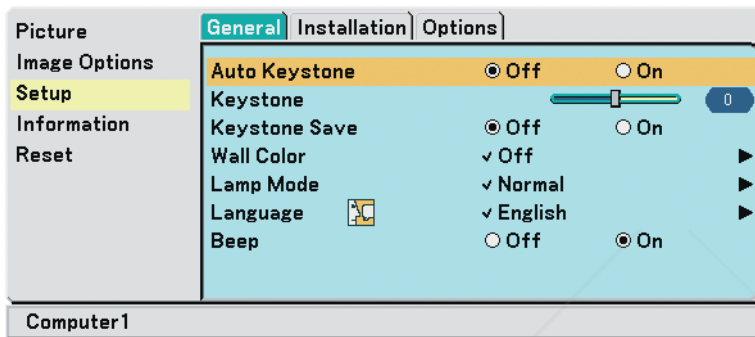

**4. Press the SELECT ◀ or ▶ button to select [On].**

**5. Press the MENU button.**

The menu will be closed.

**NOTE:**

- Vertical distortions between offset angles of +/- 30 degrees can be corrected.
- The Auto Keystone correction will take effect in 2 seconds after changing the projection angle during projection.
- The left and right (horizontal) keystone correction is not available.

Place the projector so that the lens surface is parallel to the screen.

The rear feet of the projector can be adjusted to level the projector.

---

**NOTE:**

- Auto and Manual Keystone correction angle could be less than 30 degrees depending on the signal and/or aspect ratios.
  - Using keystone correction can cause the image to be slightly blurred because the correction is made electronically.
- 

**NOTE:**

- When the menu is displayed, the Keystone Correction operation is not available by using the buttons on the projector cabinet. When the menu is displayed, press the EXIT button to close the menu and then perform the Keystone correction. From the menu, select [Setup] → [General] → [Keystone]. The changes can be saved with [Keystone Save].

Page 14 | DLP.com

Sponsored by

*TIP: If you have one of the following conditions, the projector's Auto Keystone may not be performed correctly.*

- The screen is tilted
  - The room temperature is too high or too low
  - The optical zoom is maximized or minimized
-

## 5 Optimizing RGB Picture Automatically

### Adjusting the Image Using Auto Adjust

Optimizing an RGB image automatically.

Press the AUTO ADJ. button to optimize an RGB image automatically.

This adjustment may be necessary when you connect your computer for the first time.

[Poor picture]

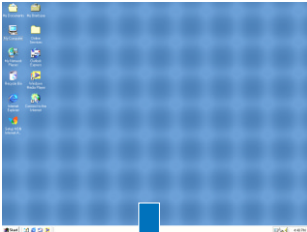

[Normal picture]

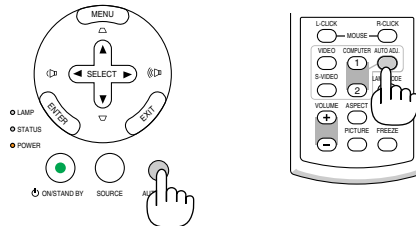
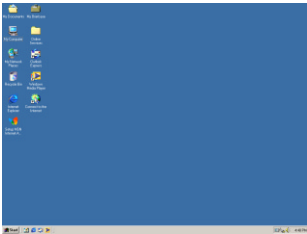

#### NOTE:

Some signals may take time to display or may not be displayed correctly.

- VT695/VT595: The Auto Adjust function does not work for component, video, and DVI digital signals.
- VT590/VT490/VT59/VT49: The Auto Adjust function does not work for component and video signals.
- If the Auto Adjust operation cannot optimize the RGB signal, try to adjust Horizontal/Vertical Position, Clock and Phase manually. (→page 43)

## 6 Turning Up or Down Volume

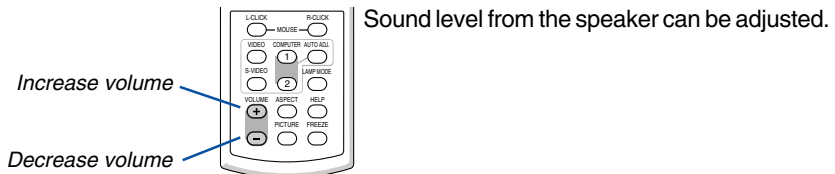

When no menus appear, the SELECT ◀ and ▶ buttons on the projector cabinet work as a volume control.

Sponsored by DM

Discount-Merchant.com (800) 281-8860  
THE TRUSTED SOURCE FOR PROJECTOR LAMPS AND ACCESSORIES

## 7 Turning off the Projector

To turn off the projector:

1. First, press the **POWER (ON/STAND BY)** button on the projector cabinet or the **POWER OFF** button on the remote control. The [Power Off / Are you sure?] message will appear.

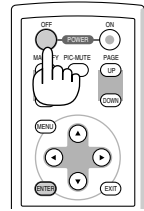
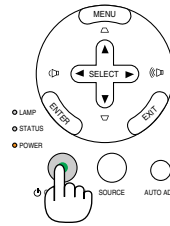
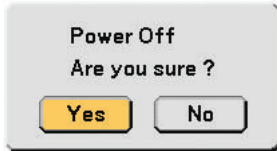

2. Secondly, press the **ENTER** button or press the **POWER (ON/STAND BY)** or the **POWER OFF** button again.

The power indicator will glow orange. After the projector turns off, the cooling fans keep operating for 30 seconds (Cool-down time).

Immediately after turning on the projector and displaying an image, you cannot turn off the projector for 60 seconds.

3. Finally, turn off the Main Power switch. The power indicator will go out.

*TIP:* The main power of the projector can be turned off by pressing the main power switch or by unplugging the power cable even during the cool down period after the projector is turned off.

*NOTE:* Do not turn off the main power within 10 seconds of making adjustment or setting changes and closing the menu. Doing so can cause loss of adjustments and settings.

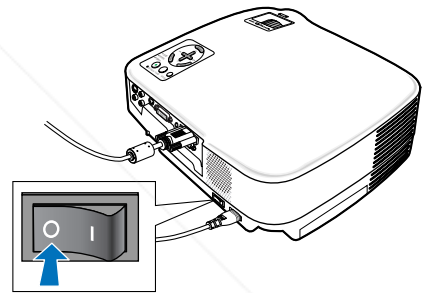
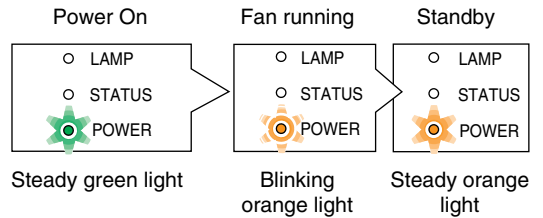

#### CAUTION:

Parts of the projector will become heated during operation. Use caution when picking up the projector immediately after it has been operating.

#### CAUTION:

- The projector cannot be turned off for 60 seconds after the lamp is turned on and while the POWER indicator is blinking green. Doing so could cause premature lamp failure.
- Do not turn off the AC power by pressing the main power switch or by unplugging the power cable when the projector is powered on. Doing so can cause damage to the projector.



Discount-Merchant.com (800) 281-8860  
THE TRUSTED SOURCE FOR PROJECTOR LAMPS AND ACCESSORIES

## 8 After Use

Preparation: Make sure that the projector is turned off.

1. *Unplug the power cable.*
2. *Disconnect any other cables.*
3. *Retract adjustable tilt feet if extended.*
4. *Cover the lens with the lens cap.*
5. *Put the projector and accessories in the supplied soft case.*

*Place the projector in the soft case with the lens facing upward as shown below. This is to prevent the lens from damage.*

*Insert the projector with the lens facing upward*

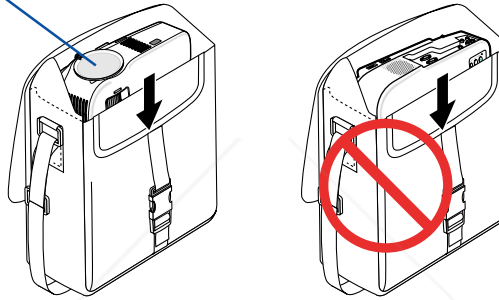

*NOTE: When placing the projector in the soft case, retract the tilt feet and the rear feet. Failure to do so may cause damage to the projector.*

#### CAUTION:

Use caution when putting the projector in the soft case immediately after the projector has been operating. The projector cabinet is hot.

# 4. Convenient Features

## ❶ Turning off the Image and Sound

Press the PIC-MUTE button to turn off the image and sound for a short period of time. Press again to restore the image and sound.

*NOTE:*

*Sound from the AUDIO OUT jack (Stereo mini) on the VT695/VT595 can be turned off.*

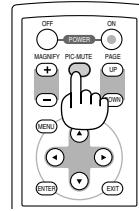

## ❷ Freezing a Picture

Press the FREEZE button to freeze a picture. Press again to resume motion.

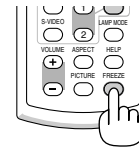

## ❸ Enlarging a Picture

You can enlarge the picture up to four times.

*NOTE: The maximum magnification may be less than four times depending on the signal.*

To do so:

1. Press the **MAGNIFY (+)** button to magnify the picture.  
To move the magnified image, use the **SELECT ▲, ▼, ◀ or ▶** button.

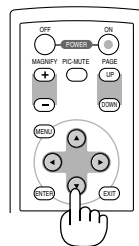
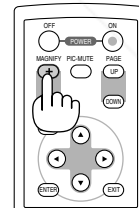
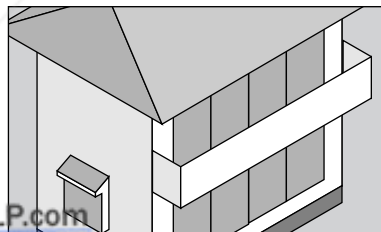
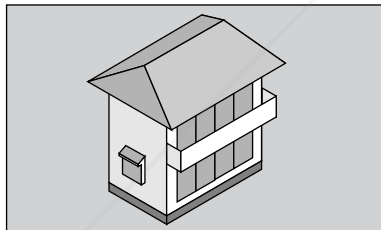

2. Press the **MAGNIFY (-)** button to return the image to the original size.

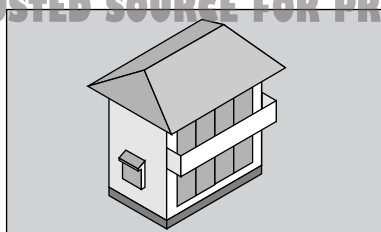

## 4 Changing Lamp Mode

This feature enables you to select two brightness modes of the lamp: Normal and Eco modes. The lamp life can be extended by using the Eco mode.

Lamp Mode	Description	Status of LAMP indicator
Normal Mode	This is the default setting (100% Brightness).	Off LAMP ○ STATUS ○ POWER ●
Eco Mode	Select this mode to increase the lamp life (approx. 80% Brightness). *approx. 75% Brightness: VT695	Steady Green light LAMP ● STATUS ○ POWER ●

To change to the [Eco] mode, do the following:

1. Press the **LAMP MODE** button on the remote control to display [Lamp Mode] screen.
2. Use the **SELECT ▲** or **▼** button to select [Eco] mode.
3. Press the **ENTER** button.  
To change from [Eco] to [Normal], Go back to Step 2 and select [Normal]. Repeat Step 3.

**NOTE:**

- The Lamp Mode can be changed by using the menu.  
Select [Setup] → [General] → [Lamp Mode].
- The lamp life remaining and lamp hours used can be checked in [Usage Time]. Select [Information] → [Usage Time].
- If the projector is overheated in Normal mode, there may be a case where the Lamp mode automatically changes to Eco mode to protect the projector. When the projector is in Eco mode, the picture brightness decreases. When the projector comes back to normal temperature, the Lamp mode returns to Normal mode.  
Thermometer symbol [  ] indicates the lamp mode is automatically set to Eco mode because the internal temperature is too high.

## 5 Preventing the Unauthorized Use of the Projector

To enable the Security function:

1. Press the **MENU** button.  
The menu will be displayed.
2. Use the **SELECT ▲** or **▼** button to select [Setup] and press the **ENTER** button.

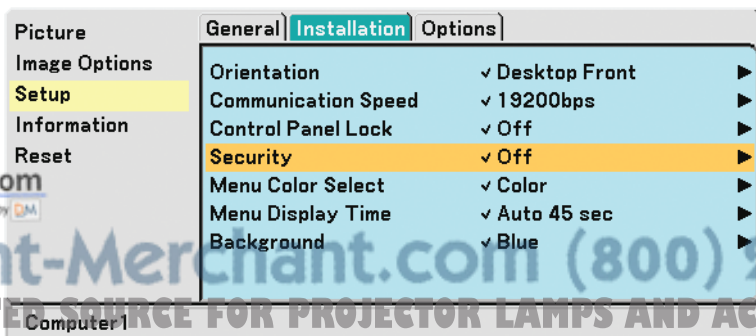

Example of menu for VT695 and VT595

3. Use the **SELECT ◀** or **▶** button to select [Installation].
4. Use the **SELECT ▲** or **▼** button to select [Security] and press the **SELECT ▶** button.



5. Use the **SELECT ▲ or ▼** button to select [On] and press the **ENTER** button.

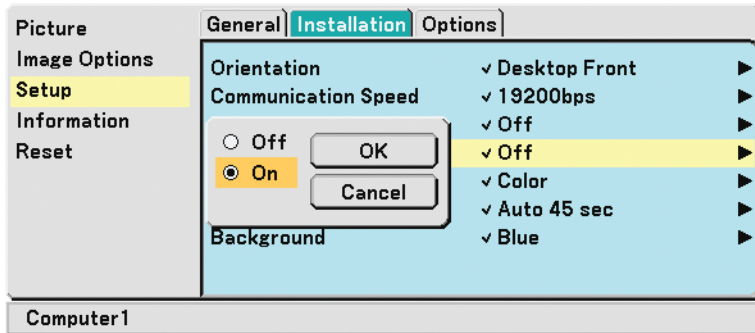

The [Security Keyword] screen will be displayed.

6. Type in a combination of the four **SELECT** buttons **▲▼◀▶** and press the **ENTER** button.

---

*NOTE: A keyword must be 4 to 10 digits in length. Please make a note of your keyword.*

---



The [Confirm Keyword] screen will be displayed.

---

*NOTE:*

*Do not forget your keyword. However, if you forget your keyword, NEC or your dealer will provide you with your Release Code upon proof of ownership. See more information at the end of this section. (→page 33)*

---

7. Type in the same combination of **SELECT** button **▲▼◀▶** and press the **ENTER** button.

The confirmation screen will be displayed.

8. Select [Yes] and press the **ENTER** button.

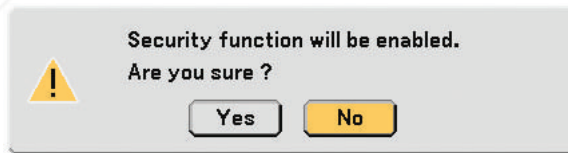

The Security function has been enabled.

## 4. Convenient Features

To turn on the projector when Security is enabled:

1. **Press the Main Power Switch to the On position (I).**
2. **Press and hold the POWER ON or the ON/STAND BY button for a minimum of 1 second.**  
The projector will be turned on and display a message to the effect that the projector is security-protected.
3. **Press the MENU button.**

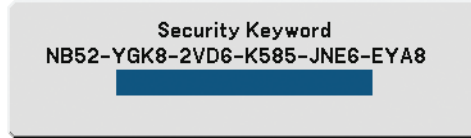

The Security Keyword screen will be displayed.

4. **Enter your keyword in the Security Keyword screen and press the ENTER button.**

You can view the projected image.

---

*NOTE: The security disable mode is maintained until the main power is turned off (by setting the main power switch to "0" or unplugging the power cord).*

---

### To disable the Security function:

1. **Press the MENU button.**  
The menu will be displayed.
2. **Use the SELECT ▲ or ▼ button to select [Setup] and press the ENTER button.**
3. **Use the SELECT ◀ or ▶ button to select [Installation].**
4. **Use the SELECT ▲ or ▼ button to select [Security] and press the SELECT ▶ button.**
5. **Use the SELECT ▲ or ▼ button to select [Off] and press the ENTER button.**

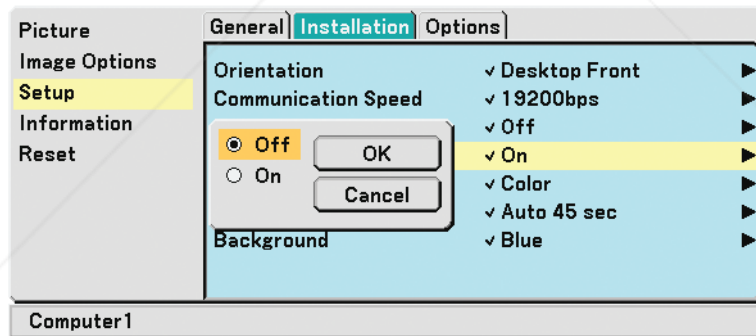

The keyword confirmation screen will be displayed.

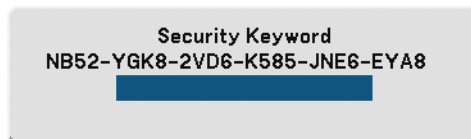

6. **Type in your keyword and press the ENTER button.**

When the correct keyword is entered, the Security function will be disabled.

#### NOTE:

- If you forget your keyword, contact your dealer. Your dealer will provide you with your keyword in exchange for your request code. Your request code is displayed in the Keyword Confirmation screen. In this example [NB52-YGK8-2VD6-K585-JNE6-EYA8] is a request code.
- The [Security] setting cannot be cancelled by using the [Reset] of the menu.

## ⑥ Using the Optional Remote Mouse Receiver (NP01MR)

The optional remote mouse receiver enables you to operate your computer's mouse functions from the remote control. It is a great convenience for clicking through your computer-generated presentations.

### Connecting the remote mouse receiver to your computer

If you wish to use the remote mouse function, connect the mouse receiver and computer. The mouse receiver can be connected directly to the computer's USB port (type A).

*NOTE: Depending on the type of connection or OS installed on your computer, you may have to restart your computer or change your computer settings.*

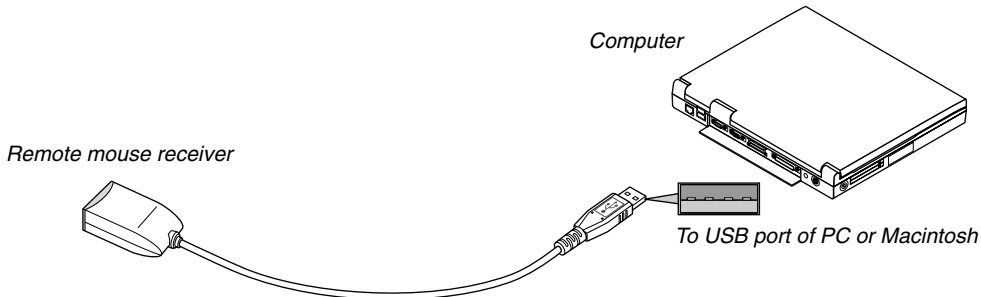

### When operating a computer via the remote mouse receiver

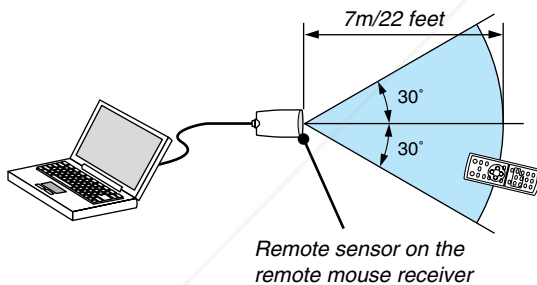

### When connecting using the USB terminal

For PC, the mouse receiver can only be used with a Windows 98/Me/XP\*, Windows 2000 or Mac OS X 10.0.0 or later operating system.

*\* NOTE: In SP1 or older version of Windows XP, if the mouse cursor will not move correctly, do the following: Clear the Enhance pointer precision check box underneath the mouse speed slider in the Mouse Properties dialog box [Pointer Options tab].*

*NOTE: Wait at least 5 seconds after disconnecting the mouse receiver before reconnecting it and vice versa. The computer may identify the mouse receiver if it is repeatedly connected and disconnected in rapid intervals.*

### Operating your computer's mouse from the remote control

You can operate your computer's mouse from the remote control.

PAGE UP/DOWN Button: scrolls the viewing area of the window or to move to the previous or next slide in PowerPoint on your computer.

SELECT▲▼◀▶ Buttons: moves the mouse cursor on your computer.

MOUSE L-CLICK Button: works as the mouse left button.

MOUSE R-CLICK Button: works as the mouse right button.

### About Drag Mode:

By pressing the MOUSE L-CLICK or R-CLICK button for 2 or 3 seconds then releasing, the drag mode is set and the drag operation can be performed simply by pressing the SELECT ▲▼◀▶ button. To drop the item, press the MOUSE L-CLICK (or R-CLICK) button. To cancel it, press the MOUSE R-CLICK (or L-CLICK) button.

---

*NOTE: When you operate the computer using the SELECT ▲▼◀▶ or ▶ button with the menu displayed, both the menu and the mouse pointer will be affected. Close the menu and perform the mouse operation.*

---

*TIP: You can change the Pointer speed on the Mouse Properties dialog box on the Windows. For more information, see the user documentation or online help supplied with your computer.*

---



**Discount-Merchant.com (800) 281-8860**  
**THE TRUSTED SOURCE FOR PROJECTOR LAMPS AND ACCESSORIES**

# 5. Using On-Screen Menu

## ① Using the Menus

*NOTE: The on-screen menu may not be displayed correctly while interlaced motion video image is projected.*

1. Press the **MENU** button on the remote control or projector cabinet to display the Menu.



2. Press the **SELECT** ▲ or ▼ button on the remote control or the projector cabinet to highlight the menu for the item you want to adjust or set.

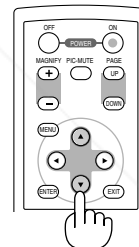
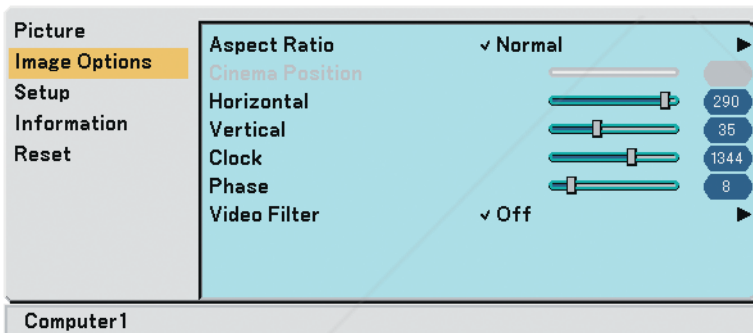

3. Press the **SELECT** ► button or the **ENTER** button on the remote control or the projector cabinet to select a submenu or item.

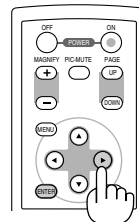

## 5. Using On-Screen Menu

4. Use the **SELECT ▲** or **▼** button on the remote control or the projector cabinet to select the item you want to adjust or set.

5. Adjusting the level of a selected item or selecting an item.

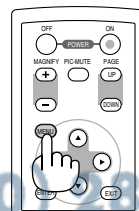
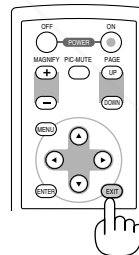
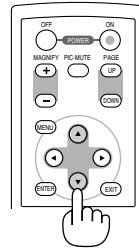
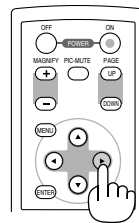
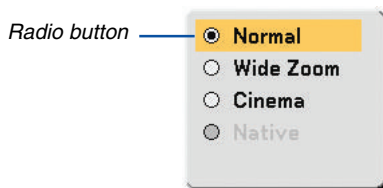
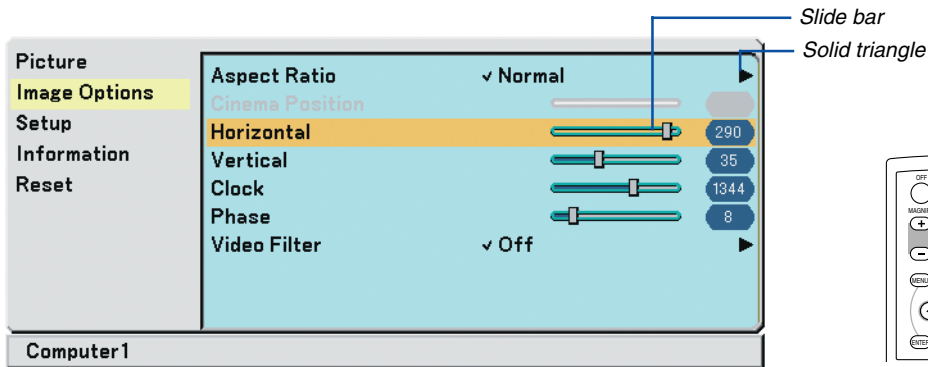

### For Adjusting items (Slide bar)

Slide bar ..... Indicates settings or the direction of adjustment.

- Use the **SELECT ◀▶** buttons to adjust the item.

### For Selecting items (Solid triangle)

Solid triangle .... Indicates further choices are available. A highlighted triangle indicates the item is active.

- (1) Use the **SELECT ▶** button to select the item.
- (2) Use the **SELECT ▲▼** buttons to highlight the item you want to set.
- (3) Press the **ENTER** button. The selected item will be displayed.

### For Selecting items (Radio button)

Radio button .... Use this round button to select an option in a dialog box.

- Use the **SELECT ▲▼** buttons to select the item.
- Changes are stored until you adjust it again.  
Press the **EXIT** button to return to the previous screen.

6. Repeat steps 2-5 to adjust an additional item, or press the **MENU** button to close the menu.

Sponsored by 

**Discount-Merchant.com (800) 231-8860**  
**THE TRUSTED SOURCE FOR PROJECTOR LAMPS AND ACCESSORIES**

## 2 Menu Elements

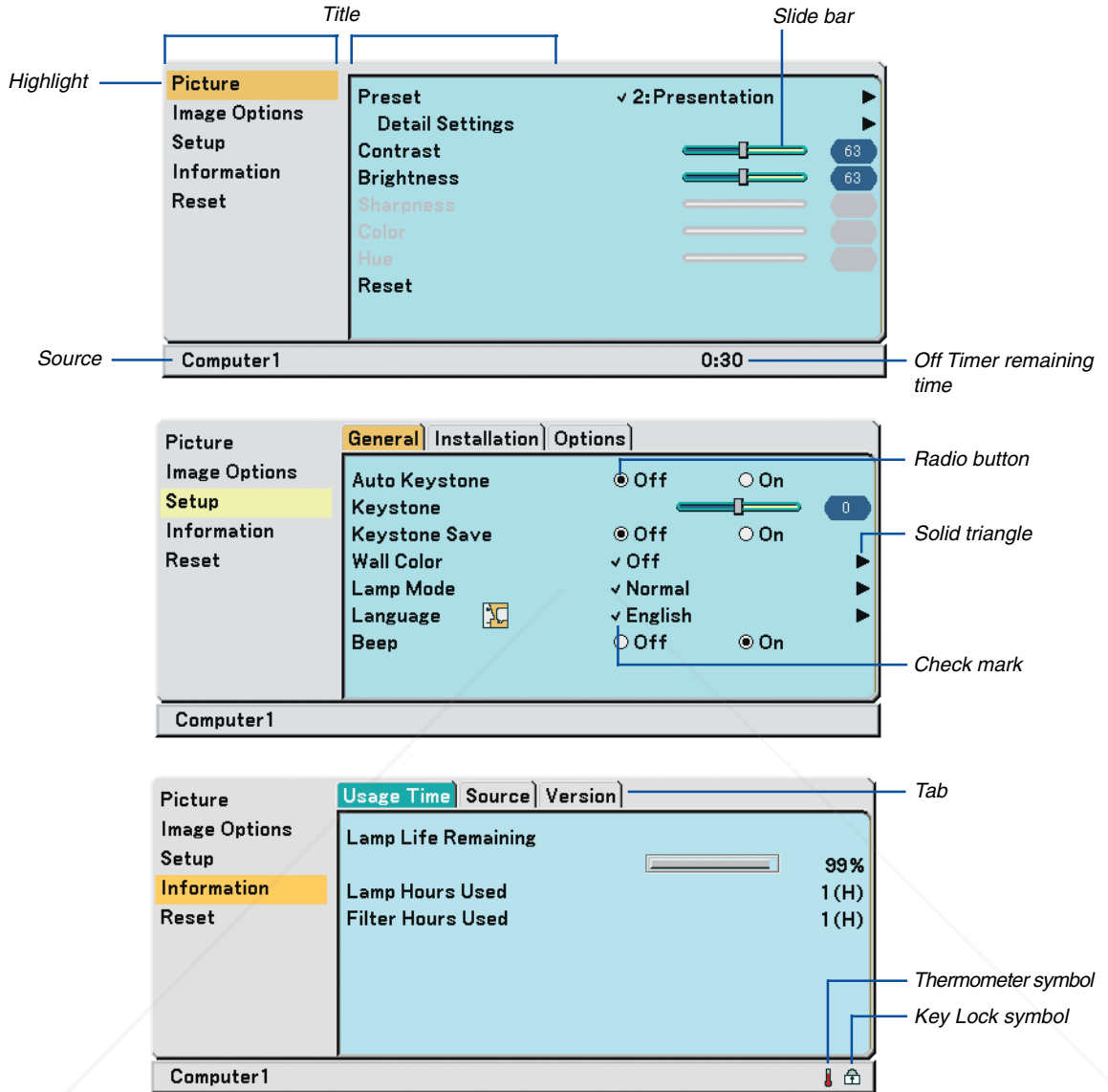

Menu windows or dialog boxes typically have the following elements:

Title ..... Indicates the menu title.

Highlight ..... Indicates the selected menu or item.

Source ..... Indicates the currently selected source.

Off Timer remaining time ..... Indicates the remaining countdown time when the Off Timer is preset.

Solid triangle ..... Indicates further choices are available. A highlighted triangle indicates the item is active.

Tab ..... Indicates a group of features in a dialog box. Selecting on any tab brings its page to the front.

Radio button ..... Use this round button to select an option in a dialog box.

Check mark ..... Indicates the item is selected.

Slide bar ..... Indicates settings or the direction of adjustment.

Key Lock symbol ..... Indicates the Control Panel Lock is enabled.

Thermometer symbol ..... Indicates the lamp mode is forcibly set to Eco mode because the internal temperature is too high.

### 3 List of Menu Items

Some menu items are not available depending on the input source.

Picture	Default	Item	Resettable
Preset	*	1 to 6	Yes
Detail Settings			
General			
Reference		High-Bright, Presentation, Video, Movie, Graphic, sRGB	Yes
Gamma Correction		Dynamic, Natural, Black Detail	Yes
Color Temperature		6500, 7800, 8500, 9300	Yes
White Balance			
Contrast RGB, Brightness RGB			
Contrast			Yes
Brightness			Yes
Sharpness			Yes
Color			Yes
Hue			Yes
Reset			
Image Options	Default	Item	Resettable
Aspect Ratio	*	Normal, Wide Zoom, Cinema, Native	Yes
Cinema Position			Yes
Horizontal	*		Yes
Vertical	*		Yes
Clock	*		Yes
Phase	*		Yes
Video Filter	*	Off, Less, More	Yes
Setup	Default	Item	Resettable
General			
Auto Keystone (VT695/VT595 only)	Off	Off, On	Yes
Keystone			Yes
Keystone Save	Off	Off, On	Yes
Wall Color	Off	Off, Blackboard, Blackboard(Gray), Light yellow, Light green, Light blue, Sky blue, Light rose, Pink	Yes
Lamp Mode	Normal	Normal, Eco	Yes
Language	English	English, Deutsch, Français, Italiano, Español, Português, Nederlands, Svenska, Norsk, Suomi, Čeština, Magyar, Polski, Türkçe, Русский, Ελληνικά, 日本語, 中文, 한국어, العربية, Dansk	-
Beep	On	Off, On	Yes
Installation			
Orientation	Desktop Front	Desktop Front, Ceiling Rear, Desktop Rear, Ceiling Front	Yes
Communication Speed	19200	4800, 9600, 19200	-
Control Panel Lock	Off	Off, On	Yes
Security	Off	Off, On	-
Menu Color Select	Color	Color, Monochrome	Yes
Menu Display Time	Auto 45 sec	Manual, Auto 5 sec, Auto 15sec, Auto 45 sec	Yes
Background	Blue	Blue, Black, Logo	Yes
Options			
Off Timer	Off	Off, 0:30, 1:00, 2:00, 4:00, 8:00, 12:00, 16:00	Yes
Auto Adjust	Normal	Off, Normal, Fine	Yes
Auto Start	Off	Off, On	Yes
Power Management	Off	Off, 0:05, 0:10, 0:20, 0:30	Yes
Fan Mode	Auto	Auto, High	Yes
Default Source Select	Last	Last, Auto, Computer, Computer 1, Computer 2 (Digital), Computer 2 (Analog), Video, S-Video	Yes
		<ul style="list-style-type: none"> <li>• Computer: VT590/VT490/VT59/VT49 only</li> <li>• Computer 1, Computer 2 (Digital), Computer 2 (Analog): VT695/VT595 only</li> </ul>	

\* The asterisk (\*) indicates that the default setting varies depending on the signal.



## 5. Using On-Screen Menu

Signal Select			
Computer 1(VT695/VT595)	RGB/Component	RGB/Component, RGB, Component	Yes
Computer 2 (Analog) (VT695/VT595)	RGB/Component	RGB/Component, RGB, Component	Yes
Computer(VT590/VT490/VT59/VT49)	RGB/Component	RGB/Component, RGB, Component	Yes
Video	Auto	Auto, NTSC3.58, NTSC4.43, PAL, PAL-M, PAL-N, PAL60, SECAM	Yes
S-Video	Auto	Auto, NTSC3.58, NTSC4.43, PAL, PAL-M, PAL-N, PAL60, SECAM	Yes
Deinterlace	On	Off, On	Yes

Information		Item
Usage Time	Lamp Life Remaining	
	Lamp Hours Used	
	Filter Hours Used	
Source	Source index	
	Horizontal Frequency	
	Vertical Frequency	
	Signal Type	RGB, Component, Video, S-Video, HDTV, Digital
	Video Type	NTSC, NTSC3.58, NTSC4.43, PAL, PAL-M, PAL-N, PAL60, SECAM
	Sync Type	Separate Sync, Composite Sync, Sync on Green, Sync on Video
	Sync Polarity	
	Scan Type	Interlace, Non-interlace
Version	Product	
	Serial Number	
	Firmware	
	Data	

Reset	Item
Current Signal	
All Data	
Clear Lamp Hours	
Clear Filter Hours	



**Discount-Merchant.com (800) 281-8860**  
**THE TRUSTED SOURCE FOR PROJECTOR LAMPS AND ACCESSORIES**

## ④ Menu Descriptions & Functions [Picture]

### Preset



When selecting user adjustable [Preset], the submenu will be displayed. You can customize each gamma or color. To do so, first select [Preset] and press the ENTER button, then proceed using the following steps.

### Detail Settings

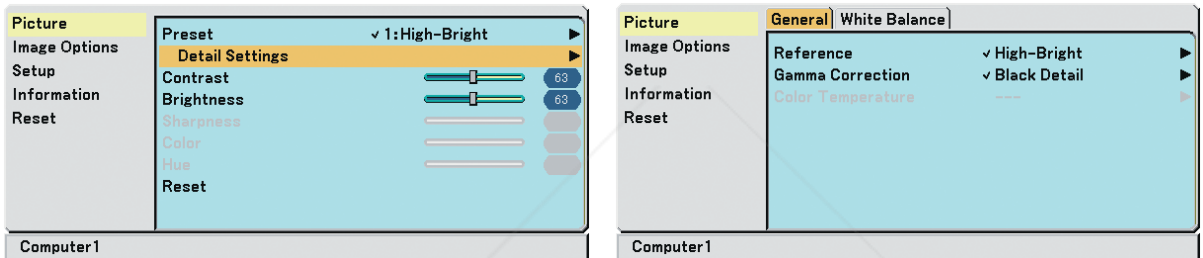

### Selecting Reference Setting [Reference]

This option allows you to adjust neutral tint for yellow, cyan or magenta. There are six factory presets optimized for various types of images, you can set user adjustable settings.

- High-Bright ..... Recommended for the use in a brightly lit room.
- Presentation ..... Recommended for making a presentation using a PowerPoint file.
- Video ..... Recommended for standard video such as a TV program.
- Movie ..... Recommended for film based video such as a movie (DVD or HDTV).
- Graphic ..... Recommended for viewing accurate colors in graphics.
- sRGB ..... Standard color values.

### Selecting Gamma Correction Mode [Gamma Correction]

Each mode is recommended for:

- Dynamic ..... Creates a high-contrast picture.
- Natural ..... Natural reproduction of the picture.
- Black Detail ..... Emphasizes detail in dark areas of the picture.

### Adjusting Color Temperature [Color Temperature]

This option allows you to select the color temperature of your choice.

*NOTE: When [High-Bright] or [Presentation] is selected in [Reference], [Color Temperature] is not available.*

### Adjusting White Balance [White Balance]

This allows you to adjust the white balance. Contrast for each color (RGB) to adjust the white level of the screen; Brightness for each color (RGB) is used to adjust the black level of the screen.

### Adjusting Contrast, Brightness, Sharpness, Color and Hue

You can adjust contrast, brightness, sharpness, color and hue.

- Contrast ..... Adjusts the intensity of the image according to the incoming signal (White level of the image).
- Brightness ..... Adjusts the brightness level or the black level of the image.
- Sharpness ..... Controls the detail of the image for Video (not valid for RGB).
- Color ..... Increases or decreases the color saturation level (not valid for RGB).
- Hue ..... Varies the color level from +/- green to +/-blue. The red level is used as reference. This adjustment is only valid for Video and Component inputs (not valid for RGB).

### Reset

The settings and adjustments for [Picture] will be returned to the factory settings with the exception of the following; Preset numbers and [Reference] within the [Preset] screen. The settings and adjustments under [Detail Settings] within the [Preset] screen that are not currently selected will not be reset.

## 6 Menu Descriptions & Functions [Image Options]

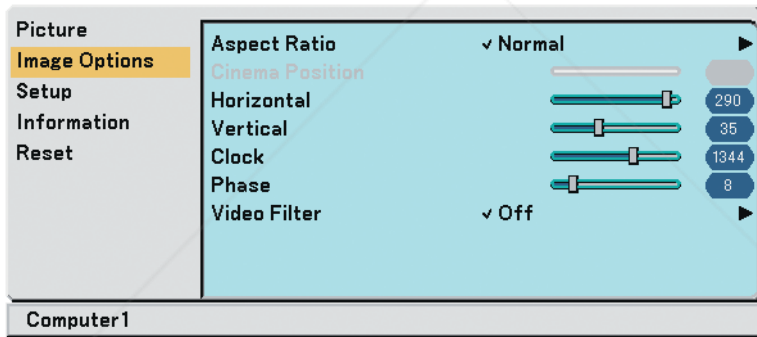

### Selecting Aspect Ratio [Aspect Ratio]

Aspect Ratio allows you to select the best Aspect mode to display your source image. You can also display the Aspect Ratio menu by pressing the ASPECT button on the remote control.

When 4:3 is selected from the source (i.e. DVD player), the following selections will display:

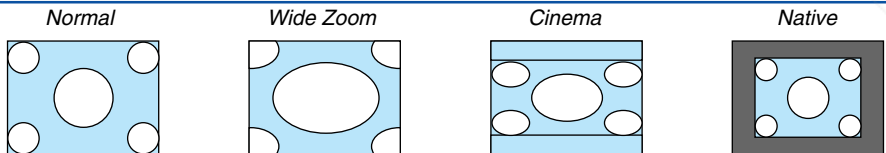

Standard 4:3 Aspect      Left and right stretched      Left and right stretched

When 16:9 is selected from the source (i.e. DVD player), the following selections will display:

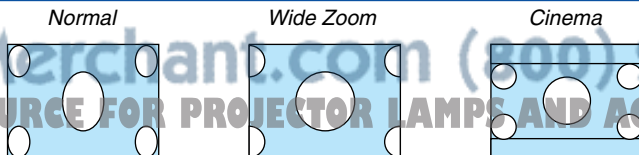

16:9 image displayed in 4:3 mode      Left and right stretched      Left and right stretched to display the true aspect

Native (RGB only): Turns off the scaling feature. The projector displays the current image in its true resolution.

**NOTE:**

- When you are displaying an RGB image with a higher resolution than the projector's native resolution, the image will be displayed in the projector's native resolution. In this case [Native] is not available from the menu. Only when displaying an RGB image with a lower resolution than the projector's native resolution, will the image be able to be displayed in its true resolution [Native].
- When Computer 2 (Digital) is selected, some options of Aspect Ratio are not available depending on the signal.
- You can adjust the image position for Cinema aspect. See [Cinema Position] for setting the image position.

**Copyright**

Please note that using this projector for the purpose of commercial gain or the attraction of public attention in a venue such as a coffee shop or hotel and employing compression or expansion of the screen image with a [Aspect Ratio] setting may raise concern about the infringement of copyrights which are protected by copyright law.

**Adjusting the Vertical Position of Image [Cinema Position] (for Cinema only)**

This feature adjusts the vertical position of the image when viewing video with Cinema aspect ratio selected. When [Cinema] is selected in [Aspect Ratio], the image is displayed with black borders on the top and bottom. You can adjust the vertical position from the top to the bottom of the black area.

*NOTE: This option is available only when [Cinema] is selected in [Aspect Ratio].*

**Adjusting Horizontal/Vertical Position, Clock and Phase [Horizontal/Vertical/Clock/Phase] (available for RGB signal only)**

You can adjust the image manually for position and stability; [Horizontal], [Vertical], [Clock] and [Phase].

[Horizontal/Vertical]

Adjusts the image location horizontally and vertically.

[Clock]

Use this item to fine tune the computer image or to remove any vertical banding that might appear. This function adjusts the clock frequencies that eliminate the horizontal banding in the image. This adjustment may be necessary when you connect your computer for the first time.

[Phase]

Use this item to adjust the clock phase or to reduce video noise, dot interference or cross talk. (This is evident when part of your image appears to be shimmering.)

Use [Phase] only after the [Clock] is complete.

**NOTE:**

*A projected image may not be displayed correctly during adjustment of [Clock] or [Phase]. This is normal.*

*NOTE: The [Horizontal] and [Vertical] options can be adjusted for component signals.*

**Selecting Video Filter Level [Video Filter] (not available for Digital RGB, Video and S-Video)**

Select one of the three levels for reducing video noise: Off, Less or More.

- Off ..... The low-pass filter is turned off.
- Less ..... The low-pass filter is applied partially.
- More ..... The low-pass filter is applied fully.

**NOTE:**

- Selecting [Off] will give best image quality by way of higher bandwidth. Selecting [Less] will soften the image and selecting [More] will soften the image more.

## 6 Menu Descriptions & Functions [Setup]

### [General]

VT695/VT595

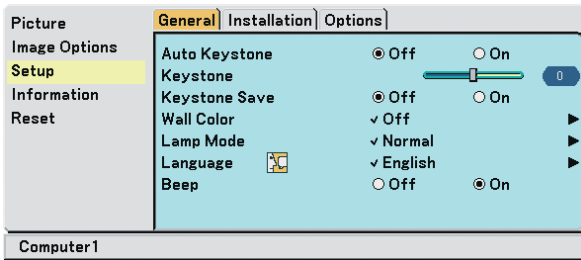

VT590/VT490/VT59/VT49

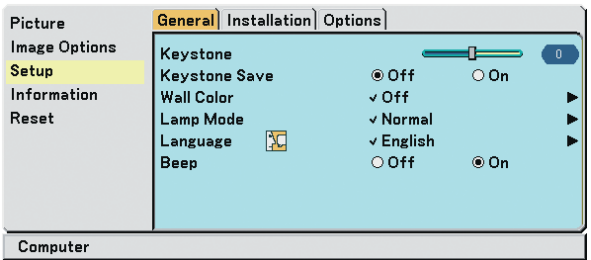

### Enabling Auto Keystone [Auto Keystone] (VT695/VT595 only)

This feature allows the projector to detect its tilt and correct vertical distortion automatically. To turn on the Auto Keystone feature, select [On].

### Correcting Vertical Keystone Distortion Manually [Keystone]

You can correct vertical distortion manually.

### Saving Vertical Keystone Correction [Keystone Save]

This option enables you to save your current keystone settings.

Off ..... Does not save current keystone correction settings

On ..... Saves current keystone correction settings

Saving your change once affects all sources. The changes are saved when the projector is off.

*NOTE: When [Auto Keystone] is set to [On], [Keystone Save] is not available. Next time you turn on the power, the Auto Keystone function will work and the data stored with [Keystone Save] will be invalid.*

### Selecting Wall Color Correction Mode [Wall Color]

This function allows for quick adaptive color correction in applications where the screen material is not white. The following nine options are available: Off, Blackboard, Blackboard (Gray), Light yellow, Light green, Light blue, Sky blue, Light rose and Pink.

### Selecting Lamp Mode [Lamp Mode]

This feature enables you to select two brightness modes of the lamp: Normal and Eco modes. The lamp life can be extended by using the Eco mode.

Normal Mode ..... This is the Default setting (100% Brightness).

Eco Mode ..... Select this mode to increase the lamp life (approx. 80% Brightness).

approx. 75% Brightness: VT695

### Selecting Menu Language [Language]

You can choose one of 21 languages for the on-screen menu.

### Enabling Key Sound and Error Sound [Beep]

This feature turns on or off the keypad sound or alarm when a button on the cabinet and the remote control is pressed or an error occurs.

[Installation]

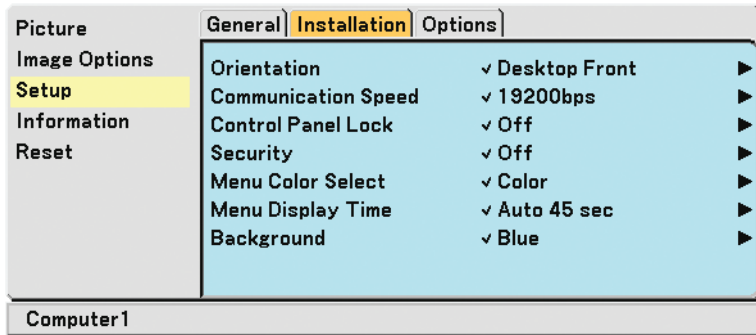

**Selecting Projector Orientation [Orientation]**

This sets your image for your type of projection application. The options are: desktop front projection, ceiling rear projection, desktop rear projection, and ceiling front projection.

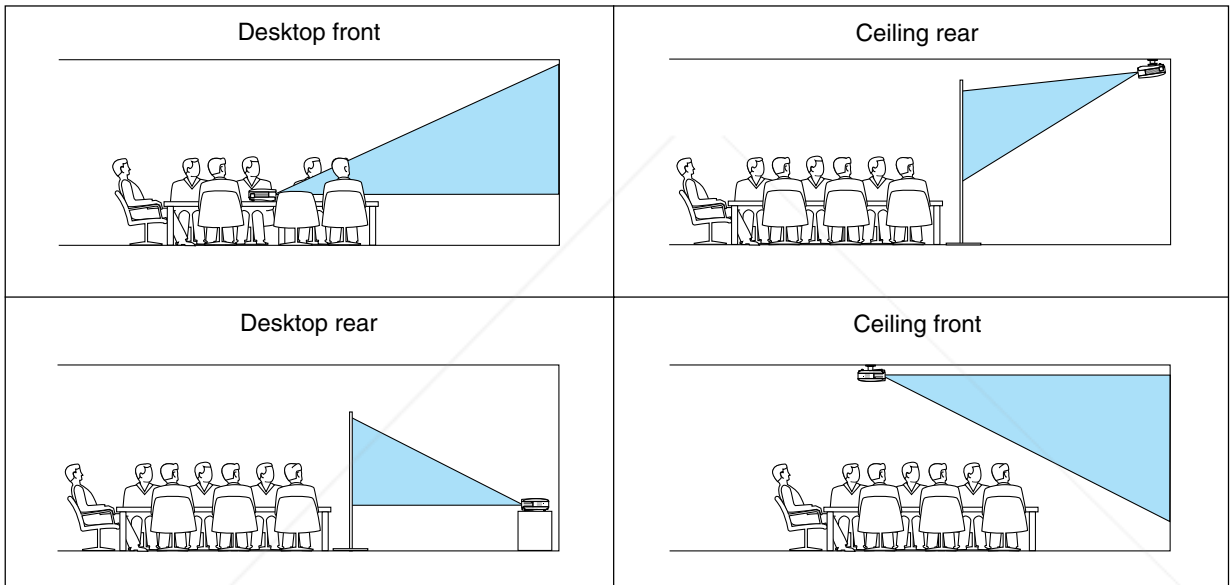

**Selecting Communication Speed [Communication Speed]**

This feature sets the baud rate of the PC Control port (Mini DIN 8 Pin). It supports data rates from 4800 to 19200 bps. The default is 19200 bps.

Select the appropriate baud rate for your equipment to be connected (depending on the equipment, a lower baud rate may be recommended for long cable runs).

Your selected communication speed will not be affected even when [Reset] is done from the menu.

**Disabling the Cabinet Buttons [Control Panel Lock]**

This option turns on or off the Key Lock function for cabinet buttons.

**NOTE:**

- The Control Panel Lock setting will not affect the remote control or PC Control Functions.
- When the cabinet buttons are disabled, pressing and holding the EXIT button on the projector cabinet for about 10 seconds will change the setting to enable.
- The Key Lock icon will be displayed at the bottom right of the menu when Control Panel Lock is enabled.

**Enabling Security [Security]**

This feature turns on or off the Security function.

Unless the correct keyword is entered, the projector cannot project an image. (→page 31)

**Selecting Menu Color [Menu Color Select]**

You can choose between two color modes for menu color: color and monochrome.

**Selecting Menu Display Time [Menu Display Time]**

This option allows you to select how long the projector waits after the last touch of a button to turn off the menu. The preset choices are [Manual], [Auto 5 sec], [Auto 15 sec], and [Auto 45 sec].

**Selecting a Color for Background [Background]**

Use this feature to display a blue, black or logo when no signal is available.

**[Options]**

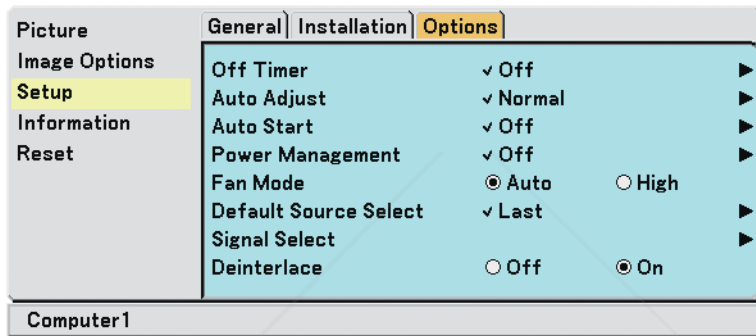

**Setting Off Timer [Off Timer]**

You can use the Off Timer feature to turn off the projector automatically at a preset time. Eight preset times can be selected: Off, 0:30, 1:00, 2:00, 4:00, 8:00, 12:00 and 16:00.

**Setting Auto Adjust [Auto Adjust]**

This feature sets the Auto Adjust mode so that the RGB image can be automatically or manually adjusted for noise and stability. You can automatically make adjustment in two ways: Normal and Fine

- Off ..... The RGB image will not be automatically adjusted.  
You can manually optimize the RGB image.
- Normal ..... Default setting. The RGB image will be automatically adjusted. Normally select this option.
- Fine ..... Select this option if fine adjustment is needed. It takes more time to switch to the source than when [Normal] is selected.

**Enabling Auto Start [Auto Start]**

Enables the projector on automatically when the power cable is inserted into an active power outlet. This eliminates the need to always use the POWER button on the remote control or projector cabinet. To use the Auto Start function, you must first press the main power switch to the position "On" (I) before plugging the power cable.

**Enabling Power Management [Power Management]**

When this option is selected you can enable the projector to automatically turn off (at the selected time: 5 min., 10 min., 20 min., 30 min.) if there is no signal received by any input.

### Enabling Fan Speed Mode [Fan Mode]

This option allows you to select two modes for fan speed: Auto mode and High speed mode.

Auto ..... The built-in fans automatically run at a variable speed according to the internal temperature.

High ..... The built-in fans run at a fixed high speed.

When you wish to cool down the temperature inside the projector quickly, select [High].

---

*NOTE: It is recommended that you select High speed mode if you continue to use the projector for consecutive days.*

---

### Selecting Default Source [Default Source Select]

You can set the projector to default to any one of its inputs each time the projector is turned on.

Last ..... Sets the projector to default to the previous or last active input each time the projector is turned on.

Auto ..... Searches for an active source in order of Computer 1 → Computer 2 (Digital) → Computer 2 (Analog) → Video → S-Video → Computer 1 and displays the first found source.

NOTE The VT590, VT490, VT59 and VT49 will search for an active source in order of Computer → Video → S-Video → Computer and displays the first found source.

Computer 1 ..... Displays the RGB source from the COMPUTER 1 IN connector every time the projector is started up. (VT695/VT595 only)

Computer 2 (Digital) ... Displays the DVI digital source from the COMPUTER 2 IN connector every time the projector is started up. (VT695/VT595 only)

Computer 2 (Analog) .. Displays the RGB source from the COMPUTER 2 IN connector every time the projector is started up. (VT695/VT595 only)

Computer ..... Displays the RGB source from the COMPUTER IN connector every time the projector is started up. (VT590/VT490/VT59/VT49 only)

Video ..... Displays the Video source from the VIDEO IN connector every time the projector is started up.

S-Video ..... Displays the Video source from the S-VIDEO IN connector every time the projector is started up.

### Selecting Signal Format [Signal Select]

[Computer \*],[Computer 1],[Computer 2 (Analog)]

Allows you to choose [Computer \*], [Computer 1], or [Computer 2 (Analog)] for an RGB source such as a computer, or [Component] for a component video source such as a DVD player. Normally select [RGB/Component] and the projector automatically detects a component signal. However there may be some component signals that the projector is unable to detect. If this is the case, select [Component].

\*[Computer]: VT590, VT490, VT59 and VT49 only

[Video & S-Video System Select]

This feature enables you to select composite video standards automatically or manually.

Normally select [Auto] and the projector will automatically detect the video standard.

In the case where the projector has difficulty detecting the video standard, select the appropriate video standard from the menu.

This must be done for Video and S-Video respectively.

### Enabling the deinterlace [Deinterlace]

Turns on or off the deinterlace function for a telecine signal.

On ..... Default standard setting.

Off ..... Select this option if there is any jitter or artifacts in video.

---

*NOTE: This feature is not available for RGB, 480p, 576p and HDTV signals.*

---



## 7 Menu Descriptions & Functions [Information]

Displays the status of the current signal and lamp usage. This item has three pages. The information included is as follows:

### [Usage Time]

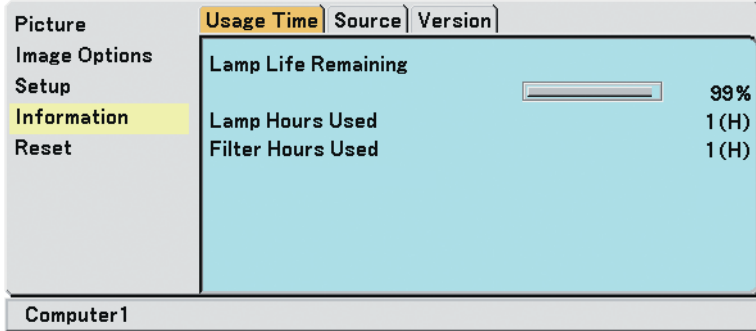

[Lamp Life Remaining] (%)\*

[Lamp Hours Used] (H)

[Filter Hours Used] (H)

\* The progress indicator shows the percentage of remaining bulb life.

The value informs you of the amount of lamp usage. When the remaining lamp time reaches 0, the Remaining Lamp Time bar indicator changes from 0% to 100 Hours and starts counting down.

If the remaining lamp time reaches 0 hours, the projector will not turn on regardless of whether the lamp mode is set to Normal or Eco.

Model	Lamp life(H)		Replacement lamp
	Normal	Eco	
VT695/VT595/ VT590/VT490	2000	3000	VT85LP
VT59/VT49	3000	4000	VT80LP

### [Source]

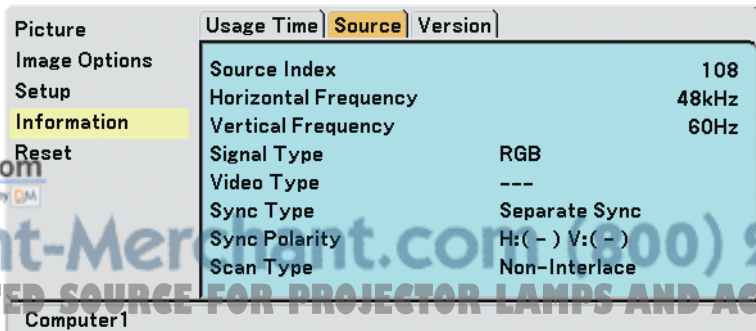

[Source Index]

[Horizontal Frequency]

[Vertical Frequency]

[Signal Type]

[Video Type]

[Sync Type]

[Sync Polarity]

[Scan Type]

**[Version]**

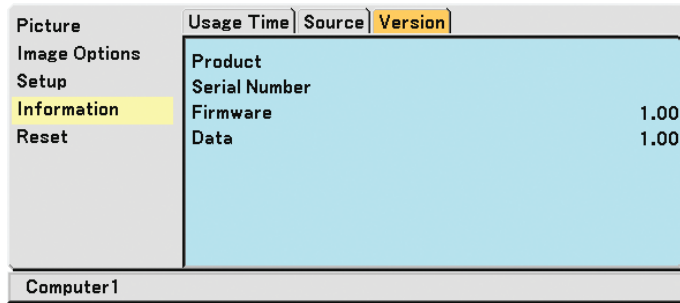

[Product] [Firmware] Version  
 [Serial Number] [Data] Version

**8 Menu Descriptions & Functions [Reset]**

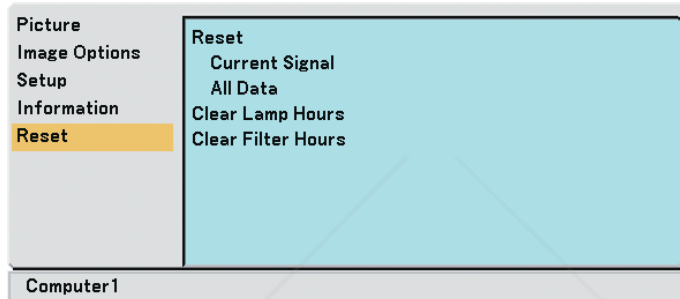

**Returning to Factory Default [Reset]**

The Factory Default feature allows you to change adjustments and settings to the factory preset for a (all) source (s) except the following:

**[Current Signal]**

Resets the adjustments for the current signal to the factory preset levels.

The items that can be reset are: [Preset], [Contrast], [Brightness], [Color], [Hue], [Sharpness], [Aspect Ratio], [Horizontal], [Vertical], [Clock], [Phase] and [Video Filter].

**[All Data]**

Reset all the adjustments and settings for all the signals to the factory preset.

All items can be reset except [Language], [Communication Speed], [Security], [Lamp Life Remaining], [Lamp Hours Used] and [Filter Hours Used].

To reset the lamp usage time, see "Clearing Lamp Hour Meter [Clear Lamp Hours] below".

**Clearing Lamp Hour Meter [Clear Lamp Hours]**

Resets the lamp clock back to zero. Selecting this option displays submenu for a confirmation. Select [Yes] and press the ENTER button.

*NOTE: Elapsed time of the lamp use will not be affected even when [Reset] is done from the menu.*

*NOTE: The projector will turn off and go into standby mode after 2100\* hours (up to 3100\* hours in Eco mode) of service. If this happens, press the HELP button on the remote control for ten seconds to reset the lamp clock back to zero. Do this only after replacing the lamp. \* VT59 and VT49: 3100 hours (up to 4100 hours in Eco mode).*

**Clearing the Filter Usage Hours [Clear Filter Hours]**

Resets the filter usage back to zero. Selecting this option displays submenu for a confirmation. Select [Yes] and press the ENTER button.

*NOTE: Elapsed time of the filter use will not be affected even when [Reset] is done from the menu.*

# 6. Maintenance

This section describes the simple maintenance procedures you should follow to clean the filters and replace the lamp.

## ① Cleaning or Replacing the Filters

The air-filter sponge keeps dust and dirt from getting inside the projector and should be cleaned after every 100 hours of operation (more often in dusty conditions). If the filter is dirty or clogged, your projector may overheat.

### CAUTION

- Turn off the projector, turn off the main power switch and unplug the projector before replacing the filters.
- Only clean the outside of the filter cover with a vacuum cleaner.
- Do not attempt to operate the projector without the filter cover.

### To clean the air-filter:

Vacuum the filter-through the filter cover.

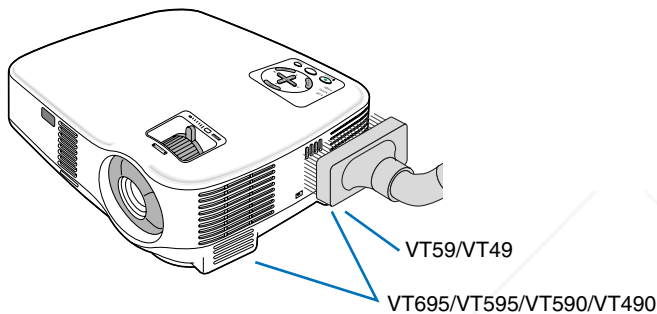

### To replace the filter (sponge):

1. Remove the filter cover by pushing down on the catch of the cover until you feel it detach.

---

*NOTE: The VT695/VT595/VT590/VT490 have two filters; the VT59 and VT49 have one filter only.*

---

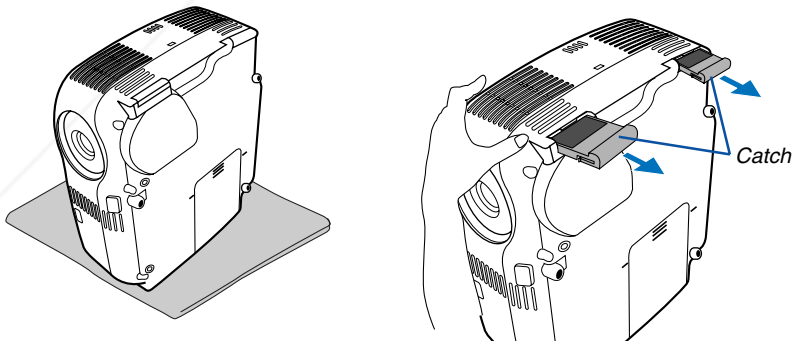

Gently peel off the filter (sponge) and replace it with the new one.

Sponsored by 

**Discount Merchant.com (800) 281-8860**

**THE TRUSTED SOURCE FOR PROJECTOR LAMPS AND ACCESSORIES**

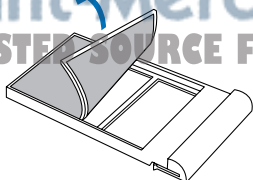

3. Reinstall the new filter cover.

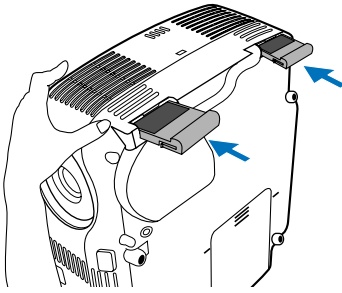

4. Clear the filter hours used.

To reset the filter usage time, from the menu, select [Reset] → [Clear Filter Hours].  
(→page 49 for resetting the filter usage time.)

---

*NOTE: Do not wash the filter with soap and water. Soap and water will damage the filter membrane. Before replacing the filter, remove dust and dirt from the projector cabinet. Keep out dust and dirt during filter replacement.*

---

---

*NOTE: When you replace the lamp, it is also wise to replace the filter. The filter comes in the same package with your replacement lamp.*

---

## ② Cleaning the Cabinet and the Lens

1. Turn off the projector before cleaning.
2. Clean the cabinet periodically with a damp cloth. If heavily soiled, use a mild detergent. Never use strong detergents or solvents such as alcohol or thinner.
3. Use a blower or lens paper to clean the lens, and be careful not to scratch or mar the lens.

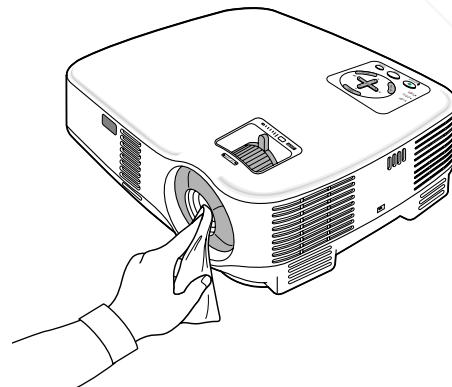
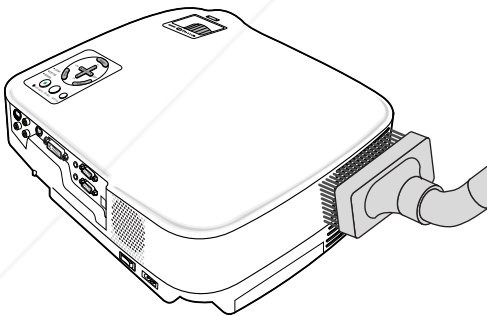

**Discount-Merchant.com (800) 281-8860**  
**THE TRUSTED SOURCE FOR PROJECTOR LAMPS AND ACCESSORIES**

### ③ Replacing the Lamp

After your lamp has been operating for 2000<sup>\*1</sup> hours (up to 3000<sup>\*1</sup> hours in Eco mode) or longer, the LAMP indicator in the cabinet will blink red and the message **[The lamp has reached the end of its usable life. Please replace the lamp.]**<sup>\*2</sup> will appear. Even though the lamp may still be working, replace it at 2000<sup>\*1</sup> (up to 3000<sup>\*1</sup> hours in Eco mode) hours to maintain optimal projector performance. After replacing the lamp, be sure to clear the lamp hour meter. (→ page 49)

#### CAUTION

- DO NOT TOUCH THE LAMP immediately after it has been used. It will be extremely hot. Turn the projector off, wait 30 seconds, turn off the main power switch and then disconnect the power cable. Allow at least one hour for the lamp to cool before handling.
- DO NOT REMOVE ANY SCREWS except two lamp case screws. You could receive an electric shock.
- Do not break the glass on the lamp housing.  
Keep finger prints off the glass surface on the lamp housing. Leaving finger prints on the glass surface might cause an unwanted shadow and poor picture quality.
- The projector will turn off and go into standby mode after 2100<sup>\*1</sup> (up to 3100<sup>\*1</sup> hours in Eco mode) hours of service. If this happens, be sure to replace the lamp. If you continue to use the lamp after 2000<sup>\*1</sup> hours (up to 3000<sup>\*1</sup> hours in Eco mode) of use, the lamp bulb may shatter, and pieces of glass may be scattered in the lamp case. Do not touch them as the pieces of glass may cause injury. If this happens, contact your NEC dealer for lamp replacement.

---

<sup>\*1</sup> NOTE: Lamp life for VT59/VT49 is 3000 hours in Normal mode and 4000 hours in Eco mode.  
The projector will turn off and go into standby mode after 3100 (up to 4100 hours in Eco mode) hours of service.

---

<sup>\*2</sup> NOTE: This message will be displayed under the following conditions:

- for one minute after the projector has been powered on
- when the POWER ON/STAND BY button on the projector cabinet or the POWER OFF button on the remote control is pressed

To turn off the message, press any button on the projector cabinet or the remote control.

---

#### To replace the lamp:

Optional lamp and tools needed for replacement:

- Replacement lamp VT85LP (VT695/VT595/VT590/VT490) or VT80LP (VT59/VT49)

**1. Place the projector on a soft cloth and turn it over to access the lamp cover on the bottom.**

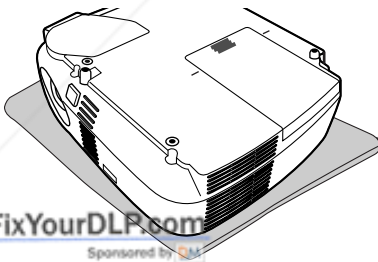

FixYourDLP.com  
Sponsored by

**Discount-Merchant.com (800) 281-8860**  
**THE TRUSTED SOURCE FOR PROJECTOR LAMPS AND ACCESSORIES**

### 2. Remove the lamp cover.

- (1) Press firmly and slide the lamp cover by 1 cm (0.4")
  - Do not force to pull the lamp cover
- (2) Push to release two catches on both sides and slide the lamp cover off.

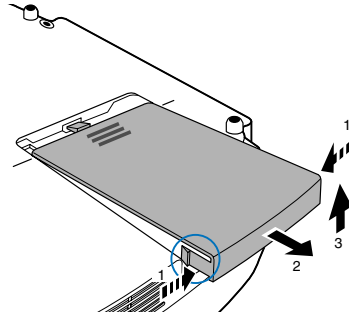
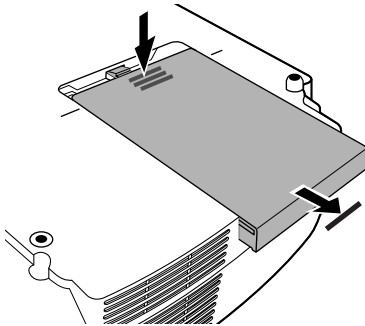

### 3. Remove the lamp housing.

- (1) Loosen the two screws securing the lamp housing until the phillips screwdriver goes into a freewheeling condition. The two screws are not removable.
- (2) Remove the lamp housing by holding it.

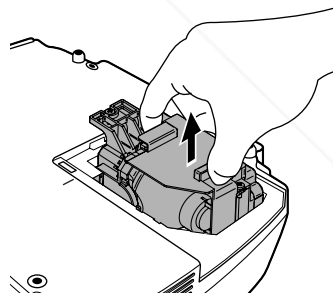
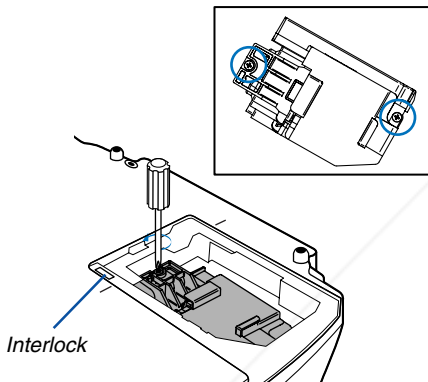

**NOTE:** There is an interlock on this case to prevent the risk of electrical shock. Do not attempt to circumvent this interlock.

### 4. Install a new lamp housing.

(1) Insert a new lamp housing until the lamp housing is plugged into the socket.

#### CAUTION

Do not use a lamp other than the NEC replacement lamp VT85LP (VT695/VT595/VT590/VT490) or VT80LP (VT59/VT49). Order this from your NEC dealer.

(2) Secure it in place with the two screws.

Be sure to tighten the screws.

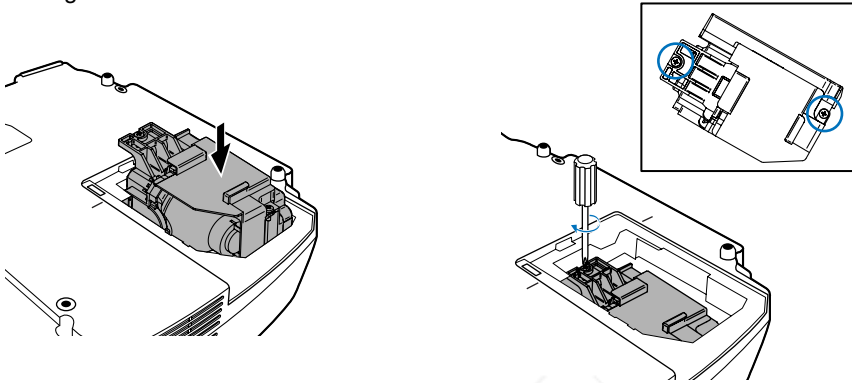

### 5. Reattach the lamp cover.

(1) Place the lamp cover, aligning it with the guiding line.

(2) Slide the lamp cover back until it snaps into place.

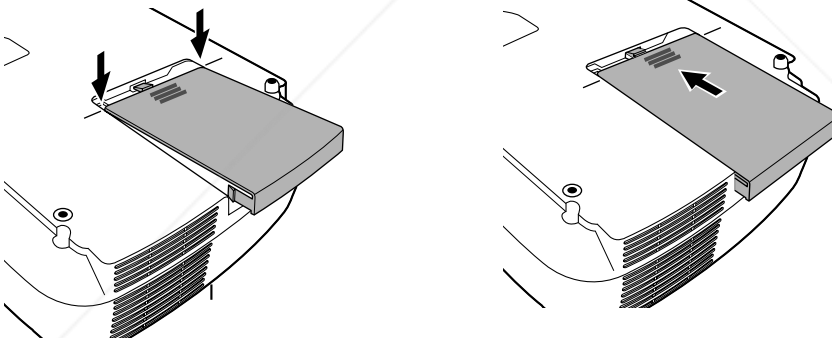

6. Connect the supplied power cable, turn on the Main Power switch and turn on the projector.

7. Finally, select the menu → [Reset] → [Clear Lamp Hours] to reset the lamp usage hours.

*Note:* When the lamp exceeds 2100\* hours (up to 3100\* hours in Eco mode) of service, the projector cannot turn on and the LAMP indicator is not displayed.

If this happens, press the HELP button on the remote control for ten seconds to reset the lamp clock back to zero.

When the lamp time clock is reset to zero, the LAMP indicator goes out.

\* VT59 and VT49: 3100 hours (up to 4100 hours in Eco mode).

THE TRUSTED SOURCE FOR PROJECTOR LAMPS AND ACCESSORIES

# 7. Appendix

## 1 Troubleshooting

This section helps you resolve problems you may encounter while setting up or using the projector.

### Indicator Messages

#### Power Indicator

Indicator Condition			Projector Condition	Note
Off			The main power is off	–
Blinking light	Green	0.5 sec On, 0.5 sec Off	The projector is getting ready to turn on.	Wait for a moment.
		2.5 sec On, 0.5 sec Off	Off Timer is enabled.	–
	Orange	0.5 sec On, 0.5 sec Off	The projector is cooling down.	Wait for a moment.
Steady light	Green		The projector is turned on.	–
	Orange		The projector is in Standby.	–

#### Status Indicator

Indicator Condition			Projector Condition	Note
Off			Normal	–
Blinking light	Red	1 cycle (0.5 sec On, 2.5 sec Off)	Lamp cover error or lamp housing error	Replace the lamp cover or lamp housing correctly.
		2 cycle (0.5 sec On, 0.5 sec Off)	Temperature error	The projector is overheated. Move the projector to a cooler location.
		4 cycle (0.5 sec On, 0.5 sec Off)	Fan error	Fans will not work correctly.
		6 cycle (0.5 sec On, 0.5 sec Off)	Lamp error	Lamp fails to light. Wait a full minute and then turn on again.
	Green		Re-firing the lamp (The projector is cooling down.)	The projector is re-firing. Wait for a moment.
Steady light	Orange		Cabinet button is locked	You have pressed cabinet button when Cabinet Button is locked.

#### Lamp Indicator

Indicator Condition			Projector Condition	Note
Off			Normal	–
Blinking light	Red		Lamp has reached its end of life. Lamp replacement message will be displayed.	Replace the lamp.
Steady light	Red		Lamp has been used beyond its limit. The projector will not turn on until the lamp is replaced.	Replace the lamp.
	Green		Lamp mode is set to Eco mode	–

#### Over-Temperature Protection

If the temperature inside the projector rises too high, the over-temperature protector will automatically turn off the lamp with the STATUS indicator blinking (2-cycle On and Off.)

Should this happen, do the following:

- Unplug the power cable after the cooling fans stop.
- Move the projector to a cooler location if the room where you are presenting is particularly too warm.
- Clean the ventilation holes if they are clogged with dust.
- Wait about 60 minutes until the inside of the projector becomes cool enough.



## Common Problems &amp; Solutions (→ "Power/Status/Lamp Indicator" on page 55.)

Problem	Check These Items
Does not turn on	<ul style="list-style-type: none"> <li>• Check that the power cable is plugged in and that the power button on the projector cabinet or the remote control is on. (→ pages 19 and 20)</li> <li>• Ensure that the lamp cover is installed correctly. (→ page 54)</li> <li>• Check to see if the projector has overheated. If there is insufficient ventilation around the projector or if the room where you are presenting is particularly warm, move the projector to a cooler location.</li> <li>• Check to see if the lamp usage exceeds 2100* hours (up to 3100* hours : Eco mode). If so, replace the lamp. After replacing the lamp, reset the lamp hours used. (→ page 49)</li> <li>* VT59 and VT49: 3100 hours (up to 4100 hours in Eco mode)</li> <li>• The lamp may fail to light. Wait a full minute and then turn on the power again.</li> </ul>
Will turn off	<ul style="list-style-type: none"> <li>• Ensure that the Power Management or Off Timer is off. (→ page 46)</li> </ul>
No picture	<ul style="list-style-type: none"> <li>• Use the COMPUTER, the VIDEO or the S-VIDEO button on the remote control to select your source (Computer, Video or S-Video). (→ page 22) If there is still no picture, press the button again.</li> <li>• Ensure your cables are connected properly.</li> <li>• Use menus to adjust the brightness and contrast. (→ page 42)</li> <li>• Remove the lens cap.</li> <li>• Reset the settings or adjustments to factory preset levels using the [Reset] in the Menu. (→ page 49)</li> <li>• Enter your registered keyword if the Security function is enabled. (→ page 31)</li> <li>• Be sure to connect the projector and notebook PC while the projector is in standby mode and before turning on the power to the notebook PC. In most cases the output signal from the notebook PC is not turned on unless connected to the projector before being powered up. * If the screen goes blank while using your remote control, it may be the result of the computer's screen-saver or power management software.</li> <li>• See also the next page.</li> </ul>
Picture suddenly becomes dark	<ul style="list-style-type: none"> <li>• When one of the following happens, the Lamp mode automatically changes from Normal to Eco. * When there are no signals → To return to the Normal mode, select another available source. * When the room where you're presenting is particularly warm → Move the projector to a cooler location, or set [Fan Mode] to [High].</li> </ul>
Color tone or hue is unusual	<ul style="list-style-type: none"> <li>• Check if an appropriate color is selected in [Wall Color]. If so, select an appropriate option. (→ page 44)</li> <li>• Adjust [Hue] in [Picture]. (→ page 42)</li> </ul>
Image isn't square to the screen	<ul style="list-style-type: none"> <li>• Reposition the projector to improve its angle to the screen. (→ page 23)</li> <li>• Use the Keystone correction function to correct the trapezoid distortion. (→ page 25)</li> </ul>
Picture is blurred	<ul style="list-style-type: none"> <li>• Adjust the focus. (→ page 24)</li> <li>• Reposition the projector to improve its angle to the screen. (→ page 23)</li> <li>• Ensure that the distance between the projector and screen is within the adjustment range of the lens. (→ page 11 for VT695, page 11 for VT595/VT590/VT490/VT59 and 12 for VT49)</li> <li>• Condensation may form on the lens if the projector is cold, brought into a warm place and is then turned on. Should this happen, let the projector stand until there is no condensation on the lens.</li> </ul>
Image is scrolling vertically, horizontally or both	<ul style="list-style-type: none"> <li>• Use the COMPUTER, the VIDEO or the S-VIDEO button on the remote control to select your source (Computer, Video or S-Video). (→ page 22)</li> <li>• Adjust the computer image manually with the Horizontal/Vertical in the [Image Options]. (→ page 43)</li> </ul>
Remote control does not work	<ul style="list-style-type: none"> <li>• Install new batteries. (→ page 8)</li> <li>• Make sure there are no obstacles between you and the projector.</li> <li>• Stand within 22 feet (7 m) of the projector. (→ page 8)</li> </ul>
Indicator is lit or blinking	<ul style="list-style-type: none"> <li>• See the POWER/STATUS/LAMP Indicator. (→ page 55)</li> </ul>
Loss color in RGB mode	<ul style="list-style-type: none"> <li>• Press the AUTO ADJ. button on the projector cabinet or the remote control. (→ page 27)</li> <li>• Adjust the computer image manually with Clock/Phase in [Image Options] in the menu. (→ page 43)</li> </ul>

For more information contact your dealer.

### If there is no picture, or the picture is not displayed correctly.

- Power on process for the projector and the PC.

Be sure to connect the projector and notebook PC while the projector is in standby mode and before turning on the power to the notebook PC.

In most cases the output signal from the notebook PC is not turned on unless connected to the projector before being powered up.

---

*NOTE: You can check the horizontal frequency of the current signal in the projector's menu under Information. If it reads "0kHz", this means there is no signal being output from the computer. (→ page 48 or go to next step)*

---

- Enabling the computer's external display.

Displaying an image on the notebook PC's screen does not necessarily mean it outputs a signal to the projector. When using a PC compatible laptop, a combination of function keys will enable/disable the external display. Usually, the combination of the 'Fn' key along with one of the 12 function keys gets the external display to come on or off. For example, NEC laptops use Fn + F3, while Dell laptops use Fn + F8 key combinations to toggle through external display selections.

- Non-standard signal output from the computer

If the output signal from a notebook PC is not an industry standard, the projected image may not be displayed correctly. Should this happen, deactivate the notebook PC's LCD screen when the projector display is in use. Each notebook PC has a different way of deactivate/reactivate the local LCD screens as described in the previous step. Refer to your computer's documentation for detailed information.

- Image displayed is incorrect when using a Macintosh

When using a Macintosh with the projector, set the DIPswitch of the Mac adapter (not supplied with the projector) according to your resolution. After setting, restart your Macintosh for the changes to take affect.

For setting display modes other than those supported by your Macintosh and the projector, changing the DIP switch on a Mac adapter may bounce an image slightly or may display nothing. Should this happen, set the DIP switch to the 13" fixed mode and then restart your Macintosh. After that, restore the DIP switches to a displayable mode and then restart the Macintosh again.

---

*NOTE: A Video Adapter cable manufactured by Apple Computer is needed for a PowerBook which does not have a mini D-Sub 15-pin connector.*

---

- Mirroring on a PowerBook

\* When using the projector with a Macintosh PowerBook, output may not be set to 1024 x 768 unless "mirroring" is off on your PowerBook. Refer to owner's manual supplied with your Macintosh computer for mirroring.

Folders or icons are hidden on the Macintosh screen

Folders or icons may not be seen on the screen. Should this happen, select [View] → [Arrange] from the Apple menu and arrange icons.

## ② Specifications

This section provides technical information about the VT695/VT595/VT590/VT490/VT59/VT49 projector's performance.

<b>Model Number</b>	<b>VT695/VT595/VT590/VT490/VT59/VT49</b>
<b>Optical</b>	
LCD Panel	<b>VT695:</b> 0.63" p-Si TFT active-matrix with Micro Lens Array <b>VT595/VT590/VT490/VT59/VT49:</b> 0.6" p-Si TFT active-matrix with Micro Lens Array
Resolution	<b>VT695/VT595/VT590/VT59:</b> 1024 × 768 pixels* native, up to UXGA with Advanced AccuBlend <b>VT490/VT49:</b> 800 × 600 pixels* native, up to UXGA with Advanced AccuBlend
Lens	<b>VT695/VT595/VT590/VT490/VT59:</b> Manual zoom and manual focus F1.7 - 2.0 f=18.9 - 22.7 mm <b>VT49:</b> Digital zoom and manual focus F1.7 f=22.4 mm
Lamp	<b>VT695:</b> 200 W DC lamp (150W Eco mode) <b>VT595/VT590/VT490:</b> 190 W DC lamp (150W Eco mode) <b>VT59/VT49:</b> 150 W DC lamp (120W Eco mode)
Light Output**	<b>VT695:</b> 2500 lumens (approx. 75% in Eco mode) <b>VT595/VT590/VT490:</b> 2000 lumens (approx. 80% in Eco mode) <b>VT59/VT49:</b> 1600 lumens (approx. 80% in Eco mode)
Contrast Ratio	600: 1 (full white: full black)
Image Size (Diagonal)	<b>VT695/VT595/VT590/VT490/VT59:</b> 21 - 300 inches / 0.5 - 7.6 m <b>VT49:</b> 25 - 300 inches / 0.6 - 7.6 m
Projection Distance	<b>VT695:</b> 28" - 424" / 0,7 - 10,7 m <b>VT595/VT590/VT490/VT59:</b> 29" - 438" / 0,7 - 11,1 m <b>VT49:</b> 35" - 434" / 0,9 - 11,0 m
Projection Angle	<b>VT695/VT595/VT590/VT490/VT59:</b> Tele: 8.3° - 8.6°/ Wide: 9.9° - 10.3° <b>VT49:</b> 8.4° - 8.7°
Keystone Correction	+/- 30° Vertical (Auto Keystone on VT695/VT595 only)
<b>Electrical</b>	
Inputs	<b>VT695/VT595:</b> 1 RGB/Component (D-Sub 15 Pin), 1 RGB (Digital/Analog) (DVI-I 29 Pin, HDCP*** supported), 1 S-Video (DIN 4 Pin), 1 Video (RCA), 1 (L/R) RCA Audio, 1 Stereo Mini Audio, 1 PC Control (DIN 8 Pin) <b>VT590/VT490/VT59/VT49:</b> 1 RGB/Component (D-Sub 15 Pin), 1 S-Video (DIN 4 Pin), 1 Video (RCA), 1 (L/R) RCA Audio, 1 PC Control (DIN 8 Pin)
Outputs	1 RGB (D-Sub 15 Pin), 1 Stereo Mini Audio (VT695/VT595 only)
Video Compatibility	NTSC, NTSC4.43, PAL, PAL-60, PAL-N, PAL-M, SECAM, HDTV: 1080i, 1080i/50Hz, 720p, 576p, 480p, 480i/60Hz
Scan Rate	Horizontal: 15 kHz to 100 kHz (RGB: 24 kHz or over) Vertical: 50 Hz to 120 Hz
Video Bandwidth	RGB: 80 MHz (-3dB)
Color Reproduction	16.7 million colors simultaneously, Full color
Horizontal Resolution	NTSC / NTSC4.43/PAL/PAL-M/PAL-N/PAL60: 540 TV lines SECAM: 300 TV lines RGB: <b>VT695/VT595/VT590/VT59:</b> 1024 dots (H) × 768 dots (V), <b>VT490/VT49:</b> 800 dots (H) × 600 dots (V)
External Control	RS232, IR

Sync Compatibility	Separate Sync / Composite Sync / Sync on Green / Sync on Video
Built-in Speaker	<b>VT695/VT595:</b> 5W (monaural) <b>VT590/VT490/VT59/VT49:</b> 1W (monaural)
Power Requirement	100 - 240V AC, 50 / 60 Hz
Input Current	<b>VT695/VT595/VT590/VT490:</b> 3.1 - 1.3A <b>VT59/VT49:</b> 2.4 - 1.0A
Power Consumption	<b>VT695:</b> 9W in Standby mode / 285W in Lamp Normal mode / 220W in Lamp Eco mode <b>VT595:</b> 9W in Standby mode / 270W in Lamp Normal mode / 220W in Lamp Eco mode <b>VT590/VT490:</b> 9W in Standby mode / 255W in Lamp Normal mode / 205W in Lamp Eco mode <b>VT59/VT49:</b> 9W in Standby mode / 205W in Lamp Normal mode / 170W in Lamp Eco mode
<b>Mechanical</b>	
Installation Orientation	Desktop/Front, Desktop/Rear, Ceiling/Front, Ceiling/Rear
Dimensions	12.2" (W) × 4.4" (H) × 10.2" (D) 309mm (W) × 112mm (H) × 258mm (D) (not including protrusions)
Weight	<b>VT695/VT595:</b> approx. 6.6 lbs / 3.0 kg <b>VT590/VT490:</b> approx. 6.4 lbs / 2.9 kg <b>VT59/VT49:</b> approx. 6.2 lbs / 2.8 kg
Environmental Considerations	Operational Temperatures : 41° to 104°F (5° to 40°C), (Eco mode selected automatically at 95°F to 104°F/35°C to 40°C) 20% to 80% humidity (non-condensing) Storage Temperatures : 14° to 122°F (-10° to 50°C), 20% to 80% humidity (non-condensing)

\* Effective pixels are more than 99.99%.

\*\* This is the light output value (lumens) when the [Preset] mode is set to [High-Bright]. If any other mode is selected as the [Preset] mode, the light output value may drop slightly.

\*\*\* What is HDCP/HDCP technology?

HDCP is an acronym for High-bandwidth Digital Content Protection. High bandwidth Digital Content Protection (HDCP) is a system for preventing illegal copying of video data sent over a Digital Visual Interface (DVI).

If you are unable to view material via the DVI input, this does not necessarily mean the VT695/VT595 projector is not functioning properly. With the implementation of HDCP, there may be cases in which certain content is protected with HDCP and might not be displayed due to the decision/intention of the HDCP community (Digital Content Protection, LLC).



**Discount-Merchant.com (800) 281-8860**  
**THE TRUSTED SOURCE FOR PROJECTOR LAMPS AND ACCESSORIES**

Regulations

**VT695/VT595/VT590/VT490/VT49:** *For United States:*

UL Approved (UL 60950 - 1)  
Meets FCC Class B requirements

*For Canada:*

UL Approved (CSA 60950 - 1)  
Meets DOC Canada Class B requirements

*For Australia/New Zealand:*

Meets AS/NZS CISPR.22 Class B

*For Europe:*

Meets EMC Directive (EN55022, EN55024, EN61000-3-2, EN61000-3-3)  
Meets Low Voltage Directive (EN60950 - 1, TÜV GS Approved)



**VT59:**

Meets EMC Directive (EN55022, EN55024, EN61000-3-2, EN61000-3-3)  
Meets Low Voltage Directive (EN60950-1, TÜV GS Approved)



For additional information visit:

US : <http://www.necvisualsystems.com>

Europe : <http://www.neceurope.com/>

Global : <http://www.nec-pj.com/>

For information on our optional accessories, visit our website or see our brochure.

The specifications are subject to change without notice.



**Discount-Merchant.com (800) 281-8860**  
**THE TRUSTED SOURCE FOR PROJECTOR LAMPS AND ACCESSORIES**

### 3 Cabinet Dimensions

Although the appearance is slightly different, the VT695, VT595, VT590, VT490, VT59 and VT49 are the same in dimensions.

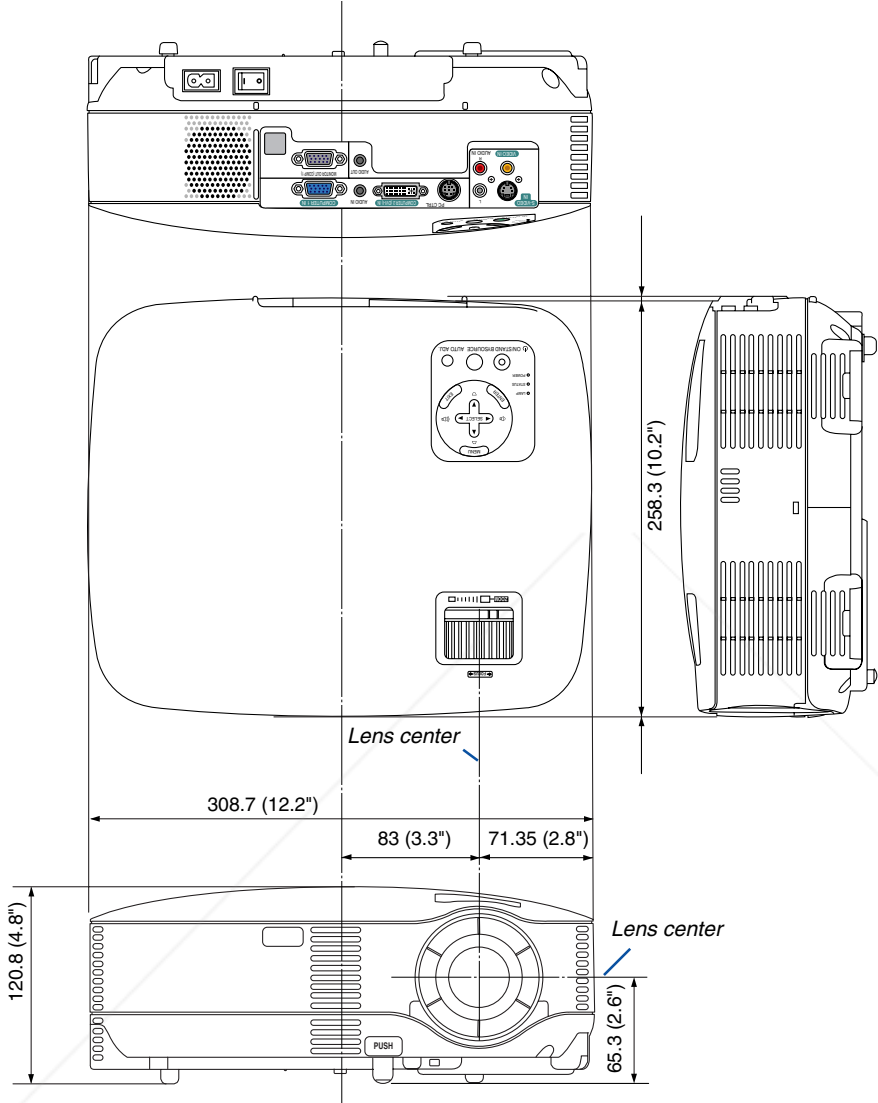

Unit: mm (inch)



**Discount-Merchant.com (800) 281-8860**  
THE TRUSTED SOURCE FOR PROJECTOR LAMPS AND ACCESSORIES

## ④ Pin Assignments of D-Sub COMPUTER Input Connector

### Mini D-Sub 15 Pin Connector

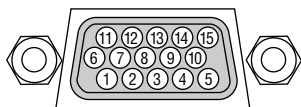

Signal Level

Video signal : 0.7Vp-p (Analog)

Sync signal : TTL level

Pin No.	RGB Signal (Analog)	YCbCr Signal
1	Red	Cr
2	Green or Sync on Green	Y
3	Blue	Cb
4	Ground	
5	Ground	
6	Red Ground	Cr Ground
7	Green Ground	Y Ground
8	Blue Ground	Cb Ground
9	No Connection	
10	Sync Signal Ground	
11	No Connection	
12	Bi-directional DATA (SDA)*	
13	Horizontal Sync or Composite Sync	
14	Vertical Sync	
15	Data Clock*	

\* Only COMPUTER 1 input connector supported on VT695/VT595.

## 5 Compatible Input Signal List

Horizontal: 15KHz to 100KHz (RGB: 24KHz or over)

Vertical: 50Hz to 120Hz

Signal	Resolution ( Dots )	Frequency H. ( kHz )	Refresh Rate ( Hz )	
NTSC	–	15.73	59.94	
PAL	–	15.63	50.00	
PAL60	–	15.73	60.00	
SECAM	–	15.63	50.00	
D VESA	640 × 480	31.47	59.94	
D IBM	640 × 480	31.48	59.95	
D MAC	640 × 480	35.00	66.67	
D VESA	640 × 480	37.86	72.81	
D VESA	640 × 480	37.50	75.00	
D IBM	640 × 480	39.38	75.00	
D VESA	640 × 480	43.27	85.01	
D IBM	720 × 350	31.47	70.08	
D IBM	720 × 350	39.44	87.85	
D IBM	720 × 400	39.44	87.85	
D VESA	800 × 600	35.16	56.25	
D VESA	800 × 600	37.88	60.32	
D VESA	800 × 600	48.08	72.19	
D VESA	800 × 600	46.88	75.00	
D VESA	800 × 600	53.67	85.06	
@ D MAC	832 × 624	49.72	74.55	
@ D VESA	1024 × 768	48.36	60.00	
@ D VESA	1024 × 768	56.48	70.07	
@ D MAC	1024 × 768	60.24	74.93	
@ D VESA	1024 × 768	60.02	75.03	
@ D VESA	1024 × 768	68.68	85.00	
@ D # VESA	1152 × 864	67.50	75.00	
@ D # MAC	1152 × 870	68.68	75.06	
@ D # VESA	1280 × 960	60.00	60.00	
@ #	1280 × 960	75.00	75.00	
@ #	1280 × 960	85.94	85.00	
@ D # VESA	1280 × 1024	63.98	60.02	
@ D # MAC	1280 × 1024	64.30	60.38	
@ # MAC	1280 × 1024	69.87	65.18	
@ # VESA	1280 × 1024	79.98	75.02	
@ # VESA	1280 × 1024	91.15	85.02	
@ # VESA	1400 × 1050	63.98	60.02	
@ # VESA	1600 × 1200	75.00	60.00	
@ # VESA	1600 × 1200	81.25	65.00	
@ # VESA	1600 × 1200	87.50	70.00	
@ # VESA	1600 × 1200	93.75	75.00	
	SDTV(576i)	–	15.63	50.00 Interlace
D	SDTV(576p)	–	31.25	50.00 Progressive
@ D #	HDTV (1080i)	1920 × 1080	33.75	60.00 Interlace
@ D #	HDTV (1080i)	1920 × 1080	28.13	50.00 Interlace
@ D #	HDTV (720p)	1280 × 720	45.00	60.00 Progressive
	SDTV (480p)	–	31.47	59.94 Progressive
	DVD YCbCr	–	15.73	59.94 Interlaced
	DVD YCbCr	–	15.63	50.00 Interlaced

# : Images in above flagged with # are compressed with Advanced AccuBlend on VT695/VT595/VT590/VT59.

D : Images in above flagged with "D" are supported by the DVI digital signals on VT695/VT595.

@ : Images in above flagged with @ are compressed with Advanced AccuBlend on VT490/VT49.

**NOTE:** Some composite sync signals may not be displayed correctly.

Signals other than those specified in the table above may not be displayed correctly. If this should happen, change the refresh rate or resolution on your PC. Refer to Display Properties help section of your PC for procedures.

UXGA (1600×1200) is supported for separate sync signal only.



## ⑥ PC Control Codes and Cable Connection

### PC Control Codes (VT695/VT595)

Function	Code Data								
POWER ON	02H	00H	00H	00H	00H	02H			
POWER OFF	02H	01H	00H	00H	00H	03H			
INPUT SELECT COMPUTER 1	02H	03H	00H	00H	02H	01H	01H	09H	
INPUT SELECT COMPUTER 2 (Digital)	02H	03H	00H	00H	02H	01H	1AH	22H	
INPUT SELECT COMPUTER 2 (Analog)	02H	03H	00H	00H	02H	01H	02H	0AH	
INPUT SELECT VIDEO	02H	03H	00H	00H	02H	01H	06H	0EH	
INPUT SELECT S-VIDEO	02H	03H	00H	00H	02H	01H	0BH	13H	
PICTURE MUTE ON	02H	10H	00H	00H	00H	12H			
PICTURE MUTE OFF	02H	11H	00H	00H	00H	13H			
SOUND MUTE ON	02H	12H	00H	00H	00H	14H			
SOUND MUTE OFF	02H	13H	00H	00H	00H	15H			

### PC Control Codes (VT590/VT490/VT59/VT49)

Function	Code Data								
POWER ON	02H	00H	00H	00H	00H	02H			
POWER OFF	02H	01H	00H	00H	00H	03H			
INPUT SELECT COMPUTER	02H	03H	00H	00H	02H	01H	01H	09H	
INPUT SELECT VIDEO	02H	03H	00H	00H	02H	01H	06H	0EH	
INPUT SELECT S-VIDEO	02H	03H	00H	00H	02H	01H	0BH	13H	
PICTURE MUTE ON	02H	10H	00H	00H	00H	12H			
PICTURE MUTE OFF	02H	11H	00H	00H	00H	13H			
SOUND MUTE ON	02H	12H	00H	00H	00H	14H			
SOUND MUTE OFF	02H	13H	00H	00H	00H	15H			

*NOTE: Contact your local dealer for a full list of the PC Control Codes if needed.*

### Cable Connection

#### Communication Protocol

Baud rate .....	19200 bps
Data length .....	8 bits
Parity .....	No parity
Stop bit .....	One bit
X on/off .....	None
Communications procedure .....	Full duplex

*NOTE: Depending on the equipment, a lower baud rate may be recommended for long cable runs.*

**PC Control Connector (DIN-8P)**

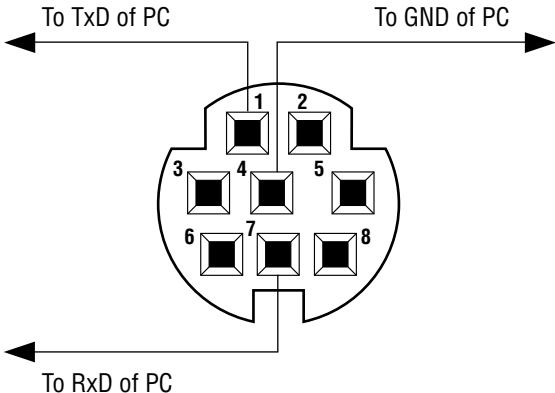

*NOTE: Pins 2, 3, 5, 6 and 8 are used inside the projector.*



**Discount-Merchant.com (800) 281-8860**  
**THE TRUSTED SOURCE FOR PROJECTOR LAMPS AND ACCESSORIES**

## 7 Troubleshooting Check List

Before contacting your dealer or service personnel, check the following list to be sure repairs are needed also by referring to the "Troubleshooting" section in your user's manual. This checklist below will help us solve your problem more efficiently.

\* Print this page and the next page for your check.

**Frequency of occurrence**  always  sometimes (How often? \_\_\_\_\_)  other (\_\_\_\_\_)

### Power

- |  |  |
|--|--|
| <ul style="list-style-type: none"> <li><input type="checkbox"/> No power (POWER indicator does not light green) See also "Status Indicator (STATUS)".           <ul style="list-style-type: none"> <li><input type="checkbox"/> Power cable's plug is fully inserted into the wall outlet.</li> <li><input type="checkbox"/> Main power switch is pressed to the ON position.</li> <li><input type="checkbox"/> Lamp cover is installed correctly .</li> <li><input type="checkbox"/> Lamp Hours Used (lamp operation hours) was cleared after lamp replacement.</li> <li><input type="checkbox"/> No power even though you press and hold the POWER button for 1 second.</li> </ul> </li> </ul> | <ul style="list-style-type: none"> <li><input type="checkbox"/> Shut down during operation.           <ul style="list-style-type: none"> <li><input type="checkbox"/> Power cable's plug is fully inserted into the wall outlet.</li> <li><input type="checkbox"/> Lamp cover is installed correctly .</li> <li><input type="checkbox"/> Power Management is turned off (only models with the Power Management function).</li> <li><input type="checkbox"/> Off Timer is turned off (only models with the Off Timer function ).</li> </ul> </li> </ul> |
|--|--|

### Video and Audio

- |   |  |
|---|--|
| <ul style="list-style-type: none"> <li><input type="checkbox"/> No image is displayed from your PC or video equipment to the projector.           <ul style="list-style-type: none"> <li><input type="checkbox"/> Still no image even though you connect the projector to the PC first, then start the PC.</li> <li><input type="checkbox"/> Enabling your notebook PC's signal output to the projector.               <ul style="list-style-type: none"> <li>• <i>A combination of function keys will enable/disable the external display. Usually, the combination of the "Fn" key along with one of the 12 function keys turns the external display on or off.</i></li> </ul> </li> <li><input type="checkbox"/> No image (blue or black background, no display).</li> <li><input type="checkbox"/> Still no image even though you press the AUTO ADJUST button.</li> <li><input type="checkbox"/> Still no image even though you carry out [Reset] in the projector's menu.</li> <li><input type="checkbox"/> Signal cable's plug is fully inserted into the input connector</li> <li><input type="checkbox"/> A message appears on the screen. ( _____ )</li> <li><input type="checkbox"/> The source connected to the projector is active and available.</li> <li><input type="checkbox"/> Still no image even though you adjust the brightness and/or the contrast.</li> <li><input type="checkbox"/> Input source's resolution and frequency are supported by the projector.</li> </ul> </li> <li><input type="checkbox"/> Image is too dark.           <ul style="list-style-type: none"> <li><input type="checkbox"/> Remains unchanged even though you adjust the brightness and/or the contrast.</li> </ul> </li> <li><input type="checkbox"/> Image is distorted.           <ul style="list-style-type: none"> <li><input type="checkbox"/> Image appears to be trapezoidal (unchanged even though you carry out the [Keystone] adjustment).</li> </ul> </li> <li><input type="checkbox"/> Remote control does not work.           <ul style="list-style-type: none"> <li><input type="checkbox"/> No obstacles between the sensor of the projector and the remote control.</li> <li><input type="checkbox"/> Projector is placed near a fluorescent light that can disturb the infrared remote controls.</li> <li><input type="checkbox"/> Batteries are new and are not reversed in installation.</li> </ul> </li> </ul> | <ul style="list-style-type: none"> <li><input type="checkbox"/> Parts of the image are lost.           <ul style="list-style-type: none"> <li><input type="checkbox"/> Still unchanged even though you press the AUTO ADJUST button.</li> <li><input type="checkbox"/> Still unchanged even though you carry out [Reset] in the projector's menu.</li> </ul> </li> <li><input type="checkbox"/> Image is shifted in the vertical or horizontal direction.           <ul style="list-style-type: none"> <li><input type="checkbox"/> Horizontal and vertical positions are correctly adjusted on a computer signal.</li> <li><input type="checkbox"/> Input source's resolution and frequency are supported by the projector.</li> <li><input type="checkbox"/> Some pixels are lost.</li> </ul> </li> <li><input type="checkbox"/> Image is flickering.           <ul style="list-style-type: none"> <li><input type="checkbox"/> Still unchanged even though you press the AUTO ADJUST button.</li> <li><input type="checkbox"/> Still unchanged even though you carry out [Reset] in the projector's menu.</li> <li><input type="checkbox"/> Image shows flickering or color drift on a computer signal.</li> </ul> </li> <li><input type="checkbox"/> Image appears blurry or out of focus.           <ul style="list-style-type: none"> <li><input type="checkbox"/> Still unchanged even though you checked the signal's resolution on PC and changed it to projector's native resolution.</li> <li><input type="checkbox"/> Still unchanged even though you adjusted the focus.</li> </ul> </li> <li><input type="checkbox"/> No sound.           <ul style="list-style-type: none"> <li><input type="checkbox"/> Audio cable is correctly connected to the audio input of the projector.</li> <li><input type="checkbox"/> Still unchanged even though you adjusted the volume level.</li> <li><input type="checkbox"/> AUDIO OUT is connected to your audio equipment (only models with the AUDIO OUT connector).</li> </ul> </li> <li><input type="checkbox"/> Buttons on the projector cabinet do not work ( only models with the Key Lock function).           <ul style="list-style-type: none"> <li><input type="checkbox"/> Control Panel Lock is not turned on or is disabled in the menu.</li> <li><input type="checkbox"/> Still unchanged even though you press and hold the EXIT button for a minimum of 10 seconds.</li> </ul> </li> </ul> |
|---|--|

In the space below please describe your problem in detail.

**Information on application and environment where your projector is used**

**Projector**  
 Model number:  
 Serial No.:  
 Date of purchase:  
 Lamp operating time (hours):  
 Lamp Mode:  Normal  Eco  
 Information on input signal:  
 Horizontal synch frequency [     ] kHz  
 Vertical synch frequency [     ] Hz  
 Synch polarity            H  (+)  (-)  
                                   V  (+)  (-)  
 Synch type                 Separate  Composite  
                                    Sync on Green  
 STATUS Indicator:  
 Steady light                 Orange  Green  
 Flashing light              [     ] cycles  
 Remote control model number:

**Installation environment**  
 Screen size:                      inch  
 Screen type:  White matte  Beads  Polarization  
                                    Wide angle  High contrast  
 Throw distance:                feet/inch/m  
 Orientation:  Ceiling mount  Desktop  
 Power outlet connection:  
 Connected directly to wall outlet  
 Connected to power cord extender or other (the number of connected equipment \_\_\_\_\_)  
 Connected to a power cord reel or other (the number of connected equipment \_\_\_\_\_)

**Computer**  
 Manufacturer:  
 Model number:  
 Notebook PC  / Desktop   
 Native resolution:  
 Refresh rate:  
 Video adapter:  
 Other:

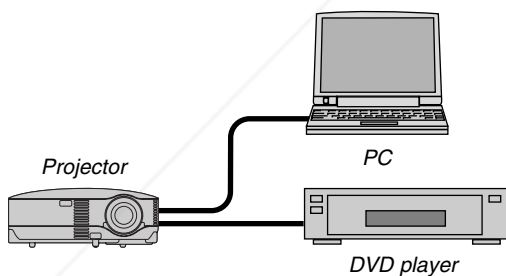

**Signal cable**  
 NEC standard or other manufacturer's cable?  
 Model number:                      Length:            inch/m  
 Distribution amplifier  
 Model number:  
 Switcher  
 Model number:  
 Adapter  
 Model number:

**Video equipment**  
 VCR, DVD player, Video camera, Video game or other  
 Manufacturer:  
 Model number:

Discount-Merchant.com (800) 281-8860  
 THE TRUSTED SOURCE FOR PROJECTOR LAMPS AND ACCESSORIES

## 8 TravelCare Guide

### TravelCare - a service for international travelers

This product is eligible for "TravelCare", NEC's unique international warranty.

Please note that TravelCare coverage differs in part from coverage under the warranty included with the product.

### Services offered with TravelCare

This warranty allows customers to receive service on their product at the NEC and NEC-designated service stations in the countries listed herein when temporarily traveling internationally for business or pleasure.

For details on services offered by the different service stations, please refer to the "List of TravelCare Outlets" below.

#### 1 Repair services

The product will be repaired and delivered within 10 business days, not including shipping time.

During the term of warranty, the cost of maintenance parts, labor costs for repairs and shipping costs within the service station's coverage area are covered by the warranty.

#### 2 Replacement product rental service

If the customer desires, he or she can rent a replacement product while the original product is being repaired.

Fee: US\$200 for 12 days

This fee must be paid at the local service station in cash or credit card.

The US\$200 rental fee is non-refundable even if the customer rents it less than 12 days before returning.

The replacement product will be delivered within 3 business days.

If the customer did not return the replacement product within 12 days, the customer will be charged the price of the unit.

If the customer returned the replacement product in a faulty or damaged condition, the repair cost will be charged to the customer.

Note that this service is not offered in all countries and regions. Please refer to the "List of TravelCare Outlets".

In addition, this replacement product rental service is not offered after the product's warranty has expired.

### Term of warranty

1

- a. Upon presentation of the warranty or receipt received upon purchase:

Valid for the term indicated on the warranty or the normal term of warranty for the country of purchase.

- b. When only the product is brought in:

Valid for a period of within 14 months of the date of manufacture indicated by the serial number attached to the product.

- 2 When a product whose term of warranty is expired is brought in:

Repairs will be offered for a fee. In this case the customer is not eligible for the replacement product rental service.

- 3 In the following cases, repairs may be charged, even if the product's warranty is still in effect:

- 1) **Fixed on warranty.** Model name, serial number and name of the store of purchase are not indicated on the warranty or have been altered.
- 2) Problems or damage caused by dropping or shocks during shipment or movement by the customer or by improper handling by the customers.
- 3) Problems or damage caused by improper usage or unwarrantable alterations or repairs by the customer.
- 4) Problems or damage caused by fire, salt damage, gas damage, earthquakes, lightning damage, storm or flood damage or other natural disasters or such external factors as dust, cigarette smoke, abnormal voltage, etc.

- 5) Problems or damage caused by use in hot or humid places, in vehicles, boats or ships, etc.
- 6) Problems or damage caused by expendable supplies or devices connected to the product other than those designated by NEC.
- 7) Problems caused by natural consumption, wear or deterioration of parts under normal usage conditions.
- 8) Problems or damage to lamps and other expendable supplies, included parts or optional parts.
- 9) Other conditions stipulated in the warranty included with the product also apply.

*NOTE: The product can be used overseas with voltages indicated in the rating label on the product by using a power cable suited for the standards and power source voltage of the country in which the product is being used.*

### List of TravelCare Outlets

This list applies as of July 1, 2006.

For the most up-to-date information, please refer to the websites of the service stations in the various countries on the List of TravelCare Outlets or to the NEC website at <http://www.nec-pj.com>.

#### In Europe

NEC Europe, Ltd. / European Technical Centre

Address: Unit G, Stafford Park 12, Telford TF3 3BJ, U.K.  
 Telephone: +44 1952 237000  
 Fax Line: +44 1952 237006  
 Email Address: AFR@uk.necur.com  
 WEB Address: <http://www.necur.com>

(Regions Covered)

EU: Austria\*, Belgium\*, Denmark\*, Finland\*, France\*, Germany\*, Greece\*, Ireland\*, Italy\*, Luxembourg\*, The Netherlands\*, Portugal\*, Spain\*, Sweden\* and the United Kingdom\*  
 EEA: Norway\*, Iceland and Liechtenstein

#### In North America

NEC Corporation of America

Address: 1250 N. Arlington Heights Road, Itasca, Illinois 60143, U.S.A.  
 Telephone: +1 800 836 0655  
 Fax Line: +1 800 356 2415  
 Email Address: vsd.tech-support@necsam.com  
 WEB Address: <http://www.necvisualsystems.com>

(Regions Covered)

U.S.A. \*, Canada\*

#### In Oceania

NEC Australia Pty., Ltd.

Address:

New South Wales;  
 184 Milperra Road, Reversby NSW 2212  
 Telephone: +61 2 9780 8688 Fax Line: +61 2 9780 8659

Victoria;  
 Unit 1/6 Garden Road, Clayton VIC 3168  
 Telephone: +61 3 8562 6245 Fax Line: +61 3 8562 6220

Newcastle;  
 120 Parry Street Newcastle West NSW 2300  
 Telephone: +61 2 4926 2466

Queensland;  
 Unit 4/305 Montague Road West End QLD 4101  
 Telephone: +61 7 3840 5858 Fax Line: +61 7 3840 5866

Goldcoast QLD;  
 Shop1 48 Ferry Road Southport QLD 4215  
 Telephone: +61 7 5591 3670

South Australia;  
 84A Richmond Road, Keswick 5035  
 Telephone: +61 8 8375 5707 Fax Line: +61 8 8375 5757

Western Australia;  
 45 Sarich Court Osborne Park WA 6017  
 Telephone: +61 8 9445 5901 Fax Line: +61 8 9445 5999

WEB Address: <http://www.nec.com.au>

(Regions Covered)  
Australia\*, New Zealand

**In Asia and Middle East**

NEC Viewtechnology, Ltd.

Address: 686-1, Nishioi, Oi-Machi, Ashigarakami-Gun,  
Kanagawa 258-0017, Japan

Telephone: +81 465 85 2369  
Fax Line: +81 465 85 2393  
Email Address: support\_pjweb@nevt.nec.co.jp  
WEB Address: <http://www.nec-pj.com>

(Regions Covered)  
Japan\*

NEC Hong Kong Ltd.

Address: 25/F., The Metropolis Tower, 10 Metropolis Drive,  
Hung Hom, Kowloon, Hong Kong

Telephone: +852 2369 0335  
Fax Line: +852 2795 6618  
Email Address: nechksc@nechk.nec.com.hk  
esmond\_au@nechk.nec.com.hk  
WEB Address: <http://www.nec.com.hk>

(Regions Covered)  
Hong Kong

NEC Taiwan Ltd.

Address: 7F, No.167, SEC.2, Nan King East Road, Taipei,  
Taiwan, R.O.C.

Telephone: +886 2 8500 1714  
Fax Line: +886 2 8500 1420  
Email Address: chenguanfu@nec.com.tw  
WEB Address: <http://www.nec.com.tw>

(Regions Covered)  
Taiwan

NEC Solutions Asia Pacific Pte. Ltd

Address: 401 Commonwealth Drive, #07-02, Haw Par  
Technocentre, Singapore 149598

Telephone: +65 6 273 8333  
Fax Line: +65 6 274 2226  
Email Address: tehgh@rsc.ap.nec.com.sg  
WEB Address: <http://www.nec.com.sg/ap>

(Regions Covered)  
Singapore

NEC Systems Integration Malaysia Sdn Bhd

Address: Ground Floor, Menara TA One, 22, Jalan P.  
Ramlee, 50250 Kuala Lumpur, Malaysia

Telephone: +6 03 2178 3600 (ISDN)  
Fax Line: +6 03 2178 3789  
Email Address: necare@nsm.nec.co.jp  
WEB Address: <http://www.necarecenter.com>

(Regions Covered)  
Malaysia

Tele Service Co., Ltd.

Address: 2nd Fl., Ire B/D. #2, 4Ga, Yangpyeng-Dong,  
Youngdeungpo-Gu, Seoul, Korea 150-967

Telephone: +82 2 2163 4193  
Fax Line: +82 2 2163 4196  
Email Address: moneybear@hyosung.com

(Regions Covered)  
South Korea

Lenso Communication Co., Ltd.

Address: 292 Lenso House 4, 1st Floor, Srinakarin Road,  
Huamark, Bangkok, Bangkok 10240, Thailand

Telephone: +66 2 375 2425  
Fax Line: +66 2 375 2434  
Email Address: pattara@lenso.com  
WEB Address: <http://www.lenso.com>

(Regions Covered)  
Thailand

ABBA Electronics L.L.C.

Address: Tariq Bin Ziyad Road, P.O.Box 327, Dubai, United  
Arab Emirates

Telephone: +971 4 371800  
Fax Line: +971 4 364283  
Email Address: ABBA@emirates.net.ae

(Regions Covered)  
United Arab Emirates

Samir Photographic Supplies

Address: P.O.Box 599, Jeddah 21421, Saudi Arabia  
Telephone: +966 2 6828219  
Fax Line: +966 2 6830820  
Email Address: asif@samir-photo.com

Riyadh

Address: P.O.Box 5519, Riyadh 11432, Saudi Arabia  
Telephone: +966 1 4645064  
Fax Line: +966 1 4657912  
Email Address: bhimji@samir-photo.com

Alkhubar

Address: P.O.Box 238, Alkhubar 31952, Saudi Arabia  
Telephone: +966 3 8942674  
Fax Line: +966 3 8948162  
Email Address: chamsedin@samir-photo.com

(Regions Covered)  
Saudi Arabia

*NOTE: In countries designated with an asterisk(\*), replacement product rental service are offered.*



**Discount-Merchant.com (800) 281-8860**  
**THE TRUSTED SOURCE FOR PROJECTOR LAMPS AND ACCESSORIES**

Date: / / ,

P-1/ ,

**TO: NEC or NEC's Authorized Service Station:**

**FM:**

\_\_\_\_\_  
 (Company & Name with signature)

Dear Sir (s),

I would like to apply your TravelCare Service Program based on attached registration and qualification sheet and agree with your following conditions, and also the Service fee will be charged to my credit card account, if I don't return the Loan units within the specified period. I also confirm following information is correct. Regards.

***Application Sheet for TravelCare Service Program***

Country, product purchased :	
User's Company Name :	
User's Company Address : Phone No., Fax No. :	
User's Name :	
User's Address :	
Phone No., Fax No. :	
Local Contact office :	
Local Contact office Address :	
Phone No., Fax No. :	
User's Model Name :	
Date of Purchase :	
Serial No. on cabinet :	
Problem of units per User :	
Required Service :	(1) Repair and Return (2) Loan unit
Requested period of Loan unit :	
Payment method :	(1) Credit Card (2) Travelers Cheque (3) Cash
In Case of Credit Card : Card No. w/Valid Date :	

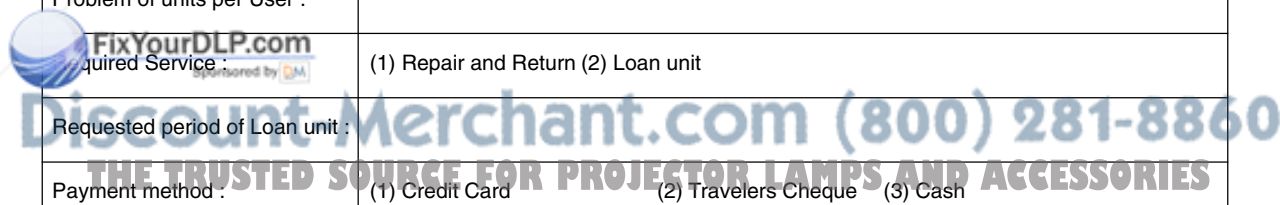

### Condition of your TravelCare Service Program

Enduser is requested to understand following condition of TravelCare Service Program and complete the necessary information on the application sheet.

#### 1. Service Options:

There are 3 types of [Service] available. Enduser has to understand following condition and is required to fill in the Application Sheet.

##### 1) Repair and Return:

The 'Faulty unit' is sent or collected from the customer. It is repaired and returned within 10 days to the customer, excluding transport time.

There may have a case, repair and return can't be done by NEC Authorized Service Station, because of shortage of spare parts due to same model is not sold in the territory.

##### 2) Repair and Return with Loan: (This service is limited to some Service Stations)

This service is offered to the Enduser, who cannot wait until their unit is repaired.

The customer can borrow a unit for US\$200 up to 12 days. Customer then sends in inoperable unit to nearest NEC Authorized Service Station for service. In order to prevent collection problem, Enduser is required to fill in Application Sheet.

Enduser needs to confirm the availability of the Service to NEC Authorized Service Stations.

##### 3) Loan Only:

For this service, NEC Authorized Service Station supplies the customer with a loan unit for US\$200 up to 12 days. Customer keeps the inoperable unit and when customer returns home, customer arranges to have the projector serviced in the home country.

#### 2. Warranty Exclusions:

This program does not apply if the Projector's serial number has been defaced, modified or removed.

If, in the judgement of NEC Authorized Service Station or its agent the defects or failures result from any cause other than fair wear and tear or NEC neglect, or fault including the following without limitation:

- 1) Accidents, transportation, neglect, misuse, abuse, water, dust, smoke or default of or by the Customer its employees or agents or any third party;
- 2) Failure or fluctuation of electrical power, electrical circuitry, air conditioning, humidity control or other environmental conditions such as use it in smoking area;
- 3) Any fault in the attachments or associated products or components (whether or not supplied by NEC or its agents which do not form part of the Product covered by this warranty);
- 4) Any act of God, fire, flood, war, act of violence or any similar occurrence;
- 5) Any attempt by any person other than any person authorized by NEC to adjust, modify, repair, install or service the product.
- 6) Any Cross-border charges such as, duty, insurance, tax etc.

#### Charges for Warranty Exclusions and Out of Warranty Case:

If a faulty unit is under warranty exclusions case or under Out of warranty period, NEC Authorized Service Station will inform estimation of actual service cost to the Enduser with reason.

#### 4. Dead on Arrival (DOA):

Enduser must take this issue up with their original supplier in the country of purchase.

NEC Authorized Service Station will repair the DOA unit as a Warranty repair, but will not exchange DOA unit with new units.

#### 5. Loan Service Charges and Conditions:

Upon acceptance of this NEC Projector, Customer agrees to assume liability for this loan unit.

The current cost of use of this loan unit is US\$200 for 12 calendar days. If Customer does not return the unit within the 12 calendar days, Customer will be charged the next highest cost up to and including the full list price to Credit Cards, which price will be informed by NEC Authorized Service Stations. Please see the attached listing of contacts for each country to arrange for pickup of the loan unit.

If you return to their country of origin with the loan unit, you will be charged additional freight to return the unit to the loaning country.

Thank you for your understanding of this program.





# Disclaimer

This user manual is provided as a free service by FixYourDLP.com. FixYourDLP is in no way responsible for the content of this manual, nor do we guarantee its accuracy. FixYourDLP does not make any claim of copyright and all copyrights remain the property of their respective owners.

About FixYourDLP.com

FixYourDLP.com (<http://www.fixyourdpl.com>) is the World's #1 resource for media product news, reviews, do-it-yourself guides, and manuals.

Informational Blog: <http://www.fixyourdpl.com>

Video Guides: <http://www.fixyourdpl.com/guides>

User Forums: <http://www.fixyourdpl.com/forum>

FixYourDLP's Fight Against Counterfeit Lamps:

<http://www.fixyourdpl.com/counterfeits>

## Sponsors:

RecycleYourLamp.org – Free lamp recycling services for used lamps:

<http://www.recycleyourlamp.org>

Lamp Research - The trusted 3rd party lamp research company:

<http://www.lampresearch.com>

Discount-Merchant.com – The worlds largest lamp distributor:

<http://www.discount-merchant.com>



**FixYourDLP.com**

Sponsored by 