



# Disclaimer

This user manual is provided as a free service by FixYourDLP.com. FixYourDLP is in no way responsible for the content of this manual, nor do we guarantee its accuracy. FixYourDLP does not make any claim of copyright and all copyrights remain the property of their respective owners.

About FixYourDLP.com

FixYourDLP.com (<http://www.fixyourdpl.com>) is the World's #1 resource for media product news, reviews, do-it-yourself guides, and manuals.

Informational Blog: <http://www.fixyourdpl.com>

Video Guides: <http://www.fixyourdpl.com/guides>

User Forums: <http://www.fixyourdpl.com/forum>

FixYourDLP's Fight Against Counterfeit Lamps:

<http://www.fixyourdpl.com/counterfeits>

## Sponsors:

RecycleYourLamp.org – Free lamp recycling services for used lamps:

<http://www.recycleyourlamp.org>

Lamp Research - The trusted 3rd party lamp research company:

<http://www.lampresearch.com>

Discount-Merchant.com – The worlds largest lamp distributor:

<http://www.discount-merchant.com>



**FixYourDLP.com**

Sponsored by 



## ULTRA PORTABLE PROJECTOR

# VP150X

### USER'S GUIDE

Thank you for purchasing Benq Ultra Portable Projector.

Please read this user's guide to ensure correct use of the device. Save this user's guide for future reference.

### OUTLINE

---

This Ultra Portable Projector can display various computer signals and NTSC/PAL/SECAM video signals.



### FEATURES

---

- 1. High Brightness**
- 2. High Resolution**
- 3. Easy to Set Up**
- 4. Compact Size, Light Weight for Portability**
- 5. RGB Output Terminal**
- 6. Mouse Emulation**
- 7. Auto-Adjustment Function (i - key)**
- 8. USB Communication**



FixYourDLP.com

Discount-Merchant.com (800) 281-8860

THE TRUSTED SOURCE FOR PROJECTOR LAMPS AND ACCESSORIES

## Copyright

---

Copyright © 2002 by Benq Corporation, formerly Acer Communications & Multimedia Inc.. All rights reserved. No part of this publication may be reproduced, transmitted, transcribed, stored in a retrieval system or translated into any language or computer language, in any form or by any means, electronic, mechanical, magnetic, optical, chemical, manual or otherwise, without the prior written permission of Benq Corporation.

## Disclaimer

---

Benq Corporation makes no representations or warranties, either expressed or implied, with respect to the contents hereof and specifically disclaims any warranties, merchantability or fitness for any particular purpose. Furthermore, Benq Corporation reserves the right to revise this publication and to make changes from time to time in the contents hereof without obligation of Benq Corporation to notify any person of such revision or changes.

## Warning

---

This equipment has been tested and found to comply with the limits for a Class A digital device, pursuant to part 15 of the FCC Rules. These limits are designed to provide reasonable protection against harmful interferences when the equipment is operated in a commercial environment. This equipment will generate and radiate radio frequency energy, if not installed and used in accordance with the instruction manual, may cause harmful interference to radio communications. Operation of this equipment in a residential area is likely to cause harmful interference in which case the user will be required to correct the interference at his own expense.

Fill this in!!	
For future service convenience, record the following information in the space below. The serial number is on the back of the product.	
<b>Projector Information</b>	
Product Name:	VP150X
Serial Number:	
Date of Purchase:	
<b>Dealer Information</b>	
Dealer:	
Telephone	
Number:	
Address:	

 FixYourDLP.com  
Sponsored by  DM

**Discount-Merchant.com (800) 281-8860**  
**THE TRUSTED SOURCE FOR PROJECTOR LAMPS AND ACCESSORIES**

## Safety Instructions

---

1. Read this user's guide before you operate your projector and save it for future reference.
2. When the lamp becomes extremely hot during operation, allow the projector to cool for approximately 45 minutes prior to removing the lamp assembly for replacement. Do not operate lamps beyond the rated lamp life. Excessive operation of lamps beyond rated life could cause them to explode in rare occasions.
3. Power is still available when the projector is in the standby mode. Never replace lamp assembly or any electronic components unless the projector is unplugged.
4. Do not attempt to service this product yourself, as opening or removing covers may damage the components inside and will void your warranty.
5. Do not place this product on an unstable cart, stand, or table. The product may fall, causing serious damage to the product.
6. The standard remote control contains a low-power laser that acts as a pointing device during presentations. The light beam may cause injury if pointed directly into a person's eyes.
7. This product is capable of displaying inverted images for ceiling mount configurations. Please use suitable equipment for mounting the unit and make sure it is securely installed.
8. Openings in front or at two sides are for ventilation. They must not be blocked or covered.
9. For ventilation reasons, fans continue to operate for about 1 minute after the projector is powered off. Please do not unplug the power cord until the fans stop.
10. Do not look straight at the projector lens during operation. The intense light beam may injure your eyes.



**Discount-Merchant.com (800) 281-8860**  
**THE TRUSTED SOURCE FOR PROJECTOR LAMPS AND ACCESSORIES**

# TABLE OF CONTENTS

---

<b>INTRODUCTION .....</b>	<b>1</b>
Projector Features.....	1
Description.....	2
A FRONT .....	2
B RIGHT .....	2
C BOTTOM .....	2
Installation.....	3
A IMAGE SIZE ADJUSTMENT .....	3
B ADJUSTABLE FEET .....	3
Moving the Projector .....	4
Accessories .....	5
<b>CONNECTION .....</b>	<b>6</b>
Connect the Projector to Computer .....	6
Connect the Projector to Notebook .....	6
Connect the Projector to Macintosh.....	7
Connect the Projector to Power Book .....	7
Connect to Video/ S-Video .....	7
<b>OPERATION .....</b>	<b>8</b>
Turn On/Off Procedure.....	8
A POWER ON .....	8
B STANDBY .....	8
External Control.....	8
A CONTROL PAD .....	8
B REMOTE CONTROL .....	9
Usage and Replacement of Lamp .....	11
A LAMP/TEMPERATURE STATUS LED INDICATOR .....	11
B LAMP REPLACEMENT 12	
OSD.....	14
Main OSD Menu.....	14
A DISPLAY PAGE.....	14
B IMAGE PAGE.....	15
C CONTROL PAGE.....	16
D SOURCE PAGE.....	16
Other Correspondent and Remote Functions Messages.....	17
<b>MAINTENANCE AND TROUBLESHOOTING .....</b>	<b>18</b>
A LAMP REPLACEMENT .....	18
B CLEANING THE LENS .....	18
C TROUBLESHOOTING .....	18
<b>SPECIFICATIONS .....</b>	<b>19</b>
A OPTICAL.....	19
B ELECTRICAL.....	19
C MECHANICAL.....	19
D PRESET DISPLAY RESOLUTION TABLE.....	19

## Projector Features

### A. Image Resolution

By using advanced intelligent compression technology, it is fully compatible with true XGA, and supports SXGA . The advanced intelligent compression technology enables the projector to present clear compression XGA images without line omission.

### B. Brightness

Provides superior brightness for the 0.9" *Liquid Crystal Panel* and our own optical design, with a geometric effect that increases light usage efficiency. By increasing the light usage efficiency we can better reproduce the three basic colors (RGB) required for color reproduction on LCD Panel.

### C. Portability

This projector has a sophisticated shape, like that of an attaché case, with a retractable carrying handle that is extremely compact and lightweight. It helps you make powerful presentations wherever you go with its 8-pound weight and A4 size.

### D. Keystone

The projection position is already set to the height of the line of vision; there is no keystone effect. Even when projecting above or under the height of the line of vision, image distortion (if any) can be adjusted using the keystone correction function.

### E. Multilanguage

The OSD (On Screen Display: information screens and menus) in 7 languages (English, Deutsch, Français, Italiano, Español, Dutch and Simplified Chinese) provides you with additional information to assist you making corrections with OSD operation in your native languages.

### F. Auto Detect System

This projector can detect display signals from PCs with frequently used timing and do the optimization simultaneously. It does not require complicated adjustments in order to project picture images from PCs.

### G. Ceiling Mount and Rear Screen Projection

The projector is equipped with a full mirror scan conversion function (vertical/horizontal mirror), which allows the image to be reversed for ceiling mounting as well as for rear projection applications.

### H. Auto adjustment (I-key)

The projector will automatically adjust five items (V. Position, H. Position, H. Phase, V. Phase, White Level), when I-key is selected.

# Description

## A FRONT

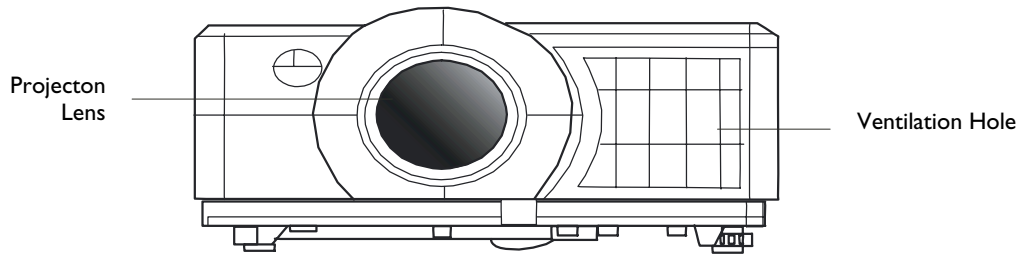

Figure 1. Front view

## B RIGHT

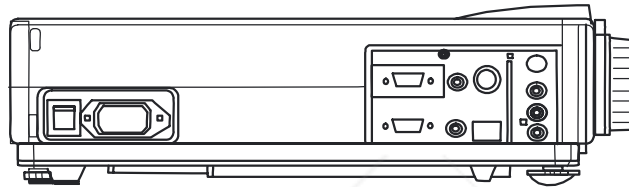

Figure 2. Right view

## C BOTTOM

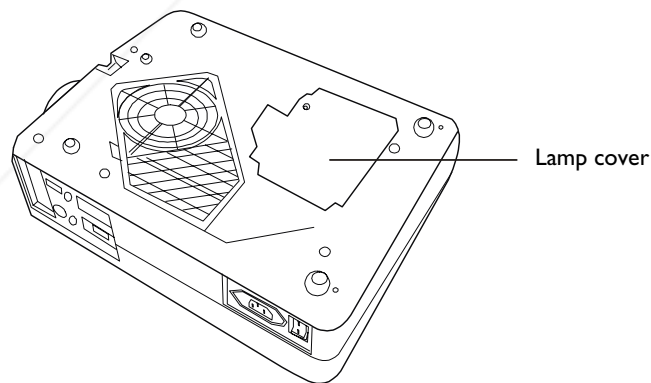

Figure 3. Bottom view

# Installation

## A Image Size Adjustment

- This projector is basically designed to project on a flat projection surface.
- This projector can be focused from 1m–12.3m.
- Refer to Figure. 4 to adjust the screen size.

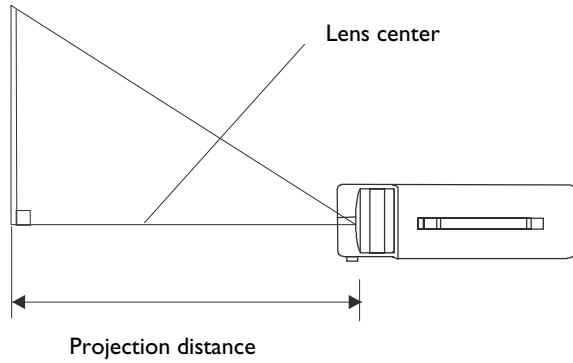

Figure 4. Positioning

Projection distance	Screen size	
	Wide	Telephoto
m	Inch	Inch
1.64	40	30.76
2.06	50	38.46
2.46	60	46.15
2.9	70	53.84
4.6	100	76.92
6.26	150	115.38
8.35	200	153.84
12.55	300	230.76

## B Adjustable Feet

Picture tilt and projection angle can be adjusted by twisting the adjustable feet. Projection angle can be adjusted from 0 to 9 degrees by rotating the feet. .

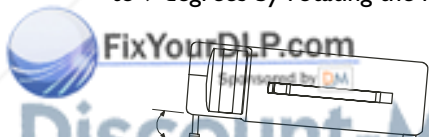

Figure 5. Adjustable feet

FixYourDLP.com  
 Discount-Merchant.com (800) 281-8860  
 THE TRUSTED SOURCE FOR PROJECTOR LAMPS AND ACCESSORIES



## Moving the Projector

Use the carrying handle when moving the projector.

Replace the lens cover and rotate the feet fully clockwise (to shorten the feet) when moving the projector to prevent damage it.

 **Caution**

*The carrying bag is supplied to protect the projector from dust and scratches on the surface of the cabinet. It is not designed to protect the projector from external shock.*

*Do not transport the projector in an unsuitable transport case by using a courier or transport service. This may cause damage to the projector.*



Figure 6. Moving the projector

# Accessories

Please check and ensure your box contains everything listed below. Contact your dealer, if any pieces are missing.

Please save the original box and packing materials in case you ever need to ship the unit.

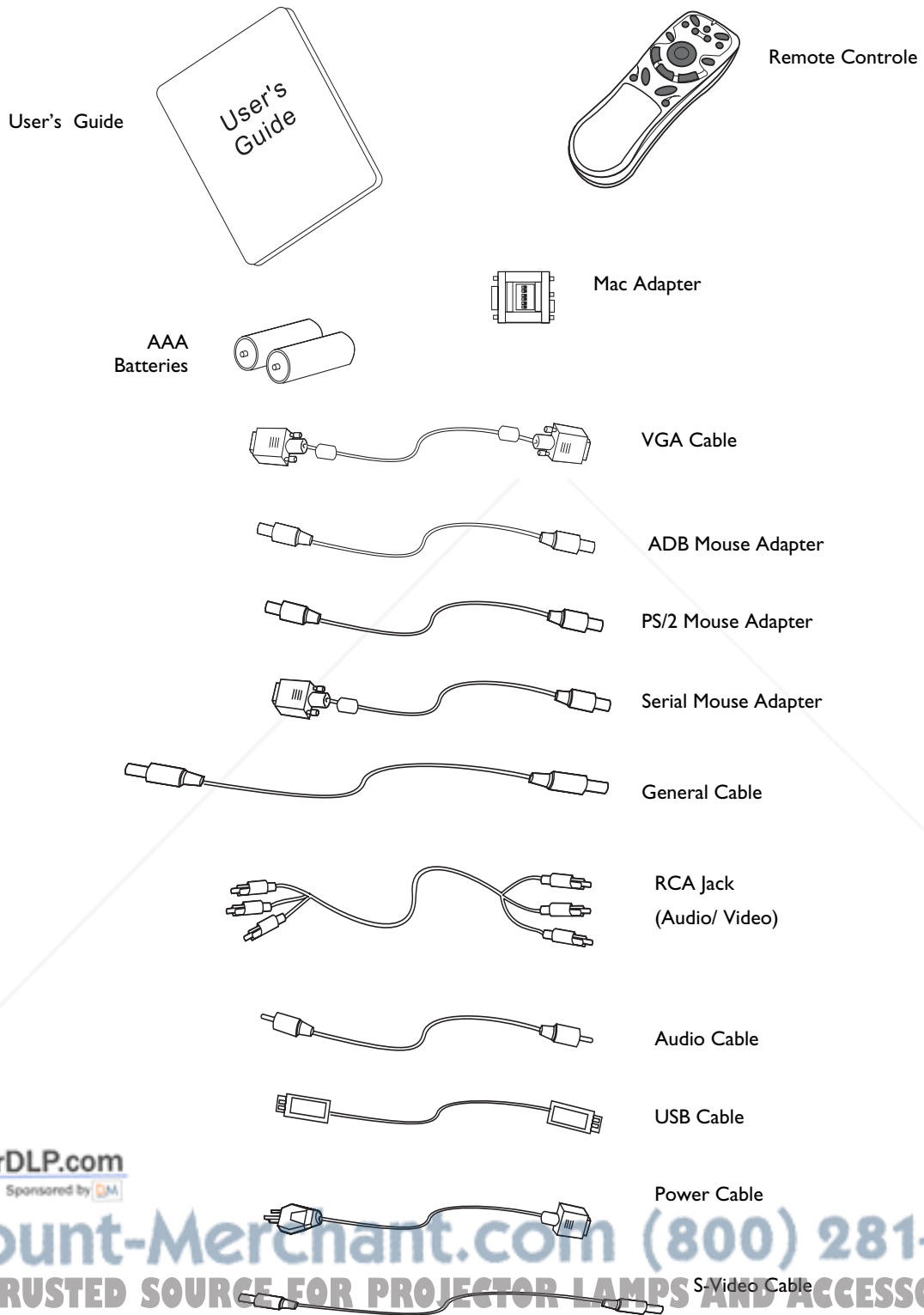

Figure 7. Accessories

## Connect the Projector to Computer

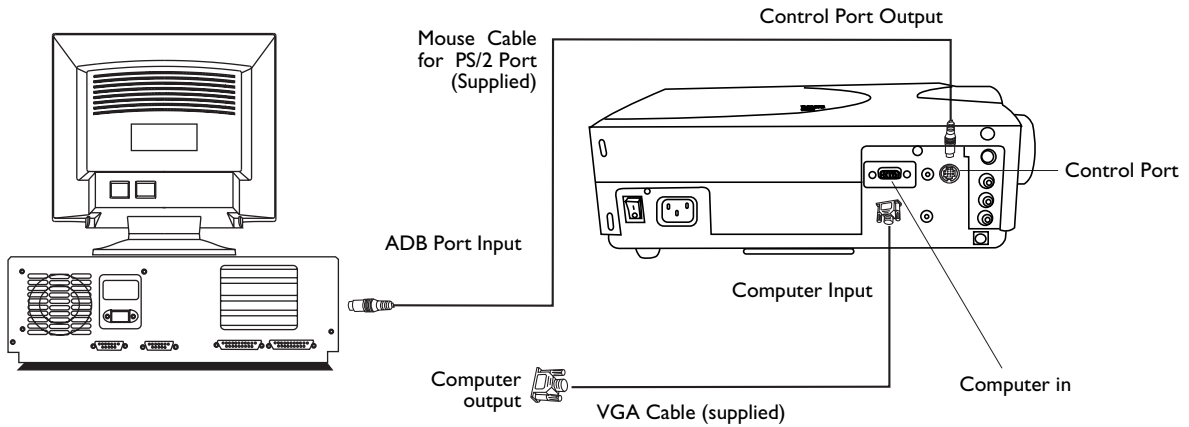

Figure 8. Connect to PC

## Connect the Projector to Notebook

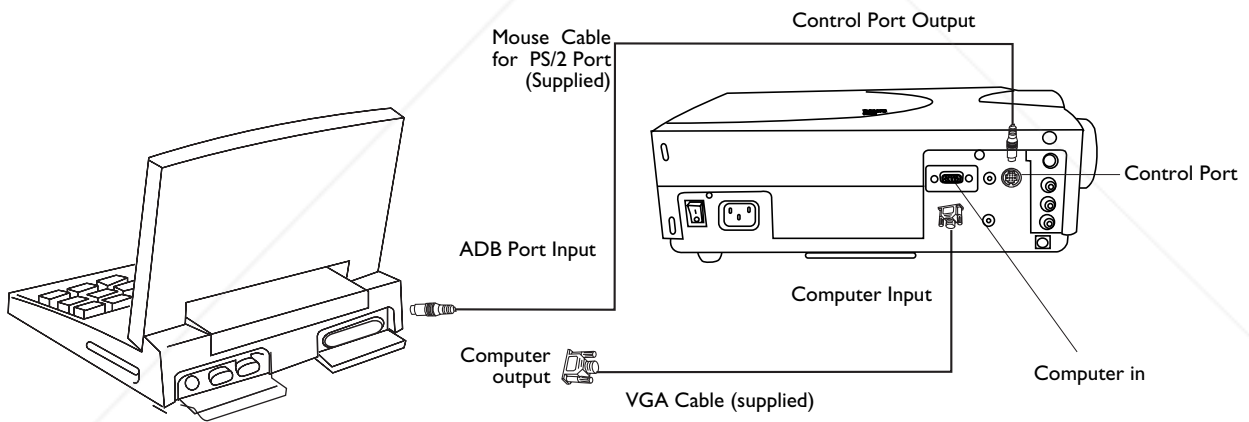

Figure 9. Connect to notebook

FixYourDEF.com  
Sponsored by DM

**Discount-Merchant.com (800) 281-8860**  
**THE TRUSTED SOURCE FOR PROJECTOR LAMPS AND ACCESSORIES**

## Connect the Projector to Macintosh

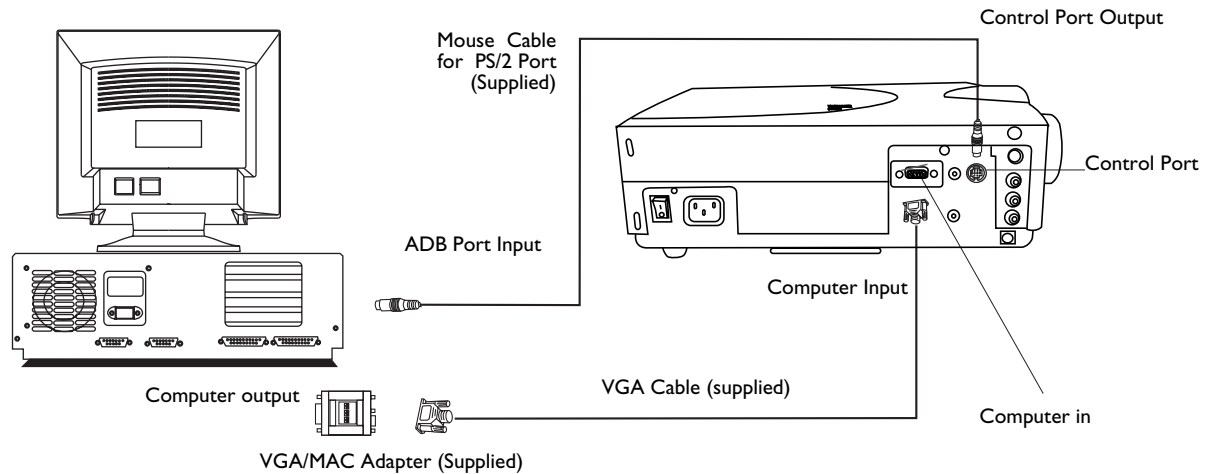

Figure 10. Connect to Macintosh

## Connect the Projector to Power Book

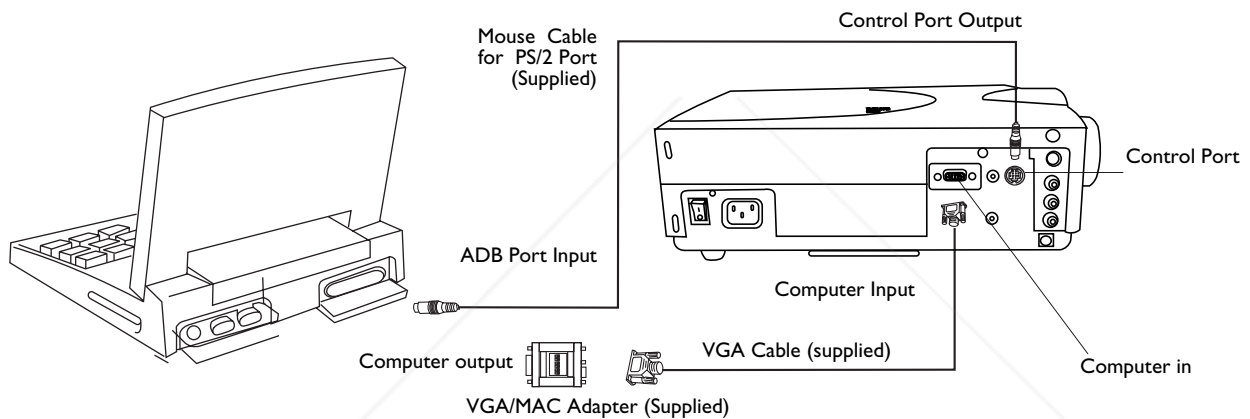

Figure 11. Connect to Power Book

## Connect to Video/ S-Video

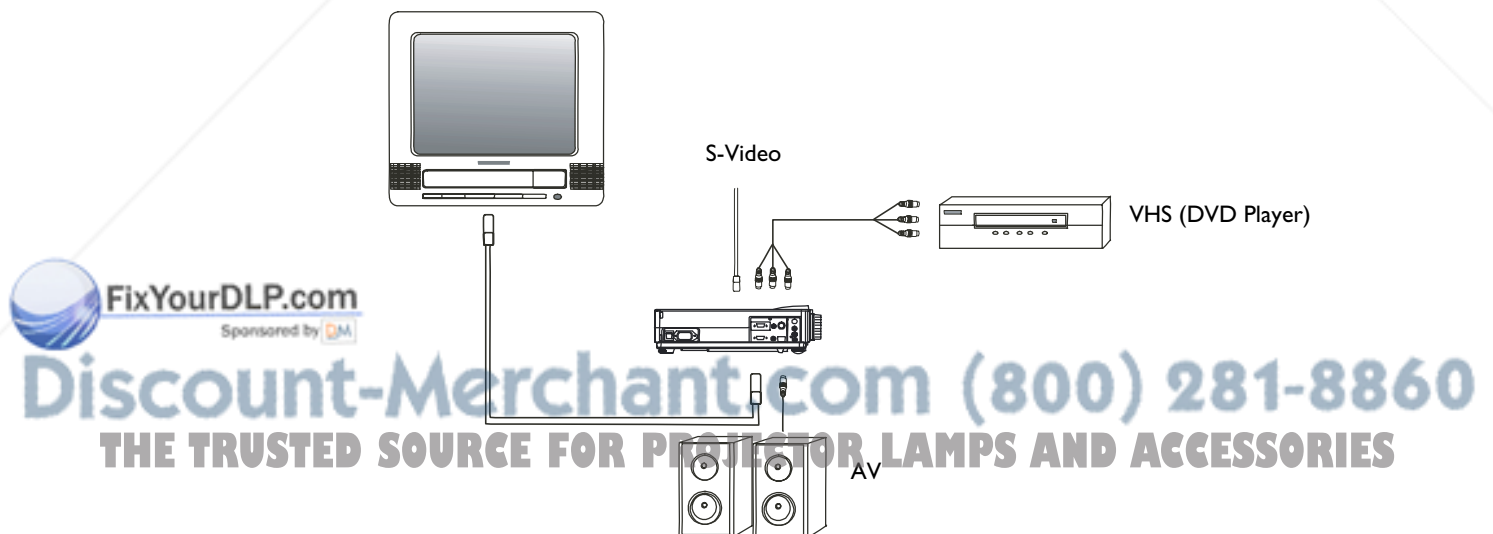

Figure 12. Connect to Video, S-Video

## Turn On/Off Procedure

### A Power on

Press the Standby/On key to turn on the lamp. The LED will blink green during warm up and then light solid green.

- "INPUT SIGNAL DETECTED, ACTIVATING AUTO IMAGE" will be displayed on the screen after the projector identifies the input signal.
- "SEARCHING" message will be displayed on the screen if there is no signal input.
- "SYNC IS OUT OF RANGE" message will be displayed on the screen if the horizontal frequency of the input signal exceeds the range of the projector.

### B Standby

Press the Standby/On key for more than one second to turn off the lamp. The LED will then blink orange and the lamp will shut down, but the fans will continue to run for about 1 minutes to cool the lamp. After the fans stop, the LED will turn to a solid orange light.

*\*Lamp Protection Procedure: If you try to turn on the lamp again while the LED is blinking, the projector will ignore the command until it is cooled down for one minute.*

## External Control

### A Control Pad

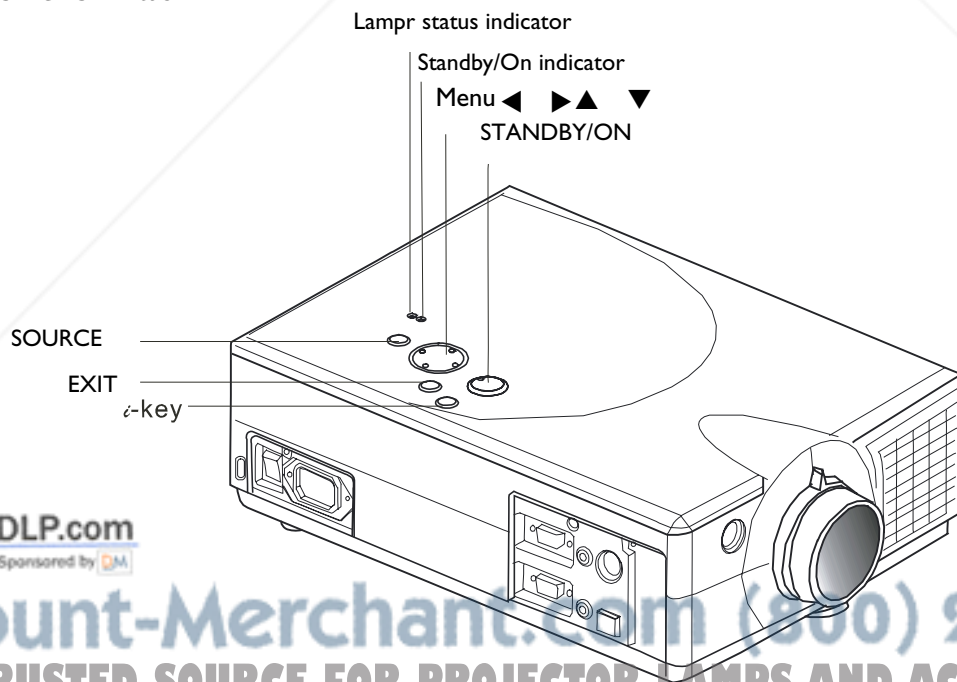



Figure 13. External control pad

MAIN UNIT	FUNCTION
Menu 	To call the OSD menu. To enter sub pages. To select items. To navigate through sub pages or to increase/decrease the scale bar number.
Exit	To exit from the current page or OSD menu, and save setting changes. To show lamp hour messages.
i-key	To adjust position, phase automatically.
Source	To select the input source.
Standby/On	To turn the projection lamp or and off.
Standby/On indicator	Functions as an indicator showing the standby status.
Lamp status indicator	Lights or blinks when the lamp does not light.

## B Remote Control

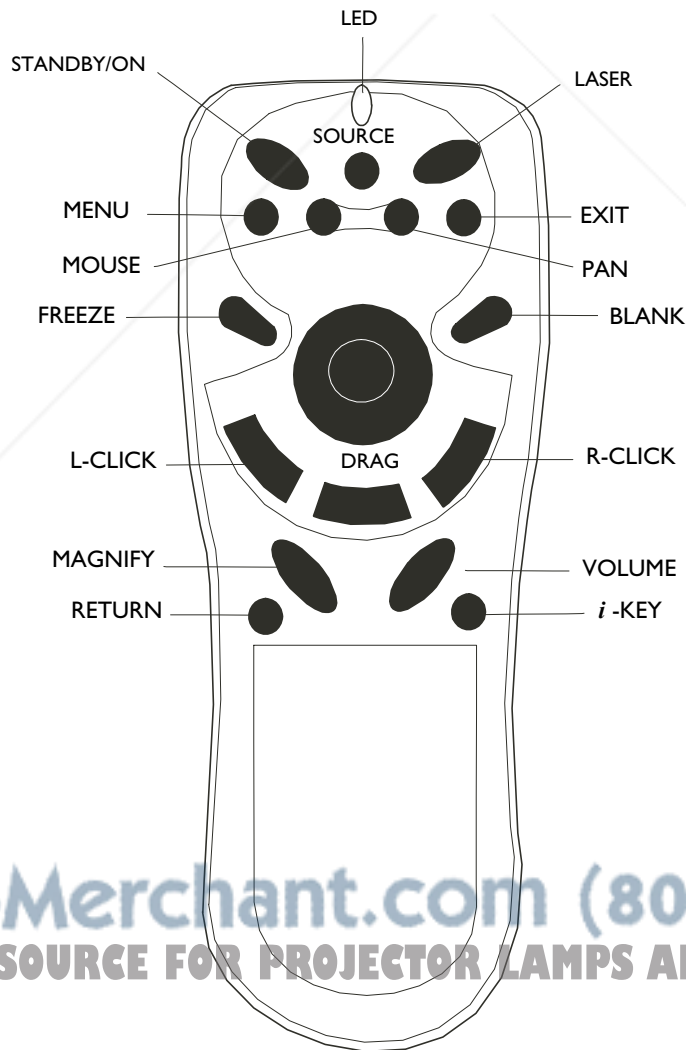

Figure 14. Remote control

The remote control allows you to operate the function keys on the projector and to emulate mouse function when the projector is connected to a computer.

Main Unit	Function
Standby/On	To turn the projection lamp on and off.
Freeze	Pressing this button displays a still (frozen) picture.
Magnify	Pressing this button partially magnifies a displayed picture. (Move the picture with the Disk Pad after pressing the Magnify button.)
Disk Pad	When the OSD menu is active, Disk Pad acts as ▲▼◀ ▶ selecting device. When the on-screen menus are not active, it works as mouse pad. When the magnify function is active, use disk pad to move through the picture.
Menu	Call the OSD Menu.
Blank	The blank screen is displayed by pressing Blank. And the blank screen will be revealed partially from top to bottom by pressing Blank again.
Source	Selects the input source.
Return	Image ration backs to 1:1.
Volume	Adjusts volume. The sound gets louder or quieter by pressing the "+" or "-" button.
Laser	Laser pointer on button. Use as a stick (for indication).
Mouse Left-Click	When operating in mouse emulation mode, it registers a left mouse click.
Mouse Right-Click	When operating in mouse emulation mode, it registers a right mouse click.
Exit	To leave current OSD Pages.
i-key	To adjust position, phase automatically.

### Inserting Batteries in the Remote Control

Be sure to follow instructions in placing batteries into the remote control units.

- Push and slide the lid in the direction of the arrow.
- Install two 'AAA' batteries as indicated inside the battery compartment.
- Replace the lid and snap into place.



#### Caution

- Avoid excessive heat and humidity.
- Do not mix new and old or different types of batteries.

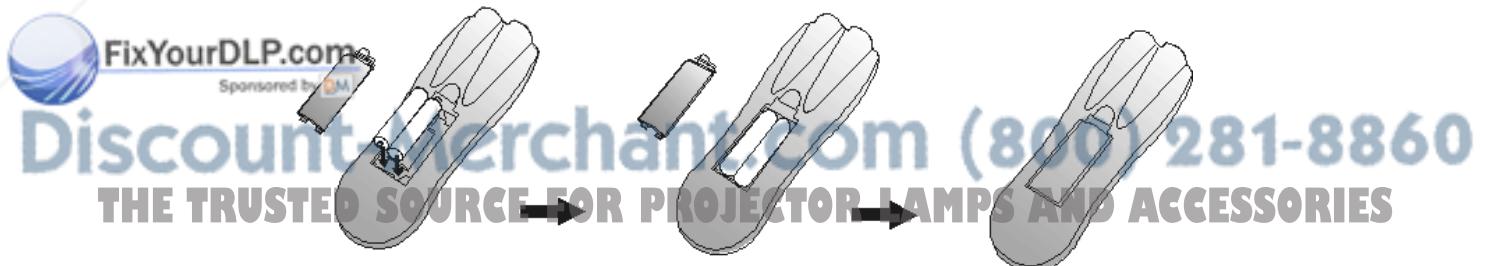

Figure 15. Battery replacement process

## Remote Control Range

The remote sensors are located on the back of the unit. It can function in a range 50 degrees horizontal and 30 degrees vertical relative to a line that is a right angle to the remote sensor. The distance between the remote control and remote sensor must be shorter than four meters (13 feet).

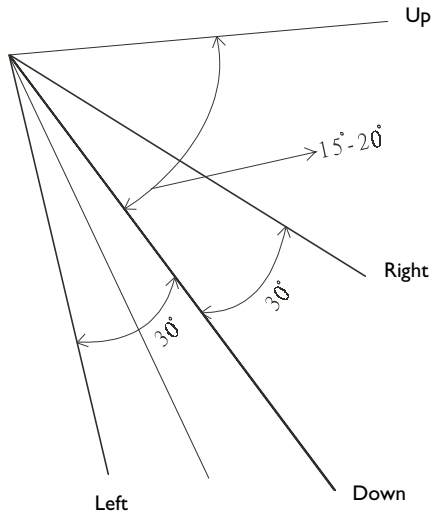

Figure 16. Range

## Usage and Replacement of Lamp

The light source lamp has a limited service life.

The picture will become dark or the color will fade after the lamp has been used for a long time. In such cases, continued use of the lamp could cause a malfunction. Replace the lamp with a new one.

### A Lamp/Temperature Status LED Indicator

#### I. Excessive lamp service hours

When the LED light is a continuous red, it means the lamp exceeds 2000 service hours. After this light appears, it is advisable to replace the projection lamp as soon as possible.

	<p>"CHANGE THE LAMP, AND RESET THE LAMP TIMER" will be displayed on the screen if the lamp is operated for 1950 hours.</p>
	<p>"CHANGE THE LAMP, THE POWER WILL TURN OFF AFTER 20 HOURS" will be displayed on the screen if the lamp is operated for 1979 hours. The "20" hours will count down.</p>
	<p>"CHANGE THE LAMP!" will blink on the screen together with a red LED if the lamp is operated for more than 2000 hours. The power will turn off automatically after 10 minutes. All the three messages will not display for more than 3 minutes, but each message will be displayed whenever you turn on the lamp.</p>



## 2. Lamp is not well attached

If the LED blinks rapidly, it indicates that the lamp is not attached properly.

## 3. Temperature is too high

If the internal temperature of the projector is too hot to operate safely, the LED will blink slowly for one minute and then the lamp will turn off automatically.

## 4. Normal status

If the LED light is off, it means the lamp and temperature inside the projector are normal.



### Caution

*The lamp indicator will light up when the lamp becomes too hot. Turn off the power and let the projector cool down for 45 minutes, then turn it on again. If the indicator is still on, contact your dealer.*

## B Lamp Replacement

When replacing the lamp, turn off the projector and unplug the AC cord. Wait for 45 minutes so that the lamp can be cool. High-pressure lamp may explode if improperly handled.



### Caution

- *Dispose of used lamps in accordance with local authorities.*
- *Do not apply shocks to it or scratch it, as the lamp is made of glass.*
- *Furthermore, do not use an old lamp, because this could cause the lamp to explode.*
- *If it the lamp has exploded, disconnect the power cord from the outlet and ask your dealer to replace the lamp. The lamp is covered by a front glass panel and an air-tight structure, but, in rare cases, the reflector and the inside of the projector may be damaged by scattered, broken pieces of glass, which could cause injury while being handled.*

1. Switch the main power off and disconnect the power cord from the outlet.
2. Remove the lamp cover.
  - If hot, the lamp could cause burns. Wait for about 45 minutes until lamp cools down.
  - Loose a screw and remove the cover.
3. Loosen the screw and pull the handle to remove the lamp.
  - If the screw is not loosened completely, you could injure your fingers.
  - Do not insert your hand into the box after the lamp is removed. (There are optical parts inside that could result in color unevenness, if touched.)
4. Replace a new lamp and secure it using the same screw.
  - Firmly tighten the screws. Loose screws could result in poor connection, which will cause the unit to malfunction.
5. Install the lamp cover and secure it with a screw.
  - To prevent burns, install the lamp cover and secure it using the screw.
  - Do not turn on power when lamp cover is removed.
  - Whenever the lamp is replaced, reset the total operation time of the lamp. Do not reset if a new lamp is not replaced.
  - Do not reset the timer without lamp replacement, as this can cause lamp breakage .



FixYourTV.com

Sponsored by DM

DiscountMerchant.com (800) 281-8860

THE TRUSTED SOURCE FOR PROJECTOR LAMPS AND ACCESSORIES

## Lamp Replacement Procedure

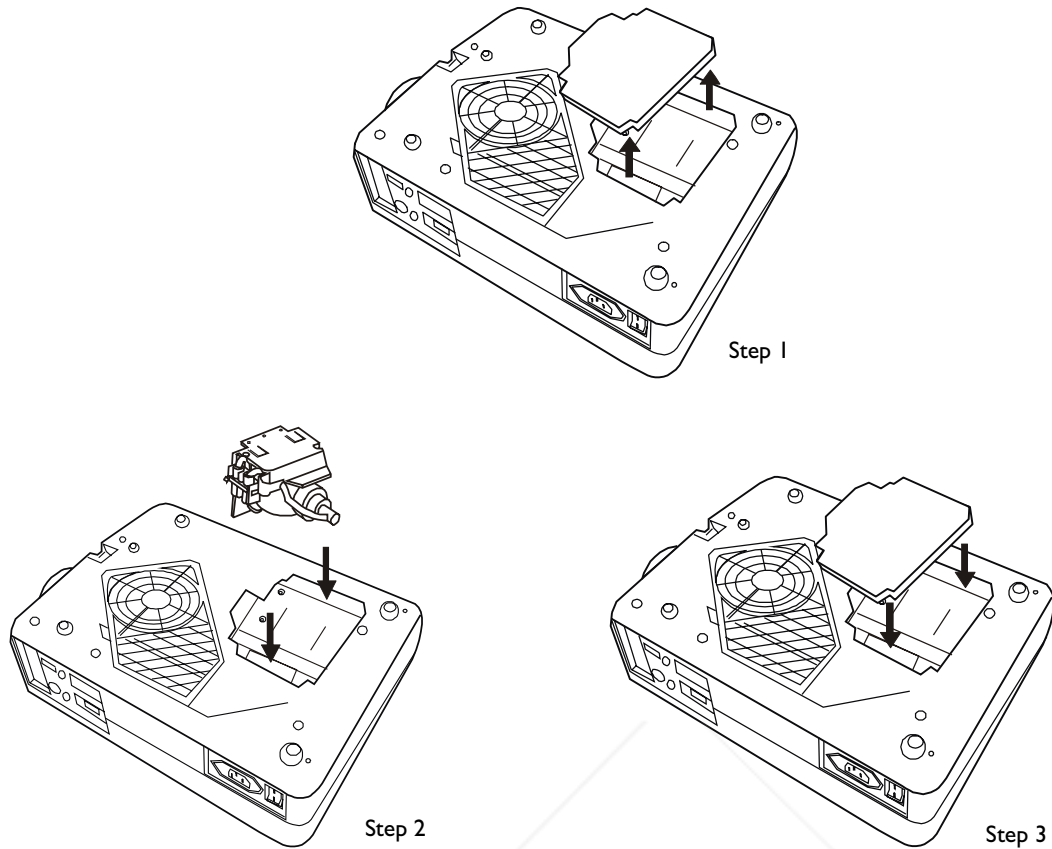

Figure 17. Lamp replacement: Step 1, Step 2, Step 3

### Resetting Lamp Timer

Carry out the following operation within 10 minutes of powering on after a new lamp is installed.

OSD	FUNCTION
	Press <b>Exit</b> on the projector for 3 seconds or <b>Exit</b> on the remote control for 3 seconds and display the total lamp usage time.
	Press <b>Menu</b> on the projector or the remote control while the lamp usage time is being displayed, and the lamp hour display will be active and adjustable.
	Select the <b>Reset</b> item on the screen using the ◀ or ▶ buttons on the control pad or the remote control. Lamp Hours Used/Reset

# OSD

## Main OSD Menu

Press **Menu** and the main OSD menu structure will appear as shown at right (Figure 18). Whenever AV connector is attached, 4 sub-pages appear in the menu: Display page, Image page, Control page and Source page. Press the "▲" or "▼" key to enter Display page items or press "◀" or "▶" to select sub-pages.

Press **Exit** to leave the current sub-page, and press the button again to leave the main OSD menu (meanwhile the settings are saved).

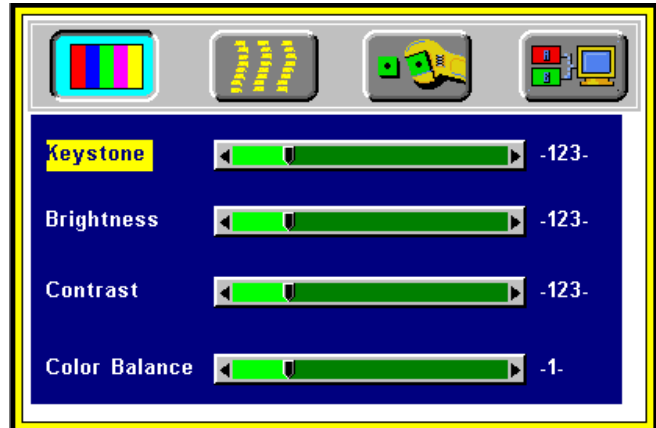

Figure 18. Main OSD menu

## A Display Page

When a PC is the input source, there will be only four items on this page: Keystone, Brightness, Contrast, and Color Balance (Figure 19). On the other hand, when the input source is Video or S-video, there will be 4 other items on this page: Keystone, Brightness, Contrast, and Sharpness (Figure 20).

Press **Menu** again to scroll through the items; press ◀ or ▶ to adjust the item scale, or press **Exit** to go back to the main OSD page.

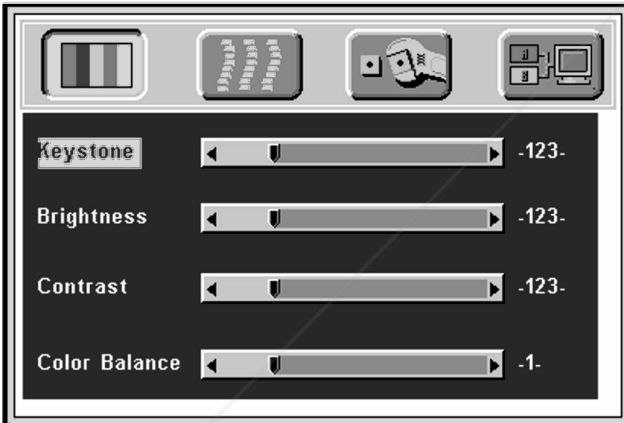

Figure 19. Display sub-page when the input source is PC (with/without video, s-video).

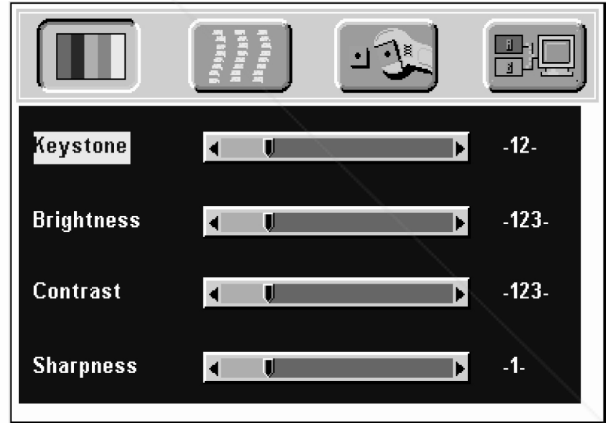

Figure 20. Display sub-page when the input source is video, s-video.

Setting effects			
<b>Keystone</b>	(Decrease)	↔	(Increase) Source is PC
<b>Brightness</b>	(Dark)	↔	(Bright)
<b>Contrast</b>	(Lower)	↔	(Higher)
<b>Color Balance</b>	(Red)	↔	(Blue)
<b>Sharpness</b>	(Soft)	↔	(Sharp) Source is Video

## B Image Page

Select the Image sub-page and **Auto Resize** will be highlighted. There are five items on this page: Auto Resize, H. Phase, H. Size, H. Position, and V. Position (Figure 21).

If the input is from video, s-video instead of PC, another different IMAGE sub-page including Image Ratio, System, Color and Tint will come out as Figure 22.

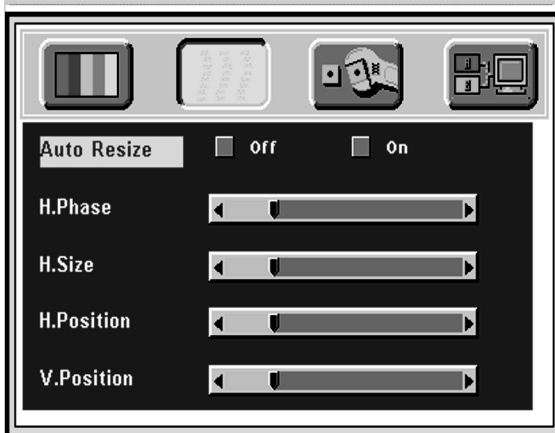

Figure 21. Image sub-page  
Only available when the input signal is PC.

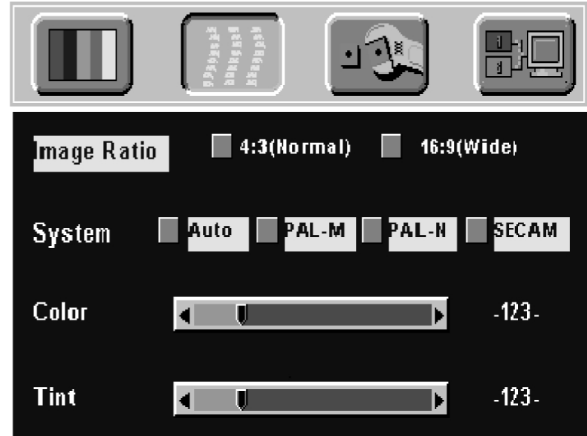
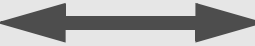
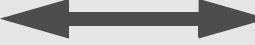

Figure 22. Image sub-page  
Only available when the input signal is from video, S-video

### Setting effects

<b>Auto Resize</b>	When Auto Resize is on, the projector determines the best fit of the image to the screen.
<b>H. Phase</b>	If flickers occur on the projected image, users may try to adjust the H. Phase manually.
<b>H. Size</b>	If the projected image is too wide or too narrow for the screen, users may turn Auto Image off and adjust the H. Size manually to fit the screen size.
<b>H. Position</b>	(move the image left)  (move the image right) The Auto Image should be turned off to activate the H. Position item. Position adjustments are saved when the projector is power off.
<b>V. Position</b>	(move the image down)  (move the image up) Position adjustments are saved when the projector is power off.

<b>Image Ratio</b>	4:3 (Normal)    16:9 (Wide)
<b>System</b>	When a video or s-video is attached, the projector will automatically detect the video system. Users can select desired video systems. When selecting system, the projector will auto detect the selected system simultaneously, and the OSD will still exit on the screen. The default setting of System is "Auto" (See Figure 22).

<b>Color</b>	(Less)  (More)
<b>Tint</b>	(Red)  (Green)    Source is Video or S-Video

\*Tint may not be adjusted with PAL/SECAM video signal input.

## C Control Page

There are five items on this page: Auto, Language, Mirror, and Auto Off. (Figure 23)

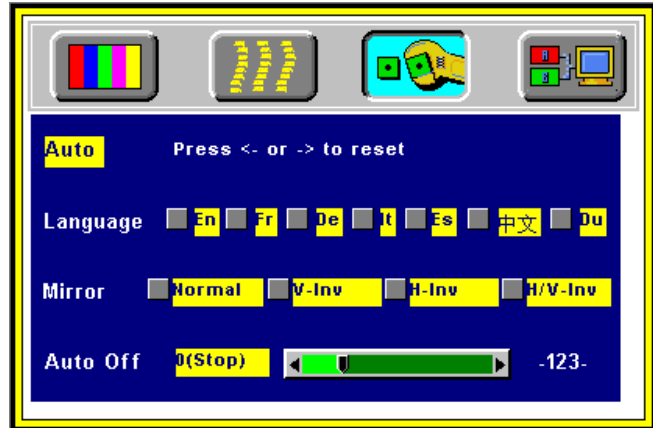

Figure 23. Control sub-page

### Setting effects

<b>Language</b>	The OSD menus support 7 languages and they are English, French, German, Italian, Spanish, Simplified Chinese and Dutch. (See Figure 23).
<b>Mirror</b>	Normal projection, H-Invert projection, V-Invert projection, or H/V Invert projection for selection.
<b>Auto Off</b>	To set the time to turn the power off after the start up screen is displayed and no signal is detected or sync is out of range. Use “◀” or “▶” to set the time. 0 means Auto Off function is inactive. *Default setting is 0 (stop).
<b>Auto</b>	Select Auto and press “◀” or “▶” to reset display, image and control settings to factory settings.

## D Source Page

This Sub-page will only show up whenever video, s-video is attached.

There are five items on this page: Source, Volume, Treble, Bass, and Mute.

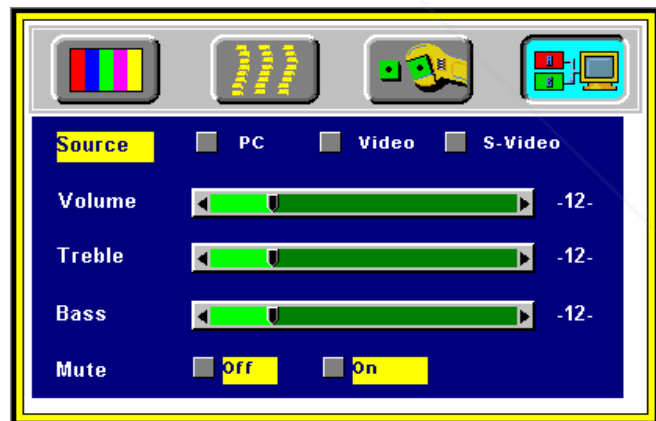

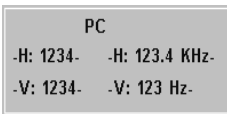



Figure 24. Source sub-page (video, s-video)

\*The sequence of input signal detection: a. PC b. Video c. S-Video

\*When selecting input sources, the projector will detect the selected input simultaneously, and the OSD menu will still exist on the screen.

Discount-Merchant.com (800) 281-8860  
THE TRUSTED SOURCE FOR PROJECTOR LAMPS AND ACCESSORIES

## Other Correspondent and Remote Functions Messages

OSD	FUNCTION
 <p>Source</p>	The selected source will be displayed at the bottom right of the screen for 3 seconds after selecting the source.
 <p>Freeze</p>	The image will be frozen when the <b>Freeze</b> is pressed. A mark appears at the lower right of the screen for 3 seconds during the freeze function. Furthermore, a “▶” mark appears at the lower right of the screen for 3 seconds when freeze is released. <b>Freeze</b> is released when the source button or <b>Freeze</b> button is pressed again.
 <p>Mute</p>	Press <b>Mute</b> and the sound will be muted. There will be an OSD message as shown left: Press <b>Mute</b> again or the volume +/- buttons to turn off the mute.
 <p>Volume</p>	Press volume + or – to adjust the volume. The OSD message on the left will appear: (The message will disappear automatically 3 seconds after the volume is adjusted.)
 <p>Magnify</p>	By pressing the magnify + , the center of the picture will be magnified. Press the button again, and the image will be further magnified (to a maximum of 4X). Press the magnify - button, and the size of the magnified image will be reduced by 50 percent. To return to the normal display mode, press <b>Return</b> .
<p>Laser</p>	Press this button to generate the laser beam.
<p>Disk Pad</p>	If users connect the PS2 (ADB) mouse cable on the projector with the PC/Notebook (Macintosh/ Powerbook) mouse port, the disk pad will be able to function as a PC/Notebook (Macintosh/ Powerbook) mouse. When an image has been magnified, press the <b>Disk Pad</b> button to move around the display area (the mouse function is not available when magnify function is on).
<p>Drag</p>	This button is a toggle to turn on/off the drag function of the remote mouse.
<p>Blank</p>	Press <b>Blank</b> to activate or release the blank function.

# MAINTENANCE AND TROUBLESHOOTING

# 4

## A Lamp Replacement

Refer to page 11.

## B Cleaning the Lens

Follow the steps below to clean the projection lens:

1. Apply a non-abrasive camera lens cleaner to a soft, dry cleaning cloth (abrasive cleaners, solvents or other harsh chemicals might scratch the lens).
2. Avoid using an excessive amount of cleaner.
3. Lightly wipe the clean cloth over the lens.
4. Affix the lens cover whenever the projector is not in use.

## C Troubleshooting

PROBLEMS	TRY THESE SOLUTIONS
<b>NO POWER</b>	<ul style="list-style-type: none"> <li>• Plug the power cord into the AC Inlet.</li> <li>• Plug the power cord into the power Inlet.</li> <li>• Wait for 2 minutes after the projector is turned off before turning the projector back on.</li> </ul>
<b>NO PICTURE</b>	<ul style="list-style-type: none"> <li>• Check if you select the proper input source.</li> <li>• Ensure all cables are connected properly.</li> <li>• Adjust the brightness and contrast.</li> <li>• Remove the lens cap.</li> <li>• Is the POWER indicator flashing?</li> <li>• Is the STATUS Indicator flashing?</li> </ul>
<b>TILTED IMAGE</b>	<ul style="list-style-type: none"> <li>• Reposition the unit to improve its angle on the screen.</li> <li>• Is the vertical offset properly corrected by using the keystone function?</li> </ul>
<b>POOR COLOR</b>	<ul style="list-style-type: none"> <li>• Select the correct video system.</li> <li>• Adjust brightness, contrast, or saturation.</li> </ul>
<b>BLURRED IMAGE</b>	<ul style="list-style-type: none"> <li>• Adjust the focus.</li> <li>• Reposition the unit to improve its screen angle.</li> <li>• Ensure the distance between the unit and screen is within the adjustment range of the lens.</li> </ul>
<b>REMOTE CONTROL NOT WORK</b>	<ul style="list-style-type: none"> <li>• Replace the batteries with new ones.</li> <li>• Make sure there is no obstacle between the remote control and the unit.</li> <li>• Stand within 4 meters (13 feet) of the unit.</li> <li>• Make sure nothing is blocking the receiver on the control pad.</li> </ul>
<b>NO SOUND</b>	<ul style="list-style-type: none"> <li>• Check audio cable connection from audio input source.</li> <li>• Adjust audio source.</li> <li>• Press "Volume" (+) button.</li> <li>• Press "Mute" button.</li> </ul>



# SPECIFICATIONS

# 5

## A Optical

LCD Panel	3 sheets of liquid crystal panels, 3 primary color lights shutter system
Lens	Manual zoom, manual focus (F=1.73 to 2.17 f=37.8 to 49 mm)
Lamp	150W UHE
Image size	19 to 310
Projection Distance	1 to 13 M

## B Electrical

Inputs RGB	(H:31.47 to 68.70 kHz V:56.25 to 85.00 Hz)
Video	(NTSC/PAL/SECAM/NTSC 4.43)
Color Reproduction	Full color, 16.7 million colors simultaneously.
Power Requirement	100 to 240 VAC, 50 to 60 Hz

## C Mechanical

Dimensions	32.5 cm (L) 9.9 cm (H) 24.0 cm (W)
Operational Temperature projector	10°C to 40°C
Remote control	

## D Preset Display Resolution Table

Resolution	H Sync (kHz)	V Sync (Hz)	Remark
640x350	37.9	85.1	VESA
640x400	37.9	85.1	VESA
640x400	24.8	56.4	
720x400	37.9	85.0	VESA
640x480	31.5	59.9	VESA
640x480	37.9	72.8	VESA
640x480	35	66.7	Macintosh
640x480	43.3	85.0	VESA
800x600	35.2	56.3	VESA
800x600	37.9	60.3	VESA
800x600	46.9	75.0	VESA
800x600	48.1	72.2	VESA
800x600	53.7	85.1	VESA
832x624	49.7	74.5	Macintosh
1024x768	48.4	60.0	VESA
1024x768	56.5	70.1	VESA
1024x768	60.0	75.0	VESA
1024x768	68.7	85.0	VESA
1280x1024	64.0	60.0	VESA





**Discount-Merchant.com (800) 281-8860**  
**THE TRUSTED SOURCE FOR PROJECTOR LAMPS AND ACCESSORIES**



# Disclaimer

This user manual is provided as a free service by FixYourDLP.com. FixYourDLP is in no way responsible for the content of this manual, nor do we guarantee its accuracy. FixYourDLP does not make any claim of copyright and all copyrights remain the property of their respective owners.

About FixYourDLP.com

FixYourDLP.com (<http://www.fixyourdpl.com>) is the World's #1 resource for media product news, reviews, do-it-yourself guides, and manuals.

Informational Blog: <http://www.fixyourdpl.com>

Video Guides: <http://www.fixyourdpl.com/guides>

User Forums: <http://www.fixyourdpl.com/forum>

FixYourDLP's Fight Against Counterfeit Lamps:

<http://www.fixyourdpl.com/counterfeits>

## Sponsors:

RecycleYourLamp.org – Free lamp recycling services for used lamps:

<http://www.recycleyourlamp.org>

Lamp Research - The trusted 3rd party lamp research company:

<http://www.lampresearch.com>

Discount-Merchant.com – The worlds largest lamp distributor:

<http://www.discount-merchant.com>



**FixYourDLP.com**

Sponsored by 