



Disclaimer

This user manual is provided as a free service by FixYourDLP.com. FixYourDLP is in no way responsible for the content of this manual, nor do we guarantee its accuracy. FixYourDLP does not make any claim of copyright and all copyrights remain the property of their respective owners.

About FixYourDLP.com

FixYourDLP.com (<http://www.fixyourdpl.com>) is the World's #1 resource for media product news, reviews, do-it-yourself guides, and manuals.

Informational Blog: <http://www.fixyourdpl.com>

Video Guides: <http://www.fixyourdpl.com/guides>

User Forums: <http://www.fixyourdpl.com/forum>

FixYourDLP's Fight Against Counterfeit Lamps:

<http://www.fixyourdpl.com/counterfeits>

Sponsors:

RecycleYourLamp.org – Free lamp recycling services for used lamps:

<http://www.recycleyourlamp.org>

Lamp Research - The trusted 3rd party lamp research company:

<http://www.lampresearch.com>

Discount-Merchant.com – The worlds largest lamp distributor:

<http://www.discount-merchant.com>



FixYourDLP.com

Sponsored by 

ViewSonic®

PJ500/PJ550 ***PJ501/PJ551***

User Guide

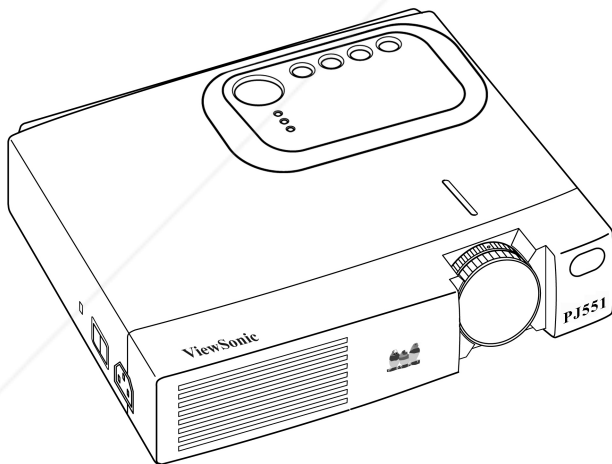

 **FixYourDLP.com**
Sponsored by 

DiscountMerchant.com (800) 281-8860
THE TRUSTED SOURCE FOR PROJECTOR LAMPS AND ACCESSORIES

Image Size 30" - 300"
High Brightness Light Weight
LCD Projector

Contents

For Your Records	1
Features	2
Product Features	2
Before Use	2
Package Contents	2
Projector Components	3
Projector Components Diagram	3
Remote Control Components	4
Remote Control Components Diagram	4
Inserting the Batteries	5
Installation	6
Angle Adjustment	6
Cabling	7
Power Connection	7
Example of System Setup	8
Plug & Play	8
Operations 9	
Power ON	9
Power OFF	9
Basic Operation	10
MAIN Menu	12
PICTURE-1 Menu	13
PICTURE-2 Menu	14
INPUT Menu	15
SCREEN Menu	16
OPTION Menu	17
Maintenance	18
Lamp	18
Lamp Life	18
Replacing the Lamp	19
Resetting the Lamp Timer	19
Air Filter	20
Maintenance Inside the Equipment	20
Cleaning the Lens	20
Cleaning the Cabinet and Remote Control	20



Troubleshooting	21
OSD Messages	21
Indicator Messages	21
Symptom	22
Specifications	24
PJ500/PJ501 Technical Specifications	24
PJ550/PJ551 Technical Specifications	25
Customer Support	26
LIMITED WARRANTY	27
VIEWSONIC Projector	27
Appendix	28
Power Cord Safety Guidelines	28
Compliance Information for U.S.A.	29
Compliance Information for Canada	29
Compliance Information for European Countries	29
User Information for all Countries	29



Discount-Merchant.com (800) 281-8860
THE TRUSTED SOURCE FOR PROJECTOR LAMPS AND ACCESSORIES

Copyright © ViewSonic Corporation, 2002. All rights reserved.

Apple, Mac and ADB registered trademarks of Apple Computer, Inc.

Microsoft, Windows, Windows NT, and the Windows logo are registered trademarks of Microsoft Corporation in the United States and other countries.

ViewSonic, the three birds logo and OnView are registered trademarks of ViewSonic Corporation.

VESA and SVGA are registered trademarks of the Video Electronics Standards Association.

DPMS and DDC are trademarks of VESA.

PS/2, VGA and XGA are registered trademarks of International Business Machines Corporation.

As an ENERGY STAR® partner, ViewSonic Corporation has determined that this product meets the ENERGY STAR® guidelines for energy efficiency.

Disclaimer: ViewSonic Corporation shall not be liable for technical or editorial errors or omissions contained herein; nor for incidental or consequential damages resulting from furnishing this material, or the performance or use of this product.

In the interest of continuing product improvement, ViewSonic Corporation reserves the right to change product specifications without notice. Information in this document may change without notice.

No part of this document may be copied, reproduced, or transmitted by any means, for any purpose without prior written permission from ViewSonic Corporation.

This document is applicable for both projector models PJ500/PJ550/PJ501/PJ551.

Electronic Warranty Registration

To meet your future needs, and to receive any additional product information as it becomes available, please register your projector's warranty on the Internet at: <http://www.viewsonic.com>

For Your Records

Product Name:	PJ500	PJ550	PJ501	PJ551
Model Number:	VPROJ23544-2W	VPROJ23545-2W	VPROJ25048-1W	VPROJ25049-1W
Document Number	A-CD-PJ001			
Serial Number:	B0Y_____	B0W_____	B12_____	B13_____
Purchase Date:	_____	_____	_____	_____



Discount-Merchant.com (800) 281-8860
THE TRUSTED SOURCE FOR PROJECTOR LAMPS AND ACCESSORIES

Features

Product Features

- SVGA (PJ500/501)
- XGA (PJ550/551)
- High performance scalers for viewing high resolution computer images
- Short focal length
- Whisper-mode
- Digital keystone correction
- Component video maximizes video image quality

Before Use

Package Contents

Make sure all of the following items are included in the package. If anything is missing, please contact ViewSonic.

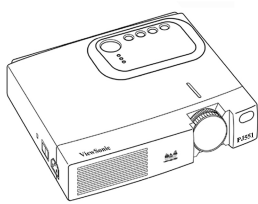

Projector



Carrying Case

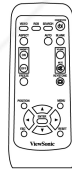

Remote Control with battery

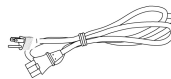

Power Cord (US type)

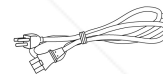

Power Cord (Europe type)

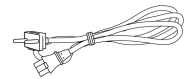

Power Cord (China type)



Quick Start Guide



ViewSonic Wizard CD

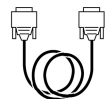

RGB Cable (computer)

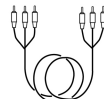

RCA Video/Audio cable



Yellow Red White



Red Blue Green

Component Video Cable



S-Video Cable

Figure 1: Package Contents



NOTE: Keep the original packing material for possible future reshipment.

FixYourDLP.com

Sponsored by DM

Discount-Merchant.com (800) 281-8860

THE TRUSTED SOURCE FOR PROJECTOR LAMPS AND ACCESSORIES

Projector Components

Projector Components Diagram

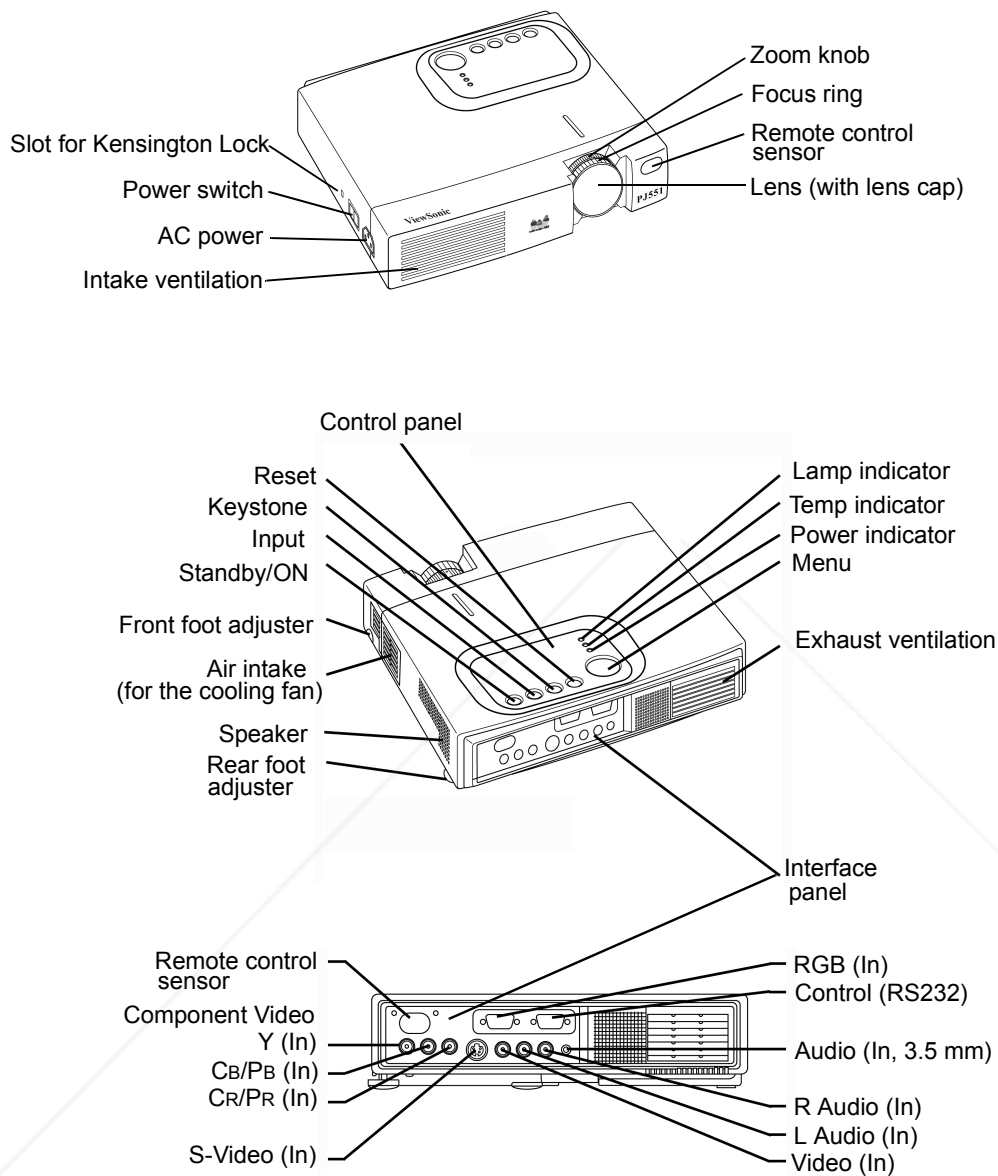

Figure 2: Projector Components

Remote Control Components

Remote Control Components Diagram

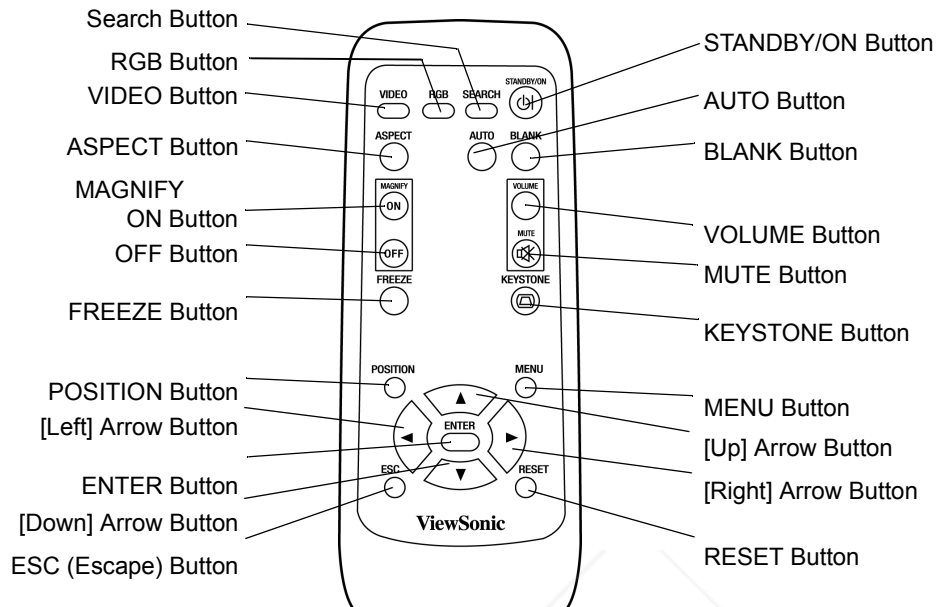

Figure 3: Remote Control Components

Inserting the Batteries

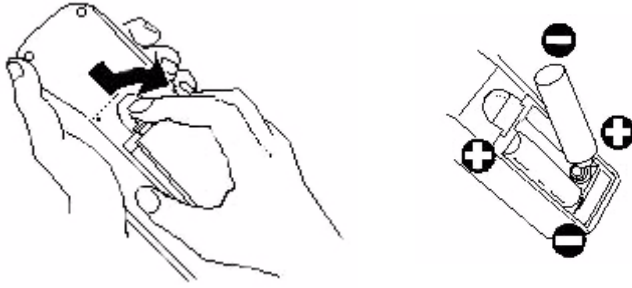

Figure 4: Battery

- 1 Remove the battery cover by pulling then lifting the knob on the cover.
- 2 Insert the batteries, corresponding to the (+) and (-) markings on the battery compartment.
- 3 Reattach the battery cover.



CAUTION

- Only use the specified AA batteries.
- Do not mix new and old batteries. This may result in cracking or leakage, which may pose a risk of fire or lead to personal injury.
- Insert batteries according to (+) and (-) markings. Inserting the batteries incorrectly may result in cracking or leakage, which may pose a risk of fire or lead to personal injury.
- Dispose of the battery in accordance with local laws and regulations.
- Keep the battery away from children and pets.
- When the remote control will not to be used for an extended period, remove the batteries.

NOTE: Replace the batteries if the operation of the remote control becomes irregular or weak.

Installation

Refer to the graphics and table on this page to determine the screen size and projection distance.

The projection distances shown in the table below are for full size (PJ500/PJ501:800x600pixels, PJ501/PJ550:1024 x 768 pixels).

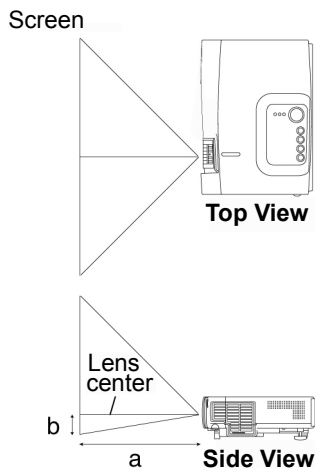

- a** Distance from the projector to the screen (+10%).
- b** Distance from the lens center to the bottom of the screen (+10%).

Table 1: Projection Distance

Screen Size Inches (m)	a Inches (m) Minimum and Maximum		b Inches (cm)
40 (1.0)	37 (0.9)	46 (1.2)	3 (8.7)
60 (1.5)	57 (1.5)	69 (1.8)	5 (13.1)
80 (2.0)	77 (1.9)	93 (2.4)	7 (17.4)
100 (2.5)	96 (2.4)	116 (2.9)	9 (21.8)
120 (3.0)	116 (2.9)	139 (3.5)	10 (26.1)
150 (3.8)	145 (3.7)	174 (4.4)	13 (32.7)
200 (5.0)	194 (4.9)	233 (5.9)	17 (43.5)

Figure 5: Screen Views



Warnings

- Position the projector in a horizontal position; other positions can cause heat build-up and damage to the projector.
- Make sure the heat ventilation holes are not blocked.
- Do not use the projector in a smoky environment. Smoke residue may cause buildup on critical parts (i.e. LCD panel, lens assembly, etc.)

Angle Adjustment

Use the foot adjusters on the bottom of the projector to adjust the projection angle. The angle is variable within approximately 0° to 9°.

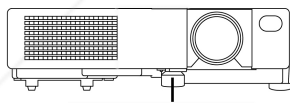

Foot Adjuster

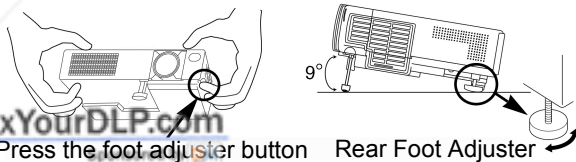

Press the foot adjuster button

Rear Foot Adjuster

Figure 6: Angle Adjustment

- 1 Lift up the front side of the projector, press the foot adjuster button, and adjust the projection angle.
- 2 Release the adjuster button to lock at the desired angle.
- 3 Rotate the foot pad to adjust the left/right tilt of the displayed image.

Cabling

Refer to the table below for connecting each terminal of the projector to a device.

Table 2: Cabling

Function	Terminal	Cable
Analog RGB input	RGB	Accessory RGB cable or optional RGB cable with D-sub 15-pin shrink jack and inch thread screws
RS-232C communication	CONTROL	Optional RS-232C cable
Component video input	VIDEO Y VIDEO Cb/Pb VIDEO Cr/Pr	Accessory component video cable
S-video input	S-VIDEO	Accessory S-video cable with mini DIN 4-pin jack
Video input/ Audio input	VIDEO AUDIO (L) AUDIO (R)	Accessory video/audio cable with RCA jacks
Audio Input	3.5 mm to mini-jack L/R	Optional



Warnings

- Incorrect connections could result in fire or electrical shock.
- Before connecting, turn off all devices to be connected.
- Use the cables that are packaged with the product. Refer to page 27.
- See “Power Cord Safety Guidelines” on page 28.

NOTE:

- Before connecting, read the instruction manuals of the devices to be connected, and make sure that the projector is compatible with the device(s).
- Securely tighten the screws on the connectors.
- For some RGB input modes, the optional Mac adapter is necessary.
- Some computers may have multiple display screen modes. You may not be able to use some of the modes with this projector.

Power Connection

Use the correct power cord supplied with your projector. Connect the AC inlet of the projector to the power outlet as shown in the graphic below.

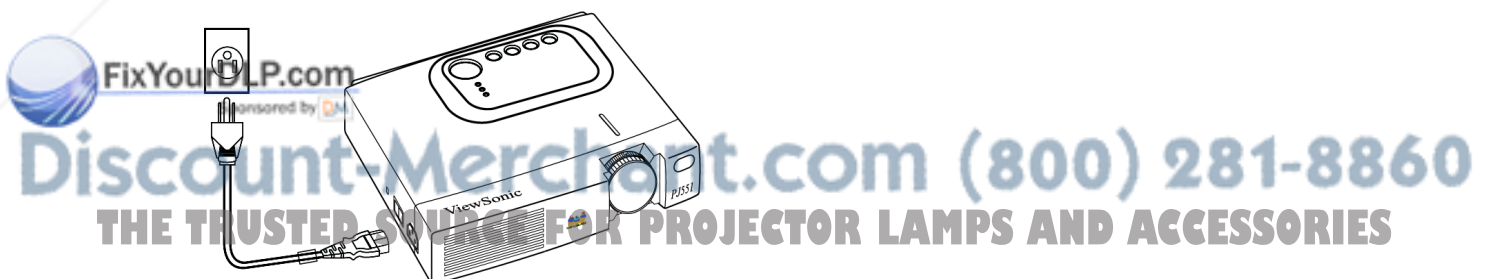

Figure 7: Power Cord Connect

Example of System Setup

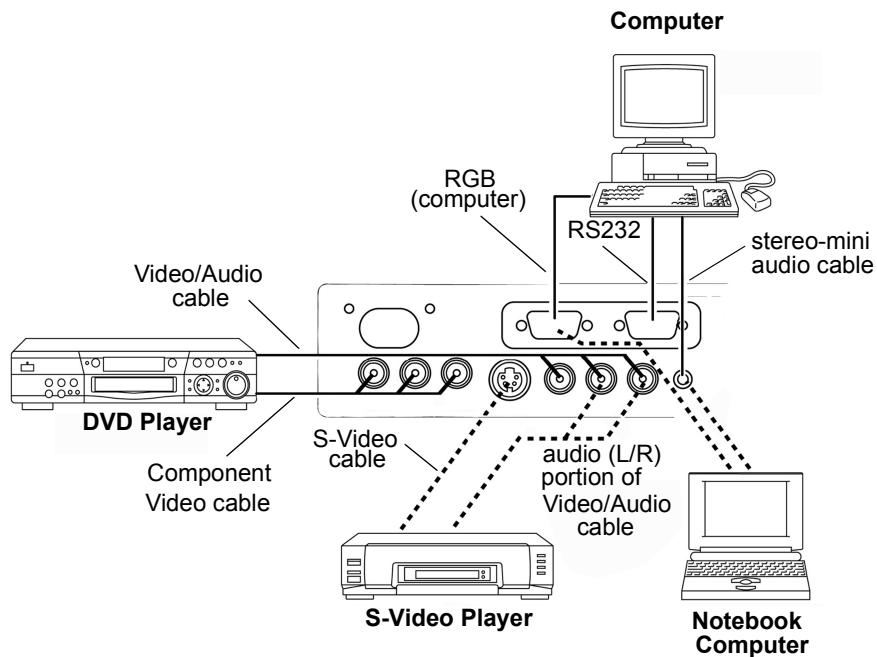

Figure 8: System Setup

Plug & Play

This projector is VESA DDC 1/2B compatible. Plug& Play is possible by connecting to a computer that is VESA DDC (Display Data Channel) compatible.

Please use this function by connecting the accessory RGB cable to RGB (In) of the projector; other connection methods may not work.

NOTE: Plug & Play is a system configured with peripheral equipment including a computer, display and operating system. This projector is recognized as Plug & Play capable. Refer to the ViewSonic CD Wizard INF display driver files for configuration.

Plug & Play will not operate with a direct connection to an Apple computer.

NOTE: When connecting with a notebook computer, set the proper RGB external image output. Please read the instruction manual of the notebook computer for more information.

Operations

Power ON

NOTE: Refer to “Example of System Setup” on page 8.

- 1 Make sure the power cord is connected correctly and lens cap has been removed. Set the Power Switch to [I] ON. The unit is now in Standby mode and the POWER indicator LED turns a steady orange.
- 2 Press the STANDBY/ON button on the control panel or the remote control. Warm-up begins and the power indicator blinks in green.
- 3 After several seconds the lamp will stop blinking and will turn to continuous green, indicating that the projector is ready to use.
- 4 Adjust the size of the projected image with the Zoom knob.
- 5 Adjust focus using the Focus ring.

Power OFF

NOTE: See Caution below.

- 1 Press the STANDBY/ON button on the control panel or the remote control. The message “POWER OFF?” will display on the screen, and the message will disappear in 5 seconds. During this message indication, press the STANDBY/ON button again. The projector lamp shuts off and lamp cooling begins.
- 2 Wait for the cooling fan to stop. The POWER indicator blinks orange during lamp cooling. Pressing the STANDBY/ON button has no effect while the POWER indicator is blinking.
- 3 The system assumes the Standby mode when cooling is complete. The POWER indicator ceases blinking and changes to a steady orange. Check that the indicator is orange and set the POWER switch to [O]. The POWER indicator turns off when the Power Switch is set to [O] OFF. Remember to replace the lens cap after use.

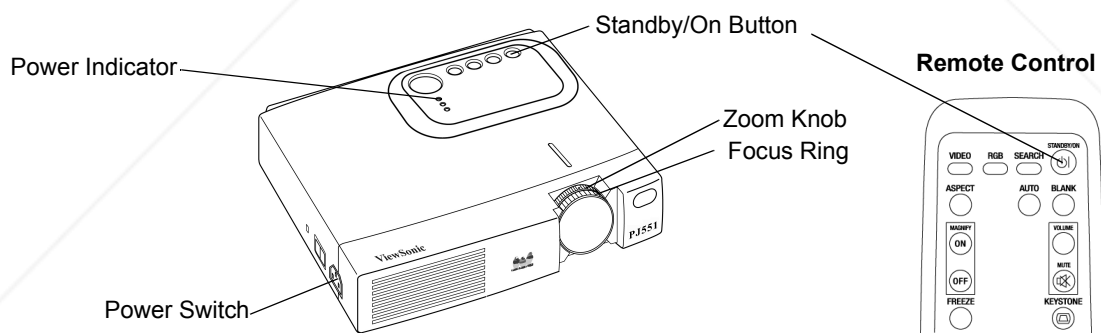

Figure 9: Power Buttons

NOTE: Except in emergencies, do not turn off the Power Switch unless the POWER indicator is a steady orange. Otherwise improper cooling of the lamp will reduce the life of the lamp or may damage the lamp.



CAUTION

- To turn OFF the projector press the Standby/ON button and hold for 2 seconds .
- The POWER LED on the control pad flashes orange during cool-down.
- Wait until the POWER LED changes to a steady orange before you set the Power Switch to [O] OFF.

Basic Operation

Table 3 below refers to buttons on the projector control panel and on the remote control. Items marked with (*) may be accessed from the projector control panel.

Table 3: Basic Operation

Item	Description
INPUT SELECT (projector control panel)	<p>Select Input Signal (*) : press the INPUT Button. RGB → VIDEO → S-VIDEO → COMPONENT (→RGB)</p> <p>Select RGB Input: Press the RGB button. VIDEO/S-VIDEO/COMPONENT → RGB</p> <p>Select Video Input: Press the VIDEO button. RGB → VIDEO/S-VIDEO/COMPONENT VIDEO → S-VIDEO → COMPONENT (→VIDEO)</p> <ul style="list-style-type: none"> The selected signal name is displayed for approximately 3 seconds when the input signal is changed.
POSITION (remote control)	<p>Set/Clear Position Adjustment mode : Press the POSITION button. “POSITION” is displayed in the POSITION mode.</p> <p>Image Position Adjustment: Press the ◀ ▶ ▲ ▼ buttons in the POSITION mode.</p> <ul style="list-style-type: none"> Valid only in the MAGNIFY mode when a video signal is input. After approximately 10 seconds of inactivity “POSITION” disappears and the POSITION mode is cleared automatically.
RESET (*) (remote control)	<p>Initialize Each item: Select an item and press the RESET button.</p> <p>Initialize Position Adjustment: Press the RESET button in the POSITION mode. This function is valid only when RGB signal is input.</p> <ul style="list-style-type: none"> Valid except for: VOLUME, LANGUAGE, H PHASE, and WHISPER.
MAGNIFY (remote control)	<p>Set MAGNIFY Mode: Press the MAGNIFY “ON” button.</p> <p>Move Magnified Area: Run the POSITION in the MAGNIFY mode.</p> <p>Adjust Magnification: Press the MAGNIFY ▲ / ▼ button in MAGNIFY mode. MAGNIFY ▲ magnifies the image. MAGNIFY (-) reduces the image.</p> <p>Clear MAGNIFY Mode: Press the MAGNIFY OFF button.</p> <ul style="list-style-type: none"> The MAGNIFY mode is cleared by selecting AUTO, ASPECT, INPUT SELECT, or VIDEO, or changing the input signal.
FREEZE (remote control)	<p>Set/Clear FREEZE Mode: Press the FREEZE button. When the [II] icon is displayed, the image is frozen in the FREEZE mode.</p> <ul style="list-style-type: none"> The FREEZE mode is cleared by selecting POSITION, VOLUME, MUTE, Automatic Adjustment, BLANK ON/OFF, or MENU ON/OFF, or by changing the input signal. Do not forget to clear frozen static images.
KEystone (*) (projector control panel and remote control)	<p>Set/Clear KEystone Mode: Press the KEystone button.</p> <p>Adjust Keystone: Press the ▲ / ▼ buttons in the KEystone mode. ▲ reduces the width of the bottom of the projected image. ▼ reduces the width of the top of the projected image.</p>
VOLUME (remote control)	<p>Set/Clear VOLUME Mode: Press the VOLUME button to display the Volume menu, then press ▲ / ▼ buttons on the remote control to increase/decrease the loudness of the sound. After the desired volume is selected, press the VOLUME button again to exit the Volume mode.</p>
MUTE (remote control)	<p>Set/Clear Mute Mode: Press the MUTE button. The sound is silenced in this mode.</p>

Table 3: Basic Operation (Continued)

Item	Description
AUTO (remote control)	<p>Automatic Adjustment (for RGB input): Press the AUTO button. Horizontal Position (H. POSITION), Vertical Position, (V. POSITION), Clock Phase (H. PHASE), and Horizontal Size (H. SIZE), are automatically adjusted.</p> <ul style="list-style-type: none"> • Before using the AUTO feature, be sure to maximize the window of the application displayed on-screen. <p>Automatic Adjustment (for Video Input): Press the AUTO button. A signal type appropriate for the input signal is selected automatically. This is valid only when AUTO is set for VIDEO on the menu.</p> <ul style="list-style-type: none"> • This operation requires approximately ten seconds. It may not function correctly with some input signals.
BLANK ON/OFF (remote control)	<p>Set/ Clear Blank Mode: press the BLANK button. A blank screen (no image) is displayed in this mode. Access the on-screen menu to set the screen color for blank mode.</p>
MENU (*) (projector control panel and remote control)	<p>Display/Clear Menu: Press the MENU button.</p> <p>Select Menu: Press the ▲ / ▼ buttons to select the menu (MAIN, PICTURE-1, PICTURE-2, INPUT, SCREEN, OPTION), and press the ► button or the ENTER button (on the remote control) to proceed.</p> <p>Select Item: Press the ▲ / ▼ buttons to select the item you want to operate, and press the ► button or the ENTER button (on the remote control) to proceed.</p> <p>Select Menu Type (for adjustment with numerical value): After fixing the item, press the ► button or ENTER button (on the remote control) to turn to the single type menu. To return to the usual menu, press the ◀ button or ESC button.</p> <p>Operate: Press the ▲ / ▼ buttons according to the menu.</p> <ul style="list-style-type: none"> • The menu display is terminated automatically after approximately 10 seconds of inactivity.
SEARCH (remote control)	<p>Search Signal: Press the SEARCH button on the remote control to search for other signal inputs with following command : When a signal is detected, the projector displays the detected signal picture. If no signal is detected, it turns back to the initial signal input.</p> <p>Example : If S-VIDEO was the last input used before powering off, then S-VIDEO will be the selected input when the projector is powered back on.</p> <p>RGB → VIDEO → S-VIDEO → COMPONENT VIDEO → (RGB)</p>
ASPECT (Aspect Ratio) (remote control)	<p>Select Aspect (Ratio): Press the ASPECT button on the remote control to select the aspect ratio.</p> <p>For RGB Input or Hi-Vision 1125i/750p of COMPONENT VIDEO Input: 4:3 ↔ 16:9</p> <p>For VIDEO Input, S-VIDEO Input or 525i/525p/625i/625p of COMPONENT VIDEO Input: 4:3 → 16:9 → SMALL → (4:3)</p>
ESC (Escape) (remote control)	<p>Escape: Press the ESC button on the remote control to return to the previous menu from a selected sub-menu.</p>
ENTER (remote control)	<p>Escape: Press the ENTER button on the remote control activate the adjustment screen for a selected menu option.</p> <p>NOTE: Pressing the ► button performs the same function.</p>

MAIN Menu

To access the MAIN Menu, press the MENU button on the remote control. This projector has 6 menus: MAIN, PICTURE-1, PICTURE-2, INPUT, SCREEN and OPTION. To select a menu use the ▲ / ▼ buttons, then press the ► button or the ENTER button to select a menu item.

The MAIN Menu has seven (7) items as shown in the Table 4.

Please select the item you want to operate with the ▲ / ▼ buttons and press the ► button or the ENTER button to start operating. Then you can operate corresponding to the following table.

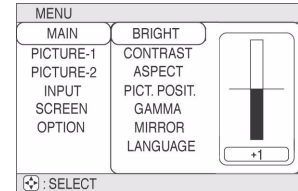

Table 4: MAIN Menu

Item	Actions/Description
BRIGHT (Brightness)	Lighter ▲ Darker ▼
CONTRAST	Stronger ▲ Weaker ▼
ASPECT (Aspect Ratio)	<p>Select Aspect Ratio</p> <p>Select ASPECT from the MAIN menu and then do the following:</p> <p>For RGB Input or Hi-Vision 1035i/1125i/750p of COMPONENT VIDEO Input , press the ▲ / ▼ button to select one of these options:</p> <ul style="list-style-type: none"> • 4:3 • 16:9 <p>For VIDEO Input, S-VIDEO Input or 525i/525p/625i of COMPONENT VIDEO Input, press the ▲ / ▼ button to select one of these options:</p> <ul style="list-style-type: none"> • 4:3 • 16:9 • SMALL (The SMALL option may not work properly with some input signals.) <p>NOTE: You can also press the ASPECT button on the remote control to select the Aspect Ratio.</p>
PICT. POSIT. (Picture Position)	<p>Select Picture Position (for 16:9/SMALL Picture)</p> <p>Press the ▲ / ▼ button to select one of these options:</p> <ul style="list-style-type: none"> • TOP • CENTER • BOTTOM
GAMMA	<p>Select Gamma Mode</p> <p>Press the ▲ / ▼ button to select one of these options:</p> <ul style="list-style-type: none"> • NORMAL • CINEMA • DYNAMIC
MIRROR	<p>Select Mirror Status:</p> <p>Press the ▲ / ▼ button to select one of these options:</p> <ul style="list-style-type: none"> • NORMAL • H:INVERT (Horizontally Inverted image) • V:INVERT (Vertically Inverted image) • H&V:INVERT (Horizontally and Vertically Inverted image)

Table 4: MAIN Menu (Continued)

Item	Actions/Description
LANGUAGE	<p>Select Menu Language:</p> <p>Press the ▲/▼ button to select one of these language options:</p> <ul style="list-style-type: none"> • ENGLISH • FRANÇAIS • DEUTSCH • ESPAÑOL • ITALIANO • NORSK • NEDERLANDS • [JAPANESE] • POTUGUÊS • [TRADITIONAL CHINESE] • [KOREAN]

PICTURE-1 Menu

The PICTURE-1 menu has 5 items as shown in Table 5.

Select the item you want to adjust with the ▲/▼ buttons and press the ► button or the ENTER button.

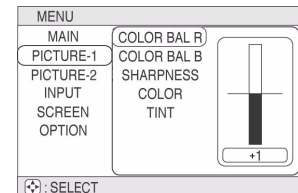

Table 5: PICTURE-1Menu

Item	Actions/Description
COLOR BAL R	Adjust Red Color Balance: Darker ▲ Lighter ▼
COLOR BAL B	Adjust Blue Color Balance: Darker ▲ Lighter ▼
SHARPNESS	Adjust Sharpness (for VIDEO/S-VIDEO): Sharper ▲ Softer ▼
COLOR	Adjust COLOR (for VIDEO/S-VIDEO/COMPONENT VIDEO): Darker ▲ Lighter ▼
TINT	Adjust Tint (for VIDEO/S-VIDEO): More Green ▲ More Red ▼

PICTURE-2 Menu

The PICTURE-2 menu has 4 items as shown in Table 6.

Please select the item you want to operate with the ▲/▼ buttons and press the ▶ button or the ENTER button to start operating. Then you can operate according to the following table.

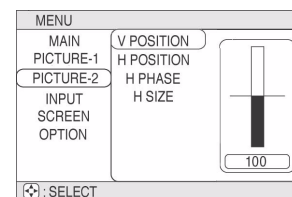

Table 6: PICTURE-2 Menu

Item	Actions/Description
V POSITION	Adjust Vertical Position (for RGB): Up ▲ Down ▼
H POSITION	Adjust Horizontal Position (for RGB): Left ▲ Right ▼
H PHASE	Adjust Horizontal Phase (for RGB/COMPONENT VIDEO): Right ▲ Left ▼ <ul style="list-style-type: none"> • Adjust to eliminate flicker.
H SIZE	Adjust Horizontal Size (for RGB): Larger ▲ Smaller ▼ <ul style="list-style-type: none"> • If the horizontal size adjustment is excessive, the image may not be displayed correctly. In such cases, please initialize the H SIZE with the RESET button.

INPUT Menu

The INPUT menu has 4 items as shown in Table 7.

Select the item you want to adjust with the ▲/▼ buttons and press the ► button or the ENTER button.

Remember, the starting of the item AUTO performs its function at the same time.

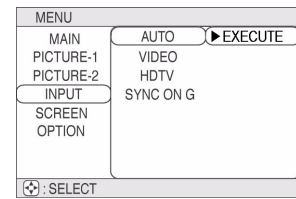

Table 7: INPUT Menu

Item	Actions/Description
AUTO	<p>Auto Adjust (for RGB): It adjusts automatically the H POSITION, V POSITION, H PHASE and H SIZE. Use this function with the maximum size window of the application.</p> <p>Auto Adjust (for VIDEO/S-VIDEO): It automatically selects the proper VIDEO mode for the current input signal. This function is active only when the AUTO mode is selected at the item VIDEO. Please refer to the description of the item VIDEO below.</p> <ul style="list-style-type: none"> • This function may not function correctly with the PAL60 signal or some other signals. • This function requires approximately 10 seconds. • For the COMPONENT VIDEO, the signal type is distinguished automatically though this function is inactive. For HDTV signal, refer to the item HDTV below.
VIDEO	<p>Select Mode of Signal Type (for VIDEO/S-VIDEO):</p> <p>Press the ▲/▼ button to select one of these options:</p> <ul style="list-style-type: none"> • AUTO • NTSC • PAL • SECAM • NTSC 4.43 • M-PAL • N-PAL <p>Selecting of the AUTO mode activates and performs the function of the item AUTO for VIDEO/S-VIDEO. It selects automatically the proper one of the modes above.</p> <p>Use this function when the image becomes unstable at VIDEO/S-VIDEO. (eg. The image becomes irregular, or lacks color.)</p> <ul style="list-style-type: none"> • The operation of the AUTO mode may not function correctly with the PAL60 signal or some other signals. • The operation of the AUTO mode requires approximately 10 seconds. • For the COMPONENT VIDEO, the signal type is distinguished automatically though this function is inactive. For HDTV signal, refer to the item HDTV below.
HDTV	<p>Select Mode of HDTV Signal Type:</p> <p>1080i ▲ 1035i ▼</p> <ul style="list-style-type: none"> • When the selected HDTV mode is incompatible with the input signal, the picture may be incorrect.
SYNC ON G	<p>On/Off SYNC ON G Mode:</p> <p>TURN ON ▲ TURN OFF ▼</p> <p>Selecting the TURN ON turns the SYNC ON G mode on. The SYNC ON G mode enables the SYNC on G to be received.</p> <ul style="list-style-type: none"> • In the SYNC ON G mode, the picture may be incorrect with some signals. In such cases, remove the signal connector so that no signal is received and turn the SYNC ON G off, and then reconnect the signal.

SCREEN Menu

The SCREEN menu has 2 items as shown in Table 8.

Please select the item you want to operate with the ▲/▼ buttons and press the ► button or the ENTER button to start operating. Then you can operate according to the following table.

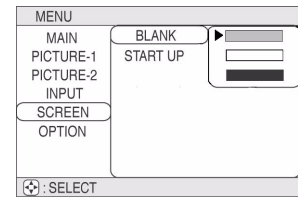

Table 8: SCREEN Menu

Item	Actions/Description
BLANK	<p>Select Mode of Blank Screen:</p> <p>Press the ▲/▼ button to select one of these options:</p> <ul style="list-style-type: none"> • Blue blank screen • White blank screen • Black blank screen <p>The Blank Screen is for the BLANK mode. Refer to the BLANK ON/OFF of the Table 3: Basic Operation. The plain screen of the selected color is displayed as the Blank Screen. The Blank Screen is displayed also as the Start Up Screen when the TURN OFF is selected at the item START UP below.</p>
START UP	<p>On/Off START UP Screen:</p> <p>TURN ON ▲ TURN OFF ▼</p> <p>The START UP screen is fixed screen displays when no signal is detected. This screen is active only when TURN ON option is selected from the START UP sub-menu.</p> <p>When TURN OFF is selected, the Blue blank screen displays when is no signal is detected.</p>

OPTION Menu

The OPTION menu has 5 items as shown in the Table 9.

Please select the item you want to operate with the ▲/▼ buttons and press the ► button or the ENTER button to start operating. Then you can operate according to the following table.

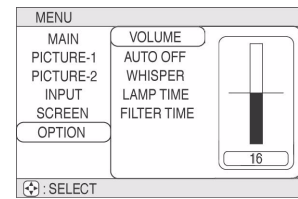

Table 9: OPTION Menu

Item	Actions/Description
VOLUME	Adjust Volume: Loud ▲ Quiet ▼
AUTO OFF	Adjust AUTO OFF Time: <ul style="list-style-type: none"> • Long (MAX. 99 min.) • Short (Min. 1 min.) • (DISABLE: 0 min.) The system automatically enters the standby mode when no signal is received for the set time. When the DISABLE (0 min.) is selected this function is inactive.
WHISPER	Select WHISPER Mode: NORMAL ▲ WHISPER ▼ The WHISPER mode is active when WHISPER is selected. In the WHISPER mode, acoustic noise level from the unit is reduced and the brightness level on screen is lowered.
LAMP TIME	Refer to Lamp Time: The starting of this item displays the time that the projector lamp has been used. Reset Lamp Time [Use this function only when the lamp is replaced!] : Keep pressing the RESET button for 3 seconds or more during the display of the lamp time. Then the menu for reset will appear. When you have replaced the lamp, select the RESET on the menu with the ▲ button. <ul style="list-style-type: none"> • Do not reset the lamp time without replacing the lamp. Reset the lamp time always when replacing the lamp. The message functions will not operate properly if the lamp time is not reset correctly. • Before replacing the lamp, carefully read the descriptions of "Lamp", "Lamp Life" and "Replacing the Lamp".
FILTER TIME	Refer to Filter Time: The starting of this item displays the time that the air-filter has been used. Reset Filter Time [Use this function only when the filter is replaced!] : Pres the RESET button for 3 seconds or more during the display of the filter time. Then the menu for resetting the filter time will display. When you have replaced the filter, select the RESET on the menu with the ▲ button. <ul style="list-style-type: none"> • Do not reset the filter time without replacing the filter. Reset the filter time always when replacing the filter. The message functions will not operate properly if the filter time is not reset correctly. • Before replacing the air filter, carefully read the descriptions of "Air-Filter" and "Replacing the Filter" on page 20.

Maintenance

Lamp

To order a new lamp unit see page 26 for contact information and see Table 15 for part numbers. The estimated lamp life is 2000 hours. Before replacing the lamp, turn the Power Switch OFF, remove the power cord from the power outlet, and wait approximately 45 minutes until the lamp has cooled.

CAUTION: The lamp may explode if handled at high temperatures.



HIGH VOLTAGE
HIGH TEMPERATURE
HIGH PRESSURE



WARNINGS

- Dispose of the used lamp according to local regulations.
- Since the lamp is made of glass, do not drop the unit and do not scratch the glass.
- Do not reuse the old lamp. This could cause the lamp to explode.
- If it is probable that the lamp has exploded (you have heard an explosive sound), disconnect the power plug from the power outlet and ask your dealer to replace the lamp. The lamp is protected by a cover glass, but in rare cases the reflector and the inside of the projector could be damaged by broken or shattered glass. Broken pieces of glass could cause injury.
- Do not use the projector with the lamp's front glass covering removed.

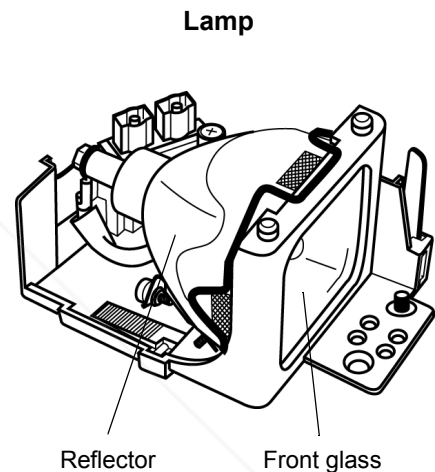

Figure 10: Lamp Diagram

Lamp Life

Projector lamps have a finite life. The image will become darker and hues will become weaker after a lamp has been used for a long period of time.

Replace the lamp if the LAMP indicator is red or the "CHANGE THE LAMP" message appears when the projector is switched on. See Table 10: "OSD Messages" on page 21 and Table 11: "Indicator Messages" on page 21.

NOTE: The LAMP indicator is also red when the lamp unit reaches high temperature. Before replacing the lamp switch the POWER OFF, wait approximately 20 minutes, and switch the POWER ON again. If the LAMP indicator is still red replace the lamp.

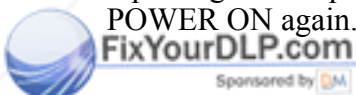

Discount-Merchant.com (800) 281-8860
THE TRUSTED SOURCE FOR PROJECTOR LAMPS AND ACCESSORIES

Replacing the Lamp

When the indicator shows that there is zero (0) hours of lamp life remaining, the unit will automatically shut off within 10 minutes. If you see this message you should replace the lamp. However, you may replace the lamp anytime after the first warning message appears at approximately 300 hours of remaining lamp life.

- 1 Switch the projector OFF, remove the power cord from the power outlet, and wait at least 45 minutes for the unit to cool.
- 2 Prepare a new lamp.
- 3 Check that the projector has cooled sufficiently, and gently turn it upside down.
- 4 Loosen the two screws as shown in the diagram, and remove the lamp cover.
- 5 Loosen the one screw, and gently remove the lamp while holding the grips. Touching the inside of the lamp case may result in uneven coloring.
- 6 Install the new lamp and tighten the one screw firmly. Make sure that the lamp assembly is seated properly before replacing the other screw.
- 7 Replace the lamp cover in position and tighten the two screws firmly.
- 8 Gently turn the projector right-side up.



CAUTION

- Ensure that screws are tightened properly. Screws not tightened fully may result in injury or accidents.
- Do not use the projector with the lamp cover removed.

Figure 11: Lamp Replacement

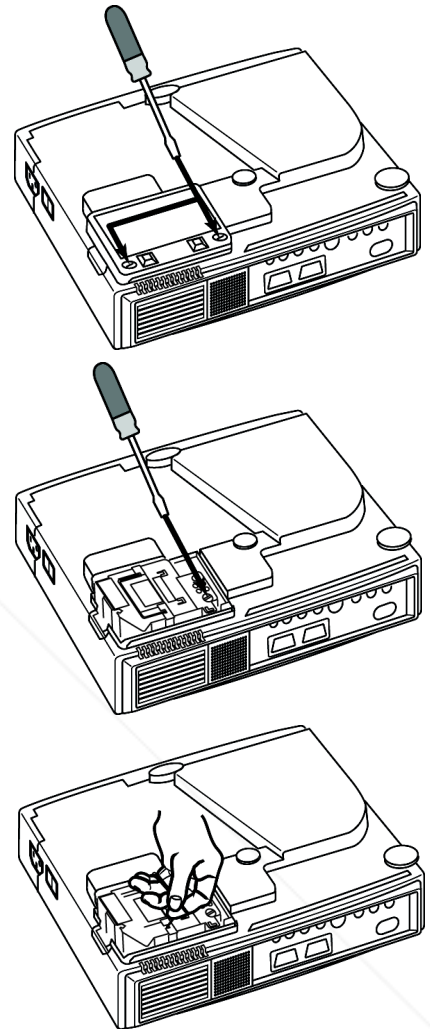

Resetting the Lamp Timer

After replacing the lamp, it is important that you reset the lamp timer. When the lamp has been replaced after the "THE POWER WILL TURN OFF AFTER 0hr." message is displayed, complete the following steps within 10 minutes of switching power ON. The power will be turned off automatically after 10 minutes.

- 1 Switch POWER ON.
- 2 From the OPTION menu select LAMP TIME with the description of "Adjusting the Projected Image".
- 3 Press the RESET button and hold for approximately 3 seconds. The DEFAULT and CANCEL options will display.
- 4 Press the Up arrow button to select the DEFAULT. The remaining lamp life is now reset to 2000 hours.

IMPORTANT: Do not reset the lamp timer without replacing the lamp. The message functions will not operate properly if the lamp timer is not reset correctly.

Air-Filter

Cleaning the Air Filter

The air filter should be cleaned as described below at intervals of approximately 100 hours. When the filter is used for approximately 100 hours, the message "CLEAN THE AIR FILTER" appears when the projector is switched on.

- 1 Switch the projector power supply OFF, and remove the power cord from the power outlet.
- 2 Clean the air filter with a vacuum cleaner.
- 3 Reset the Filter Timer using the function of the FILTER TIME on the OPTION Menu. Please refer to the description of the "FILTER TIME" on the Table 9: MAIN Menu.

Replacing the Air Filter

Replace the air filter if contamination cannot be removed, or if it is damaged. To order a new air filter see page 26 for contact information.

- 1 Switch the projector power OFF, and remove the power cord from the power outlet.
- 2 Remove the filter cover and the filter.
- 3 Replace the new air-filter and the filter cover.
- 4 Reset the Filter Timer using the function of the FILTER TIME on the OPTION Menu. Refer to the description of the "FILTER TIME" on Table 9: MAIN Menu.



CAUTION

- Switch POWER OFF and remove the power cord from the power outlet before beginning maintenance work.
- Replace the air filter if contamination cannot be removed, or if it is damaged.
- Do not use the projector with the air filter removed.
- When the air filter is clogged, the power supply is switched OFF automatically to prevent overheating.

Maintenance Inside the Equipment

For safety reasons, ensure that the equipment is cleaned and checked by the dealer once every two years. Maintaining the equipment by yourself is dangerous.

Cleaning the Lens

Gently wipe the lens with lens cleaning paper. Do not touch the lens with your hands.

Cleaning the Cabinet and Remote Control

Gently wipe with a soft cloth. If dirt and stains are not easily removed, use a soft cloth dampened with water, or water and a neutral detergent, and wipe dry with a soft, dry cloth.



CAUTION

- Switch POWER OFF and remove the power cord from the power outlet before beginning maintenance work.
- Make sure the lens is cool before cleaning.
- Do not use detergents or chemicals other than those noted above. Do not use benzene or thinners.
- Do not use chemical sprays.
- Use a soft cloth or lens paper only.

Troubleshooting

OSD Messages

The messages as described below may appear on the screen at POWER ON. Take the appropriate measures when such messages appear.

Table 10: OSD Messages

Screen Message	Meaning or Action Required
CHANGE THE LAMP. AFTER REPLACING LAMP, RESET THE LAMP TIME. ¹	The lamp will reach the end of its life in 300 hours. POWER is switched off automatically when the lamp reaches the end of its life. prepare a new lamp for installation. Always reset the lamp timer after replacing the lamp.
CHANGE THE LAMP. AFTER REPLACING LAMP, RESET THE LAMP TIME. THE POWER WILL TURN OFF AFTER ** HR. ¹	The lamp will reach the end of its life in ** hours. POWER will be switched OFF automatically in ** hours. Replace the lamp as shown in "Replacing the Lamp" on page 19. Always reset the lamp timer after replacing the lamp.
CHANGE THE LAMP. AFTER REPLACING LAMP, RESET THE LAMP TIME. THE POWER WILL TURN OFF AFTER 0 HR.	The lamp has reached the end of its life. POWER will be switched OFF in a few minutes. Switch POWER OFF immediately and replace the lamp as shown in "Replacing the Lamp" on page 19. Always reset the lamp timer after replacing the lamp.
NO INPUT IS DETECTED ON ***	No input signal found. Check signal input connections and signal sources.
SYNC IS OUT OF RANGE ON ***	The horizontal or vertical frequency of the input signal is not within the specified range. Check the specifications of the equipment and the signal source.
CHECK THE AIR FLOW	The internal temperature has risen. Switch POWER OFF, and wait 20 minutes until the equipment cools. Check the following and switch POWER ON again. <ul style="list-style-type: none"> • Are the ventilation openings blocked? • Is the air filter dirty? • Is the ambient temperature in excess of 95°F (35°C)?

¹ This message is cleared automatically after approximately three minutes, and appears every time POWER is switched ON.

Indicator Messages

The POWER indicator, LAMP indicator, and TEMP indicator are either lit, unlit or blinking as explained in the table below.

Table 11: Indicator Messages

POWER indicator	LAMP indicator	TEMP indicator	Meaning or Action Required
Lights orange	Turns off	Turns off	The Standby mode has been set.
Blinks green	Turns off	Turns off	Warming up. Please wait.
Lights green	Turns off	Turns off	ON. Normal operation possible.
Blinks orange	Turns off	Turns off	Cooling. Please wait.
Blinks red	-	-	Cooling. Please wait. The error is found. Take the appropriate measures when the POWER indicator ceases blinking.

Table 11: Indicator Messages (Continued)

POWER indicator	LAMP indicator	TEMP indicator	Meaning or Action Required
Blinks/ Lights red	Lights red	Turns off	Lamp is not lit. The interior of the equipment may be too hot. Switch POWER OFF, wait 20 minutes until the equipment cools, and check whether the ventilation openings are blocked, whether the air filter is dirty, or whether the ambient temperature exceeds 95°F (35°C). And switch POWER ON again. Replace the lamp if the same problem occurs again.
Blinks/ Lights red	Blinks red	Turns off	Lamp or lamp cover is not found, or hasn't been fitted in correctly. Switch POWER OFF, and wait for 45 minutes until the equipment cools. Check fitting of the lamp and lamp cover, and switch POWER ON again. Contact your dealer if the same problem occurs again.
Blinks/ Lights red	Turns off	Blinks red	The cooling fan is not operating. Switch POWER OFF, and wait for 20 minutes until the equipment cools. Check for foreign matter in the fan, and switch POWER ON again. Contact your dealer if the same problem occurs again.
Blinks/ Lights red	Turns off	Lights red	The interior of the equipment is too hot. See NOTE: (about overheating) below. Switch POWER OFF, and wait for 20 minutes until the equipment cools. Check whether the ventilation openings are blocked., whether the air filter is dirty, or whether the ambient temperature exceeds 95°F (35°C). Then switch POWER ON again. Contact your dealer if the same problem occurs again.
Lights green	Blinks red alternately with TEMP indicator	Blinks red alternately with LAMP indicator	The interior of the equipment is too cool. Check whether the ambient temperature is below 32°F (0°C). Contact your dealer if the same problem occurs when the ambient temperature is 32°F ~ 95°F (0°C ~ 35°C).
Lights green	Blinks red synchronizing with TEMP indicator	Blinks red synchronizing with LAMP indicator	The air-filter has been used for 100 hours or more. Clean the filter, then reset the filter timer.

NOTE: (about overheating) When the internal temperature rises too high, POWER to the unit switches OFF as a safety precaution; the LED lamp indicator turns OFF. Set the POWER switch to [0] and wait 20 minutes until the equipment has cooled sufficiently before continuing with operation.



Symptom

Before requesting repair, refer to the chart below. If the problem cannot be corrected, contact your dealer.

Table 12: Symptom

Symptom	Possible cause	Remedy	Page
No power	The main POWER switch is not turned on.	Turn on the main POWER switch.	page 9
	The power cord is disconnected.	Plug the power cord into an AC power outlet.	page 7
No video or audio	The Input is not correctly set.	Use INPUT button on projector control pad or remote control to select input source.	page 10
	No signal input.	Connect correctly.	page 7,8

Table 12: Symptom (Continued)

Symptom	Possible cause	Remedy	Page
Video is present but no audio	The projector is not correctly connected.	Connect correctly.	page 7 page 8
	The volume is set to minimum.	Press VOLUME  button on the remote control or display the menu screen and adjust the volume.	
	Mute is turned on.	Press the MUTE  button.	page 10
Audio is present but no video	The projector is not correctly connected.	Connect correctly.	page 7 page 8
	The brightness is set to minimum.	Select BRIGHT and CONTRAST with the MENU button and press the  button.	page 12
Colors are pale and color matching is poor	Color density and color matching are not correctly adjusted.	Go to PICTURE-1 menu and adjust color parameters.	page 13
Images are dark	Brightness and contrast are not correctly adjusted.	Go to MAIN menu and adjust COLOR and BRIGHTNESS. Go to PICTURE-1 menu and adjust color parameters.	page 12 page 13
	The lamp is nearing the end of its service life.	Replace lamp.	page 19
Images are blurred	Focus or H PHASE is out of adjustment.	Adjust the focus or H PHASE. Adjust focus with Focus Ring.	page 14 page 3

Specifications

PJ500/PJ501 Technical Specifications

Table 13: PJ500/PJ501 Specifications

Item	Specification
Liquid crystal panel Panel Size Pixels	0.7 inch P-Si TFT x3 800 horizontal x 600 vertical, 8 bit color, 16.7 Million colors
Lens	Manual Zoom F=2.0 - 2.3 f=17.7 -21.2 mm Zoom 1.2 : 1, manual focus
Projection Distance	0.9 - 9.0 Meters
Display Size	30 - 300 inches
Keystone Correction	6:1 upward shift (fixed)
Lamp	150 W UHB (normal mode); 130 W UHB (whisper mode)
Speaker	1.0 W
Power Supply	AC 100 ~ 120V, 2.7A AC220 - 240V,1.3A
Power consumption	240 W
Battery type	AA battery x2
Temperature range	0 ~ 35°C (Operating)
Size	11.4" (W) x 3.3" (H) x 8.3" (D) inches 289 (W) x 83 (H) x 210 (D) mm
Weight	5.4 lbs. (2.4 kg)
Horizontal Scan Frequency	31 - 91 KHz (PC mode) 15 KHz (video mode)
Vertical Scan Frequency	56 - 120 KHz (PC mode) 50 KHz (video mode)
Computer Compatibility Computer RGB IN (RGB signal input) Plug & Play AUDIO IN	PC compatible for VGA, SVGA, XGA, and SXGA. Video: Analog 0.7 Vp-p, 75 ohm terminator (positive), HV. sync.: TTL level (positive/negative), Composite sync.: TTL level, D-sub 15-pin shrink jack Native resolution 1024 x 768 DDC 1/28 (VESA) 200m Vrms, 47 k ohms (max. 3.0Vp-p), Stereo mini jack
Video signal input VIDEO (Composite) S-VIDEO COMPONENT VIDEO AUDIO	1.0 Vp-p, 75 ohm terminator, RCA jack NTSC, NTSC4.43, PAL (BGDHI), SECAM, PAL-M, PAL-N, PAL60 Brightness signal: 1.0 Vp-p, 75 ohm terminator, Color signal: 0.3 Vp-p (burst signal), 75 ohm terminator, Mini DIN 4-pin jack 480i, 575i, 1080i, 720i Y 1.0 Vp-p, 75 ohm Terminator (Positive) CB/CR 0.7 Vp-p, 75 ohm Terminator (Positive) PB/PR 0.7 Vp-p, 75 ohm Terminator (Positive) L 200 m Vrms, 47 k ohms (max. 3.0 Vp-p) R RCA jack
Control functions CONTROL	D-sub 15-pin shrink plug (RS232)



FixYourDLP.com
Sponsored by DM

Discount-Merchant.com (800) 281-8860
THE TRUSTED SOURCE FOR PROJECTOR LAMPS AND ACCESSORIES

PJ550/PJ551 Technical Specifications

Table 14: PJ550/PJ551 Specifications

Item	Specification	
Liquid crystal panel Panel Size Pixels	0.7 inch P-Si TFT with microlens 1024 horizontal x 768 vertical, 8 bit color, 16.7 Million colors	
Lens	Manual Zoom F=2.0 - 2.3 f=17.7 -21.2 mm Zoom 1.2 : 1, manual focus	
Projection Distance	0.9 - 9.0 Meters	
Display Size	30 - 300 inches	
Keystone Correction	6:1 upward shift (fixed)	
Lamp	150 W UHB (normal mode); 130 W UHB (whisper mode)	
Speaker	1.0 W	
Power Supply	AC 100 ~ 120V, 2.7A AC220 - 240V,1.3A	
Power consumption	240 W	
Battery type	AA battery x2	
Temperature range	0 ~ 35°C (Operating)	
Size	11.4" (W) x 3.3" (H) x 8.3" (D) inches 289 (W) x 83 (H) x 210 (D) mm	
Weight	5.4 lbs. (2.4 kg)	
Horizontal Scan Frequency	31 - 91 KHz (PC mode) 15 KHz (video mode)	
Vertical Scan Frequency	56 - 120 KHz (PC mode) 50 KHz (video mode)	
Computer Compatibility Computer (RGB signal input) Plug & Play	PC compatible for VGA, SVGA, XGA, and SXGA. Video: Analog 0.7 Vp-p, 75 ohm terminator (positive), HV. sync.: TTL level (positive/negative), Composite sync.: TTL level, D-sub 15-pin shrink jack Native resolution 1024 x 768 DDC 1/28 (VESA) 200m Vrms, 47 k ohms (max. 3.0Vp-p), Stereo mini jack	
Video signal input	VIDEO (Composite) S-VIDEO COMPONENT VIDEO AUDIO	1.0 Vp-p, 75 ohm terminator, RCA jack NTSC, NTSC4.43, PAL (BGDHI), SECAM, PAL-M, PAL-N, PAL60 Brightness signal: 1.0 Vp-p, 75 ohm terminator, Color signal: 0.3 Vp-p (burst signal), 75 ohm terminator, Mini DIN 4-pin jack 480i, 575i, 1080i, 720i Y 1.0 Vp-p, 75 ohm Terminator (Positive) CB/CR 0.7 Vp-p, 75 ohm Terminator (Positive) PB/PR 0.7 Vp-p, 75 ohm Terminator (Positive) L 200 m Vrms, 47 k ohms (max. 3.0 Vp-p) R RCA jack
Control functions	CONTROL D-sub 15-pin shrink plug (RS232)	



Discount-Merchant.com (800) 281-8860
THE TRUSTED SOURCE FOR PROJECTOR LAMPS AND ACCESSORIES

Customer Support

For technical support or product service, see the table below or contact your reseller.

NOTE: You will need the product serial number.

Country/Region	Web site	T = Telephone F = FAX	Email
United States	viewsonic.com/ support	T: (800) 688-6688 F: (909) 468-1202	service.us@ viewsonic.com
Canada	viewsonic.com/ support	T: (800) 688-6688 F: (909) 468-1202	service.ca@ viewsonic.com
United Kingdom	viewsoniceurope.com	T: 0800 833 648 F: (01293) 643910	service.eu@ viewsoniceurope.com
Europe, Middle East, Baltic countries, and North Africa	viewsoniceurope.com	Contact your reseller	service.eu@ viewsoniceurope.com
Australia and New Zealand	viewsonic.com.au	T: +61 2 9929 3955 F: +61 2 9929 8393	service.au@ viewsonic.com
Singapore/India and Southeast Asia	viewsonic.com.sg	T: 65 273 4018 F: 65 273 1566	service.sg@ viewsonic.com
Other Asia/Pacific countries	viewsonic.com.tw	T: 886 2 2246 3456 F: 886 2 8242 3668	service.ap@ viewsonic.com
South Africa	viewsonic.com/asia	T: 886 2 2246 3456 F: 886 2 8242 3668	service.ap@ viewsonic.com

Table 15: Optional Parts

Part	Ordering Specifications									
Lamp Replacement	<table border="1"> <tr> <td>PJ500</td> <td>PJ501</td> <td>PJ550</td> <td>PJ551</td> <td rowspan="2">To order parts contact your dealer or ViewSonic.</td> </tr> <tr> <td>RLU-150-001</td> <td>RLU-150-001</td> <td>RLC-150-003</td> <td>RLC-150-003</td> </tr> </table>	PJ500	PJ501	PJ550	PJ551	To order parts contact your dealer or ViewSonic.	RLU-150-001	RLU-150-001	RLC-150-003	RLC-150-003
PJ500	PJ501	PJ550	PJ551	To order parts contact your dealer or ViewSonic.						
RLU-150-001	RLU-150-001	RLC-150-003	RLC-150-003							
Air Filter Replacement	To order parts contact your dealer or ViewSonic.									
Slot for Kensington lock	To order parts contact your dealer or ViewSonic.									



Discount-Merchant.com (800) 281-8860
THE TRUSTED SOURCE FOR PROJECTOR LAMPS AND ACCESSORIES

LIMITED WARRANTY

VIEWSONIC PROJECTOR

What the warranty covers:

ViewSonic® warrants its products to be free from defects in material and workmanship during the warranty period. If a product proves to be defective in material or workmanship during the warranty period, **ViewSonic** will at its sole option repair or replace the product with a like product. Replacement product or parts may include remanufactured or refurbished parts or components.

How long the warranty is effective:

ViewSonic projectors are warranted for three (3) years for all parts excluding the lamp and three (3) years for all labor from the date of the first consumer purchase. Projector lamps are warranted separately.

Who the warranty protects:

This warranty is valid only for the first consumer purchaser.

What the warranty does not cover:

1. Any product on which the serial number has been defaced, modified or removed.
2. Damage, deterioration or malfunction resulting from:
 - a. Accident, misuse, neglect, fire, water, lightning, or other acts of nature, unauthorized product modification, or failure to follow instructions supplied with the product.
 - b. Repair or attempted repair by anyone not authorized by **ViewSonic**.
 - c. Any damage of the product due to shipment.
 - d. Removal or installation of the product.
 - e. Causes external to the product, such as electric power fluctuations or failure.
 - f. Use of supplies or parts not meeting **ViewSonic's** specifications.
 - g. Normal wear and tear.
 - h. Any other cause which does not relate to a product defect.
3. Removal, installation, and set-up service charges.

How to get service:

1. For information about receiving service under warranty, contact **ViewSonic Customer Support**. You will need to provide your product's serial number.
2. To obtain warranted service, you will be required to provide (a) the original dated sales slip, (b) your name, (c) your address, (d) a description of the problem, and (e) the serial number of the product.
3. Take or ship the product freight prepaid in the original container to an authorized **ViewSonic** service center or **ViewSonic**.
4. For additional information or the name of the nearest **ViewSonic** service center, contact **ViewSonic**.

Limitation of implied warranties:

THERE ARE NO WARRANTIES, EXPRESS OR IMPLIED, WHICH EXTEND BEYOND THE DESCRIPTION CONTAINED HEREIN INCLUDING THE IMPLIED WARRANTY OF MERCHANTABILITY AND FITNESS FOR A PARTICULAR PURPOSE.

Exclusion of damages:

VIEWSONIC'S LIABILITY IS LIMITED TO THE COST OF REPAIR OR REPLACEMENT OF THE PRODUCT. **VIEWSONIC** SHALL NOT BE LIABLE FOR:

1. DAMAGE TO OTHER PROPERTY CAUSED BY ANY DEFECTS IN THE PRODUCT, DAMAGES BASED UPON INCONVENIENCE, LOSS OF USE OF THE PRODUCT, LOSS OF TIME, LOSS OF PROFITS, LOSS OF BUSINESS OPPORTUNITY, LOSS OF GOODWILL, INTERFERENCE WITH BUSINESS RELATIONSHIPS, OR OTHER COMMERCIAL LOSS, EVEN IF ADVISED OF THE POSSIBILITY OF SUCH DAMAGES.
2. ANY OTHER DAMAGES, WHETHER INCIDENTAL, CONSEQUENTIAL OR OTHERWISE.
3. ANY CLAIM AGAINST THE CUSTOMER BY ANY OTHER PARTY.

Effect of state law:

This warranty gives you specific legal rights, and you may also have other rights which vary from state to state. Some states do not allow limitations on implied warranties and/or do not allow the exclusion of incidental or consequential damages. So the above limitations and exclusions may not apply to you.

Sales outside the U.S.A. and Canada:

For warranty information and service on **ViewSonic** products sold outside of the U.S.A. and Canada, contact **ViewSonic** or your local **ViewSonic** dealer.

Appendix

Power Cord Safety Guidelines

Caution: Use a power cable that is properly grounded. Always use an AC power cord that meets your country's safety standard.

USA.....	UL	Switzerland	SEV
Canada.....	CSA	Britain.....	BASE/BS
Germany.....	VDE	Japan	Electric Appliance Control Act

AC PLUG CORD PRECAUTIONS FOR THE UNITED KINGDOM

FOR YOUR SAFETY PLEASE READ THE FOLLOWING TEXT CAREFULLY.

IF THE FITTED MOULDED PLUG IS UNSUITABLE FOR THE SOCKET OUTLET THEN THE PLUG SHOULD BE CUT OFF AND DISPOSED OF SAFELY.

THERE IS A DANGER OF SEVERE ELECTRICAL SHOCK IF THE CUT OFF PLUG IS INSERTED INTO AN APPROPRIATE SOCKET.

If a new plug is to be fitted, please observe the wiring code as shown below.

If in any doubt, please consult a qualified electrician.

WARNING: THIS APPLIANCE MUST BE EARTHED.

IMPORTANT: The wires in this mains lead are coloured in accordance with the following code:

Green-and-Yellow:	Earth
Blue:	Neutral
Brown:	Live

If the coloured wires of the mains lead of this appliance do not correspond with the coloured markings identifying the terminals in your plug, proceed as follows:

The wire which is coloured GREEN-AND-YELLOW must be connected to the terminal in the plug which is marked by the letter E or by the Earth symbol or coloured GREEN or GREEN-AND-YELLOW.

The wire which is coloured BLUE must be connected to the terminal in the plug which is marked with the letter N or coloured BLACK. The wire which is coloured BROWN must be connected to the terminal in the plug which is marked with the letter L or coloured RED.

IMPORTANT NOTICE CONCERNING POWER CORD SELECTION

The power cord set for this unit has been enclosed and has been selected according to the country of destination and must be used to prevent electric shock. Use the following guidelines if it is necessary to replace the original cord set, or if the cord set is not enclosed.

The female receptacle of the cord set must meet CEE-22 requirements and may look like (Figure A1 below):

Figure 1 

For the United States and Canada

In the United States and Canada the male plug is a NEMA5-15 style (Figure A2), UL Listed, and CSA Labeled. For units which are mounted on a desk or table, type SVT or SJT cord sets may be used. For units which sit on the floor, only SJT type cord sets may be used. The cord set must be selected according to the current rating for your unit. Please consult the table below for the selection criteria for power cords used in the United States and Canada.

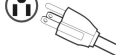
Figure 2 

Cord Type	Size of Conductors in Cord	Maximum Current Rating of Unit
SJT <small>Sponsored by DLP</small>	18 AWG	10 Amps
	16 AWG	12 Amps
	14 AWG	12 Amps
SVT	18 AWG	10 Amps
	17 AWG	12 Amps

For European Countries

In Europe you must use a cord set which is appropriate for the receptacles in your country. The cord set is HAR-Certified, and a special mark that will appear on the outer sheath, or on the insulation of one of the inner conductors.

If you have any questions concerning which proper power cord to use, please consult with the dealer from whom you have purchased the product.

Compliance Information for U.S.A.

This equipment has been tested and found to comply with the limits for a Class B digital device, pursuant to part 15 of the FCC Rules. These limits are designed to provide reasonable protection against harmful interference in a residential installation. This equipment generates, uses, and can radiate radio frequency energy, and if not installed and used in accordance with the instructions, may cause harmful interference to radio communications. However, there is no guarantee that interference will not occur in a particular installation. If this equipment does cause harmful interference to radio or television reception, which can be determined by turning the equipment off and on, the user is encouraged to try to correct the interference by one or more of the following measures:

- Reorient or relocate the receiving antenna.
- Increase the separation between the equipment and receiver.
- Connect the equipment into an outlet on a circuit different from that to which the receiver is connected.
- Consult the dealer or an experienced radio/TV technician for help.

FCC Warning

To assure continued FCC compliance, the user must use grounded power supply cord and the provided shielded video interface cable with bonded ferrite cores. If a BNC cable is going to be used, use only a shielded BNC(5) cable. Also, any unauthorized changes or modifications not expressly approved by the party responsible for compliance could void the user's authority to operate this device.

Instructions to Users

This equipment complies with the requirements of FCC (Federal Communication Commission) equipment provided that the following condition is met. **Use the cables which are included with the projector or specified.**

Compliance Information for Canada

Notice: This class B digital apparatus complies with Canadian ICES-003.

AVIS: Cet appareil numérique de la Classe B conforme a la norme NMB-003 du Canada.

Compliance Information for European Countries

CE Conformity



The device complies with the requirements of the EEC directive 89/336/EEC as amended by 92/31/EEC and 93/68/EEC Art.5 with regard to "Electromagnetic compatibility," and 73/23/EEC as amended by 93/68/EEC Art.13 with regard to "Safety."

User Information for all Countries

NOTICE: Use the cables which are included with the projector or specified.



Discount-Merchant.com (800) 281-8860
THE TRUSTED SOURCE FOR PROJECTOR LAMPS AND ACCESSORIES



Disclaimer

This user manual is provided as a free service by FixYourDLP.com. FixYourDLP is in no way responsible for the content of this manual, nor do we guarantee its accuracy. FixYourDLP does not make any claim of copyright and all copyrights remain the property of their respective owners.

About FixYourDLP.com

FixYourDLP.com (<http://www.fixyourdlp.com>) is the World's #1 resource for media product news, reviews, do-it-yourself guides, and manuals.

Informational Blog: <http://www.fixyourdlp.com>

Video Guides: <http://www.fixyourdlp.com/guides>

User Forums: <http://www.fixyourdlp.com/forum>

FixYourDLP's Fight Against Counterfeit Lamps:

<http://www.fixyourdlp.com/counterfeits>

Sponsors:

RecycleYourLamp.org – Free lamp recycling services for used lamps:

<http://www.recycleyourlamp.org>

Lamp Research - The trusted 3rd party lamp research company:

<http://www.lampresearch.com>

Discount-Merchant.com – The worlds largest lamp distributor:

<http://www.discount-merchant.com>



FixYourDLP.com

Sponsored by 