



Disclaimer

This user manual is provided as a free service by FixYourDLP.com. FixYourDLP is in no way responsible for the content of this manual, nor do we guarantee its accuracy. FixYourDLP does not make any claim of copyright and all copyrights remain the property of their respective owners.

About FixYourDLP.com

FixYourDLP.com (<http://www.fixyourdpl.com>) is the World's #1 resource for media product news, reviews, do-it-yourself guides, and manuals.

Informational Blog: <http://www.fixyourdpl.com>

Video Guides: <http://www.fixyourdpl.com/guides>

User Forums: <http://www.fixyourdpl.com/forum>

FixYourDLP's Fight Against Counterfeit Lamps:

<http://www.fixyourdpl.com/counterfeits>

Sponsors:

RecycleYourLamp.org – Free lamp recycling services for used lamps:

<http://www.recycleyourlamp.org>

Lamp Research - The trusted 3rd party lamp research company:

<http://www.lampresearch.com>

Discount-Merchant.com – The worlds largest lamp distributor:

<http://www.discount-merchant.com>



FixYourDLP.com

Sponsored by 

Panasonic®

LCD Projector

ENGLISH

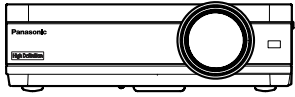

Operating Instructions

Model No. **PT-AE500U**



Before operating this product, please read the instructions carefully and save this manual for future use.

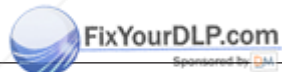

For assistance, please call : 1-888-View-PTV(843-9788)
or send e-mail to : consumerproducts@panasonic.com
or visit us at www.panasonic.com

For assistance, please call : 787-750-4300
or visit us at www.panasonic.co.jp/global/ (Puerto Rico)

Merchant.com (800) 281-8860
THE TRUSTED SOURCE FOR PROJECTOR LAMPS AND ACCESSORIES

Dear Panasonic Customer:

This instruction booklet provides all the necessary operating information that you might require. We hope it will help you to get the most out of your new product, and that you will be pleased with your Panasonic LCD projector. The serial number of your product may be found on its back. You should note it in the space provided below and retain this booklet in case service is required.

Model number: **PT-AE500U**

Serial number: _____

IMPORTANT SAFETY NOTICE

WARNING: TO REDUCE THE RISK OF FIRE OR ELECTRIC SHOCK, DO NOT EXPOSE THIS PRODUCT TO RAIN OR MOISTURE.

Power Supply: This LCD Projector is designed to operate on 100 V – 240 V, 50 Hz/60 Hz AC, house current only.

CAUTION: The AC power cord which is supplied with the projector as an accessory can only be used for power supplies up to 125 V, 7 A. If you need to use higher voltages or currents than this, you will need to obtain a separate 250 V power cord. If you use the accessory cord in such situations, fire may result.



The lightning flash with arrowhead symbol, within an equilateral triangle, is intended to alert the user to the presence of uninsulated "dangerous voltage" within the product's enclosure that may be of sufficient magnitude to constitute a risk of electric shock to persons.



The exclamation point within an equilateral triangle is intended to alert the user to the presence of important operating and maintenance (servicing) instructions in the literature accompanying the product.

CAUTION: This equipment is equipped with a three-pin grounding-type power plug. Do not remove the grounding pin on the power plug. This plug will only fit a grounding-type power outlet. This is a safety feature. If you are unable to insert the plug into the outlet, contact an electrician. Do not defeat the purpose of the grounding plug.

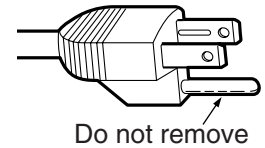

WARNING:

This equipment has been tested and found to comply with the limits for a Class B digital device, pursuant to Part 15 of the FCC Rules. These limits are designed to provide reasonable protection against harmful interference in a residential installation. This equipment generates, uses, and can radiate radio frequency energy and, if not installed and used in accordance with the instructions, may cause harmful interference to radio communications. However, there is no guarantee that interference will not occur in a particular installation. If this equipment does cause harmful interference to radio or television reception, which can be determined by turning the equipment off and on, the user is encouraged to try to correct the interference by one or more of the following measures:

- Reorient or relocate the receiving antenna.
- Increase the separation between the equipment and receiver.
- Connect the equipment into an outlet on a circuit different from that to which the receiver is connected.
- Consult the dealer or an experienced radio/TV technician for help.

FCC CAUTION: To assure continued compliance, use only shielded interface cables when connecting to computers or peripheral devices.

Any unauthorized changes or modifications to this equipment will void the users authority to operate.

WARNING:

Not for use in a computer room as defined in the Standard for the Protection of Electronic Computer/Data Processing Equipment, ANSI/NFPA 75.

Declaration of Conformity

Model Number: PT-AE500U

Trade Name: **Panasonic**

Responsible party: Matsushita Electric Corporation of America.

Address: One Panasonic Way Secaucus New Jersey 07094

Telephone number: 1-888-View-PTV(843-9788)

This device complies with Part 15 of the FCC Rules, Operation is subject to the following two conditions: (1) This device may not cause harmful interference, and (2) this device must accept any interference received, including interference that may cause undesired operation.

Contents

Preparation

IMPORTANT SAFETY NOTICE ...2

Precautions with regard to safety5

Accessories9

Before use9

Location and function of each part.....11

Getting started

Setting-up16

Projection methods, Projector position, Projection distances

Connections18

Connecting to video equipment, Connecting to equipment compatible with YPbPr (CbCr) signals,

Connecting to computer

Preparation for the remote control unit.....21

Basic operation

Turning on the power22

Turning off the power.....24

Useful functions

Correcting keystone distortion...26

Selecting the picture mode.....27

Setting the aspect ratio28

Turning on the button lights.....30

Pausing a picture.....30

Retrieving the saved picture settings.....31

Adjustments and settings

On-screen menus32

Menu screens, Menu operation guide, Returning a setting to the factory default

Adjusting the picture.....36

PICTURE MODE, CONTRAST, BRIGHT, COLOR, TINT, SHARPNESS, COLOR TEMP., AI, ADVANCE MENU, MEMORY SAVE, MEMORY LOAD,

TV-SYSTEM, SIGNAL MODE, Projecting sRGB-compatible pictures

Adjusting the position.....40

Horizontal position, Vertical position, DOT CLOCK, CLOCK PHASE, ASPECT,AUTO SETUP

Turning off the picture momentarily (SHUTTER).....41

Changing the display language...41

Option settings42

OSD, Noise Reduction (NR), PC PRIORITY, BACK COLOR, EDID, FRONT/REAR, DESK/CEILING, FAN CONTROL, LAMP POWER, LAMP RUNTIME

Care and maintenance

When the TEMP indicator and the LAMP indicator are illuminated...44

Cleaning and replacing the air filter46

Replacing the lamp unit47

Before calling for service.....50

Cleaning and maintenance51

Others

Specifications52

Appendix54

List of compatible signals, Connector pin wiring, Projection dimensions calculation methods

Dimensions57

Trademark acknowledgements...58



Discount-Merchant.com (800) 231-5800
THE TRUSTED SOURCE FOR PROJECTOR LAMPS AND ACCESSORIES

Precautions with regard to safety

WARNING

If a problem occurs (such as no image or no sound) or if you notice smoke or a strange smell coming from the projector, turn off the power and disconnect the power cord from the wall outlet.

- Do not continue to use the projector in such cases, otherwise fire or electric shocks could result.
- Check that no more smoke is coming out, and then contact an Authorized Service Center for repairs.
- Do not attempt to repair the projector yourself, as this can be dangerous.

Do not install this projector in a place which is not strong enough to take the full weight of the projector.

- If the installation location is not strong enough, it may fall down or tip over, and severe injury or damage could result.

Installation work (such as ceiling suspension) should only be carried out by a qualified technician.

- If installation is not carried out correctly, there is the danger that injury or electric shocks may occur.

If foreign objects or water get inside the projector, or if the projector is dropped or the cabinet is broken, turn off the power and disconnect the power cord from the wall outlet.

- Continued use of the projector in this condition may result in fire or electric shocks.
- Contact an Authorized Service Center for repairs.

Do not overload the wall outlet.

- If the power supply is overloaded (for example, by using too many adapters), overheating may occur and fire may result.

Do not remove the cover or modify it in any way.

- High voltages which can cause fire or electric shocks are present inside the projector.
- For any inspection, adjustment and repair work, please contact an Authorized Service Center.

Clean the power cord plug regularly to prevent it from becoming covered in dust.

- If dust builds up on the power cord plug, the resulting humidity can damage the insulation, which could result in fire. Pull the power cord out from the wall outlet and wipe it with a dry cloth.
- If not using the projector for an extended period of time, pull the mains plug out from the wall outlet.

Do not do anything that might damage the power cord or the power cord plug.

- Do not damage the power cord, make any modifications to it, place it near any hot objects, bend it excessively, twist it, pull it, place heavy objects on top of it or wrap it into a bundle.
- If the power cord is used while damaged, electric shocks, short-circuits or fire may result.
- Ask an Authorized Service Center to carry out any repairs to the power cord that might be necessary.

Do not handle the power cord plug with wet hands.

- Failure to observe this may result in electric shocks.

Insert the power cord plug securely into the wall outlet.

- If the plug is not inserted correctly, electric shocks or overheating could result.
- Do not use plugs which are damaged or wall outlets which are coming loose from the wall.

Do not place the projector on top of surfaces which are unstable.

- If the projector is placed on top of a surface which is sloped or unstable, it may fall down or tip over, and injury or damage could result.

Do not place the projector into water or let it become wet.

- Failure to observe this may result in fire or electric shocks.

Do not place liquid containers on top of the projector.

- If water spills onto the projector or gets inside it, fire or electric shocks could result.
- If any water gets inside the projector, contact an Authorized Service Center.

Do not insert any foreign objects into the projector.

- Do not insert any metal objects or flammable objects into the projector or drop them onto the projector, as doing so can result in fire or electric shocks.

Keep the batteries out of the reach of infants.

- If the batteries are swallowed, death by suffocation may result. If you believe that the batteries may have been swallowed, seek medical advice immediately.

Do not allow the + and - terminals of the batteries to come into contact with metallic objects such as necklaces or hairpins.

- Failure to observe this may cause the batteries to leak, overheat, explode or catch fire.
- Store the batteries in a plastic bag and keep them away from metallic objects.

During a thunderstorm, do not touch the projector or the cable.

- Electric shocks can result.

Do not use the projector in a bath or shower.

- Fire or electric shocks can result.

Do not look into the lens while the projector is being used.

- Strong light is emitted from the projector's lens. If you look directly into this light, it can hurt and damage your eyes.
- Be especially careful not to let young children look into the lens. In addition, turn off the power when you are away from the projector.

Do not place your hands or other objects close to the air outlet port.

- Heated air comes out of the air outlet port. Do not place your hands or face, or objects which cannot withstand heat close to this port, otherwise burns or damage could result.

Replacement of the lamp unit should only be carried out by a qualified technician.

- The lamp unit has high internal pressure. If improperly handled, explosion might result.
- The lamp unit can easily become damaged if struck against hard objects or dropped, and injury or malfunctions may result.

When replacing the lamp, allow it to cool for at least one hour before handling it.

- The lamp cover gets very hot, and contact with it can cause burns.

Before replacing the lamp, be sure to unplug the power cord from the wall outlet.

- Electric shocks or explosions can result if this is not done.

Caution**Do not cover the air inlet or the air outlet.**

- Doing so may cause the projector to overheat, which can cause fire or damage to the projector.
- Do not place the projector in narrow, badly ventilated places such as closets or bookshelves.

Do not set up the projector in humid or dusty places or in places where the projector may come into contact with smoke or steam.

- Using the projector under such conditions may result in fire or electric shocks.

When disconnecting the power cord, hold the plug, not the cord.

- If the power cord itself is pulled, the cord will become damaged, and fire, short-circuits or serious electric shocks may result.

Always disconnect all cables before moving the projector.

- Moving the projector with cables still attached can damage the cables, which could cause fire or electric shocks to occur.

Do not place any heavy objects on top of the projector.

- Failure to observe this may cause the projector to become unbalanced and fall, which could result in damage or injury.

Do not short-circuit, heat or disassemble the batteries or place them into water or fire.

- Failure to observe this may cause the batteries to overheat, leak, explode or catch fire, and burns or other injury may result.

When inserting the batteries, make sure the polarities (+ and -) are correct.

- If the batteries are inserted incorrectly, they may explode or leak, and fire, injury or contamination of the battery compartment and surrounding area may result.

Use only the specified batteries.

- If incorrect batteries are used, they may explode or leak, and fire, injury or contamination of the battery compartment and surrounding area may result.

Do not mix old and new batteries.

- If the batteries are inserted incorrectly, they may explode or leak, and fire, injury or contamination of the battery compartment and surrounding area may result.

Do not put your weight on this projector.

- You could fall or the projector could break, and injury may result.
- Be especially careful not to let young children climb onto the projector.

Disconnect the power cord plug from the wall outlet as a safety precaution before carrying out any cleaning.

- Electric shocks can result if this is not done.

Ask an Authorized Service Center to clean inside the projector at least once a year.

- If dust is left to build up inside the projector without being cleaned out, it can result in fire or problems with operation.
- It is a good idea to clean the inside of the projector before the season for humid weather arrives. Ask your nearest Authorized Service Center to clean the projector when required. Please discuss with the Authorized Service Center regarding cleaning costs.

We are constantly making efforts to preserve and maintain a clean environment. Please take non repairable units back to your dealer or a recycling company.

NOTICE:

- This product has a High Intensity Discharge (HID) lamp that contains a small amount of mercury. It also contains lead in some components. Disposal of these materials may be regulated in your community due to environmental considerations. For disposal or recycling information please contact your local authorities, or the Electronics Industries Alliance: <http://www.eiae.org>.

Accessories

Check that all of the accessories shown below have been included with your projector.

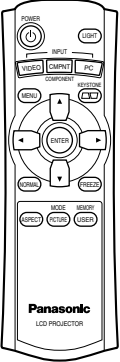
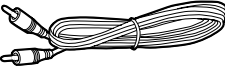
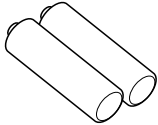
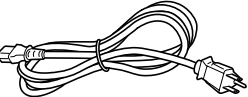
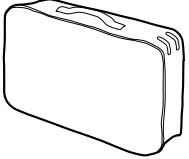
Remote control unit (N2QAEA000019 x1) 	Video cable [3.0 m (9'10"), K2KA2FA00003 x1] 	AAA batteries for remote control unit (x2) 
	Power cord (K2CG3FR00001 x 1) 	Carrying bag (TPEP008 x1) 

Before use

Cautions when moving the projector

Be sure to attach the lens cover before moving the projector.

The projection lens is extremely susceptible to vibration and shocks. When moving the projector, use the accessory carrying bag. When placing the projector inside the carrying bag, position it so that the lens is facing upward.

Cautions regarding setting-up

Avoid setting up in places which are subject to vibration or shocks.

The internal parts can be damaged, which may cause malfunctions or accidents.

Do not set up the projector near high-voltage power lines or near motors.

The projector may be subject to electromagnetic interference.

If installing the projector to the ceiling, ask a qualified technician to carry out all installation work.

You will need to purchase the separate installation kit (Model No.ET-PKE300). Furthermore, all installation work should only be carried out by a qualified technician.

If using this projector at high elevations (above 1 400 m), set the “FAN CONTROL” to “HIGH”. (Refer to page 43.)

Failure to observe this may result in malfunctions.

Notes on use

In order to get the best picture quality

Draw curtains or blinds over any windows and turn off any fluorescent lights near the screen to prevent outside light or light from indoor lamps from shining onto the screen.

Do not touch the surfaces of the lens with your bare hands.

If the surface of the lens becomes dirty from fingerprints or anything else, this will be magnified and projected onto the screen. Moreover, when not using the projector, retract the lens and then cover it with the accessory lens cover.

Screen

Do not apply any volatile substances which may cause discoloration to the screen, and do not let it become dirty or damaged.

Lamp

The lamp may need to be replaced earlier due to variables such as individual lamp characteristics, usage conditions and the installation environment, especially when the projector is subjected to continuous use for more than 10 hours or the power is frequently turned on and off.

Liquid crystal panel

- Do not project the same image for long periods of time, as this may remain as an afterimage on the liquid crystal panel.
- The liquid crystal panel of the projector is built with very high precision technology to provide fine picture details. Occasionally, a few non-active pixels may appear on the screen as fixed points of blue, green or red. Please note that this does not affect the performance of your LCD.

Location and function of each part

Projector <Top, right and front>

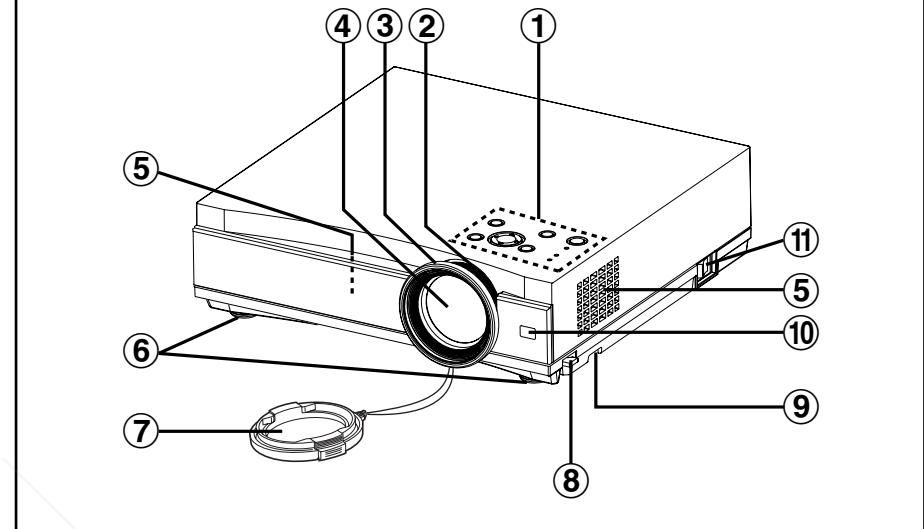

- ① **Projector control panel** (page 14)
- ② **Zoom ring** (page 23)
- ③ **Focus ring** (page 23)
- ④ **Projection lens**
- ⑤ **Air inlet ports**
Do not cover these ports.
- ⑥ **Front adjustable legs(L/R)** (page 23)
- ⑦ **Lens cover**
- ⑧ **Leg adjuster buttons(L/R)** (page 23)
These buttons are used to unlock the front adjustable legs. Press to adjust the angle of tilt of the projector.
- ⑨ **Air filter** (page 46)
- ⑩ **Remote control signal receptor** (page 21)
- ⑪ **MAIN POWER switch** (pages 22 and 24)



Discount-Merchant.com (800) 281-8860
THE TRUSTED SOURCE FOR PROJECTOR LAMPS AND ACCESSORIES

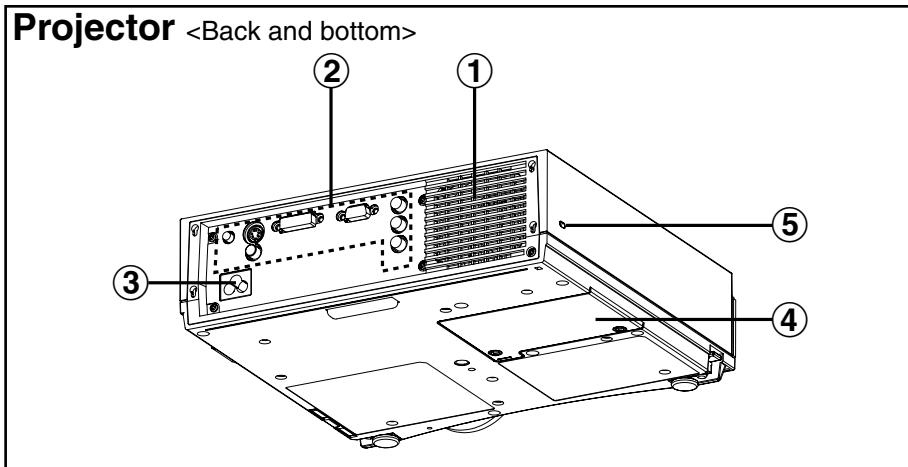

① Air outlet port

Do not cover this port.

② Connector panel (page 13)

③ Power input socket (AC IN) (page 22)

The accessory power cord is connected here. Do not use any power cord other than the accessory power cord.

④ Lamp unit holder (page 47)

⑤ Security lock

This can be used to connect a commercially-available theft-prevention cable (manufactured by Kensington). This security lock is compatible with the Microsaver Security System from Kensington.

WARNING

Do not place your hands or other objects close to the air outlet port.

- Heated air comes out of the air outlet port. Do not place your hands or face, or objects which cannot withstand heat close to this port, otherwise burns or damage could result.

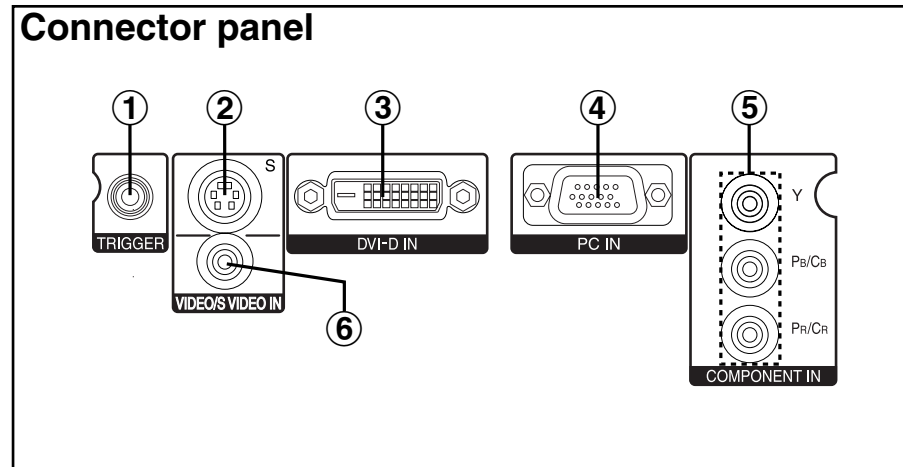

① TRIGGER output jack (pages 18, 19 and 20)

This jack outputs 12 V when the power is turned on. Connect this jack to equipment such as an electric screen.

② S-VIDEO input connector (page 18)

This connector is used to input signals from an S-VIDEO-compatible equipment such as a video deck.

③ DVI-D IN connector (page 20)

This connector is used to input DVI-D signals.

④ RGB input connector (page 20)

This connector is used to input RGB signals from a PC.

⑤ YPBPR(CbCr) input jacks(page 19)

These jacks are used to input YPBPR signals from compatible equipment such as a DVD player.

⑥ VIDEO input jack (page 18)

This jack is used to input video signals from a video equipment such as a video deck.



Discount-Merchant.com (800) 281-8860
THE TRUSTED SOURCE FOR PROJECTOR LAMPS AND ACCESSORIES

Projector control panel

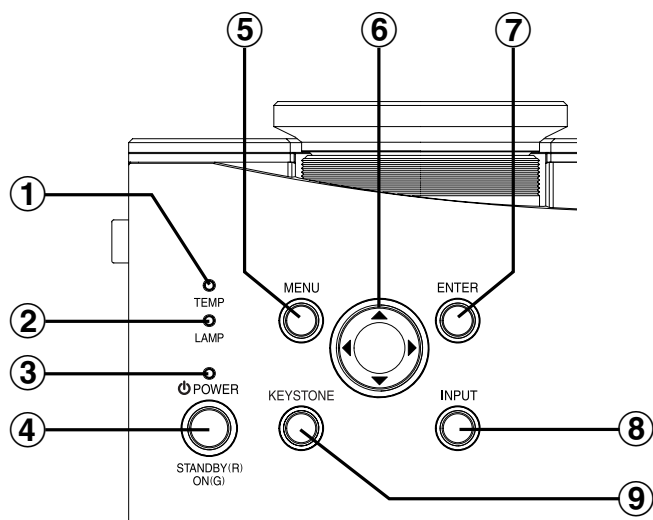

Remote control unit

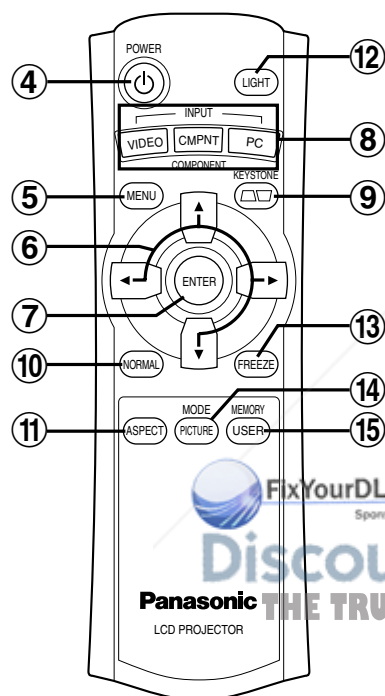

- ① **TEMP indicator** (page 44)
This indicator illuminates if an abnormally high temperature is detected inside the projector. If the temperature rises above a certain level, the power supply will be turned off automatically and the indicator will flash.
- ② **LAMP indicator** (page 45)
This indicator illuminates when it is time to replace the lamp unit. It flashes if a circuit abnormality is detected.
- ③ **Power indicator** (pages 22, 24 and 25)
This indicator illuminates red when the main power is switched on (standby mode), and it illuminates green when projection of an image begins.
- ④ **POWER button** (pages 22 and 24)
- ⑤ **MENU button** (page 32)
This button is used to display the "MAIN MENU". When a menu screen is being displayed, it can be used to return to a previous screen or to clear the screen.
- ⑥ **Arrow (▲, ▼, ◀ and ▶) buttons** (page 34)
These buttons are used to select and adjust items in the on-screen menus.
- ⑦ **ENTER button** (page 34)
This button is used to accept and to activate items selected in the on-screen menus.
- ⑧ **INPUT select button** (page 23)
These buttons are used to switch the input signals from the connected equipment.
- ⑨ **KEYSTONE button** (page 26)
This button is used to correct keystone distortion of the projected image when the projector position is tilted upward or downward.
- ⑩ **NORMAL button** (page 35)
This button is used to reset the projector adjustment values to the factory default settings.
- ⑪ **ASPECT button** (page 28)
This button is used for aspect adjustment (vertical and horizontal proportions).
- ⑫ **LIGHT button** (page 30)
This button is used to illuminate the buttons on the remote control unit.
- ⑬ **FREEZE button** (page 30)
This button is used to momentarily freeze projection so that a still picture is displayed.
- ⑭ **PICTURE MODE button** (page 27)
This button is used to display the "PICTURE MODE" menu.
- ⑮ **USER MEMORY button** (page 31)
This button is used to display the "MEMORY LOAD" menu.

Setting-up

Projection methods

In way of installing projector, any one of the following four projection methods are used. Select whichever projection method matches the setting-up method. (The projection method can be set from the "OPTION" menu. Refer to page 43 for details.)

• Front-desk projection

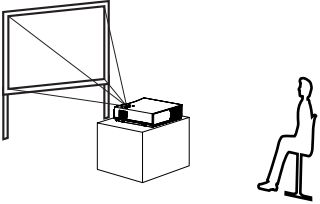

Menu items	Setting
FRONT/REAR	FRONT
DESK/CEILING	DESK

• Front-ceiling projection

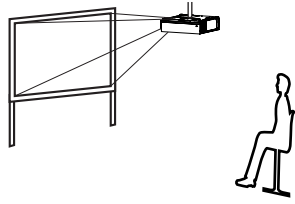

Menu items	Setting
FRONT/REAR	FRONT
DESK/CEILING	CEILING

• Rear-desk projection (Using a translucent screen)

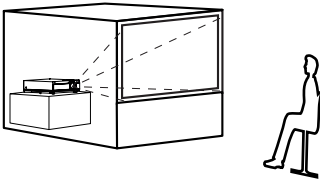

Menu items	Setting
FRONT/REAR	REAR
DESK/CEILING	DESK

• Rear-ceiling projection (Using a translucent screen)

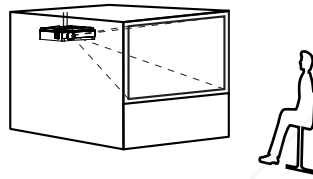

Menu items	Setting
FRONT/REAR	REAR
DESK/CEILING	CEILING

NOTE:

- You will need to purchase the separate ceiling bracket (ET-PKE300) when using the ceiling installation method.
- If you set up the projector vertically, it may cause damage to the projector.
- It is recommended that you set up the projector in a place that is tilted at less than $\pm 30^\circ$. Setting up the projector in places that are tilted at more than $\pm 30^\circ$ may cause malfunctions.

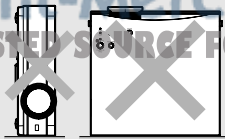

Projector position

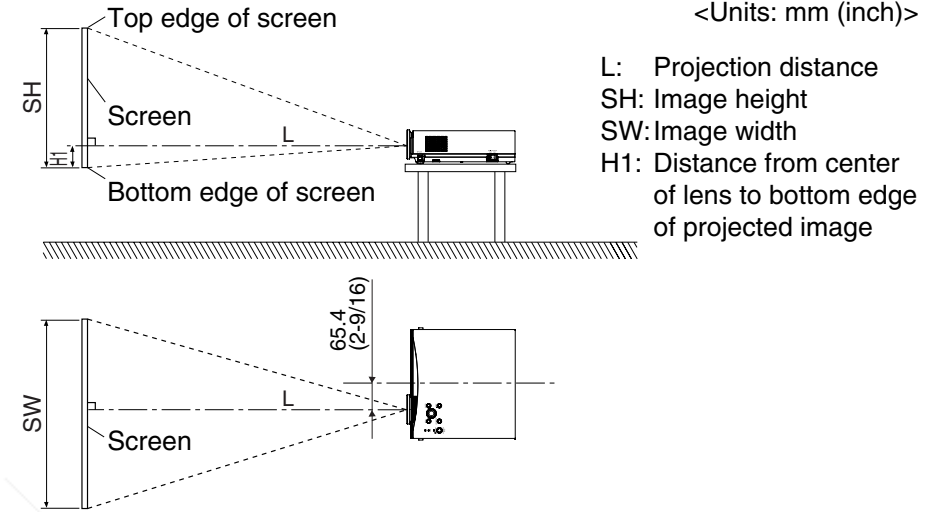

Projection distances

Diagonal length	Screen size (16:9)		Projection distance (L)		Height position (H1)
	Height (SH)	Width (SW)	Wide (LW)	Telephoto (LT)	
1.01 m(40")	0.50 m(1'7")	0.89 m(2'11")	1.2 m(3'11")	1.4 m(4'7")	0.03 m(1-5/32")
1.27 m(50")	0.62 m(2')	1.11 m(3'7")	1.6 m(5'2")	1.8 m(5'10")	0.04 m(1-9/16")
1.52 m(60")	0.75 m(2'5")	1.33 m(4'4")	1.9 m(6'2")	2.2 m(7'2")	0.04 m(1-9/16")
1.77 m(70")	0.87 m(2'10")	1.55 m(5'1")	2.2 m(7'2")	2.5 m(8'2")	0.05 m(1-15/32")
2.03 m(80")	1.00 m(3'3")	1.77 m(5'9")	2.5 m(8'2")	2.9 m(9'6")	0.06 m(2-11/32")
2.28 m(90")	1.12 m(3'8")	1.99 m(6'6")	2.8 m(9'2")	3.3 m(10'9")	0.06 m(2-11/32")
2.54 m(100")	1.24 m(4')	2.21 m(7'3")	3.1 m(10'2")	3.7 m(12'1")	0.07 m(2-3/4")
3.81 m(150")	1.87 m(6'1")	3.32 m(10'10")	4.7 m(15'5")	5.6 m(18'4")	0.10 m(3-29/32")
5.08 m(200")	2.49 m(8'2")	4.43 m(14'6")	6.2 m(20'4")	7.4 m(24'3")	0.14 m(5-1/2")

NOTE:

- The dimensions in the table above are approximate.
- For details about projected image distances, refer to page 56.

Connections

Notes on connections

- Read the instruction manual for each system component carefully before connecting it.
- Turn off the power supply for all components before making any connections.
- If the cables necessary for connecting a component to the system are not included with the component or available as an option, you may need to fashion a cable to suit the component concerned.
- Refer to the list on page 54 for details on compatible signals which can be input to the projector.
- An audio system circuit is not provided with this projector. Connect the audio output of the components to a separate audio system.

Connecting to video equipment

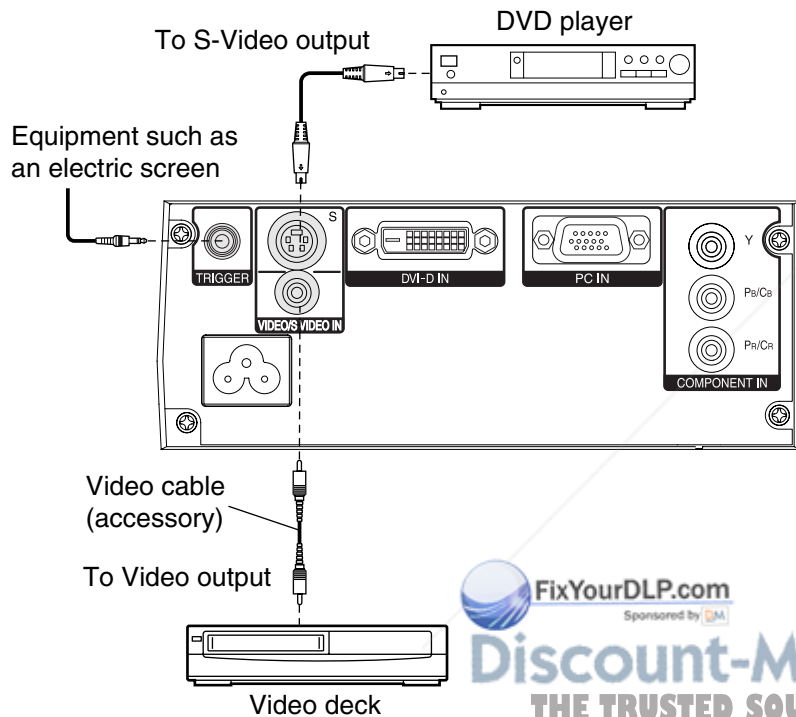

Connecting to equipment compatible with YPBPR (CbCr) signals

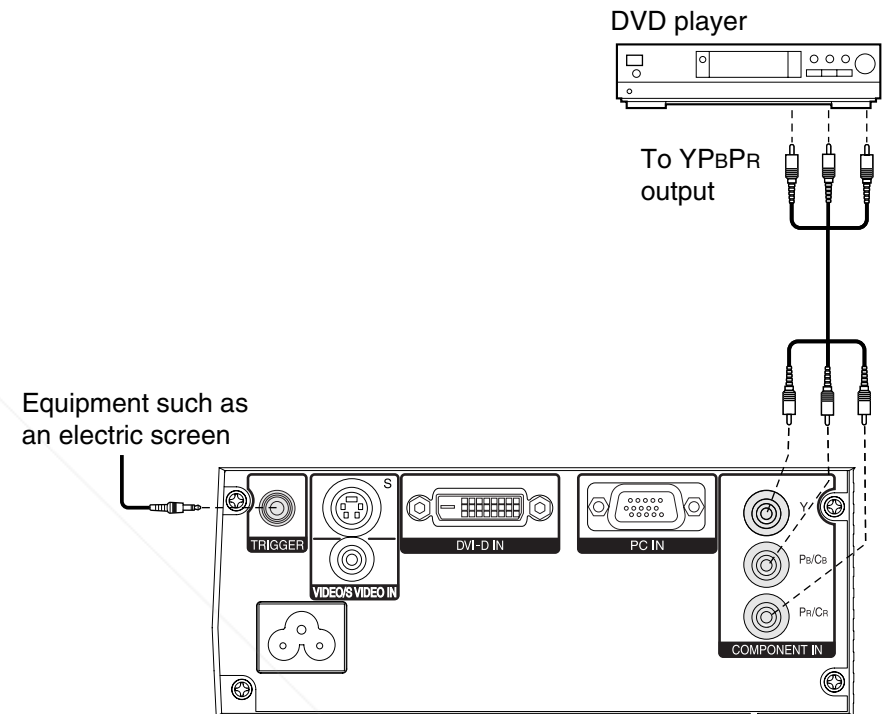

Connecting to computer

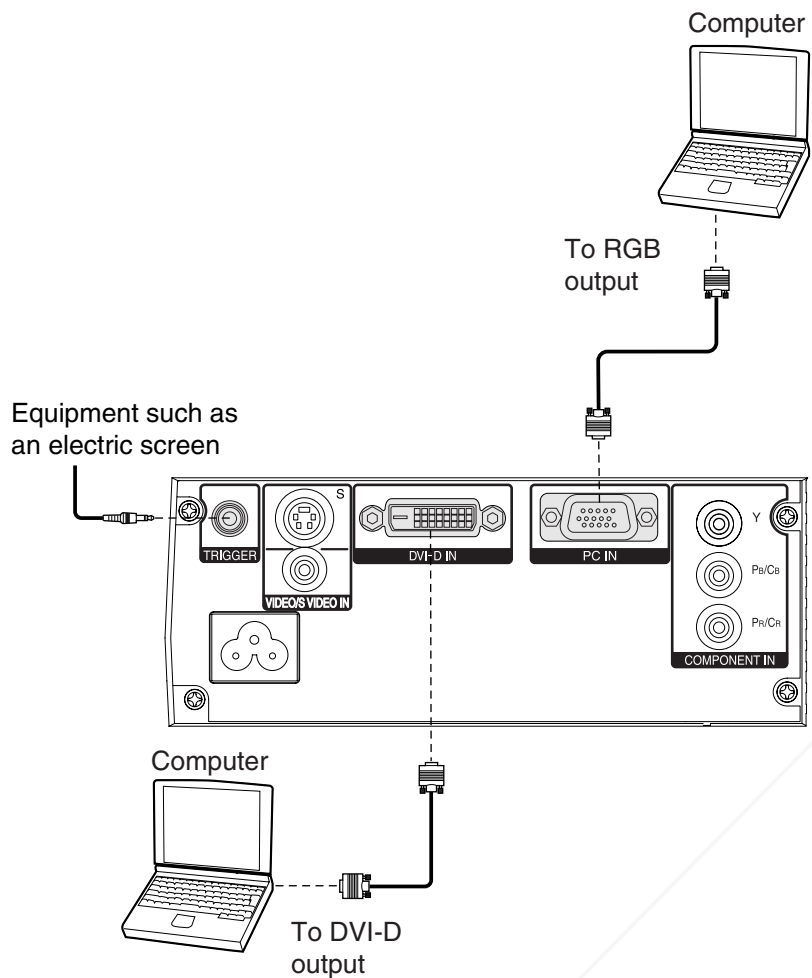

NOTE:

- Shut down the computer before turning off the MAIN POWER switch of the projector.

Preparation for the remote control unit

① Open the cover.

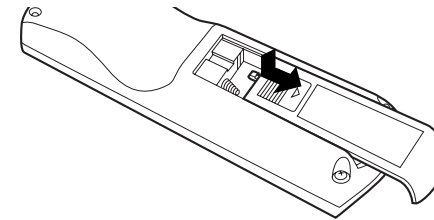

② Insert the batteries so that the polarities are correct, and then close the cover.

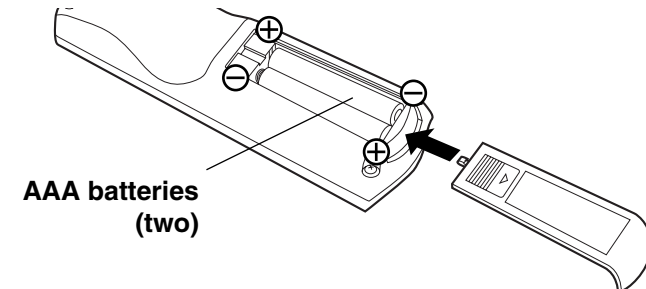

NOTE:

- Do not drop the remote control unit.
- Keep the remote control unit away from liquids.
- Remove the batteries if not using the remote control unit for long periods.
- Do not use rechargeable batteries.

Operating range

If the remote control unit is held so that it is facing directly in front of the remote control signal receptors on the front or rear of the projector, the operating range is within approximately 7 m (23') from the surfaces of the receptors. Furthermore, the remote control unit can be operated from an angle of $\pm 30^\circ$ to the left or right and $\pm 15^\circ$ above or below the receptors.

NOTE:

- If there are any obstacles in between the remote control unit and the receptors, the remote control unit may not operate correctly.
- If strong light is allowed to shine onto the remote control signal receptor, correct projector operation may not be possible. Place the projector as far away from light sources as possible.
- If facing the remote control unit toward the screen to operate the projector, the operating range of the remote control unit will be limited by the amount of light reflection loss caused by the characteristics of the screen used.

Turning on the power

Before turning on the power

- 1, Ensure that all components are connected properly.
- 2, Connect the accessory power cord.
- 3, Remove the lens cover.

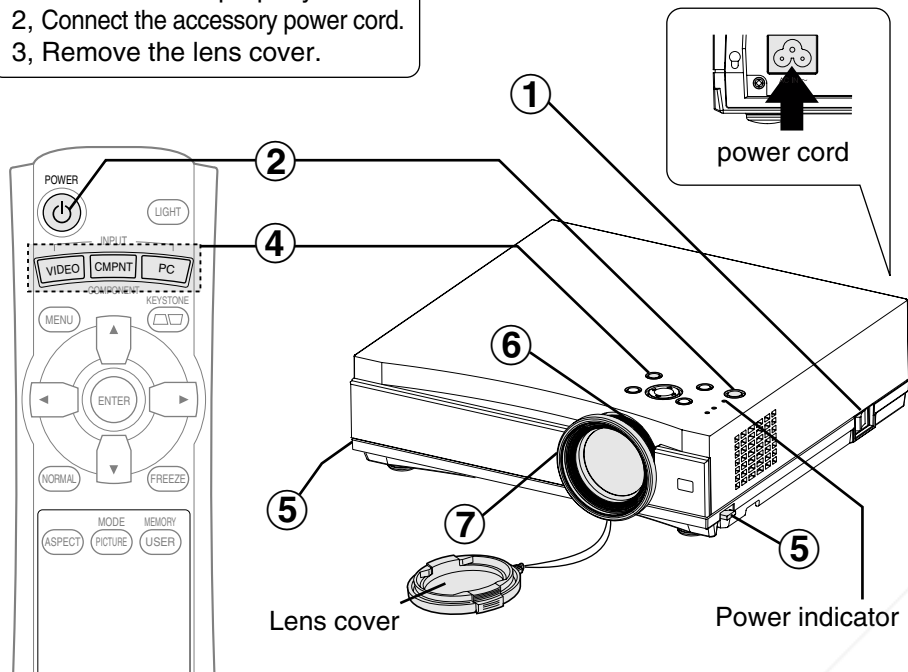

1 Press the MAIN POWER switch to turn on the power.

- The power indicator on the projector will illuminate red.

2 Press the POWER button.

- The power indicator on the projector will flash green. After a short period, the indicator will illuminate green, and a picture will be projected.

3 Turn on the power of connected devices.

- Start the play function of a device such as a DVD player.

NOTE:

- A tinkling sound may be heard when the lamp unit is turned on, but this is not a sign of a malfunction.

4 Press the input select button to select the input signal.

		INPUT		
		○		
Control panel	Input select button	VIDEO → S-VIDEO → Y·PB·PR		
	Changing signals	DVI ← PC		
Remote control unit	Input select button	VIDEO	CMPNT	PC
	Changing signals	VIDEO ↔ S-VIDEO	Y·PB·PR	PC ↔ DVI

- A picture will be projected in accordance with the selected input signal.

Follow the procedure below when you set the projector up first, and when you change the setup place.

5 Adjusting the angle

- While pressing the adjuster buttons, adjust the forward/back angle of tilt of the projector. Adjust so that the projector is as vertical to the screen as possible.

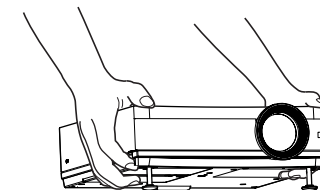

6 Adjusting the size

- Turn the zoom ring to adjust the size of the projected image.

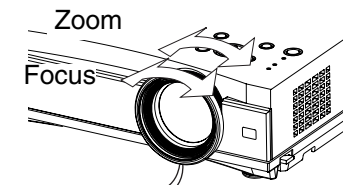

7 Adjusting the focus

- Turn the focus ring to adjust the focus of the projected image.

Turning off the power

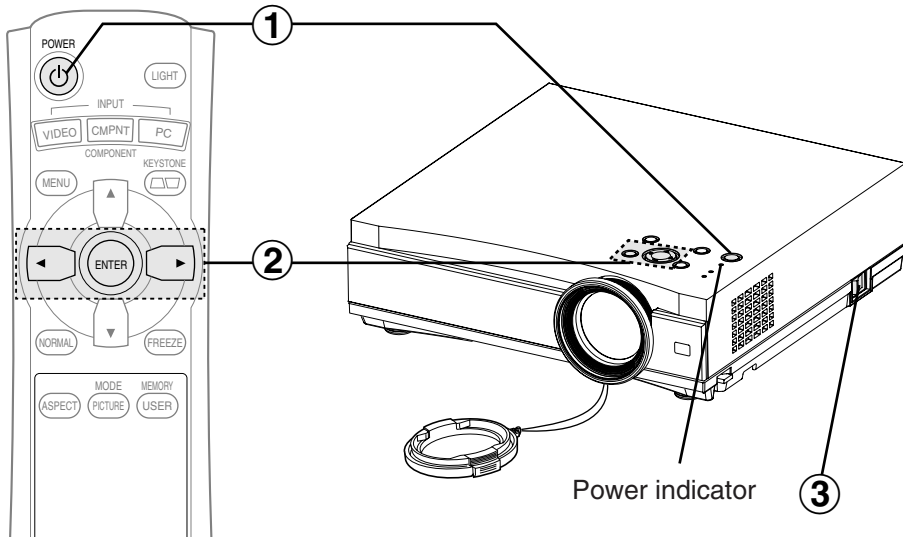

1 Press the POWER button.
 • “POWER OFF” is displayed on the screen.

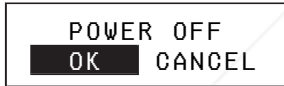

2 Press the ◀ or ▶ button to select “OK”, and then press the ENTER button.
 • The lamp unit will switch off and the picture will stop being projected. (The power indicator on the projector will illuminate orange while the cooling fan is still operating.)

3 Press the MAIN POWER switch to turn off the power after the power indicator on the projector illuminates red.
 • Do not cut power to the projector in any way while the cooling fan is still operating. Be careful not to switch off the MAIN POWER switch of the projector or unplug the power cord from the wall outlet.

NOTE:

- During projection of an image, the cooling fan will operate, emitting a small noise as it operates. Turning the lamp on or off will cause this noise to increase a little.
- By using the “OPTION” menu to set “LAMP POWER” to “LOW”, the operating sound of the fan can be reduced. (Refer to page 43.)
- You can also turn off the power by pressing the POWER button twice or by holding it down for at least 0.5 seconds.
- When the projector is in standby mode (the power indicator on the projector is illuminated red), the projector will still draw a maximum 1.0 W of power, even when the cooling fan has stopped.

Power indicator

Power indicator status		Projector status
Red	Illuminated	The projector is in standby mode and image projection is possible by pressing the POWER button.
Green	Flashing	The projector is preparing for projection after the power is turned on while the power indicator is illuminated red. (After a short period, a picture will be projected.)
	Illuminated	A picture is being projected.
Orange	Illuminated	The lamp is cooling down after the power is turned off. (The cooling fan is operating.)
	Flashing	The projector is preparing for projection after the power is turned on while the power indicator is illuminated orange. (After a short period, a picture will be projected.)

Correcting keystone distortion (KEYSTONE)

When either the projector or the screen is tilted, the keystone distortion will affect the image. You can correct the image proportions by the following procedure.

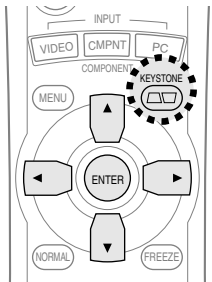

Press the **KEYSTONE** button.



- Press the ▲ or ▼ button to select the item you want to correct, and then press the ENTER button. Follow the procedures in the table below to correct the keystone distortion.

Projector control panel

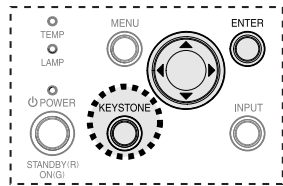

Horizontal keystone distortion correction		
Operation	Press the ► button.	Press the ◀ button.
Vertical keystone distortion correction		
Operation	Press the ► button.	Press the ◀ button.

- Press the **MENU** button to return to the previous screen.

NOTE:

- You can also correct keystone distortion from the "KEYSTONE" in the "MAIN MENU".
- Vertical and horizontal keystone distortion can be corrected to ±30° of the angle of tilt. However, the greater the correction amount, the more the picture quality will deteriorate, and the harder it will become to achieve a good level of focus. To obtain the best picture quality, set up the projector and screen in such a way that the amount of keystone correction required is as minimal as possible.
- The picture size will also change when correction of keystone distortion is carried out.

Selecting the picture mode (PICTURE MODE)

You can select the appropriate picture mode for the type of projected image by the following procedure.

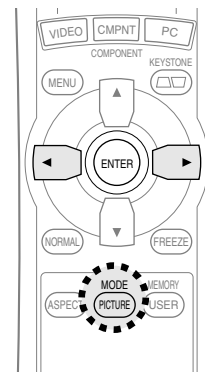

Press the **PICTURE MODE** button.



- Press the ◀ or ► button to select an item.

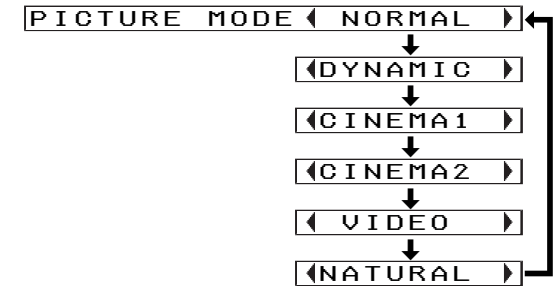

- NORMAL**When watching various image sources.
- DYNAMIC**When the projector is used in a bright room.
- CINEMA1**When watching movies. The projected image will be refined. This mode was well tuned to the look of Hollywood movie.
- CINEMA2**When watching movies. The projected image will be clear and have high contrast.
- VIDEO**When watching video sources such as music or sports programs.
- NATURAL**To reproduce the color of the image faithfully from the image source.

NOTE:

- The picture mode can be also selected in the "PICTURE" menu.

Useful functions

Setting the aspect ratio (ASPECT)

This projector allows you to change the aspect ratio to match the type of input signal.

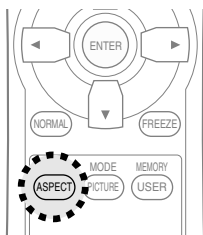

Press the ASPECT button.

- Pressing the ASPECT button will change the aspect ratio according to the successive settings shown below.
- Illustrations for aspect ratio settings are shown on the next page. Refer to this illustration for assistance in selecting a suitable aspect ratio.

S-VIDEO/VIDEO/ YPbPr	AUTO→4:3→16:9→JUST→ZOOM
PC	4:3→16:9→V SCROLL
DVI	4:3→16:9
	(When a 525p/625p signal is being input) 4:3→16:9→JUST→ZOOM

- When set to “AUTO”, the aspect ratio will be automatically selected if the input signal has a detector signal.

NOTE:

- If a selected mode does not match the aspect ratio of the input signal, it may affect the quality of viewing of the original picture. Keep this in mind when selecting the aspect ratio.
- If using this projector in places such as cafes or hotels to display programs for a commercial purpose or for public presentation, note that if the aspect ratio (16:9) selection function is used to change the aspect ratio of the screen picture, you may be infringing the rights of the original copyright owner for that program under copyright protection laws.
- If a normal (4:3) picture which was not originally intended for wide-screen viewing is projected onto a wide screen, distortion may occur around the edges of the picture so that part of the picture is no longer visible. Such programs should be viewed in 4:3 mode to give proper consideration to the aims and intentions of the original program's creator.
- The following signals have resolutions that are 16:9 image sizes. The aspect ratios for these signals cannot be changed while being played because they are already established. (Refer to page 54.)
HDTV60, HDTV50, 750p, WIDE 480/600/720/768/768-2
*WIDE768 signals can be set to “V SCROLL”.
- Image sizes such as Cinema-Vision that project wider than the 16:9 ratio will have narrow black fields at the top and bottom.
- You can also change the aspect ratio from the “POSITION” menu.

ASPECT	Input signal	Projected image
4:3	4:3 input signal 	4:3
16:9	Squeezed signal (image contracted horizontally) 	Horizontal expansion of projected image
JUST	4:3 input signal 	Horizontal expansion of projected image (Center of image is less distorted.)
ZOOM	Letterbox signal 	Expansion preserves original ratio
V SCROLL (XGA/MXGA/SXGA/ WIDE768 only)	4:3 input signal 	A picture is projected without expansion or reduction. (Vertical position can be adjusted by the ▼ and ▲ buttons.)

Turning on the button lights (LIGHT)

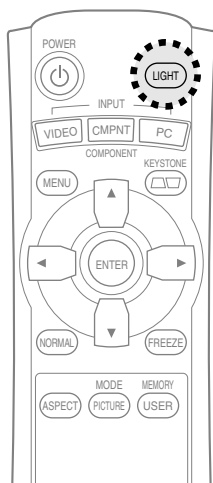

Press the LIGHT button.

- The buttons on the remote control unit will be illuminated.
- Press the LIGHT button again to turn off the button lights. The button lights will be turned off automatically when no buttons on the remote control unit are pressed for 10 seconds.

Retrieving the saved picture settings (USER MEMORY)

The picture settings adjusted according to the instructions on page 36 can be saved and retrieved.

Press the USER MEMORY button.

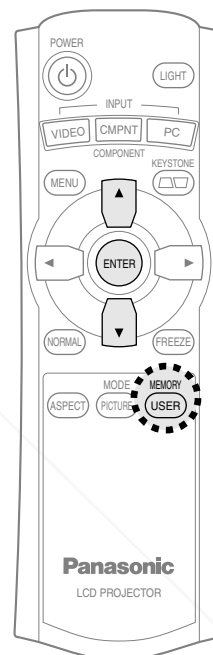

MEMORY LOAD	
MEMORY 1	
MEMORY 2	
MEMORY 3	
SELECT	ENTER ENTER MENU ESC

- The “MEMORY LOAD” menu will be displayed. Press the ▲ or ▼ button to select the setting you want to retrieve, then press the ENTER button.

Pausing a picture (FREEZE)

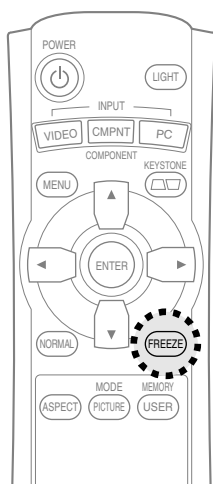

Press the FREEZE button.



- The picture being projected will be paused.
- Press the FREEZE button again to cancel the still picture.

NOTE:

- Only the settings saved in the “MEMORY SAVE” menu will be displayed in the “MEMORY LOAD” menu.

On-screen menus

Menu screens

The various settings and adjustments for this projector can be carried out by selecting the operations from on-screen menus.

The general arrangement of these menus is shown below.

MAIN MENU

MENU	
	KEYSTONE
	PICTURE
	POSITION
	SHUTTER
	LANGUAGE
	OPTION
SELECT	ENTER ENTER MENU EXIT

- Press the MENU button to display the "MAIN MENU". Refer to page 34 for details on how to operate the on-screen menus.

PICTURE menu (page 36)

When an S-VIDEO/VIDEO signal is being input

PICTURE	
PICTURE MODE ◀ NORMAL ▶	
CONTRAST	0
BRIGHT	0
COLOR	0
TINT	0
SHARPNESS	0
COLOR TEMP.	0
AI	OFF
ADVANCE MENU	
MEMORY SAVE	
MEMORY LOAD	
TV-SYSTEM	AUTO
SELECT	ADJ MENU ESC

When a YPbPr/PC signal is being input

PICTURE	
PICTURE MODE ◀ NORMAL ▶	
CONTRAST	0
BRIGHT	0
COLOR	0
TINT	0
SHARPNESS	0
COLOR TEMP.	0
AI	OFF
ADVANCE MENU	
MEMORY SAVE	
MEMORY LOAD	
SIGNAL MODE	525I
SELECT	ADJ MENU ESC

When a DVI signal is being input

PICTURE	
PICTURE MODE ◀ NORMAL ▶	
CONTRAST	0
BRIGHT	0
SHARPNESS	0
COLOR TEMP.	0
AI	OFF
ADVANCE MENU	
MEMORY SAVE	
MEMORY LOAD	
SIGNAL MODE	XGA
SELECT	ADJ MENU ESC

POSITION menu (page 40)

When an S-VIDEO/VIDEO/DVI signal is being input

POSITION	
H-POSITION	0
V-POSITION	0
ASPECT	16:9
SELECT	ENTER ENTER MENU ESC

- When a DVI signal is being input, only "ASPECT" can be adjusted.

When a YPbPr signal is being input

POSITION	
H-POSITION	0
V-POSITION	0
CLOCK PHASE	0
ASPECT	4:3
SELECT	ENTER ENTER MENU ESC

When a PC signal is being input

POSITION	
H-POSITION	0
V-POSITION	0
DOT CLOCK	0
CLOCK PHASE	0
ASPECT	4:3
AUTO SETUP	
SELECT	ENTER ENTER MENU ESC

LANGUAGE menu (page 41)

LANGUAGE ENGLISH	
ENGLISH	
DEUTSCH	
FRANÇAIS	
ESPAÑOL	
ITALIANO	
РУССКИЙ	
한국어	
中文	
SELECT	ENTER ENTER MENU ESC

OPTION menu (page 42)

OPTION	
OSD	ON
NR	ON
PC PRIORITY	NORMAL
BACK COLOR	BLACK
EDID	
FRONT/REAR	FRONT
DESK/CEILING	DESK
FAN CONTROL	NORMAL
LAMP POWER	HIGH
LAMP RUNTIME	5H
SELECT	ADJ MENU ESC

SHUTTER function (page 41)

KEYSTONE correction (page 26)

KEYSTONE	
H-KEYSTONE	0
V-KEYSTONE	0
SELECT	ENTER ENTER MENU ESC

Fix Your DHP.com
 Discount Merchant.com (800) 281-8860
 THE TRUSTED SOURCE FOR PROJECTOR LAMPS AND ACCESSORIES

Menu operation guide

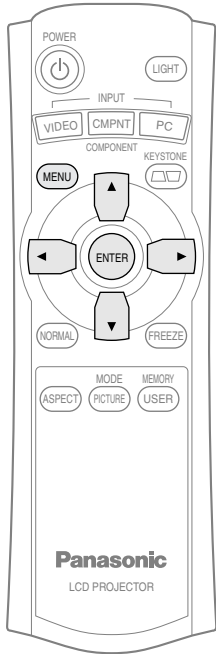

Projector control panel

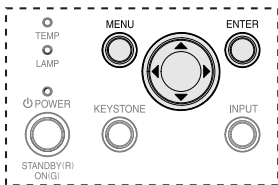

① Press the MENU button.

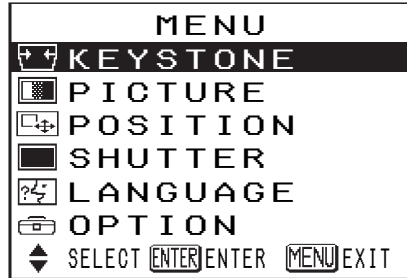

The "MAIN MENU" screen will be displayed.

② Press the ▲ or ▼ button to select an item.

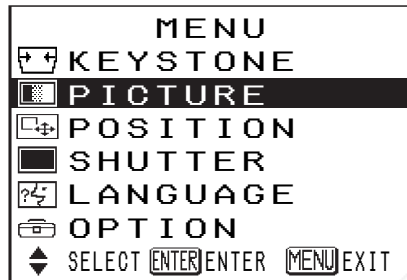

Selected items will be displayed in blue.

③ Press the ENTER button to accept the selection.

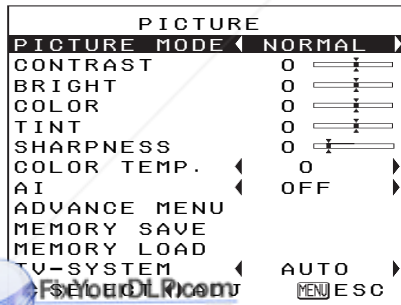

The selected menu screen or adjustment screen will then be displayed. (Example: "PICTURE" menu)

NOTE:

- Press the MENU button to return to the previous screen.

④ Press the ▲ or ▼ button to select an item, and then press the ◀ or ▶ button to change or adjust the setting.

An individual adjustment screen such as the one shown below will be displayed for bar scale items.



The bar scale will turn green when any adjustment changes the setting from the factory set value.

For items without any selective arrow or bar scale, press the ENTER button. The menu screen for the item will then be displayed.

Unavailable on-screen menu items

This projector has unadjustable items and unusable functions depending on the signal being input.

When an item cannot be adjusted or a function cannot be used, the corresponding on-screen menu display does not appear, and the item or function will not work even if the ENTER button is pressed.

Returning a setting to the factory default

If you press the NORMAL button on the remote control unit, you can return settings to the factory default settings. However, the operation of this function varies depending on which screen is being displayed.

● **When a menu screen is being displayed**

All items displayed will be returned to their factory default settings, and the bar scale will appear white.

● **When an individual adjustment screen is being displayed**

Only the item displayed will be returned to the factory default setting, and the bar scale will appear white.

NOTE:

- Triangle symbols above and below a menu bar indicate the factory default setting. Items which do not have these triangle symbols cannot be returned to the factory default setting. The positions of triangle symbols vary depending on the type of signal being input.

Indicates the standard factory default setting

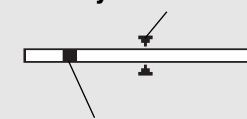

Indicates the current adjustment value

Adjusting the picture

Press the ▲ or ▼ button to select an item, and then press the ◀ or ▶ button to change the setting.

For items with bar scales, press the ENTER button or the ◀ or ▶ button to display the adjustment screen, and then press the ◀ or ▶ button to make the adjustment.

For items without any selective arrow or bar scale, press the ENTER button. The menu screen for the item will then be displayed.

When an S-VIDEO/VIDEO signal is being input

PICTURE	
PICTURE MODE	NORMAL
CONTRAST	0
BRIGHT	0
COLOR	0
TINT	0
SHARPNESS	0
COLOR TEMP.	0
AI	OFF
ADVANCE MENU	
MEMORY SAVE	
MEMORY LOAD	
TV-SYSTEM	AUTO
SELECT	ADJ
	MENU ESC

When a YPbPr/PC signal is being input

PICTURE	
PICTURE MODE	NORMAL
CONTRAST	0
BRIGHT	0
COLOR	0
TINT	0
SHARPNESS	0
COLOR TEMP.	0
AI	OFF
ADVANCE MENU	
MEMORY SAVE	
MEMORY LOAD	
SIGNAL MODE	525 I
SELECT	ADJ
	MENU ESC

When a DVI signal is being input

PICTURE	
PICTURE MODE	NORMAL
CONTRAST	0
BRIGHT	0
SHARPNESS	0
COLOR TEMP.	0
AI	OFF
ADVANCE MENU	
MEMORY SAVE	
MEMORY LOAD	
SIGNAL MODE	XGA
SELECT	ADJ
	MENU ESC

PICTURE MODE

Refer to page 27 for details.

CONTRAST

This adjusts the contrast of the picture. (Adjust the “BRIGHT” setting first if required before adjusting the “CONTRAST” setting.)

The picture is bright: ◀ button

The picture is dark: ▶ button

BRIGHT

This adjusts the darker areas (black areas) in the picture.

Black areas are too light: ◀ button

Dark areas are too solid: ▶ button

COLOR

(S-VIDEO/VIDEO/YPbPr/PC only)

The color is too deep: ◀ button

The color is too pale: ▶ button

NOTE:

- When PC signals are being input, adjustment can be made only when HDTV60/HDTV50 signals are being input.

TINT

(NTSC/NTSC 4.43/YPbPr/PC only)

This adjusts the flesh tones in the picture.

The flesh tones are greenish: ◀ button

The flesh tones are reddish: ▶ button

NOTE:

- When PC signals are being input, adjustment can be made only when HDTV60/HDTV50 signals are being input.

SHARPNESS

To soften the picture details: ◀ button

To sharpen the picture details: ▶ button

COLOR TEMP.

COLOR TEMP.	◀ -2 ▶
	↓
	◀ -1 ▶
	↓
	◀ 0 ▶
	↓
	◀ +1 ▶
	↓
	◀ +2 ▶

This is used to adjust the white areas of the picture if they appear bluish or reddish.

AI

The lamp is controlled according to the input signals to project images with the best quality.

AI-1 For image sources with many dark scenes such as movies.

AI-2 For image sources with many bright scenes such as general programs.

OFF “AI” is disabled.

NOTE:

- “AI” is disabled when “LAMP POWER” is set to “LOW”. (Refer to page 43.)

ADVANCE MENU

Picture settings can be adjusted in more detail.

Press the ENTER button to display the “ADVANCE MENU”

ADVANCE MENU	
GAMMA HIGH	0
GAMMA MID	0
GAMMA LOW	0
CONTRAST R	0
CONTRAST G	0
CONTRAST B	0
BRIGHT R	0
BRIGHT G	0
BRIGHT B	0
SELECT	ENTER ENTER MENU ESC

“GAMMA HIGH/MID/LOW” is used for correcting the gradation of a bright or dark projected image.

- Adjust “GAMMA HIGH” mainly to correct the gradation of a bright projected image.
- Adjust “GAMMA LOW” mainly to correct the gradation of a dark projected image.

“CONTRAST R/G/B” and “BRIGHT R/G/B” are used for correcting the color temperature in more detail.

- Adjust “CONTRAST R/G/B” mainly to correct the white areas of the projected image.
- Adjust “BRIGHT R/G/B” mainly to correct the black areas of the projected image.

MEMORY SAVE

Press the ENTER button to display the “MEMORY SAVE” menu.

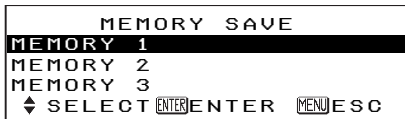

The settings adjusted in “PICTURE” menu can be saved. Press the ▲ or ▼ button to select the number in which you want to save the setting, and then press the ENTER button. The confirmation screen will then be displayed. Press the ◀ or ▶ button to select “OK” and then press the ENTER button. The current picture setting will be saved.

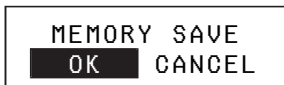

NOTE:

- You can save up to 3 settings for each of the 2 signal groups described below (up to 6 settings can be saved).

S-VIDEO, VIDEO, YPBPR, and HDTV50/HDTV60 signals from DVI and PCs

PC and DVI (except for HDTV50/HDTV60 signals)

MEMORY LOAD

Press the ENTER button to display the “MEMORY LOAD” menu. (If any setting is not saved in the “MEMORY SAVE” menu, the “MEMORY LOAD” menu will not be displayed.) Refer to page 31 on how to retrieve the saved settings.

TV-SYSTEM

(S-VIDEO/VIDEO only)

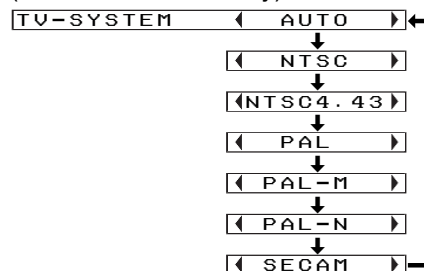

This should normally be set to “AUTO”. If the signal is of such poor quality that the correct format cannot be automatically distinguished, change the setting manually to the required TV system.

NOTE:

- When set to “AUTO”, the projector automatically distinguishes between NTSC/NTSC 4.43/PAL/PAL60/PAL-M/PAL-N/SECAM signals.

SIGNAL MODE

(PC/YPBPR/DVI only)

This displays the type of signal which is currently being projected. Refer to the table on page 54 for details on each type of signal.

Projecting sRGB-compatible pictures

sRGB is an international color reproduction standard (IEC61966-2-1) established by the International Electrotechnical Commission (IEC). If you would like the colors in sRGB-compatible pictures to be reproduced more faithfully, make the following settings.

- Press the ▲ or ▼ button to select “PICTURE MODE”, and then press the ◀ or ▶ button to select “NATURAL”.
- Press the NORMAL button on the remote control unit.
- Press the ▲ or ▼ button to select “LAMP POWER” in the “OPTION” menu, and then press the ◀ or ▶ button to select “HIGH”.



Discount-Merchant.com (800) 281-8860
THE TRUSTED SOURCE FOR PROJECTOR LAMPS AND ACCESSORIES

Adjusting the position

When the input signal is from a PC, first select "AUTO SETUP" and then press the ENTER button to initiate automatic positioning. If the optimum setting is not obtained when "AUTO SETUP" is carried out, adjust by the following procedure.

Press the ▲ or ▼ button to select an item, and then press the ◀ or ▶ button to change the setting. For items with bar scales, press the ENTER button or the ◀ or ▶ button to display the adjustment screen, and then Press the ◀ or ▶ button to make the adjustment.

When an S-VIDEO/VIDEO/DVI signal is being input.

POSITION	
H-POSITION	0 ◀ ▶
V-POSITION	0 ◀ ▶
ASPECT	◀ 16:9 ▶
◆ SELECT ENTER ENTER MENU ESC	

- When a DVI signal is being input, only "ASPECT" can be adjusted.

When a YPbPr signal is being input

POSITION	
H-POSITION	0 ◀ ▶
V-POSITION	0 ◀ ▶
CLOCK PHASE	0 ◀ ▶
ASPECT	◀ 4:3 ▶
◆ SELECT ENTER ENTER MENU ESC	

When a PC signal is being input

POSITION	
H-POSITION	0 ◀ ▶
V-POSITION	0 ◀ ▶
DOT CLOCK	0 ◀ ▶
CLOCK PHASE	0 ◀ ▶
ASPECT	◀ 4:3 ▶
◆ SELECT ENTER ENTER MENU ESC	

Horizontal position (H-POSITION)

(S-VIDEO/VIDEO/YPbPr/PC only)
To move the picture to the left: ◀ button
To move the picture to the right: ▶ button

Vertical position (V-POSITION)

(S-VIDEO/VIDEO/YPbPr/PC only)
To move the picture down: ◀ button
To move the picture up: ▶ button

DOT CLOCK

(PC only)
Periodic striped pattern interference (noise) may occur when a striped pattern such as the one below is projected. If this happens, press the ◀ or ▶ button to adjust so that any such noise is minimised.

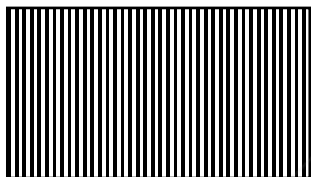

CLOCK PHASE

(PC/YPbPr only)
Adjust the "DOT CLOCK" setting first before carrying out this adjustment. Press the ◀ or ▶ button to adjust so that the noise level is least noticeable.

NOTE:
If signals with a dot clock frequency of 100 MHz or higher are being input, interference may not be completely eliminated when the "DOT CLOCK" and "CLOCK PHASE" adjustments are carried out.

- When YPbPr signals are being input, "CLOCK PHASE" can be adjusted only when HDTV60/HDTV50/750p signals are being input.

ASPECT

Refer to page 28.

AUTO SETUP

(PC only)
"H-POSITION", "V-POSITION", "DOT CLOCK" and "CLOCK PHASE" are automatically adjusted according to the input signal.

NOTE:

- When the "ASPECT" is set to "V SCROLL" (page 28), "AUTO SETUP" cannot be performed.

Turning off the picture momentarily (SHUTTER)

The "SHUTTER" function can be used to momentarily turn off the picture when the projector is not being used for short periods of time. The projector uses less power in "SHUTTER" mode than it does in normal projection mode.

- 1 Select "SHUTTER" from the "MAIN MENU" and then press the ENTER button.
- 2 Press any button on either the projector or remote control unit (except the LIGHT button) to return to normal operating mode.

Changing the display language

- 1 Select "LANGUAGE" from the "MAIN MENU" and then press the ENTER button.
- 2 Press the ▲ or ▼ button to select a language and then press the ENTER button.

LANGUAGE	ENGLISH
ENGLISH	◀ ▶
DEUTSCH	◀ ▶
FRANÇAIS	◀ ▶
ESPAÑOL	◀ ▶
ITALIANO	◀ ▶
РУССКИЙ	◀ ▶
한국어	◀ ▶
中文	◀ ▶
◆ SELECT ENTER ENTER MENU ESC	

Indicates the language which is currently set

Option settings

Press the ▲ or ▼ button to select an item, and then press the ◀ or ▶ button to change the setting.

OPTION	
OSD	ON
NR	ON
PC PRIORITY	NORMAL
BACK COLOR	BLACK
EDID	EDID1
FRONT/REAR	FRONT
DESK/CEILING	DESK
FAN CONTROL	NORMAL
LAMP POWER	HIGH
LAMP RUNTIME	5H
SELECT	ADJ
MENU	ESC

OSD

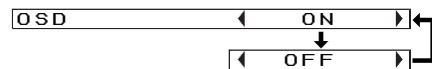

ON The signal name is displayed in the top-right corner of the screen when the input signal is changed.

OFF Use this setting when you do not want the signal name to be displayed.

Noise Reduction (NR)

(YPbPr only)

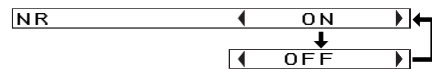

If noise occurs from the projector because of a poor input signal, set "NR" to "ON".

To turn off the "NR" feature, set it to "OFF".

PC PRIORITY

(PC only)

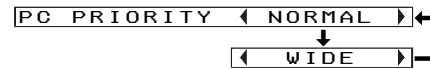

NORMAL The PC screen data is displayed in a 4:3 aspect ratio.

WIDE The PC screen data is displayed in a 16:9 aspect ratio.

BACK COLOR

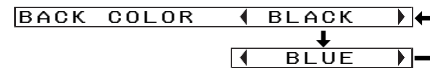

This sets the color which is projected onto the screen when no signal is being input to the projector.

EDID

(DVI only)



When DVI signals such as 525p, 625p, HDTV60, HDTV50, or 750p signals are being input, set to "EDID1". Set to "EDID2" when other signals are being input.

NOTE:

- "EDID" stands for "Extended Display Identification Data". It is used to transmit information such as the model name of this projector or the settings to the computer connected to DVI-D IN connector. This is useful for projecting the images with the proper resolution.

FRONT/REAR

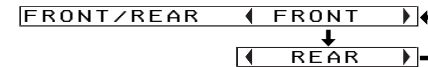

This setting should be changed in accordance with the projector setting-up method. (Refer to page 16.)

FRONT When the projector is placed in front of a screen.

REAR When using a translucent screen.

DESK/CEILING



This setting should be changed in accordance with the projector setting-up method. (Refer to page 16.)

DESK When the projector is placed on a desk or similar.

CEILING When the projector is suspended from a ceiling using the ceiling bracket (sold separately).

FAN CONTROL

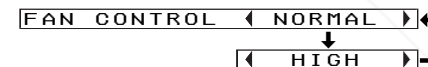

Set "FAN CONTROL" to "HIGH", when using this projector at high elevations (above 1 400 m) only.

LAMP POWER

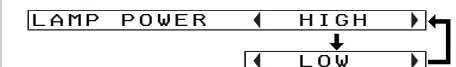

This setting changes the lamp brightness. When set to "LOW", the luminance of the lamp is reduced, but the projector uses less power, and the operating noise is also reduced.

The "LOW" setting is recommended for narrow rooms where a high picture luminance is not essential or for watching movies.

NOTE:

- "LAMP POWER" cannot be set when no signal is being input.

LAMP RUNTIME

This setting displays the usage time for the lamp unit which is currently being used. When replacing the lamp unit, follow the instructions on page 48, and reset "LAMP RUNTIME" to "0".

NOTE:

- The lamp's operating life varies depending on the usage conditions (such as the "LAMP POWER" setting and the number of times the power is turned on and off).

When the TEMP indicator and the LAMP indicator are illuminated

There are two indicators on the control panel of the projector which give information about the operating condition of the projector. These indicators illuminate or flash to warn you about problems that have occurred inside the projector, so if you notice that one of the indicators is on, turn off the power and check the table below for the cause of the problem.

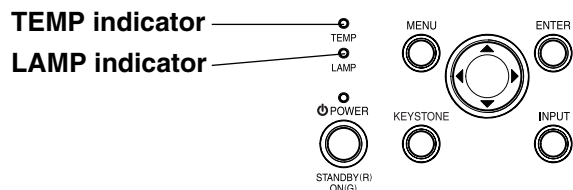

TEMP indicator			
Indicator display	Illuminated (red) (Lamp unit on)	Flashing (red) (Lamp unit on)	Flashing (red) (Lamp unit off)
Problem	The surrounding temperature or the temperature inside the projector has become unusually high.	The temperature inside the projector has become dangerously high, or the temperature has suddenly changed.	The surrounding temperature or the temperature inside the projector has become dangerously high, causing the lamp unit to automatically shut off.
Possible cause	<ul style="list-style-type: none"> • The ventilation holes may be covered. • The ambient temperature in the place of use may be too high. • The air filter may be blocked. 		
Remedy	<ul style="list-style-type: none"> • Uncover the ventilation holes. • Set up the projector in a place where the temperature is between 0 °C (32 °F) and 40 °C (104 °F) and the humidity is between 20% and 80% (with no condensation). [If you set the "FAN CONTROL" to "HIGH" (page 43), set up the projector in a place where the temperature is between 0 °C (32 °F) and 35 °C (95 °F) and the humidity is between 20% and 80% (with no condensation).] • Turn off the MAIN POWER switch by following the procedure on page 24, and then clean the air filter. (Refer to page 46.) 		

LAMP indicator		
Indicator display	Illuminated (red)	Flashing (red)
Problem	It is nearly time to replace the lamp unit.	An abnormality has been detected in the lamp circuit.
Possible cause	<ul style="list-style-type: none"> • Does "REPLACE LAMP" appear on the screen after the projector is turned on? 	<ul style="list-style-type: none"> • The power may have been turned on straight away after it was turned off. • There may be an abnormality in the lamp circuit.
Remedy	<ul style="list-style-type: none"> • This occurs when the operation time for the lamp unit is nearing 1 800 hours (when "LAMP POWER" has been set to "HIGH"). Ask your dealer or an Authorized Service Center to replace the lamp unit. 	<ul style="list-style-type: none"> • Wait for a while until the lamp unit cools down before turning the power back on again. • Turn off the MAIN POWER switch by following the procedure given on page 24, and then contact an Authorized Service Center.

NOTE:

- Be sure to turn off the MAIN POWER switch by following the procedure given in "Turning off the power" on page 24 before carrying out any of the procedures in the "Remedy" column.
- If the main power turns off after the TEMP indicator starts flashing, it means that an abnormality has occurred. Please contact an Authorized Service Center so that the necessary repairs can be made.

Cleaning and replacing the air filter

If the air filter becomes clogged with dust, the internal temperature of the projector will rise, the TEMP indicator will flash and the projector power will turn off. **The air filter should be cleaned after every 100 hours of use.**

- ① **Turn off the MAIN POWER switch and disconnect the power cord plug from the wall outlet.**

Turn off the MAIN POWER switch according to the procedure given in "Turning off the power" on page 24 before disconnecting the plug from the wall outlet.

- ② **Gently turn the projector upside down.**

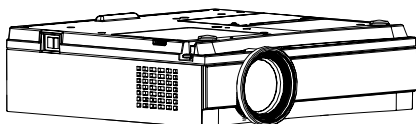

NOTE:

- Place the projector on top of a soft cloth so that it will not become scratched.

- ③ **Remove the air filter.**

Put your fingernails under the air filter and pull the air filter out of the projector.

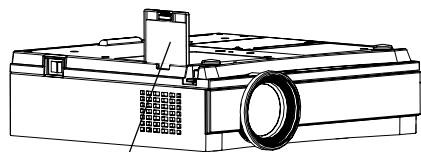

Air filter

- ④ **Clean the air filter.**

Soak the air filter in water and wash out dirt by hand.

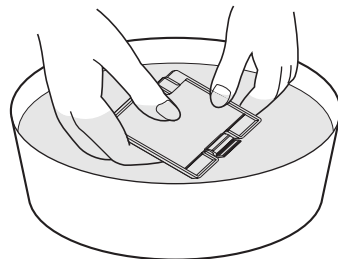

NOTE:

- Do not use detergent.
- Be careful not to separate the air filter cover from the frame when washing the air filter.

- ⑤ **Dry the air filter and install it to the projector.**

NOTE:

- Be sure to install the air filter before using the projector. If the projector is used without the air filter installed, dust and other foreign particles will be drawn into the projector, and malfunctions will result. If the dust cannot be removed by cleaning, it is time to replace the air filter. Please consult your dealer. Furthermore, if the lamp unit is being replaced, replace the air filter at this time also.

Replacing the lamp unit

NOTE:

- If you need the lamp replacement, please purchase the lamp unit from our customer service.
Lamp unit product no.: **ET-LAE500**

CAUTION:

- Do not use any lamp unit other than the one with the product number indicated above.

Warning

When replacing the lamp, allow it to cool for at least one hour before handling it.

- The lamp cover gets very hot, and contact with it can cause burns.

Notes on replacing the lamp unit

- The light generating lamp is made of glass, so dropping it or allowing it to hit hard objects may cause it to burst. Be careful when handling the lamp.
- Dispose of the removed old lamp with the same care that would be taken with a fluorescent light.
- A Phillips screwdriver is necessary for removing the lamp unit.

Lamp unit replacement period



The lamp is a consumable product. Even when the full life of the bulb has not been exhausted, the brightness of the light will gradually decline. Therefore periodic replacement of the lamp is necessary.

The intended lamp replacement interval is 2 000 hours, but it is possible that the lamp may need to

be replaced earlier due to variables such as a particular lamp's characteristics, usage conditions and the installation environment. Early preparation for lamp replacement is encouraged. The lamp will automatically shut off when 2 000 hours of use have been reached because of a much greater chance of it exploding after this time.

NOTE:

- The usage hours explained above are for use when the "HIGH" setting has been selected for "LAMP POWER" in the "OPTION" menu. If the "LOW" setting is selected, the brightness of the lamp will be less and life of the lamp can be extended.
- While 2 000 hours is the intended replacement interval, it is not a period of time covered by warranty.

	On-screen display 	Lamp indicator warning light 
More than 1 800 hours	Displayed for 30 seconds. Pressing any button will clear the display.	Illuminates red during image projection and standby mode.
More than 2 000 hours	Remains displayed until any button is pressed.	

Lamp unit replacement procedure

NOTE:

- If the lamp usage time has passed 2 000 hours (when “LAMP POWER” has been set to “HIGH”), the projector will switch to standby mode after approximately 10 minutes of operation. The steps ⑦ to ⑩ on the next page should thus be completed within 10 minutes.

- ① Turn off the MAIN POWER switch according to the procedure given in “Turning off the power” on page 24, and then disconnect the power cord plug from the wall outlet and check that the area around the lamp unit has cooled down.
- ② Use a Phillips screwdriver to turn the lamp unit cover fixing screws at the bottom of the projector, and then remove the lamp unit cover from the projector.

Lamp unit cover

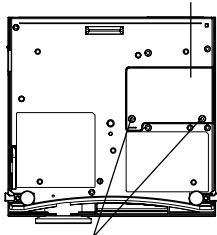

Lamp unit cover fixing screws

- ③ Use a Phillips screwdriver to loosen the two lamp unit fixing screws until the screws turn freely. Then hold the handle of the lamp unit and gently pull it out from the projector.

Lamp unit fixing screws

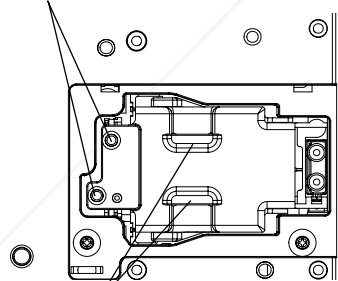

- ④ Insert the new lamp unit while making sure that the direction of insertion is correct, and then use a Phillips screwdriver to securely tighten the lamp unit fixing screws.

- ⑤ Install the lamp unit cover, and then use a Phillips screwdriver to securely tighten the lamp unit cover fixing screws.
- ⑥ Insert the power cord plug into the wall outlet and then press the MAIN POWER switch.
- ⑦ Press the POWER button so that a picture is projected onto the screen.
- ⑧ Press the MENU button to display the “MAIN MENU”, and then press the ▲ or ▼ button to select “OPTION”.

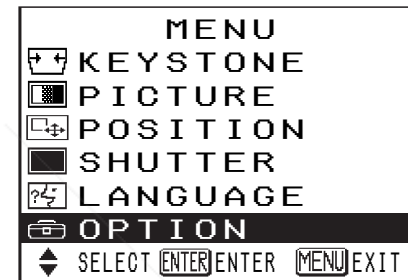

- ⑨ Press the ENTER button to display the “OPTION” menu, and then press the ▲ or ▼ button to select “LAMP RUNTIME”.

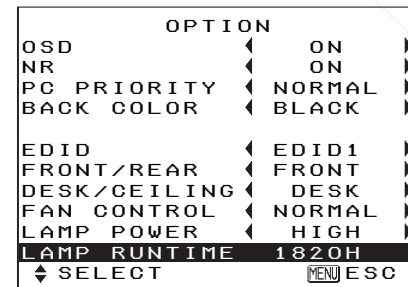

- ⑩ Press and hold the ENTER button for approximately 3 seconds.

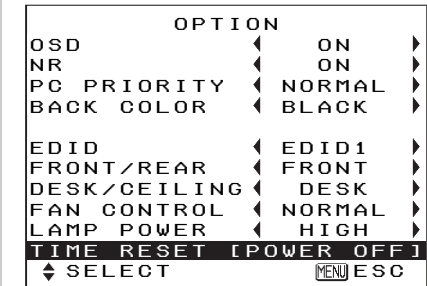

The “LAMP RUNTIME” will change to “TIME RESET [POWER OFF]”.

- If the MENU button is pressed, the lamp time resetting screen will be cancelled.
- ⑪ Turn off the power.
This will reset the cumulative usage time for the lamp unit to zero.
Refer to page 24 for details on how to turn off the power.

NOTE:

- Be sure to install the lamp unit and the lamp unit cover securely. If they are not securely installed, it may cause the protection circuit to operate so that the power cannot be turned on.

Before calling for service

Before calling for service, check the following points.

Problem	Possible cause	Page
Power does not turn on.	• The power cord may not be connected.	–
	• The MAIN POWER switch is turned off.	–
	• The main power supply is not being supplied to the wall outlet.	–
	• TEMP indicator is illuminated or flashing.	44
	• LAMP indicator is illuminated or flashing.	45
No picture appears.	• The video signal input source may not be connected properly.	–
	• The input selection setting may not be correct.	23
	• The “BRIGHT” adjustment setting may be at the minimum possible setting.	36
	• The shutter function may be in use.	41
The picture is fuzzy.	• The lens cover may still be attached to the lens.	–
	• The lens focus may not have been set correctly.	23
	• The projector may not be at the correct distance from the screen.	17
	• The lens may be dirty.	–
	• The projector may be tilted too much.	17
COLOR is too light or TINT is poor.	• “COLOR” or “TINT” adjustment may be incorrect.	36
	• The input source which is connected to the projector may not be adjusted correctly.	–
The remote control unit does not operate.	• The batteries may be weak.	–
	• The batteries may not be inserted correctly.	21
	• The remote control signal receptor on the projector may be obstructed.	21
	• The remote control unit may be out of the operation range.	21
The picture does not display correctly.	• The signal format (“TV-SYSTEM”) may not be set correctly.	38
	• There may be a problem with the video tape or other signal source.	–
	• A signal which is not compatible with the projector may be being input.	54
Picture from computer does not appear.	• The cable may be connected incorrectly.	–
	• The external video input for the laptop computer may not be set correctly. (You may be able to change the external output settings by pressing the [Fn]+[F3] or [Fn]+[F10] keys simultaneously. The actual method varies depending on the type of computer, so refer to the documentation provided with your computer for further details.)	–

Cleaning and maintenance

Before carrying out cleaning and maintenance, be sure to disconnect the power cord plug from the wall outlet.

Wipe the cabinet with a soft, dry cloth.

If the cabinet is particularly dirty, soak the cloth in water with a small amount of neutral detergent in it, squeeze the cloth very well, and then wipe the cabinet. After cleaning, wipe the cabinet dry with a dry cloth. If using a chemically-treated cloth, read the instructions supplied with the cloth before use.

Do not wipe the lens with a cloth that is dusty or which produces lint.

If any dust or lint gets onto the lens, such dust or lint will be magnified and projected onto the screen. Use a blower to clean any dust and lint from the lens surface, or use a soft cloth to wipe off any dust or lint.

Discount-Merchant.com (800) 281-8860
 THE TRUSTED SOURCE FOR PROJECTOR LAMPS AND ACCESSORIES

Specifications

Power supply:	100 V – 240 V ~, 50 Hz/60 Hz
Power consumption:	180 W [During standby (when fan is stopped): Approx. 1.0 W]
Amps:	2.2 A - 1.0 A
LCD panel:	
Panel size (diagonal):	0.7 type (17.78 mm)
Aspect ratio:	16:9
Display method:	3 transparent LCD panels (RGB)
Drive method:	Active matrix method
Pixels:	921 600 (1 280 x 720) x 3 panels
Lens:	Manual zoom (1 - 1.2) / focus lens F 1.9 - 2.2, f 22.0 mm - 26.2 mm
Lamp:	UHM lamp (130 W)
Luminosity:	850 lm
Scanning frequency(for RGB signals):	
Horizontal scanning frequency:	30 kHz–70 kHz
Vertical scanning frequency:	50 Hz–87 Hz
Dot clock frequency:	Less than 100 MHz
YPbPr signals:	525i (480i), 525p (480p), 625i (576i), 625p (576p), 750p (720p), 1 125i (1 080i)
Color system:	7 (NTSC/NTSC 4.43/PAL/PAL-M/PAL-N/ PAL60/SECAM)
Projection size:	1 016 mm - 5 080 mm (40" - 200")
Throw distance:	1.2 m - 7.4 m (3'11" - 24'3")
Optical axis shift:	17:1 (fixed)
Screen aspect ratio:	16:9
Installation:	Front/Rear/Ceiling/Desk (Menu selection method)
Connectors	
VIDEO IN:	
S-VIDEO:	Single-line, Mini DIN 4-pin Y 1.0 V [p-p], C 0.286 V [p-p], 75 Ω
VIDEO:	Single-line, RCA pin jack 1.0 V [p-p], 75 Ω
PC IN:	
RGB:	Single-line, D-SUB HD 15-pin (female)
R.G.B.:	0.7 V [p-p], 75 Ω
G.SYNC:	1.0 V [p-p], 75 Ω
HD/SYNC:	TTL high impedance, automatic plus/minus polarity compatible
VD:	TTL high impedance, automatic plus/minus polarity compatible

COMPONENT IN:	
Y, Pb/Cb, Pr/Cr	Single-line, RCA pin jack x 3
Y:	1.0 V [p-p], 75 Ω
Pb,Pr (Cb,Cr):	0.7 V [p-p], 75 Ω
DVI-D IN:	Single-line, DVI-D, 24-pin
TRIGGER out:	Single-line, M3 jack When the power is turned on (during projection) : 12 V When the power is turned off : 0 V
Cabinet:	Moulded plastic (ABS/PC)
Dimensions:	
Width:	280 mm (11") (Not including projecting parts)
Height:	85 mm (3-11/32")
Length:	269 mm (10-9/16") (Not including lens)
Weight:	2.9 kg (6.4 lbs.)
Operating environment:	
Temperature:	0 °C – 40 °C (32 °F – 104 °F) [When the "FAN CONTROL" is set to "HIGH" (page 43): 0 °C – 35 °C (32 °F – 95 °F)]
Humidity:	20% – 80% (no condensation)
Certifications:	UL60950, C-UL FCC Class B

<Remote control unit>

Power supply:	3 V DC (AAA battery x2)
Operating range:	Approx. 7 m (23') (when operated directly in front of signal receptor)
Weight:	70 g (2.5 ozs.) (including batteries)
Dimensions:	
Width:	43 mm (1-11/16")
Length:	135 mm (5-5/16")
Height:	22.3 mm (-7/8")

<Options>

Ceiling bracket	ET-PKE300
Projection Screen	ET-SR90CT [width: 1 800 mm(70")] ET-SR70CT [width: 1 400 mm(55")]

Appendix

List of compatible signals

Mode	Display resolution (dots)*1	Scanning frequency		Dot clock frequency (MHz)	Picture quality*2	Format
		H (kHz)	V (Hz)			
NTSC/NTSC4.43/ PAL-M/PAL60	720 x 480i	15.734	59.940		A	Video/S-Video
PAL/PAL-N/SECAM	720 x 576i	15.625	50.000		A	Video/S-Video
525i	720 x 480i	15.734	59.940	13.500	A	YPbPr
625i	720 x 576i	15.625	50.000	13.500	A	YPbPr
525p	720 x 483	31.469	59.940	27.000	A	YPbPr/DVI
625p	720 x 576	31.250	50.000	27.000	A	YPbPr/DVI
HDTV60	1 920 x 1 080i	33.750	60.000	74.250	AA	YPbPr/PC/DVI
HDTV50	1 920 x 1 080i	28.125	50.000	74.250	AA	YPbPr/PC/DVI
750p	1 280 x 720	45.000	60.000	74.250	AA	YPbPr/DVI
VGA480	640 x 480	31.469	59.940	25.175	A	PC/DVI
	640 x 480	35.000	66.667	30.240	A	PC
	640 x 480	37.861	72.809	31.500	A	PC
	640 x 480	37.500	75.000	31.500	A	PC
	640 x 480	43.269	85.008	36.000	A	PC
WIDE480 SVGA	640 x 480	72.090	138.000	62.284	A	PC
	856 x 480	30.057	60.114	31.500	A	PC/DVI
	800 x 600	35.156	56.250	36.000	A	PC
	800 x 600	37.879	60.317	40.000	A	PC/DVI
	800 x 600	48.077	72.188	50.000	A	PC
WIDE600 SVGA	800 x 600	46.875	75.000	49.500	A	PC
	800 x 600	53.674	85.061	56.250	A	PC
	800 x 600	72.080	112.000	77.849	A	PC
	1 072 x 600	37.287	59.947	51.382	A	PC/DVI
	1 280 x 720	45.106	60.141	76.500	AA	PC/DVI
XGA	1 024 x 768	48.363	60.004	65.000	A	PC/DVI
	1 024 x 768	56.476	70.069	75.000	A	PC
	1 024 x 768	60.023	75.029	78.750	A	PC
	1 024 x 768	68.678	84.997	94.500	A	PC
	1 024 x 768	72.080	89.000	99.185	A	PC
WIDE768	1 280 x 768	45.327	56.518	76.150	A	PC/DVI
MXGA	1 152 x 864	63.995	71.184	94.200	A	PC
	1 152 x 864	67.500	74.917	108.000	A	PC
SXGA	1 280 x 1 024	63.981	60.020	108.000	A	PC/DVI
WIDE768-2	1 360 x 768	48.830	59.841	73.831	A	PC/DVI

*1 The "i" appearing after the resolution indicates an interlaced signal.

*2 The following symbols are used to indicate picture quality.

AA Maximum picture quality can be obtained.

A Signals are converted by the image processing circuit before picture is projected

Connector pin wiring

- The pin layout and signal names for the S-VIDEO input connector are shown below.

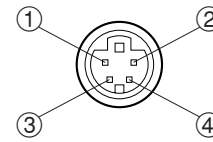

External view

Pin No.	Signal
①	Earth (Luminance signal)
②	Earth (Color signal)
③	Luminance signal
④	Color signal

- The pin layout and signal names for the RGB input connector are shown below.

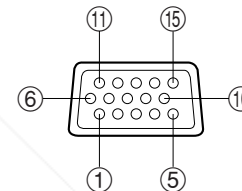

External view

Pin No.	Signal
①	R
②	G/G·SYNC
③	B
⑫	SDA
⑬	HD/SYNC
⑭	VD
⑮	SCL

Pin ⑨ is spare.

Pins ④ – ⑧, ⑩ and ⑪ are for earth.

Pins ⑫ and ⑮ functions are only valid when supported by the computer



Discount-Merchant.com (800) 281-8860
THE TRUSTED SOURCE FOR PROJECTOR LAMPS AND ACCESSORIES

Dimensions

<Units: mm (inch)>

- The pin layout and signal names for the DVI-D input connector are shown below. (interface with TMDS connector on a personal computer)

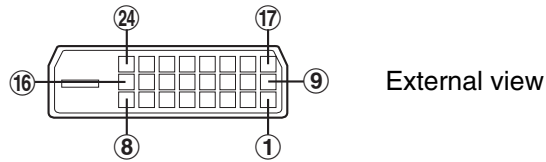

Pin No.	Signal	Pin No.	Signal
①	T.M.D.S data 2-	⑬	T.M.D.S data 3+
②	T.M.D.S data 2+	⑭	+5 V
③	T.M.D.S data 2/4 shield	⑮	Earth
④	T.M.D.S data 4-	⑯	Hot plug sense
⑤	T.M.D.S data 4+	⑰	T.M.D.S data 0-
⑥	DDC clock	⑱	T.M.D.S data 0+
⑦	DDC data	⑲	T.M.D.S data 0/5 shield
⑧	—	⑳	T.M.D.S data 5-
⑨	T.M.D.S data 1-	㉑	T.M.D.S data 5+
⑩	T.M.D.S data 1+	㉒	T.M.D.S clock shield
⑪	T.M.D.S data1/3 shield	㉓	T.M.D.S clock+
⑫	T.M.D.S data 3-	㉔	T.M.D.S clock-

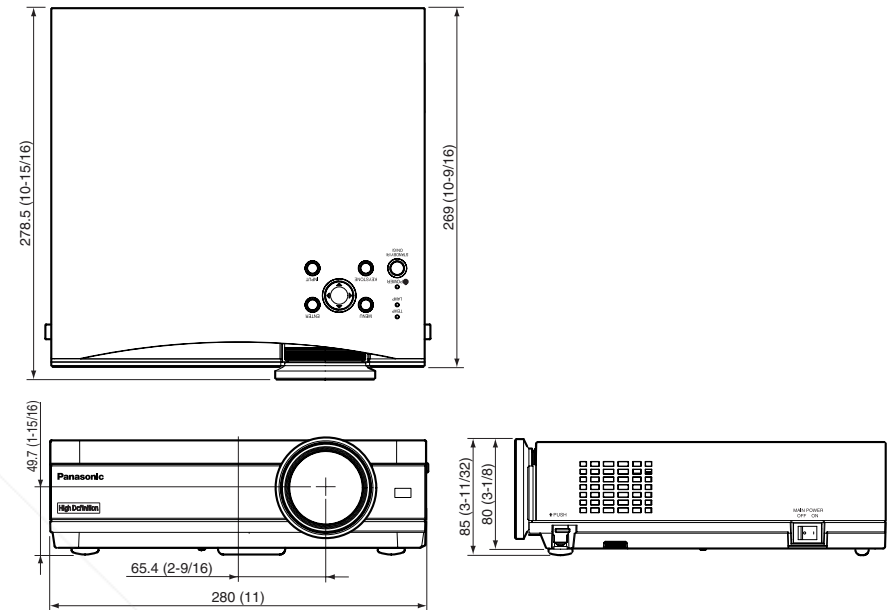

Projection dimensions calculation methods

The following methods will allow you to calculate dimensions such as screen diagonal length and projection distances. Units in all calculations are metre.

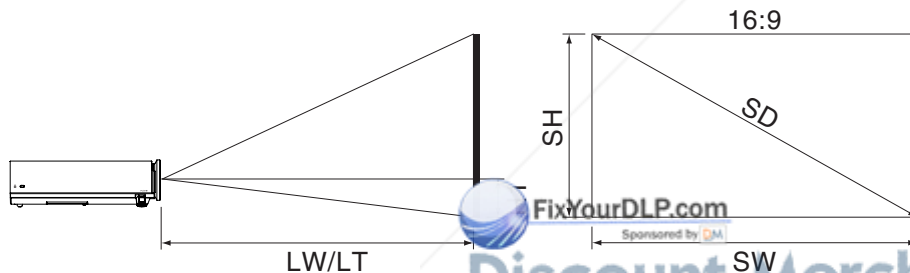

Screen Width: $SW=SD \times 0.872$

Screen Height: $SH=SD \times 0.490$

Minimum Projection Distance: $LW=1.229 \times SD - 0.0381$

Maximum Projection Distance: $LT=1.481 \times SD - 0.0381$

Image Lower Edge from Lens Center: $H1=SW/29$

Discount-Merchant.com (800) 281-8860
 THE TRUSTED SOURCE FOR PROJECTOR LAMPS AND ACCESSORIES

Trademark acknowledgements

- VGA and XGA are trademarks of International Business Machines Corporation.
- S-VGA is a registered trademark of the Video Electronics Standards Association.

All other trademarks are the property of the various trademark owners.



Discount-Merchant.com (800) 281-8860
THE TRUSTED SOURCE FOR PROJECTOR LAMPS AND ACCESSORIES

These Operating Instructions are printed on recycled paper.



Disclaimer

This user manual is provided as a free service by FixYourDLP.com. FixYourDLP is in no way responsible for the content of this manual, nor do we guarantee its accuracy. FixYourDLP does not make any claim of copyright and all copyrights remain the property of their respective owners.

About FixYourDLP.com

FixYourDLP.com (<http://www.fixyourdlp.com>) is the World's #1 resource for media product news, reviews, do-it-yourself guides, and manuals.

Informational Blog: <http://www.fixyourdlp.com>

Video Guides: <http://www.fixyourdlp.com/guides>

User Forums: <http://www.fixyourdlp.com/forum>

FixYourDLP's Fight Against Counterfeit Lamps:

<http://www.fixyourdlp.com/counterfeits>

Sponsors:

RecycleYourLamp.org – Free lamp recycling services for used lamps:

<http://www.recycleyourlamp.org>

Lamp Research - The trusted 3rd party lamp research company:

<http://www.lampresearch.com>

Discount-Merchant.com – The worlds largest lamp distributor:

<http://www.discount-merchant.com>



FixYourDLP.com

Sponsored by 