



# Disclaimer

This user manual is provided as a free service by FixYourDLP.com. FixYourDLP is in no way responsible for the content of this manual, nor do we guarantee its accuracy. FixYourDLP does not make any claim of copyright and all copyrights remain the property of their respective owners.

About FixYourDLP.com

FixYourDLP.com (<http://www.fixyourdlp.com>) is the World's #1 resource for media product news, reviews, do-it-yourself guides, and manuals.

Informational Blog: <http://www.fixyourdlp.com>

Video Guides: <http://www.fixyourdlp.com/guides>

User Forums: <http://www.fixyourdlp.com/forum>

FixYourDLP's Fight Against Counterfeit Lamps:

<http://www.fixyourdlp.com/counterfeits>

## Sponsors:

RecycleYourLamp.org – Free lamp recycling services for used lamps:

<http://www.recycleyourlamp.org>

Lamp Research - The trusted 3rd party lamp research company:

<http://www.lampresearch.com>

Discount-Merchant.com – The worlds largest lamp distributor:

<http://www.discount-merchant.com>



**FixYourDLP.com**

Sponsored by 

# Panasonic

LCD Projector **Commercial Use**

## Operating Instructions

Model No. **PT-L711XU**  
**PT-L701XU**  
**PT-L511XU**  
**PT-L501XU**

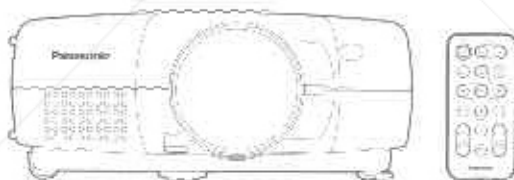

 **FixYourDLP.com**  
Sponsored by 

**Discount-Merchant.com (800) 281-8860**  
**THE TRUSTED SOURCE FOR PROJECTOR LAMPS AND ACCESSORIES**

Read these instructions completely before operating this unit.

TRB10081

# Dear Panasonic Customer:

This instruction booklet provides all the necessary operating information that you might require. We hope it will help you to get the most performance out of your new product, and that you will be pleased with your Panasonic LCD projector.

The serial number of your product may be found on its back. You should note it in the space provided below and retain this booklet in case service is required.

Model number: **PT-L711XU / PT-L701XU / PT-L511XU / PT-L501XU**

Serial number: \_\_\_\_\_

## IMPORTANT SAFETY NOTICE

**WARNING: TO REDUCE THE RISK OF FIRE OR ELECTRIC SHOCK, DO NOT EXPOSE THIS PRODUCT TO RAIN OR MOISTURE.**

**Power Supply:** This LCD Projector is designed to operate on 100 V – 240 V, 50 Hz/60 Hz AC, house current only.

**CAUTION:** The AC power cord which is supplied with the projector as an accessory can only be used for power supplies up to 125 V, 10 A. If you need to use higher voltages or currents than this, you will need to obtain a separate 250-V power cord. If you use the accessory cord in such situations, fire may result.



The lightning flash with arrowhead symbol, within an equilateral triangle, is intended to alert the user to the presence of uninsulated "dangerous voltage" within the product's enclosure that may be of sufficient magnitude to constitute a risk of electric shock to persons.



The exclamation point within an equilateral triangle is intended to alert the user to the presence of important operating and maintenance (servicing) instructions in the literature accompanying the product.

**CAUTION:** This equipment is equipped with a three-pin grounding-type power plug. Do not remove the grounding pin on the power plug. This plug will only fit a grounding-type power outlet. This is a safety feature. If you are unable to insert the plug into the outlet, contact an electrician. Do not defeat the purpose of the grounding plug.

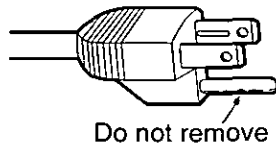

**WARNING:** This equipment has been tested and found to comply with the limits for a Class A digital device, pursuant to Part 15 of the FCC Rules. These limits are designed to provide reasonable protection against harmful interference when the equipment is operated in a commercial environment. This equipment generates, uses, and can radiate radio frequency energy and, if not installed and used in accordance with the instruction manual, may cause harmful interference to radio communications. Operation of this equipment in a residential area is likely to cause harmful interference in which case the user will be required to correct the interference at his own expense.

**CAUTION:** Any unauthorized changes or modifications to this equipment will void the users authority to operate.



**Discount-Merchant.com (800) 281-8860**  
THE TRUSTED SOURCE FOR PROJECTOR LAMPS AND ACCESSORIES

# Contents

## Preparation

|  |    |
|--|----|
| <b>IMPORTANT SAFETY NOTICE</b> .....             | 2  |
| <b>Precautions with regard to safety</b> .....   | 5  |
| <b>Accessories</b> .....                         | 8  |
| <b>Precautions on handling</b> .....             | 9  |
| <b>Location and function of each part</b> .....  | 11 |
| Adjusting the angle of tilt.....                 | 12 |
| Storing the card remote control unit.....        | 15 |
| <b>Using the remote control unit</b> .....       | 16 |
| Inserting the battery.....                       | 16 |
| Operating range.....                             | 16 |
| <b>Connections</b> .....                         | 17 |
| Notes on connections.....                        | 17 |
| Example of connecting with video equipments..... | 18 |
| Example of connecting with computers.....        | 19 |
| <b>Setting-up</b> .....                          | 20 |
| Projection methods.....                          | 20 |
| Projector position.....                          | 20 |
| Projection distances.....                        | 21 |

## Basic Operation

|   |    |
|---|----|
| <b>Starting to use</b> .....                          | 22 |
| Turning on the power.....                             | 22 |
| Turning off the power.....                            | 23 |
| About the RGB INPUT monitor.....                      | 24 |
| About the automatic setup function.....               | 24 |
| <b>On-screen menus</b> .....                          | 25 |
| Menu screens.....                                     | 25 |
| Menu operation guide.....                             | 26 |
| White character display of on-screen items.....       | 26 |
| Returning to the previous screen.....                 | 26 |
| Returning a setting to the factory default.....       | 27 |
| <b>Using the freeze function</b> .....                | 27 |
| <b>Using the D.ZOOM (digital zoom) function</b> ..... | 28 |
| <b>Correcting keystone distortion</b> .....           | 29 |
| <b>Adjusting the picture</b> .....                    | 30 |
| PICTURE MODE.....                                     | 30 |
| COLOR.....  | 30 |
| TINT.....   | 30 |
| BRIGHT.....   | 30 |
| CONTRAST.....   | 30 |

|  |    |
|--|----|
| SHARPNESS.....                               | 30 |
| TV SYSTEM.....                               | 31 |
| WHITE BALANCE R/G/B.....                     | 31 |
| DISPLAY MODE.....                            | 31 |
| S1 SIGNAL.....                               | 31 |
| RESIZING.....                                | 32 |
| <b>Adjusting the position</b> .....          | 33 |
| HORIZONTAL POSITION.....                     | 33 |
| VERTICAL POSITION.....                       | 33 |
| VIDEO SIZE.....                              | 33 |
| DOT CLOCK.....                               | 33 |
| CLOCK PHASE.....                             | 33 |
| <b>Using the INDEX WINDOW function</b> ..... | 34 |
| <b>Using the shutter function</b> .....      | 35 |
| <b>Changing the display language</b> .....   | 35 |

## Advanced Operation

|   |    |
|---|----|
| <b>Option settings</b> .....            | 36 |
| SCREEN DISPLAY.....                     | 36 |
| AUTO KEYSTN.....                        | 36 |
| AUTO Y-PB-PR.....                       | 36 |
| AUTO RGB IN.....                        | 36 |
| RGB FORMAT.....                         | 36 |
| BACK COLOR.....                         | 37 |
| FRONT/REAR.....                         | 37 |
| DESK/CEILING.....                       | 37 |
| LAMP POWER.....                         | 37 |
| LAMP TIME.....                          | 37 |
| FUNC 1.....                             | 37 |
| <b>Using the SERIAL connector</b> ..... | 38 |

## Others

|   |    |
|---|----|
| <b>Indicators</b> .....                               | 40 |
| <b>Cleaning and replacing the air filter</b> .....    | 42 |
| <b>Replacing the lamp unit</b> .....                  | 43 |
| <b>Before asking for service</b> .....                | 46 |
| <b>Specifications</b> .....                           | 48 |
| <b>Appendix</b> .....                                 | 50 |
| List of compatible signals.....                       | 50 |
| <b>Dimensions</b> .....                               | 51 |
| <b>Trademark acknowledgements</b> .....               | 52 |
| <b>NOTES IMPORTANTES CONCERNANT LA SÉCURITÉ</b> ..... | 53 |
| <b>Précautions concernant la sécurité</b> .....       | 55 |
| <b>Précautions concernant la manipulation</b> .....   | 59 |
| <b>Remplacement du bloc de lampe</b> .....            | 61 |

# Precautions with regard to safety

## WARNING

If a problem occurs (such as no image or no sound) or if you notice smoke or a strange smell coming from the projector, turn off the power and disconnect the power cord from the wall outlet.

- Do not continue to use the projector in such cases, otherwise fire or electric shocks could result.
- Check that no more smoke is coming out, and then contact an Authorised Service Center for repairs.
- Do not attempt to repair the projector yourself, as this can be dangerous.

**Do not install this projector in a place which is not strong enough to take the full weight of the projector.**

- If the installation location is not strong enough, it may fall down or tip over, and severe injury or damage could result.
- Installation work (such as ceiling suspension) should only be carried out by a qualified technician.
- If installation is not carried out correctly, there is the danger that injury or electric shocks may occur.

**If foreign objects or water get inside the projector, or if the projector is dropped or the cabinet is broken, turn off the power and disconnect the power cord from the wall outlet.**

- Continued use of the projector in this condition may result in fire or electric shocks.
- Contact an Authorised Service Center for repairs.

**Do not cover the air filter and the air inlet.**

- Doing so may cause the projector to overheat, which can cause fire or damage to the projector.

**Do not overload the wall outlet.**

- If the power supply is overloaded (for example, by using too many adapters), overheating may occur and fire may result.

**Do not remove the cover or modify it in any way.**

- High voltages which can cause fire or electric shocks are present inside the projector.
- For any inspection, adjustment and repair work, please contact an Authorised Service Center.

**Clean the power cord plug regularly to prevent it from becoming covered in dust.**

- If dust builds up on the power cord plug, the resulting humidity can damage the insulation, which could result in fire. Pull the power cord out from the wall outlet and wipe it with a dry cloth.
- If not using the projector for an extended period of time, pull the power cord plug out from the wall outlet.

**Do not do anything that might damage the power cord or the power cord plug.**

- Do not damage the power cord, make any modifications to it, place it near any hot objects, bend it excessively, twist it, pull it, place heavy objects on top of it or wrap it into a bundle.
- If the power cord is used while damaged, electric shocks, short-circuits or fire may result.
- Ask an Authorised Service Center to carry out any repairs to the power cord that might be necessary.

**Do not handle the power cord plug with wet hands.**

- Failure to observe this may result in electric shocks.

**Insert the power cord plug securely into the wall outlet.**

- If the plug is not inserted correctly, electric shocks or overheating could result.
- Do not use plugs which are damaged or wall outlets which are coming loose from the wall.

**Do not place the projector on top of surfaces which are unstable.**

- If the projector is placed on top of a surface which is sloped or unstable, it may fall down or tip over, and injury or damage could result.

**Do not place the projector into water or let it become wet.**

- Failure to observe this may result in fire or electric shocks.

**Do not place liquid containers on top of the projector.**

- If water spills onto the projector or gets inside it, fire or electric shocks could result.
- If any water gets inside the projector, contact an Authorised Service Center.

**Do not insert any foreign objects into the projector.**

- Do not insert any metal objects or flammable objects into the projector or drop them onto the projector, as doing so can result in fire or electric shocks.

**After removing the battery from remote control unit, keep it away from the reach of children.**

- The battery can cause death by suffocation if swallowed.
- If the battery is swallowed, seek medical advice immediately.

**Do not allow the + and - terminals of the battery to come into contact with metallic objects such as necklaces or hairpins.**

- Failure to observe this may cause the battery to leak, overheat, explode or catch fire.
- Store the battery in a plastic bag and keep it away from metallic objects.

**Insulate the battery using tape or similar before disposal.**

- If the battery comes into contact with metallic objects or other batteries, it may catch fire or explode.

## Caution

**Do not set up the projector in humid or dusty places or in places where the projector may come into contact with smoke or steam.**

- Using the projector under such conditions may result in fire or electric shocks.

**When disconnecting the power cord, hold the plug, not the cord.**

- If the power cord itself is pulled, the cord will become damaged, and fire, short-circuits or serious electric shocks may result.

**Always disconnect all cables before moving the projector.**

- Moving the projector with cables still attached can damage the cables, which could cause fire or electric shocks to occur.

**Do not place any heavy objects on top of the projector.**

- Failure to observe this may cause the projector to become unbalanced and fall, which could result in damage or injury.

**Do not short-circuit, heat or disassemble the battery or place it into water or fire.**

- Failure to observe this may cause the battery to overheat, leak, explode or catch fire, and burns or other injury may result.

**When inserting the battery, make sure the polarities (+ and -) are correct.**

- If the battery is inserted incorrectly, it may explode or leak, and fire, injury or contamination of the battery compartment and surrounding area may result.

**Use only the specified battery.**

- If an incorrect battery is used, it may explode or leak, and fire, injury or contamination of the battery compartment and surrounding area may result.

**Do not look into the lens while the projector is being used.**

- Strong light is emitted from the projector's lens. If you look directly into this light, it can hurt and damage your eyes.

**Do not bring your hands or other objects close to the air outlet port.**

- Heated air comes out of the air outlet port. Do not bring your hands or face, or objects which cannot withstand heat close to this port, otherwise burns or damage could result.

**Replacement of the lamp unit should only be carried out by a qualified technician.**

- The lamp unit has high internal pressure. It can easily become damaged if struck against hard objects or dropped, and injury or malfunctions may result.

**Disconnect the power cord plug from the wall outlet as a safety precaution before carrying out any cleaning.**

- Electric shocks can result if this is not done.





**Ask an Authorised Service Center to clean inside the projector at least once a year.**

- If dust is left to build up inside the projector without being cleaned out, it can result in fire or problems with operation.
- It is a good idea to clean the inside of the projector before the season for humid weather arrives. Ask your nearest Authorised Service Center to clean the projector when required. Please discuss with the Authorised Service Center regarding cleaning costs.

**We are in effort to hold your environment clean. Please bring the non repairable unit your Dealer or a Recycling Company.**

## Accessories

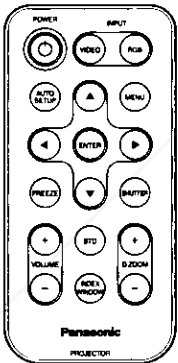
Check that all of the accessories shown below have been included with your projector.

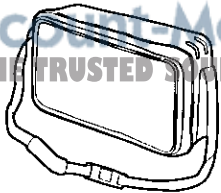
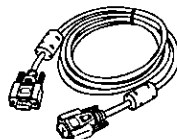
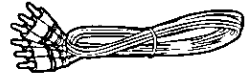
|   |  |  |
|---|--|--|
| <p>Card remote control unit (TNQE239 x1)</p>  | <p>Lens cover (TKKL5139 x1)</p>                       | <p>Lithium battery for remote control unit (CR2025 x1)</p>  |
| <p>Carrying bag (TPEP001 x1)</p>             | <p>RGB signal cable [2.0 m (6'7"), TSXF163 x1]</p>  | <p>Video/Audio cable [1.5 m (4'11"), TSXF015 x1]</p>      |

# Precautions on handling

## Cautions regarding transportation

**Be sure to attach the lens cover before transporting the projector.**

The projection lens is extremely susceptible to vibration and shocks. When carrying the projector, use the accessory carrying bag.

## Cautions regarding setting-up

Observe the following at all times when setting up the projector.

**Avoid setting up in places which are subject to vibration or shocks.**

If the projector is set up in locations with strong vibration, such as near a motor, or if it is installed inside a vehicle or on board a ship, the projector may be subjected to vibration or shocks which can damage the internal parts and cause malfunctions or accidents. Accordingly, set up the projector in a place which is free from such vibrations and shocks.

**Do not set up the projector near high-voltage power lines or near motors.**

The projector may be subject to electromagnetic interference if it is set up near high-voltage power lines or motors.

**If installing the projector to the ceiling, ask a qualified technician to carry out all installation work.**

If the projector is to be suspended from the ceiling, you will need to purchase the separate installation kit (Model No.: ET-PK701). Furthermore, all installation work should only be carried out by a qualified technician.

## Notes on use

**In order to get the best picture quality**

If outside light or light from indoor lamps is shining onto the screen, the images projected will not have good contrast. Draw curtains or blinds over any windows and turn off any fluorescent lights near the screen to prevent reflection.

**Do not touch the surfaces of the lens with your bare hands.**

If the surface of the lens becomes dirty from fingerprints or anything else, this will be magnified and projected onto the screen. Moreover, when not using the projector, retract the lens and then cover it with the accessory lens cover.

### About the screen

If the screen you are using is dirty, damaged or discolored, attractive projections cannot be obtained. Do not apply any volatile substances to the screen, and do not let it become dirty or damaged.

**Before carrying out cleaning and maintenance, be sure to disconnect the power cord plug from the wall outlet.**

**Wipe the cabinet with a soft, dry cloth.**

If the cabinet is particularly dirty, soak the cloth in water with a small amount of neutral detergent in it, squeeze the cloth very well, and then wipe the cabinet. After cleaning, wipe the cabinet dry with a dry cloth.

**If using a chemically-treated cloth, read the instructions supplied with the cloth before use.**

Do not wipe the lens with a cloth that is dusty or which produces lint.

If any dust or lint gets onto the lens, such dust or lint will be magnified and projected onto the screen. Use a blower to clean any dust and lint from the lens surface, or use a soft cloth to wipe off any dust or lint.



**Discount-Merchant.com (800) 281-8860**  
**THE TRUSTED SOURCE FOR PROJECTOR LAMPS AND ACCESSORIES**

# Location and function of each part

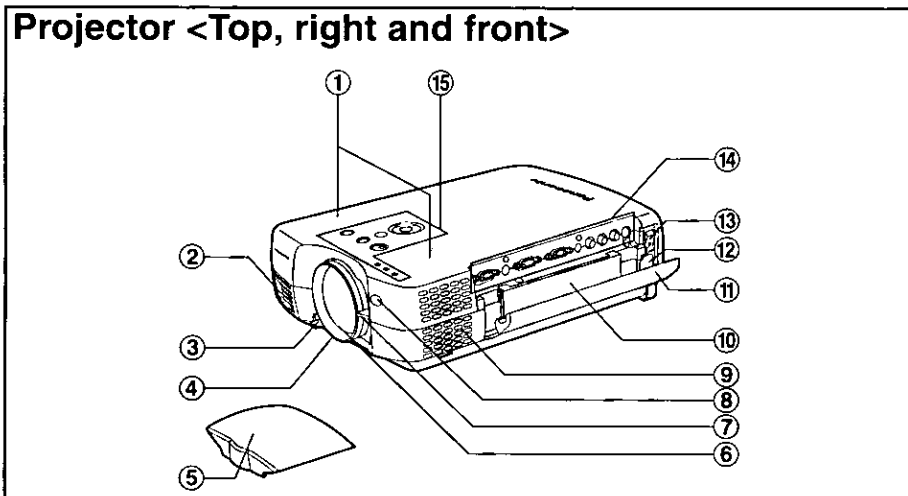

- ① **Stereo speakers**
- ② **Air inlet port**  
Do not cover this port.
- ③ **Leg adjuster button**  
(pages 12 and 23)  
This button is used to unlock the front adjustable leg. Press to adjust the angle of tilt of the projector.
- ④ **Focus ring**  
(pages 22 and 23)
- ⑤ **Lens cover**
- ⑥ **Projection lens**
- ⑦ **Zoom knob**  
(page 23)
- ⑧ **Remote control signal receptor**  
(page 16)
- ⑨ **Air filter**  
(page 42)
- ⑩ **Card remote control unit holder**  
(page 15)
- ⑪ **Carrying handle**  
When the handle is retracted, it covers the connector panel.
- ⑫ **Power input socket (AC IN)**  
(page 22)  
The accessory power cord is connected here.  
Do not use any power cord other than the accessory power cord.
- ⑬ **MAIN POWER switch**  
(pages 22 and 23)
- ⑭ **Connector panel**  
(page 13)  
Extend the carrying handle to use the terminal board.
- ⑮ **Projector control panel**  
(page 14)

## Projector <Back and bottom>

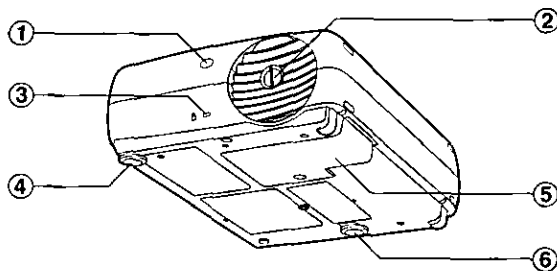

① **Remote control signal receptor**  
(page 16)

② **Air outlet**

You can turn the knob in the center of the air outlet to change the direction of air flow before turning on the power.

### CAUTION

**The air outlet will be hot during use and immediately after use.**

- Burns may result if you touch the air outlet while it is hot.

③ **Security lock**

This can be used to connect a commercially-available theft-prevention cable (manufactured by Kensington). This security lock is compatible with the Microsaver Security System from Kensington. Contact details for this company are given below. Kensington Technology Group ACCO Brands Inc.

2855 Campus Drive  
San Mateo, CA 94403  
Tel (650)572-2700  
Fax (650)572-9675  
<http://www.kensington.com/>  
<http://www.gravis.com/>

④ **Rear adjustable leg**

(page 23, refer to illustration at right)

⑤ **Lamp unit holder**  
(page 43)

⑥ **Front adjustable leg**

(page 23, refer to illustration below)

### Adjusting the angle of tilt

#### Adjusting the forward/back angle of tilt

Turn the front adjustable leg to the left or right to adjust the tilt. Furthermore, the front adjustable leg can be moved in and out freely when the adjuster button is pressed.

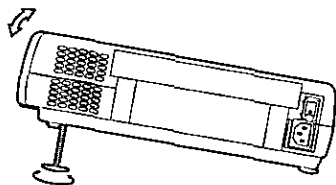

#### Adjusting the left/right angle of tilt

Turn the rear adjustable leg to the left or right to adjust the tilt.

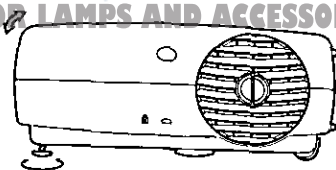

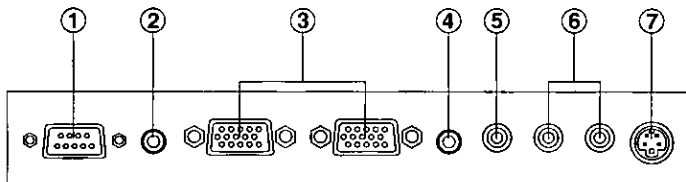
**<Connector panel>****① SERIAL connector**

(pages 18, 19 and 32)

This connector is used to connect a personal computer to the projector in order to externally control the projector. (RS-232C compatible)

**② AUDIO OUT jack**

(pages 18 and 19)

This jack is used to output the audio signals which are input to the projector. If audio equipment is connected to this jack, no sound will be output from the built-in speakers.

**③ RGB1 IN/RGB2 IN connectors**

(pages 18 and 19)

These connectors are used to input RGB signals and YPbPr signals.

**④ RGB AUDIO IN jack**

(pages 18 and 19)

Only one system is provided, so connect the appropriate connector when using RGB1 or RGB2.

**⑤ VIDEO IN jack**

(page 18)

This jack is used to input video signals from a video equipment such as a video deck.

**⑥ AUDIO IN L-R (for VIDEO/S-VIDEO) jacks**

(page 18)

Only one system is provided, so connect the appropriate connector when using VIDEO or S-VIDEO.

**⑦ S-VIDEO IN connector**

(pages 18 and 31)

This connector is used to input signals from a S-VIDEO-compatible equipment such as a video deck. The connector is S1 signal compatible, and it automatically switches between 16:9 and 4:3 aspect ratios in accordance with the type of signal being input.



Fixyourprojector.com

powered by DM

Discontinued Merchants.com (800) 281-8860

THE TRUSTED SOURCE FOR PROJECTOR LAMPS AND ACCESSORIES

## <Projector control panel and remote control unit>

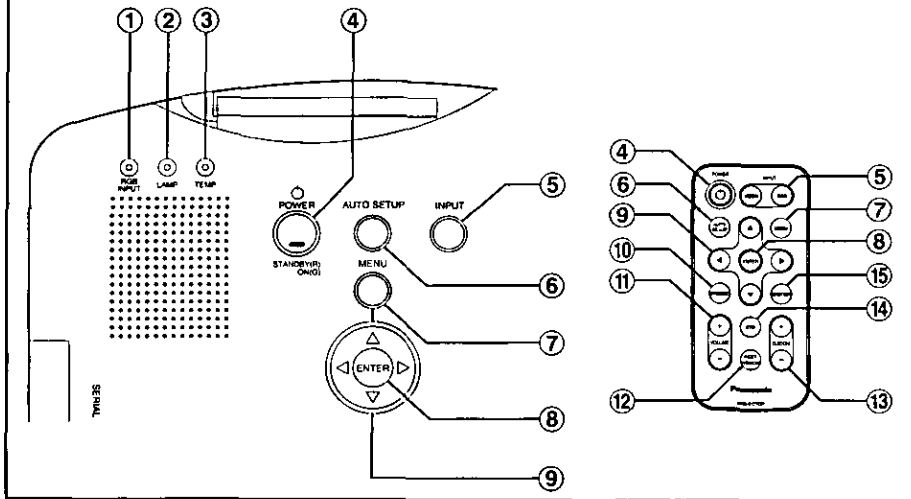

### ① RGB INPUT indicator

(page 24)

This indicator shows whether a signal is being input to the RGB input connectors (RGB 1 IN/RGB2 IN). When an input signal is detected, the indicator illuminates.

### ② LAMP indicator

(page 40)

This indicator illuminates when it is time to replace the lamp unit. It flashes if a circuit abnormality is detected.

### ③ TEMP indicator

(page 40)

This indicator illuminates if an abnormally high temperature is detected inside the projector. If the temperature rises above a certain level, the power supply will be turned off automatically and the indicator will illuminate or flash.

### ④ POWER button

(pages 22 and 23)

The POWER button on the projector's control panel has a built-in indicator. This indicator illuminates red when the MAIN POWER switch is turned on (standby mode), and illuminates green when the power is turned on and a picture starts to be projected.

### ⑤ Input select (INPUT, RGB, VIDEO) buttons

(page 22)

### ⑥ AUTO SETUP button

(pages 23 and 24)

If this button is pressed while a picture is being projected, the projection settings will be adjusted automatically in accordance with the signal being input. ("AUTO SETUP" will appear on the screen during adjustment.) If "AUTO KEYSTN" in the OPTION menu is set to "ON", the angle of tilt of the

projector will be automatically detected and adjusted in order to correct any keystone distortion.

**⑦ MENU button**

(pages 25 and 26)

This button is used to display menu screens. When a menu screen is being displayed, it can be used to return to a previous screen or to clear the screen.

**⑧ ENTER button**

(page 26)

This button is used to accept and to activate items selected in the on-screen menus.

**⑨ Arrow (▲, ▼, ◀ and ▶) buttons**

(page 26)

These buttons are used to select and adjust items in the on-screen menu screens.

**⑩ FREEZE button**

(page 27)

This button is used to momentarily freeze the image so that a still picture is displayed.

**⑪ VOLUME +/- buttons**

These buttons are used to adjust the volume of the sound output by the projector's built-in speakers. Refer to page 25 for details on how to adjust the volume using the buttons on the projector control panel.

**⑫ INDEX WINDOW button**

(page 34)

This button can be used to split the image projection area into a still image and a moving image.

**⑬ D.ZOOM +/- buttons**

(page 28)

These buttons are used to enlarge certain portions of the projected image.

**⑭ STD (standard) button**

(page 27)

This button is used to reset the projector adjustment values to the factory default settings.

**⑮ SHUTTER button**

(page 35)

This button is used to momentarily turn off the picture and sound.

### Storing the card remote control unit

**① Extend the carrying handle.**



**② Open the card remote control unit holder.**

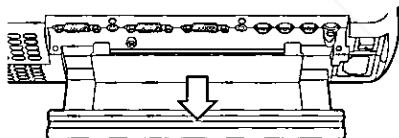

**③ Place the remote control unit inside.**

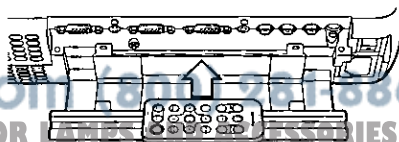

**④ Close the card remote control unit holder and retract the carrying handle.**



# Using the remote control unit

## Inserting the battery

Insert the lithium battery which is supplied with the remote control unit, making sure that the polarities are correct.

- ① While pushing the battery holder tab to the right, pull out the battery holder.

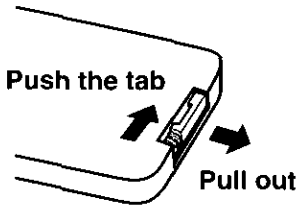

- ② Insert the battery into the battery holder so that the + side is facing upward.

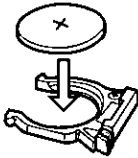

- ③ Insert the battery holder.

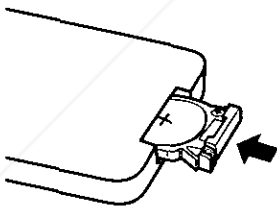

### NOTE:

- Do not drop the remote control unit.
- Keep the remote control unit away from liquids.
- Remove the battery if not using the remote control unit for long periods.
- Use only CR2025 batteries as replacement batteries.

## Operating range

If the remote control unit is held so that it is facing directly in front of the front or rear remote control signal receptors, the operating range is within approximately 7 m (23') from the surfaces of the receptors. Furthermore, the remote control unit can be operated from an angle of  $\pm 30^\circ$  to the left or right and  $\pm 15^\circ$  above or below the receptors.

### NOTE:

- If there are any obstacles in between the remote control unit and the receptors, the remote control unit may not operate correctly.
- If strong light is allowed to shine onto the remote control signal receptor, correct remote control operation may not be possible. Place the projector as far away from light sources as possible.
- If facing the remote control unit toward the screen to operate the projector, the operating range of the remote control unit will be limited by the amount of light reflection loss caused by the characteristics of the screen used.

# Connections

## Notes on connections

- Read the instruction manual for each system component carefully before connecting it.
- Turn off the power supply for all components before making any connections.
- If the cables necessary for connecting a component to the system are not included with the component or available as an option, you may need to fashion a cable to suit the component concerned.
- If there is a lot of jitter in the video signal which is input from the video source, the picture on the screen may flicker. In such cases, it will be necessary to connect a TBC (time base corrector).
- The projector has built-in speakers. However, you will need to connect a separate audio system to the AUDIO OUT jack if your needs specify high sound volumes. No sound will come out of the projector's built-in speakers while the AUDIO OUT jack is being used.
- It may not be possible to connect some types of computer. Refer to the list of compatible signals on page 50.
- The pin layout and signal names for the S-VIDEO IN connector are shown below.

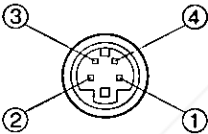

External view

| Pin No. | Signal                    |
|---------|---------------------------|
| ①       | Ground (Luminance signal) |
| ②       | Ground (Color signal)     |
| ③       | Luminance signal          |
| ④       | Color signal              |

- The pin layout and signal names for the RGB/YPbPr (RGB1 IN/RGB2 IN) connector are shown below.

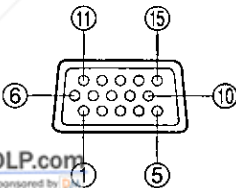

External view

| Pin No. | Signal     |
|---------|------------|
| ①       | R/Pr       |
| ②       | G/G-SYNC/Y |
| ③       | B/Pb       |
| ⑫       | SDA        |
| ⑬       | HD/SYNC    |
| ⑭       | VD         |
| ⑮       | SCL        |

Pin ⑨ is spare.

Pins ④-⑧, ⑩ and ⑪ are for ground.

Pins ⑫ and ⑮ functions are only valid when supported by the computer



FixYourDLP.com  
Sponsored by

Discount Merchant (800) 281-8860  
THE TRUSTED SOURCE FOR PROJECTOR SUPPLIES AND ACCESSORIES

## Example of connecting with video equipments

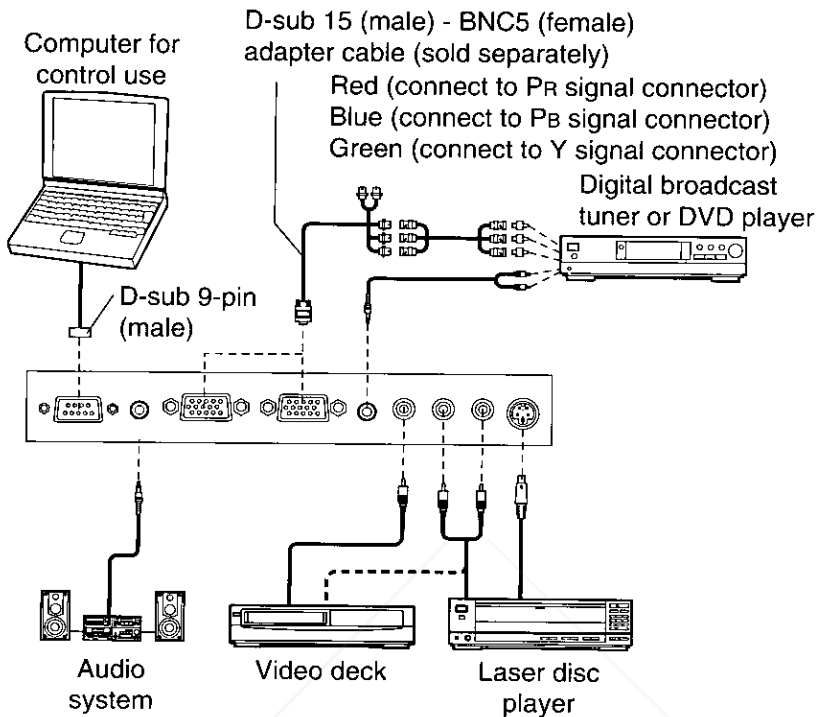

### NOTE:

- Only one audio system circuit is available for the AUDIO IN L-R jacks for S-VIDEO/VIDEO signals, so if you wish to change the audio input source, you will need to remove and insert the appropriate plugs.
- Only one audio system circuit is available for the RGB AUDIO IN jacks, so if you wish to change the audio input source, you will need to remove and insert the appropriate plugs.
- If an audio system is connected to the AUDIO OUT jack, the sound volume balance can be controlled by the remote control unit which is supplied with the projector.
- If the video signal source is connected using a cable with a BNC connector plug, use a BNC/RCA adapter (sold separately) to convert the cable end to an RCA plug-type jack.
- Refer to page 50 for a list of compatible YPBPR signals which can be input to the projector.
- If the signal cables are disconnected or if the power supply for the computer or video deck is turned off while the digital zoom or index window functions are being used, these functions will be cancelled.

# Example of connecting with computers

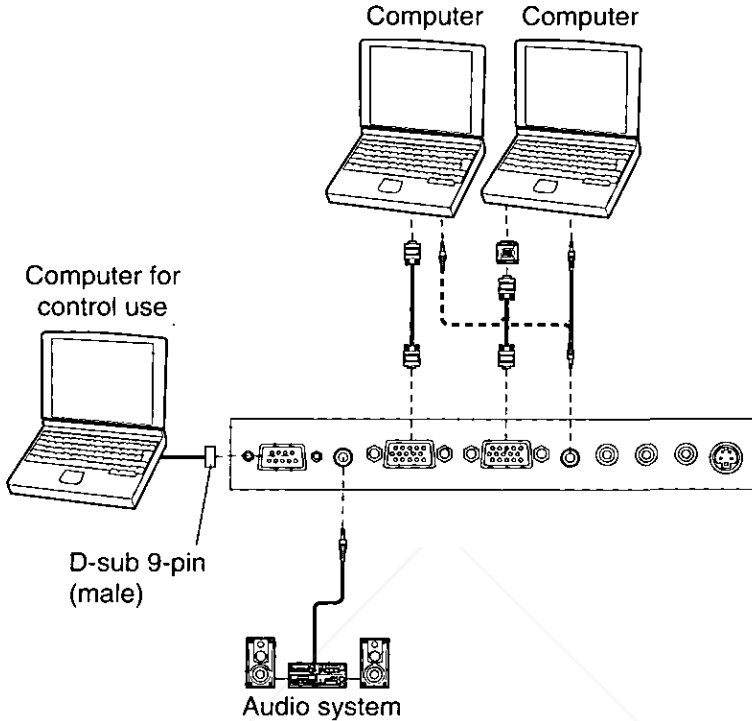



## NOTE:

- If the MAIN POWER switch for the projector is turned off, it's better to shut down the computer also.
- Refer to the list of compatible signals on page 50 for the types of RGB signals which can be input to the projector by connecting a computer.
- Only one audio system circuit is available for the RGB AUDIO IN jacks, so if you wish to change the audio input source, you will need to remove and insert the appropriate plugs.

# Setting-up

## Projection methods

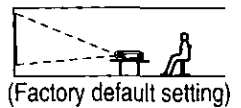
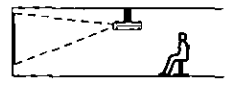
The projector can be set up so that any one of the following four projection methods are used. Select whichever projection method matches the setting-up method. (The projection method can be set from the Option menu. Refer to page 37 for details.)

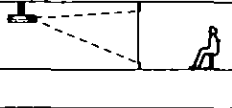
|            |       | DESK/CEILING   |   |
|------------|-------|--|---|
|            |       | DESK   | CEILING   |
| FRONT/REAR | FRONT | <br>(Factory default setting) |  |
|            | REAR  |                               |  |

### NOTE:

- You will need to purchase the separate ceiling bracket (ET-PK701) when using the ceiling installation method.

## Projector position

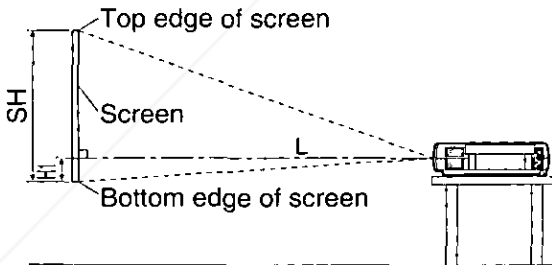

- L: Projection distance
- SH: Image height
- SW: Image width
- H1: Distance from center of lens to bottom edge of projected image ( $SH \div 10$ )

FixYourDLP.com  
Sponsored by CM

Discount-Merchant.com (800) 281-8860  
THE TRUSTED SOURCE FOR PROJECTOR LAMPS AND ACCESSORIES

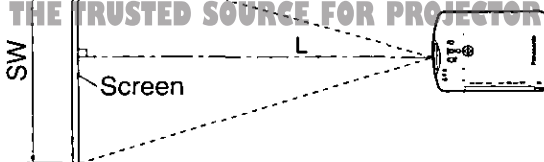

# Projection distances

| Screen size (4:3) |               |               | Projection distance (L) |                | Height position (H1) |
|-------------------|---------------|---------------|-------------------------|----------------|----------------------|
| Diagonal length   | Height (SH)   | Width (SW)    | Wide (LW)               | Telephoto (LT) |                      |
| 0.76 m(30°)       | 0.46 m(1'6")  | 0.61 m(2')    |                         | 1.15 m(3'9")   | 0.05 m(1-13/16")     |
| 1.01 m(40°)       | 0.61 m(2')    | 0.81 m(2'8")  | 1.18 m(3'10")           | 1.51 m(4'11")  | 0.06 m(2-13/32")     |
| 1.27 m(50°)       | 0.76 m(2'6")  | 1.02 m(3'4")  | 1.49 m(4'10")           | 1.90 m(6'2")   | 0.08 m(3")           |
| 1.52 m(60°)       | 0.91 m(3')    | 1.22 m(4')    | 1.80 m(5'10")           | 2.29 m(7'6")   | 0.09 m(3-19/32")     |
| 1.77 m(70°)       | 1.07 m(3'6")  | 1.42 m(4'8")  | 2.12 m(6'11")           | 2.68 m(8'9")   | 0.11 m(4-6/32")      |
| 2.03 m(80°)       | 1.22 m(4')    | 1.63 m(5'4")  | 2.43 m(7'11")           | 3.08 m(10'1")  | 0.12 m(4-26/32")     |
| 2.28 m(90°)       | 1.37 m(4'6")  | 1.83 m(6')    | 2.74 m(8'11")           | 3.47 m(11'4")  | 0.14 m(5-13/32")     |
| 2.54 m(100°)      | 1.52 m(5')    | 2.03 m(6'8")  | 3.05 m(10')             | 3.86 m(12'7")  | 0.15 m(6")           |
| 3.81 m(150°)      | 2.29 m(7'6")  | 3.05 m(10')   | 4.61 m(15'1")           | 5.83 m(19'1")  | 0.23 m(9")           |
| 5.08 m(200°)      | 3.05 m(10')   | 4.06 m(13'4") | 6.17 m(20'2")           | 7.79 m(25'6")  | 0.31 m(12")          |
| 6.35 m(250°)      | 3.81 m(12'6") | 5.08 m(16'8") | 7.73 m(25'4")           | 9.75 m(31'11") | 0.38 m(15")          |
| 7.62 m(300°)      | 4.57 m(15')   | 6.10 m(20')   | 9.29 m(30'5")           | 11.72 m(38'5") | 0.46 m(18")          |

Setting-up dimensions which are not given in the above table can be calculated using the formulas below.

If the screen size (diagonal) is SD (m), then the following formula is first used to obtain the screen width (SW).

$$SW = SD \times 4 \div 5$$

The value for SW obtained above can then be used with the following functions to calculate the projection distance for the wide lens position (LW) and the projection distance for the telephoto lens position (LT).

$$LW = 1.535 \times SW - 0.068$$

$$LT = 1.933 \times SW - 0.066$$

For 16:9 aspect ratios, the following formula can be used to calculate the screen width (SW).

$$SW = SD \times 16 \div \sqrt{337}$$

**NOTE:**

- The dimensions in the table above and the values obtained from the above formulas may contain slight errors.
- It is recommended that you use the projection distance for the wide lens position (except in cases where the diagonal picture size is 0.762 m [30"]).

 Fix Your DLP.com  
 Sponsored by DM

**Discount-Merchant.com (800) 281-8860**  
**THE TRUSTED SOURCE FOR PROJECTOR LAMPS AND ACCESSORIES**

# Starting to use

## Turning on the power

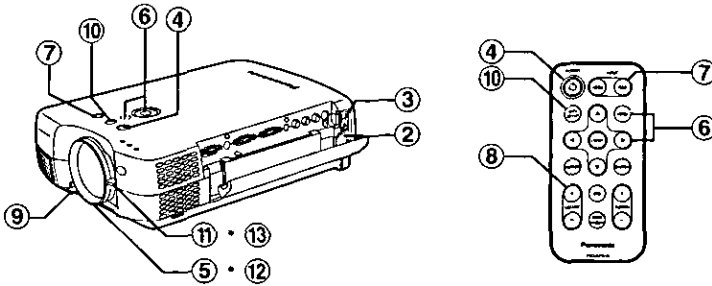

- ① Remove the lens cover.
- ② Connect the accessory power cord to a 100 V–240 V AC (50 Hz/60 Hz) power supply.
- ③ Press the MAIN POWER switch to the “|” side to turn on the power. The POWER button on the projector will illuminate red. You can check whether a signal is being input or not by checking the status of the RGB INPUT indicator. Refer to page 24.
- ④ Press the POWER button on the projector or remote control unit. The POWER button on the projector will flash green. After a short period, the button will illuminate green, and a picture will be projected.
- ⑤ Turn the focus ring to make broad adjustments to the picture focus.
- ⑥ Set the projection method. (pages 20 and 37)
- ⑦ Press the input select (INPUT, RGB, VIDEO) buttons on the projector or remote control unit to select the input signal. The input signal selected will change as shown in the table below each time an input select button is pressed.

|                     |       |                |              |
|---------------------|-------|----------------|--------------|
| Projector           | INPUT | RGB1(YPBPR1) → | RGB2(YPBPR2) |
|                     |       | ↑              | ↓            |
|                     |       | S-VIDEO ←      | VIDEO        |
| Remote control unit | RGB   | RGB1(YPBPR1) ↔ | RGB2(YPBPR2) |
|                     | VIDEO | S-VIDEO ↔      | VIDEO        |

- ⑧ Press the VOLUME +/- buttons on the remote control unit to adjust the volume. Refer to page 25 for details on how to adjust the volume using the buttons on the projector control panel.

- ⑨ While pressing the adjuster button, adjust the forward/back angle of tilt of the projector.

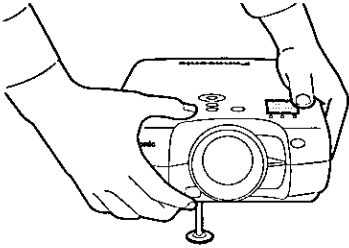

#### NOTE:

- If the projected picture is tilted to the right or left, turn the rear adjuster leg underneath the projector to the left or right. Refer to page 12.
- ⑩ Press the **AUTO SETUP** button on the projector or remote control unit.
- ⑪ Turn the zoom knob so that the size of the picture matches the size of the screen.  
Repeat steps ⑨ to ⑪ until the screen and the picture match.
- ⑫ Turn the focus ring to adjust the picture focus.
- ⑬ Turn the zoom knob once more so that the size of the picture matches the size of the screen.

## Turning off the power

- ① Press and hold the **POWER** button on the projector or remote control unit for 0.5 seconds, or press it twice.

The lamp unit will switch off and the picture will stop being projected. (The **POWER** button on the projector will illuminate orange.)

- ② Wait until the **POWER** button on the projector illuminates red (until the cooling fan stops). Never turn off the **MAIN POWER** switch, disconnect the power cord or shut off the mains power supply until the cooling fan stops.
- ③ Press the **MAIN POWER** switch to the “O” side to turn off the power.

#### NOTE:

- After the power is turned off, the lamp unit will take some time to cool down. If you turn the power back on again before the lamp unit has cooled down, the lamp unit may not turn on immediately, but it will turn on automatically after a short period. (During this time, the **POWER** button on the projector will flash orange.)
- When the projector is in standby mode (the **POWER** button on the projector is illuminated red), the projector will still draw a maximum 10 W of power, even when the cooling fan has stopped.
- If the **MAIN POWER** switch is accidentally turned off while the projector is being used, the lamp unit may not turn on immediately after the power is turned back on. In such cases, the lamp unit will turn back on automatically after a short period. (During this time, the **POWER** button on the projector will flash green.)
- A tinkling sound may be heard while the power indicator is turned off, but this is not a sign of a malfunction.



## About the RGB INPUT monitor

The RGB input monitor can be used to check whether an RGB/YPbPr signal is being input. Refer to the table below for details.

| RGB INPUT monitor status | Power supply status  |  |
|--------------------------|--|--|
|                          | Standby  | On (projecting)  |
| <b>Illuminated</b>       | A signal is being input to either the RGB1 IN or RGB2 IN connector.  | A signal is being input to the connector selected using the input select buttons.  |
| <b>Switched off</b>      | No signal is being input to either the RGB1 IN or RGB2 IN connector. | No signal is being input to the connector selected using the input select buttons. |

## About the automatic setup function

If you press the AUTO SETUP button, the items given in the table below will be set automatically. The setting details change according to the signal which is being input. Refer to the table below for details.

|                                | Horizontal/vertical position | Dot clock/clock phase | Auto RGB input select/Auto YPbPr select | Automatic keystone correction |
|--------------------------------|------------------------------|-----------------------|---|-------------------------------|
| <b>VIDEO/S-VIDEO</b>           |                              |                       |   | <b>Yes</b>                    |
| <b>YPbPr</b>                   |                              |                       |   | <b>Yes</b>                    |
| <b>UXGA</b>                    | <b>Yes</b>                   | <b>No</b>             |   | <b>Yes</b>                    |
| <b>Signal other than above</b> | <b>Yes</b>                   |                       |   |                               |

FixYourDLP.com

NOTE: Sponsored by LM.

- If the edges of the projected picture are indistinct, or if a dark picture is being projected, the automatic setup processing may stop automatically before it is complete. If this happens, project a different picture and then press the AUTO SETUP button once more, or make the above adjustments manually.
- If you would like to make further adjustments to the picture, use the menu commands which are listed on the next and subsequent pages.

# On-screen menus

## Menu screens

The various settings and adjustments for this projector can be carried out by selecting the operations from on-screen menus.

The general arrangement of these menus is shown below.

### MAIN MENU

|                  |  |
|------------------|--|
| MENU             |  |
| KEYSTONE         |  |
| PICTURE          |  |
| POSITION         |  |
| INDEX WINDOW     |  |
| SHUTTER          |  |
| AUDIO            |  |
| LANGUAGE         |  |
| OPTION           |  |
| SELECT ENTER ESC |  |

### OPTION menu (page 36)

|                     |         |    |  |
|---------------------|---------|----|--|
| OPTION              |         |    |  |
| INPUT DISP          | OFF     | ON |  |
| AUTO KEYSIN         | OFF     | ON |  |
| AUTO Y-PB-PR        | OFF     | ON |  |
| AUTO RGB IN         | OFF     | ON |  |
| RGB FORMAT          | Y-PB-PR |    |  |
| BACK COLOR          | BLUE    |    |  |
| FRONT/REAR          | FRONT   |    |  |
| DESK/CEILING        | DESK    |    |  |
| LAMP POWER          | STD     |    |  |
| LAMP RUNTIME        | LOH     |    |  |
| FUNC 1              | INDEX   |    |  |
| SELECT ADJ MENU ESC |         |    |  |

### LANGUAGE menu (page 35)

|           |  |                |
|-----------|--|----------------|
| LANGUAGE  |  | ENGLISH        |
| ENGLISH   |  | ENGLISH        |
| DEUTSCH   |  |                |
| FRANCAIS  |  |                |
| ESPAÑOL   |  |                |
| ITALIANO  |  |                |
| PORTUGUEZ |  |                |
| SELECT    |  | ENTER MENU ESC |

### Volume adjustment

Press the ENTER button, and then press the ◀ and ▶ buttons to adjust the volume.

### SHUTTER function

(page 35)

### INDEX WINDOW function

(page 34)

### Keystone correction

(page 29)

### PICTURE menu (page 30)

When an RGB/YPbPr signal is being input

|                      |        |
|----------------------|--------|
| PICTURE              |        |
| PICTURE MODE NATURAL |        |
| COLOR                |        |
| BRIGHT               | 32     |
| CONTRAST             | 32     |
| SHARPNESS            | 32     |
| W-BAL R              | 32     |
| W-BAL G              | 32     |
| W-BAL B              | 32     |
| SIGNAL MODE SVGA     |        |
| S1 SIGNAL            |        |
| RESIZING             | OFF ON |
| SELECT ADJ MENU ESC  |        |

### When an S-VIDEO/VIDEO

signal is being input

|                      |        |
|----------------------|--------|
| PICTURE              |        |
| PICTURE MODE NATURAL |        |
| COLOR                | 32     |
| TINT                 | 32     |
| BRIGHT               | 32     |
| CONTRAST             | 32     |
| SHARPNESS            | 8      |
| TV-SYSTEM            | AUTO1  |
| S1 SIGNAL            | 4:3    |
| RESIZING             | OFF ON |
| SELECT ADJ MENU ESC  |        |

### POSITION menu (page 33)

When an RGB/YPbPr signal is being input

|                       |    |
|-----------------------|----|
| POSITION              |    |
| H-POST                | 32 |
| V-POST                | 32 |
| DOT CLK               | 32 |
| CLK PHASE             | 32 |
| SELECT ENTER MENU ESC |    |

### When an S-VIDEO/VIDEO

signal is being input

|                       |    |
|-----------------------|----|
| POSITION              |    |
| H-POST                | 32 |
| V-POST                | 16 |
| VIDEO SIZE            | 32 |
| SELECT ENTER MENU ESC |    |

### NOTE:

- Keystone distortion of the on-screen display will not be corrected.

# Menu operation guide

- 1 Press the MENU button.  
The MAIN MENU screen will be displayed.

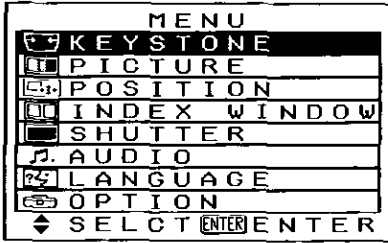

- 2 Press the ▲ or ▼ arrow buttons to select an item.  
Selected items will be displayed in yellow.

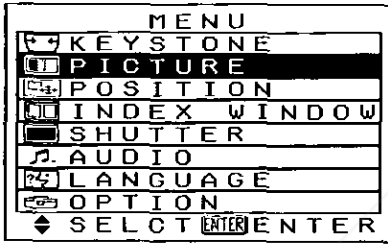

- 3 Press the ENTER button to accept the selection.  
The selected menu screen or adjustment screen will then be displayed.  
(Example: PICTURE menu)

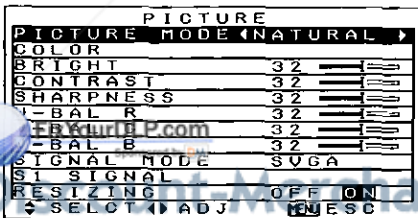

- 4 Press the ▲ or ▼ buttons to select an item, and then press the ◀ or ▶ buttons to change or adjust the setting.  
An individual adjustment screen such as the one shown below will be displayed for bar-scale items.



## White character display of on-screen items

This projector has unadjustable items and unusable functions depending on the signal being input. When an item cannot be adjusted or a function cannot be used, the corresponding on-screen menu display appears in white characters, and the item or function will not work even if the ENTER button is pressed.

## Returning to the previous screen

If you press the MENU button while a menu screen is being displayed, the display will return to the previous screen.

If you press the MENU button while the MAIN MENU screen is being displayed, the MAIN MENU screen will be cleared.

## Returning a setting to the factory default

If you press the STD (standard) button on the remote control unit, you can return settings to the factory default settings. However, the operation of this function varies depending on which screen is being displayed.

- When a menu screen is being displayed

| PICTURE              |     | STD |
|----------------------|-----|-----|
| PICTURE MODE NATURAL |     |     |
| COLOR                |     |     |
| BRIGHT               | 32  |     |
| CONTRAST             | 32  |     |
| SHARPNESS            | 32  |     |
| W-BAL R              | 32  |     |
| W-BAL G              | 32  |     |
| W-BAL B              | 32  |     |
| SIGNAL MODE SUGA     |     |     |
| SI SIGNAL            |     |     |
| RESIZING             | OFF | ON  |
| SELECT               |     | ESC |

All items displayed will be returned to their factory default settings, and "STD" will be displayed in the top-right corner of the screen.

- When an individual adjustment screen is being displayed

BRIGHT 32

Only the item displayed will be returned to the factory default setting, and the bar scale will appear green.

### NOTE:

- Triangle symbols above and below a menu bar indicate the factory default setting. Items which do not have these triangle symbols cannot be returned to the factory default setting.

Indicates the standard factory default setting



Indicates the current adjustment value

## Using the freeze function

The picture will alternate between a still picture and a moving picture each time the FREEZE button on the remote control unit is pressed.

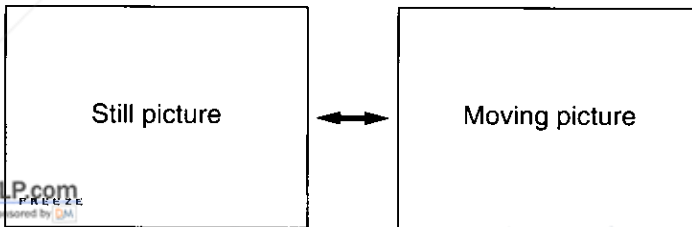

# Using the D.ZOOM (digital zoom) function

This function lets you enlarge a single section of the picture. Furthermore, the spot display mode which is used to select the section which is to be enlarged can also be used when making presentations.

① **Press a D.ZOOM +/- button.**

The projector will change to spot display mode.

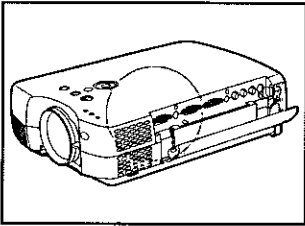

② **Use the ▲, ▼, ◀ and ▶ buttons to move the spot to the section which you would like to enlarge, and then press the ENTER button.**

The area around the spot will then be enlarged to twice the normal size.

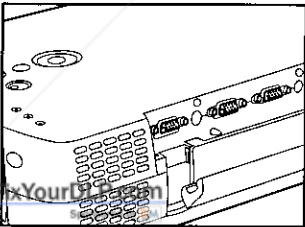

③ **Use the D.ZOOM +/- buttons to change the enlargement ratio.**

The enlargement ratio can be changed within the range of x1 to x3, in steps of 0.1.

④ **Press the MENU button to return to the normal screen.**

The projector will not return to spot display mode at this time. To return to spot display mode, clear the enlarged picture display from the screen and then press a D.ZOOM +/- button again.



**NOTE:**

- This function can only be used when using the remote control unit.
- If the type of signal being input changes while the digital zoom function is being used, the digital zoom function will be cancelled.

# Correcting keystone distortion

Keystone distortion is corrected automatically when the projector's automatic setup function is used, but this correction will not apply if the screen itself is tilted. In such cases, you can correct the keystone distortion manually with the following procedure.

- ① Select "KEYSTONE" from the MAIN MENU screen, and then press the ENTER button.
- ② Press the ◀ or ▶ buttons to correct the keystone distortion.

| Picture condition   | Operation           |
|---|---------------------|
|  | Press the ▶ button. |
|  | Press the ◀ button. |

- ③ Press the MENU button to return to the previous screen.

## NOTE:

- If you press the AUTO SETUP button after correcting the keystone distortion manually, the automatic keystone correction function will operate and the corrected picture will return to its previous incorrect condition. To prevent this from happening, you can set "AUTO KEYSTN" in the OPTION menu to "OFF".
- Keystone distortion can be corrected to  $\pm 30^\circ$  of the angle of tilt for the projector. However, the greater the correction amount, the more the picture quality will deteriorate, and the harder it will become to achieve a good level of focus. To obtain the best picture quality, set up the projector and screen in such a way that the amount of keystone correction required is as minimal as possible.
- The picture size will also change when correction of keystone distortion is carried out.

 FixYourDLP.com  
**Discount-Merchant.com (800) 281-8860**  
 THE TRUSTED SOURCE FOR PROJECTOR LAMPS AND ACCESSORIES

# Adjusting the picture

Use the ▲ and ▼ buttons on the projector or remote control unit to select an item, and then use the ◀ and ▶ buttons to change the setting for that item.

For items with bar scales, press the ENTER button or the ◀ or ▶ buttons to display the adjustment screen, and then use the ◀ or ▶ buttons to make the adjustment.

When an RGB/YPbPr signal is being input

| PICTURE                 |        |
|-------------------------|--------|
| PICTURE MODE ◀NATURAL▶  |        |
| COLOR                   |        |
| BRIGHT                  | 32     |
| CONTRAST                | 32     |
| SHARPNESS               | 32     |
| U-BAL R                 | 32     |
| U-BAL G                 | 32     |
| U-BAL B                 | 32     |
| SIGNAL MODE SUGA        |        |
| SIGNAL 4:3              |        |
| RESIZING                | OFF ON |
| ◀ SELECT ▶ ADJ MENU ESC |        |

When an S-VIDEO/VIDEO signal is being input

| PICTURE                 |        |
|-------------------------|--------|
| PICTURE MODE ◀NATURAL▶  |        |
| COLOR                   | 32     |
| TINT                    | 32     |
| BRIGHT                  | 32     |
| CONTRAST                | 32     |
| SHARPNESS               | 8      |
| TV-SYSTEM               | AUTO 1 |
| SIGNAL                  | 4:3    |
| RESIZING                | OFF ON |
| ◀ SELECT ▶ ADJ MENU ESC |        |

## PICTURE MODE

| PICTURE MODE ◀NATURAL▶ |  |
|------------------------|--|
| ▼ ▲                    |  |
| ◀DYNAMIC▶              |  |

This setting lets you adjust the picture quality in accordance with the video source and the conditions in the room to make the picture easier to see.

Select "NATURAL" to view the picture at standard brightness, and select "DYNAMIC" when viewing the picture in brighter environments.

## COLOR

(S-VIDEO/VIDEO/YPbPr only)

Press the ▶ button to make the color more vivid in tone, and press the ◀ button to make the color more pastel in tone.

## TINT

(NTSC/NTSC 4.43 only)

This adjusts the flesh tones in the picture. Press the ▶ button to make flesh tones more greenish, and press the ◀ button to make the flesh tones more reddish.

## BRIGHT

This adjusts the darker areas (black areas) in the picture. Press the ◀ button if dark areas are too solid (for example, if hair is difficult to see), and press the ▶ button if black areas are too light (grey rather than black).

## CONTRAST

This adjusts the contrast of the picture. Press the ▶ button to make the picture brighter, and press the ◀ button to make the picture darker. (Adjust the BRIGHT setting first if required before adjusting the CONTRAST setting.)

## SHARPNESS

Press the ▶ button to make the picture details sharper, and press the ◀ button to make the picture details softer.

## TV SYSTEM

(S-VIDEO/VIDEO only)

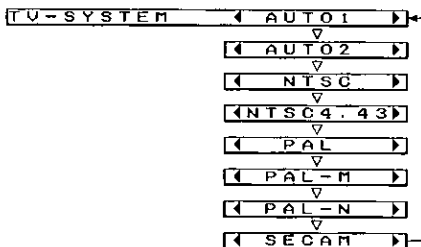

**AUTO1** The projector automatically distinguishes between NTSC/NTSC 4.43/PAL/SECAM signals.

**AUTO2** The projector automatically distinguishes between NTSC/PAL-M/PAL-N signals.

This should normally be set to "AUTO1" or "AUTO2". If the signal is of such poor quality that the correct format cannot be automatically distinguished, change the setting manually to the required TV system.

## WHITE BALANCE R/G/B

(RGB only)

This is used to adjust the white areas of the picture if they appear coloured.

Press the ◀ button to make the selected color lighter.

Press the ▶ button to make the selected color stronger.

## DISPLAY MODE

(RGB/YPbPr only)

This displays the type of signal which is currently being projected.

Refer to the table on page 50 for details on each type of signal.

## S1 SIGNAL

This setting is only valid for S-VIDEO/VIDEO signals and YPbPr signals in NTSC (480i), 480p and PAL (625i) format.

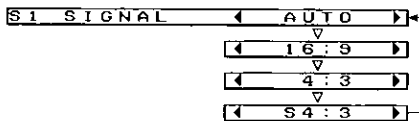

**AUTO** (S-VIDEO only)

When an S1 video signal is input to the S-VIDEO terminal, the aspect ratio is changed automatically to project a 16:9 picture.

**16:9** The picture is compressed to a ratio of 16:9 and projected.

**4:3** The input signal is projected without change.

**S4:3** The size of the input signal is compressed to 75% and projected. (This is useful for projecting a picture with a 4:3 aspect ratio onto a 16:9 screen.)

## S1 video signals

- S1 video signals are a type of video signal with an aspect ratio of 16:9 which include a detector signal. This detector signal is output by some sources such as wide-vision video decks. If the AUTO setting above is selected, this projector will recognise the detector signal and automatically switch the aspect ratio to 16:9 in order to project the picture.



## NOTE:

- This projector is equipped with an aspect ratio selection function. However, if a mode which does not match the aspect ratio of the input signal is selected, it may affect the quality of viewing of the original picture. Keep this in mind when selecting the aspect ratio.
- If using this projector in places such as cafes or hotels with the aim of displaying programs for viewing for a commercial purpose or for public presentation, note that if the aspect ratio (16:9) selection function is used to change the aspect ratio of the screen picture, you may be infringing the rights of the original copyright owner for that program under copyright protection laws.
- If a normal (4:3) picture which was not originally intended for wide-screen viewing is projected onto a wide screen, distortion may occur around the edges of the picture so that part of the picture is no longer visible. Such programs should be viewed in 4:3 mode to give proper consideration to the aims and intentions of the original program's creator.

## RESIZING

This should normally be set to "ON". (This setting is only for signals which have lower resolutions than the LCD panels. Refer to page 50 for details.)

**ON** The pixel resolution of the input signal is converted to the same resolution as the LCD panels before being projected. For signals with lower resolutions, gaps in the pixels are automatically interpolated into the picture before it is projected. This may sometimes cause problems with the quality of the picture.

**OFF** The picture signal is projected at its original resolution, with no pixel conversion. The projected picture will be smaller than normal, so adjust the zoom setting or move the projector forwards or backwards to adjust the picture size if necessary.



**Discount-Merchant.com (800) 281-8860**  
**THE TRUSTED SOURCE FOR PROJECTOR LAMPS AND ACCESSORIES**

# Adjusting the position

Use the ▲ and ▼ buttons on the projector or remote control unit to select an item, then press the ENTER button or the ◀ or ▶ buttons to display the adjustment screen, and then use the ◀ or ▶ buttons to make the adjustment.

When an RGB/YPbPr signal is being input

| POSITION  |                |
|-----------|----------------|
| H-POS I   | 32             |
| V-POS I   | 32             |
| DOT CLK   | 32             |
| CLK PHASE | 32             |
| SELECT    | ENTER MENU ESC |

When an S-VIDEO/VIDEO signal is being input

| POSITION   |                |
|------------|----------------|
| H-POS I    | 32             |
| V-POS I    | 16             |
| VIDEO SIZE | 32             |
| SELECT     | ENTER MENU ESC |

## HORIZONTAL POSITION

Press the ◀ button to move the picture to the left, and press the ▶ button to move the picture to the right.

## VERTICAL POSITION

Press the ▼ button to move the picture down, and press the ▲ button to move the picture up.

## VIDEO SIZE

(S-VIDEO/VIDEO only)

Press the ◀ button to make the picture smaller, and press the ▶ button to make the picture larger.

## DOT CLOCK

(RGB only)

Periodic striped pattern interference (noise) may occur when a striped pattern such as the one below is projected. If this happens, use the ◀ and ▶ buttons to adjust so that any such noise is minimised.

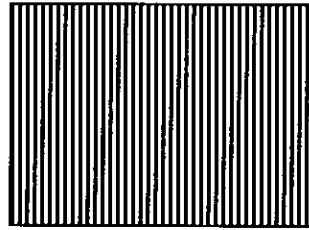

## CLOCK PHASE

(RGB only)

Adjust the DOT CLOCK setting first before carrying out this adjustment. Use the ◀ and ▶ buttons to adjust so that the noise level is least noticeable.

### NOTE:

- When an UXGA signal is being projected, interference may not be completely eliminated when the DOT CLOCK and CLOCK PHASE adjustments are carried out.



Sponsored by DM

Discount-Merchant.com (800) 281-8860

THE TRUSTED SOURCE FOR PROJECTOR LAMPS AND ACCESSORIES

# Using the INDEX WINDOW function

This function lets you store a picture which is being projected into memory, so that you can display a still picture and a moving picture on the screen.

① **Press the INDEX WINDOW button.**

You can also select INDEX WINDOW from the MAIN MENU screen and then press the ENTER button.

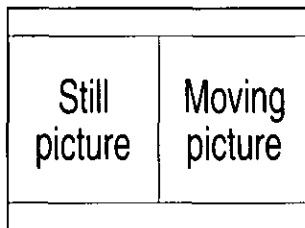

**NOTE:**

- The screen aspect ratio will become 2:3, and the ratio of the height of the picture to its width will become 1.5 times the normal ratio.

② **Use the ▲ and ▼ buttons to set the screen height.**

The vertical height can be set to one of three heights: x1, x1.5 and x2.

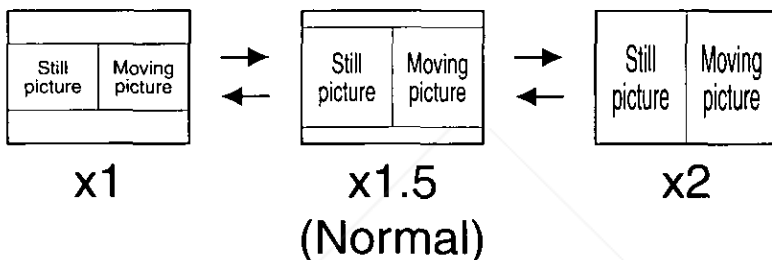

③ **Use the ◀ and ▶ buttons to switch between the still picture screen (left) and moving picture screen (right).**

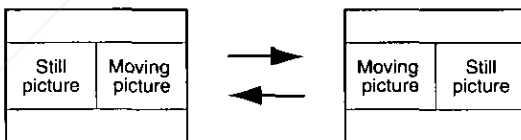

④ **Press the ENTER button to store the picture in memory.**

**NOTE:**

- When the screen size is changed, the picture's aspect ratio will also change. Make sure that you fully understand the notes on S1 signals which are given on page 32 before using the index window function.
- When steps ② and ③ are carried out, the memory will be reset and a new picture will be stored in memory.

# Using the shutter function

The shutter function can be used to momentarily turn off the picture and sound from the projector when the projector is not being used for short periods of time, such as during breaks in meetings or when carrying out preparation. The projector uses less power in shutter mode than it does in normal projection mode.

- ① **Press the SHUTTER button on the remote control unit.**  
You can also select SHUTTER from the MAIN MENU screen and then press the ENTER button.
- ② **Press any button on either the projector or remote control unit to return to normal operating mode.**

# Changing the display language

Use the ▲ and ▼ buttons on the projector or remote control unit to select a language, then press the ENTER button to accept the setting.

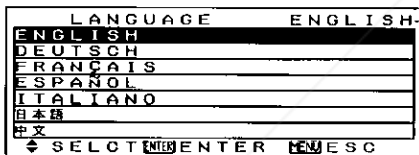

Indicates the language which is currently set

# Option settings

Use the ▲ and ▼ buttons on the projector or remote control unit to select an item, then press the ◀ or ▶ buttons to change the setting.

| OPTION                      |         | OFF | ON |
|-----------------------------|---------|-----|----|
| INPUT DISP                  |         | OFF | ON |
| AUTO KEYSTN                 |         | OFF | ON |
| AUTO Y·PB·PR                |         | OFF | ON |
| AUTO RGB IN                 |         | OFF | ON |
| RGB FORMAT                  | Y·PB·PR |     |    |
| BACK COLOR                  | BLUE    |     |    |
| FRONT/REAR                  | FRONT   |     |    |
| DESK/CEILING                | DESK    |     |    |
| LAMP POWER                  | STD     |     |    |
| LAMP RUNTIME                | 10H     |     |    |
| FUNC 1                      | INDEX   |     |    |
| ◀ SELECT ▶ ADJ ◀ MENU ▶ ESC |         |     |    |

## SCREEN DISPLAY

- ON** The signal name is displayed in the top-right corner of the screen when the input signal is changed.
- OFF** Use this setting when you do not want the signal name to be displayed.

## AUTO KEYSTN

This should normally be set to ON.

- ON** During automatic setup, the angle of tilt of the projector is detected and keystone distortion is corrected automatically.
- OFF** Use this setting when you do not want automatic keystone correction to be carried out during automatic setup, such as when the screen itself is at an angle.

## AUTO Y·PB·PR

| Input signal        | AUTO Y·PB·PR   |                                  |
|---------------------|--|----------------------------------|
|                     | ON   | OFF                              |
| <b>HDTV (1080i)</b> | RGB or YPbPr is selected automatically depending on the synchronising signal status. | RGB format setting becomes valid |
| <b>Other</b>        | RGB or YPbPr is selected automatically depending on the synchronising signal status. |                                  |

## AUTO RGB IN

This should normally be set to ON.

- ON** During automatic setup, the projector selects whichever one of the RGB1 IN or RGB2 IN connectors has a signal being input, and uses that signal for projection. (If a picture is being projected, the signal source is not automatically changed.)
- OFF** Use this setting when you do not want the signal source to be changed automatically during automatic setup.

## RGB FORMAT

|            |         |
|------------|---------|
| RGB FORMAT | Y·PB·PR |
|            | ▲ ▼     |

This setting is only valid when an HDTV (1080i) signal is being input and "AUTO Y·PB·PR" is set to OFF.

## BACK COLOR

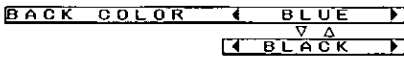

This sets the color which is projected onto the screen when no signal is being input to the projector.

## FRONT/REAR

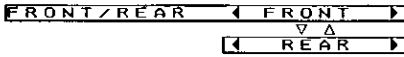

This setting should be changed in accordance with the projector setting-up method.

Set to "FRONT" when using a normal reflective screen with the projector positioned in front of the screen, and set to "REAR" when using a translucent screen with the projector positioned behind the screen.

## DESK/CEILING

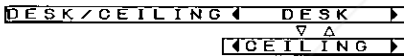

This setting should be changed in accordance with the projector setting-up method.

Set to "DESK" when setting up the projector on a desk or similar, and set to "CEILING" when suspending the projector from the ceiling using the ceiling bracket which is sold separately.

## LAMP POWER

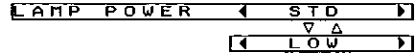

This setting changes the lamp brightness. When set to "LOW", the luminance of the lamp is reduced, but the projector uses less power, and the operating noise is also reduced. This can help to extend the lamp's operating life. If using the projector in small rooms where high luminance is not required, it is recommended that you set the LAMP POWER to "LOW".

## LAMP TIME

This setting displays the usage time for the lamp unit which is currently being used.

### NOTE:

- The lamp's operating life varies depending on the usage conditions (such as the LAMP POWER setting and the number of times the power is turned on and off).

## FUNC 1



This assigns a function to the F1 button of the ET-RM100 full function remote control unit (sold separately).

### INDEX

- Functions in the same way as the INDEX WINDOW button on the accessory card remote control unit. (page 34)

### KEYSTONE AND ACCESSORIES

- Functions in the same way as when "KEYSTONE" is selected from the MAIN MENU screen. (page 29)

# Using the SERIAL connector

The serial connector which is on the side connector panel of the projector conforms to the RS-232C interface specification, so that the projector can be controlled by a personal computer which is connected to this connector.

## Connection

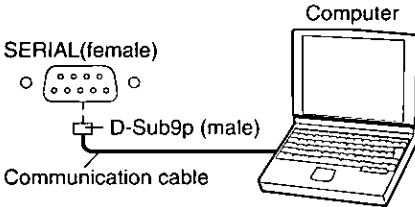

### NOTE:

- Use a proper communication cable which is suitable for the personal computer to connect the serial connector and the personal computer.

## Pin layout and signal names for SERIAL connector

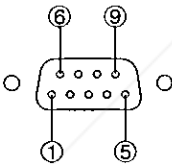

D-SUB 9-pin connector seen from outside

| Pin No. | Signal name | Contents             |
|---------|-------------|----------------------|
| ①       |             | NC                   |
| ②       | TXD         | Transmitted data     |
| ③       | RXD         | Received data        |
| ④       |             | Connected internally |
| ⑤       | GND         |                      |
| ⑥       |             | NC                   |
| ⑦       | CTS         | Connected internally |
| ⑧       | RTS         |                      |
| ⑨       |             | NC                   |

## Communications settings

|                  |              |
|------------------|--------------|
| Signal level     | RS-232C      |
| Sync. method     | Asynchronous |
| Baud rate        | 9600 bps     |
| Parity           | None         |
| Character length | 8 bits       |
| Stop bit         | 1 bit        |
| X parameter      | None         |
| S parameter      | None         |

## Basic format

The data sent from the computer to the projector is transmitted in the format shown below.

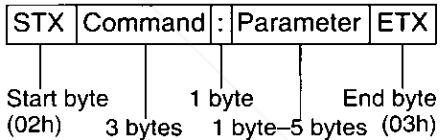

### NOTE:

- If sending multiple commands, check that a response has been received from the projector for one command before sending the next command.
- When a command which does not require parameters is sent, the colon (:) is not required.
- If an incorrect command is sent from the personal computer, the "ER401" command will be sent from the projector to the personal computer.

## Control commands

The commands which the personal computer can use to control the projector are shown in the following table.

| Command | Control Contents        | Remarks  |
|---------|-------------------------|--|
| PON     | Power ON                | In standby mode, all commands other than the PON command are ignored. <ul style="list-style-type: none"> <li>• The PON command is ignored during lamp ON control.</li> <li>• If a PON command is received while the cooling fan is operating after the lamp has switched off, the lamp is not turned back on again straight away, in order to protect the lamp.</li> </ul> |
| POF     | Power OFF               |  |
| AVL     | Volume                  | Parameter<br>000-063(Adjustment value 0-63)  |
| IIS     | Input signal selection  | Parameter<br>VID=VIDEO                      SVD=S-VIDEO<br>RG1=RGB1(YPBPR1)      RG2=RGB2(YPBPR2)  |
| ORF     | RGB format selection    | Parameter<br>0=RGB                              1=YPBPR  |
| QSS     | Lamp ON condition query | Parameter<br>0 = Standby<br>1 = Lamp ON control active<br>2 = Lamp ON<br>3 = Lamp OFF control active   |

## Cable specifications

(When connected to a personal computer)

At the projector

At the computer  
(DTE specifications)

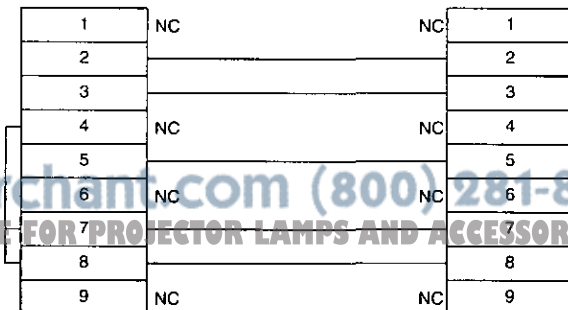



# Indicators

There are two indicators on the control panel of the projector which give information about the operating condition of the projector. These indicators illuminate or flash to warn you about problems that have occurred inside the projector, so if you notice that one of the indicators is on, turn off the power and check the table below for the cause of the problem.

| TEMP indicator        |   |  |   |
|-----------------------|---|--|---|
| Indicator display     | illuminated (red)<br>(Lamp unit on)   | Flashing (red)<br>(Lamp unit off)  | illuminated (red)<br>(Lamp unit off)  |
| <b>Problem</b>        | The internal projector temperature is too high.   | The lamp has turned off automatically (the projector is in standby mode) because the internal temperature has risen to an abnormally high level. | The lamp has turned off automatically (the projector is in standby mode) because the internal temperature has risen to an abnormally high level, or because an abnormally rapid temperature variation occurred. |
| <b>Possible cause</b> | <ul style="list-style-type: none"> <li>• The ventilation holes may be covered.</li> <li>• The ambient temperature in the place of use may be too high.</li> <li>• The air filter may be blocked.</li> </ul>   |  |   |
| <b>Remedy</b>         | <ul style="list-style-type: none"> <li>• Uncover the ventilation holes.</li> <li>• Set up the projector in a place where the temperature is between 0 °C (32 °F) and 40 °C (104 °F) and the humidity is between 20% and 80% (with no condensation).</li> <li>• Turn off the MAIN POWER switch by following the procedure on page 23, and then clean the air filter (refer to page 42).</li> </ul> |  |   |

| LAMP indicator        |  |   |  |
|-----------------------|--|---|--|
| Indicator display     | Illuminated (red)  | Flashing (red)  |  |
| <b>Problem</b>        | It is nearly time to replace the lamp unit.  | An abnormality has been detected in the lamp circuit.   |  |
| <b>Possible cause</b> | <ul style="list-style-type: none"> <li>Does "REPLACE LAMP" appear on the screen after the projector is turned on?</li> </ul>   | <ul style="list-style-type: none"> <li>The power may have been turned on immediately after it was turned off.</li> </ul>                  | <ul style="list-style-type: none"> <li>There may be an abnormality in the lamp circuit.</li> </ul>   |
| <b>Remedy</b>         | <ul style="list-style-type: none"> <li>This occurs when the operation time for the lamp unit is nearing 1800 hours. (when LAMP POWER has been set to "STD") Ask your dealer or an Authorised Service Center to replace the lamp unit.</li> </ul> | <ul style="list-style-type: none"> <li>Wait for a while until the lamp unit cools down before turning the power back on again.</li> </ul> | <ul style="list-style-type: none"> <li>Turn off the MAIN POWER switch by following the procedure given on page 23, and then contact an Authorised Service Center.</li> </ul> |

**NOTE:**

- Be sure to turn off the MAIN POWER switch by following the procedure given in "Turning off the power" on page 23 before carrying out any of the procedures in the "Remedy" column.
- If the main power turns off after the TEMP indicator starts flashing, it means that an abnormality has occurred. Please contact an Authorised Service Center so that the necessary repairs can be made.



**Discount-Merchant.com (800) 281-8860**  
**THE TRUSTED SOURCE FOR PROJECTOR LAMPS AND ACCESSORIES**

Others

# Cleaning and replacing the air filter

If the air filter becomes clogged with dust, the internal temperature of the projector will rise, the TEMP indicator will flash and the projector power will turn off. **The air filter should be cleaned every 100 hours of use,** depending on the location where the projector is being used.

## Cleaning procedure

- ① **Turn off the MAIN POWER switch and disconnect the power cord plug from the wall outlet.**

Turn off the MAIN POWER switch according to the procedure given in "Turning off the power" on page 23 before disconnecting the plug from the wall outlet.

- ② **Gently turn the projector upside down.**

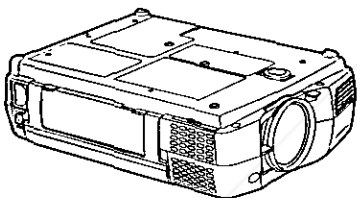

### NOTE:

- Place the projector on top of a soft cloth so that it will not become scratched.

- ③ **Remove the air filter.**

Put your fingernails under the air filter and pull the air filter out of the projector.

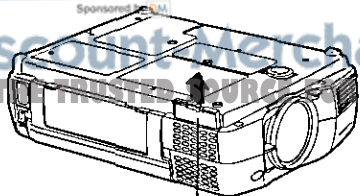

Air filter

- ④ **Clean the air filter.**

Use a vacuum cleaner to clean off any accumulated dust.

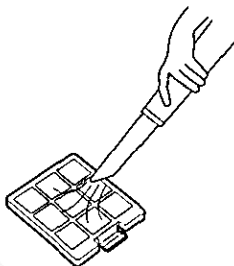

### NOTE:

- Be careful not to let the air filter get sucked into the vacuum cleaner.

- ⑤ **Install the air filter.**

### NOTE:

- Be sure to install the air filter cover before using the projector. If the projector is used without the air filter cover installed, dust and other foreign particles will be drawn into the projector, and malfunctions will result.
- If the dust cannot be removed by cleaning, it is time to replace the air filter. Please consult your dealer. Furthermore, if the lamp unit is being replaced, replace the air filter at this time also.

# Replacing the lamp unit

## Caution

The lamp unit should only be replaced by a qualified technician.

The lamp cover will be hot after use.

- Burns may result if you touch the lamp cover while it is hot.

## Notes on replacing the lamp unit

- Take extreme care when handling the removed lamp unit, as it contains gas under high pressure and can easily become damaged if it is struck against hard objects or dropped.
- The old lamp unit may shatter if it is handled roughly after removal. Ask an authorised waste disposal agency to dispose of the old lamp unit.
- A Phillips screwdriver is necessary for removing the lamp unit. Make sure that your hands are not slippery when using the screwdriver.

### NOTE:

- The projector is not supplied with a replacement lamp unit. Please ask your dealer for details. Lamp unit product no.: **ET-LA702**

### CAUTION:

- Do not use any lamp unit other than the one with the product number indicated above.

## Lamp unit replacement period

The lamp used as the light source for this projector is a consumable part. The normal operating life of the lamp unit is about 2000 hours, however the lamp unit may stop projecting before 2000 hours of operation is reached, depending on the characteristics of the lamp and also on the conditions under which the lamp is being used. (If the lamp is turned on and off very frequently, or if the waiting period between turning it off and turning it back on again is too short, it may cause the operating life of the lamp unit to be shortened.) It is recommended that you always have a replacement lamp unit ready for use if needed. Furthermore, the operating life can be extended by setting LAMP POWER in the OPTION menu to "LOW".

If the lamp is not replaced after the cumulative usage time has passed 1800 hours (when LAMP POWER has been set to "STD"), the power will automatically turn off and the projector will switch to standby mode when the cumulative usage time reaches 2000 hours. If you turn the power back on after this 2000-hour mark has been exceeded, the projector will automatically switch to standby mode again after approximately 10 minutes.



Discount Merchant.com (800) 281-8869

THE TRUSTED SOURCE FOR PROJECTOR LAMPS AND ACCESSORIES

Others

## Screen display once cumulative usage time exceeds 1800 hours

If you continue to use the lamp unit after 1800 hours of total usage time have passed (when LAMP POWER has been set to "STD"), the LAMP indicator will illuminate, even when the projector is in standby mode. The on-screen display shown at right will appear as a reminder to replace the lamp unit 10 minutes before the power is due to turn off automatically. This display will continue to appear until a button such as the MENU button or the VOLUME +/- buttons is pressed.

REPLACE LAMP

## Lamp unit replacement procedure

### NOTE:

- If the lamp usage time has passed 2000 hours (when LAMP POWER has been set to "STD"), the projector will switch to standby mode after approximately 10 minutes of operation. The steps on the next page should thus be completed within 10 minutes.

① Turn off the MAIN POWER switch according to the procedure given in "Turning off the power" on page 23, and then disconnect the power cord plug from the wall outlet and check that the area around the lamp unit has cooled down.

② Use a Phillips screwdriver to turn the lamp unit cover fixing screws at the bottom of the projector, and then remove the lamp unit cover from the projector.

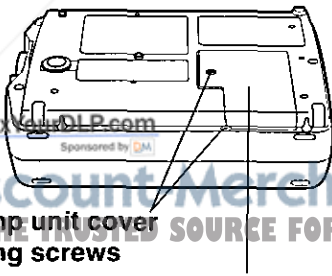

Lamp unit cover fixing screws

Lamp unit cover

③ Use a Phillips screwdriver to loosen the two lamp unit fixing screws until the screws turn freely. Then hold the handle of the lamp unit and gently pull it out from the projector.

Lamp unit fixing screws

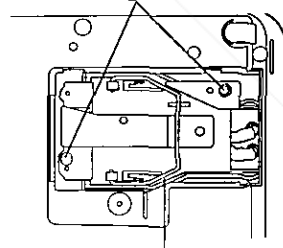

Handle

### Caution

The lamp unit will be hot after it has been used.

- You might get burned if you touch it while it is still hot.

④ Insert the new lamp unit while making sure that the direction of insertion is correct, and then use a Phillips screwdriver to securely tighten the lamp unit fixing screws.

- ⑤ Install the lamp unit cover, and then use a Phillips screwdriver to securely tighten the lamp unit cover fixing screws.

**NOTE:**

- Be sure to install the lamp unit and the lamp unit cover securely. If they are not securely installed, it may cause the protection circuit to operate so that the power cannot be turned on.

- ⑥ Insert the power cord plug into the wall outlet and then press the MAIN POWER switch.

**NOTE:**

- If the POWER button on the projector does not illuminate red when the MAIN POWER switch is turned on, turn the MAIN POWER switch off again and check that the lamp unit and the lamp unit cover are securely installed. Then turn the MAIN POWER switch back on.

- ⑦ Press the POWER button so that a picture is projected onto the screen.
- ⑧ Press the MENU button to display the MAIN MENU screen, and then press the ▲ and ▼ buttons to move the cursor to select “OPTION”.

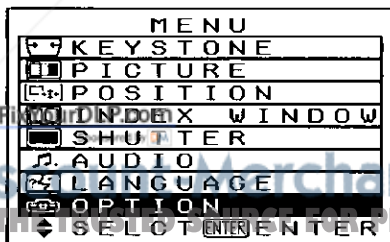

- ⑨ Press the ENTER button to display the OPTION screen, and then use the ▲ and ▼ buttons to select LAMP TIME.

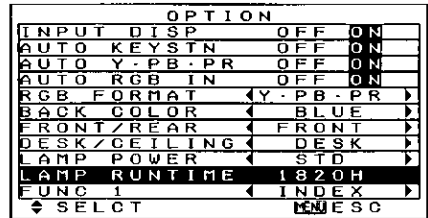

- ⑩ Press and hold the ENTER button on the control panel of the projector for approximately 3 seconds.

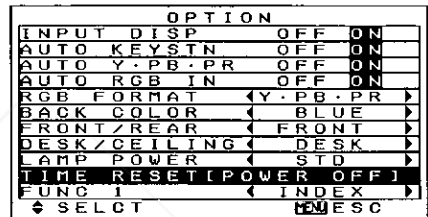

The “LAMP TIME” will change to “TIME RESET [POWER OFF]”.

**NOTE:**

- This operation will not work if the ENTER button on the remote control unit is pressed.
  - If the MENU button is pressed, the lamp time resetting screen will be cancelled.
- ⑪ Press and hold the POWER button for 0.5 seconds or press it twice to turn off the power. This will reset the cumulative usage time for the lamp unit to zero.

# Before asking for service

Before asking for service, check the following points.

| Problem                                   | Possible cause   |
|---|--|
| <b>Power does not turn on.</b>            | <ul style="list-style-type: none"><li>• The power cord may not be connected.</li><li>• The MAIN POWER switch is turned off.</li><li>• The main power supply is not being supplied to the wall outlet.</li><li>• TEMP indicator is illuminated or flashing. (Refer to page 40.)</li><li>• LAMP indicator is illuminated or flashing. (Refer to page 40.)</li><li>• The lamp unit cover has not been securely installed.</li></ul> |
| <b>No picture appears.</b>                | <ul style="list-style-type: none"><li>• The video signal input source may not be connected properly.</li><li>• The input selection setting may not be correct. (Refer to page 22.)</li><li>• The BRIGHT adjustment setting may be at the minimum possible setting. (Refer to page 30.)</li><li>• The shutter function may be in use. (Refer to page 35.)</li></ul>   |
| <b>The picture is fuzzy.</b>              | <ul style="list-style-type: none"><li>• The lens cover may still be attached to the lens.</li><li>• The lens focus may not have been set correctly. (Refer to pages 22 and 23.)</li><li>• The projector may not be at the correct distance from the screen. (Refer to pages 20 and 21.)</li><li>• The lens may be dirty.</li><li>• The projector may be tilted too much. (Refer to page 23.)</li></ul>                           |
| <b>COLOR is too light or TINT is poor</b> | <ul style="list-style-type: none"><li>• COLOR or TINT adjustment may be incorrect. (Refer to page 30.)</li><li>• The input source which is connected to the projector may not be adjusted correctly.</li></ul>   |
| <b>No sound can be heard.</b>             | <ul style="list-style-type: none"><li>• The audio signal source may not be connected properly.</li><li>• A cable may be connected to the AUDIO OUT jack.</li><li>• The volume adjustment may be at the lowest possible setting. (Refer to pages 15 and 25.)</li></ul>  |

| Problem  | Possible cause  |
|--|---|
| <b>Remote control unit does not operate.</b>   | <ul style="list-style-type: none"> <li>● The battery may be weak.</li> <li>● The battery may not be inserted correctly. (Refer to page 16.)</li> <li>● The remote control signal receptor on the projector may be obstructed. (Refer to page 16.)</li> <li>● The remote control unit may be out of the operation range. (Refer to page 16.)</li> </ul>  |
| <b>The picture does not display correctly.</b> | <ul style="list-style-type: none"> <li>● The correct input signal may not be selected. (Refer to page 22.)</li> <li>● The signal format (TV system) may not be set correctly. (Refer to page 31.)</li> <li>● There may be a problem with the video tape or other signal source.</li> </ul>  |
| <b>Picture from computer does not appear</b>   | <ul style="list-style-type: none"> <li>● A signal which is not compatible with the projector may be being input. (Refer to page 50.)</li> <li>● The cable may be too long.</li> <li>● The external video output for the laptop computer may not be set correctly.<br/>(You may be able to change the external output settings by pressing the [Fn]+[F3] or [Fn]+[F10] keys simultaneously. The actual method varies depending on the type of computer, so refer to the documentation provided with your computer for further details.)</li> <li>● If an RGB input monitor (refer to pages 14 and 24) is turned off, the video signals may not be output from the computer.</li> </ul> |



# Specifications

|                                |  |
|--------------------------------|--|
| Power supply:                  | 100 V–240 V ~, 50 Hz/60 Hz   |
| Power consumption:             | 240 W (During standby (when fan is stopped): Approx. 5 W–10 W)         |
| Amps:                          | 2.8 A–1.0 A  |
| LCD panel:                     |  |
| Panel size (diagonal):         | 0.9 type (22.86 mm)  |
| Aspect ratio:                  | 4:3 (16:9 compatible)  |
| Micro lens array:              |  |
| PT-L711XU:                     | Available  |
| PT-L701XU/PT-L511XU/PT-L501XU: | Not available  |
| Display method:                | 3 transparent LCD panels (RGB)   |
| Drive method:                  | Active matrix method   |
| Pixels:                        |  |
| PT-L711XU/PT-L701XU:           | 786 432 (1024 x 768) x 3 panels  |
| PT-L511XU/PT-L501XU:           | 480 000 (800 x 600) x 3 panels   |
| Lens:                          | Manual zoom (1 - 1.3) / focus lens<br>F 1.8 - 2.1, f 28.7 mm - 36.0 mm |
| Lamp:                          | UHM lamp (165 W)   |
| Luminosity:                    |  |
| PT-L711XU:                     | 1600 lm/ANSI   |
| PT-L701XU:                     | 1200 lm/ANSI   |
| PT-L511XU:                     | 1500 lm/ANSI   |
| PT-L501XU:                     | 1200 lm/ANSI   |

Scanning frequency(for RGB signals):

|                                      | <b>PT-L711XU<br/>PT-L701XU</b> | <b>PT-L511XU<br/>PT-L501XU</b> |
|--------------------------------------|--------------------------------|--------------------------------|
| <b>Horizontal scanning frequency</b> | 24 kHz - 97 kHz                | 24 kHz - 81 kHz                |
| <b>Vertical scanning frequency</b>   | 50 Hz - 120 Hz                 | 50 Hz - 120 Hz                 |
| <b>Dot clock frequency</b>           | 135 MHz or less                | 110 MHz or less                |

|                             |   |
|-----------------------------|---|
| YPbPr signals:              | NTSC (480i), 480p, PAL (625i), 720p, HDTV (1080i/1035i) |
| Color system:               | 6 (NTSC/NTSC 4.43/PAL/PAL-M/PAL-N/SECAM)                |
| Projection size:            | 762 mm - 7620 mm (30" - 300")                           |
| Throw distance:             | 1.1 m - 11.7 m (3'8" - 38'4")                           |
| Optical axis shift:         | 9:1 (fixed)   |
| Screen aspect ratio:        | 4:3   |
| Installation:               | Front/Rear/Ceiling/Desk (Menu selection method)         |
| Speakers:                   | 2.8 cm round x 2  |
| Max. useable volume output: | 2 W (1 W + 1 W) (stereo)                                |

|                               |  |
|-------------------------------|--|
| Connectors                    |  |
| RGB IN:                       | Dual-line D-SUB HD 15-pin (female)   |
| During YPbPr input:           |  |
| Y:                            | 1.0 V [p-p], 75 Ω  |
| Pb,Pr :                       | 0.7 V [p-p], 75 Ω  |
| During RGB input              |  |
| R.G.B.:                       | 0.7 V [p-p], 75 Ω  |
| G.SYNC:                       | 1.0 V [p-p], 75 Ω  |
| HD/SYNC:                      | TTL high impedance, automatic plus/minus polarity compatible   |
| VD:                           | TTL high impedance, automatic plus/minus polarity compatible   |
| AUDIO IN (for RGB):           | Double-line 0.5 V [rms] M3 jack (Stereo MINI)  |
| VIDEO IN:                     | Single-line, RCA pin jack<br>1.0 V [p-p], 75 Ω   |
| S-VIDEO IN:                   | Single-line, Mini DIN 4-pin<br>Y 1.0 V [p-p], C 0.286 V [p-p], 75 Ω  |
| AUDIO IN (for S-VIDEO/VIDEO): | 0.5 V [rms] RCA pin jack x 2 (L-R)   |
| AUDIO OUT:                    | Single-line 0.5 V [rms] M3 jack (Stereo MINI) (Monitor output/stereo compatible)<br>0 V [rms] - 2.0 V [rms] (variable) |
| Serial connector:             | D-sub 9p (female) RS-232C compatible   |
| Cabinet:                      | Molded plastic   |
| Dimensions:                   |  |
| Width:                        | 233 mm (9 5/32")   |
| Height:                       | 98 mm (3 27/32")   |
| Length:                       | 330 mm (13") (with lens cover fitted)  |
| Weight:                       | 3.8 kg (8.4 lbs.)  |
| Operating environment:        |  |
| Temperature:                  | 0 °C–40 °C (32 °F–104 °F)  |
| Humidity:                     | 20%–80% (no condensation)  |
| Certifications:               | UL1950, C-UL<br>FCC  |

#### <Remote control unit>

|                  |  |
|------------------|--|
| Power supply:    | 3 V DC (Lithium CR2025 battery x1)                                     |
| Operating range: | Approx. 7 m (23') (when operated directly in front of signal receptor) |
| Weight:          | 18 g (0.6 ozs.) (including battery)                                    |

|             |                 |
|-------------|-----------------|
| Dimensions: |                 |
| Width:      | 40 mm (1 9/16") |
| Height:     | 6.5 mm (1/4")   |
| Length:     | 86 mm (3 3/8")  |

#### <Options>

|                                   |          |
|-----------------------------------|----------|
| Ceiling bracket                   | ET-PK701 |
| Full function remote control unit | ET-RM100 |



FixYo.com

Discount-Merchant.com (800) 281-8866

THE #1 SOURCE FOR PROJECTOR LAMPS AND ACCESSORIES

Others

# Appendix

## List of compatible signals

| Mode              | Display resolution (dots)*1 | Scanning frequency |         | Dot clock frequency (MHz) | Picture quality*2 |           | Resizing*3 |           | Format        |
|-------------------|-----------------------------|--------------------|---------|---------------------------|-------------------|-----------|------------|-----------|---------------|
|                   |                             | H (kHz)            | V (Hz)  |                           | L711 L701         | L511 L501 | L711 L701  | L511 L501 |               |
| NTSC/M-NTSC/PAL-M | 768 x 480i                  | 15.734             | 59.940  |                           | A                 | A         | OK         | OK        | Video/S-Video |
| PAL/PAL-N/SECAM   | 768 x 576i                  | 15.625             | 50.000  |                           | A                 | A         | OK         | OK        | Video/S-Video |
| HDTV              | 1 920 x 1 080i              | 33.750             | 60.000  | 74.250                    | A                 | A         |            |           | YPbPr/RGB     |
| 720P              | 1 280 x 720                 | 45.000             | 60.000  | 74.250                    | A                 | A         |            |           | YPbPr         |
| VGA400            | 640 x 400                   | 24.825             | 56.422  | 21.052                    | A                 | A         | OK         | OK        | RGB           |
| VGA480            | 640 x 400                   | 31.469             | 70.086  | 25.175                    | A                 | A         | OK         | OK        | RGB           |
|                   | 640 x 480                   | 31.469             | 59.940  | 25.175                    | A                 | A         | OK         | OK        | RGB           |
|                   | 640 x 480                   | 35.000             | 66.667  | 30.240                    | A                 | A         | OK         | OK        | RGB           |
|                   | 640 x 480                   | 37.861             | 72.809  | 31.500                    | A                 | A         | OK         | OK        | RGB           |
|                   | 640 x 480                   | 37.500             | 75.000  | 31.500                    | A                 | A         | OK         | OK        | RGB           |
| SVGA              | 640 x 480                   | 43.269             | 85.008  | 36.000                    | A                 | A         | OK         | OK        | RGB           |
|                   | 800 x 600                   | 32.118             | 51.144  | 33.660                    | A                 | AA        | OK         |           | RGB           |
|                   | 800 x 600                   | 35.156             | 56.250  | 36.000                    | A                 | AA        | OK         |           | RGB           |
|                   | 800 x 600                   | 37.879             | 60.317  | 40.000                    | A                 | AA        | OK         |           | RGB           |
|                   | 800 x 600                   | 48.077             | 72.188  | 50.000                    | A                 | AA        | OK         |           | RGB           |
| 800 x 600         |                             | 46.875             | 75.000  | 49.500                    | A                 | AA        | OK         |           | RGB           |
|                   |                             | 53.674             | 85.061  | 56.250                    | A                 | AA        | OK         |           | RGB           |
|                   |                             | 49.725             | 74.550  | 57.283                    | A                 | A         | OK         |           | RGB           |
| MAC16             | 832 x 624                   | 49.725             | 74.550  | 57.283                    | A                 | A         | OK         |           | RGB           |
| XGA               | 1 024 x 768                 | 48.363             | 60.004  | 65.000                    | AA                | A         |            |           | RGB           |
|                   | 1 024 x 768                 | 56.476             | 70.069  | 75.000                    | AA                | A         |            |           | RGB           |
|                   | 1 024 x 768                 | 60.023             | 75.029  | 78.750                    | AA                | A         |            |           | RGB           |
|                   | 1 024 x 768                 | 65.549             | 81.630  | 86.000                    | AA                | A         |            |           | RGB           |
|                   | 1 024 x 768                 | 68.678             | 84.997  | 94.500                    | AA                | A         |            |           | RGB           |
|                   | 1 024 x 768i                | 35.520             | 86.952  | 44.897                    | AA                | A         |            |           | RGB           |
|                   | 1 024 x 768                 | 80.030             | 100.038 | 105.000                   | AA                | A         |            |           | RGB           |
|                   | 1 024 x 768                 | 96.726             | 120.000 | 130.000                   | AA                | C         |            |           | RGB           |
| MXGA              | 1 120 x 760                 | 50.108             | 60.153  | 78.569                    | A                 | A         |            |           | RGB           |
|                   | 1 152 x 864                 | 63.995             | 71.184  | 94.200                    | A                 | A         |            |           | RGB           |
|                   | 1 152 x 864                 | 67.500             | 74.917  | 108.000                   | A                 | A         |            |           | RGB           |
|                   | 1 152 x 864                 | 76.705             | 85.038  | 121.500                   | A                 | C         |            |           | RGB           |
| MAC21             | 1 152 x 870                 | 68.681             | 75.062  | 100.000                   | A                 | C         |            |           | RGB           |
| SXGA              | 1 280 x 1 024               | 52.350             | 50.000  | 87.948                    | A                 | A         |            |           | RGB           |
|                   | 1 280 x 1 024               | 63.981             | 60.020  | 108.000                   | A                 | A         |            |           | RGB           |
|                   | 1 280 x 1 024               | 72.338             | 66.304  | 125.000                   | A                 | C         |            |           | RGB           |
|                   | 1 280 x 1 024               | 78.160             | 71.970  | 135.060                   | A                 | C         |            |           | RGB           |
|                   | 1 280 x 1 024               | 79.977             | 75.025  | 135.001                   | A                 | C         |            |           | RGB           |
|                   | 1 280 x 1 024i              | 46.433             | 86.872  | 78.750                    | A                 | C         |            |           | RGB           |
|                   | 1 280 x 1 024i              | 47.600             | 89.055  | 80.730                    | A                 | C         |            |           | RGB           |
|                   | 600 x 1 200                 | 75.000             | 60.000  | 162.000                   | B                 | C         |            |           | RGB           |
| 1 600 x 1 200     | 87.500                      | 70.000             | 189.000 | B                         | C                 |           |            | RGB       |               |
| 1 600 x 1 200     | 93.750                      | 75.000             | 202.500 | B                         | C                 |           |            | RGB       |               |
| 480i              | 720 x 480i                  | 15.734             | 59.940  | 13.500                    | A                 | A         | OK         | OK        | YPbPr         |
| 625i              | 720 x 576i                  | 15.625             | 50.000  | 13.500                    | A                 | A         | OK         | OK        | YPbPr         |
| 480p              | 720 x 483                   | 31.469             | 59.940  | 27.000                    | A                 | A         | OK         | OK        | YPbPr         |

- \*1 The "i" appearing after the resolution indicates an interlaced signal.
- \*2 The following symbols are used to indicate picture quality.
  - AA Maximum picture quality can be obtained.
  - A Signals are converted by the image processing circuit before picture is projected
  - B Some loss of data occurs to make projection easier.
  - C Picture cannot be projected.
- \*3 Signals with "OK" in the Resizing column can be set using the RESIZING command in the PICTURE menu. (Refer to page 32.)

## Dimensions

<Units: mm (")>

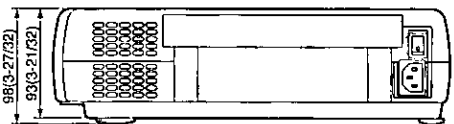
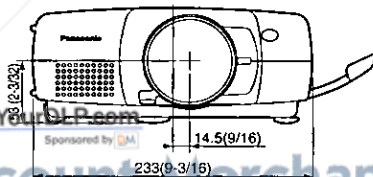
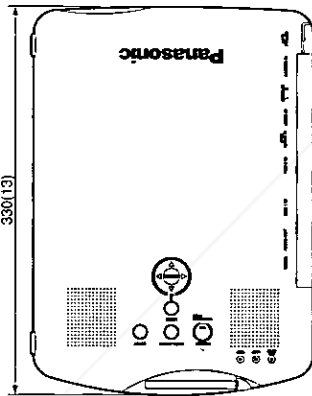

FixYourGrip.com

Sponsored by DM

Discount-Merchant.com (800) 281-8860

THE TRUSTED SOURCE FOR PROJECTOR LAMPS AND ACCESSORIES

Others

# Trademark acknowledgements

- VGA and XGA are trademarks of International Business Machines Corporation.
  - Macintosh is a registered trademark of Apple Computer, Inc.
  - S-VGA is a registered trademark of the Video Electronics Standards Association.
  - Windows is a registered trademark of Microsoft Corporation.
- All other trademarks are the property of the various trademark owners.



**Discount-Merchant.com (800) 281-8860**  
**THE TRUSTED SOURCE FOR PROJECTOR LAMPS AND ACCESSORIES**

# NOTES IMPORTANTES CONCERNANT LA SÉCURITÉ

**AVERTISSEMENT: POUR REDUIRE LES RISQUES DE FEU OU DE CHOC ÉLECTRIQUE, NE PAS EXPOSER CE PRODUIT À L'EAU OU À L'HUMIDITÉ**

**Alimentation:** Ce projecteur LCD est conçu pour fonctionner sur secteur de 100 V - 240 V, 50 Hz/60 Hz seulement.

**ATTENTION:** Le cordon d'alimentation secteur fourni avec le projecteur peut être utilisé uniquement pour une alimentation électrique de 125 V, 10 A maximum. Si on veut l'utiliser avec une tension ou un courant plus forts, on doit se procurer un autre cordon d'alimentation de 250 V. Si on utilise le cordon fourni sous ces conditions, risque de provoquer un incendie.



Le symbole de la flèche en forme d'éclair, dans un triangle, avertit l'utilisateur de la présence de "tensions dangereuses" à l'intérieur du produit qui peuvent être de force suffisante pour constituer un risque de choc électrique aux personnes.



Le point d'exclamation dans un triangle avertit l'utilisateur de la présence d'instructions importantes concernant l'utilisation et l'entretien (réparation) dans la littérature accompagnant le produit.



FixYourPLP.com

DiscountMerchant.com (800) 281-8866  
THE TRUSTED SOURCE FOR PROJECTOR LAMPS AND ACCESSORIES

Others

**ATTENTION:** Cet appareil est équipé d'une fiche de courant à trois broches avec mise à la terre. Ne pas retirer la broche de mise à la masse de la fiche.

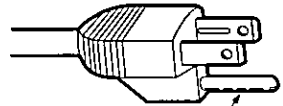

Ne pas retirer

Cette fiche ne pourra être utilisée que dans une prise avec mise à la terre. Ceci est une précaution sécuritaire. S'il est impossible d'insérer la fiche dans la prise, s'adresser à un électricien. Ne pas annuler la protection de la fiche à mise à la terre.

 **FixYourDLP.com**  
Sponsored by 

**Discount-Merchant.com (800) 281-8860**  
**THE TRUSTED SOURCE FOR PROJECTOR LAMPS AND ACCESSORIES**

# Précautions concernant la sécurité

## AVERTISSEMENT

**En cas de problème (pas d'image ou de son), ou si le projecteur dégage de la fumée ou une odeur étrange, éteindre l'appareil et débrancher immédiatement la fiche d'alimentation de la prise de courant.**

- Ne pas continuer d'utiliser le projecteur dans ces cas, autrement cela peut entraîner un incendie ou des chocs électriques.
- Après s'être assuré que de la fumée ne se dégage plus, s'adresser à un centre technique agréé et demander que les réparations nécessaires soient faites.
- Le fait de réparer le projecteur soi-même est très dangereux, et ne doit jamais être fait.

**Ne pas installer ce projecteur dans un endroit qui n'est pas assez résistant pour supporter le poids du projecteur.**

- Si l'emplacement d'installation n'est pas assez résistant, le projecteur risque de tomber et causer de graves blessures et (ou) des dommages.

**Demander à un technicien qualifié d'installer le projecteur par exemple s'il est installé au plafond.**

- Si l'installation n'est pas faite correctement, cela peut entraîner des blessures ou des chocs électriques.

**Si de l'eau ou des objets étrangers entrent dans le projecteur, si le projecteur tombe, ou si le boîtier est endommagé, éteindre l'appareil et débrancher immédiatement la fiche d'alimentation de la prise de courant.**

- Si l'on continue d'utiliser le projecteur dans cette condition, cela peut entraîner un incendie ou des chocs électriques.
- S'adresser à un centre technique agréé pour que les réparations nécessaires puissent être faites.

**Ne pas couvrir le filtre et la sortie d'air.**

- Cela risque de faire surchauffer le projecteur, et causer un incendie ou endommager le projecteur.

**Ne pas surcharger la prise de courant.**

- Si l'alimentation est surchargée (par exemple, par l'utilisation de trop d'adaptateurs), cela risque de faire surchauffer le projecteur et peut entraîner un incendie.

**Ne pas retirer le couvercle ou le modifier.**

- Des hautes tensions qui peuvent causer de graves blessures sont présentes à l'intérieur du projecteur.
- Pour toute inspection, réglage ou réparation, s'adresser à un centre technique agréé.



Fix Your DLP.com

Discontinued by Dell (800) 281-8866  
THE ONLINE SOURCE FOR PROJECTOR LAMPS AND ACCESSORIES

Others



### **Nettoyer la fiche du cordon d'alimentation régulièrement afin d'éviter toute accumulation de poussière.**

- Si de la poussière s'accumule sur la fiche du cordon d'alimentation, l'humidité peut endommager l'isolant et entraîner un incendie. Débrancher le cordon d'alimentation de la prise de courant et l'essuyer avec un chiffon sec.
- Si le projecteur ne sera pas utilisé pendant une période prolongée, débrancher le cordon d'alimentation de la prise de courant.

### **Faire attention de ne pas endommager le cordon d'alimentation.**

- Ne pas endommager le cordon d'alimentation, ne pas le modifier, ne pas placer d'objets lourds, ne pas le chauffer, ne pas le placer près d'objets chauffants, ne pas le tordre, ne pas le plier ou le tirer excessivement et ne pas le rouler en boule.
- Si le cordon d'alimentation est endommagé, cela peut entraîner un incendie et des chocs électriques.
- Si le cordon d'alimentation est endommagé, le faire réparer par un centre technique agréé.

### **Ne pas manipuler le cordon d'alimentation avec les mains mouillées.**

- Cela peut entraîner des chocs électriques.

### **Brancher la fiche du cordon d'alimentation fermement dans la prise de courant.**

- Si la fiche n'est pas complètement insérée, cela peut entraîner des chocs électriques ou la faire surchauffer.
- Si la fiche est endommagée ou la plaque de la prise est desserrée, elles ne devraient pas être utilisées.

### **Ne pas placer le projecteur sur des surfaces instables.**

- Si le projecteur est placé sur une surface qui est inclinée ou instable, il risque de tomber ou de se renverser et cela peut causer des blessures ou des dommages.

### **Ne pas placer le projecteur dans l'eau ou ne pas le laisser se mouiller.**

- Sinon cela peut causer un incendie ou des chocs électriques.

### **Ne pas placer des récipients de liquide sur le projecteur.**

- Si de l'eau se renverse sur le projecteur, s'adresser à un centre technique agréé.
- Si n'importe quelle eau obtient à l'intérieur du projecteur, entrer en contact avec un centre commercial autorisé.

### **Ne pas mettre d'objets étrangers dans le projecteur.**

- Ne pas insérer d'objets métalliques ou inflammables dans les orifices de ventilation ou les faire tomber sur le projecteur, car cela peut causer un incendie ou des chocs électriques.

### **Après avoir retiré la pile, la garder hors de la portée des enfants.**

- Si avalée, la pile peut causer la mort par suffocation.
- Si la pile est avalée, s'adresser à un médecin immédiatement.

**Ne pas laisser les bornes + et - de la pile entrer en contact avec des objets métalliques tels que des colliers ou des épingles à cheveux.**

- Cela peut faire que la pile fuit, surchauffe, éclate ou prenne feu.
- Garder la pile dans un sachet en plastique et la maintenir éloignée des objets métalliques.

**Isoler la pile à l'aide de ruban ou autre avant de la mettre au rebut.**

- Si la pile entre en contact avec des objets métalliques ou d'autres piles, elle peut prendre feu ou éclater.

## **Attention**

**Ne pas installer le projecteur dans des endroits humides ou poussiéreux ou dans des endroits où le projecteur peut entrer en contact avec de la fumée ou la vapeur.**

- L'utilisation du projecteur dans de telles conditions peut causer un incendie ou des chocs électriques.

**Pour débrancher le cordon d'alimentation, tenir la fiche et non pas le cordon.**

- Si le cordon d'alimentation est tiré, le cordon sera endommagé et cela peut causer un incendie, des courts-circuits ou des chocs électriques sérieux.

**Débrancher toujours tous les câbles avant de déplacer le projecteur.**

- Le fait de déplacer le projecteur avec des câbles branchés peut endommager les câbles, ce qui pourraient causer un incendie ou des chocs électriques.

**Ne pas placer d'objets lourds sur le projecteur.**

- Cela peut déséquilibrer le projecteur et le faire tomber, ce qui peut entraîner des dommages ou des blessures.

**Ne pas court-circuiter, chauffer ou démonter la pile et ne pas la placer dans l'eau ou le feu.**

- Cela peut faire que la pile fuit, surchauffe, éclate ou prenne feu et causer des brûlures ou autres blessures.

**Lors de l'insertion de la pile, s'assurer que les polarités (+ et -) sont correctes.**

- Si la pile est insérée incorrectement, elle peut éclater ou fuir et cela peut causer un incendie, des blessures ou la contamination du compartiment des piles.

**N'utiliser que la pile indiquée.**

- Si une pile incorrecte est utilisée, elle peut éclater ou fuir et cela peut causer un incendie, des blessures ou la contamination du compartiment des piles.



Fix Your PLP.com

Discount Merchant.com (800) 221-8860

THE TRUSTED SOURCE FOR PROJECTOR LAMPS AND ACCESSORIES

Others

**Ne pas regarder directement dans la lentille pendant que le projecteur fonctionne.**

- Une lumière intense est émise par la lentille du projecteur. Si l'on regarde directement dans cette lumière, elle risque de causer des blessures et de graves lésions aux yeux.

**Ne pas placer ses mains ou autres objets près de la sortie d'air.**

- De l'air chaud sort par l'ouverture de sortie d'air. Ne pas placer les mains ou la figure, ou d'autres objets qui ne peuvent résister à la chaleur près de cette sortie d'air, sinon cela peut causer des blessures ou des dommages.

**Le remplacement de l'unité de lampe ne devrait être effectué que par un technicien qualifié.**

- L'unité de lampe a une pression interne élevée. Elle peut facilement s'endommager si cognée contre des objets durs ou si elle tombe, cela peut causer des blessures ou des mauvais fonctionnements.

**Débrancher la fiche du cordon d'alimentation de la prise de courant comme mesure de sécurité avant d'effectuer tout nettoyage.**

- Sinon cela peut causer des chocs électriques.

**Demander à un centre technique agréé de nettoyer l'intérieur du projecteur au moins une fois par an.**

- S'il n'est pas nettoyé et que la poussière s'accumule à l'intérieur du projecteur, cela peut causer un incendie ou des problèmes de fonctionnement.
- Il est recommandé de nettoyer l'intérieur du projecteur avant que la saison humide n'arrive. Demander au centre technique agréé plus proche de nettoyer le projecteur lorsque cela est requis. Se renseigner auprès du centre technique agréé pour le coût du nettoyage.

**Nous faisons tous les efforts possibles afin de préserver l'environnement. Prière d'apporter l'appareil, s'il n'est pas réparable, à votre revendeur ou à un centre de recyclage.**



**Discount-Merchant.com (800) 281-8860**  
**THE TRUSTED SOURCE FOR PROJECTOR LAMPS AND ACCESSORIES**

# Précautions concernant la manipulation

## Avertissements concernant la manipulation

**S'assurer d'attacher le capuchon d'objectif avant de transporter le projecteur.**

La lentille de projection est extrêmement sensible à la vibration et aux chocs. Utiliser la sacoche de transport pour transporter le projecteur.

## Avertissements concernant l'installation

Toujours observer les points suivants lors de l'installation du projecteur.

**Éviter de l'installer dans les endroits sujets à des vibrations ou à des chocs.**

Si le projecteur est installé dans les endroits sujets à de fortes vibrations, comme près d'un moteur, ou s'il est installé à l'intérieur d'un véhicule ou à bord d'un bateau, le projecteur peut être soumis à une vibration ou à des chocs qui peuvent endommager les pièces internes et causer des mauvais fonctionnements ou des accidents. Dès lors, installer le projecteur dans un endroit qui n'est pas soumis à des vibrations ou des chocs.

**Ne pas installer le projecteur près de lignes d'alimentation électrique à haute tension ou de moteurs.**

Le projecteur peut être sujet à une interférence électromagnétique s'il est installé près de lignes d'alimentation électrique à haute tension ou de moteurs.

**Si le projecteur est installé au plafond, demander à un technicien qualifié de faire tous les travaux d'installation.**

Si le projecteur doit être suspendu au plafond, il faut acheter le kit d'installation séparé (numéro de modèle: ET-PK701). De plus, tous les travaux d'installation ne devraient être faits que par un technicien qualifié.

## Notes sur l'utilisation

**Afin d'obtenir la meilleure qualité d'image**

Si la lumière extérieure ou la lumière des lampes intérieures brille sur l'écran, les images projetées n'auront pas un bon contraste. Tirer les rideaux ou les stores de toutes les fenêtres et éteindre toutes les lumières fluorescentes près de l'écran pour empêcher la réflexion.

**Ne pas toucher aux surfaces de la lentille avec les mains nues.**

Si la surface de la lentille est salie par des empreintes digitales ou autre, ceci sera agrandi et projeté sur l'écran. D'ailleurs, lorsque le projecteur n'est pas utilisé, rétracter la lentille, puis la couvrir à l'aide du capuchon d'objectif accessoire.

**À propos de l'écran**

Si l'écran utilisé est sale, endommagé ou décoloré, des projections de bonne qualité ne peuvent pas être obtenues. N'appliquer aucune substance volatile à l'écran et ne pas le laisser se salir ou s'endommager.



Discount Merchant.com (800) 281-8866

Others

## **Avant de faire le nettoyage et l'entretien, s'assurer de débrancher la fiche du cordon d'alimentation de la prise de courant.**

### **Essuyer le boîtier avec un tissu doux et sec.**

Si le boîtier est très sale, imbiber le chiffon dans de l'eau avec un peu de détergent neutre, bien essorer le chiffon, puis essuyer le boîtier. Après le nettoyage, sécher le boîtier à l'aide d'un chiffon sec.

### **Si un chiffon traité chimiquement est utilisé, lire les directives fournies avec le chiffon avant de l'utiliser.**

Ne pas essuyer la lentille avec un chiffon poussiéreux ou pelucheux.

Si de la poussière ou de la peluche se dépose sur la lentille, elle sera agrandie et projetée sur l'écran. Utiliser une poire à air pour nettoyer toute poussière et peluche de sur la surface de la lentille, ou utiliser un chiffon doux pour retirer toute poussière ou peluche.



**Discount-Merchant.com (800) 281-8860**  
**THE TRUSTED SOURCE FOR PROJECTOR LAMPS AND ACCESSORIES**

# Remplacement du bloc de lampe

## Attention

Le bloc de lampe ne devrait être remplacé que par un technicien qualifié.

Le couvercle du bloc de lampe sera chaud après l'utilisation.

- On risque de se brûler si le couvercle du bloc de lampe est touché pendant qu'il est chaud.

## Notes sur le remplacement du bloc de lampe

- Faire très attention en manipulant le bloc de lampe retiré, car il contient du gaz sous haute pression et peut facilement s'endommager s'il est cogné contre des objets durs ou s'il tombe.
- Le vieux bloc de lampe peut se briser si manipulé rudement après le retrait. Demander à une agence de mise au rebut agréée de s'occuper de mettre au rebut le bloc de lampe retiré.
- Un tournevis cruciforme Phillips sera nécessaire lors du retrait du bloc de lampe. S'assurer que ses mains ne glissent pas lors de l'utilisation du tournevis.

### REMARQUE:

- Le projecteur n'est pas fourni avec un bloc de lampe de rechange. Demander les détails au revendeur. Numéro de produit du bloc de lampe: ET-LA702

### ATTENTION:

- Ne pas utiliser un bloc de lampe avec un numéro de pièce autre que celui indiqué ci-dessus.

## Période de remplacement du bloc de lampe

La lampe utilisée comme source lumineuse pour ce projecteur doit être remplacée. La durée de fonctionnement normale du bloc de lampe est d'environ 2000 heures, toutefois le bloc de lampe peut cesser de projeter avant que les 2000 heures de fonctionnement soient atteintes, suivant les caractéristiques de la lampe et les conditions dans lesquelles la lampe est utilisée. (Si la lampe est allumée et éteinte très fréquemment, ou si la période d'attente entre l'arrêt et la mise en marche est trop courte, cela peut raccourcir la durée de fonctionnement du bloc de lampe.) Il est recommandé de toujours avoir un bloc de lampe de rechange prêt à l'emploi si nécessaire. Aussi, la durée de vie utile de la lampe peut être prolongée en réglant PUIS LAMPE dans le menu OPTION à "FAIBLE".

Si la lampe n'est pas remplacée après que la durée d'utilisation totale ait dépassé les 1800 heures (lorsque PUIS LAMPE est réglé à "STD"), l'alimentation s'éteindra automatiquement et le projecteur passera au mode d'attente lorsque la durée d'utilisation totale atteint les 2000 heures. Si l'alimentation est mise de nouveau en circuit après que les 2000 heures aient été dépassées, le projecteur passera de nouveau automatiquement au mode d'attente après 10 minutes approximativement.



FixYourDLP.com  
Discontinued  
THE TRUSTED SOURCE FOR PROJECTOR LAMP AND ACCESSORIES

Others

## Affichage à l'écran lorsque l'utilisation totale dépasse 1800 heures

Si l'on continue d'utiliser le bloc de lampe après 1800 heures d'utilisation totale (lorsque PUIS LAMPE est réglé à "STD"), l'indicateur LAMP (lampe) s'allumera, même lorsque le projecteur est en mode d'attente. L'affichage à l'écran indiqué à droite apparaîtra pour rappeler de remplacer le bloc de lampe 10 minutes avant que l'alimentation s'éteigne automatiquement. Cet affichage continuera d'apparaître jusqu'à ce qu'un bouton comme la touche de menu (MENU) ou les touches de volume (VOLUME +/-) soit pressé.

REEMPLACER LAMPE

## Méthode de remplacement du bloc de lampe

### REMARQUE:

- Si le temps d'utilisation de la lampe a dépassé 2000 heures (lorsque PUIS LAMPE a été mis sur "STD"), le projecteur passe en mode d'attente après environ dix minutes de fonctionnement. Les étapes de la page suivante devront dès lors être exécutées dans les 10 minutes.

① **Mettre hors circuit l'interrupteur d'alimentation principale (MAIN POWER) suivant la méthode donnée dans "Mise hors circuit de l'alimentation" à la page 21, puis débrancher la fiche du cordon d'alimentation de la prise de courant et vérifier que les pièces autour du bloc de lampe se sont refroidies.**

② **Utiliser un tournevis Phillips pour desserrer les vis de fixation du couvercle du bloc de lampe sur le fond du projecteur, puis enlever le couvercle du bloc de lampe.**

③ **Utiliser un tournevis Phillips pour desserrer les deux vis de fixation du bloc de lampe jusqu'à ce que les vis tournent librement. Tenir la poignée du bloc de lampe et tirer doucement pour le sortir du projecteur.**

Vis de fixation du bloc de lampe

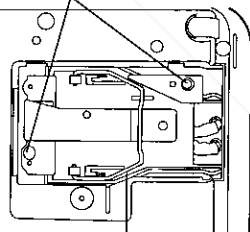

Poignée

### Attention

**Le bloc de lampe sera chaud après l'utilisation.**

- Il est possible de se brûler si on le touche alors qu'il est encore chaud.

④ **Insérer le nouveau bloc de lampe tout en s'assurant que la direction de l'insertion est correcte, puis utiliser un tournevis Phillips pour resserrer fermement les vis de fixation du bloc de lampe.**

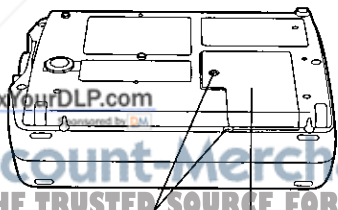

Vis de fixation du couvercle du bloc de lampe

Couvercle de l'unité de lampe

- ⑤ Installer le couvercle du bloc de lampe, puis utiliser un tournevis Phillips pour resserrer fermement les vis de fixation du couvercle du bloc de lampe.

**REMARQUE:**

- S'assurer de bien installer le bloc de lampe et le couvercle du bloc de lampe. S'ils ne sont pas bien installés, cela peut déclencher le circuit de protection et le projecteur ne pourra pas être allumé.

- ⑥ Insérer la fiche du cordon d'alimentation dans la prise de courant, puis appuyer sur l'interrupteur d'alimentation principale (MAIN POWER).

**REMARQUE:**

- Si la touche d'alimentation (POWER) sur le projecteur ne s'allumera pas en rouge quand l'interrupteur d'alimentation principale (MAIN POWER) est mis en circuit, remettre hors circuit l'interrupteur d'alimentation principale (MAIN POWER) et vérifier que le bloc de lampe et le couvercle du bloc de lampe sont bien installés. Remettre ensuite l'interrupteur d'alimentation principale (MAIN POWER) en circuit.

- ⑦ Appuyer sur la touche d'alimentation (POWER) pour projeter une image sur l'écran.
- ⑧ Appuyer sur la touche de menu (MENU) pour afficher l'écran de MENU PRINCIPAL, puis appuyer sur les touches ▲ et ▼ pour déplacer le curseur et sélectionner "OPTION".

- ⑨ Appuyer sur la touche d'entrée (ENTER) pour afficher le menu OPTION, puis utiliser les touches ▲ et ▼ pour sélectionner DURÉE LAMPE.

| OPTION       |      |          |     |
|--------------|------|----------|-----|
| ENTRÉE ÉCRAN | NON  | OUI      |     |
| COR TRAP     | AUT  | NON      | OUI |
| Y-PB-PR      | AUTO | NON      | OUI |
| RUB          | AUTO | NON      | OUI |
| FORMAT       | RGB  | Y-PB-PR  |     |
| COULEUR FOND |      | BLEU     |     |
| INSTALLATION |      | FAÇADE   |     |
| SOL/PLAFOND  |      | SOL      |     |
| PUIS LAMPE   |      | STD      |     |
| DURÉE LAMPE  |      | 1820H    |     |
| FONCT 1      |      | REGL     |     |
| ↓ SÉLECT     |      | MENU ESC |     |

- ⑩ Appuyer et maintenir la touche d'entrée (ENTER) sur le panneau de commande du projecteur pendant 3 secondes approximativement.

| OPTION                 |      |          |     |
|------------------------|------|----------|-----|
| ENTRÉE ÉCRAN           | NON  | OUI      |     |
| COR TRAP               | AUT  | NON      | OUI |
| Y-PB-PR                | AUTO | NON      | OUI |
| RUB                    | AUTO | NON      | OUI |
| FORMAT                 | RGB  | Y-PB-PR  |     |
| COULEUR FOND           |      | BLEU     |     |
| INSTALLATION           |      | FAÇADE   |     |
| SOL/PLAFOND            |      | SOL      |     |
| PUIS LAMPE             |      | STD      |     |
| INIT COMPT [POWER OFF] |      |          |     |
| FONCT 1                |      | REGL     |     |
| ↓ SÉLECT               |      | MENU ESC |     |

"DURÉE LAMPE" changera à "INIT COMPT [POWER OFF]".

**REMARQUE:**

- Ceci ne fonctionnera pas si la touche d'entrée (ENTER) sur la télécommande est pressée.
  - Si la touche de menu (MENU) est pressée, l'écran de remise à zéro de la durée de lampe sera annulé.
- ⑪ Maintenir la touche POWER enfoncée pendant 0,5 seconde ou l'enfoncer deux fois pour couper l'alimentation électrique. Ceci remettra à zéro la durée d'utilisation totale du bloc de lampe.

| MENU     |               |
|----------|---------------|
| ☐        | COR TRAP      |
| ☐        | IMAGE         |
| ☐        | POSITION      |
| ☐        | REGL FENETRE  |
| ☐        | OBTURATEUR    |
| ☐        | AUDIO         |
| ☐        | LANGUAGE      |
| ☐        | OPTION        |
| ↓ SÉLECT | ENTER] VAL ID |



Discount Merchant.co (800) 281-8860  
 DISCOUNT SOURCE FOR PROJECTOR LAMPS AND ACCESSORIES

Others



These Operating Instructions are printed on recycled paper.

---

# Panasonic<sup>®</sup>

Professional/Industrial Video

---

**Panasonic Broadcast & Television Systems Company**  
Division of Matsushita Electric Corporation of America

One Panasonic Way 4E-7 Secaucus, NJ 07094 (201) 392-4443  
3330 Canuenga Blvd West Los Angeles, CA 90068 (323) 436-3500

**Technical Support:**

(800) 524-1448

(800) 526-6610

FAX: (201) 392-6514

E-Mail: [pbtssupport@panasonic.com](mailto:pbtssupport@panasonic.com)

---

**Panasonic Canada Inc.**

5770 Ambler Drive, Mississauga, Ontario L4W 2T3 (905) 624-5010

Printed in Japan  
S0501-0A



# Disclaimer

This user manual is provided as a free service by FixYourDLP.com. FixYourDLP is in no way responsible for the content of this manual, nor do we guarantee its accuracy. FixYourDLP does not make any claim of copyright and all copyrights remain the property of their respective owners.

About FixYourDLP.com

FixYourDLP.com (<http://www.fixyourdlp.com>) is the World's #1 resource for media product news, reviews, do-it-yourself guides, and manuals.

Informational Blog: <http://www.fixyourdlp.com>

Video Guides: <http://www.fixyourdlp.com/guides>

User Forums: <http://www.fixyourdlp.com/forum>

FixYourDLP's Fight Against Counterfeit Lamps:

<http://www.fixyourdlp.com/counterfeits>

## Sponsors:

RecycleYourLamp.org – Free lamp recycling services for used lamps:

<http://www.recycleyourlamp.org>

Lamp Research - The trusted 3rd party lamp research company:

<http://www.lampresearch.com>

Discount-Merchant.com – The worlds largest lamp distributor:

<http://www.discount-merchant.com>



**FixYourDLP.com**

Sponsored by 