



# Disclaimer

This user manual is provided as a free service by FixYourDLP.com. FixYourDLP is in no way responsible for the content of this manual, nor do we guarantee its accuracy. FixYourDLP does not make any claim of copyright and all copyrights remain the property of their respective owners.

About FixYourDLP.com

FixYourDLP.com (<http://www.fixyourdpl.com>) is the World's #1 resource for media product news, reviews, do-it-yourself guides, and manuals.

Informational Blog: <http://www.fixyourdpl.com>

Video Guides: <http://www.fixyourdpl.com/guides>

User Forums: <http://www.fixyourdpl.com/forum>

FixYourDLP's Fight Against Counterfeit Lamps:

<http://www.fixyourdpl.com/counterfeits>

## Sponsors:

RecycleYourLamp.org – Free lamp recycling services for used lamps:

<http://www.recycleyourlamp.org>

Lamp Research - The trusted 3rd party lamp research company:

<http://www.lampresearch.com>

Discount-Merchant.com – The worlds largest lamp distributor:

<http://www.discount-merchant.com>



**FixYourDLP.com**

Sponsored by 

# Panasonic®

## Operating Instructions

LCD Projector

Model No. **PT-AX200E**

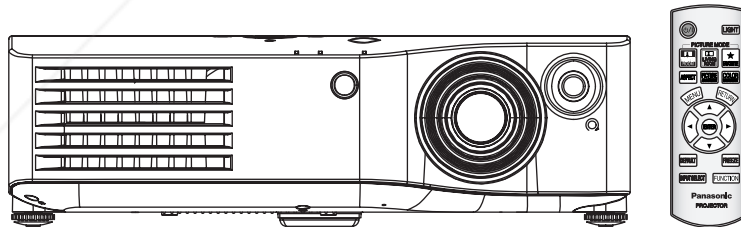

 **FixYourDLP.com**  
Sponsored by 

**Discount-Merchant.com (800) 281-8860**

**THE TRUSTED SOURCE FOR PROJECTOR LAMPS AND ACCESSORIES**

**HDMI™**

HIGH-DEFINITION MULTIMEDIA INTERFACE

Before operating this product, please read the instructions carefully and save this manual for future use.

TQBJ0236

**ENGLISH**

# Important Safety Notice

## Dear Panasonic Customer:

This instruction booklet provides all the necessary operating information that you might require. We hope it will help you to get the most out of your new product, and that you will be pleased with your Panasonic LCD projector. The serial number of your product may be found on its bottom. You should note it in the space provided below and retain this booklet in case service is required.

Model number: **PT-AX200E**

Serial number:

**WARNING:** THIS APPARATUS MUST BE EARTHED.

**WARNING:** To prevent damage which may result in fire or shock hazard, do not expose this appliance to rain or moisture.

Machine Noise Information Ordinance 3. GSGV, January 18, 1991: The sound pressure level at the operator position is equal or less than 70 dB (A) according to ISO 7779.

**WARNING:**

1. Remove the plug from the mains socket when this unit is not in use for a prolonged period of time.
2. To prevent electric shock, do not remove cover. No user serviceable parts inside. Refer servicing to qualified service personnel.
3. Do not remove the earthing pin on the mains plug. This apparatus is equipped with a three prong earthing-type mains plug. This plug will only fit an earthing-type mains socket. This is a safety feature. If you are unable to insert the plug into the mains socket, contact an electrician. Do not defeat the purpose of the earthing plug.

**CAUTION:** To assure continued compliance, follow the attached installation instructions, which includes using the provided power cord and shielded interface cables when connecting to computer or peripheral device. If you use serial port to connect PC for external control of projector, you must use optional RS-232C serial interface cable with ferrite core. Any unauthorized changes or modifications to this equipment will void the user's authority to operate.

Pursuant to at the directive 2004/108/EC, article 9(2)  
Panasonic Testing Centre  
Panasonic Service Europe, a division of Panasonic Marketing Europe GmbH  
Winsbergring 15, 22525 Hamburg, F.R. Germany

Information on Disposal for Users of Waste Electrical & Electronic Equipment (private households)



This symbol on the products and/or accompanying documents means that used electrical and electronic products should not be mixed with general household waste.

For proper treatment, recovery and recycling, please take these products to designated collection points, where they will be accepted on a free of charge basis. Alternatively, in some countries you may be able to return your products to your local retailer upon the purchase of an equivalent new product.

Disposing of this product correctly will help to save valuable resources and prevent any potential negative effects on human health and the environment which could otherwise arise from inappropriate

waste handling. Please contact your local authority for further details of your nearest designated collection point.

Penalties may be applicable for incorrect disposal of this waste, in accordance with national legislation.

Sponsored by CEC

### For business users in the European Union

If you wish to discard electrical and electronic equipment, please contact your dealer or supplier for further information.

### Information on Disposal in other Countries outside the European Union

This symbol is only valid in the European Union.

If you wish to discard this product, please contact your local authorities or dealer and ask for the correct method of disposal.

**IMPORTANT: THE MOULDED PLUG (U.K. only)**

FOR YOUR SAFETY, PLEASE READ THE FOLLOWING TEXT CAREFULLY.

This appliance is supplied with a moulded three pin mains plug for your safety and convenience. A 13 amp fuse is fitted in this plug. Should the fuse need to be replaced, please ensure that the replacement fuse has a rating of 13 amps and that it is approved by ASTA or BSI to BS1362.

Check for the ASTA mark  or the BSI mark  on the body of the fuse.

If the plug contains a removable fuse cover, you must ensure that it is refitted when the fuse is replaced. If you lose the fuse cover, the plug must not be used until a replacement cover is obtained. A replacement fuse cover can be purchased from an Authorised Service Centre.

**If the fitted moulded plug is unsuitable for the mains socket in your home, then the fuse should be removed and the plug cut off and disposed of safely. There is a danger of severe electrical shock if the cut off plug is inserted into any 13 amp socket.**

If a new plug is to be fitted, please observe the wiring code as shown below. If in any doubt, please consult a qualified electrician.

**WARNING:** THIS APPLIANCE MUST BE EARTHED.

**IMPORTANT:** The wires in this mains lead are coloured in accordance with the following code:

|                       |         |
|-----------------------|---------|
| Green - and - Yellow: | Earth   |
| Blue:                 | Neutral |
| Brown:                | Live    |

As the colours of the wire in the mains lead of this appliance may not correspond with the coloured markings identifying the terminals in your plug, proceed as follows.

The wire which is coloured GREEN - AND - YELLOW must be connected to the terminal in the plug which is marked with the letter E or by the Earth symbol  or coloured GREEN or GREEN - AND - YELLOW.

The wire which is coloured BLUE must be connected to the terminal in the plug which is marked with the letter N or coloured BLACK.

The wire which is coloured BROWN must be connected to the terminal in the plug which is marked with the letter L or coloured RED.

How to replace the fuse: Open the fuse compartment with a screwdriver and place the fuse.

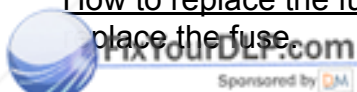

**Discount-Merchant.com (800) 291-8860**  
**THE TRUSTED SOURCE FOR PROJECTOR LAMPS AND ACCESSORIES**

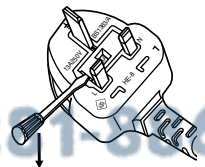

# Contents

## Quick steps

**1. Set up your projector**  
See "Setting up" on page 14.



**2. Connect with other devices**  
See "Connections" on page 18.



**3. Prepare the remote control**  
See "Remote control" on page 11.



**4. Start projecting**  
See "Switching the projector on/off" on page 19.



**5. Adjust the image**  
See "Menu Navigation" on page 27.

## Important Information

|  |    |
|--|----|
| <b>Important Safety Notice</b> .....           | 2  |
| <b>Precautions with regard to safety</b> ..... | 6  |
| WARNINGS .....                                 | 6  |
| CAUTIONS .....                                 | 7  |
| Cautions when transporting .....               | 8  |
| Cautions when installing .....                 | 9  |
| Cautions on use .....                          | 9  |
| Accessories .....                              | 10 |

## Preparation

|                                   |    |
|-----------------------------------|----|
| <b>About Your Projector</b> ..... | 11 |
| Remote control .....              | 11 |
| Projector body .....              | 12 |

## Getting Started

|  |    |
|--|----|
| <b>Setting up</b> .....                              | 14 |
| Screen size and throw distance .....                 | 14 |
| Projection method .....                              | 15 |
| Front leg adjusters and throwing angle .....         | 15 |
| Lens shift and positioning .....                     | 16 |
| <b>Connections</b> .....                             | 18 |
| Before connecting to the projector .....             | 18 |
| Connecting to COMPONENT IN/VIDEO IN/S-VIDEO IN ..... | 18 |
| Connecting to COMPUTER IN/HDMI IN .....              | 18 |

## Basic Operation

|   |    |
|---|----|
| <b>Switching the projector on/off</b> .....     | 19 |
| Mains lead .....                                | 19 |
| POWER indicator .....                           | 19 |
| Switching on the projector .....                | 20 |
| Switching off the projector .....               | 20 |
| <b>Projecting an image</b> .....                | 21 |
| Selecting the input signal .....                | 21 |
| Positioning the image .....                     | 21 |
| <b>Remote control operation</b> .....           | 22 |
| Operating range .....                           | 22 |
| Turning on the button backlight .....           | 22 |
| Switching the preset settings .....             | 22 |
| Adjusting the image .....                       | 23 |
| Switching the aspect ratio .....                | 23 |
| Resetting to the factory default settings ..... | 23 |
| Capturing an image .....                        | 23 |
| Setting your own colour profile .....           | 24 |
| Switching the input signal .....                | 26 |
| Assigning the functions for shortcut .....      | 26 |



**Discount-Merchant.com (800) 281-8860**  
THE TRUSTED SOURCE FOR PROJECTOR LAMPS AND ACCESSORIES

## Settings

|                                   |           |
|-----------------------------------|-----------|
| <b>Menu Navigation</b> .....      | <b>27</b> |
| Navigating through the MENU ..... | 27        |
| Main menu and sub-menu .....      | 28        |
| <b>PICTURE menu</b> .....         | <b>30</b> |
| PICTURE MODE .....                | 30        |
| CONTRAST .....                    | 30        |
| BRIGHTNESS .....                  | 30        |
| COLOUR .....                      | 30        |
| TINT .....                        | 30        |
| SHARPNESS .....                   | 30        |
| COLOUR TEMPERATURE .....          | 31        |
| DYNAMIC IRIS .....                | 31        |
| LIGHT HARMONIZER .....            | 31        |
| ADVANCED MENU .....               | 31        |
| FAVOURITE SAVE .....              | 32        |
| FAVOURITE LOAD .....              | 32        |
| FAVOURITE EDIT .....              | 33        |
| SIGNAL MODE .....                 | 33        |
| <b>POSITION menu</b> .....        | <b>34</b> |
| H-POSITION .....                  | 34        |
| V-POSITION .....                  | 34        |
| DOT CLOCK .....                   | 34        |
| CLOCK PHASE .....                 | 34        |
| ASPECT .....                      | 34        |
| WSS .....                         | 36        |
| OVER SCAN .....                   | 36        |
| KEYSTONE .....                    | 36        |
| AUTO SETUP .....                  | 36        |
| <b>FUNCTION BUTTON</b> .....      | <b>37</b> |
| FUNCTION BUTTON .....             | 37        |
| <b>OPTION menu</b> .....          | <b>38</b> |
| INPUT GUIDE .....                 | 38        |
| OSD DESIGN .....                  | 38        |
| OSD POSITION .....                | 38        |
| BACK COLOUR .....                 | 38        |
| STARTUP LOGO .....                | 38        |
| AUTO SEARCH .....                 | 38        |
| HDMI SIGNAL LEVEL .....           | 38        |
| INSTALLATION .....                | 38        |
| SLEEP .....                       | 39        |
| ALTITUDE .....                    | 39        |
| LAMP POWER .....                  | 39        |
| LAMP RUNTIME .....                | 39        |
| TEST PATTERN .....                | 39        |

## Maintenance

|                                       |           |
|---------------------------------------|-----------|
| <b>TEMP and LAMP Indicators</b> ..... | <b>40</b> |
| Managing the indicated problems ..... | 40        |
| <b>Care and Replacement</b> .....     | <b>41</b> |
| Cleaning the projector .....          | 41        |
| Replacing the lamp unit .....         | 42        |
| <b>Troubleshooting</b> .....          | <b>44</b> |

## Appendix

|  |           |
|--|-----------|
| <b>Technical Information</b> .....     | <b>45</b> |
| List of compatible signals .....       | 45        |
| Serial terminal .....                  | 46        |
| Specifications .....                   | 48        |
| Ceiling mount bracket safeguards ..... | 50        |
| Dimensions .....                       | 51        |
| Trademark acknowledgements .....       | 51        |
| <b>Index</b> .....                     | <b>52</b> |



Discount-Merchant.com (800) 281-8860

THE TRUSTED SOURCE FOR PROJECTOR LAMPS AND ACCESSORIES

# Precautions with regard to safety

## WARNINGS

**If you notice smoke, strange smells or noise coming from the projector, disconnect the mains plug from the mains socket.**

- Do not continue to use the projector in such cases, otherwise fire or electric shocks could result.
- Check that no more smoke is coming out, and then contact an Authorised Service Centre for repairs.
- Do not attempt to repair the projector yourself, as this can be dangerous.

**Do not install this projector in a place which is not strong enough to take the full weight of the projector.**

- If the installation location is not strong enough, it may fall down or tip over, and severe injury or damage could result.

**Installation work (such as ceiling suspension) should only be carried out by a qualified technician.**

- If installation is not carried out correctly, there is the danger that injury or electric shocks may occur.
- Do not use other than an authorised ceiling mount bracket.

**If foreign objects or water get inside the projector, or if the projector is dropped or the cabinet is broken, disconnect the mains plug from the mains socket.**

- Continued use of the projector in this condition may result in fire or electric shocks.
- Contact an Authorised Service Centre for repairs.

**Do not overload the mains socket.**

- If the power supply is overloaded (for example, by using too many adapters), overheating may occur and fire may result.

**Never attempt to modify or disassemble the projector.**

- High voltages can cause fire or electric shocks.
- For any inspection, adjustment and repair work, please contact an Authorised Service Centre.

**Clean the mains plug regularly to prevent it from becoming covered in dust.**

- If dust builds up on the mains plug, the resulting humidity can damage the insulation, which could result in fire. Pull the mains plug out from the mains socket and wipe it with a dry cloth.
- If not using the projector for an extended period of time, pull the mains plug out from the mains socket.

**Do not handle the mains plug with wet hands.**

- Failure to observe this may result in electric shocks.

**Insert the mains plug securely into the mains socket.**

- If the plug is not inserted correctly, electric shocks or overheating could result.
- Do not use plugs which are damaged or mains sockets which are coming loose from the wall.

**Do not place the projector on top of surfaces which are unstable.**

- If the projector is placed on top of a surface which is sloped or unstable, it may fall down or tip over, and injury or damage could result.

**Do not place the projector into water or let it become wet.**

- Failure to observe this may result in fire or electric shocks.

**Do not do anything that might damage the mains lead or the mains plug.**

- Do not damage the mains lead, make any modifications to it, place it near any hot objects, bend it excessively, twist it, pull it, place heavy objects on top of it or wrap it into a bundle.
- If the mains lead is used while damaged, electric shocks, short-circuits or fire may result.
- Ask an Authorised Service Centre to carry out any repairs to the mains lead that might be necessary.

**Do not place the projector on soft materials such as carpets or sponge mats.**

- Doing so may cause the projector to overheat, which can cause burns, fire or damage to the projector.

**Do not place liquid containers on top of the projector.**

- If water spills onto the projector or gets inside it, fire or electric shocks could result.
- If any water gets inside the projector, contact an Authorised Service Centre.

**Do not insert any foreign objects into the projector.**

- Do not insert any metal objects or flammable objects into the projector or drop them onto the projector, as doing so can result in fire or electric shocks.

**Do not allow the + and - terminals of the batteries to come into contact with metallic objects such as necklaces or hairpins.**

- Failure to observe this may cause the batteries to leak, overheat, explode or catch fire.
- Store the batteries in a plastic bag and keep them away from metallic objects.

**Do not touch the leaked liquid from the batteries.**

- If you touch the leaked liquid, it may hurt your skin. Immediately wash away the liquid with water and seek medical advice.
- If you get the leaked liquid in your eye, it may cause blindness or damage. Never rub your eye, and immediately wash away the liquid with water and seek medical advice.

**During a thunderstorm, do not touch the projector or the cable.**

- Electric shocks can result.

## Precautions with regard to safety

### Do not use the projector in a bath or shower.

- Fire or electric shocks can result.

### Do not place your skin into the light beam while the projector is being used.

- Strong light is emitted from the projector's lens. If you place directly into this light, it can hurt or damage your skin.

### Do not look into the lens while the projector is being used.

- Strong light is emitted from the projector's lens. If you look directly into this light, it can hurt and damage your eyes.
- Be especially careful not to let young children look into the lens. In addition, turn off the power and disconnect the mains plug when you are away from the projector.

### Do not place your hands or other objects close to the air outlet port.

- Heated air comes out of the air outlet port. Do not place your hands or face, or objects which cannot withstand heat close to this port [allow at least 50 cm (20") of space], otherwise burns or damage could result.

### Replacement of the lamp is recommended to be carried out by a qualified technician.

- The lamp has high internal pressure. If improperly handled, explosion might result.
- The lamp can easily become damaged if struck against hard objects or dropped, and injury or malfunctions may result.

### When replacing the lamp, allow it to cool for at least one hour before handling it.

- The lamp cover gets very hot, and touching it can cause burns.

### Before replacing the lamp, be sure to disconnect the mains plug from the mains socket.

- Electric shocks or explosions can result if this is not done.

### Do not allow infants or pets to touch the remote control unit.

- Keep the remote control unit out of the reach of infants and pets after using it.

## CAUTIONS

### Do not cover the air inlet port or the air outlet port.

- Doing so may cause the projector to overheat, which can cause fire or damage to the projector.
- Do not place the projector in narrow, badly ventilated places such as closets or bookshelves.
- Do not place the projector on cloth or papers, as these materials could be drawn into the air inlet port.

### Do not set up the projector in humid or dusty places or in places where the projector may come into contact with oily smoke or steam.

- Using the projector under such conditions may result in fire, electric shocks or plastic deterioration. The plastic deterioration may cause the falling down of the projector which is mounted in the ceiling.

### Do not set up the projector in a high temperature environment, such as near a heater or in direct sunlight.

Failure to observe this may result in fire, malfunction or plastic deterioration.

### Do not set up the projector outdoors.

- The projector is designed for indoor use only.

### When disconnecting the mains lead, hold the plug, not the lead.

- If the mains lead itself is pulled, the lead will become damaged, and fire, short-circuits or serious electric shocks may result.

### Always disconnect all cables before moving the projector.

- Moving the projector with cables still attached can damage the cables, which could cause fire or electric shocks to occur.

### Do not place any heavy objects on top of the projector.

- Failure to observe this may cause the projector to become unbalanced and fall, which could result in damage or injury.

### Do not short-circuit, heat or disassemble the batteries or place them into water or fire.

- Failure to observe this may cause the batteries to overheat, leak, explode or catch fire, and burns or other injury may result.

### When inserting the batteries, make sure the polarities (+ and -) are correct.

- If the batteries are inserted incorrectly, they may explode or leak, and fire, injury or contamination of the battery compartment and surrounding area may result.

### Use only the specified batteries.

- If incorrect or different kind of batteries are used, they may explode or leak, and fire, injury or contamination of the battery compartment and surrounding area may result.



## Precautions with regard to safety

### Do not mix old and new batteries.

- If the batteries are inserted incorrectly, they may explode or leak, and fire, injury or contamination of the battery compartment and surrounding area may result.

### Remove the used batteries from the remote control promptly.

- If you leave used batteries in the remote control for an extended period of time, it may cause liquid leaking, abnormal internal temperature rising or explosion.

### If not using the projector for an extended period of time, disconnect the mains plug from the mains socket and remove the batteries from the remote control.

- If dust builds up on the mains plug, the resulting humidity may damage the insulation, which could result in fire.
- Keeping or leaving the remote control with batteries inside may cause insulation deterioration, electrical leakage or explosion which could result in fire.

### Do not put your weight on this projector.

- You could fall or the projector could break, and injury may result.
- Be especially careful not to let young children stand or sit on the projector.

We are constantly making efforts to preserve and maintain a clean environment. Please take non repairable units back to your dealer or a recycling company.

### Disconnect the mains plug from the mains socket as a safety precaution before carrying out any cleaning.

- Electric shocks can result if this is not done.

### If the lamp has broken, ventilate the room immediately. Do not touch or bring your face close to the broken pieces.

- Failure to observe this may cause the user to absorb the gas which was released when the lamp broke and which contains nearly the same amount of mercury as fluorescent lamps, and the broken pieces may cause injury.
- If you believe that you have absorbed the gas or that the gas has got into your eyes or mouth, seek medical advice immediately.
- Ask your dealer about the replacement of the lamp unit and check the inside of the projector.

### Ask an Authorised Service Centre to clean inside the projector at least once a year.

- If dust is left to build up inside the projector without being cleaned out, it can result in fire or problems with operation.
- It is a good idea to clean the inside of the projector before the season for humid weather arrives. Ask your nearest Authorised Service Centre to clean the projector when required. Please discuss with the Authorised Service Centre regarding cleaning costs.

## Cautions when transporting

### Do not subject the projector to excessive vibration or shocks.

- The projector lens need to be handled with care.
- Cover the lens with the lens cover when transporting the projector.

### When transporting the projector, hold the body at the bottom securely.

- Do not hold the adjuster legs or the top cover to move the projector, as this may damage the projector.



**Discount-Merchant.com (800) 281-8860**  
**THE TRUSTED SOURCE FOR PROJECTOR LAMPS AND ACCESSORIES**

## Cautions when installing

### Avoid setting up in places which are subject to vibration or shocks.

- The internal parts can be damaged, which may cause malfunctions or accidents.

### Avoid setting up in places which are subject to sudden temperature changes, such as near an air conditioner or lighting equipment.

- The life of the lamp may be shortened or the projector may be turned off. See "TEMP indicator" on page 40.

### Do not set up the projector near high-voltage power lines or near motors.

- The projector may be subject to electromagnetic interference.

### If installing the projector to the ceiling, ask a qualified technician to carry out all installation work.

- You will need to purchase the separate installation kit (Model No. ET-PKX100). Furthermore, all installation work should only be carried out by a qualified technician.
- See "Ceiling mount bracket safeguards" on page 50 for the safety cable installation.

### If using this projector at high elevations (above 1 400 m), set the HIGHLAND to ON. See "ALTITUDE" on page 39.

- Failure to observe this may result in malfunctions or the life of the lamp or the other components may be shortened.

## Cautions on use

### In order to get the best picture quality

- Draw curtains or blinds over any windows and turn off any lights near the screen to prevent outside light or light from indoor lamps from shining onto the screen.

### Do not touch the surfaces of the lens with your bare hands.

- If the surface of the lens becomes dirty from fingerprints or anything else, this will be magnified and projected onto the screen. Moreover, when not using the projector, attach the lens cover.

### Liquid crystal panel

- Do not project the same image for long periods of time, as this may remain as an afterimage on the liquid crystal panel.
- The liquid crystal panel of the projector is built with very high precision technology to provide fine picture details. Occasionally, a few stuck pixels may appear on the screen as fixed points of blue, green or red. It is recommended to switch off the projector once and try after 1 hour later again. Please note that this does not affect the performance of your LCD.

### The projector has a high pressure mercury lamp and that is characterised as follows.

- The brightness of the lamp depends on the duration of use.
- The lamp may explode or shorten the lamp life by shocks or chipping damage.
- The lamp may explode only occasionally after using the projector.
- The lamp may explode if using the projector after the instructed lamp replacement timing.
- The lamp life is depends on individual lamp characteristics, usage condition and the installation environment. Especially the consecutive use of the projector for more than 10 hours, or the frequent switching on or off may greatly affect on the lamp life.

### Screen

- Do not apply any volatile substances which may cause discolouration to the screen, and do not let it become dirty or damaged.

### Optical components

- If you use the projector consecutively 6 hours every day, the optical components may need to be replaced in less than 1 year.



**Discount-Merchant.com (800) 281-8860**  
**THE TRUSTED SOURCE FOR PROJECTOR LAMPS AND ACCESSORIES**

## Precautions with regard to safety

### Accessories

Make sure the following accessories are provided with your projector.

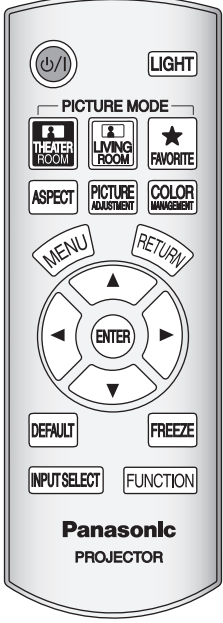
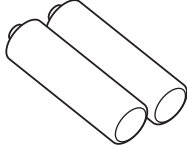
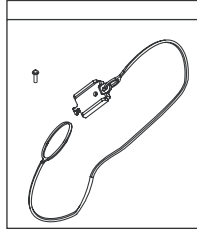
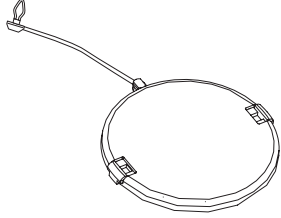
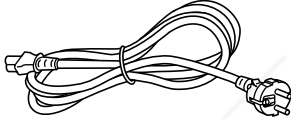
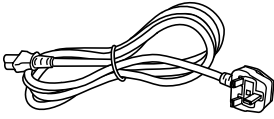
|   |   |  |  |
|---|---|--|--|
| <p><b>Remote control</b> for PT-AX200E (x1)<br/>N2QAYB000194</p>  | <p><b>AA batteries</b> for remote control (x2)</p>                     | <p><b>Safety cable</b><br/>TTRA0140<br/>Attachment screw (x1)<br/>Safety cable (x1)</p>  | <p><b>Lens cover</b> (x1)<br/>TKKL5372</p>  |
|   | <p><b>Mains lead for continental Europe</b> (x1)<br/>K2CM3FR00002</p>  | <p><b>Mains lead for UK</b> (x1)<br/>K2CT3FR00003</p>                                   |  |

\* The protectors for enclosed products, such as a plug cover or foam cartons must be treated properly.

# About Your Projector

## Remote control

**POWER** button  
While the **MAIN POWER** button is on, switch between stand-by mode and projection mode. (page 19)

**PICTURE MODE** buttons  
Switch to the best setting for a darker room.  
Switch to the best setting for a brighter room.  
Display the **FAVOURITE LOAD** menu. (page 22)

Switch to cycle through the aspect ratio. (page 23)

Display the main menu or return to the previous menu. (page 27)

Navigate through the menus with **▲▼◀▶**, and activate the menu item with **ENTER**. (page 27)

Reset some of the settings to the factory default settings. (page 23)

Switch to cycle through the input method. (page 26)

**Remote control signal emitter**  
Remote control signal. (page 22)

**LIGHT**  
Turn the button backlight of the remote control on/off. (page 22)

**COLOR MANAGEMENT**  
Display the **COLOUR MANAGEMENT** menu. (page 24)

**PICTURE ADJUSTMENT**  
Display the **PICTURE** menu. (page 23)

**RETURN**  
Return to the previous menu. (page 27)

**FREEZE**  
Capture the projected image as a still picture. (page 23)

**FUNCTION**  
Assign the frequently used functions from the option for shortcut. (page 26)

**Battery compartment**  
1. Press the tab and lift up the cover.  
2. Insert the batteries according to the polarity diagram indicated inside.

**NOTE:**

- Do not drop the remote control.
- Avoid contact with liquids or moisture.
- Use manganese batteries or alkaline batteries with the remote control.
- Do not attempt to modify or disassemble the remote control. Contact an Authorised Service Centre for repairs.
- Do not keep pressing the remote control buttons as this may shorten battery life.
- See "Remote control operation" on page 22.

# About Your Projector

## Projector body

### Top and front view

Preparation

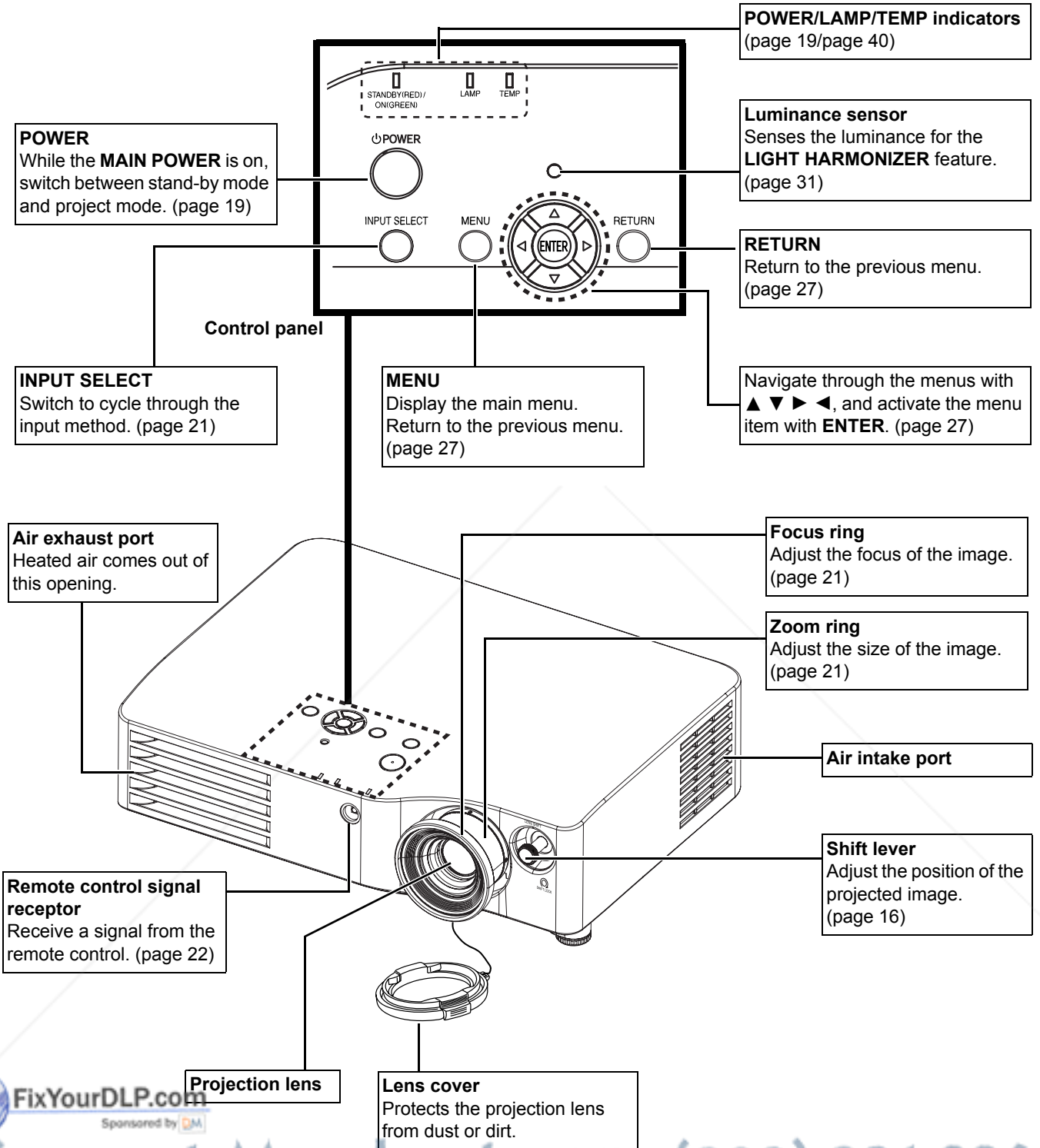

FixYourDLP.com  
Sponsored by DM

Discount-Merchant.com (800) 281-8860

### NOTE: TRUSTED SOURCE FOR PROJECTOR LAMPS AND ACCESSORIES

- Do not cover the ventilation openings or place anything within 50 cm (20") of them as this may cause damage or injury.
- While the projector is not in use, keep the lens cover to protect the lens.

**Back and bottom view**

**SERIAL**

Connect a compatible cable for controlling the projector remotely via your computer.

**COMPUTER IN**

Connect an RGB signal cable from your PC.

**S-VIDEO IN**

Connect a S-VIDEO signal cable.

**VIDEO IN**

Connect an RCA composite video cable.

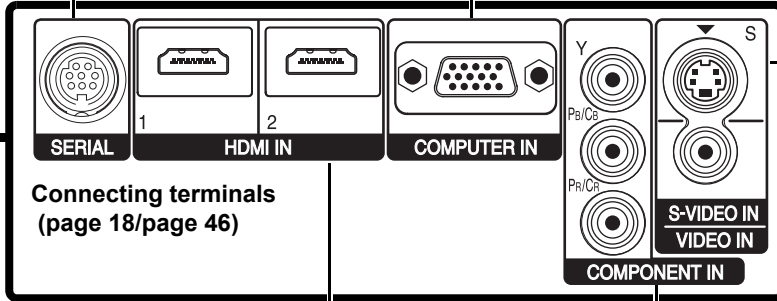

**Connecting terminals**  
(page 18/page 46)

**HDMI IN**

Connect HDMI signal cables.

**COMPONENT IN**

Connect YPBPR signal cables.

**MAIN POWER**

Switch the projector on/off  
(page 19)

**AC IN**

Connect the mains lead to supply electronic power to the projector. (page 19)

**Air intake port**

**Lamp unit compartment**  
(page 41)

**Security lock**

Attach the shackle lock provided with the projector. Compatible with the Kensington MicroSaver Security System. (page 50)

**Air filter** (page 41)

**Lens cover attachment hole**

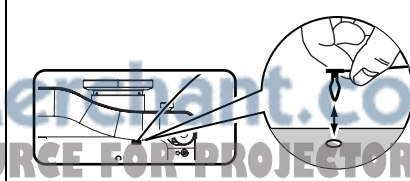

**Front leg adjusters**

Screw up/down to adjust the projection angle. (page 15)

**NOTE:**

- Do not cover the ventilation openings or place anything within 10 cm (4") of them as this may cause damage or injury.
- The projector should only be used with the attached mains lead to ensure optimum performance and avoid damage to the projector.



Discount-Merch.com (800) 281-8860  
THE TRUSTED SOURCE FOR PROJECTOR LAMPS AND ACCESSORIES

# Setting up

## Screen size and throw distance

You can adjust the projection size with 2.0x zoom lens. Calculate and define the throw distance as follows.

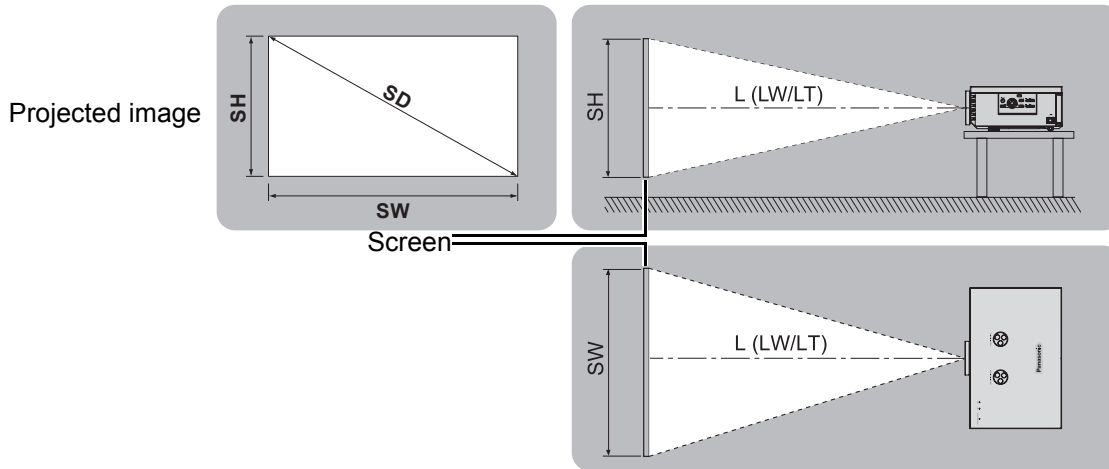

Getting Started

| Projection size (16 : 9) |                    |                   | Throw distance (L)    |                       |
|--------------------------|--------------------|-------------------|-----------------------|-----------------------|
| Screen Diagonal (SD)     | Screen height (SH) | Screen width (SW) | Minimum distance (LW) | Maximum distance (LT) |
| 1.02 m (40")             | 0.50 m (1'7")      | 0.89 m (2'11")    | 1.2 m (3'11")         | 2.4 m (7'10")         |
| 1.27 m (50")             | 0.62 m (2')        | 1.11 m (3'7")     | 1.5 m (4'11")         | 3.0 m (9'10")         |
| 1.52 m (60")             | 0.75 m (2'5")      | 1.33 m (4'4")     | 1.8 m (5'10")         | 3.7 m (12'1")         |
| 1.78 m (70")             | 0.87 m (2'10")     | 1.55 m (5'1")     | 2.1 m (6'10")         | 4.3 m (14'1")         |
| 2.03 m (80")             | 1.00 m (3'3")      | 1.77 m (5'9")     | 2.4 m (7'10")         | 4.9 m (16')           |
| 2.29 m (90")             | 1.12 m (3'8")      | 1.99 m (6'6")     | 2.7 m (8'10")         | 5.5 m (17')           |
| 2.54 m (100")            | 1.24 m (4')        | 2.21 m (7'3")     | 3.1 m (10'2")         | 6.2 m (20'4")         |
| 3.05 m (120")            | 1.49 m (4'10")     | 2.66 m (8'8")     | 3.7 m (12'1")         | 7.4 m (24'3")         |
| 3.81 m (150")            | 1.87 m (6'1")      | 3.32 m (10'10")   | 4.6 m (15'1")         | 9.3 m (30'6")         |
| 5.08 m (200")            | 2.49 m (8'2")      | 4.43 m (14'6")    | 6.2 m (20'4")         | 12.4 m (40'8")        |

\* All measurements above are approximate and may differ slightly from the actual measurements.

### Calculation methods for screen dimensions

You can calculate more detailed screen dimension from the screen diagonal.

$$SW (m) = SD (m) \times 0.872$$

$$SH (m) = SD (m) \times 0.490$$

$$LW (m) = 1.2244 \times SD (m) - 0.056$$

$$LT (m) = 2.449 \times SD (m) - 0.056$$

\* The results above are approximate and may differ slightly from the actual measurements.

#### NOTE:

- Do not use the projector at a raised or a horizontally tilted position as it may cause malfunction of the projector.
- Make sure the projector lens surface is parallel with the screen. You can tilt the projector body less than approximately  $\pm 30^\circ$  vertically. Overtilting may result in shortening the component's life.
- For the best quality of the projection image, install a screen where sun light or room light does not shine directly onto the screen. Close window shades or curtains to block the lights.

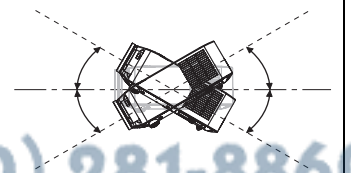

## Projection method

You can use the projector with any of the following 4 projection methods. To set the desired method in the projector, See "INSTALLATION" on page 38.

### ■ Setting on a desk/floor and projecting from front

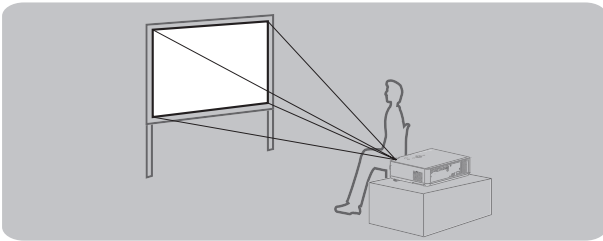

INSTALLATION: FRONT/DESK

### ■ Setting on a desk/floor and projecting from rear

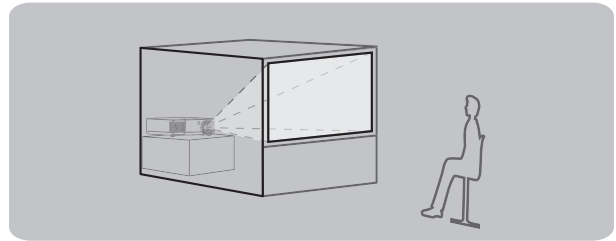

INSTALLATION: REAR/DESK

### ■ Mounting in the ceiling and projecting from front

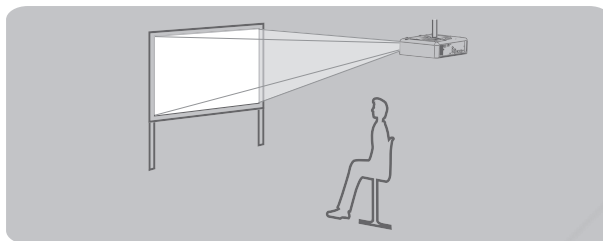

INSTALLATION: FRONT/CEILING

### ■ Mounting in the ceiling and projecting from rear

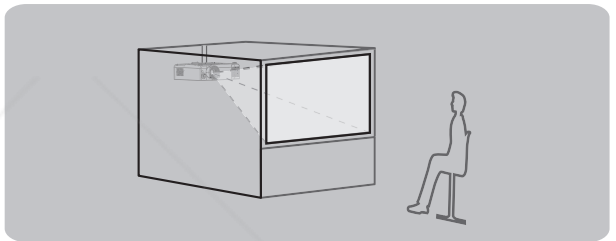

INSTALLATION: REAR/CEILING

#### NOTE:

- A translucent screen is required for rear projection.
- When mounting the projector in the ceiling, the optional ceiling mount bracket (ET-PKX200) is required.
- See "Ceiling mount bracket safeguards" on page 50.

## Front leg adjusters and throwing angle

You can screw up/down the front leg adjusters to control the angle of the projector for adjusting the throwing angle. See "Positioning the image" on page 21.

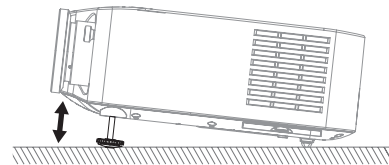
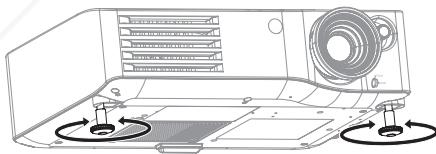

#### NOTE:

- Heated air comes out of the air exhaust port. Do not touch the air exhaust port directly.
- If keystone distortion occurs, see "KEYSTONE" on page 36.
- Screw up the adjuster legs, and an audible click will be heard as the limit.



## Setting up

### Lens shift and positioning

If the projector is not positioned right in front of the centre of the screen, you can adjust the projected image position by moving the lens shift dials within the shift range of the lens.

#### Adjusting the lens shift lever

1. Screw the shift lever counterclockwise to unlock.
2. Move the shift lever to adjust the projected image position.
3. Screw the shift lever clockwise to lock.

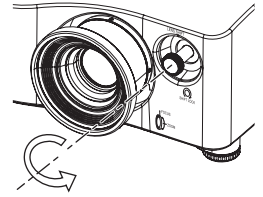

#### Horizontal shift

You can place the projector where the projector lens is up to 25% horizontally off-centre from the screen and then adjust the image position with the lens shift feature.

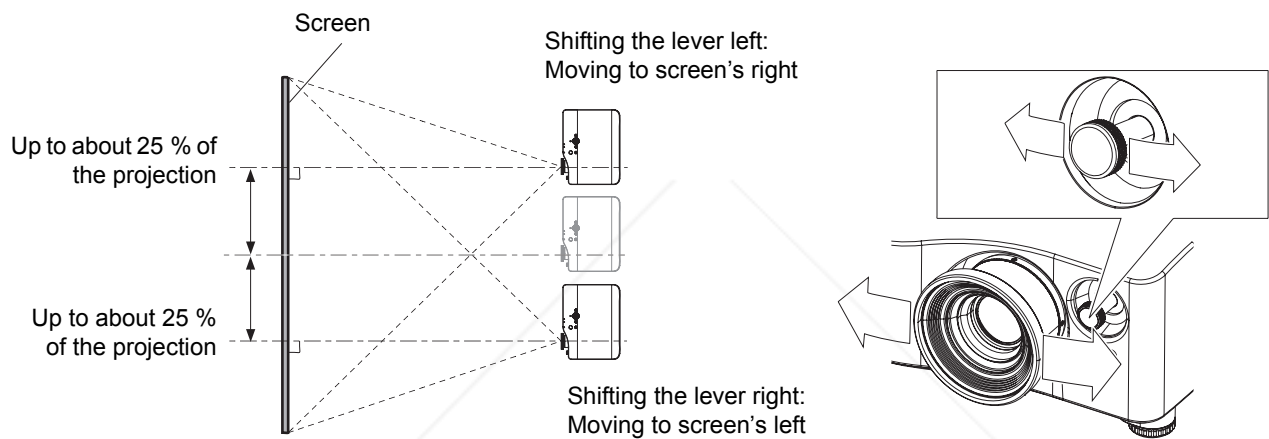

#### Vertical shift

You can place the projector where the projector lens is up to 63% vertically off-centre from the screen and the adjust the image position with the lens shift feature.

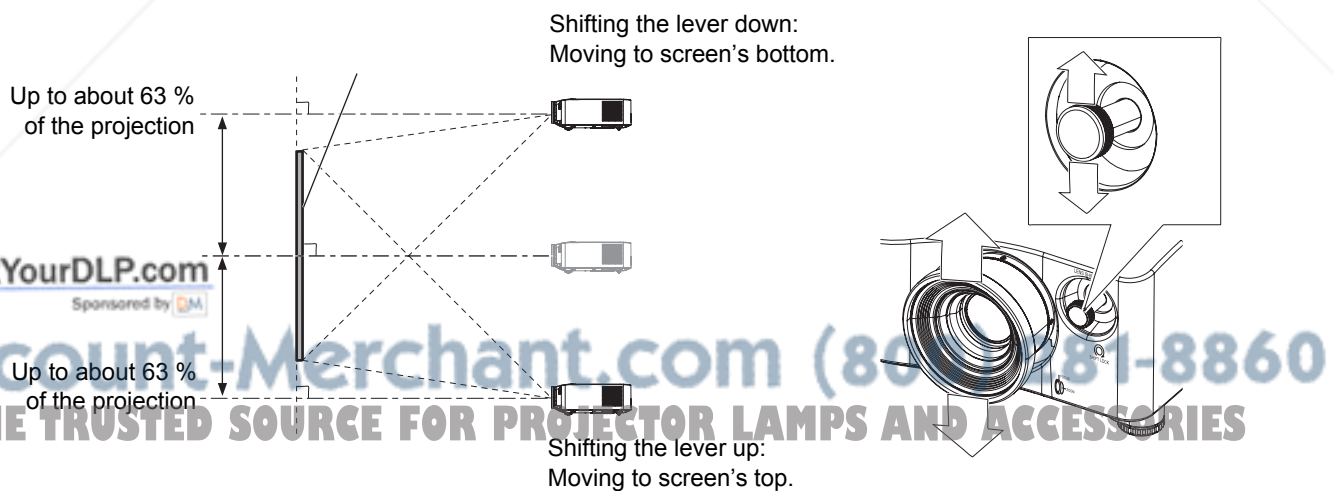

## Projector location range

You can determine where to locate the screen and the projector by considering the lens shift possibilities. See "Positioning the image" on page 21.

### When the screen position is fixed

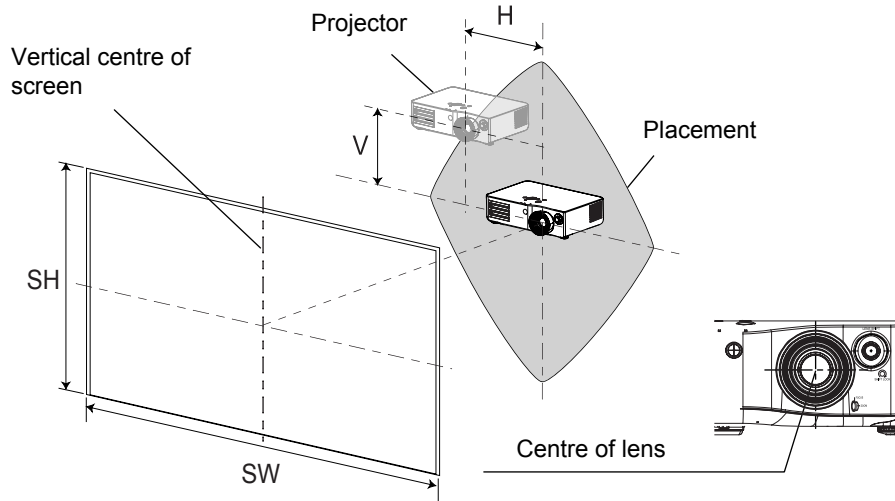

### When the projector position is fixed

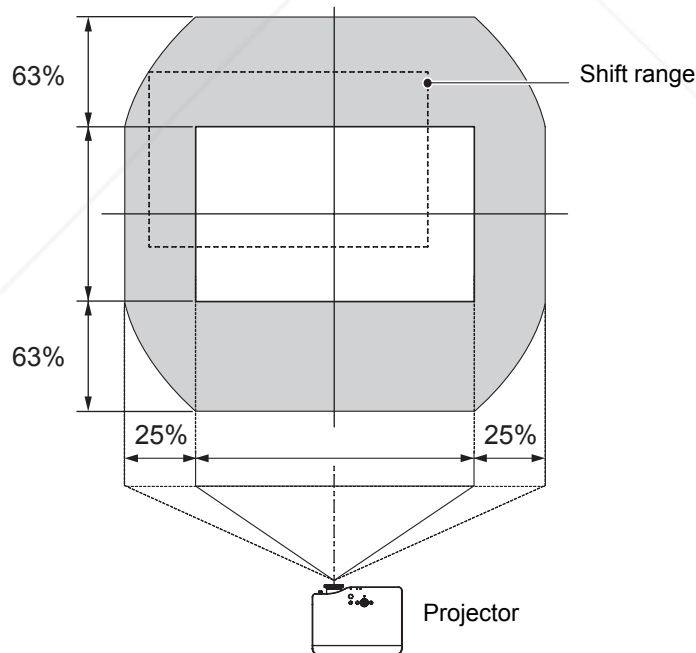

#### NOTE:

- When the projector is located right in front of the screen and the lens shift dials is centred, you will get the best quality of the projection image.
- When the shift lever is at the vertical limit of the shift range, you cannot move the lever to the horizontal limit, likewise when the shift lever is at the horizontal limit of the shift range, you cannot move the lever to the vertical limit.
- When the projector is tilted and you adjust **KEYSTONE**, the centre of the screen and the lens need to be realigned.
- Do not attempt to pull hard the shift lever while adjusting as this may damage the projector.

# Connections

## Before connecting to the projector

- Read and follow the operating and connecting instructions of each peripheral device.
- The peripheral devices must be turned off.
- Use cables that match each peripheral device to be connected.
- Confirm the type of video signals. See “List of compatible signals” on page 45.
- Audio cables must be connected from each peripheral device directly to the audio reproduction system.

## Connecting to COMPONENT IN/VIDEO IN/S-VIDEO IN

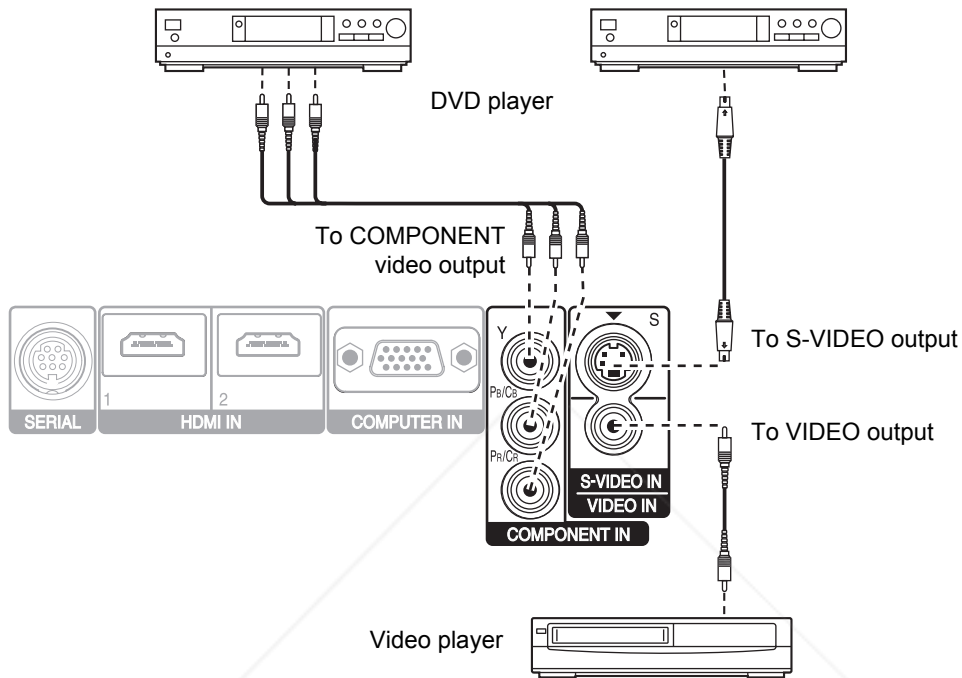

Getting Started

## Connecting to COMPUTER IN/HDMI IN

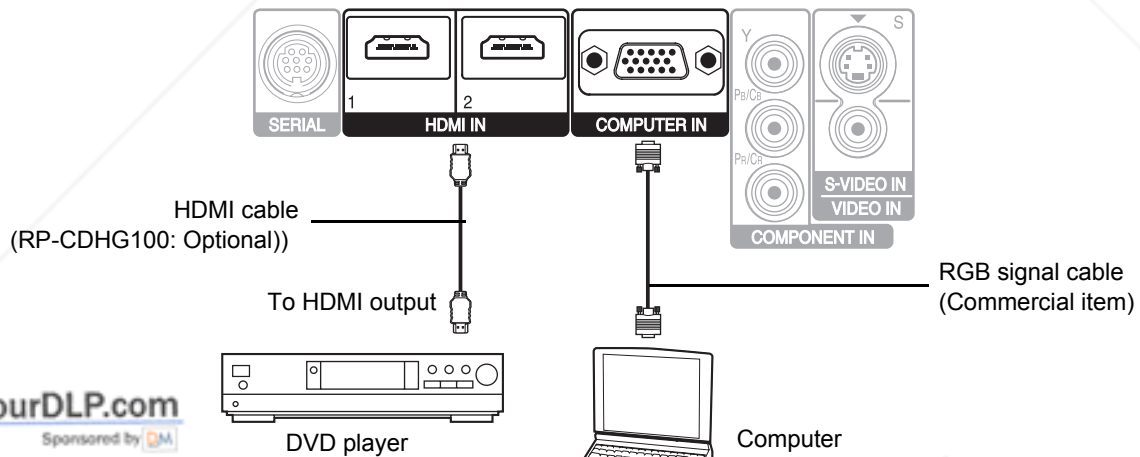

 FixYourDLP.com  
Sponsored by 

Discount-Merchant.com (800) 281-8860  
THE TRUSTED SOURCE FOR PROJECTOR LAMPS AND ACCESSORIES

### NOTE:

- Make sure the HDMI cable is adapted to your HDMI device for proper performance.
- A compatible cable is required for an HDMI 1 080p signal.
- It is possible to connect with DVI devices via a HDMI/DVI conversion adapter, but some equipment may not project the image properly or other problems could be encountered. “Serial terminal” on page 46

# Switching the projector on/off

## Mains lead

### Connecting

1. Make sure the shape of the mains plug and the **AC IN** connector on the back of the projector match, then push the plug all the way in.
2. Connect the mains lead to a mains socket.

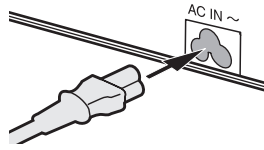

### Disconnecting

1. Make sure the **MAIN POWER** is switched off and unplug the mains lead from the mains socket.
2. Hold the plug and unplug the mains lead from the **AC IN** connector on the side of the projector.

### NOTE:

- Do not use other than the provided mains lead.
- Ensure all the input devices are connected and turned off before connecting the mains lead.
- Do not force the connector as this may damage the projector and/or the mains lead.
- Dirt or dust build-up around plugs may cause fire or electrical hazards.
- Switch off the power to the projector when not in use.

## POWER indicator

### POWER indicator

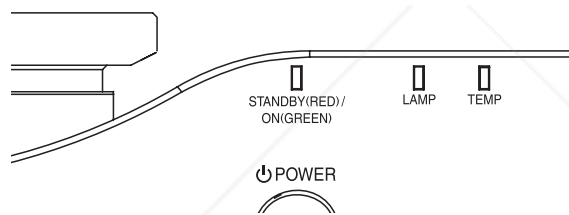

| Indicator status            |          | Status   |
|-----------------------------|----------|--|
| No illumination or flashing |          | The <b>MAIN POWER</b> button is switched off.  |
| Red                         | Lit      | The <b>MAIN POWER</b> button is switched on and the projector is in standby.   |
| Green                       | Flashing | The <b>POWER</b> button is switched on and the projector is getting ready to project.  |
|                             | Lit      | The projector is ready to project.   |
| Orange                      | Lit      | The <b>POWER</b> button is switched off and the projector is cooling the lamp.   |
|                             | Flashing | The <b>POWER</b> button is switched on again when cooling the lamp and recovering to projection mode. Recovery may take a while. |

### NOTE:

- While the projector is cooling the lamp, do not switch the **MAIN POWER** button off or unplug the mains lead.
- The electric consumption in standby mode is 0.08 W.

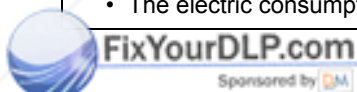

**Discount-Merchant.com (800) 281-8860**  
**THE TRUSTED SOURCE FOR PROJECTOR LAMPS AND ACCESSORIES**

## Switching the projector on/off

### Switching on the projector

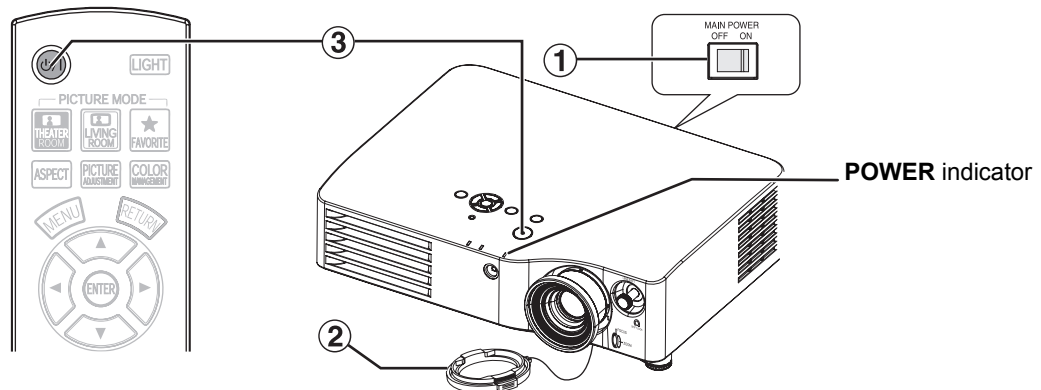

1. Switch the **MAIN POWER** button on.
  - The power indicator lights up in red.
2. Remove the lens cover from the lens.
3. Press the **POWER** button.
  - The power indicator lights up in green after flashing for a while.
  - The **STARTUP LOGO** is displayed on the screen. See "STARTUP LOGO" on page 38.

#### NOTE:

- When starting up the projector, some small rattling or tinkling sound may be heard, or the display may flicker for the characteristics of the lamp. Those are normal and do not affect the performance of the projector.
- Do not attempt to modify the lens cover which may cause burns, fire or damage to the projector.

### Switching off the projector

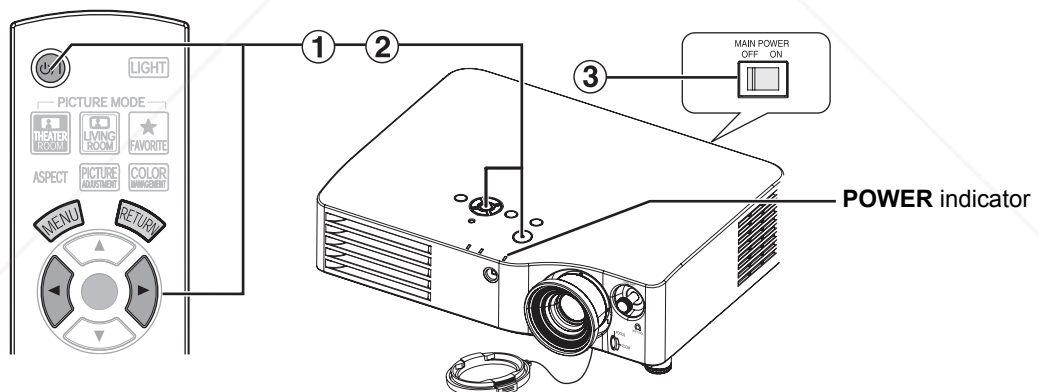

1. Press the **POWER** button.
  - The confirmation screen is displayed. It will disappear and return to the projection after 10 seconds without any operation.
  - To return to the projection, press **ENTER** to select **CANCEL** or press **MENU/RETURN**.
2. Press ◀ to select **OK** and press the **POWER** or **ENTER** button.
  - The power indicator lights up in orange while cooling the lamp, then illuminates red when it is ready to switch off the **MAIN POWER** button.
3. Switch off the **MAIN POWER** button on the back of the projector.

#### NOTE:

- Press the **POWER** twice or for a long duration to switch the power off.

# Projecting an image

## Selecting the input signal

1. Switch on the connected devices.
  - Press the play button of the required device.
2. Press the **INPUT SELECT** button to select the required input method if needed. See “Switching the input signal” on page 26.
  - The image will be projected on the screen.

### NOTE:

- **AUTO SEARCH** is **ON** as default and the signal from the connected devices is detected automatically. See “AUTO SEARCH” on page 38.

## Positioning the image

1. Press the **ASPECT** button to select the required aspect mode. See “Switching the aspect ratio” on page 23.
2. Adjust the projected image with the lens shift levers. See “Lens shift and positioning” on page 16.
4. Adjust the focus and the projected image size.
  - Turn the focus ring and zoom ring to adjust.
  - You can confirm the result with **TEST PATTERN**. See “TEST PATTERN” on page 39.

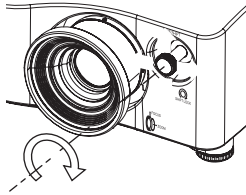

3. Adjust the angle of the projector.
  - Screw down the front leg adjusters and adjust the angle vertically.
  - See “Front leg adjusters and throwing angle” on page 15.

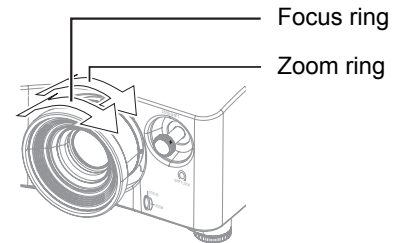
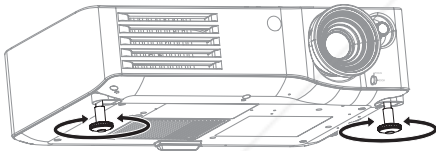

### NOTE:

- Do not touch the air exhaust port as this may cause burns or injury.
- If keystone distortion occurs, see “KEYSTONE” on page 36.
- If you adjust the focus, you may need to adjust the size of the image again.

# Remote control operation

## Operating range

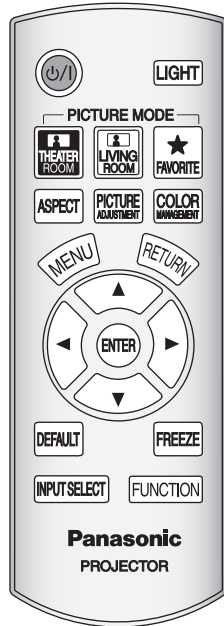

You can operate the projector with the remote control within the remote range 7 m (22'11").

### ● Facing to the projector

Ensure the remote control emitter is facing to the remote control signal receptor on front/back of the projector and press the required buttons to operate.

### ● Facing to the screen

Ensure the remote control emitter is facing to the screen and press the required buttons to operate the projector. The signal will be reflected off the screen. The operating range may differ due to the screen material. This function may not be effective with a translucent screen.

#### NOTE:

- Do not let strong light shine onto the signal receptor. The remote control may malfunction under strong light such as fluorescent.
- If there are any obstacles between the remote control and the remote control signal receptor, the remote control may not operate correctly.

## Turning on the button backlight

**LIGHT**

In a dark room, you can turn on the button backlight to operate the remote control. Press the **LIGHT** button on the upper right corner of the unit to turn on the backlight and enter the light-on mode.

After 5 seconds without any operation, the backlight will be faded, and it will go out after another 5 seconds. Press any but the **LIGHT** button to turn on again. To escape from the light-on mode, press the **LIGHT** button.

## Switching the preset settings

You can switch the preset settings by pressing the **THEATER ROOM**, **LIVING ROOM**, **FAVORITE LOAD** buttons. See "FAVOURITE LOAD" on page 32.



Recommended for viewing in dark room.

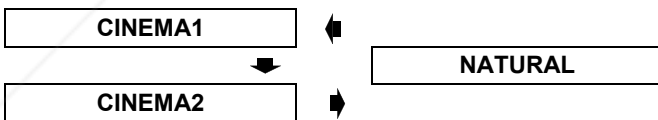

Display the **FAVOURITE LOAD** menu. See "FAVOURITE LOAD" on page 32.



Recommended for viewing in lit room.

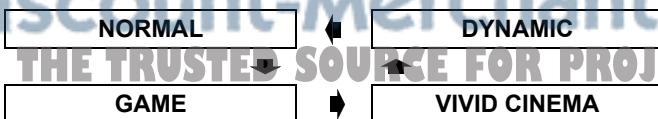

## Adjusting the image



You can display the **PICTURE** and **ADVANCED MENU** menu items by pressing the **PIC. ADJUST** button. Press the button to switch between **PICTURE** and **ADVANCED MENU** menu. Press **▲ ▼** to select the required menu item and **◀ ▶** to adjust.

### ● PICTURE menu items

**PICTURE MODE, CONTRAST, BRIGHTNESS, COLOUR, TINT, SHARPNESS, COLOUR TEMPERATURE and DYNAMIC IRIS**

### ● ADVANCED MENU items

**GAMMA, CONTRAST, BRIGHTNESS, NR, MPEG NR, CINEMA REALITY and TV-SYSTEM**

#### NOTE:

- For each menu items description, see "PICTURE menu" on page 30.
- The screen will be cleared after 7 seconds without any operation.

## Switching the aspect ratio



The aspect ratio will be selected automatically, or you can switch it manually by pressing the **ASPECT** button. Press the button several times to cycle through the different aspect type as follows. See "ASPECT" on page 34.

### ● VIDEO/S-VIDEO/COMPONENT (YPBPR)

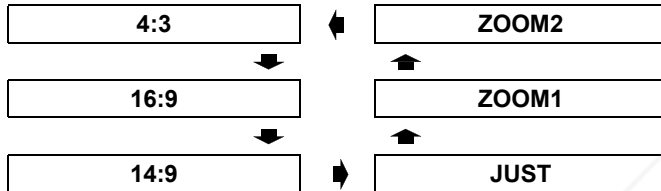

### ● COMPUTER (RGB)

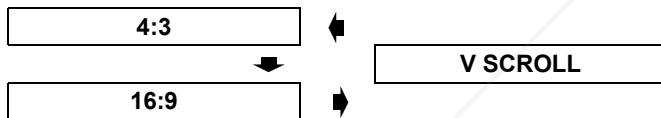

### ● HDMI



#### NOTE:

- If you project an image with an unmatched aspect ratio, the image may distort or some portions may be cropped. Select an aspect ratio which preserves the intention of the image creator.
- The order of aspect type is defined not only by the input method but also by the input signals. See "List of compatible signals" on page 45.
- If you project a copyrighted image enlarged or distorted by using **ASPECT** function in commercial use in a public place, such as a restaurant or hotel, you might infringe on the copyright of the creator which is protected by copyright law.

## Resetting to the factory default settings



You can reset most of the customised settings to the factory defaults by pressing **DEFAULT** button of the remote control.

Display the required sub-menu or the menu items and press the button again.

#### NOTE:

- Some menu items are not available to reset by pressing the **DEFAULT** button. Adjust each menu items manually.

## Capturing an image



When projecting an image, press **FREEZE** button to capture the projected image and display it on the screen as a still picture. Press again to escape.



## Setting your own colour profile



You can adjust a selected colour individually and save and retrieve under the **PICTURE MODE** setting. Press the **COLOR MANAGEMENT** button to open the menu.

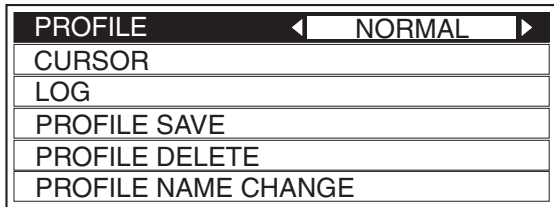

### ● Adjusting the selected colour

Select a colour and adjust **COLOUR**, **TINT** and **BRIGHTNESS**.

1. Select the **CURSOR** menu and press **ENTER**.
  - The projected image is captured, and the target cursor is displayed.
  - When the **LOG** is fully stored, the target cursor will not be displayed. See "Managing stored logs" on page 24.

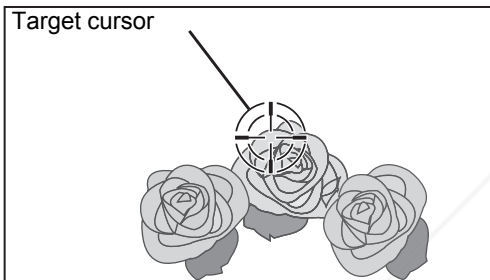

2. Move the cursor with **▲ ▼ ◀ ▶** to the required place to select a colour and press **ENTER**.
  - The colour at the centre of the target cursor is sampled and the sample box is displayed on the left of the cursor. The menu items are displayed on the upper part of the screen.

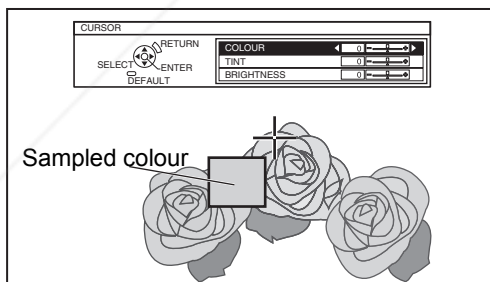

3. Select a menu item and the **◀ ▶** to adjust each item level.
  - The result box is displayed on the right of the cursor and shows the adjusted colour.

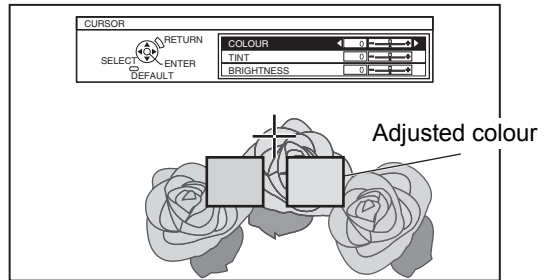

|                   |   |
|-------------------|---|
| <b>COLOUR</b>     | Adjust the vividness of the colour.<br>Setting range: -30 to +30  |
| <b>TINT</b>       | Adjust the colour tone.<br>Setting range: -30 to +30              |
| <b>BRIGHTNESS</b> | Adjust the brightness of the colour.<br>Setting range: -20 to +20 |

4. Press **ENTER** to store the adjusted result.
  - "**PROCESSING**" is displayed for a few seconds and the result is stored in **LOG**.
  - You can store up to 8 logs under **LOG** for each **PICTURE MODE** setting.
5. Press **MENU** or **RETURN** to return to the previous menu.
  - Repeat the steps above to store more adjustment.

### ● Managing stored logs

You can edit or delete the stored logs of the selected **PICTURE MODE**.

1. Select **LOG** and press **ENTER**.
  - The **LOG** menu is displayed.

| PICTURE MODE : CINEMA1 |     |     |     |
|------------------------|-----|-----|-----|
| POINT1                 | 0   | 0   | +2  |
| POINT2                 | -1  | 0   | -2  |
| POINT3                 | 0   | +10 | 0   |
| POINT4                 | -10 | +10 | -10 |
| POINT5                 | -6  | +5  | +7  |
| POINT6                 | +3  | -3  | +1  |
| POINT7                 | 0   | +7  | +9  |
| POINT8                 | -1  | +14 | -4  |
| ALL DELETE             |     |     |     |

Sampled colour Adjusted colour

2. Select the required log from 1 - 8 or **ALL DELETE**, and press **ENTER**.
  - Select **CHANGE** to edit the log.  
The cursor menu is displayed and you can readjust the colour.
  - Select **DELETE** to delete the log.  
The confirmation screen will be displayed. Select **OK** to delete.
  - When you select **ALL DELETE**, the "**DELETE ALL LOG.**" screen is displayed. Select **OK** to delete all logs. The **PROFILE** setting will be set to **NORMAL**.

## ● Saving a log setting as a profile

Return to the **COLOUR MANAGEMENT** menu and save the stored log as a profile. Make sure that the **PICTURE MODE** is not switched.

1. Select the **PROFILE SAVE** menu and press **ENTER**
  - The **PROFILE SAVE** menu is displayed. You can save the profile as **USER1**, **USER2** and **USER3**.

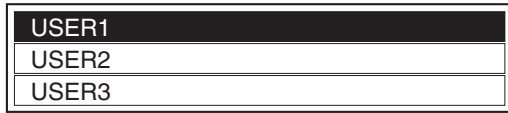

2. Press **ENTER** to save the profile
  - The confirmation screen is displayed. Press **ENTER** again to save.
3. Use **▲ ▼ ◀ ▶** to specify the location of the required character to enter and press the **ENTER** button.
  - You can enter up to 14 characters.

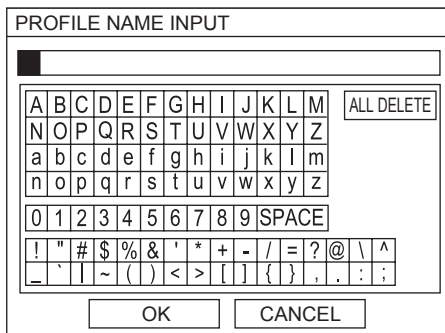

4. Repeat step 3 until you finish the text line.
  - Move the cursor to **DEL ALL** and press the **ENTER** button to delete all the entered text line.
  - Press the **DEFAULT** button to delete the last entered character or indicated with cursor in the text box.
  - To insert a character in the entered text line, move the cursor to the text box to select the required place and press **▼** then perform step 4.
5. Select **OK** and press the **ENTER** button to set the entered text as a name.
  - Press the **ENTER** without entering any text to keep the default name.

## ● Changing the profile names

You can change the name of the profiles from the **PROFILE NAME CHANGE** menu.

1. Select **PROFILE NAME CHANGE** and press the **ENTER** button.
2. Select the required profile and press the **ENTER** button.
3. Use **▲ ▼ ◀ ▶** to specify the location of the required character to enter and press the **ENTER** button.
4. Select **OK** and press the **ENTER** button to set the entered text as a name.

## ● Loading saved profiles

When profiles are loaded under the **PICTURE MODE** setting, you can keep them as you defined until the **PROFILE** is set to **NORMAL**.

1. Select the required **PICTURE MODE** and press **ENTER**.
2. Press the **COLOR MANAGEMENT** button and select the **PROFILE** menu.
  - The profile settings of the selected **PICTURE MODE** will be displayed.
3. Select the required profile and press **ENTER**.

|               |  |
|---------------|--|
| <b>NORMAL</b> | Return to the default setting of the <b>PICTURE MODE</b> menu. |
| <b>USER1</b>  | Defined profile settings.                                      |
| <b>USER2</b>  |  |
| <b>USER3</b>  |  |

## ● Deleting the saved profiles

You can delete the profiles from **PROFILE DELETE** menu.

1. Select **PROFILE DELETE** and press the **ENTER** button.
2. Select the required profile or **ALL DELETE** and press the **ENTER** button.
  - The confirmation screen will be displayed and select **OK**.
3. Press the **ENTER** button.

### NOTE:

- **LOG** and **PROFILE SAVE** are not displayed before you apply **COLOUR MANAGEMENT**.
- If you load a profile with a different attribute mode of the profile, the **CURSOR** and **PROFILE SAVE** menus will not be displayed.
- The approximate colours will be adjusted at the same time. If you adjust the exact same colour differently, both colours will affect each other and you might get unexpected results.
- White, Black and Grey are not adjustable.
- If you escape the **COLOUR MANAGEMENT** menu or attempt to perform another menu action before you save the adjusted profile, the confirmation screen will be displayed.
- If you switch the input signal before you save the profile, the setting will be cancelled without notice.

## Remote control operation

### Switching the input signal

**INPUT SELECT**

You can switch the input method manually by pressing the **INPUT SELECT** button. Press the button several times or press ◀ ▶ to cycle through the input methods as follows. The actual projected image will be changed in a while.

- The graphical guidance will be displayed on the upper right of the projected image and you can confirm the selected input method which is highlighted in yellow. See "INPUT GUIDE" on page 38.

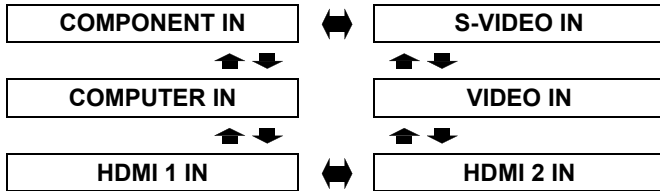

|                     |  |
|---------------------|--|
| <b>COMPONENT IN</b> | <b>COMPONENT</b> (YPBPR) signals from the equipment connected to <b>COMPONENT IN</b> . |
| <b>S-VIDEO IN</b>   | <b>S-VIDEO</b> signal from the equipment connected to <b>S-VIDEO IN</b> .              |
| <b>VIDEO IN</b>     | <b>VIDEO</b> signal from the equipment connected to <b>VIDEO IN</b> .                  |
| <b>HDMI 1 IN</b>    | <b>HDMI</b> signal from the equipment connected to <b>HDMI 1 IN/HDMI IN 2</b> .        |
| <b>HDMI 2 IN</b>    |  |
| <b>COMPUTER IN</b>  | <b>COMPUTER</b> (RGB) signal from the equipment connected to <b>COMPUTER IN</b> .      |

#### NOTE:

- If you select an unplugged input method, the guidance will blink on and off several times.
- See "List of compatible signals" on page 45.
- See "Connections" on page 18.

### Assigning the functions for shortcut

You can assign the following menu options to the **FUNCTION** button for shortcut. See "FUNCTION BUTTON" on page 37.

|                         |         |
|-------------------------|---------|
| <b>BLANK</b>            | page 37 |
| <b>SLEEP</b>            | page 39 |
| <b>FAVOURITE LOAD</b>   | page 32 |
| <b>LIGHT HARMONIZER</b> | page 31 |
| <b>AUTO SETUP</b>       | page 36 |
| <b>HDMI 1 IN</b>        | page 26 |
| <b>HDMI 2 IN</b>        |         |
| <b>COMPUTER IN</b>      |         |
| <b>COMPONENT IN</b>     |         |

|                     |         |
|---------------------|---------|
| <b>S-VIDEO IN</b>   | page 26 |
| <b>VIDEO IN</b>     | page 30 |
| <b>NORMAL</b>       |         |
| <b>DYNAMIC</b>      |         |
| <b>CINEMA1</b>      |         |
| <b>CINEMA2</b>      |         |
| <b>VIVID CINEMA</b> |         |
| <b>GAME</b>         |         |
| <b>NATURAL</b>      |         |

# Menu Navigation

The menu system allows you to access functions which do not have their own dedicated buttons on the remote control. The menu options are structured and categorised. You can navigate through the menu with ▲ ▼ ► ◀ buttons.

## Navigating through the MENU

### Displaying the main menu



Press the **MENU** button to display the main menu and the operating guidance.

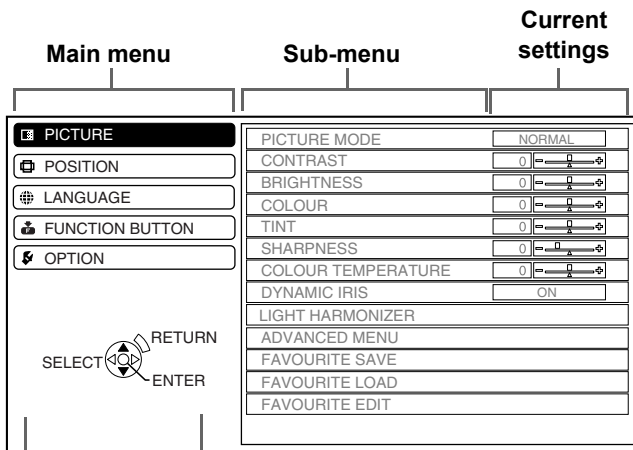

#### Operating guidance

Contains the required buttons to adjust the settings.

### Adjusting with the bar scale items

The triangle mark under the bar indicates factory default setting and the square indicates the current setting.

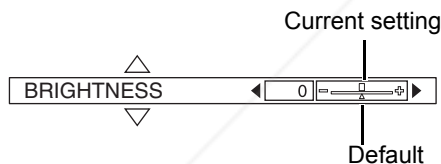

### Returning to the previous menu



Press the **MENU** or **RETURN** button to return to the previous menu. Press repeatedly to escape from the menu mode and return to the projection.

### Operating procedure

- Press ▲ ▼ to scroll to the required main menu item and press **ENTER** to select.
  - The selected item is highlighted in orange and the sub-menu is displayed on the right.
  - See "Main menu and sub-menu" on page 28.

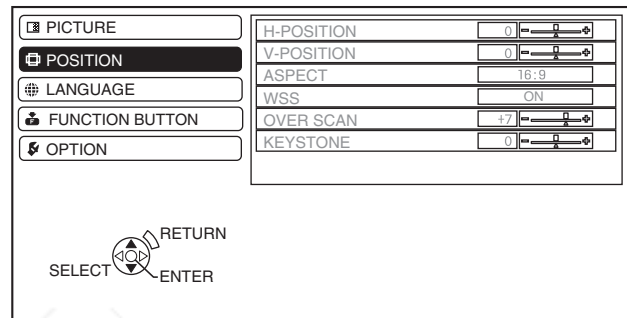

- Press ▲ ▼ to scroll to the required sub-menu item and press ◀ ► or **ENTER** to adjust.
  - The selected item is called up and the other menu items disappear from the screen. Called up item will be disappear after 5 seconds and return to the menu mode.
  - If there is a lower level, the next level will be displayed.

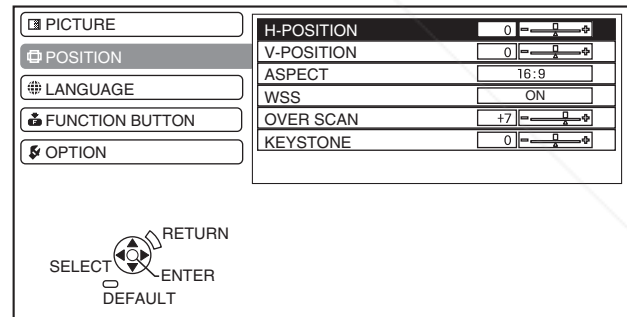

- Press ◀ ► to adjust or set the selected item.
  - For items using a bar scale, the current settings are displayed on the left of the bar scale.
  - You can cycle through the options of an item by pressing ◀ ►.



- Press **MENU** or **RETURN** to return to the previous menu.

#### NOTE:

- See "Resetting to the factory default settings" on page 23 to reset each menu items.

## Menu Navigation

### Main menu and sub-menu

The main menu has 5 options. Select the required menu item and press **ENTER** to display the sub-menu.

**NOTE:**







- Some default settings vary by the selected input signal.
- Sub-menu items vary according to the selected input signal.
- Some settings are adjustable without any signals.

| Main menu   | Sub-menu                                 | Options (Underlined is default setting)   | Page  |         |  |
|---|--|---|---|---------|--|
| <b>PICTURE</b><br> | <b>PICTURE MODE</b>                      | NATURAL <u>NORMAL</u> DYNAMIC<br>CINEMA1      CINEMA2      VIVID CINEMA<br>GAME | page 30   |         |  |
|   | <b>CONTRAST</b>                          | • Default: 0  | page 30   |         |  |
|   | <b>BRIGHTNESS</b>                        | • Default: 0  | page 30   |         |  |
|   | <b>COLOUR</b>                            | • Default: 0  | page 30   |         |  |
|   | <b>TINT</b>                              | • Default: 0  | page 30   |         |  |
|   | <b>SHARPNESS</b>                         | • Default: 0  | page 30   |         |  |
|   | <b>COLOUR TEMPERATURE</b>                | • Default: 0  | page 31   |         |  |
|   | <b>DYNAMIC IRIS</b>                      | <u>ON</u> OFF   | page 31   |         |  |
|   | <b>LIGHT HARMONIZER</b>                  | MODE                  AUTO                  OFF                                 | page 31   |         |  |
|   |  | MANUAL  |   |         |  |
|   | <b>ADVANCED MENU</b>                     | <b>GAMMA HIGH</b>   | • Default: 0  | page 31 |  |
|   |  | <b>GAMMA MID</b>  | • Default: 0  |         |  |
|   |  | <b>GAMMA LOW</b>  | • Default: 0  |         |  |
|   |  | <b>CONTRAST R</b>   | • Default: 0  |         |  |
|   |  | <b>CONTRAST G</b>   | • Default: 0  |         |  |
|   |  | <b>CONTRAST B</b>   | • Default: 0  |         |  |
|   |  | <b>BRIGHTNESS R</b>   | • Default: 0  |         |  |
|   |  | <b>BRIGHTNESS G</b>   | • Default: 0  |         |  |
|   |  | <b>BRIGHTNESS B</b>   | • Default: 0  |         |  |
|   |  | <b>COLOUR MANAGEMENT</b>  | PROFILE<br>CURSOR<br>LOG<br>PROFILE SAVE<br>PROFILE DELETE<br>PROFILE NAME CHANGE |         |  |
|   |  | <b>NR</b>   | <u>ON</u> OFF   |         |  |
|   |  | <b>MPEG NR</b>  | <u>ON</u> OFF   |         |  |
|   |  | <b>CINEMA REALITY</b>   | <u>ON</u> OFF   |         |  |
| <b>TV-SYSTEM</b>  |  | <u>AUTO</u>   |   |         |  |
|   |  | SECAM      PAL-N      PAL-M   |   |         |  |
|   |  | PAL                  NTSC 4.43      NTSC  |   |         |  |
| <b>FAVOURITE SAVE</b>   | FAVOURITE1 - 8                           | page 32   |   |         |  |
| <b>FAVOURITE LOAD</b>   | FAVOURITE1 - 8                           | page 32   |   |         |  |
| <b>FAVOURITE EDIT</b>   | FAVOURITE DELETE      MEMORY NAME CHANGE | page 33   |   |         |  |
|   | <b>SIGNAL MODE</b> *1                    | page 33   |   |         |  |

\*1. COMPUTER/COMPONENT/HDMI signals only

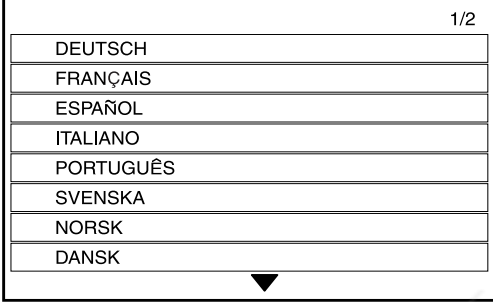

**Discount-Merchant.com (800) 281-8860**  
 THE TRUSTED SOURCE FOR PROJECTOR LAMPS AND ACCESSORIES

| Main menu   | Sub-menu   | Options (Underlined is default setting)  |  |             | Page            |         |
|---|--|--|--|-------------|-----------------|---------|
| <b>POSITION</b><br>          | H-POSITION   | • Default: 0   |  |             | page 34         |         |
|   | V-POSITION   | • Default: 0   |  |             | page 34         |         |
|   | DOT CLOCK*1  | • Default: 0   |  |             | page 34         |         |
|   | CLOCK PHASE*2  | • Default: 0   |  |             | page 34         |         |
|   | ASPECT   | 4:3  | 16:9   | 14:9        | page 34         |         |
|   |  | ZOOM1  | ZOOM2  | V SCROLL    |                 |         |
|   |  | H-FIT  | V-FIT  | JUST        |                 |         |
|   | WSS*3  | <u>ON</u>  | OFF  |             | page 36         |         |
|   | OVER SCAN*4  | • Default: 0   |  |             | page 36         |         |
| KEYSTONE  | • Default: 0   |  |  | page 36     |                 |         |
| AUTO SETUP*5  |  |  |  | page 36     |                 |         |
| <b>LANGUAGE</b><br>          |   |  |  |             |                 |         |
|   |  |  |  |             |                 |         |
| <b>FUNCTION BUTTON</b><br> | <b>BLANK</b><br><b>SLEEP</b><br><b>FAVOURITE LOAD</b><br><b>LIGHT HARMONIZER</b><br><b>AUTO SETUP</b><br><b>HDMI 1 IN</b><br><b>HDMI 2 IN</b><br><b>COMPUTER IN</b><br><b>COMPONENT IN</b> | <b>S-VIDEO IN</b><br><b>VIDEO IN</b><br><b>NORMAL (PICTURE MODE)</b><br><b>DYNAMIC (PICTURE MODE)</b><br><b>CINEMA1 (PICTURE MODE)</b><br><b>CINEMA2 (PICTURE MODE)</b><br><b>VIVID CINEMA (PICTURE MODE)</b><br><b>GAME (PICTURE MODE)</b><br><b>NATURAL (PICTURE MODE)</b> |  |             | page 37         |         |
|   |  |  |  |             |                 |         |
| <b>OPTION</b><br>          | INPUT GUIDE  | <u>DETAILED</u>  | SIMPLE   | OFF         | page 38         |         |
|   | OSD DESIGN   | <u>TYPE1</u>   | TYPE2  | TYPE3       | page 38         |         |
|   | OSD POSITION   | UPPER LEFT   | UPPER CENTRE   | UPPER RIGHT |                 | page 38 |
|   |  | LOWER LEFT   | LOWER CENTRE   | LOWER RIGHT |                 |         |
|   | BACK COLOUR  | <u>BLUE</u>  | BLACK  |             | page 38         |         |
|   | STARTUP LOGO   | <u>ON</u>  | OFF  |             | page 38         |         |
|   | AUTO SEARCH  | <u>ON</u>  | OFF  |             | page 38         |         |
|   | HDMI SIGNAL LEVEL  | <u>NORMAL</u>  | EXPAND   |             | page 38         |         |
|   | INSTALLATION   | <u>FRONT/DESK</u>  | FRONT/CEILING  |             | page 38         |         |
|   |  | REAR/DESK  | REAR/CEILING   |             |                 |         |
|   | SLEEP  | <u>OFF</u>   | 60 MIN.  | 90MIN.      | 120MIN.         | page 39 |
|   |  |  | 150MIN.  | 180MIN.     | 210MIN. 240MIN. |         |
|   | ALTITUDE   | <u>LOW</u>   | HIGH   |             | page 39         |         |
|   | LAMP POWER   | <u>NORMAL</u>  | ECO-MODE   |             | page 39         |         |
| LAMP RUNTIME  |  |  |  | page 39     |                 |         |
| TEST PATTERN  |  |  |  | page 39     |                 |         |

\*1. COMPONENT/COMPUTER signals only

\*2. COMPONENT signals only

\*3. VIDEO/S-VIDEO/COMPONENT signals only.

\*4. Not available with COMPUTER signals

\*5. COMPUTER signals only

# PICTURE menu

## Remote control

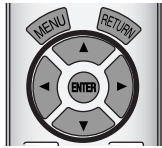

## Control panel

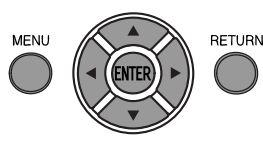

- See "Navigating through the MENU" on page 27.
- See "Main menu and sub-menu" on page 28.

## PICTURE MODE

Depending on the projection environment, you can use these preset parameter settings to optimise image projection. Press ◀ ▶ to cycle through the options.

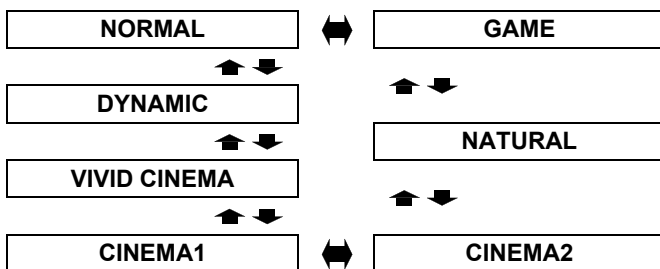

### Recommended for viewing in lit room

|                     |  |
|---------------------|--|
| <b>NORMAL</b>       | Setting for a general image, such as sports. |
| <b>DYNAMIC</b>      | Bright and sharp setting                     |
| <b>VIVID CINEMA</b> | Vivid and crisp colour setting               |
| <b>GAME</b>         | Setting for games                            |

### Recommended for viewing in dark room

|                |  |
|----------------|--|
| <b>CINEMA1</b> | Hollywood style colours                    |
| <b>CINEMA2</b> | Deeper and more rich colour setting        |
| <b>NATURAL</b> | Reproduce the original colour of the image |

### NOTE:

- It may take for a while until the selected mode is stabilised.

### ● Reproducing colour of an sRGB image

For reproducing the original colour of **S-VIDEO** images precisely, set as follows.

1. Press the **PICTURE ADJUST** button and select **NATURAL**.
2. Press the **DEFAULT** button to reset the other sub-menu items.
3. Press the **RETURN** button once to return to the main menu and select **OPTION**.
4. Set the **LAMP POWER** menu to **NORMAL**.

## CONTRAST

You can adjust the contrast of the projected image. Adjust the **BRIGHTNESS** in advance if necessary.

Lower



Higher

- Setting range: -32 to +32

## BRIGHTNESS

You can adjust the brightness of the projected image.

Darker



Brighter

- Setting range: -32 to +32

## COLOUR

You can adjust the colour saturation of the projected image.

Lighter



Darker

- Setting range: -32 to +32
- When **COMPUTER** signal is connected, only available with the following signals.  
1 125 (1 080)/60i      1 125 (1 080)/50i  
1 125 (1 080)/60p      1 125 (1 080)/50p

## TINT

You can adjust the skin tone in the projected image.

More reddish



More greenish

- Setting range: -32 to +32
- When **COMPUTER** signal is connected, only available with the following signals.  
1 125 (1 080)/60i      1 125 (1 080)/50i  
1 125 (1 080)/60p      1 125 (1 080)/50p

## SHARPNESS

You can adjust the sharpness of the projected image.

Less sharp



More sharp

- Setting range will vary according to the selected input signal.

## COLOUR TEMPERATURE

You can adjust the white balance of the projected image.



- Setting range: -6 to +6

## DYNAMIC IRIS

You can switch automatic adjustment system of the lamp and the lens iris, which control the contrast and black level, on/off.

- **ON:** Automatic adjustment
- **OFF:** No adjustment

## LIGHT HARMONIZER

The luminance sensor detects the brightness of the room and keeps the luminance in balance automatically. If needed, you can switch this function on/off from **MODE**, or adjust it manually from **MANUAL** by pressing ◀ ▶.

- Setting range: -8 to +8

### NOTE:

- To assure correct performance of the **LIGHT HARMONIZER**, do not interrupt the light on to the luminance sensor. See "Projector body" on page 12.

## ADVANCED MENU

You can perform more detailed image adjustment manually.

### GAMMA

You can adjust linear intensity at 3 levels. Press ◀ ▶ to increase/decrease 1 point.

| Levels     | Default setting |
|------------|-----------------|
| GAMMA HIGH | 0               |
| GAMMA MID  | 0               |
| GAMMA LOW  | 0               |

- Setting range: -8 to +8

### CONTRAST

You can adjust the amount of contrast in RGB colours individually. Press ◀ ▶ to increase/decrease 1 point.

| RGB        | Default setting |
|------------|-----------------|
| CONTRAST R | 0               |
| CONTRAST G | 0               |
| CONTRAST B | 0               |

- Setting range: -16 to +16

### BRIGHTNESS

You can adjust the brightness in RGB colours individually. Press ◀ ▶ to increase/decrease 1 point.

| RGB          | Default setting |
|--------------|-----------------|
| BRIGHTNESS R | 0               |
| BRIGHTNESS G | 0               |
| BRIGHTNESS B | 0               |

- Setting range: -16 to +16

### COLOUR MANAGEMENT

You can manage your own defined colour settings. See "Setting your own colour profile" on page 24.

### NR (Noise Reduction)

You can switch the automatic noise reduction system on/off. Press ◀ ▶ to select the required setting.

- **ON:** Automatic noise reduction
- **OFF:** No noise reduction

### MPEG NR

You can switch the automatic noise reduction system for MPEG format images on/off. The system minimise block noise and mosquito noise to eliminate jagged edges, providing an overall smoother image. Press ◀ ▶ to select the required setting.

- **ON:** Active
- **OFF:** Deactive

### NOTE:

- **MPEG NR** system is not available with **COMPUTER/HDMI (VGA480)** signals.

### CINEMA REALITY

You can switch the automatic image synchroniser on/off for 24 frames a second images, such as movies. Press ◀ ▶ to select the required setting.

- **ON:** Active
- **OFF:** Deactive

### NOTE:

- **CINEMA REALITY** is effective only with interlace signals.



## PICTURE menu

### TV-SYSTEM

When the video signal is changed, the setting switches automatically.

You can switch the setting manually to match the video data. Press ◀ ▶ to cycle through the options.

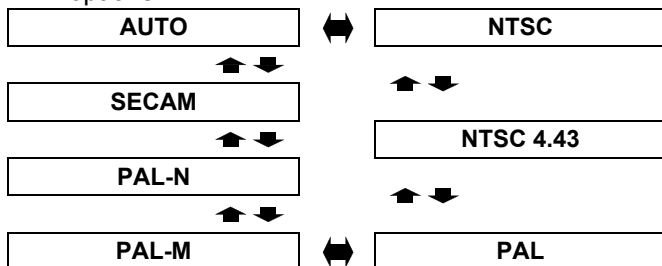

#### NOTE:

- AUTO setting will select from NTSC/NTSC 4.43/PAL/PAL60/PAL-M/PAL-N/SECAM.

### FAVOURITE SAVE

You can save and name the adjusted **PICTURE** menu settings for instant access from **FAVOURITE LOAD** menu.

1. Adjust the items in **PICTURE** menu.
2. Select **FAVOURITE SAVE** and press the **ENTER** button.
3. Select the required memory setting and press the **ENTER** button.
  - The confirmation screen will be displayed. Select **OK** and press the **ENTER** button.
  - Indicated with ★ is in use, and ☆ is empty.
4. Use ▲ ▼ ◀ ▶ to specify the location of the required character to enter and press the **ENTER** button.
  - You can enter up to 16 characters.

The screenshot shows a screen titled "FAVOURITE NAME CHANGE". At the top is a text input field. Below it is a grid of characters for selection, organized into rows: uppercase letters A-M, uppercase letters N-Z, lowercase letters a-m, lowercase letters n-z, digits 0-9 and SPACE, and various symbols including !, ", #, \$, %, &, ', \*, +, -, /, =, ?, @, \, ^, \_, ` | ~ ( ) < > [ ] { } , . : ;. To the right of the grid is an "ALL DELETE" button. At the bottom are "OK" and "CANCEL" buttons.

5. Repeat step 4 until you finish the text line.
  - Move the cursor to **DEL ALL** and press the **ENTER** button to delete all the entered text line.
  - Press the **DEFAULT** button to delete the last entered character or indicated with cursor in the text box.
  - To insert a character in the entered text line, move the cursor to the text box to select the required place and press ▼ then perform step 4.
6. Select **OK** and press the **ENTER** button to set the entered text as a name.

#### NOTE:

- If you leave the text box empty and save, the default memory number will stay as a name.

### FAVOURITE LOAD

You can access the saved settings instantly. See "Switching the preset settings" on page 22.

1. Select a setting from **FAVOURITE1 - 8**.
  - Undefined settings will not be selectable.
2. Press **ENTER** to activate.

#### NOTE:

- If you have not saved any settings, **FAVOURITE1 - 8** will not be displayed.

## FAVOURITE EDIT

You can edit the named memory settings.

### ● Deleting a memory setting

1. Select **FAVOURITE DELETE** and press the **ENTER** button.
2. Select the required memory setting and press the **ENTER** button.
  - If you select **ALL DELETE**, you can delete all of the saved memory settings.
3. Select **OK** in the confirmation screen and press the **ENTER** button.

### ● Changing the name of the memory setting

1. Select the required memory setting and press the **ENTER** button.
2. Use **▲ ▼ ◀ ▶** to specify the location of the required character to enter and press the **ENTER** button.
  - You can enter up to 16 characters.

FAVOURITE NAME CHANGE

|   |   |   |    |   |   |   |   |   |   |       |   |   |            |   |   |  |
|---|---|---|----|---|---|---|---|---|---|-------|---|---|------------|---|---|--|
| A | B | C | D  | E | F | G | H | I | J | K     | L | M | ALL DELETE |   |   |  |
| N | O | P | Q  | R | S | T | U | V | W | X     | Y | Z |            |   |   |  |
| a | b | c | d  | e | f | g | h | i | j | k     | l | m |            |   |   |  |
| n | o | p | q  | r | s | t | u | v | w | x     | y | z |            |   |   |  |
| 0 | 1 | 2 | 3  | 4 | 5 | 6 | 7 | 8 | 9 | SPACE |   |   |            |   |   |  |
| ! | " | # | \$ | % | & | ' | * | + | - | /     | = | ? | @          | \ | ^ |  |
| _ | ` |   | ~  | ( | ) | < | > | [ | ] | {     | } | , | .          | : | ; |  |

OK
CANCEL

3. Repeat step 4 until you finish the text line.
  - Move the cursor to **DEL ALL** and press the **ENTER** button to delete all the entered text line.
  - Press the **DEFAULT** button to delete the last entered character or indicated with cursor in the text box.
  - To insert a character in the entered text line, move the cursor to the text box to select the required place and press **▼** then perform step 4.
4. Select **OK** and press the **ENTER** button to set the entered text as a name.

**NOTE:**

- If you have not saved any settings, **FAVOURITE1 - 16** will not be displayed.

## SIGNAL MODE

The current selected signal will be displayed. This is available with signals from **COMPUTER IN/COMPONENT IN/HDMI IN** only.

**NOTE:**

- See "List of compatible signals" on page 45.

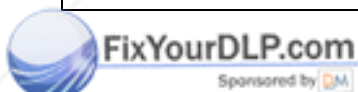

**Discount-Merchant.com (800) 281-8860**  
**THE TRUSTED SOURCE FOR PROJECTOR LAMPS AND ACCESSORIES**

# POSITION menu

**Remote control**

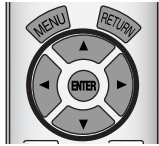

**Control panel**

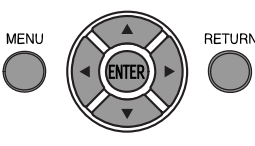

- See "Navigating through the MENU" on page 27.
- See "Main menu and sub-menu" on page 28.

## H-POSITION

You can move the projected image horizontally for fine adjustment.



## V-POSITION

You can move the projected image vertically for fine adjustment.



## DOT CLOCK

If you have interference patterns of the projected image, which is sometimes referred to as moire or noise, you can minimize it by pressing ◀ ▶ to adjust the clock frequency. (Available with signals from **COMPUTER IN** only)

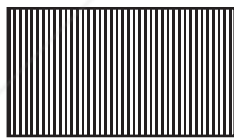

**NOTE:**

- If the projecting signal's dot clock frequency is higher than 150 MHz, the adjustment may not make a difference.
- **DOT CLOCK** needs to be adjusted before adjusting the

## CLOCK PHASE

If you require further adjustment for the same reason as the **DOT CLOCK** adjustment, you can fine adjust the timing of the clock. Press ◀ ▶ to adjust. (Available with signals from **COMPUTER IN/COMPONENT IN** only)

**NOTE:**

- If the projecting signal's dot clock frequency is higher than 150 MHz, the adjustment may not make a difference.
- Available signals from **COMPONENT IN**:  
1 125 (1 080)/60i, 1 125 (1 080)/50i, 1 125 (1 080)/60p,  
1 125 (1 080)/50p, 1 125 (1 080)/24p, 750 (720)/60p,  
750 (720)/50p

## ASPECT

You can switch the aspect ratio manually when needed.

### Aspect ratio depend on signals

Press ◀ ▶ to cycle through the aspect ratio options. The cycle pattern depends on the connected signals.

|                              |   |
|------------------------------|---|
| <b>VIDEO/<br/>S-VIDEO</b>    | <ul style="list-style-type: none"> <li>● 4:3 → 16:9 → 14:9 → ZOOM1 → ZOOM2 → JUST</li> <li>● AUTO → 4:3 → 16:9 → JUST → ZOOM<br/>NTSC signal</li> </ul>   |
| <b>COMPUTER<br/>(RGB)</b>    | <ul style="list-style-type: none"> <li>● 4:3 → 16:9 → V SCROLL</li> <li>● 4:3 → 16:9<br/>VGA or SVGA signals</li> <li>● Not switchable<br/>WIDE480/600/720/768/768-2/800/<br/>900 signals</li> </ul>  |
| <b>HDMI</b>                  | <ul style="list-style-type: none"> <li>● 4:3 → 16:9</li> <li>● 16:9 → H - FIT → V - FIT → ZOOM<br/>1 125 (1 080)/50i, 1 125 (1 080)/60i,<br/>1 125 (1 080)/50p, 1 125 (1 080)/60p,<br/>1 125 (1 080)/24p, 750 (720)/50p and<br/>750 (720)/60p signals</li> <li>● 4:3 → 16:9 → JUST → ZOOM<br/>525p (480p) and 625p (576p) signals</li> </ul>  |
| <b>COMPONENT<br/>(YPBPR)</b> | <ul style="list-style-type: none"> <li>● 4:3 → 16:9 → 14:9 → JUST → ZOOM1 → ZOOM2<br/>625i (576i), 625p (576p)</li> <li>● AUTO → 4:3 → 16:9 → JUST → ZOOM<br/>525i (480i), 525p (480p)</li> <li>● 16:9 → H - FIT → V - FIT<br/>1 125 (1 080)/50i, 1 125 (1 080)/60i,<br/>1 125 (1 080)/50p, 1 125 (1 080)/60p,<br/>1 125 (1 080)/24p, 750 (720)/50p,<br/>750 (720)/60p signals</li> </ul> |

**Aspect ratio options and projection example**

If you apply the aspect ratio options to the projected image, the result will be as follows. The result may differ due to the input signals. See “Switching the aspect ratio” on page 23.

**VIDEO/S-VIDEO/COMPONENT**

Not available with 1 125 (1 080)/50i, 1 125 (1 080)/60i, 1 125 (1 080)/50p, 1 125 (1 080)/60p, 1 125 (1 080)/24p, 750 (720)/50p and 750 (720)/60p signals.

| Original size |  | 4:3 | Squeeze signal | 16:9 Letter box | 14:9 Letter Box | 2.35:1 Cinescope |
|---------------|--|-----|----------------|-----------------|-----------------|------------------|
| 4:3           | Projects at 4:3.   |     |                |                 |                 |                  |
| 16:9          | Adjusts horizontally to 16:9.  |     |                |                 |                 |                  |
| JUST          | Adjusts horizontally to fit 16:9. Closer to edge, more enlarged. Not available with <b>COMPUTER</b> signals. |     |                |                 |                 |                  |
| ZOOM/ ZOOM1   | Adjusts to 16:9 size with preserving original ratio. Escape the menu mode and press ▲▼ to adjust vertically. |     |                |                 |                 |                  |
| ZOOM2         | Adjusts to cinescope size not including letter box. Escape the menu mode and press ▲▼ to adjust vertically.  |     |                |                 |                 |                  |
| 14:9          | Adjusts to 14:9.   |     |                |                 |                 |                  |

**COMPONENT signals**

Available with 1 125 (1 080)/50i, 1 125 (1 080)/60i, 1 125 (1 080)/50p, 1 125 (1 080)/60p, 1 125 (1 080)/24p, 750 (720)/50p and 750 (720)/60p signals

| Original Size |   | 4:3 | 16:9 | Cinescope |
|---------------|---|-----|------|-----------|
| H - FIT       | Adjusts horizontally to 16:9.   |     |      |           |
| V - FIT       | Adjusts to 16:9 vertically. Escape and press ▲ ▼ to scroll the image to adjust the edge vertically. |     |      |           |

**COMPUTER signals**

Escape and press ▲ ▼ to scroll the image of **COMPUTER** signals to adjust the edge vertically.

**Discount-Merchant.com (800) 281-8860**
  
**THE TRUSTED SOURCE FOR PROJECTOR LAMPS AND ACCESSORIES**

Settings

## POSITION menu

### WSS

**WSS** (Wide Screen Signalling) detects if a **PAL/625p (576p)/625i (576i)** signal is input and that signal has an identification signal, and switch the aspect ratio to required setting automatically. You can switch the system off manually.

### OVER SCAN





If the 4 edges of an image is partly dropped, you can use this function to adjust and project it properly.

- Setting range: 0 to +10
- **OVER SCAN** is not available with **COMPUTER** signals.



### KEYSTONE

If the projector is aligned non-perpendicularly to the screen, or if the projection screen has an angled surface, you can vertically correct keystone.

| Image  | Operation   |
|--|---|
|  |  |
|  |  |

- Setting range: -32 to 32

#### NOTE:

- You can correct the distortion  $\pm 30$  degrees from the vertical plane. For a better quality image, installing the projector with a minimum of distortion is recommended.
- Some distortion may be retained for the lens shift adjustment.
- The distortion of the main menu screen is not correctable.
- The result of the keystone correction will affect the aspect ratio and the size of the image.

### AUTO SETUP

You can adjust **V - POSITION**, **H - POSITION**, **DOT CLOCK** and **CLOCK PHASE** automatically when connecting via **COMPUTER IN**. Press **ENTER** to adjust these at the same time.

# FUNCTION BUTTON

**Remote control**

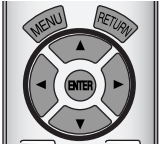

**Control panel**

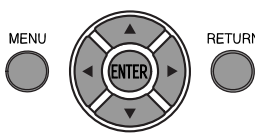

- See “Navigating through the MENU” on page 27.
- See “Main menu and sub-menu” on page 28.

## FUNCTION BUTTON

You can assign a frequently used menu option to the **FUNCTION** button for shortcut. Press ◀ ▶ to select the required menu option and press the **ENTER** button.

|                         |         |
|-------------------------|---------|
| <b>BLANK</b>            | page 37 |
| <b>SLEEP</b>            | page 39 |
| <b>FAVOURITE LOAD</b>   | page 32 |
| <b>LIGHT HARMONIZER</b> | page 31 |
| <b>AUTO SETUP</b>       | page 36 |
| <b>HDMI 1 IN</b>        | page 26 |
| <b>HDMI 2 IN</b>        |         |
| <b>COMPUTER IN</b>      |         |
| <b>COMPONENT IN</b>     |         |

|                     |         |
|---------------------|---------|
| <b>S-VIDEO IN</b>   | page 26 |
| <b>VIDEO IN</b>     | page 30 |
| <b>NORMAL</b>       |         |
| <b>DYNAMIC</b>      |         |
| <b>CINEMA1</b>      |         |
| <b>CINEMA2</b>      |         |
| <b>VIVID CINEMA</b> |         |
| <b>GAME</b>         |         |
| <b>NATURAL</b>      |         |

### ● **BLANK function**

You can stop the projection temporary for electrical power save. To escape from the blank mode, press any button except the **LIGHT** button.

# OPTION menu

## Remote control



## Control panel



- See "Navigating through the MENU" on page 27.
- See "Main menu and sub-menu" on page 28.

## INPUT GUIDE

When you change the input method, the guidance appears in the upper right corner of the screen. The following display methods are available. Press ◀ ▶ to cycle through the options.

| Options  | Function  |
|----------|---|
| OFF      | Turn off the guidance.  |
| SIMPLE   | Display the input method by text. The <b>INPUT GUIDE</b> will go out after 5 seconds without any operation.     |
| DETAILED | Display the input method by graphic. The <b>INPUT GUIDE</b> will go out after 10 seconds without any operation. |

## OSD DESIGN

You can change the background colour of the menu. Press ◀ ▶ to cycle through the option.

- **TYPE1** Semi transparent black
- **TYPE2** Solid blue
- **TYPE3** Semi transparent dark blue

## OSD POSITION

You can change the position where to display the menu. Press ◀ ▶ to cycle through the options.

|            |              |             |
|------------|--------------|-------------|
| UPPER LEFT | UPPER CENTRE | UPPER RIGHT |
|            | CENTRE       |             |
| LOWER LEFT | LOWER CENTRE | LOWER RIGHT |

## BACK COLOUR

You can choose a screen colour from **BLUE** or **BLACK** for when the projector is idle. Press ◀ ▶ to select.

## STARTUP LOGO

You can switch the logo on/off that is displayed when starting up the projector. Press ◀ ▶ to select the required option. **STARTUP LOGO** will be displayed for 30 seconds.

- **ON** Active
- **OFF** Deactive

## AUTO SEARCH

When the projector is turned on, the input terminals are detected and an input signal is selected automatically. You can switch the system on/off. Press ◀ ▶ to cycle through the options.

- **ON** Active
- **OFF** Deactive

### NOTE:

- When no signal is detected, the last used input will be selected.

## HDMI SIGNAL LEVEL

When an **HDMI** is not projected normally, you can switch the **HDMI** signal level to **NORMAL** or **EXPAND**. Press ◀ ▶ to select an option.

- **NORMAL** General **HDMI** signal level
- **EXPAND** Expanded **HDMI** signal level

### NOTE:

- **HDMI SIGNAL LEVEL** is not available with some equipment.

## INSTALLATION

When installing the projector, select the projection method according to the projector position. Press ◀ ▶ to cycle through the options. See "Projection method" on page 15.

|                      |   |
|----------------------|---|
| <b>FRONT/DESK</b>    | Setting on a desk/floor and projecting from front |
| <b>FRONT/CEILING</b> | Mounting in the ceiling and projecting from front |
| <b>REAR/DESK</b>     | Setting on a desk/floor and projecting from rear  |
| <b>REAR/CEILING</b>  | Mounting in the ceiling and projecting from rear  |

## SLEEP

You can select the required duration of time and set the off timer to turn off the power of the projector automatically. 3 minutes before turn-off, the countdown of minutes will be displayed in the lower right corner. Press ◀ ▶ to cycle through the options.

|         |   |         |
|---------|---|---------|
| OFF     | ◀ | 240MIN. |
| ↓       |   | ↑       |
| 60MIN.  |   | 210MIN. |
| ↓       |   | ↑       |
| 90MIN.  |   | 180MIN. |
| ↓       |   | ↑       |
| 120MIN. | ▶ | 150MIN. |

## ALTITUDE

If you use the projector at high elevation, the **ALTITUDE** setting need to be **HIGH** to set the fan speed high. Press ◀ ▶ to select the required option.

- **LOW**            The fan speed is low.
- **HIGH**            The fan speed is high.

### NOTE:

- At 1 400 m (4 593 ft) above sea level, the setting must be **HIGH**.
- The loudness of fan noise depends on the **ALTITUDE** setting.

## LAMP POWER

You can adjust the power of the lamp to save electricity, prolong the lamp life and reduce the noise.

| Options         | Function                            |
|-----------------|-------------------------------------|
| <b>NORMAL</b>   | When higher luminance is required.  |
| <b>ECO-MODE</b> | When lower luminance is sufficient. |

### NOTE:

- When no input signal is detected, the function is disabled.

## LAMP RUNTIME

You can check how long time the lamp has been used.

### NOTE:

- **LAMP RUNTIME** is a relevant matter for lamp replacement timing. See "Replacing the lamp unit" on page 42.

## TEST PATTERN

You can use the 2 different test patterns to adjust the focus of the image.

1. Press the **ENTER** button to display the test pattern 1 and adjust the focus with the focus ring.

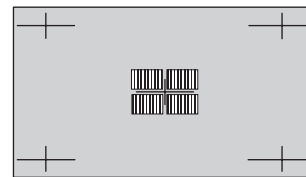

2. Press the **ENTER** button to display the test pattern 2 and adjust the focus with the focus ring again.

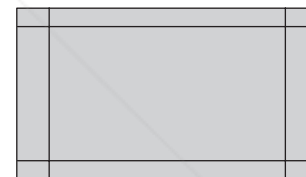

3. Press the **MENU** or **RETURN** to return to the previous menu, or press repeatedly to return to the screen.

### NOTE:

- When the projector and/or the screen is tilted, adjust the focus at the centre of the image. The upper and lower edge might be out of focus.
- When the image is distorted in keystone, adjust the **KEYSTONE** in the **POSITION** menu.



# TEMP and LAMP Indicators

## Managing the indicated problems

If a problem should occur with the projector, the **LAMP** and/or **TEMP** indicators will inform you. Manage the indicated problems as follow.

1. Confirm the status of all indicators and projector, and switch off the projector in proper way.
2. Find out the cause of the problem by status of the **LAMP** and/or **TEMP** indicators.
3. Follow the following instruction for each indication and solve the problem.
4. Turn on the projector in the correct way and confirm the indicator is not indicating a problem any longer.

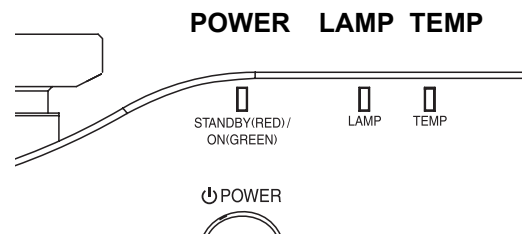

### NOTE:

- If no problem is found or the problem remains, do not turn on the projector. Instead contact an Authorised Service Centre.

### LAMP indicator

| Indicator | ● Illuminating red  | ● Flashing red  |
|-----------|---|---|
| Problem   | <b>LAMP RUNTIME</b> has reached 1 800 hours.              | The lamp circuit failure, abnormal function or lamp unit is damaged.              |
| Cause     | The lamp unit will run out soon and needs to be replaced. | The <b>MAIN POWER</b> is switched on again before the lamp unit is cooled enough. |
| Remedy    | See "Replacing the lamp unit" on page 42.                 | Let the lamp unit cool down and turn on the <b>MAIN POWER</b> .                   |

### TEMP indicator

| Indicator | ● Illuminating red and still projecting   | ● Flashing red and the <b>POWER</b> button is turned off              |
|-----------|---|---|
| Problem   | The temperature inside and/or outside the projector is abnormally high.           |   |
| Cause     | The ventilation openings are covered.   | The room temperature is too high.                                     |
| Remedy    | Remove the object(s) from the ventilation openings or clear around the projector. | Reinstall the projector in temperature controlled place. See page 48. |

# Care and Replacement

## Cleaning the projector

### Before cleaning the projector

- Switch off the **MAIN POWER** switch in proper way and disconnect the mains plug from the mains socket.
- Unplug all the cables from the projector.

### Cleaning the outer surface of the projector

Wipe off dirt and dust gently with a soft cloth.

- If it is difficult to remove the dirt, soak a cloth in a neutral detergent diluted with water, wring the cloth well and then wipe the projector. Dry off the projector with dry cloth.
- If you use a chemical treated wipe, follow the instructions supplied with it.

### Cleaning the lens surface

Wipe off dirt and dust gently with a lint-free cloth.

- Make sure no dirt or dust remains on the surface of the lens. It will be enlarged and projected onto a screen.

### Cleaning the air filter

If the air filter is excessively dirty, the internal temperature of the projector increases and may cause malfunction. Clean the air filter regularly every 100 hours of usage.

1. Turn the projector upside down and place it gently on a soft cloth.
2. Press the tab and slightly slide up the air filter to remove.

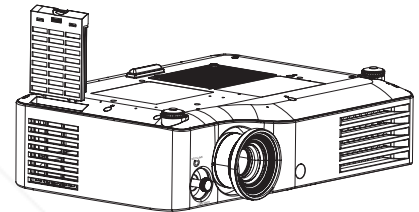

3. Vacuum dirt and dust from the air filter.
  - Do not wash the air filter.

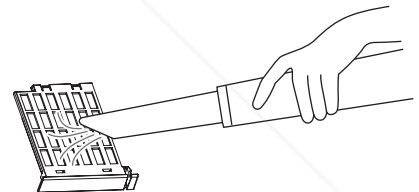

4. Place and slightly slide in the air filter in the air intake port to attach.
  - Make sure the air filter clicks into the place.

#### NOTE:

- Do not use the projector without attaching the air filter.

### Replacing the air filter

The air filter should be replaced when cleaning is ineffective and when replacing the lamp unit. A replacement air filter is provided with a replacement lamp unit, ET-LAX100. Contact an Authorised Service Centre for the optional air filter.

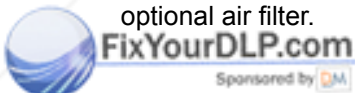

**Discount-Merchant.com (800) 281-8860**  
THE TRUSTED SOURCE FOR PROJECTOR LAMPS AND ACCESSORIES

## Care and Replacement

### Replacing the lamp unit

#### Before replacing the lamp unit



- Switch off the **MAIN POWER** button in proper way and disconnect the mains plug from the mains socket.
- Make sure the lamp unit and the surroundings are cooled enough.
- Unplug all the cables from the projector.
- Prepare a Phillips-head screwdriver.
- Contact an Authorised Service Centre to purchase a replacement lamp unit (ET-LAX100).
- When the projector is mounted in the ceiling, do not work directly under the projector or put your face closer to the projector.

#### NOTE:

- Prior to replacing the lamp unit, allow it to cool down to prevent the risk of burns, damage and other hazards.
- Do not attempt replacement with an unauthorised lamp unit.

#### When to replace the lamp unit

The lamp unit is consumable and the brightness decreases by duration of usage. The **LAMP** indicator will inform you of the replacement timing at 1 800 hours, and at 2 000 hours, the projector will be turned off. Those figures are rough guidance and might be shortened by the usage conditions, characteristics of the lamp unit, environmental conditions, and so on. You can check the duration of usage time using **LAMP RUNTIME** in the **OPTION** menu.

| Indication       | On screen  | LAMP indicator   |
|------------------|--|--|
| Over 1 800 hours |  <p>“REPLACE LAMP” is displayed on the upper left of the screen for 30 seconds.<br/>To clear the screen immediately, press any button.</p> |  <p>Illuminates red.</p> |
| Over 2 000 hours | <p>“REPLACE LAMP” is displayed on the upper left of the screen, and it will stay until you respond.<br/>To clear the screen, press any button.</p>   |  |

#### NOTE:

- The guide times, 1 800 and 2 000 hours, are rough estimates based on certain conditions and is not a guaranteed time. The estimated condition is: **LAMP POWER** in **OPTION** menu set to **NORMAL**.
- To prolong the lamp life, set the **LAMP POWER** in **OPTION** menu to **ECO-MODE**. See “LAMP POWER” on page 39.
- For more information about the lamp unit, such as guaranteed time, see the instructions which is provided with the lamp unit.

## Removing and replacing the lamp unit

1. Turn the projector upside down and place it gently on a soft cloth.
2. Use a Phillips screw driver to loosen the 2 lamp unit fixing screws until the screws turn freely and remove the lamp unit cover.
3. Use a Phillips screw driver to loosen the 2 lamp unit fixing screws until the screws turn freely.
4. Hold the handle of the lamp unit and pull out gently from the projector.
5. Replace the new lamp unit while making sure that the direction of insertion is correct.
  - Press the top of the lamp unit and make sure the unit is installed securely.
6. Tighten the lamp unit fixing screws securely with a Phillips screwdriver.
7. Attach the lamp unit cover and tighten the 3 lamp unit cover fixing screws securely with a Phillips screw driver.

Lamp unit cover fixing screws

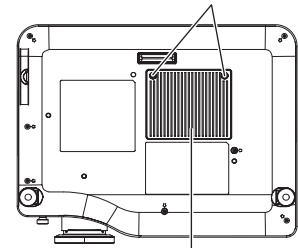

Lamp unit cover

Lamp unit fixing screws

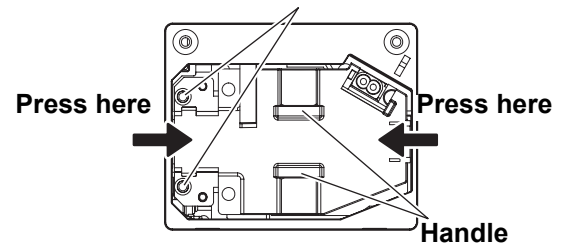

### NOTE:

- Be sure to install the lamp unit and attach the lamp unit cover securely. If they are not installed securely, it may cause the protection circuit to operate so that the power cannot be turned on.
- Grip the handle and keep the lamp unit paralleled when you remove the lamp unit. Some parts of the lamp unit are sharpened and may cause injury.
- Do not switch the power on while the lamp unit cover removed.

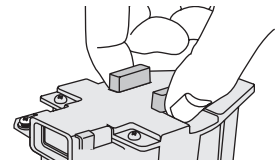

## Resetting the LAMP RUNTIME

If the lamp usage time has passed 2 000 hours (when **LAMP POWER** has been set to **NORMAL**), the projector will switch to standby mode after approximately 10 minutes of operation. The resetting procedure should thus be completed within 10 minutes.

1. Connect the mains lead to the projector and a mains socket, and switch the **MAIN POWER** on.
2. Press the **POWER** button.
3. Press the **MENU** button to display the menu.
4. Select the **OPTION** menu and press the **ENTER** button.
5. Select **LAMP RUNTIME**.
6. Press and hold the **ENTER** button for approximately 3 seconds.
7. The confirmation screen will be displayed and select **OK**.
8. Press the **POWER** button to turn off for resetting the duration of the **LAMP RUNTIME**.
9. Confirm the duration of time in **LAMP RUNTIME** is reset to "0 H".

|              |        |
|--------------|--------|
| ALTITUDE     | LOW    |
| LAMP POWER   | NORMAL |
| LAMP RUNTIME | 1820H  |

# Troubleshooting

Should any problem persist, contact your dealer.

| Problem                                  | Cause  | Reference page                                     |
|--|--|--|
| Power does not turn on.                  | <ul style="list-style-type: none"> <li>● The mains lead may not be connected.</li> <li>● The <b>MAIN POWER</b> switch is turned off.</li> <li>● No electric supply is at the mains socket.</li> <li>● <b>TEMP</b> indicator is lit or flashes.</li> <li>● <b>LAMP</b> indicator is lit or flashes.</li> <li>● The lamp unit cover has not been securely installed.</li> <li>● The circuit breakers have tripped.</li> </ul>                            | <p>19<br/>20<br/>19<br/>40<br/>40<br/>42<br/>-</p> |
| No picture appears.                      | <ul style="list-style-type: none"> <li>● The video signal input source may not be connected to a terminal properly.</li> <li>● The input selection setting may not be correct.</li> <li>● The <b>BRIGHTNESS</b> adjustment setting may be at the minimum setting.</li> <li>● The <b>BLANK</b> function may be in use.</li> <li>● The lens cover may still be attached to the lens.</li> </ul>  | <p>18<br/><br/>26<br/>30<br/>37<br/>12</p>         |
| The picture is fuzzy.                    | <ul style="list-style-type: none"> <li>● The lens focus may not have been set correctly.</li> <li>● The projector may not be at the correct distance from the screen.</li> <li>● The lens may be dirty.</li> <li>● The projector may be tilted too much.</li> </ul>  | <p>21<br/>14<br/>9<br/>16</p>                      |
| The colour is pale or greyish.           | <ul style="list-style-type: none"> <li>● <b>COLOUR</b> or <b>TINT</b> adjustment may be incorrect.</li> <li>● The input source which is connected to the projector may not be adjusted correctly.</li> </ul>   | <p>30<br/>28</p>                                   |
| The Remote control does not operate.     | <ul style="list-style-type: none"> <li>● The batteries may be weak.</li> <li>● The batteries may not have been inserted correctly.</li> <li>● The remote control signal receptor on the projector may be obstructed.</li> <li>● The remote control unit may be out of the operation range.</li> </ul>  | <p>-<br/>11<br/>22<br/>22</p>                      |
| The picture does not display correctly.  | <ul style="list-style-type: none"> <li>● The signal format (<b>TV-SYSTEM</b>) may not have been set correctly.</li> <li>● There may be a problem with the VCR or other signal source.</li> <li>● A signal which is not compatible with the projector is being input.</li> </ul>  | <p>32<br/>-<br/>45</p>                             |
| Picture from a computer does not appear. | <ul style="list-style-type: none"> <li>● The cable may be longer than the optional cable.</li> <li>● The external video output from a laptop computer may not be correct. (You may be able to change the external output settings by pressing the [Fn] + [F3] or [Fn] + [F10] keys simultaneously. The actual method varies depending on the type of computer; refer to the documentation provided with your computer for further details.)</li> </ul> | <p>-<br/>46</p>                                    |

# Technical Information

## List of compatible signals

| Signal                         | Display mode | Display resolution (dots) *1 | Scanning frequency |        | Dot clock frequency (MHz) | Picture quality *2 | Terminals                   |
|--------------------------------|--------------|------------------------------|--------------------|--------|---------------------------|--------------------|-----------------------------|
|                                |              |                              | H (kHz)            | V (Hz) |                           |                    |                             |
| NTSC/NTSC 4.43/<br>PAL-M/PAL60 | -            | 720 x 480i                   | 15.7               | 59.9   | -                         | A                  | VIDEO/S-VIDEO               |
| PAL/PAL-N/SECAM                | -            | 720 x 576i                   | 15.6               | 50.0   | -                         | A                  |                             |
| 525i (480i)                    | 525i         | 720 x 480i                   | 15.7               | 59.9   | 13.5                      | A                  | COMPONENT                   |
| 625i (576i)                    | 625i         | 720 x 576i                   | 15.6               | 50.0   | 13.5                      | A                  |                             |
| 525p (480p)                    | 525p         | 720 x 483                    | 31.5               | 59.9   | 27.0                      | A                  | COMPONENT/HDMI              |
| 625p (576p)                    | 625p         | 720 x 576                    | 31.3               | 50.0   | 27.0                      | A                  |                             |
| 1 125 (1 080)/60i              | 1 125/60i    | 1 920 x 1 080i               | 33.8               | 60.0   | 74.3                      | AA                 | COMPONENT/<br>HDMI/COMPUTER |
| 1 125 (1 080)/50i              | 1 125/50i    | 1 920 x 1 080i               | 28.1               | 50.0   | 74.3                      | AA                 |                             |
| 1 125 (1 080)/24p              | 1 125/24p    | 1 920 x 1 080                | 27.0               | 24.0   | 74.3                      | AA                 | COMPONENT/HDMI              |
| 1 125 (1 080)/60p              | 1 125/60p    | 1 920 x 1 080                | 67.5               | 60.0   | 148.5                     | AA                 |                             |
| 1 125 (1 080)/50p              | 1 125/50p    | 1 920 x 1 080                | 56.3               | 50.0   | 148.5                     | AA                 | COMPONENT/<br>HDMI/COMPUTER |
| 750 (720)/60p                  | 750/60p      | 1 280 x 720                  | 45.0               | 60.0   | 74.3                      | AA                 |                             |
| 750 (720)/50p                  | 750/50p      | 1 280 x 720                  | 37.5               | 50.0   | 74.3                      | AA                 | COMPONENT/HDMI              |
| VGA480                         | VGA60        | 640 x 480                    | 31.5               | 59.9   | 25.2                      | A                  |                             |
|                                | VGA75        | 640 x 480                    | 37.5               | 75.0   | 31.5                      | A                  | COMPUTER                    |
|                                | VGA85        | 640 x 480                    | 43.3               | 85.0   | 36.0                      | A                  |                             |
|                                | VGA138       | 640 x 480                    | 72.1               | 138.0  | 62.3                      | A                  |                             |
| WIDE480                        | WIDE480      | 856 x 480                    | 30.1               | 60.1   | 31.5                      | A                  |                             |
| SVGA                           | SVGA55       | 800 x 600                    | 35.2               | 56.3   | 36.0                      | A                  |                             |
|                                | SVGA60       | 800 x 600                    | 37.9               | 60.3   | 40.0                      | A                  |                             |
|                                | SVGA70       | 800 x 600                    | 48.1               | 72.2   | 50.0                      | A                  |                             |
|                                | SVGA75       | 800 x 600                    | 46.9               | 75.0   | 49.5                      | A                  |                             |
|                                | SVGA85       | 800 x 600                    | 53.7               | 85.1   | 56.3                      | A                  |                             |
| WIDE600                        | WIDE600      | 1 072 x 600                  | 37.2               | 59.9   | 51.4                      | A                  |                             |
| WIDE720                        | WIDE720      | 1 280 x 720                  | 45.1               | 60.1   | 76.5                      | AA                 |                             |
| XGA                            | XGA60        | 1 024 x 768                  | 48.4               | 60.0   | 65.0                      | A                  |                             |
|                                | XGA70        | 1 024 x 768                  | 56.5               | 70.1   | 75.0                      | A                  |                             |
|                                | XGA75        | 1 024 x 768                  | 60.0               | 75.0   | 78.8                      | A                  |                             |
|                                | XGA85        | 1 024 x 768                  | 68.7               | 85.0   | 94.5                      | A                  |                             |
|                                | XGA89        | 1 024 x 768                  | 72.1               | 89.0   | 99.2                      | A                  |                             |
| WIDE768                        | WIDE768      | 1 280 x 768                  | 45.3               | 56.5   | 76.2                      | A                  |                             |
| MXGA                           | MXGA70       | 1 152 x 864                  | 64.0               | 71.2   | 94.2                      | A                  |                             |
|                                | MXGA75       | 1 152 x 864                  | 67.5               | 74.9   | 108.0                     | A                  |                             |
| SXGA                           | SXGA60       | 1 280 x 1 024                | 64.0               | 60.0   | 108.0                     | A                  |                             |
| SXGA60+                        | SXGA60+      | 1 400 x 1 050                | 65.1               | 59.9   | 122.4                     | A                  |                             |
| WIDE768-2                      | WIDE768-2    | 1 360 x 768                  | 48.8               | 59.8   | 74.3                      | A                  |                             |

\*1. The "i" appearing after the resolution indicates an interlaced signal.

\*2. The following symbols are used to indicate picture quality.

AA Maximum picture quality can be obtained.

A Signals are converted by the image processing circuit before picture is projected.



**Discount-Merchant.com (800) 281-8860**  
**THE TRUSTED SOURCE FOR PROJECTOR LAMPS AND ACCESSORIES**

## Serial terminal

The serial connector which is on the connector panel of the projector conforms to the RS-232C interface specification, so that the projector can be controlled by a personal computer which is connected to this connector.

### Connection

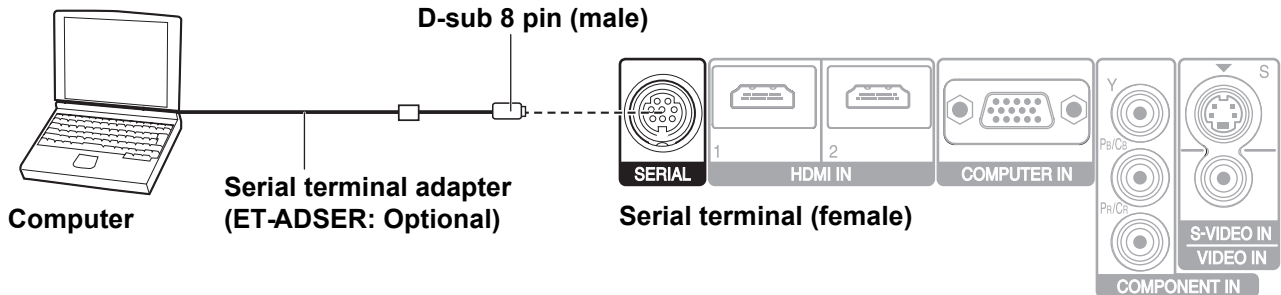

**NOTE:**

- You must use only an RS-232C Serial Interface Cable with a ferrite core, type ET-ADSER.

### Pin assignments and signal names

|  | Pin No. | Signal name | Contents             |
|--|---------|-------------|----------------------|
|  | ①       |             | Connected internally |
|  | ②       |             | Connected internally |
|  | ③       | RXD         | Received data        |
|  | ④       | GND         | Earth                |
|  | ⑤       | TXD         | Transmitted data     |
|  | ⑥       |             | Connected internally |
|  | ⑦       |             | NC                   |
|  | ⑧       |             | NC                   |

### Cable specifications

(When connected to a personal computer)

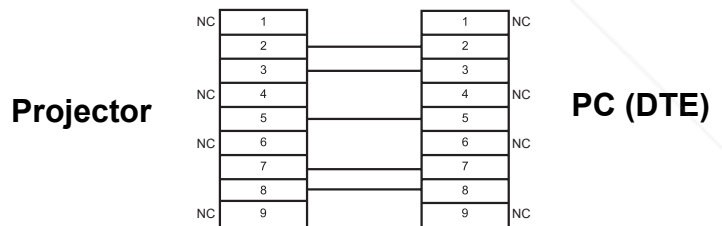

### Basic format

|                  |                |          |                  |            |   |
|------------------|----------------|----------|------------------|------------|---|
| <b>STX</b>       | <b>Command</b> | <b>:</b> | <b>Parameter</b> | <b>ETX</b> | The data streaming from the computer will start with STX, and proceed to Command, Parameter and end with ETX. You can add the required parameter. |
| Start byte (02h) | 3 bytes        | 1 byte   | 1 byte - 4 bytes | End (03h)  |   |

- The projector can not receive any command for 10 seconds after the lamp is switched on. Wait 10 seconds before sending the command.
- If sending multiple commands, check that a response has been received from the projector for one command before sending the next command.
- When a command which does not require parameters to be sent, the colon (:) is not required.
- If an incorrect command is sent from the personal computer, the ER401 command will be sent from the projector to the personal computer.

**Communication settings**

|                     |              |                         |        |
|---------------------|--------------|-------------------------|--------|
| <b>Signal level</b> | RS-232C      | <b>Character length</b> | 8 bits |
| <b>Sync. method</b> | Asynchronous | <b>Stop bit</b>         | 1 bit  |
| <b>Baud rate</b>    | 9 600 bps    | <b>X parameter</b>      | None   |
| <b>Parity</b>       | None         | <b>S parameter</b>      | None   |

**Control commands**

| Command                     | Control contents   | Remarks   |
|-----------------------------|--------------------|---|
| <b>PON</b>                  | POWER ON           | In standby mode, all commands other than the PON command are ignored. The PON command is ignored during lamp ON control.  |
| <b>POF</b>                  | POWER OFF          | If a PON command is received while the cooling fan is operating after the lamp has switched off, the lamp is not turned back on again straight away in order to protect the lamp.                         |
| <b>IIS</b>                  | INPUT              | Parameter:<br>YUV = COMPONENT IN (YPbPr)      VID = VIDEO IN<br>SVD = S-VIDEO IN                      HD2 = HDMI2 IN<br>HD1 = HDMI1 IN                         RG1 = COMPUTER IN                          |
| <b>OMN</b>                  | MAIN               | Displaying the main menu.   |
| <b>OEN</b>                  | ENTER              | Activating the selected items in the menu mode.   |
| <b>OBK</b>                  | RETURN             | Returning to the previous menu or escaping from the menu mode.  |
| <b>OCU/OCB/<br/>OCL/OCR</b> | Navigation buttons | OCU = ▲ button                              OCL = ◀ button<br>OCD = ▼ button                              OCR = ▶ button  |
| <b>OST</b>                  | DEFAULT            | Resetting to the factory default setting. (page 23)   |
| <b>OFZ</b>                  | FREEZE             | Freezing the projected screen.<br>Parameter:<br>0 = OFF    1 = ON   |
| <b>OOT</b>                  | SLEEP              | Setting the duration of time to turn off the power automatically. (page 39)<br>0 = OFF      1 = 60min.      2 = 90min.      3 = 120min.      4 = 150min.<br>5 = 180min.      6 = 210min.      7 = 240min. |
| <b>OSH</b>                  | BLANK              | Turning off the projection temporarily.<br>Send the command to switch between ON and OFF.<br>Do not send the command consecutively.   |
| <b>OVM</b>                  | PICTURE            | Activating the PICTURE menu. Send the command to switch menu items. (page 23)   |
| <b>VS1</b>                  | ASPECT             | Switching the aspect ratio. (page 23)   |
| <b>VPM</b>                  | PICTURE MODE       | Switching the PICTURE MODE. (page 30)<br>Parameter:<br>NOR = NORMAL    DYN = DYNAMIC    VCN = VIVID CINEMA<br>CN1 = CINEMA1    CN2 = CINEMA2    NAT = NATURAL    GAM = GAME                               |

**Inquiry commands**

| Command    | Control contents    | Parameter  |
|------------|---------------------|--|
| <b>QPW</b> | Power status        | 000 = OFF    001 = ON  |
| <b>QFZ</b> | FREEZE status       | 0 = OFF    1 = ON  |
| <b>QIN</b> | INPUT signal status | YUV = COMPONENT IN (YPbPr)      VID = VIDEO IN<br>SVD = S-VIDEO IN                      HD2 = HDMI2 IN<br>HD1 = HDMI1 IN                         RG1 = COMPUTER IN |
| <b>QOT</b> | SLEEP status        | 0 = OFF      1 = 60min.      2 = 90min.      3 = 120min.      4 = 150min.<br>5 = 180min.      6 = 210min.      7 = 240min.   |
| <b>QPM</b> | PICTURE MODE status | NOR = NORMAL    DYN = DYNAMIC    VCN = VIVID CINEMA<br>CN1 = CINEMA1    CN2 = CINEMA2    NAT = NATURAL    GAM = GAME   |
| <b>QSH</b> | BLANK status        | 0 = OFF  |

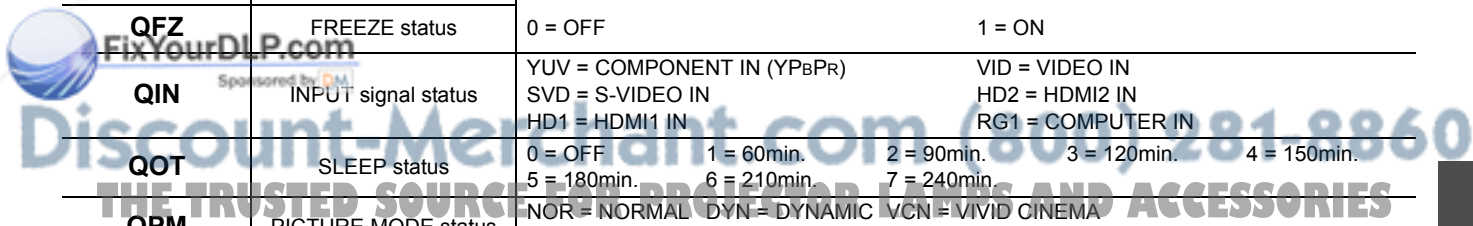



## Technical Information

### Specifications

|  |                                      |   |
|--|--------------------------------------|---|
| <b>Power supply</b>                              |                                      | AC 100 - 240 V 50 Hz/60 Hz  |
| <b>Power consumption</b>                         |                                      | 290 W<br>During standby (when fan is stopped): 0.08 W   |
| <b>Amps</b>                                      |                                      | 3.5 A - 1.5 A   |
| <b>LCD panel</b>                                 | <b>Panel size (diagonal)</b>         | 0.7 type (17.78 mm)   |
|  | <b>Aspect ratio</b>                  | 16 : 9  |
|  | <b>Display method</b>                | 3 transparent LCD panels (RGB)  |
|  | <b>Drive method</b>                  | Active matrix method  |
|  | <b>Pixels</b>                        | 921 600 (1 280 x 720) x 3 panels  |
| <b>Lens</b>                                      |                                      | Manual zoom (2x)/Manual focus<br>F 1.9 - 3.1, f 21.7 mm - 43.1 mm   |
| <b>Lamp</b>                                      |                                      | UHM lamp (220 W)  |
| <b>Luminosity</b>                                |                                      | 2 000 lm  |
| <b>Operating environment</b>                     |                                      | Temperature 0 °C - 40 °C (32 °F - 104 °F)<br>When the ALTITUDE (page 39) is set to ON: 0 °C - 35 °C (32 °F - 95 °F)<br>Humidity 20% - 80% (no condensation)                     |
| <b>Scanning frequency*1<br/>(for RGB signal)</b> | <b>Horizontal scanning frequency</b> | 30 kHz - 70 kHz   |
|  | <b>Vertical scanning frequency</b>   | 50 Hz - 87 Hz   |
|  | <b>Dot clock frequency</b>           | Less than 150 MHz   |
| <b>COMPONENT (YPbPr) signals</b>                 |                                      | 525i (480i), 525p (480p), 625i (576i), 625p (576p), 750 (720)/60p, 750 (720)/50p, 1 125 (1 080)/60i, 1 125 (1 080)/50i, 1 125 (1 080)/24p, 1 125 (1 080)/60p, 1 125 (1 080)/50p |
| <b>Colour system</b>                             |                                      | 7 (NTSC/NTSC 4.43/PAL/PAL-M/PAL-N/PAL60/SECAM)  |
| <b>Projection size</b>                           |                                      | 40" - 200" (1 016 mm - 5 080 mm)  |
| <b>Throw distance</b>                            |                                      | 1.2 m - 12.4 m (3'11" - 40'8")  |
| <b>Screen aspect ratio</b>                       |                                      | 16 : 9  |
| <b>Installation</b>                              |                                      | FRONT/DESK, FRONT/CEILING, REAR/DESK, REAR/CEILING<br>(Menu selection method)   |

\*1. See "List of compatible signals" on page 45 for available signals.

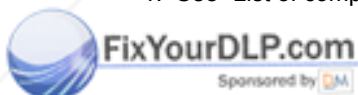

**Discount-Merchant.com (800) 281-8860**  
**THE TRUSTED SOURCE FOR PROJECTOR LAMPS AND ACCESSORIES**

## Technical Information

|  |  |  |                    |
|--|--|--|--------------------|
| <b>Terminals</b>   | <b>S-VIDEO IN</b>  | Single - line, Mini DIN 4p Y: 1.0 V [p-p], C: 0.286 V [p-p], 75 Ω                          |                    |
|  | <b>VIDEO IN</b>  | Single - line, RCA pin jack 1.0 V [p-p], 75Ω   |                    |
|  | <b>COMPUTER IN</b>   | Single - line, D - sub HD 15-pin (female)  |                    |
|  |  | R.G.B. 0.7 V [p-p], 75 Ω   |                    |
|  |  | G.SYNC 1.0 V [p-p], 75 Ω   |                    |
|  |  | HD/SYNC TTL high impedance, automatic positive/negative polarity compatible                |                    |
| VD TTL high impedance, automatic positive/negative polarity compatible |  |  |                    |
| <b>COMPONENT IN</b>  | Y, PB/CB, PR/CR Single - line, RCA pin jack x 3<br>Y: 1.0 V [p-p] (including sync), 75 Ω<br>PB/CB, (PR/CR) 0.7 V [p-p], 75 Ω |  |                    |
| <b>HDMI IN</b>   | Dual - line, 19-pin HDMI connector   |  |                    |
| <b>SERIAL</b>  | DIN 8-pin RS-232C compatible   |  |                    |
| <b>Cabinet</b>   | Moulded plastic (PC+ABS)   |  |                    |
| <b>Dimensions</b>  | Width  | 395 mm (15 -17/32")  |                    |
|  | Height   | 112 mm (4 -13/32")   |                    |
|  | Length   | 300 mm (11 -25/32")  |                    |
| <b>Weight</b>  | 4.9 kg (10.8 lbs.)   |  |                    |
| <b>Certifications</b>  | EN60950-1, EN55022, EN61000-3-2, EN61000-3-3, EN55024  |  |                    |
| <b>Remote control</b>  | <b>Power supply</b>  | 3 V DC (AA battery x 2)  |                    |
|  | <b>Operating range</b>   | Approx. 7 m (23') (when operated directly in front of signal receptor)                     |                    |
|  | <b>Weight</b>  | 125 g (4.4 ozs.) (including batteries)   |                    |
|  | <b>Dimensions</b>  | Width  | 48 mm (1 -7/8")    |
|  |  | Length   | 138 mm (5 -13/32") |
| Height   |  | 28.35 mm (1 -3/32")<br>(not including surface projection parts)                            |                    |
| <b>Options</b>   | <b>Ceiling bracket</b>   | ET-PKX200  |                    |
|  | <b>Projection screen</b>   | ET-SRW90CC   |                    |
|  | <b>Cables</b>  | ET-SC10CP (RCA pin jack x 3 - RCA pin jack x3)<br>ET-SC10DT (RCA pin jack x3 - D-Terminal) |                    |
|  | <b>Serial adapter</b>  | ET-ADSER (DIN 8-pin/D-sub 9-pin)   |                    |

### Ceiling mount bracket safeguards

The projector and the ceiling mount bracket are designed sufficiently safety though, make sure the safety cable provided with the projector is installed and attached to the security lock slot of the projector when mounting in the ceiling for safety and security.

#### NOTE:

- Even if it is guarantee period, the manufacturer is not responsible for any hazard or damage caused by using a ceiling mount bracket which is not purchased from an authorised distributors, or environmental conditions.
- Make sure to use a torque driver and do not use an electrical screwdriver or an impact screwdriver.
- Installation work of the ceiling mount bracket should only be carried by a qualified technician.
- Remove an unused ceiling mount bracket promptly.

#### Installing the safety cable

1. Install the ceiling mount bracket according to the Installation Instructions.
2. Loop the security cable around the ceiling mount bracket with less slack.
  - Lace the cable of the end with a latch through the loop on the other end of the cable.

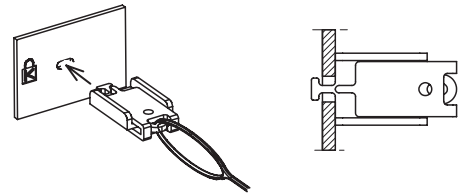

3. Pull out the tab of the lock and insert it to the security lock slot of the projector.
4. Twist the lock 90° and push in securely.

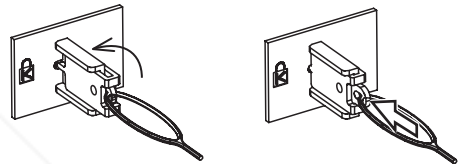

5. Attach the provided screw securely with a screwdriver, such as a torque screwdriver.
  - Torque: 0.7±0.1 N·m

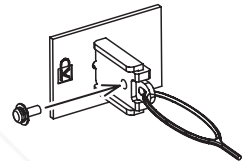

## Dimensions

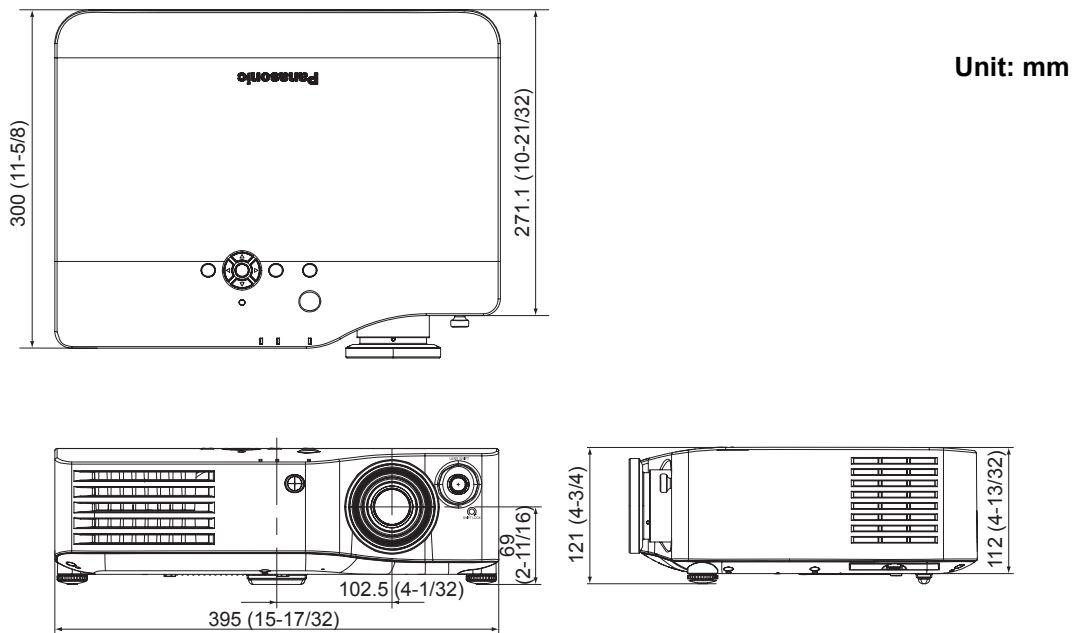

## Trademark acknowledgements

- VGA and XGA are trademarks of International Business Machines Corporation.
- S-VGA is a registered trademark of the Video Electronics Standards Association.
- HDMI, the HDMI logo and High-Definition Multimedia Interface are trademarks or registered trademarks of HDMI Licensing LLC.
- The font used in the on-screen displays is a Ricoh bitmap font, which is manufactured and sold by Ricoh Company, Ltd.

All other trademarks are the property of the various trademark owners.



**Discount-Merchant.com (800) 281-8860**  
**THE TRUSTED SOURCE FOR PROJECTOR LAMPS AND ACCESSORIES**

# Index

|                               |        |                                  |        |
|-------------------------------|--------|----------------------------------|--------|
| <b>A</b>                      |        | <b>F</b>                         |        |
| AC IN .....                   | 13     | FAVOURITE EDIT .....             | 33     |
| Accessories .....             | 10     | FAVOURITE LOAD .....             | 32     |
| ADVANCED MENU .....           | 31     | Remote control button .....      | 11     |
| Air exhaust port .....        | 12     | Remote control function .....    | 22     |
| Air filter .....              | 13     | FAVOURITE SAVE .....             | 32     |
| Replacing .....               | 41     | Focus ring .....                 | 12     |
| Air intake port .....         | 12, 13 | FREEZE                           |        |
| ALTITUDE .....                | 39     | Remote control button .....      | 11     |
| ASPECT                        |        | Remote control function .....    | 23     |
| POSITION menu .....           | 34     | Front leg adjusters .....        | 13, 15 |
| Remote control button .....   | 11     | FUNCTION BUTTON .....            | 37     |
| Remote control function ..... | 23     | Remote control button .....      | 11     |
| AUTO SEARCH .....             | 38     | Remote control function .....    | 26     |
| AUTO SETUP .....              | 36     |                                  |        |
| <b>B</b>                      |        | <b>G</b>                         |        |
| BACK COLOUR .....             | 38     | GAMMA .....                      | 31     |
| Batteries                     |        | <b>H</b>                         |        |
| Accessory .....               | 10     | HDMI IN                          |        |
| Compartment .....             | 11     | Connection .....                 | 18     |
| BLANK .....                   | 37     | Terminal .....                   | 13     |
| BRIGHTNESS                    |        | HDMI SIGNAL LEVEL .....          | 38     |
| ADVANCED MENU .....           | 31     | H-POSITION .....                 | 34     |
| PICTURE menu .....            | 30     |                                  |        |
| <b>C</b>                      |        | <b>I</b>                         |        |
| Ceiling mount bracket .....   | 50     | INPUT                            |        |
| CINEMA REALITY .....          | 31     | Control panel button .....       | 12     |
| Cleaning .....                | 41     | Remote control button .....      | 11     |
| CLOCK PHASE .....             | 34     | Remote control function .....    | 26     |
| COLOUR .....                  | 30     | INPUT GUIDE .....                | 38     |
| COLOUR MANAGEMENT             |        | INPUT SELECT                     |        |
| ADVANCED MENU .....           | 31     | Control panel button .....       | 12     |
| Remote control button .....   | 11     | INSTALLATION                     |        |
| Remote control function ..... | 24     | POSITION menu .....              | 38     |
| COLOUR TEMPERATURE .....      | 31     | Projection method .....          | 15     |
| COMPONENT IN                  |        | <b>K</b>                         |        |
| Connection .....              | 18     | KEYSTONE .....                   | 36     |
| Terminal .....                | 13     |                                  |        |
| COMPUTER IN                   |        | <b>L</b>                         |        |
| Connection .....              | 18     | LAMP                             |        |
| Terminal .....                | 13     | Indicator .....                  | 12     |
| Connections .....             | 18     | Indicator status .....           | 40     |
| CONTRAST                      |        | LAMP POWER .....                 | 39     |
| ADVANCED MENU .....           | 31     | LAMP RUNTIME .....               | 39, 43 |
| PICTURE menu .....            | 30     | Lamp unit                        |        |
|                               |        | Compartment .....                | 13     |
| <b>D</b>                      |        | Replacing .....                  | 42     |
| DEFAULT                       |        | LANGUAGE .....                   | 29     |
| Remote control button .....   | 11     | Lens cover .....                 | 12     |
| Remote control function ..... | 23     | Accessory .....                  | 10     |
| Dimensions .....              | 51     | Attachment hole .....            | 13     |
| DOT CLOCK .....               | 34     | Lens shift                       |        |
| DYNAMIC IRIS .....            | 31     | Lens shift dial • Vertical ..... | 12     |
| <b>E</b>                      |        | LIGHT                            |        |
| ENTER                         |        | Remote control buttons .....     | 11     |
| Control panel button .....    | 12     | Remote control function .....    | 22     |
| Remote control button .....   | 11     | LIGHT HARMONIZER .....           | 31     |
|                               |        | LIVING ROOM                      |        |
|                               |        | Remote control button .....      | 11     |
|                               |        | Remote control function .....    | 22     |
|                               |        | Luminance sensor .....           | 12     |

|          |                                  |          |                                  |
|----------|----------------------------------|----------|----------------------------------|
| <b>M</b> | MAIN POWER ..... 13              | <b>S</b> | Safety cable ..... 50            |
|          | Mains lead                       |          | Accessory ..... 10               |
|          | Accessory ..... 10               |          | Screen size ..... 14             |
|          | Connecting ..... 19              |          | Calculation methods ..... 14     |
|          | MENU                             |          | Security lock ..... 13           |
|          | Control panel button ..... 12    |          | SERIAL                           |
|          | Remote control button ..... 11   |          | Basic format ..... 46            |
|          | Remote control function ..... 27 |          | Cable specifications ..... 46    |
|          | Menu                             |          | Communication settings ..... 47  |
|          | Main menu ..... 28               |          | Connection ..... 46              |
|          | Navigation ..... 27              |          | Control commands ..... 47        |
|          | Sub-menu ..... 28                |          | Inquiry commands ..... 47        |
|          | MPEG NR ..... 31                 |          | Pin assignments ..... 46         |
| <b>N</b> |                                  |          | Terminal ..... 13                |
|          | Navigation buttons               |          | SHARPNESS ..... 30               |
|          | Control panel button ..... 12    |          | SLEEP ..... 39                   |
|          | Remote control button ..... 11   |          | Specifications ..... 48          |
|          | NR ..... 31                      |          | STARTUP LOGO ..... 38            |
| <b>O</b> |                                  |          | S-VIDEO IN                       |
|          | OPTION menu ..... 38             |          | Connection ..... 18              |
|          | OSD DESIGN ..... 38              |          | Terminal ..... 13                |
|          | OSD POSITION ..... 38            | <b>T</b> |                                  |
|          | OVER SCAN ..... 36               |          | Technical Information ..... 45   |
| <b>P</b> |                                  |          | TEMP                             |
|          | PICTURE ..... 30                 |          | Indicator ..... 12               |
|          | Remote control button ..... 11   |          | Indicator status ..... 40        |
|          | Remote control function ..... 23 |          | TEST PATTERN ..... 39            |
|          | PICTURE ADJUSTMENT               |          | THEATER ROOM                     |
|          | Remote control button ..... 11   |          | Remote control button ..... 11   |
|          | Remote control function ..... 23 |          | Remote control function ..... 22 |
|          | PICTURE MODE ..... 30            |          | Throw distance ..... 14          |
|          | Remote control buttons ..... 11  |          | Throwing angle ..... 15          |
|          | Remote control function ..... 22 |          | TINT ..... 30                    |
|          | POSITION ..... 34                |          | Troubleshooting ..... 44         |
|          | POWER                            |          | TV-SYSTEM ..... 32               |
|          | Control panel button ..... 12    | <b>V</b> |                                  |
|          | Indicator ..... 12               |          | VIDEO IN                         |
|          | Indicator status ..... 19        |          | Connection ..... 18              |
|          | Remote control button ..... 11   |          | Terminal ..... 13                |
| <b>R</b> |                                  |          | V-POSITION ..... 34              |
|          | Remote control ..... 11          | <b>W</b> |                                  |
|          | Accessory ..... 10               |          | WSS ..... 36                     |
|          | Operating range ..... 22         | <b>Z</b> |                                  |
|          | Operation ..... 22               |          | Zoom ring ..... 12               |
|          | Signal emitter ..... 11          |          |                                  |
|          | Signal receptor ..... 12         |          |                                  |
|          | RETURN                           |          |                                  |
|          | Control panel button ..... 12    |          |                                  |
|          | Remote control button ..... 11   |          |                                  |
|          | Remote control function ..... 27 |          |                                  |

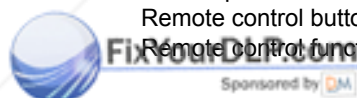

**Discount-Merchant.com (800) 281-8860**  
**THE TRUSTED SOURCE FOR PROJECTOR LAMPS AND ACCESSORIES**



FixYourDLP.com

Sponsored by 

**Discount-Merchant.com (800) 281-8860**

**THE TRUSTED SOURCE FOR PROJECTOR LAMPS AND ACCESSORIES**

**Matsushita Electric Industrial Co., Ltd.**

Web Site: <http://panasonic.net>



# Disclaimer

This user manual is provided as a free service by FixYourDLP.com. FixYourDLP is in no way responsible for the content of this manual, nor do we guarantee its accuracy. FixYourDLP does not make any claim of copyright and all copyrights remain the property of their respective owners.

About FixYourDLP.com

FixYourDLP.com (<http://www.fixyourdpl.com>) is the World's #1 resource for media product news, reviews, do-it-yourself guides, and manuals.

Informational Blog: <http://www.fixyourdpl.com>

Video Guides: <http://www.fixyourdpl.com/guides>

User Forums: <http://www.fixyourdpl.com/forum>

FixYourDLP's Fight Against Counterfeit Lamps:

<http://www.fixyourdpl.com/counterfeits>

## Sponsors:

RecycleYourLamp.org – Free lamp recycling services for used lamps:

<http://www.recycleyourlamp.org>

Lamp Research - The trusted 3rd party lamp research company:

<http://www.lampresearch.com>

Discount-Merchant.com – The worlds largest lamp distributor:

<http://www.discount-merchant.com>



**FixYourDLP.com**

Sponsored by 