



# Disclaimer

This user manual is provided as a free service by FixYourDLP.com. FixYourDLP is in no way responsible for the content of this manual, nor do we guarantee its accuracy. FixYourDLP does not make any claim of copyright and all copyrights remain the property of their respective owners.

About FixYourDLP.com

FixYourDLP.com (<http://www.fixyourdpl.com>) is the World's #1 resource for media product news, reviews, do-it-yourself guides, and manuals.

Informational Blog: <http://www.fixyourdpl.com>

Video Guides: <http://www.fixyourdpl.com/guides>

User Forums: <http://www.fixyourdpl.com/forum>

FixYourDLP's Fight Against Counterfeit Lamps:

<http://www.fixyourdpl.com/counterfeits>

## Sponsors:

RecycleYourLamp.org – Free lamp recycling services for used lamps:

<http://www.recycleyourlamp.org>

Lamp Research - The trusted 3rd party lamp research company:

<http://www.lampresearch.com>

Discount-Merchant.com – The worlds largest lamp distributor:

<http://www.discount-merchant.com>



**FixYourDLP.com**

Sponsored by 

# Panasonic®

LCD Projector Commercial Use

ENGLISH

## Operating Instructions

Model No. **PT-LB60NTU**  
**PT-LB60U**

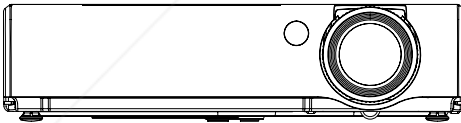

**Discount-Merchant.com (800) 281-8860**  
THE TRUSTED SOURCE FOR PROJECTOR LAMPS AND ACCESSORIES

Before operating this product, please read the instructions carefully and save this manual for future use.

TQBJ 0193

# Dear Panasonic Customer:

This instruction booklet provides all the necessary operating information that you might require. We hope it will help you to get the most out of your new product, and that you will be pleased with your Panasonic LCD projector. The serial number of your product may be found on its bottom. You should note it in the space provided below and retain this booklet in case service is required.

Model number: **PT-LB60NTU / PT-LB60U**

Serial number: \_\_\_\_\_

## IMPORTANT SAFETY NOTICE

**WARNING: TO REDUCE THE RISK OF FIRE OR ELECTRIC SHOCK, DO NOT EXPOSE THIS PRODUCT TO RAIN OR MOISTURE.**

**Power Supply:** This LCD Projector is designed to operate on 100 V – 240 V, 50 Hz/60 Hz AC, house current only.

**CAUTION:** The AC power cord which is supplied with the projector as an accessory can only be used for power supplies up to 125 V, 7 A. If you need to use higher voltages or currents than this, you will need to obtain a separate 250 V power cord. If you use the accessory cord in such situations, fire may result.



The lightning flash with arrowhead symbol, within an equilateral triangle, is intended to alert the user to the presence of uninsulated “dangerous voltage” within the product’s enclosure that may be of sufficient magnitude to constitute a risk of electric shock to persons.



The exclamation point within an equilateral triangle is intended to alert the user to the presence of important operating and maintenance (servicing) instructions in the literature accompanying the product.

**CAUTION:** **DISCOUNT-MERCHANT.COM (800) 281-8860**

This equipment is equipped with a three-pin grounding-type power plug. Do not remove the grounding pin on the power plug. This plug will only fit a grounding-type power outlet. This is a safety feature. If you are unable to insert the plug into the outlet, contact an electrician. Do not defeat the purpose of the grounding plug.

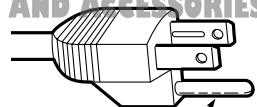

Do not remove

**WARNING:**

This equipment has been tested and found to comply with the limits for a Class B digital device, pursuant to Part 15 of the FCC Rules. These limits are designed to provide reasonable protection against harmful interference in a residential installation. This equipment generates, uses and can radiate radio frequency energy and, if not installed and used in accordance with the instructions, may cause harmful interference to radio communications. However, there is no guarantee that interference will not occur in a particular installation. If this equipment does cause harmful interference to radio or television reception, which can be determined by turning the equipment off and on, the user is encouraged to try to correct the interference by one or more of the following measures:

- Reorient or relocate the receiving antenna.
- Increase the separation between the equipment and receiver.
- Connect the equipment into an outlet on a circuit different from that to which the receiver is connected.
- Consult the dealer or an experienced radio/TV technician for help.

**FCC CAUTION:** To assure continued compliance, use only shielded interface cables when connecting to computers or peripheral devices.

Any unauthorized changes or modifications to this equipment will void the users authority to operate.

**FCC RF Exposure Warning: (if provided with wireless device)**

- This equipment complies with FCC radiation exposure limits set forth for an uncontrolled environment.
- This equipment has been approved for mobile operation and requires minimum 20 cm spacing be provided between antenna(s) and all person's body (excluding extremities of hands, wrist and feet) during wireless modes of operation.
- This equipment may not be used with other installed transmitters, which may be capable of simultaneous transmission.

**WARNING:**

- Not for use in a computer room as defined in the Standard for the Protection of Electronic Computer/Data Processing Equipment, ANSI/NFPA 75.
- For permanently connected equipment, a readily accessible disconnect device shall be incorporated in the building installation wiring;
- For pluggable equipment, the socket-outlet shall be installed near the equipment and shall be easily accessible.

**Declaration of Conformity**

Model Number: PT-LB60NTU / PT-LB60U  
 Trade Name: **Panasonic**  
 Responsible party: Panasonic Corporation of North America  
 Address: One Panasonic Way Secaucus New Jersey 07094  
 Telephone number: 1-800-528-8601 or 1-800-222-0741  
 Email: pbtsservice@panasonic.com

This device complies with Part 15 of the FCC Rules. Operation is subject to the following two conditions: (1) This device may not cause harmful interference, and (2) this device must accept any interference received, including interference that may cause undesired operation.

# Contents

## Preparation

<b>IMPORTANT SAFETY NOTICE ...</b>	<b>2</b>
<b>Precautions with regard to safety .....</b>	<b>5</b>
<b>Accessories .....</b>	<b>9</b>
<b>Before use .....</b>	<b>10</b>
<b>Location and function of each part...</b>	<b>12</b>

## Getting started

<b>Setting-up .....</b>	<b>18</b>
Projection methods, Projector position, Projection distances	
<b>Connections .....</b>	<b>21</b>
Connecting to computer, Connecting to video equipment (1), Connecting to video equipment (2)	
<b>Preparation for the remote control unit.....</b>	<b>24</b>

## Basic operation

<b>Turning on the power .....</b>	<b>26</b>
<b>Turning off the power.....</b>	<b>28</b>

## Useful functions

<b>Selecting the input signal .....</b>	<b>30</b>
<b>Correcting the image position automatically.....</b>	<b>31</b>
<b>Turning off the picture and sound momentarily .....</b>	<b>32</b>
<b>Adjusting the volume .....</b>	<b>32</b>
<b>Enlarging the picture.....</b>	<b>33</b>
<b>Displaying two screens.....</b>	<b>34</b>
<b>Displaying the pointer.....</b>	<b>35</b>

## Adjustments and settings

<b>On-screen menus .....</b>	<b>36</b>
Menu screens, Menu operation guide, Returning a setting to the factory default	
<b>Adjusting the picture.....</b>	<b>40</b>
PICTURE MODE, CONTRAST, BRIGHTNESS, COLOR, TINT, SHARPNESS, COLOR TEMPERATURE, Projecting sRGB-compatible pictures, DAYLIGHT VIEW, AI, DETAILED SETUP	
<b>Adjusting the position.....</b>	<b>44</b>

REALTIME KEYSTONE, KEYSTONE, POSITION, DOT CLOCK, CLOCK PHASE, ASPECT, RESIZING, FRAME LOCK

## **Changing the display**

<b>language.....</b>	<b>48</b>
<b>Option settings .....</b>	<b>49</b>
INPUT GUIDE, STARTUP LOGO, POINTER SELECT, PC2 SELECT, LAMP POWER, LAMP RUNTIME, POWER OFF TIMER, DIRECT POWER ON, CONTROL PANEL, AUTO SETUP, SIGNAL SEARCH, INSTALLATION, HIGHLAND, RGB/YPbPr, VOLUME, DETAILED SETUP	

## **Setting up the security**

<b>function .....</b>	<b>54</b>
INPUT PASSWORD, PASSWORD CHANGE, TEXT DISPLAY, TEXT CHANGE	

## **Wireless setup .....**

## Care and maintenance

<b>When the TEMP indicator and the LAMP indicator are illuminated ..</b>	<b>57</b>
<b>Cleaning and replacing the air filter ..</b>	<b>59</b>
<b>Replacing the lamp unit .....</b>	<b>60</b>
<b>Before calling for service.....</b>	<b>63</b>
<b>Cleaning and maintenance .....</b>	<b>64</b>

## Others

<b>Specifications .....</b>	<b>65</b>
<b>Appendix .....</b>	<b>67</b>
Projection dimensions calculation methods, List of compatible signals, Guide screen for computer connection, Using the SERIAL connector	
<b>Dimensions .....</b>	<b>72</b>
<b>Trademark acknowledgements .....</b>	<b>72</b>

## **NOTES IMPORTANTES**

<b>CONCERNANT LA SECURITE...73</b>	
<b>Précautions de sécurité.....74</b>	
<b>Avant l'utilisation.....78</b>	
<b>Remplacement du bloc de lampe ...80</b>	

# Precautions with regard to safety

## WARNING

**If you notice smoke, strange smells or noise coming from the projector, disconnect the power cord plug from the wall outlet.**

- Do not continue to use the projector in such cases, otherwise fire or electric shocks could result.
- Check that no more smoke is coming out, and then contact an Authorized Service Center for repairs.
- Do not attempt to repair the projector yourself, as this can be dangerous.

**Do not install this projector in a place which is not strong enough to take the full weight of the projector.**

- If the installation location is not strong enough, it may fall down or tip over, and severe injury or damage could result.

**Installation work (such as ceiling suspension) should only be carried out by a qualified technician.**

- If installation is not carried out correctly, there is the danger that injury or electric shocks may occur.

**If foreign objects or water get inside the projector, or if the projector is dropped or the cabinet is broken, disconnect the power cord plug from the wall outlet.**

- Continued use of the projector in this condition may result in fire or electric shocks.
- Contact an Authorized Service Center for repairs.

**Do not overload the wall outlet.**

- If the power supply is overloaded (for example, by using too many adapters), overheating may occur and fire may result.

**Do not remove the cover or modify it in any way.**

- High voltages can cause fire or electric shocks.
- For any inspection, adjustment and repair work, please contact an Authorized Service Center.

**Clean the power cord plug regularly to prevent it from becoming covered in dust.**

- If dust builds up on the power cord plug, the resulting humidity can damage the insulation, which could result in fire. Pull the power cord plug out from the wall outlet and wipe it with a dry cloth.
- If not using the projector for an extended period of time, pull the power cord plug out from the wall outlet.

**Do not do anything that might damage the power cord or the power cord plug.**

- Do not damage the power cord, make any modifications to it, place it near any hot objects, bend it excessively, twist it, pull it, place heavy objects on top of it or wrap it into a bundle.

- If the power cord is used while damaged, electric shocks, short-circuits or fire may result.
- Ask an Authorized Service Center to carry out any repairs to the power cord that might be necessary.

**Do not handle the power cord plug with wet hands.**

- Failure to observe this may result in electric shocks.

**Insert the power cord plug securely into the wall outlet.**

- If the plug is not inserted correctly, electric shocks or overheating could result.
- Do not use plugs which are damaged or mains sockets which are coming loose from the wall.

**Do not place the projector on top of surfaces which are unstable.**

- If the projector is placed on top of a surface which is sloped or unstable, it may fall down or tip over, and injury or damage could result.

**Do not place the projector into water or let it become wet.**

- Failure to observe this may result in fire or electric shocks.

**Do not place the projector on soft materials such as carpets or sponge mats.**

- Doing so may cause the projector to overheat, which can cause burns, fire or damage to the projector.

**Do not place liquid containers on top of the projector.**

- If water spills onto the projector or gets inside it, fire or electric shocks could result.
- If any water gets inside the projector, contact an Authorized Service Center.

**Do not insert any foreign objects into the projector.**

- Do not insert any metal objects or flammable objects into the projector or drop them onto the projector, as doing so can result in fire or electric shocks.

**Keep the batteries out of the reach of infants.**

- If the batteries are swallowed, death by suffocation may result. If you believe that the batteries may have been swallowed, seek medical advice immediately.

**Do not allow the + and - terminals of the batteries to come into contact with metallic objects such as necklaces or hairpins.**

- Failure to observe this may cause the batteries to leak, overheat, explode or catch fire.
- Store the batteries in a plastic bag and keep them away from metallic objects.

**During a thunderstorm, do not touch the projector or the cable.**

- Electric shocks can result.

**Do not use the projector in a bath or shower.**

- Fire or electric shocks can result.

**Do not look into the lens while the projector is being used.**

- Strong light is emitted from the projector's lens. If you look directly into this light, it can hurt and damage your eyes.
- Be especially careful not to let young children look into the lens. In addition, disconnect the power cord plug when you are away from the projector.

**Do not place your skin into the light beam while the projector is being used.**

- Strong light is emitted from the projector's lens. If you place directly into this light, it can hurt or damage your skin.

**Do not place your hands or other objects close to the air outlet port.**

- Heated air comes out of the air outlet port. Do not place your hands or face, or objects which cannot withstand heat close to this port [allow at least 15 cm (6") of space], otherwise burns or damage could result.

**Replacement of the lamp should only be carried out by a qualified technician.**

- The lamp has high internal pressure. If improperly handled, explosion might result.
- The lamp can easily become damaged if struck against hard objects or dropped, and injury or malfunctions may result.

**When replacing the lamp, allow it to cool for at least one hour before handling it.**

- The lamp cover gets very hot, and touching it can cause burns.

**Before replacing the lamp, be sure to disconnect the power cord plug from the wall outlet.**

- Electric shocks or explosions can result if this is not done.

## Caution

**Do not cover the air inlet port or the air outlet port.**

- Doing so may cause the projector to overheat, which can cause fire or damage to the projector.
- Do not place the projector in narrow, badly ventilated places such as closets or bookshelves.
- Do not place the projector on cloth or papers, as these materials could be drawn into the air inlet port.

**Do not set up the projector in humid or dusty places or in places where the projector may come into contact with smoke or steam.**

- Using the projector under such conditions may result in fire or electric shocks.

**When disconnecting the power cord, hold the plug, not the cord.**

- If the mains lead itself is pulled, the lead will become damaged, and fire, short-circuits or serious electric shocks may result.



**Always disconnect all cables before moving the projector.**

- Moving the projector with cables still attached can damage the cables, which could cause fire or electric shocks to occur.

**Do not place any heavy objects on top of the projector.**

- Failure to observe this may cause the projector to become unbalanced and fall, which could result in damage or injury.

**Do not short-circuit, heat or disassemble the batteries or place them into water or fire.**

- Failure to observe this may cause the batteries to overheat, leak, explode or catch fire, and burns or other injury may result.

**When inserting the batteries, make sure the polarities (+ and -) are correct.**

- If the batteries are inserted incorrectly, they may explode or leak, and fire, injury or contamination of the battery compartment and surrounding area may result.

**Use only the specified batteries.**

- If incorrect batteries are used, they may explode or leak, and fire, injury or contamination of the battery compartment and surrounding area may result.

**Do not mix old and new batteries.**

- If the batteries are inserted incorrectly, they may explode or leak, and fire, injury or contamination of the battery compartment and surrounding area may result.

**Do not put your weight on this projector.**

- You could fall or the projector could break, and injury may result.
- Be especially careful not to let young children stand or sit on the projector.

**If not using the projector for an extended period of time, disconnect the power cord plug from the wall outlet.**

- If dust builds up on the mains plug, the resulting humidity may damage the insulation, which could result in fire.
- This projector continues to draw approximately 3 W of power even when the power is turned off.

**Disconnect the power cord plug from the wall outlet as a safety precaution before carrying out any cleaning.**

- Electric shocks can result if this is not done.

**If the lamp has broken, ventilate the room immediately. Do not touch or bring your face close to the broken pieces.**

- Failure to observe this may cause the user to absorb the gas which was released when the lamp broke and which contains nearly the same amount of mercury as fluorescent lamps, and the broken pieces may cause injury.
- If you believe that you have absorbed the gas or that the gas has got into your eyes or mouth, seek medical advice immediately.
- Ask your dealer to replace the lamp unit and check the inside of the projector.

**Ask an Authorized Service Center to clean inside the projector at least once a year.**

- If dust is left to build up inside the projector without being cleaned out, it can result in fire or problems with operation.
- It is a good idea to clean the inside of the projector before the season for humid weather arrives. Ask your nearest Authorized Service Center to clean the projector when required. Please discuss with the Authorized Service Center regarding cleaning costs.



**We are constantly making efforts to preserve and maintain a clean environment. Please take non repairable units back to your dealer or a recycling company.**

**NOTICE:**

- This product has a High Intensity Discharge (HID) lamp that contains a small amount of mercury. It also contains lead in some components. Disposal of these materials may be regulated in your community due to environmental considerations. For disposal or recycling information please contact your local authorities, or the Electronics Industries Alliance: <<http://www.eiae.org>>

## Accessories

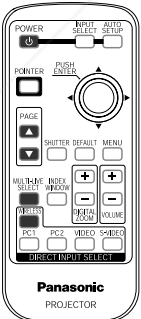
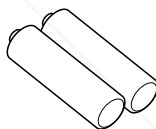
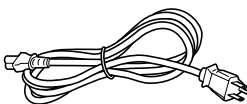
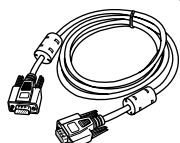
Check that all of the accessories shown below have been included with your projector.

<p>Card remote control unit* (PT-LB60NTU: N2QAYA000001 x1 PT-LB60U: N2QAYA000002 x1)</p>  <p>*The illustration above is the remote control unit for the PT-LB60NTU.</p>	<p>AAA batteries for remote control unit (x2)</p> 
<p>Power cord (K2CG3DR00006 x 1)</p> 	<p>RGB signal cable [1.8 m (5'10"), K1HA15DA0002 x1]</p> 
<p>Carrying bag (TPEP019 x 1)</p> 	<p>CD-ROM* (TQBH9008 x1)</p>  <p>*PT-LB60NTU only</p>

# Before use

## Caution when moving the projector

**Be sure to attach the lens cover before moving the projector.**

The projection lens is extremely susceptible to vibration and shocks. When moving the projector, use the accessory carrying bag. When placing the projector inside the carrying bag, position it so that the lens is facing upward. Do not place the projector with its adjustable legs extended and do not put anything else in the bag other than the projector, cables and the remote control unit.

## Cautions regarding setup

**Avoid setting up in places which are subject to vibration or shocks.**

The internal parts can be damaged, which may cause malfunctions or accidents.

**Avoid setting up in places which are subject to sudden temperature changes, such as near an air conditioner.**

The life of the lamp may be shortened.

**Do not set up the projector near high-voltage power lines or near motors.**

The projector may be subject to electromagnetic interference.

**If installing the projector to the ceiling, ask a qualified technician to carry out all installation work.**

You will need to purchase the separate installation kit (Model No.ET-PKB30). Furthermore, all installation work should only be carried out by a qualified technician.

**If using this projector at high elevations (above 1 400 m), set the “HIGHLAND” to “ON”. (Refer to page 52.)**

Failure to observe this may result in malfunctions.



**Discount-Merchant.com (800) 281-8860**  
**THE TRUSTED SOURCE FOR PROJECTOR LAMPS AND ACCESSORIES**

## Notes on use

### In order to get the best picture quality

Draw curtains or blinds over any windows and turn off any lights near the screen to prevent outside light or light from indoor lamps from shining onto the screen.

### Do not touch the surfaces of the lens with your bare hands.

If the surface of the lens becomes dirty from fingerprints or anything else, this will be magnified and projected onto the screen. Moreover, when not using the projector, retract the lens and then cover it with the lens cover.

### Screen

Do not apply any volatile substances which may cause discoloration to the screen, and do not let it become dirty or damaged.

### Lamp

The lamp may need to be replaced earlier due to variables such as individual lamp characteristics, usage conditions and the installation environment, especially when the projector is subjected to continuous use for more than 10 hours or the power is frequently turned on and off.

### Liquid crystal panel

The liquid crystal panel of the projector is built with very high precision technology to provide fine picture details. Occasionally, a few non-active pixels may appear on the screen as fixed points of blue, green or red. Please note that this does not affect the performance of your LCD.



**Discount-Merchant.com (800) 281-8860**  
**THE TRUSTED SOURCE FOR PROJECTOR LAMPS AND ACCESSORIES**

# Location and function of each part

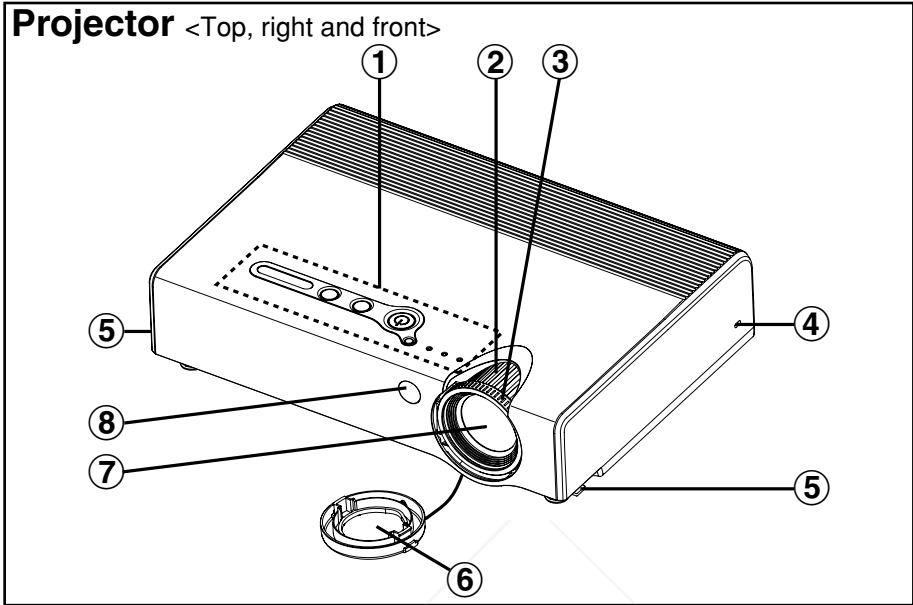

① **Projector control panel** (page 14)

② **Zoom ring** (page 27)

③ **Focus ring** (page 27)

④ **Security lock**

This can be used to connect a commercially-available theft-prevention cable (manufactured by Kensington). This security lock is compatible with the Microsaver Security System from Kensington.

⑤ **Leg adjuster buttons (L/R)** (page 27)

These buttons are used to unlock the front adjustable legs. Press to adjust the angle of tilt of the projector.

⑥ **Lens cover**

⑦ **Projection lens**

⑧ **Remote control signal receptor** (page 24)



Discount-Merchant.com  
Sponsored by DM

**Discount-Merchant.com (800) 281-8860**

**THE TRUSTED SOURCE FOR PROJECTOR LAMPS AND ACCESSORIES**

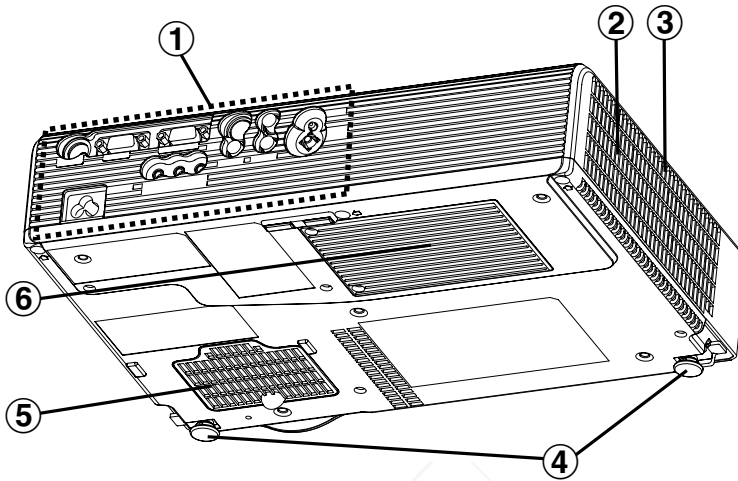
**Projector** <Back and bottom>

- ① **Connector panel** (page 16)
- ② **Air outlet port**  
Do not cover this port.
- ③ **Speaker**
- ④ **Front adjustable legs (L/R)** (page 27)
- ⑤ **Air inlet port, Air filter** (page 59)  
Do not cover this port.
- ⑥ **Lamp unit cover** (page 60)

**NOTE:**

- During projection of an image, the cooling fan will operate, emitting a small noise as it operates. This noise may change depending on the ambient temperature. Turning the lamp on or off will cause this noise to increase a little.
- By using the “OPTION” menu to set “LAMP POWER” to “ECO-MODE”, the operating sound of the fan can be reduced. (Refer to page 50.)

**WARNING**

**Do not place your hands or other objects close to the air outlet port.**

- Heated air comes out of the air outlet port. Do not place your hands or face, or objects which cannot withstand heat close to this port [allow at least 15 cm (6") of space], otherwise burns or damage could result.

## Projector control panel

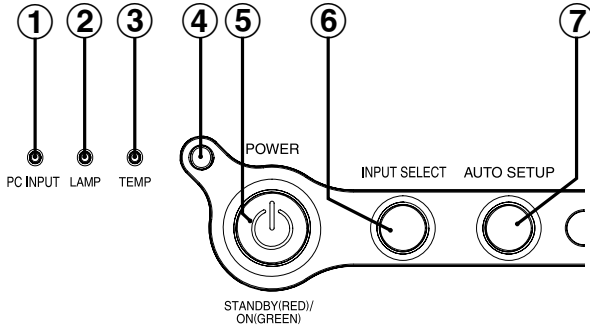

## Menu operation

<on connector panel:page 16>

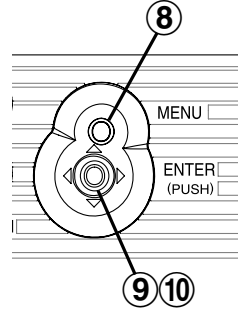

## Remote control unit

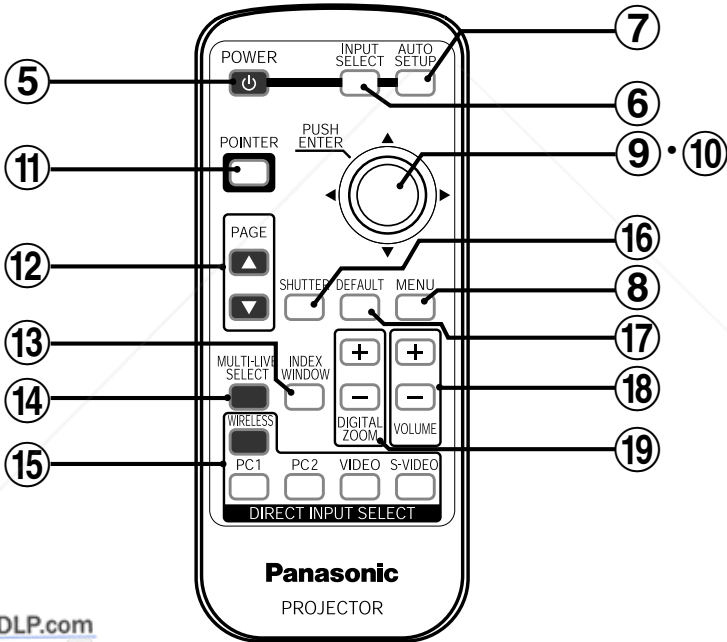

\*The illustration above is the remote control unit for the PT-LB60NTU.

\*The remote control unit for the PT-LB60U is not equipped with PAGE buttons, a MULTI-LIVE SELECT button or a WIRELESS button.

### ① PC INPUT indicator

This indicator illuminates when a signal is being input to the connector (PC 1 IN or PC 2 IN) selected using the input select buttons.

**② LAMP indicator** (page 58)

This indicator illuminates when it is time to replace the lamp unit. It flashes if a circuit abnormality is detected.

**③ TEMP indicator** (page 57)

This indicator illuminates if an abnormally high temperature is detected inside the projector or around it. If the temperature rises above a certain level, the power supply will be turned off automatically and the indicator will flash.

**④ Illumination sensor** (page 42)

This sensor detects the luminance when the “DAYLIGHT VIEW” function is operating. Do not cover the projector and do not place any object on the projector when using it.

**⑤ POWER button** (pages 26, 28 and 29)

This button is used to turn the power on and off. This button on the projector illuminates red when the projector is in standby mode, and it illuminates green when a picture starts to be projected.

**⑥ INPUT SELECT button** (pages 27 and 30)

This button is used to switch the input signals from the connected equipment.

**⑦ AUTO SETUP button** (pages 27 and 31)

If this button is pressed while a RGB signal is being projected, the position of the image and the settings for “DOT CLOCK” and “CLOCK PHASE” will be adjusted automatically.

**⑧ MENU button** (pages 36 and 38)

This button is used to display the menu screen. When a menu screen is being displayed, this button can be used to return to a previous screen or to clear the screen.

**⑨ Arrow (▲▼◀ and ▶) buttons** (page 38)

These buttons are used to select and adjust items in the on-screen menus.

**⑩ ENTER button** (page 38)

This button is used to accept and to activate items selected in the on-screen menus.

**⑪ POINTER button** (page 35)

This button is used to display a pointer on the projected images.

**⑫ PAGE buttons** (PT-LB60NTU only)

These buttons are used when the projector is controlled by means of a wireless network. Refer to the accessory CD-ROM for details.

**⑬ INDEX WINDOW button** (page 34)

This button can be used to split the image projection area into a still picture and a moving picture. You can also select this function from the on-screen menu (refer to page 53).

**⑭ MULTI-LIVE SELECT button** (PT-LB60NTU only)

This button is used when the projector is controlled by means of a wireless network. Refer to the accessory CD-ROM for details.

(continued on next page)



(continued from previous page)

⑮ **DIRECT INPUT SELECT buttons** (pages 27 and 30)

You can select the input signal directly by pushing these buttons (the WIRELESS button is for the PT-LB60NTU only).

⑯ **SHUTTER button** (page 32)

This button is used to momentarily turn off the picture and sound. You can also select this function from the on-screen menu (refer to page 53).

⑰ **DEFAULT button** (page 39)

This button is used to reset the projector adjustment values to the factory default settings.

⑱ **VOLUME +/- buttons** (page 32)

These buttons are used to adjust the volume of the sound that is output from the projector's built-in speaker and VARIABLE AUDIO OUT connector. Refer to page 52 for details on how to adjust the volume without using the remote control unit.

⑲ **DIGITAL ZOOM +/- buttons** (page 33)

These buttons are used to enlarge the projected image.

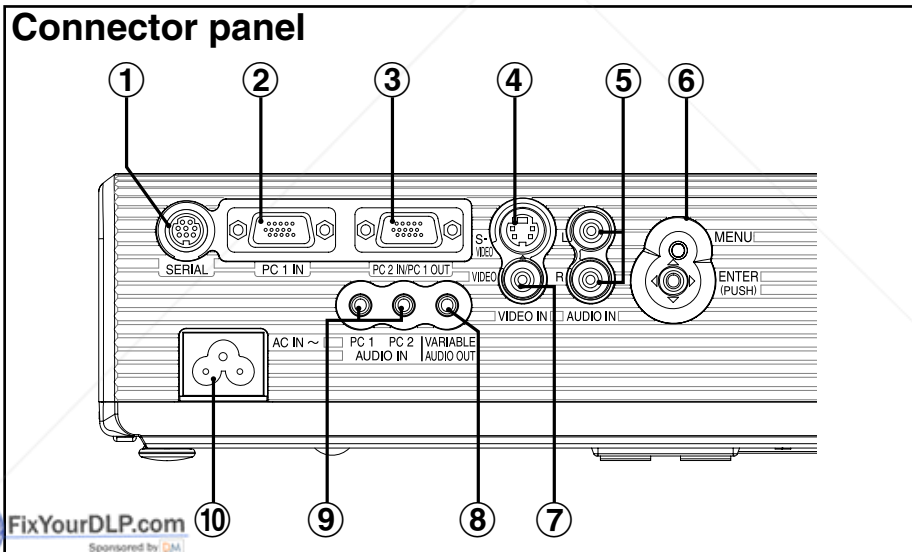

① **SERIAL connector** (pages 21, 22, 23 and 70)

This connector is used to connect a personal computer to the projector in order to control the projector externally. (RS-232C compatible)

② **PC 1 IN connector** (pages 21 and 22)

This connector is used to input RGB signals and YPbPr signals.

- ③ **PC 2 IN/PC 1 OUT connector** (pages 21, 22 and 50)  
This connector is used to input or output RGB signals and YPBPR signals. Adjust "PC2 SELECT" in the "OPTION" menu to select whether you want input or output with this connector.
- ④ **S-VIDEO IN connector** (pages 23 and 46)  
This connector is used to input signals from S-VIDEO-compatible equipment such as a DVD player. The connector is S1 signal compatible, and it automatically switches between 16:9 and 4:3 aspect ratios in accordance with the type of signal being input.
- ⑤ **AUDIO IN L-R connectors (for S-VIDEO/VIDEO)** (page 23)
- ⑥ **Menu operation** (page 14)
- ⑦ **VIDEO IN connector** (page 23)  
This connector is used to input video signals from video equipment such as a video deck.
- ⑧ **VARIABLE AUDIO OUT connector** (pages 21, 22, and 23)  
This connector is used to output the audio signals which are input to the projector. If audio equipment is connected to this connector, no sound will be output from the built-in speakers.
- ⑨ **PC 1/2 AUDIO IN connectors** (pages 21 and 22)  
These connectors are used to input audio signals, and they correspond to the PC 1 IN/PC 2 IN connectors respectively.
- ⑩ **Power input socket (AC IN)** (page 26)  
The accessory power cord is connected here.  
Do not use any power cord other than the accessory power cord.



**Discount-Merchant.com (800) 281-8860**  
**THE TRUSTED SOURCE FOR PROJECTOR LAMPS AND ACCESSORIES**

# Setting-up

## Projection methods

In way of installing projector, any one of the following four projection methods are used. Select whichever projection method matches the setting-up method. (The projection method can be set from the "OPTION" menu. Refer to page 52 for details.)

- Front-desk projection

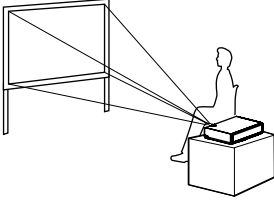

Menu item	Setting
INSTALLATION	FRONT/DESK

- Front-ceiling projection

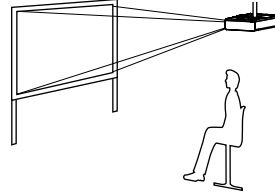

Menu item	Setting
INSTALLATION	FRONT/CEILING

- Rear-desk projection  
(Using a translucent screen)

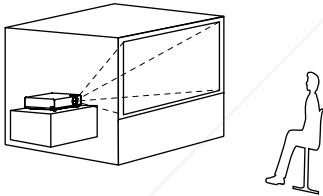

Menu item	Setting
INSTALLATION	REAR/DESK

- Rear-ceiling projection  
(Using a translucent screen)

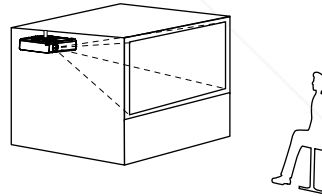

Menu item	Setting
INSTALLATION	REAR/CEILING

**NOTE:**

- You will need to purchase the separate ceiling bracket (ET-PKB30) when using the ceiling installation method.
- Do not set up the projector vertically or tilted horizontally, otherwise it may cause damage to the projector.
- Do not set up the projector in a place that is tilted at more than  $\pm 30^\circ$  vertically. Setting up the projector in places that are tilted at more than  $\pm 30^\circ$  vertically may shorten component life.

# Projector position

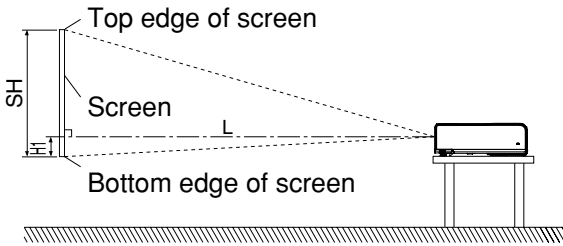

- L: Projection distance
- SH: Image height
- SW: Image width
- H1: Distance from center of lens to bottom edge of projected image

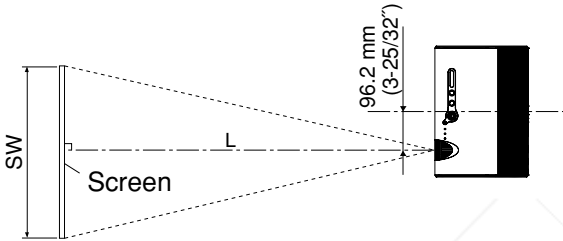

Getting started



**Discount-Merchant.com (800) 281-8860**  
THE TRUSTED SOURCE FOR PROJECTOR LAMPS AND ACCESSORIES

## Projection distances

4:3 Screen size (diagonal)	Projection distance (L)		Height position (H1)
	Wide (LW)	Telephoto (LT)	
0.84 m(33")	—	1.1 m(3'7")	0.07 m(2-3/4")
1.02 m(40")	1.2 m(3'11")	1.4 m(4'7")	0.08 m(3-1/8")
1.27 m(50")	1.5 m(4'11")	1.7 m(5'6")	0.11 m(4-5/16")
1.52 m(60")	1.8 m(5'10")	2.1 m(6'10")	0.13 m(5-3/32")
1.78 m(70")	2.1 m(6'10")	2.5 m(8'2")	0.15 m(5-7/8")
2.03 m(80")	2.4 m(7'10")	2.8 m(9'2")	0.17 m(6-11/16")
2.29 m(90")	2.7 m(8'10")	3.2 m(10'5")	0.19 m(7-15/32")
2.54 m(100")	3.0 m(9'10")	3.5 m(11'5")	0.21 m(8-1/4")
3.05 m(120")	3.6 m(11'9")	4.3 m(14'1")	0.25 m(9-13/16")
3.81 m(150")	4.6 m(15'1")	5.4 m(17'8")	0.32 m(12-19/32")
5.08 m(200")	6.1 m(20")	7.2 m(23'7")	0.42 m(16-17/32")
6.35 m(250")	7.6 m(24'11")	9.0 m(29'6")	0.53 m(20-27/32")
7.62 m(300")	9.1 m(29'10")	10.8 m(35'5")	0.63 m(24-25/32")

### NOTE:

- The dimensions in the table above are approximate.
- For details about projected image distances, refer to page 67.



**Discount-Merchant.com (800) 281-8860**  
**THE TRUSTED SOURCE FOR PROJECTOR LAMPS AND ACCESSORIES**

# Connections

## Notes on connections

- Read the instruction manual for each peripheral device carefully before connecting it.
- Turn off the power supply for all peripheral devices before making any connections.
- If the cables necessary for connection are not included with the peripheral device or available as an option, you may need to prepare a proper cable for the device concerned.
- If there is a lot of jitter in the video signal, the projected image may flicker. In such cases, it will be necessary to connect a TBC (time base corrector).
- Refer to the list on page 68 for details on compatible signals which can be input to the projector.
- Only one audio system circuit is available for the AUDIO IN L-R connectors, so if you change the audio input source, you will need to remove and insert the appropriate plugs.

## Connecting to computer

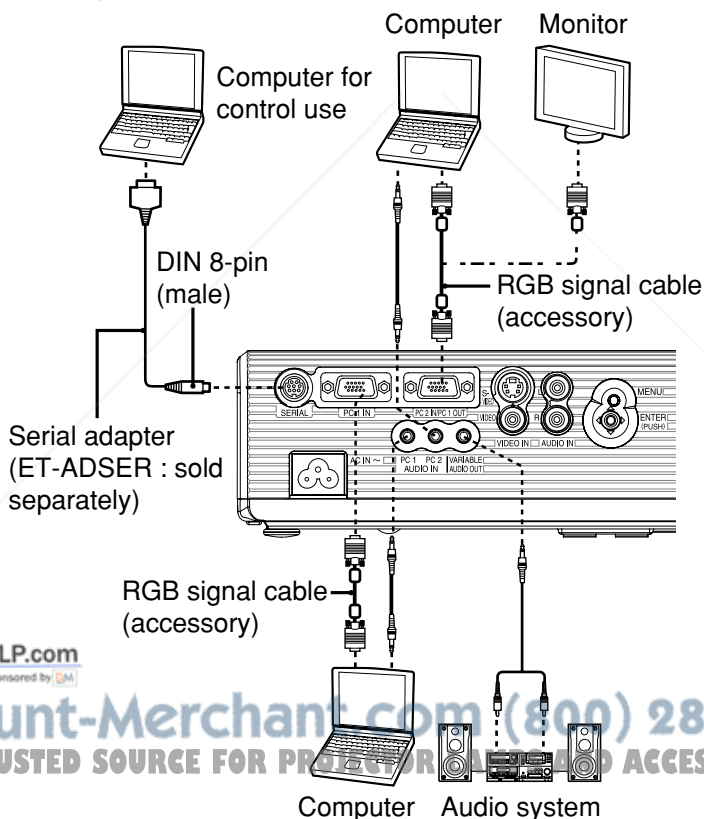

Refer to the accessory CD-ROM for details on the wireless network that can be used for controlling the projector with a personal computer. (PT-LB60NTU only)

# Connecting to video equipment (1)

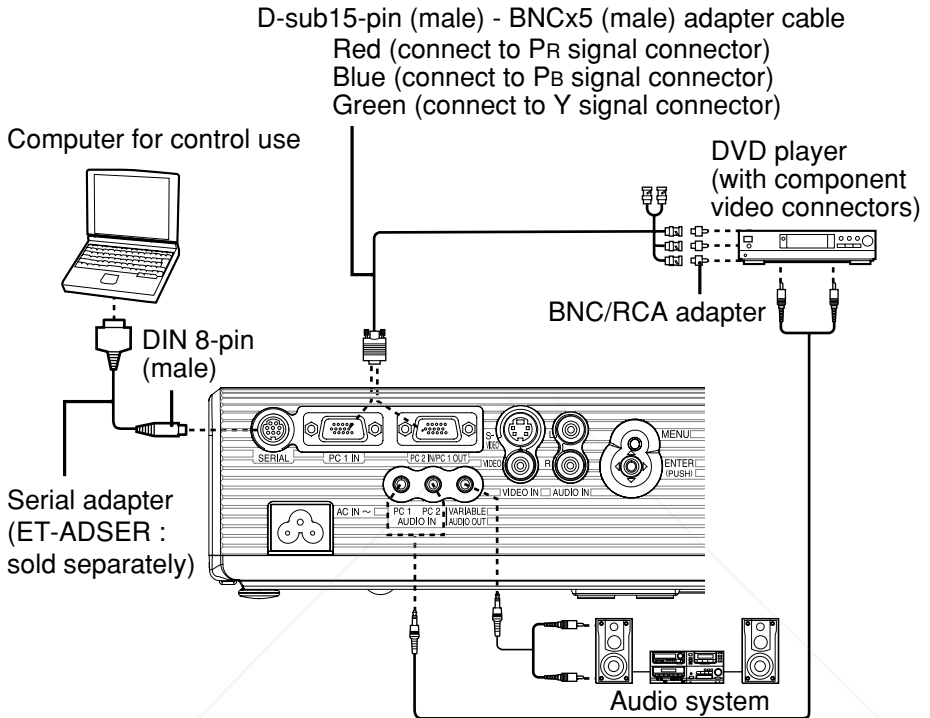

**NOTE:** DLP.com

Sponsored by

- Do not input the signal to the PC 2 IN/PC 1 OUT connector when “PC2 SELECT” in the “OPTION” menu is set to “OUTPUT”. (page 50)
- If the signal cables are disconnected or if the power supply for the computer or video deck is turned off while “DIGITAL ZOOM” or “INDEX WINDOW” is being used, these functions will be cancelled. (pages 33 and 34)

## Connecting to video equipment (2)

Computer for control use



Serial adapter  
(ET-ADSER :  
sold separately)  
DIN 8-pin  
(male)

DVD player

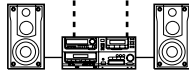
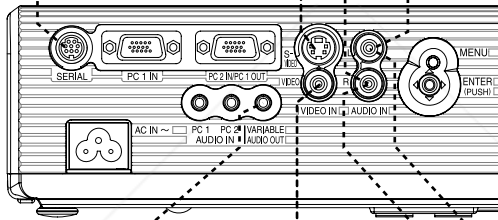
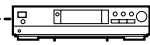

Audio system



Video deck

Getting started



**Discount-Merchant.com (800) 281-8860**  
THE TRUSTED SOURCE FOR PROJECTOR LAMPS AND ACCESSORIES



# Preparation for the remote control unit

- ① While pressing the tab, lift the battery cover to remove it.

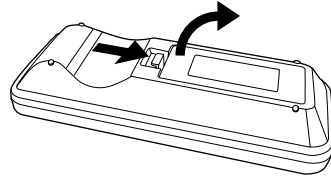

- ② Insert the batteries into the battery holder so that the polarities are correct.

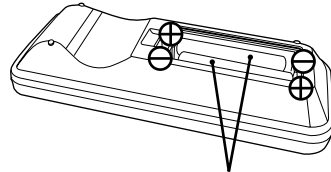

AAA batteries (two)

- ③ Replace the battery cover (a click will be heard).

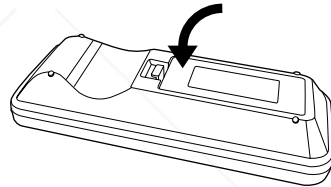

## NOTE:

- Do not drop the remote control unit.
- Keep the remote control unit away from liquids.
- Remove the batteries if not using the remote control unit for long periods.
- Do not use rechargeable batteries.
- If the remote control unit is held so that it is facing directly in front of the remote control signal receptor, the operating range is within approximately 7 m (23') from the surfaces of the receptor. Furthermore, the remote control unit can be operated from an angle of  $\pm 30^\circ$  to the left or right and  $\pm 15^\circ$  above or below the receptor.
- If the buttons on the remote control unit are kept pressed, the battery power will be consumed rapidly.
- If there are any obstacles in between the remote control unit and the receptor, the remote control unit may not operate correctly.
- If strong light is allowed to shine onto the remote control signal receptor, correct projector operation may not be possible. Place the projector as far away from light sources as possible.
- If facing the remote control unit toward the screen to operate the projector, the operating range of the remote control unit will be limited by the amount of light reflection loss caused by the characteristics of the screen used.



**Discount-Merchant.com (800) 281-8860**  
**THE TRUSTED SOURCE FOR PROJECTOR LAMPS AND ACCESSORIES**

# Turning on the power

## Before turning on the power

1. Ensure that all peripheral devices are connected properly.
2. Remove the lens cover.

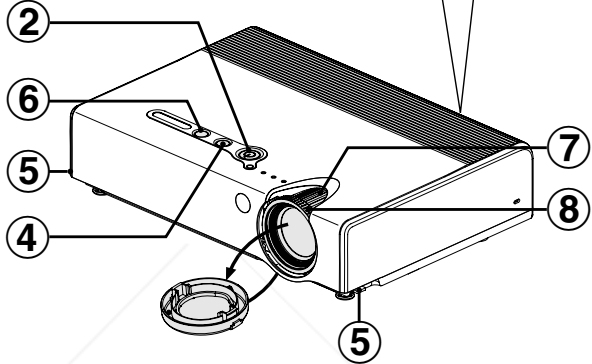
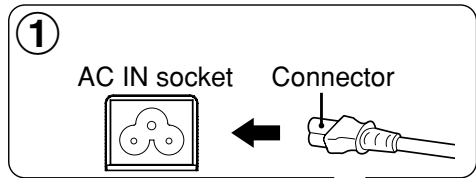
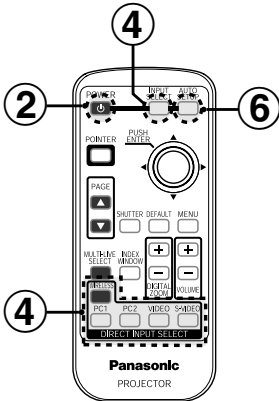

## 1 Connect the accessory power cord to the AC IN socket.

- Insert the connector into the AC IN socket so that the shape of the connector matches the shape of the socket. Then insert the power cord plug into the wall outlet.
- The POWER button on the projector will illuminate red.

## 2 Press the POWER button.

- The POWER button on the projector will flash green. After a short period, it will illuminate green, and the startup logo will be displayed. If you would like the startup logo not to be displayed, set "STARTUP LOGO" to "OFF". (Refer to page 49.)

## 3 Turn on the power of all connected devices.

- Start the play function of a device such as a DVD player.

### NOTE:

- A tinkling sound may be heard when the lamp unit is turned on, but this is not a sign of a malfunction.

## 4 Select the input signal by pressing the INPUT SELECT button or the DIRECT INPUT SELECT buttons.

- A picture will be projected in accordance with the selected input signal. (page 30)
- When “SIGNAL SEARCH” is set to “ON”, the projector detects which signals are being input, and uses these signals for projection.
- If no signal is detected, the guide screen for computer connection will be displayed (when “INPUT GUIDE” in the “OPTION” menu is set to “DETAILED”. Refer to page 69 for details).
- Press the INPUT SELECT button to finish the input signal search.

### Direct power on function

If “DIRECT POWER ON” in the “OPTION” menu is set to “ON”, projection will start after the power cord is connected. Refer to page 51 for details.

Follow the procedure below when you set the projector up first, and when you change the placement after original setup.

## 5 Adjusting the angle

- Place the projector so that it is vertical to the screen.
- While pressing the adjuster buttons, adjust the forward/back angle of tilt of the projector. Adjust so that the projected image is placed at the center of the screen.

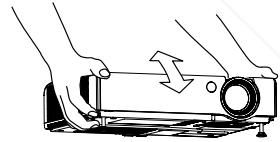

## 6 Press the AUTO SETUP button (when RGB signals are being input).

- Settings such as the position of the image will be corrected automatically. (page 31)



## 7 Adjusting the size

- Turn the zoom ring to adjust the size of the projected image.

## 8 Adjusting the focus

- Turn the focus ring to adjust the focus of the projected image.

# Turning off the power

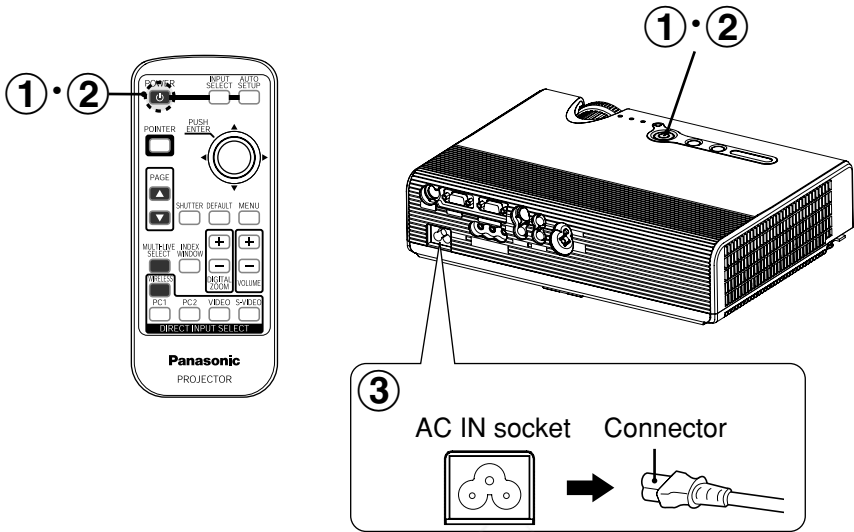

## 1 Press the POWER button.

- The “POWER OFF” confirmation screen will be displayed.

## 2 Press the POWER button again.

- The lamp unit will switch off and the picture will stop being projected.  
(The POWER button on the projector will illuminate orange while the cooling fan is still operating.)

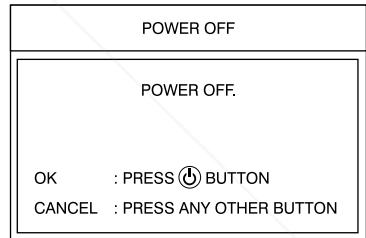

### NOTE:

- Press any button other than the POWER button to cancel the “POWER OFF” screen.
- The “POWER OFF” screen will disappear in 10 seconds.

## 3 Disconnect the power cord after the POWER button on the projector illuminates red.

- Disconnect the power cord plug from the wall outlet first, and then disconnect the connector from the AC IN socket.

### NOTE:

- You can also turn off the power by holding down the POWER button for at least 0.5 seconds.

### Direct power off function

You can disconnect the power cord during projection or immediately after use and move the projector. The cooling fan will operate by the internal power supply to cool down the lamp.

- When this function is used, it may take more time for the lamp to turn back on again compared to when the lamp cools down with the power cord connected.
- Do not put the projector in a bag while the POWER button on the projector is illuminated.

## CAUTION

**If not using the projector for an extended period of time, disconnect the power cord plug from the wall outlet.**

- If dust builds up on the power cord plug, the resulting humidity may damage the insulation, which could result in fire.
- This projector continues to draw approximately 3 W of power even when the power is turned off.

### POWER button on the projector

POWER button status		Projector status
Red	Illuminated	The projector is in standby mode and image projection is possible by pressing the POWER button.
Green	Flashing	The projector is preparing for projection after the power has been turned on while the POWER button on the projector is illuminated red. (After a short period, a picture will be projected.)
	Illuminated	A picture is being projected.
Orange	Illuminated	The lamp is cooling down after the power has been turned off or while direct power off function is operating.
	Flashing	The projector is preparing for projection after the power has been turned on while the POWER button on the projector is illuminated orange. (After a short period, a picture will be projected.)

# Selecting the input signal (INPUT SELECT/ DIRECT INPUT SELECT)

You can select the input signal by pressing the INPUT SELECT button or the DIRECT INPUT SELECT buttons.

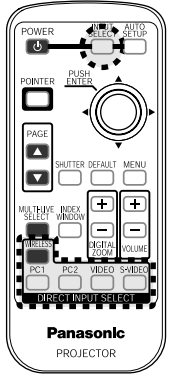

Projector control panel

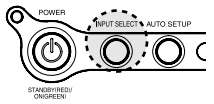

## Press the INPUT SELECT button.

- The input signal selected will change as shown below each time the INPUT SELECT button is pressed.

INPUT SELECT button		Changing signals
Control panel	INPUT SELECT	
Remote control unit	INPUT SELECT	

\* "WIRELESS" is for the PT-LB60NTU only.

## Press the DIRECT INPUT SELECT buttons.

- You can select the input signal directly.

DIRECT INPUT SELECT buttons		Changing signals
Remote control unit		The signal that is being input to the PC 1 IN connector will be projected.
		The signal that is being input to the PC 2 IN connector will be projected.
		The signal that is being input to the S-VIDEO IN connector will be projected.
		The signal that is being input to the VIDEO IN connector will be projected.
	*	The signal that is set by the wireless network will be projected. (page 56)

\* "WIRELESS" is for the PT-LB60NTU only.



Discount-Merchant.com (800) 251-8860  
THE TRUSTED SOURCE FOR PROJECTOR LAMPS AND ACCESSORIES

### NOTE:

- "PC2" cannot be selected when "PC2 SELECT" in the "OPTION" menu is set to "OUTPUT".

# Correcting the image position automatically (AUTO SETUP)

This projector can adjust the position of the image and the settings for “DOT CLOCK” and “CLOCK PHASE” when RGB signals are being input.

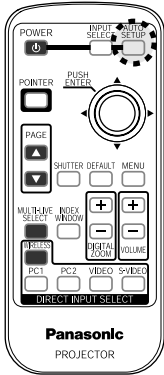

Projector control panel

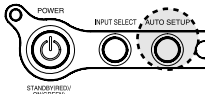

Press the **AUTO SETUP** button while RGB signals are being projected.

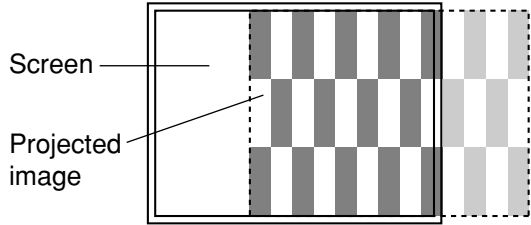

- Automatic positioning will be carried out.

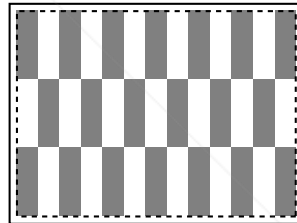

Useful functions

## NOTE:

- “SIGNAL SEARCH” will also be carried out. (When “SIGNAL SEARCH” is set to “ON”, refer to page 51 for details.)
- If the dot clock frequency is 100 MHz or higher, “DOT CLOCK”, and “CLOCK PHASE” will not be adjusted automatically. Refer to page 45 for details.
- If the edges of the projected image are indistinct, or if a dark picture is being projected, the automatic setup processing may stop automatically before it is complete. If this happens, project a different picture and then press the AUTO SETUP button again.



# Turning off the picture and sound momentarily (SHUTTER)

The “SHUTTER” function can be used to momentarily turn off the picture and sound from the projector when the projector is not being used for short periods of time, such as during breaks in meetings or when carrying out preparation. The projector uses less power in “SHUTTER” mode than it does in normal projection mode.

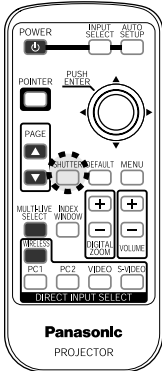

## Press the SHUTTER button.

- The picture and sound will be turned off.
- Press any button on either the projector or remote control unit to return to normal operating mode.

### NOTE:

- You can also select “SHUTTER” from the on-screen menu (refer to page 53).

# Adjusting the volume (VOLUME)

You can adjust the volume of the sound that is output from the projector’s built-in speaker and VARIABLE AUDIO OUT connector.



## Press the VOLUME +/- button.

- Press the + button to raise the volume.
- Press the - button to lower the volume.

### NOTE:

- You can also select “VOLUME” from the on-screen menu (refer to page 52).

# Enlarging the picture (DIGITAL ZOOM)

You can enlarge the projected image and move the enlarged area.

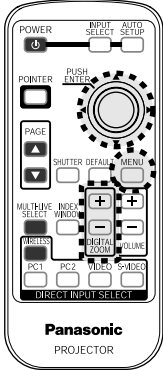

## Press the DIGITAL ZOOM +/- button.

- The picture will then be enlarged to 1.5 times the normal size.
- Press the MENU button to return to the normal screen.

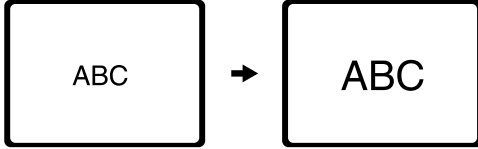

Menu operation  
(on connector panel)

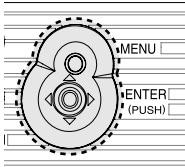

## Button functions when using “DIGITAL ZOOM”

+ button The enlargement ratio will increase.

- button The enlargement ratio will decrease.



▲ ▼ buttons The displayed position will move upward or downward.

◀ ▶ buttons The displayed position will move to the left or right.

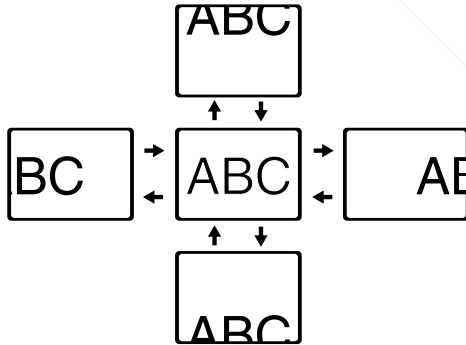

Useful functions



## NOTE:

- The enlargement ratio can be changed within the range of 1x to 2x, in steps of 0.1. When RGB signals are being input, the enlargement ratio can be changed within the range of 1x to 3x, except when the “FRAME LOCK” is set to “ON” (page 47).
- If the type of signal being input changes while the digital zoom function is being used, the digital zoom function will be cancelled.

# Displaying two screens (INDEX WINDOW)

This function lets you store a picture which is being projected into memory, so that you can display a still picture and a moving picture on the screen.

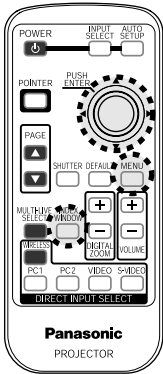

Menu operation  
(on connector panel)

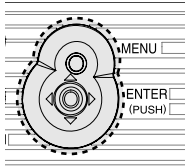

**Press the INDEX WINDOW button.**

- The current moving picture will be captured in a still window.
- Press the MENU button to return to the previous screen.

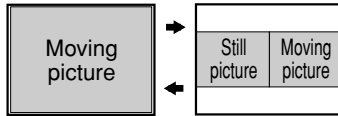

## Button functions when using “INDEX WINDOW”

**Press the ▲ or ▼ button to select a screen size.**

It can switch to three stages.

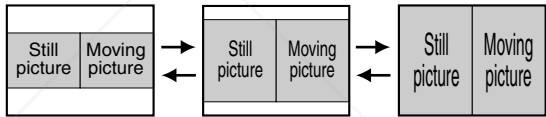

**Press the ◀ or ▶ button to switch between the still picture screen and moving picture screen.**

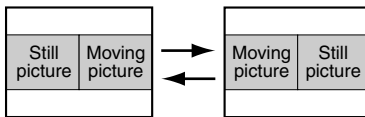

**Press the ENTER button to capture the present moving picture in a still window.**

FixYourDLP.com  
Sponsored by DLP

### NOTE:

- The aspect ratio of the screen changes and the image is vertically elongated in comparison to a normal image.
- When the screen size is changed, the picture's aspect ratio will also change. Make sure that you fully understand the notes on “ASPECT” on page 47 before using the “INDEX WINDOW” function.
- You can also select “INDEX WINDOW” from the on-screen menu (refer to page 53).

# Displaying the pointer (POINTER)

You can display the pointer on the projected images.

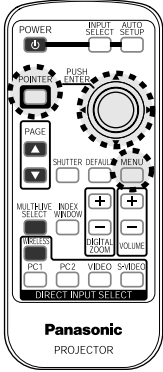

Menu operation  
(on connector panel)

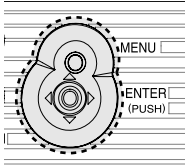

**Press the POINTER button.**

- A pointer will be displayed in the middle of the projected image.
- Press the POINTER button to cancel the pointer display.

## Moving the pointer

Press the ▲▼◀▶ buttons to move the pointer.

<Remote control unit>

The pointer will move in 8 directions as shown below.

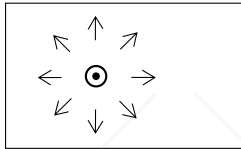

<Projector control panel>

The pointer will move in 4 directions as shown below.

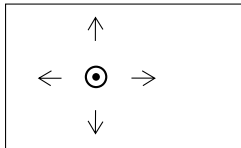

You can select the pointer in "POINTER SELECT" from 3 types (refer to page 50).

Pointer1



Pointer2



Pointer3



## NOTE:

- The pointer cannot be displayed when a menu screen is being displayed.

# On-screen menus

## Menu screens

The various settings and adjustments for this projector can be carried out by selecting the operations from on-screen menus.

The general arrangement of these menus is shown below.

### Menu Screen

(When a VIDEO signal is being input)

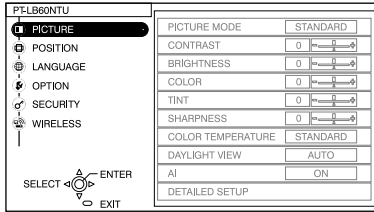

- Press the MENU button to display the menu screen. Refer to page 38 for details on how to operate the on-screen menus.
- The illustrations of the on-screen menus in this operating instructions are for the PT-LB60NTU.

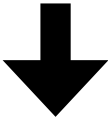

### PICTURE menu (page 40)

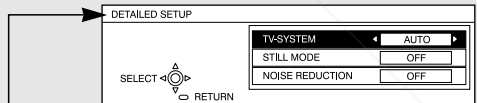
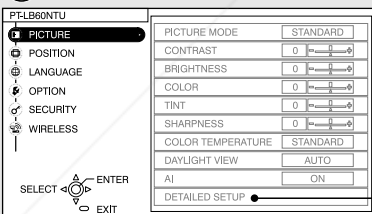

### POSITION menu (page 44)

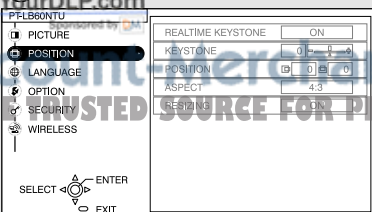

**LANGUAGE menu (page 48)**

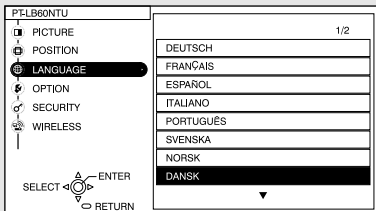

**SECURITY menu (page 54)**

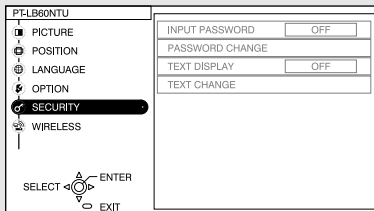

**WIRELESS menu (page 56)  
(PT-LB60NTU only)**

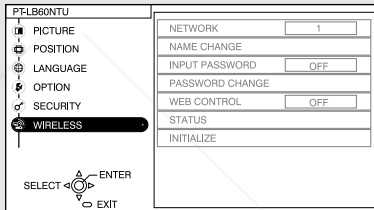

**OPTION menu (page 49)**

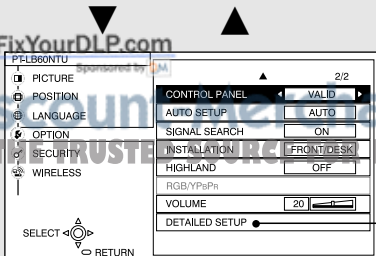
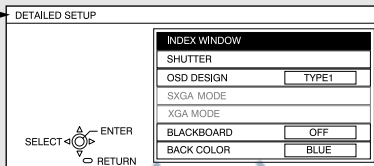
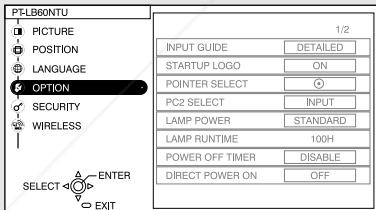

FixYourDLP.com  
 Disruptive.com (800) 281-8860  
 THE TRUSTED SOURCE FOR PROJECTOR LAMPS AND ACCESSORIES

# Menu operation guide

## ① Press the MENU button.

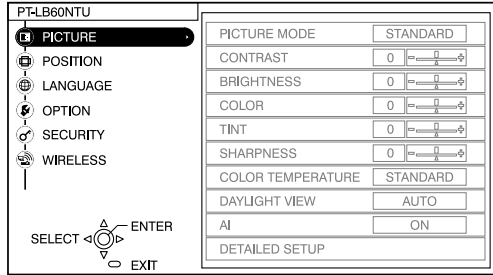
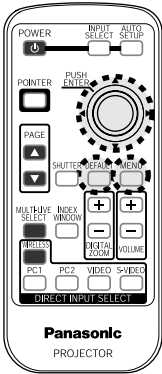

The menu screen will be displayed.

Menu operation  
(on connector panel)

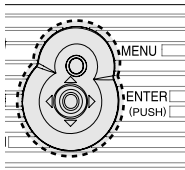

## ② Press the ▲ or ▼ button to select an item from the main menu on the left side.

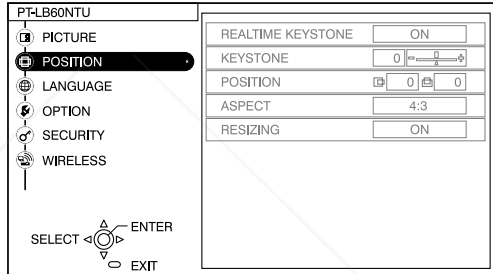

The selected item will be displayed in orange.

The sub-menu for the selected item will be displayed on the right side.

## ③ Press the ENTER button.

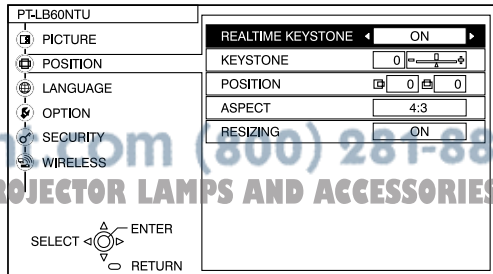

You can select an item from the sub-menu.



Discount-Merch.com (800) 281-8860  
THE TRUSTED SOURCE FOR PROJECTOR LAMPS AND ACCESSORIES

### NOTE:

- Press the MENU button to return to the previous screen.

- ④ Press the ▲ or ▼ button to select an item, and then press the ◀ or ▶ button to adjust the value or change the setting.

If adjusting the items in the “PICTURE” and “POSITION” menus, the menu screen will disappear and only the selected item will be displayed.

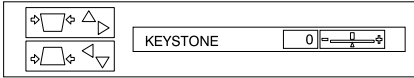

The value and setting indicator will turn green when any adjustment changes from the factory set value. For items without any selective setting or bar scale, press the ENTER button. The next screen for the item will then be displayed.

## Unavailable on-screen menu items

This projector has unadjustable items and unusable functions depending on the signal being input.

If an item cannot be adjusted or a function cannot be used, you cannot select the corresponding item.

## Returning a setting to the factory default

If you press the DEFAULT button on the remote control unit, you can return settings to the factory default settings. However, the operation of this function varies depending on which screen is being displayed.

### ● When a menu screen is being displayed

All the items on the sub-menu which is being displayed will be returned to their factory default settings, and the value and setting indicator will appear white.

### ● When an individual adjustment screen is being displayed

Only the item displayed will be returned to the factory default setting, and the value and setting indicator will appear white.



### FiNOTE!P.com

- A triangle symbol below a bar scale indicates the factory default setting. Items which do not have this triangle symbol cannot be returned to the factory default setting. The positions of the triangle symbols vary depending on the type of signal being input.

Indicates the current adjustment value



Indicates the standard factory default setting



# Adjusting the picture

- ① Press the MENU button to display the menu screen.
- ② Select the "PICTURE" menu from the main menu, and then press the ENTER button.
- ③ Press the ▲ or ▼ button to select an item.
- ④ Press the ◀ or ▶ button to adjust the value or change the setting. For items with selective setting or a bar scale, the individual adjustment screen will be displayed. For "DETAILED SETUP", press the ENTER button to display the next screen.

When an S-VIDEO/VIDEO signal is being input

PICTURE MODE	STANDARD
CONTRAST	0
BRIGHTNESS	0
COLOR	0
TINT	0
SHARPNESS	0
COLOR TEMPERATURE	STANDARD
DAYLIGHT VIEW	AUTO
AI	ON
DETAILED SETUP	

When an YPBPR signal is being input

PICTURE MODE	STANDARD
CONTRAST	0
BRIGHTNESS	0
COLOR	0
TINT	0
SHARPNESS	0
COLOR TEMPERATURE	STANDARD
DAYLIGHT VIEW	AUTO
AI	ON

When an RGB signal is being input

PICTURE MODE	DYNAMIC
CONTRAST	0
BRIGHTNESS	0
SHARPNESS	0
COLOR TEMPERATURE	STANDARD
DAYLIGHT VIEW	AUTO
AI	ON
DETAILED SETUP	

When WIRELESS is selected

PICTURE MODE	DYNAMIC
CONTRAST	0
BRIGHTNESS	0
SHARPNESS	0
COLOR TEMPERATURE	STANDARD
DAYLIGHT VIEW	AUTO
AI	ON

## PICTURE MODE

When an S-VIDEO/VIDEO/YPbPr signal is being input

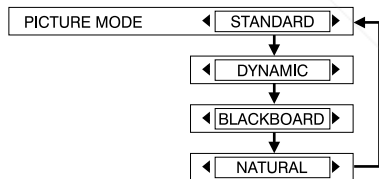

When an RGB signal is being input or WIRELESS is selected

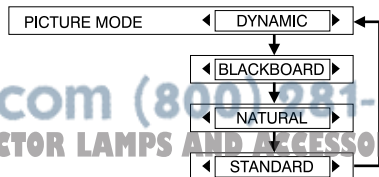

Select the picture mode that best matches the image source and room conditions.

The mode best used in dark rooms is "NATURAL". For rooms having regular lighting conditions in use, select "STANDARD". For exceptionally bright rooms, use "DYNAMIC".

"BLACKBOARD" is available only when "BLACKBOARD" in the "OPTION" menu is set to "ON". Select "BLACKBOARD" when projecting onto blackboards.

## CONTRAST

This adjusts the contrast of the picture. (Adjust the "BRIGHTNESS" setting first if required before adjusting the "CONTRAST" setting.)

The picture is bright: ◀ button

The picture is dark: ▶ button

## BRIGHTNESS

This adjusts the darker areas (black areas) in the picture.

Black areas are too light: ◀ button

Dark areas are too solid: ▶ button

## COLOR

(S-VIDEO/VIDEO/YPBPR only)

The color is too deep: ◀ button

The color is too pale: ▶ button

## TINT

(NTSC/NTSC 4.43/YPBPR only)

This adjusts the flesh tones in the picture.

The flesh tones are greenish:

◀ button

The flesh tones are reddish:

▶ button

## SHARPNESS

To soften the picture details:

◀ button

To sharpen the picture details:

▶ button

## COLOR TEMPERATURE

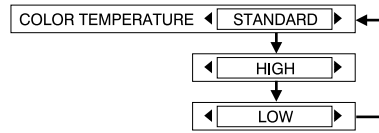

This is used to adjust the white areas of the picture if they appear bluish or reddish.

Normally "STANDARD" should be selected. If the white areas of the pictures appear reddish, set to "HIGH". If the white areas of the pictures appear bluish, set to "LOW".

### Projecting sRGB-compatible pictures

sRGB is an international color reproduction standard (IEC61966-2-1) established by the International Electrotechnical Commission (IEC). If you would like the colors in sRGB-compatible pictures to be reproduced more faithfully, make the following settings.

- 1 Press the ▲ or ▼ button to select "PICTURE MODE", and then press the ◀ or ▶ button to select "NATURAL".
- 2 Press the DEFAULT button on the remote control unit.
- 3 Press the ▲ or ▼ button to select "COLOR TEMPERATURE", and then press the ◀ or ▶ button to select "STANDARD".

**NOTE:**

- sRGB is only enabled when RGB signals are being input (when “LAMP POWER” is set to “STANDARD”, “AI” is set to “OFF”, and “DAYLIGHT VIEW” is set to “OFF”).

## DAYLIGHT VIEW



This adjusts the vividness of the projected images when the projector is used under bright lighting.

### AUTO

The vividness of the projected images will be adjusted according to the lighting condition of the room.

### OFF

“DAYLIGHT VIEW” is disabled.

**NOTE:**

- “AUTO” may not function correctly if any objects are placed on the projector.
- “AUTO” will be disabled when “INSTALLATION” in the “OPTION” menu is set to “REAR/DESK” or “REAR/CEILING”.

## AI

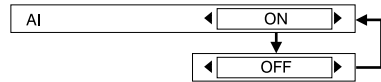

### ON

The lamp is controlled according to the input signals to project images with the best quality.

### OFF

“AI” is disabled.

**NOTE:**

- “AI” is disabled when “LAMP POWER” is set to “ECO-MODE”. (Refer to page 50.)

## DETAILED SETUP

You can adjust the picture quality of the projected images in detail. Press the ENTER button to display the “DETAILED SETUP” menu.

## WHITE BALANCE RED/GREEN/BLUE

(RGB only)

WHITE BALANCE RED	0	
WHITE BALANCE GREEN	0	
WHITE BALANCE BLUE	0	

This is used to adjust the white areas of the picture if they appear colorised.

To make the selected color lighter:

◀ button

To make the selected color stronger:

▶ button



**Discount-Merchant.com (800) 281-8860**

**THE TRUSTED SOURCE FOR PROJECTOR LAMPS AND ACCESSORIES**

## TV-SYSTEM

(S-VIDEO/VIDEO only)

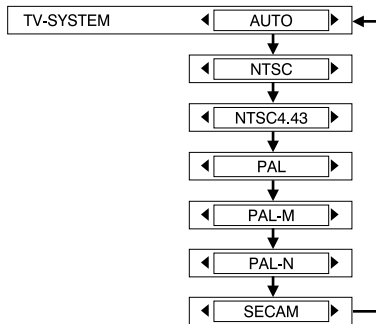

This should normally be set to "AUTO". If the signal is of such poor quality that the correct format cannot be automatically distinguished, change the setting manually to the required TV system.

### NOTE:

- When set to "AUTO", the projector automatically distinguishes between NTSC/NTSC 4.43/PAL/PAL60/PAL-M/PAL-N/SECAM signals.

## STILL MODE

(S-VIDEO/VIDEO only)

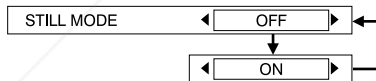

To reduce flickering of still images (vertical flicker), set "STILL MODE" to "ON".

### NOTE:

- Set to "OFF" when playing back moving images.

## NOISE REDUCTION

(S-VIDEO/VIDEO only)

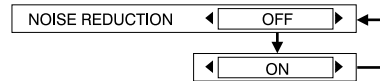

If the signal is of such poor quality that picture interference appears, set "NOISE REDUCTION" to "ON". To turn off the "NOISE REDUCTION" feature, set to "OFF".

# Adjusting the position

- ① Press the MENU button to display the menu screen.
- ② Select the “POSITION” menu from the main menu, and then press the ENTER button.
- ③ Press the ▲ or ▼ button to select an item. (When RGB signals are being input, first press the AUTO SETUP button to initiate automatic positioning. If the optimum setting is not obtained when “AUTO SETUP” is carried out, adjust the items manually.)
- ④ Press the ◀ or ▶ button to adjust the value or change the setting. For items with selective setting or a bar scale, the individual adjustment screen will be displayed.

When an S-VIDEO/VIDEO signal is being input

REALTIME KEYSTONE	ON
KEYSTONE	0
POSITION	0 0
ASPECT	4:3
RESIZING	ON

When an RGB/YPbPr signal is being input

REALTIME KEYSTONE	ON
KEYSTONE	0
POSITION	0 0
DOT CLOCK	0
CLOCK PHASE	0
ASPECT	4:3
RESIZING	ON
FRAME LOCK	OFF

When WIRELESS is selected

REALTIME KEYSTONE	ON
KEYSTONE	0

## REALTIME KEYSTONE

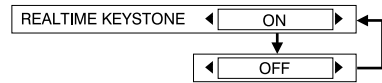

This projector detects its own degree of tilt and corrects the keystone distortion automatically.

### ON

“REALTIME KEYSTONE” is enabled.

### OFF

“REALTIME KEYSTONE” is disabled.

## KEYSTONE

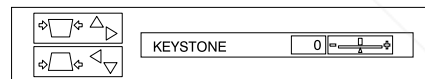

This projector detects its own degree of tilt and corrects the keystone distortion automatically (“REALTIME KEYSTONE”).

However, keystone distortion may still affect the images in some cases (e.g. when the projector is tilted slightly and the tilt is corrected slowly by hand or when the screen itself is tilted). In such cases, set “REALTIME KEYSTONE” to “OFF” and correct the vertical keystone distortion manually.

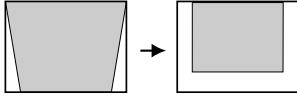
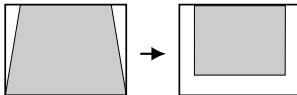
<b>Picture condition</b>	
<b>Operation</b>	Press the ▲ or ► button.
<b>Picture condition</b>	
<b>Operation</b>	Press the ▼ or ◀ button.

#### NOTE:

- Vertical keystone distortion can be corrected to  $\pm 30^\circ$  of the angle of tilt. However, the greater the correction amount, the more the picture quality will deteriorate, and the harder it will become to achieve a good level of focus. To obtain the best picture quality, set up the projector and screen in such a way that the amount of keystone correction required is as minimal as possible.
- The picture size will also change when correction of keystone distortion is carried out.
- The ratio of length and width of an image may become incorrect depending on the amount of the keystone correction.
- Keystone distortion of the on-screen display will not be corrected.
- You can correct the keystone distortion manually when "REALTIME KEYSTONE" is set to "ON". However, when you turn on the power, the amount of correction will be reset and "REALTIME KEYSTONE" will function again if the tilt is different from the last time you used the projector. If you correct the keystone distortion manually when "REALTIME KEYSTONE" is set to "OFF", the amount of correction

will be stored by the projector even after the power is turned off.

## POSITION

(S-VIDEO/VIDEO/RGB/YPbPr only)

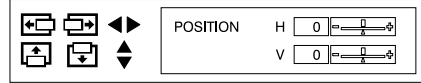

Moves the picture position.

Press the ENTER button to display the "POSITION" screen.

Press the ◀ or ► button to move the picture horizontally.

Press the ▲ or ▼ button to move the picture vertically.

## DOT CLOCK

(RGB only)

Periodic striped pattern interference (noise) may occur when a striped pattern such as the one below is projected. If this happens, press the ◀ or ► button to adjust so that any such noise is minimised.

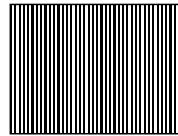

## CLOCK PHASE

(RGB/YPbPr only)

Adjust the "DOT CLOCK" setting first before carrying out this adjustment. Press the ◀ or ► button to adjust so that the noise level is least noticeable.

#### NOTE:

- If signals with a dot clock frequency of 100 MHz or higher are being input, interference may not be completely eliminated when the "DOT

"CLOCK" and "CLOCK PHASE" adjustments are carried out.

## ASPECT

(S-VIDEO/VIDEO/480i, 576i, 480p and 576p YPBPR only)

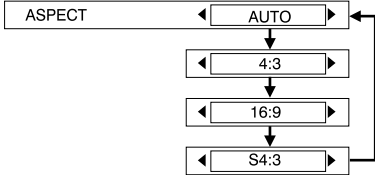

### AUTO

(S-VIDEO only)

When an S1 video signal is being input, the aspect ratio is changed automatically to project a 16:9 picture.

### 4:3

The input signal is projected without change.

### 16:9

The picture is compressed to a ratio of 16:9 and projected.

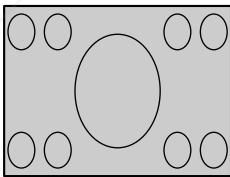

When a horizontally squeezed signal is being input.

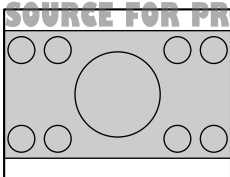

### S4:3

The size of the input signal is compressed to 75% and projected. (This is useful for projecting a picture with a 4:3 aspect ratio onto a 16:9 screen.)

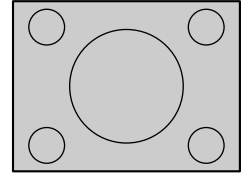

When a 4:3 signal is being input.

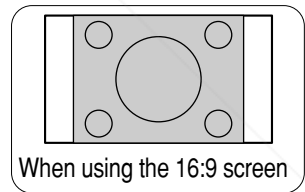
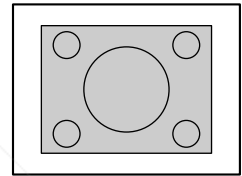

When using the 16:9 screen

### S1 video signals

- S1 video signals are a type of video signal with an aspect ratio of 16:9 which include a detector signal. This detector signal is output by some sources such as wide-vision video decks.
- When "ASPECT" is set to "AUTO", the projector recognizes the detector signal and automatically switches the aspect ratio to 16:9.

## NOTE:

- If using this projector in places such as cafes or hotels to display programmes for a commercial purpose or for public presentation, note that if the aspect ratio (16:9) selection function is used to change the aspect ratio of the screen picture, you may be infringing the rights of the original copyright owner for that programme under copyright protection laws.
- If a 4:3 picture is projected onto a 16:9 screen, distortion may occur around the edges of the picture so that part of the picture is no longer visible. Programmes which have 4:3 aspect ratios should be viewed in 4:3 mode to give proper consideration to the aims and intentions of the original programme's creator.

## RESIZING

(S-VIDEO/VIDEO/RGB/YPbPr only)



This should normally be set to “ON”. (This setting is only for signals which have lower resolutions than the LCD panels. Refer to page 68 for details.)

### ON

The pixel resolution of the input signal is converted to the same resolution as the LCD panels before being projected.

This may sometimes cause problems with the quality of the picture.

### OFF

The input signal is projected at its original resolution, with no pixel conversion. The projected picture will be smaller than normal, so adjust the zoom setting or move the projector forwards or backwards to adjust the picture size if necessary. If set to “OFF”, some features, such as “DIGITAL ZOOM”, “REALTIME KEYSTONE”, “KEYSTONE” or “INDEX WINDOW” will not function.

## FRAME LOCK

(RGB only)



If the picture's condition is bad while an RGB moving picture is projected, set “FRAME LOCK” to “ON”. Refer to page 68 for compatible RGB signals.



# Changing the display language

- ① Press the MENU button to display the menu screen.
- ② Select the “LANGUAGE” menu from the main menu, and then press the ENTER button.
- ③ Press the ▲ or ▼ button to select a language, and then press the ENTER button.

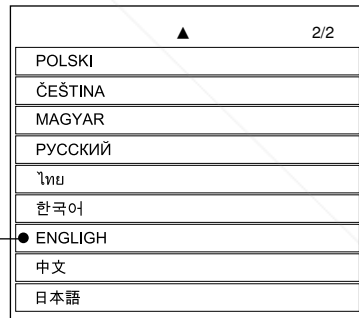
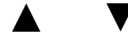
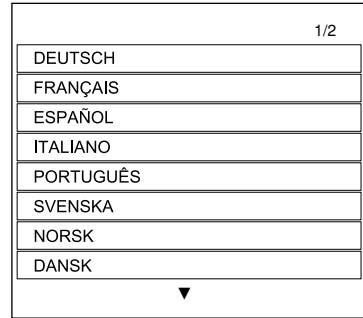

Indicates the language which is currently set

# Option settings

- ① Press the MENU button to display the menu screen.
- ② Select the “OPTION” menu from the main menu, and then press the ENTER button.
- ③ Press the ▲ or ▼ button to select an item.
- ④ Press the ◀ or ▶ button to change the setting. For “DETAILED SETUP”, press the ENTER button to display the next screen.

1/2	
INPUT GUIDE	DETAILED
STARTUP LOGO	ON
POINTER SELECT	○
PC2 SELECT	INPUT
LAMP POWER	STANDARD
LAMP RUNTIME	100H
POWER OFF TIMER	DISABLE
DIRECT POWER ON	OFF
▼	



2/2	
CONTROL PANEL	VALID
AUTO SETUP	AUTO
SIGNAL SEARCH	ON
INSTALLATION	FRONT/DESK
HIGHLAND	OFF
RGB/YPbPr	AUTO
VOLUME	20
DETAILED SETUP	

## INPUT GUIDE

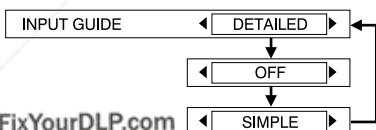

When the input signal is changed, the input signal information will be displayed in the upper right corner of the projected images. You can select the level of the input signal information.

## DETAILED

The input signal information will be displayed in detail.

## OFF

The input signal information will not be displayed.

## SIMPLE

Only the name of the input signal will be displayed.

### NOTE:

- If “INPUT GUIDE” is set to “DETAILED”, the guide screen for computer connection will be displayed when PC1 or PC2 is selected and no signal is being input to the PC 1 IN or PC 2 IN connector. If you would like the guide screen not to be displayed, set “INPUT GUIDE” to “SIMPLE” or “OFF”.

## STARTUP LOGO

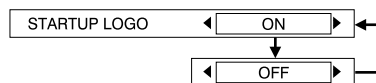

## ON

The “Panasonic” logo will be displayed when the power is turned on.

## OFF

The “Panasonic” logo will not be displayed when the power is turned on.

## POINTER SELECT

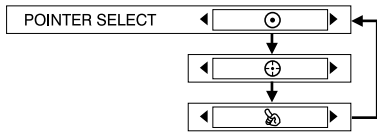

If you press the POINTER button on the remote control unit, the pointer will be displayed. You can select the pointer from 3 types as shown below (refer to page 35).

- 〔 ⊙ 〕 A double circle will be displayed.
- 〔 ⊕ 〕 A circle with a cross will be displayed.
- 〔 手 〕 A hand will be displayed.

## PC2 SELECT



This setting is used to select the function of the PC 2 IN/PC 1 OUT connector. When set to “INPUT”, it is set to the PC 2 IN connector. When set to “OUTPUT”, it is set to the PC 1 OUT connector.

## LAMP POWER

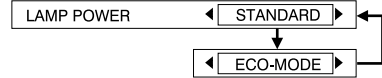

This setting changes the lamp brightness. When set to “ECO-MODE”, the luminance of the lamp is reduced, but the projector uses less power, and the operating noise is also reduced. This can help to extend the lamp’s operating life. If using the projector in small rooms where high luminance is not required, it is recommended that you set the “LAMP POWER” to “ECO-MODE”.

### NOTE:

- “LAMP POWER” cannot be set when no signal is being input.

## LAMP RUNTIME

This setting displays the usage time for the lamp unit which is currently being used. When replacing the lamp unit, follow the instructions on page 61, and reset “LAMP RUNTIME” to “0”.

### NOTE:

- The lamp’s operating life varies depending on the usage conditions (such as the “LAMP POWER” setting and the number of times the power is turned on and off).

## POWER OFF TIMER

If no signal is input to the projector for the duration of the period you set, the projector will return to standby mode. The period can be set from 15 minutes to 60 minutes in 5 minute intervals. If you don't use this feature, set it to "DISABLE".

## DIRECT POWER ON

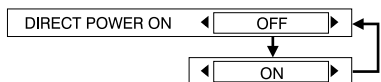

This sets the projector's start up status for when the power cord is connected.

### OFF

The projector will start from the same status as when the power cord was disconnected. If the power cord was disconnected during projection when the projector was used the last time, projection will start after the power cord is connected.

### ON

The projection will start after the mains lead is connected.

## CONTROL PANEL



To disable the buttons on the projector, set "CONTROL PANEL" to "INVALID". A confirmation screen will then be displayed. Select "OK" by using ◀ or ▶ button. To use the buttons on the projector, set to "VALID" by using the remote control unit.

## AUTO SETUP



This should normally be set to "AUTO".

### AUTO

"AUTO SETUP" will be carried out when the input signal is changed to RGB.

### BUTTON

"AUTO SETUP" will function only when you press the AUTO SETUP button.

## SIGNAL SEARCH



This should normally be set to "ON".

### ON

When the power is turned on and "AUTO SETUP" is running, the projector detects which signals are being input, and uses these signals for projection.

(If a picture is being projected, the signal source is not automatically changed.)

### OFF

Use this setting when you do not want the signal source to be changed automatically when the power is turned on and "AUTO SETUP" is running.

## INSTALLATION

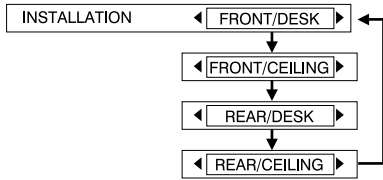

This setting should be changed in accordance with the projector setting-up method. (Refer to page 18.)

### FRONT/DESK

When the projector is placed on a desk or similar in front of a screen.

### FRONT/CEILING

When the projector is placed in front of a screen and suspended from a ceiling using a ceiling bracket (sold separately).

### REAR/DESK

When using a translucent screen and the projector is placed on a desk or similar.

### REAR/CEILING

When using a translucent screen and the projector is suspended from a ceiling using a ceiling bracket (sold separately).

## HIGHLAND

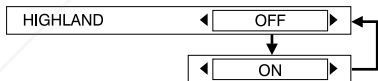

Set "HIGHLAND" to "ON", when using this projector at high elevations (above 1 400 m) only.

## RGB/YPbPr

(480i, 576i, 480p, 576p, 1 080/60i, 1 080/50i, 720/60p and VGA480 signals only)

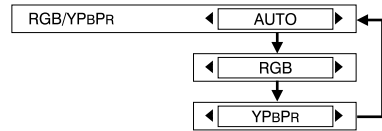

This sets the signal that is input to the PC 1 IN and PC 2 IN/PC 1 OUT connector.

Normally "AUTO" should be selected. RGB or YPbPr is selected automatically depending on the synchronising signal status. If an image is not projected correctly, select "RGB" or "YPbPr" in accordance with the input signal.

## VOLUME

You can adjust the volume of the sound that is output from the projector's built-in speaker and VARIABLE AUDIO OUT connector.

## DETAILED SETUP

Press the ENTER button to display the "DETAILED SETUP" menu.

### INDEX WINDOW

This functions in the same way as the "INDEX WINDOW" button on the remote control unit. Refer to page 34 for details.

### SHUTTER

This functions in the same way as the "SHUTTER" button on the remote control unit. Refer to page 32 for details.

### OSD DESIGN

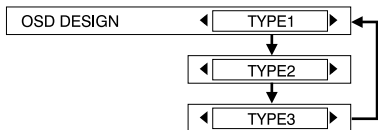

You can select the background for the OSD from 3 types.

#### TYPE1

Transparent black

#### TYPE2

Solid blue

#### TYPE3

Transparent navy blue

### SXGA MODE

[RGB(SXGA) only]



Adjust this item if the projected image overflows from the screen when an SXGA signal is being input.

#### SXGA

Select this item normally.

#### SXGA+

When the edges of the projected

image are not visible, select this item.

### XGA MODE

[RGB(XGA) only]

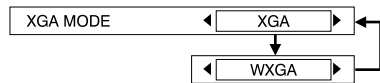

Adjust this item if the projected image overflows from the screen when an XGA signal is being input.

#### XGA

Select this item normally.

#### WXGA

Select this item when the edges of the projected image are not visible or the projected image is vertically elongated.

### BLACKBOARD

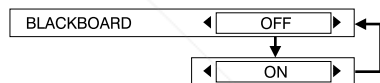

Set to "ON" when "PICTURE MODE" is set to "BLACKBORD". (Refer to page 40.)

### BACK COLOR

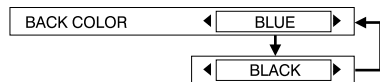

This sets the color which is projected onto the screen when no signal is being input to the projector.

# Setting up the security function

This projector is equipped with a security function. A password input screen can be displayed, or a company URL can be set up and displayed at the bottom of the projected image.

- 1 Press the **MENU** button to display the menu screen.
- 2 Select the **“SECURITY”** menu from the main menu, and then press the **ENTER** button.

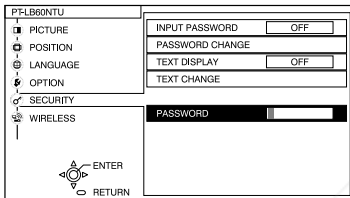
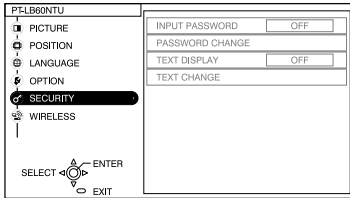

(When you use the “SECURITY” function for the first time)

Press the ▲, ►, ▼, ◀, ▲, ►, ▼ and ◀ buttons in order, then press the ENTER button.

(When a password change has been made before)

Type in the changed password, then press the ENTER button.

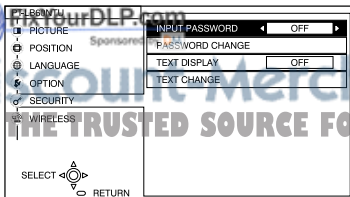

- 3 Press the ▲ or ▼ button to select an item.
- 4 Press the ◀ or ► button to

change the setting.  
For “PASSWORD CHANGE” and “TEXT CHANGE”, press the ENTER button to display the next screen.

## INPUT PASSWORD

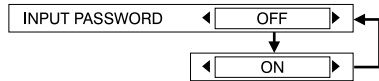

The password input screen can be displayed when the power is turned on. All of the controls other than the POWER button are disabled unless the password is entered correctly.

### OFF

“INPUT PASSWORD” is disabled.

### ON

“INPUT PASSWORD” is enabled.

## PASSWORD CHANGE

Passwords can be changed. Press the ENTER button to display the “PASSWORD CHANGE” screen.

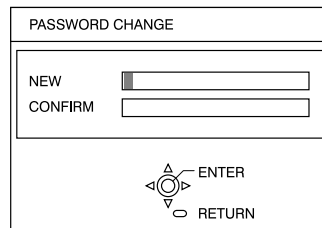

- 1 Set a password by pressing the ▲, ▼, ◀, and ► buttons.

(A maximum of 8 buttons can be set.)

- 2 Press the ENTER button.
- 3 Enter the password again for confirmation.
- 4 Press the ENTER button.

**NOTE:**

- The entered password will appear as \*. It will not be displayed on the screen.
- If you enter the wrong password, an error message will be displayed. Enter the correct password again.

## TEXT DISPLAY



You can set text to be displayed at the bottom of the projected image at all times.

### OFF

“TEXT DISPLAY” is disabled.

### ON

“TEXT DISPLAY” is enabled.

## TEXT CHANGE

The text which is displayed when “TEXT DISPLAY” is set to “ON” can be changed.

Press the ENTER button to display the “TEXT CHANGE” screen.

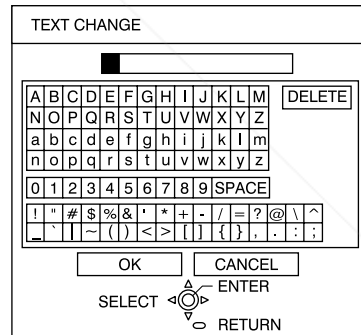

- ① Press the ▲, ▼, ◀ and ▶ buttons to select the characters, then press the ENTER button. (You can enter 22 characters continuously.)
  - Select “DELETE” to delete a character.
- ② Press the ▲, ▼, ◀ and ▶ buttons to select “OK”, then press the ENTER button.
  - Select “CANCEL” to cancel the change.

Adjustments and settings



Discount-Merchant.com (800) 281-8860  
THE TRUSTED SOURCE FOR PROJECTOR LAMPS AND ACCESSORIES



# Wireless setup (PT-LB60NTU only)

You need to make adjustments on some items when controlling the projector with a personal computer by means of the wireless network. Refer to the accessory CD-ROM for details.

NETWORK	<input type="text" value="1"/>
NAME CHANGE	
INPUT PASSWORD	<input type="text" value="OFF"/>
PASSWORD CHANGE	
WEB CONTROL	<input type="text" value="OFF"/>
STATUS	
INITIALIZE	

## NETWORK

Select the network setting you want to use.

## NAME CHANGE

The name for this projector can be set.

## INPUT PASSWORD

Set to "ON" if you want password confirmation to be used when controlling the projector with a personal computer by means of the wireless network.

## PASSWORD CHANGE

Passwords can be changed.

## WEB CONTROL

To control the projector with a personal computer by means of the wireless network, set the "WEB CONTROL" to "ON".

## STATUS

The wireless settings will be displayed.

## INITIALIZE

Wireless settings can be returned to the factory default settings.



**Discount-Merchant.com (800) 281-8860**  
THE TRUSTED SOURCE FOR PROJECTOR LAMPS AND ACCESSORIES

# When the TEMP indicator and the LAMP indicator are illuminated

There are two indicators on the control panel of the projector which give information about the operating condition of the projector. These indicators illuminate or flash to warn you about problems that have occurred inside the projector, so if you notice that one of the indicators is on, turn off the power and check the table below for the cause of the problem.

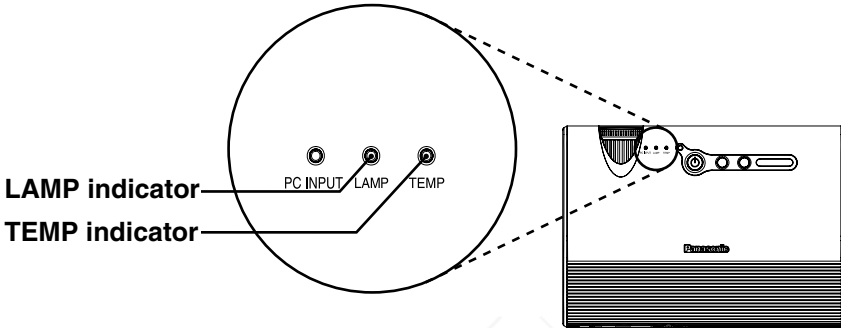

TEMP indicator		
Indicator display	Illuminated (red) (Lamp unit on)	Flashing (red) (Lamp unit off)
<b>Problem</b>	The surrounding temperature or the temperature inside the projector has become unusually high.	The surrounding temperature or the temperature inside the projector has become dangerously high, causing the lamp unit to automatically shut off.
<b>Possible cause</b>	<ul style="list-style-type: none"> <li>• The ventilation holes may be covered.</li> <li>• The ambient temperature in the place of use may be too high.</li> <li>• The air filter may be blocked.</li> </ul>	
<b>Remedy</b>	<ul style="list-style-type: none"> <li>• Uncover the ventilation holes.</li> <li>• Set up the projector in a place where the temperature is between 0 °C (32 °F) and 40 °C (104 °F) and the humidity is between 20% and 80% (with no condensation). [If you set the "HIGHLAND" to "ON" (page 52), set up the projector in a place where the temperature is between 0 °C (32 °F) and 35 °C (95 °F) and the humidity is between 20% and 80% (with no condensation).]</li> <li>• Disconnect the power cord by following the procedure on page 28, and then clean the air filter. (Refer to page 59.)</li> </ul>	

LAMP indicator		
Indicator display	Illuminated (red)	Flashing (red)
Problem	It is nearly time to replace the lamp unit.	An abnormality has been detected in the lamp circuit.
Possible cause	<ul style="list-style-type: none"> <li>Does “REPLACE LAMP” appear on the screen after the projector is turned on?</li> </ul>	<ul style="list-style-type: none"> <li>The power may have been turned on straight away after it was turned off.</li> <li>There may be an abnormality in the lamp circuit.</li> <li>The lamp unit may be blown.</li> </ul>
Remedy	<ul style="list-style-type: none"> <li>This occurs when the operation time for the lamp unit is nearing 1 800 hours (when “LAMP POWER” has been set to “STANDARD” and when “AI” has been set to “OFF”). Ask your dealer or an Authorized Service Center to replace the lamp unit. (page 60)</li> </ul>	<ul style="list-style-type: none"> <li>Wait for a while until the lamp unit cools down before turning the power back on again.</li> <li>Disconnect the power cord by following the procedure on page 28, and then contact an Authorized Service Center.</li> <li>Ask your dealer or an Authorized Service Center to replace the lamp unit. (page 60)</li> </ul>

**NOTE:**

- Be sure to disconnect the power cord by following the procedure given in “Turning off the power” on page 28 before carrying out any of the procedures in the “Remedy” column.
- If the TEMP indicator is illuminated and the power turns off after the procedures in the “Remedy” column have been carried out, it means an abnormality has occurred. Please contact an Authorized Service Center so that the necessary repairs can be made.

# Cleaning and replacing the air filter

If the air filter becomes clogged with dust, the internal temperature of the projector will rise, the TEMP indicator will illuminate and the projector's power will turn off (the TEMP indicator will flash after the power is turned off). **The air filter should be cleaned every 100 hours of use.**

## Cleaning

Use a vacuum cleaner to clean off any accumulated dust.

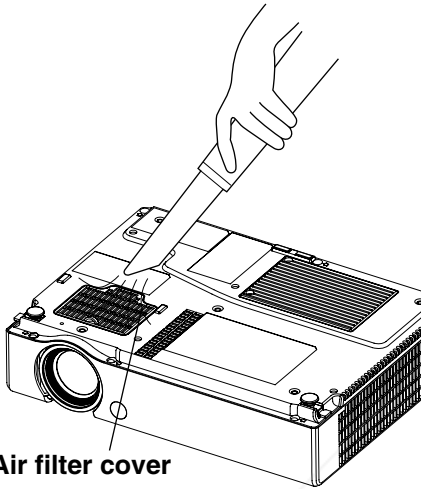

Air filter cover

### NOTE:

- If the dust cannot be cleaned by a vacuum cleaner, remove the air filter and soak it in water, and then wash out the dust by hand. Be sure to install the air filter after it has dried.
  - Do not use detergent when washing the air filter.
  - If the dust cannot be removed by cleaning, it is time to replace the air filter. Please consult your dealer.
- Furthermore, if the lamp unit is being replaced, replace the air filter at this time also.

## Replacement procedure

- ① Turn off the power and disconnect the power cord. Be sure to disconnect the power cord by following the procedure given on page 28.
- ② Gently turn the projector upside down, and then remove the air filter cover.

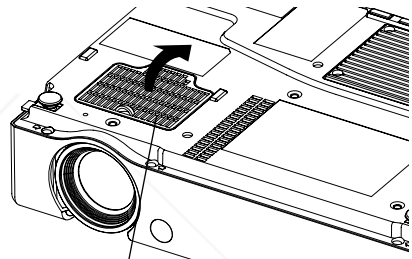

Air filter cover

- ③ Replace the air filter, and then install the air filter cover.

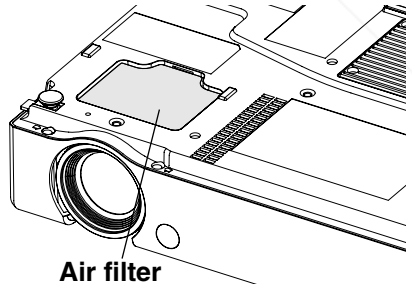

Air filter

### NOTE:

- Be sure to install the air filter before using the projector. If the projector is used without the air filter installed, dust and other foreign particles will be drawn into the projector, and malfunctions will result.

# Replacing the lamp unit

## Warning

The lamp unit should only be replaced by a qualified technician.

When replacing the lamp, allow it to cool for at least one hour before handling it.

- The lamp cover gets very hot, and touching it can cause burns.

## Notes on replacing the lamp unit

- The light generating lamp is made of glass, so dropping it or allowing it to hit hard objects may cause it to burst. Be careful when handling the lamp.
- Dispose of the removed old lamp with the same care that would be taken with a fluorescent light.
- A Phillips screwdriver is necessary for removing the lamp unit.

### NOTE:

- The projector is not supplied with a replacement lamp unit. Please ask your dealer for details. Lamp unit product no.: **ET-LAB30**

### CAUTION:

- Do not use any lamp unit other than the one with the product number indicated above.

## Lamp unit replacement period

The lamp is a consumable product. Even when the full life of the bulb has not been exhausted, the brightness of the light will gradually decline. Therefore periodic replacement of the lamp is necessary.

The intended lamp replacement interval is 2 000 hours, but it is possible that the lamp may need to be replaced earlier due to variables such as a particular lamp's characteristics, usage conditions and the installation environment. Early preparation for lamp replacement is encouraged.

The lamp will automatically shut off after approximately 10 minutes when 2 000 hours of use have been reached because of a much greater chance of it exploding after this time.

### NOTE:

- The usage hours explained above are for when "LAMP POWER" in the "OPTION" menu has been set to "STANDARD" and when "AI" in the "PICTURE" menu has been set to "OFF". If "LAMP POWER" is set to "ECO-MODE", or "AI" is set to "ON", the life of the lamp can be extended.
- While 2 000 hours is the intended replacement interval, it is not a period of time covered by warranty.





FixYourDLP.com

Sponsored by 

Discount-Merchant.com (800) 281-8860

THE TRUSTED SOURCE FOR PROJECTOR LAMPS AND ACCESSORIES

	On-screen display 	LAMP indicator 
More than 1 800 hours	Displayed for 30 seconds. Pressing any button will clear the display.	Illuminates red during image projection and standby mode.
More than 2 000 hours	Remains displayed until any button is pressed.	

## Lamp unit replacement procedure

### NOTE:

- If the lamp usage time has passed 2 000 hours (when “LAMP POWER” has been set to “STANDARD” and when “AI” has been set to “OFF”), the projector will switch to standby mode after approximately 10 minutes of operation. The steps ⑦ to ⑫ on the next page should thus be completed within 10 minutes.

- ① Disconnect the power cord from the projector by following the procedure on page 28, and check that the area around the lamp unit has cooled down.
- ② Use a Phillips screwdriver to turn the lamp unit cover fixing screws at the bottom of the projector, and then remove the lamp unit cover.

Lamp unit cover

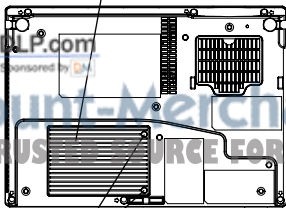

Lamp unit cover fixing screws

- ③ Use a Phillips screwdriver to loosen the two lamp unit fixing screws until the screws turn freely. Then hold the handles of the lamp unit and gently pull the lamp unit out from the projector.

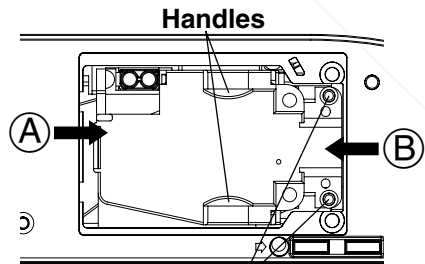

Lamp unit fixing screws

- ④ Insert the new lamp unit while making sure that the direction of insertion is correct, and then use a Phillips screwdriver to securely tighten the lamp unit fixing screws.

When inserting the new lamp unit, be sure to push it in at the point A and B.

- ⑤ **Install the lamp unit cover, and then use a Phillips screwdriver to securely tighten the lamp unit cover fixing screws.**

**NOTE:**

- Be sure to install the lamp unit and the lamp unit cover securely. If they are not securely installed, it may cause the protection circuit to operate so that the power cannot be turned on.

- ⑥ **Connect the power cord.**
- ⑦ **Press the POWER button so that a picture is projected onto the screen.**

**NOTE:**

- If “DIRECT POWER ON” in the “OPTION” menu has been set to “ON”, projection will start after the power cord is connected. Refer to page 51 for details.

- ⑧ **Press the MENU button to display the menu screen, and then press the ▲ or ▼ button to select the “OPTION” menu.**

- ⑨ **Press the ENTER button, and then press the ▲ or ▼ button to select “LAMP RUNTIME”.**
- ⑩ **Press and hold the ENTER button for approximately 3 seconds.**

The “LAMP RUNTIME” screen will be displayed.

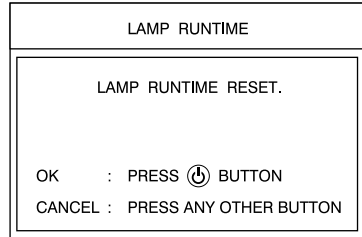

**NOTE:**

- Press any button other than the POWER button to cancel the “LAMP RUNTIME” screen.

- ⑪ **Press the POWER button to turn off the power.**
- ⑫ **Disconnect the power cord after the POWER button on the projector illuminates red.**  
This will reset the cumulative usage time for the lamp unit to “0”.

# Before calling for service

Before calling for service, check the following points.

Problem	Possible cause	Page
<b>Power does not turn on.</b>	● The power cord may not be connected.	–
	● The main power supply is not being supplied to the wall outlet.	–
	● TEMP indicator is illuminated or flashing.	57
	● LAMP indicator is illuminated or flashing.	58
	● The lamp unit cover has not been securely installed.	–
<b>No picture appears.</b>	● The video signal input source may not be connected properly.	–
	● The input selection setting may not be correct.	30
	● The “BRIGHTNESS” adjustment setting may be at the minimum possible setting.	41
	● The “SHUTTER” function may be in use.	32, 53
<b>The picture is fuzzy.</b>	● The lens cover may still be attached to the lens.	–
	● The lens focus may not have been set correctly.	27
	● The projector may not be at the correct distance from the screen.	20
	● The lens may be dirty.	–
	● The projector may be tilted too much.	18
<b>The color is pale or grayish.</b>	● “COLOR” or “TINT” adjustment may be incorrect.	41
	● The input source which is connected to the projector may not be adjusted correctly.	–
<b>No sound can be heard.</b>	● The audio signal source may not be connected properly.	–
	● The volume adjustment may be at the lowest possible setting.	32, 52
	● A cable may be connected to the VARIABLE AUDIO OUT connector.	21, 22, 23
<b>The remote control unit does not operate.</b>	● The battery may be weak.	–
	● The battery may not be inserted correctly.	24
	● The remote control signal receptor on the projector may be obstructed.	24
	● The remote control unit may be out of the operation range.	24
<b>The buttons on the projector do not function.</b>	● The “CONTROL PANEL” may be set to “INVALID”. In order to set the “CONTROL PANEL” to “VALID” without using the remote control unit, keep holding down the ENTER button on the projector and press the MENU button for more than 2 seconds.	51



Problem	Possible cause	Page
The picture does not display correctly.	<ul style="list-style-type: none"> <li>● The signal format (“TV-SYSTEM”) may not be set correctly.</li> </ul>	43
	<ul style="list-style-type: none"> <li>● There may be a problem with the video tape or other signal source.</li> </ul>	–
	<ul style="list-style-type: none"> <li>● A signal which is not compatible with the projector may be being input.</li> </ul>	68
Picture from computer does not appear.	<ul style="list-style-type: none"> <li>● The cable may be too long.</li> </ul>	–
	<ul style="list-style-type: none"> <li>● The external video output for the laptop computer may not be set correctly. (The actual method varies depending on the type of computer, so refer to the documentation provided with your computer for further details.)</li> </ul>	69
	<ul style="list-style-type: none"> <li>● If an PC INPUT indicator is turned off, the video signals may not be output from the computer.</li> </ul>	14
	<ul style="list-style-type: none"> <li>● “PC2 SELECT” in the “OPTION” menu is set to “OUTPUT” when the signals are input to PC 2 IN/PC 1 OUT connector.</li> </ul>	50

## Cleaning and maintenance

**Before carrying out cleaning and maintenance, be sure to disconnect the power cord plug from the wall outlet.**

**Wipe the cabinet with a soft, dry cloth.**

If the cabinet is particularly dirty, soak the cloth in water with a small amount of neutral detergent in it, squeeze the cloth very well, and then wipe the cabinet. After cleaning, wipe the cabinet dry with a dry cloth. If using a chemically-treated cloth, read the instructions supplied with the cloth before use.

**Do not wipe the lens with a cloth that is dusty or which produces lint.**

If any dust or lint gets onto the lens, such dust or lint will be magnified and projected onto the screen. Use a blower to clean any dust and lint from the lens surface, or use a soft cloth to wipe off any dust or lint.

# Specifications

Power supply:	100 V - 240 V ~, 50 Hz/60 Hz
Power consumption:	300 W [During standby (when fan is stopped): Approx. 3 W]
Amps:	3.5 A - 1.8 A

LCD panel:	
Panel size (diagonal):	0.8 type (20.32 mm)
Aspect ratio:	4:3
Micro lens array:	Available
Display method:	3 transparent LCD panels (RGB)
Drive method:	Active matrix method
Pixels:	786 432 (1 024 x 768) x 3 panels

Lens:	Manual zoom (1.2x) / Manual focus F 1.7 - 1.8 f 24.0 mm - 28.8 mm
-------	--

Lamp:	UHM lamp (220 W)
-------	------------------

Luminosity:	3 200 lm
-------------	----------

Scanning frequency (for RGB signals):	
Horizontal scanning frequency:	15 kHz - 91 kHz
Vertical scanning frequency:	50 Hz - 85 Hz
Dot clock frequency:	Less than 100 MHz

YPbPr signals:	480i, 576i, 480p, 576p, 1 080/60i, 1 080/50i, 720/60p
----------------	---

Color system:	7 (NTSC/NTSC 4.43/PAL/PAL-M/PAL-N/PAL60/SECAM)
---------------	--

Projection size:	838.2 mm - 7 620 mm (33" - 300")
------------------	----------------------------------

Throw distance:	1.1 m - 10.8 m (3'7" - 35'5")
-----------------	-------------------------------

Optical axis shift:	6:1 (fixed)
---------------------	-------------

Screen aspect ratio:	4:3
----------------------	-----

Installation:	Front/Desk Front/Ceiling Rear/Desk Rear/Ceiling (menu selection)
---------------	---

Speaker:	4 cm x 3 cm oval x 1
----------	----------------------

Max. usable volume output:	1 W (mono)
----------------------------	------------

Wireless LAN (PT-LB60NTU only):	IEEE802.11 b/g
---------------------------------	----------------

## Connectors

### PC IN/OUT

Sponsored by 

During RGB input/output:

R.G.B.: 0.7 V [p-p], 75 Ω

G.SYNC: 1.0 V [p-p], 75 Ω

HD, VD: TTL, automatic positive/negative polarity compatible

During YPbPr input/output:

Y: 1.0 V [p-p] (Including sync), 75 Ω

PB, PR : 0.7 V [p-p], 75 Ω

Dual line, D-sub HD 15-pin (female)  
(One line is available for input and output, selectable using an on-screen menu)



Discount-Merchants.com 1800-238-8600  
THE TRUSTED SOURCE FOR PROJECTOR LAMPS AND ACCESSORIES

Others

VIDEO IN: Single-line, RCA pin jack, 1.0 V [p-p], 75 Ω  
 S-VIDEO IN: Single-line, Mini DIN 4-pin  
 Y 1.0 V [p-p], C 0.286 V [p-p], 75 Ω  
 AUDIO IN (for S-VIDEO/VIDEO): Single-line, 0.5 V [rms] RCA pin jack x 2 (L-R)  
 PC AUDIO IN: Dual-line, 0.5 V [rms] M3 jack (Stereo MINI)  
 VARIABLE AUDIO OUT: Single-line, 0.5 V [rms] M3 jack (Stereo MINI)  
 (Monitor output/stereo compatible)  
 0 V [rms] - 2.0 V [rms] (variable)  
 SERIAL: DIN 8-pin RS-232C compatible

Cabinet: Moulded plastic (PC/ABS)  
 Dimensions:  
 Width: 327 mm (12-27/32")  
 Length: 233 mm (9-5/32") (without lens cover)  
 Height: 83 mm (3-1/4")

Weight:  
 PT-LB60NTU: 2.6 kg (5.7 lbs.)  
 PT-LB60U: 2.5 kg (5.5 lbs.)  
 Operating environment:  
 Temperature: 0 °C - 40 °C (32 °F - 104 °F)  
 [When the "HIGHLAND" is set to "ON"  
 (page 52): 0 °C - 35 °C (32 °F - 95 °F)]  
 Humidity: 20% - 80% (no condensation)  
 Certifications: UL60950, C-UL  
 FCC Class B

**<Remote control unit>**

Power supply: 3 V DC (AAA battery x 2)  
 Operating range: Approx. 7 m (23') (when operated directly  
 in front of signal receptor)  
 Weight: 74 g (2.6 ozs.) (including battery)  
 Dimensions:  
 Width: 51.5 mm (2")  
 Length: 123 mm (4-13/16")  
 Height: 21.1 mm (-13/16")

**<Options>**

Ceiling bracket ET-PKB30  
 Wireless remote control unit ET-RM300  
 Serial adapter ET-ADSER  
 (DIN 8-pin/D-sub 9-pin)

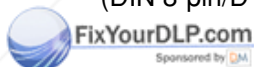

**Discount-Merchant.com (800) 281-8860**  
**THE TRUSTED SOURCE FOR PROJECTOR LAMPS AND ACCESSORIES**

# Appendix

## Projection dimensions calculation methods

If the screen size (diagonal) is SD (m), then the following formula is used to calculate the projection distance for the wide lens position (LW) and the projection distance for the telephoto lens position (LT).

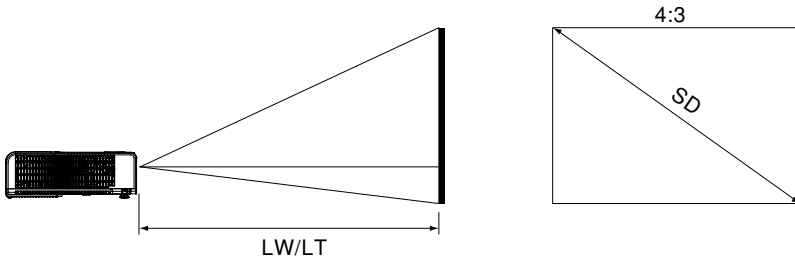

<b>Minimum Projection Distance</b>	$LW=0.0303 \times SD / 0.0254 - 0.044$
<b>Maximum Projection Distance</b>	$LT=0.0364 \times SD / 0.0254 - 0.044$

For 16:9 aspect ratios, the following formula can be used to calculate the projection distance.

<b>Minimum Projection Distance</b>	$LW=0.0331 \times SD / 0.0254 - 0.044$
<b>Maximum Projection Distance</b>	$LT=0.0397 \times SD / 0.0254 - 0.044$

\*The values obtained from the formulas above are approximate.

### NOTE:

- If 4:3 images are projected onto a 16:9 screen that has been set using the projection distance for a 16:9 screen, the 4:3 images will overflow the screen at the top and bottom. In such cases, set "ASPECT" to "S4:3". (Refer to page 46 for details.)

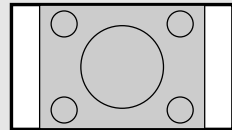

FixYourDLP.com

Discount-Merchant.com (800) 281-8860

THE TRUSTED SOURCE FOR PROJECTOR LAMPS AND ACCESSORIES

Others

# List of compatible signals

Mode	Display resolution (dots)*1	Scanning frequency		Dot clock frequency (MHz)	Picture quality*2	Resizing*3	Format
		H (kHz)	V (Hz)				
NTSC/NTSC4.43/ PAL-M/PAL60	720 x 480i	15.7	59.9		A	OK	S-Video/Video
PAL/PAL-N/SECAM	720 x 576i	15.6	50.0		A	OK	S-Video/Video
480i	720 x 480i	15.7	59.9	13.5	A	OK	YPbPr/RGB
576i	720 x 576i	15.6	50.0	13.5	A	OK	YPbPr/RGB
480p	720 x 483	31.5	59.9	27.0	A	OK	YPbPr/RGB
576p	720 x 576	31.3	50.0	27.0	A	OK	YPbPr/RGB
1 080/60i	1 920 x 1 080i	33.8	60.0	74.3	A		YPbPr/RGB
1 080/50i	1 920 x 1 080i	28.1	50.0	74.3	A		YPbPr/RGB
720/60p	1 280 x 720	45.0	60.0	74.3	A		YPbPr/RGB
VGA400	640 x 400	31.5	70.1	25.2	A	OK	RGB
	640 x 400	37.9	85.1	31.5	A	OK	RGB
VGA480 *4	640 x 480	31.5	59.9	25.2	A	OK	RGB
	640 x 480	35.0	66.7	30.2	A	OK	RGB
	640 x 480	37.9	72.8	31.5	A	OK	RGB
	640 x 480	37.5	75.0	31.5	A	OK	RGB
	640 x 480	43.3	85.0	36.0	A	OK	RGB
SVGA *4	800 x 600	35.2	56.3	36.0	A	OK	RGB
	800 x 600	37.9	60.3	40.0	A	OK	RGB
	800 x 600	48.1	72.2	50.0	A	OK	RGB
	800 x 600	46.9	75.0	49.5	A	OK	RGB
	800 x 600	53.7	85.1	56.3	A	OK	RGB
MAC16	832 x 624	49.7	74.6	57.3	A	OK	RGB
XGA *4	1 024 x 768	48.4	60.0	65.0	AA		RGB
	1 024 x 768	56.5	70.1	75.0	AA		RGB
	1 024 x 768	60.0	75.0	78.8	AA		RGB
	1 024 x 768	68.7	85.0	94.5	AA		RGB
	1 024 x 768i	35.5	87.0	44.9	AA		RGB
MXGA	1 152 x 864	64.0	71.2	94.2	A		RGB
	1 152 x 864	67.5	74.9	108.0	B		RGB
	1 152 x 864	76.7	85.0	121.5	B		RGB
MAC21	1 152 x 870	68.7	75.1	100.0	B		RGB
MSXGA *4	1 280 x 960	60.0	60.0	108.0	B		RGB
SXGA *4	1 280 x 1 024	64.0	60.0	108.0	B		RGB
	1 280 x 1 024	80.0	75.0	135.0	B		RGB
	1 280 x 1 024	91.1	85.0	157.5	B		RGB
SXGA+ *4	1 400 x 1 050	64.0	60.0	108.0	B		RGB
	1 400 x 1 050	65.1	59.9	122.4	B		RGB
UXGA60 *4	1 600 x 1 200	75.0	60.0	162.0	B		RGB
WXGA*5 *4	1 280 x 768	47.8	59.9	79.5	A		RGB
	1 280 x 800	49.7	59.8	83.5	A		RGB
	1 440 x 900	55.9	59.9	106.5	A		RGB

\*1 The "i" appearing after the resolution indicates an interlaced signal.

\*2 The following symbols are used to indicate picture quality.

AA Maximum picture quality can be obtained.

A Signals are converted by the image processing circuit before picture is projected.

B Some loss of data occurs to make projection easier.

\*3 Signals with "OK" are compatible with the "RESIZING" function. (page 47)

\*4 Signals that are compatible with the "FRAME LOCK" function. (page 47)

\*5 Signals that are compatible with the CVT standard.

# Guide screen for computer connection

Refer to the list below for details on the keyboard commands to change the output setting.

Manufacturer	Keyboard command	Manufacturer	Keyboard command
Panasonic NEC	<b>Fn</b> + <b>F3</b>	EPSON DELL	<b>Fn</b> + <b>F8</b>
TOSHIBA SHARP HP	<b>Fn</b> + <b>F5</b>	IBM SONY Apple	<b>Fn</b> + <b>F7</b> <b>F7</b>
FUJITSU	<b>Fn</b> + <b>F10</b>	Other	<b>Fn</b> + 

**NOTE:**

- The actual method varies depending on the type of computer, so refer to the documentation provided with your computer for further details.



**Discount-Merchant.com (800) 281-8860**  
**THE TRUSTED SOURCE FOR PROJECTOR LAMPS AND ACCESSORIES**

Others

# Using the SERIAL connector

The serial connector which is on the connector panel of the projector conforms to the RS-232C interface specification, so that the projector can be controlled by a personal computer which is connected to this connector.

## Connection

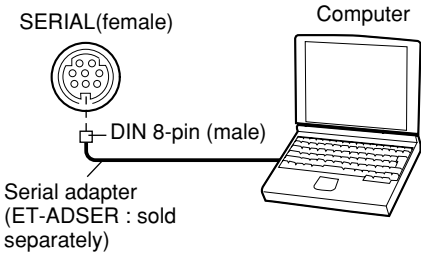

### NOTE:

- You must use only RS-232C Serial Interface Cable with ferrite core, type ET-ADSER.

## Pin assignments and signal names

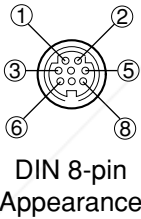

Pin No.	Signal name	Contents
③	RXD	Received data
④	GND	Earth
⑤	TXD	Transmitted data
①		Connected internally
②		
⑥		
⑦		NC
⑧		NC

## Communications settings

Signal level	RS-232C
Sync. method	Asynchronous
Baud rate	9 600 bps
Parity	None
Character length	8 bits
Stop bit	1 bit
X parameter	None
S parameter	None

## Basic format

The data sent from the computer to the projector is transmitted in the format shown below.

STX	Command	:	Parameter	ETX
Start byte (02h)	3 bytes		1 byte-5 bytes	End byte (03h)

### NOTE:

- The projector can not receive the command for 10 seconds after the lamp is switched on. Wait 10 seconds before sending the command.
- If sending multiple commands, check that a response has been received from the projector for one command before sending the next command.
- When a command which does not require parameters is sent, the colon (:) is not required.
- If an incorrect command is sent from the personal computer, the "ER401" command will be sent from the projector to the personal computer.

## Control commands

The commands which the personal computer can use to control the projector are shown in the following table.

Command	Control Contents	Remarks
PON	Power ON	In standby mode, all commands other than the PON command are ignored. <ul style="list-style-type: none"> <li>The PON command is ignored during lamp ON control.</li> </ul>
POF	Power OFF	<ul style="list-style-type: none"> <li>If a PON command is received while the cooling fan is operating after the lamp has switched off, the lamp is not turned back on again straight away, in order to protect the lamp.</li> </ul>
AVL	Volume	Parameter 000-063 (Adjustment value 0-63)
IIS	Input signal selection	Parameter VID=VIDEO                      SVD=S-VIDEO RG1=PC1                         RG2=PC2 NWP=WIRELESS (PT-LB60NTU only)
Q\$\$	Lamp ON condition query	Callback 0 = Standby 1 = Lamp ON control active 2 = Lamp ON 3 = Lamp OFF control active
OSH	Shutter function	Operation will be switched between ON and OFF each time the command is sent. Do not switch operation ON and OFF after only short periods of time. If a command other than "OSH" is sent to the projector when the shutter function is used, the "ER401" command will be sent from the projector to the computer and the shutter function will be turned off.

## Cable specifications

(When connected to a personal computer)

At the projector

At the computer  
(DTE specifications)

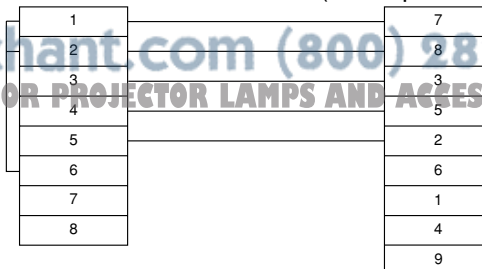



# Dimensions

<Units: mm (inch)>

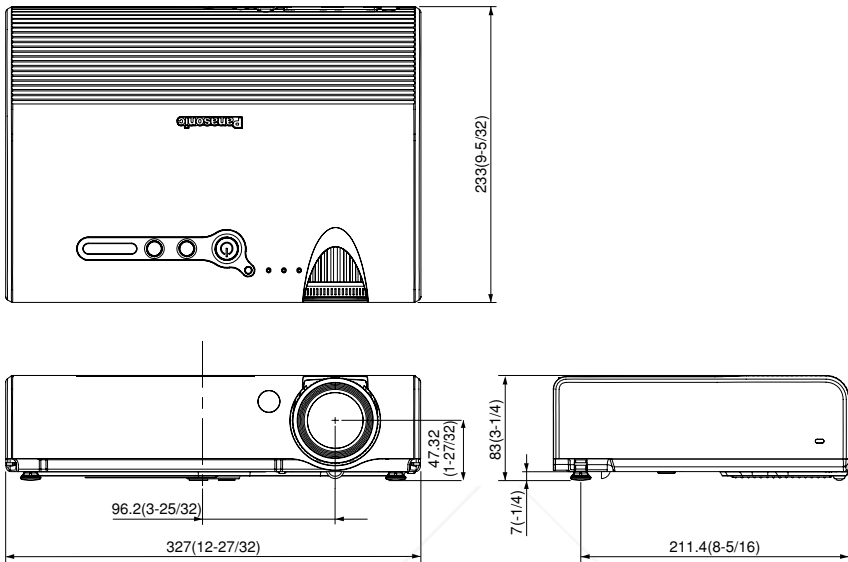

## Trademark acknowledgements

- VGA and XGA are trademarks of International Business Machines Corporation.
- Macintosh is a registered trademark of Apple Computer, Inc.
- S-VGA is a registered trademark of the Video Electronics Standards Association.
- The font used in the on-screen displays is a Ricoh bitmap font, which is manufactured and sold by Ricoh Company, Ltd.

All other trademarks are the property of the various trademark owners.

 [FixYourDLP.com](http://FixYourDLP.com)  
**Information on Disposal in other Countries outside the European Union**  
[Discount-Merchant.com](http://Discount-Merchant.com) (800) 281-8860



This symbol is only valid in the European Union.  
If you wish to discard this product, please contact your local authorities or dealer and ask for the correct method of disposal.

These Operating Instructions are printed on recycled paper.

# NOTES IMPORTANTES CONCERNANT LA SECURITE

**AVERTISSEMENT: POUR REDUIRE LES RISQUES DE FEU OU DE CHOC ÉLECTRIQUE, NE PAS EXPOSER CE PRODUIT À L'EAU OU À L'HUMIDITÉ**

**Alimentation:** Ce projecteur LCD est conçu pour fonctionner sur secteur de 100 V - 240 V, 50 Hz/60 Hz seulement.

**ATTENTION:** Le cordon d'alimentation secteur fourni avec le projecteur peut être utilisé uniquement pour une alimentation électrique de 125 V, 7 A maximum. Si on veut l'utiliser avec une tension ou un courant plus forts, on doit se procurer un autre cordon d'alimentation de 250 V. Si on utilise le cordon fourni sous ces conditions, risque de provoquer un incendie.



Le symbole de la flèche en forme d'éclair, dans un triangle, avertit l'utilisateur de la présence de "tensions dangereuses" à l'intérieur du produit qui peuvent être de force suffisante pour constituer un risque de choc électrique aux personnes.



Le point d'exclamation dans un triangle avertit l'utilisateur de la présence d'instructions importantes concernant l'utilisation et l'entretien (réparation) dans la littérature accompagnant le produit.

**ATTENTION:** Cet appareil est équipé d'une fiche de courant à trois broches avec mise à la terre. Ne pas retirer la broche de mise à la terre de la masse de la fiche.

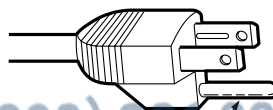

Cette fiche ne pourra être utilisée que dans une prise avec mise à la terre. Ceci est une précaution sécuritaire. S'il est impossible d'insérer la fiche dans la prise, s'adresser à un électricien. Ne pas annuler la protection de la fiche à mise à la terre.

### **AVERTISSEMENT:**

- Ne peut être utilisé dans une salle d'ordinateurs telle que définie dans la norme ANSI/NFPA 75 Standard for Protection of Electronic Computer/Data Processing Equipment.
- Pour l'équipement branché en permanence, un dispositif de disconnexion d'accès facile doit être incorporé dans le câble d'installation du bâtiment;
- Pour l'équipement branchable, une prise secteur d'accès facile doit être installée près de l'équipement.

## **Précautions de sécurité**

### **AVERTISSEMENT**

**Si l'on remarque une émission de fumée, d'odeurs suspectes ou de bruits provenant du projecteur, débrancher la fiche du cordon d'alimentation de la prise de courant.**

- Ne pas continuer d'utiliser le projecteur dans ces cas, autrement cela peut entraîner un incendie ou des chocs électriques.
- Après s'être assuré que de la fumée ne se dégage plus, s'adresser à un centre technique agréé et demander que les réparations nécessaires soient faites.
- Le fait de réparer le projecteur soi-même est très dangereux, et ne doit jamais être fait.

**Ne pas installer ce projecteur dans un endroit qui n'est pas assez résistant pour supporter le poids du projecteur.**

- Si l'emplacement d'installation n'est pas assez résistant, le projecteur risque de tomber et causer de graves blessures et (ou) des dommages.

**Demander à un technicien qualifié d'installer le projecteur par exemple s'il est installé au plafond.**

- Si l'installation n'est pas faite correctement, cela peut entraîner des blessures ou des chocs électriques.

**Si de l'eau ou des objets étrangers entrent dans le projecteur, si le projecteur tombe, ou si le boîtier est endommagé, débrancher immédiatement la fiche du cordon d'alimentation de la prise de courant.**

- Si l'on continue d'utiliser le projecteur dans cette condition, cela peut entraîner un incendie ou des chocs électriques.
- S'adresser à un centre technique agréé pour que les réparations nécessaires puissent être faites.

**Ne pas surcharger la prise de courant.**

- Si l'alimentation est surchargée (par exemple, par l'utilisation de trop d'adaptateurs), cela risque de faire surchauffer le projecteur et peut entraîner un incendie.

**Ne pas retirer le capot ou le modifier.**

- Des hautes tensions qui peuvent causer de graves blessures sont présentes à l'intérieur du projecteur.

- Pour toute inspection, réglage ou réparation, s'adresser à un centre technique agréé.

**Nettoyer la fiche du cordon d'alimentation régulièrement afin d'éviter toute accumulation de poussière.**

- Si de la poussière s'accumule sur la fiche du cordon d'alimentation, l'humidité peut endommager l'isolant et entraîner un incendie. Débrancher la fiche du cordon d'alimentation de la prise de courant et l'essuyer avec un tissu sec.
- Si le projecteur n'est pas utilisé pendant une période prolongée, débrancher la fiche du cordon d'alimentation de la prise de courant.

**Faire attention à ne pas endommager le cordon d'alimentation.**

- Ne pas endommager le cordon d'alimentation, ne pas le modifier, ne pas le placer sous des objets lourds, ne pas le chauffer, ne pas le placer près d'objets chauffants, ne pas le tordre, ne pas le plier ou le tirer excessivement et ne pas le rouler en boule.
- Si le cordon d'alimentation est endommagé, cela peut entraîner un incendie et des chocs électriques.
- Si le cordon d'alimentation est endommagé, le faire réparer par un centre technique agréé.

**Ne pas manipuler le cordon d'alimentation avec les mains mouillées.**

- Cela peut entraîner des chocs électriques.

**Brancher la fiche du cordon d'alimentation fermement dans la prise de courant.**

- Si la fiche n'est pas complètement insérée, cela peut entraîner des chocs électriques ou la faire surchauffer.
- Si la fiche est endommagée ou la plaque de la prise desserrée, celles-ci ne devraient pas être utilisées.

**Ne pas placer le projecteur sur des surfaces instables.**

- Si le projecteur est placé sur une surface qui est inclinée ou instable, il risque de tomber ou de se renverser et cela peut causer des blessures ou des dommages.

**Ne pas placer le projecteur dans l'eau ou ne pas le laisser se mouiller.**

- Sinon cela peut causer un incendie ou des chocs électriques.

**Ne pas placer le projecteur sur des matériaux comme du tapis ou du tissu éponge.**

- Cela peut provoquer une surchauffe du projecteur, pouvant entraîner des brûlures, un incendie ou endommager le projecteur.

**Ne pas placer des récipients de liquide sur le projecteur.**

- Si de l'eau se renverse sur le projecteur ou pénètre dans celui-ci, il y aura risque d'incendie ou d'électrocution.
- Si de l'eau entre à l'intérieur du projecteur, entrer en contact avec un centre technique agréé.

**Ne pas mettre d'objets étrangers dans le projecteur.**

- Ne pas insérer d'objets métalliques ou inflammables dans les orifices de ventilation ou les faire tomber sur le projecteur, car cela peut causer un incendie ou des chocs électriques.

### **Garder les piles hors de portée des enfants.**

- Si les piles sont ingérées, il y aura risque de décès par étouffement. En cas d'ingestion des piles, consulter immédiatement un médecin.

### **Veiller à ce que les bornes + et - des piles n'entrent pas en contact avec des objets métalliques tels que colliers ou épingles à cheveux.**

- Sinon, les piles risquent de fuir, de surchauffer, d'exploser ou de prendre feu.
- Ranger les piles dans un sac en plastique, et ne pas les ranger à proximité d'objets métalliques.

### **Pendant un orage, ne pas toucher le projecteur ou le câble.**

- Il y a risque d'électrocution.

### **Ne pas utiliser l'appareil dans un bain ou une douche.**

- Il y a risque d'incendie ou d'électrocution.

### **Ne pas regarder directement dans l'objectif pendant que le projecteur fonctionne.**

- Une lumière intense est émise par l'objectif du projecteur. Si l'on regarde directement dans cette lumière, elle risque de causer des blessures et de graves lésions aux yeux.
- Veiller particulièrement à ne pas laisser les jeunes enfants regarder dans l'objectif. En outre, débrancher la fiche du cordon d'alimentation de la prise de courant lorsqu'on laisse le projecteur sans surveillance.

### **Veillez à ce que le faisceau lumineux n'éclaire pas directement votre peau pendant que vous utilisez le projecteur.**

- Une lumière intense est émise par l'objectif du projecteur. Si vous vous placez dans ce faisceau lumineux, celui-ci risquera de vous blesser ou de vous abîmer la peau.

### **Ne pas placer les mains ou autres objets près de l'orifice de sortie d'air.**

- De l'air chaud sort par l'orifice de sortie d'air. Ne pas placer les mains, le visage ou d'autres objets qui ne peuvent résister à la chaleur près de cette sortie d'air [laisser un espace d'au moins 15 cm (6")], sinon des brûlures ou des dommages risqueraient de s'ensuivre.

### **Le remplacement de la lampe ne doit être effectué que par un technicien qualifié.**

- La lampe a une pression interne élevée. Si elle est manipulé incorrectement, une explosion peut s'ensuivre.
- La lampe peut être facilement endommagé si elle est heurté contre des objets durs ou si on le laisse tomber et des blessures et des mauvais fonctionnements peuvent s'ensuivre.

### **Lors du remplacement de la lampe, la laisser refroidir pendant au moins une heure avant de la manipuler.**

- Le couvercle de la lampe devient très chaud, et on risque de se brûler si on le touche.

### **Avant de remplacer la lampe, veiller à débrancher la fiche du cordon d'alimentation de la prise de courant.**

- Il y a risque d'électrocution ou d'explosion.

## **Attention**

### **Ne pas obstruer les orifices d'entrée et de sortie d'air.**

- Cela risque de faire surchauffer le projecteur, et causer un incendie ou endommager le projecteur.

- Ne pas installer le projecteur dans des endroits étroits, mal ventilés tels que des placards ou des étagères.
- Ne pas placer le projecteur sur des tissus ou du papier, ces matériaux peuvent être aspirés dans l'orifice d'entrée d'air.

**Ne pas installer le projecteur dans des endroits humides ou poussiéreux ou dans des endroits où le projecteur peut entrer en contact avec de la fumée ou la vapeur.**

- L'utilisation du projecteur dans de telles conditions peut causer un incendie ou des chocs électriques.

**Pour débrancher le cordon d'alimentation, tenir la fiche et non pas le cordon.**

- Si le cordon d'alimentation est tiré, le cordon sera endommagé et cela peut causer un incendie, des courts-circuits ou des chocs électriques sérieux.

**Débrancher toujours tous les câbles avant de déplacer le projecteur.**

- Le fait de déplacer le projecteur avec des câbles branchés peut endommager les câbles, ce qui pourrait causer un incendie ou des chocs électriques.

**Ne pas placer d'objets lourds sur le projecteur.**

- Cela peut déséquilibrer le projecteur et le faire tomber, ce qui peut entraîner des dommages ou des blessures.

**Ne pas court-circuiter, chauffer ou démonter les piles, et ne pas les mettre dans l'eau ou dans le feu.**

- Sinon, les piles risqueront de surchauffer, de fuir, d'exploser ou de prendre feu, et donc de causer des brûlures ou d'autres blessures.

**Lorsqu'on insère les piles, veiller à ce que les polarités (+ et -) soient bien respectées.**

- Si l'on insère les piles incorrectement, elles risqueront d'exploser ou de fuir, ce qui peut causer un incendie, des blessures ou une contamination du logement des piles et de la zone environnante.

**Utiliser uniquement les piles spécifiées.**

- Si l'on utilise des piles incorrectes, elles risqueront d'exploser ou de fuir, ce qui peut causer un incendie, des blessures ou une contamination du logement des piles et de la zone environnante.

**Ne pas mélanger des piles usées et des piles neuves.**

- Si l'on insère les piles incorrectement, elles risqueront d'exploser ou de fuir, ce qui peut causer un incendie, des blessures ou une contamination du logement des piles et de la zone environnante.

**Ne pas peser de tout son poids sur ce projecteur.**

- On risque de tomber ou de casser l'appareil, ce qui peut causer des blessures.
- Veiller tout particulièrement à ce que les enfants ne se tiennent pas debout ou ne s'assoient pas sur le projecteur.

**Si l'on n'utilise pas le projecteur pendant une période prolongée, débrancher la fiche du cordon d'alimentation de la prise de courant.**

- Si de la poussière s'accumule sur la fiche du cordon d'alimentation, l'humidité ainsi créée risquera d'endommager l'isolation, ce qui peut provoquer un incendie.

- Ce projecteur continue de consommer environ 3 W de courant, même lorsque l'alimentation électrique est coupée.

**Débrancher la fiche du cordon d'alimentation de la prise de courant comme mesure de sécurité avant d'effectuer tout nettoyage.**

- Sinon cela peut causer des chocs électriques.

**Si la lampe est brisée, aérer la salle immédiatement. Ne pas toucher ou approcher le visage des morceaux brisés.**

- Sinon, l'utilisateur risquera d'inhaler le gaz qui s'est dégagé lorsque la lampe s'est brisée, et qui contient à peu près la même quantité de mercure que les lampes fluorescentes, et d'être blessé par les morceaux brisés.
- Si l'on pense avoir inhalé le gaz, ou que le gaz a pénétré dans les yeux ou la bouche, consulter immédiatement un médecin.
- Demander à son revendeur de remplacer l'unité de lampe et de vérifier l'intérieur du projecteur.

**Demander à un centre technique agréé de nettoyer l'intérieur du projecteur au moins une fois par an.**

- S'il n'est pas nettoyé et que de la poussière s'accumule à l'intérieur du projecteur, cela peut causer un incendie ou des problèmes de fonctionnement.
- Il est recommandé de nettoyer l'intérieur du projecteur avant l'arrivée de la saison humide. Demander au centre technique agréé le plus proche de nettoyer le projecteur lorsque cela est requis. Se renseigner auprès du centre technique agréé pour le coût du nettoyage.

**Nous faisons tous les efforts possibles afin de préserver l'environnement. Prière de rapporter l'appareil, s'il n'est pas réparable, à votre revendeur ou à un centre de recyclage.**

## Avant l'utilisation

**Précaution à prendre lors du déplacement du projecteur**

**Veiller à bien mettre le capuchon d'objectif en place avant de déplacer le projecteur.**

L'objectif de projection est très sensible aux vibrations et aux chocs.

Lorsqu'on déplace le projecteur, utiliser la sacoche de transport fournie.

Lorsqu'on place le projecteur dans la sacoche de transport, le placer de façon que l'objectif soit orienté vers le haut. Ne pas placer le projecteur avec ses pieds réglables déployés, et ne rien mettre d'autre que le projecteur, les câbles et la télécommande dans la sacoche.

**Avertissements concernant l'installation**

**Éviter de l'installer dans les endroits sujets à des vibrations ou à des chocs.**

Les pièces internes peuvent être endommagées, ce qui peut causer des pannes ou des accidents.

**Éviter d'installer le projecteur à des endroits sujets à des changements de température brusques, à proximité d'un climatiseur par exemple.**

La durée de vie de la lampe risquerait d'être réduite.

**Ne pas installer le projecteur près de lignes d'alimentation électrique à haute tension ou de moteurs.**

Le projecteur peut être soumis à des interférences électromagnétiques.

**Si le projecteur est installé au plafond, demander à un technicien qualifié de faire tous les travaux d'installation.**

Il faut acheter le kit d'installation séparé (numéro de modèle: ET-PKB30).

En outre, tous les travaux d'installation doivent être exécutés uniquement par un technicien qualifié.

**Si l'on utilise ce projecteur à un endroit élevé (au-dessus de 1 400 m), régler la "MONTAGNE" sur "OUI" (se référer à la page 52).**

Sinon, des anomalies pourront se produire.

## Notes sur l'utilisation

**Afin d'obtenir la meilleure qualité d'image**

Fermer les rideaux ou les volets de toutes les fenêtres et éteindre les lampes fluorescentes situées à proximité de l'écran afin que la lumière extérieure ou la lumière des lampes intérieures n'éclaire pas l'écran.

**Ne pas toucher aux surfaces de l'objectif avec les mains nues.**

Si la surface de l'objectif est salie par des empreintes digitales ou autre, ceci sera agrandi et projeté sur l'écran. Par ailleurs, lorsque le projecteur n'est pas utilisé, rétracter l'objectif, puis la couvrir à l'aide du capuchon d'objectif.

### Écran

N'appliquer aucun produit volatil qui risque de décolorer l'écran, et veiller à ce que l'écran ne soit pas sale ou endommagé.

### Lampe

Il est possible qu'il faille remplacer la lampe plus tôt en raison de facteurs variables comme les caractéristiques de la lampe, des conditions d'utilisation et un environnement d'installation particuliers, notamment si elle est utilisée de façon continue pendant plus de 10 heures ou si l'alimentation est fréquemment mise en et hors circuit.

### Affichage à cristaux liquides

L'affichage à cristaux liquides du projecteur a été fabriqué en utilisant une technologie de haute précision afin d'offrir une image très détaillée. Il est possible que parfois quelques pixels non actifs apparaissent sur l'écran sous forme de points fixes bleus, verts ou rouges. Bien noter que ceci n'affecte pas le bon fonctionnement de votre LCD.



# Remplacement du bloc de lampe

## AVERTISSEMENT

Le bloc de lampe ne devrait être remplacé que par un technicien qualifié.

Lors du remplacement de la lampe, la laisser refroidir pendant au moins une heure avant de la manipuler.

- Le couvercle de la lampe devient très chaud, et on risque de se brûler si on le touche.

## Notes sur le remplacement du bloc de lampe

- La lampe produisant la lumière est en verre; il ne faut donc pas la laisser tomber ou la cogner contre des objets rigides, car elle risquerait d'éclater. Faire bien attention lorsqu'on manipule la lampe.
- Jeter la lampe usagée de la même manière qu'une lampe fluorescente.
- Il faut utiliser un tournevis Phillips pour déposer le bloc de lampe.

### REMARQUE:

- Le projecteur n'est pas fourni avec un bloc de lampe de rechange. Demander les détails au revendeur. Numéro de produit du bloc de lampe:

**ET-LAB30**

### ATTENTION!



- Ne pas utiliser un bloc de lampe avec un numéro de pièce autre que celui indiqué ci-dessus.

## Période de remplacement du bloc de lampe

La lampe est un produit qui doit être remplacé. Même si la durée de vie complète de l'ampoule n'est pas encore épuisée, la luminosité de la lampe diminuera progressivement. Il faut donc remplacer périodiquement la lampe. L'intervalle de remplacement de la lampe prévu est de 2 000 heures; il est toutefois possible qu'il faille remplacer la lampe avant ce délai en raison d'éléments variables comme les caractéristiques particulières de la lampe, les conditions d'utilisation et l'environnement d'installation. Il est recommandé de toujours avoir un bloc de lampe de rechange prêt à l'emploi. La lampe s'éteindra automatiquement après environ 10 minutes lorsque la limite de 2 000 heures d'utilisation est atteinte, car le risque d'explosion de la lampe devient beaucoup plus grand passé cette limite.

### REMARQUE:

- Les heures d'utilisation expliquées ci-dessus concernent l'utilisation lorsque "PUISSANCE DE LA LAMPE" dans le menu "OPTION" a été réglée sur "MODE STANDARD" et lorsque "AI" dans le menu "IMAGE" a été réglé sur "NON". Si "PUISSANCE DE LA LAMPE" est réglée sur "MODE ÉCO", ou si "AI" est réglé sur "OU", la durée de vie de la lampe peut être allongée.
- Bien que le délai de 2 000 heures soit l'intervalle de remplacement prévu, l'obtention de cette durée n'est pas couverte par la garantie.

	Affichage à l'écran	Indicateur LAMP
		
Plus de 1 800 heures	Affiché pendant 30 secondes. L'affichage disparaît si l'on appuie sur n'importe quelle touche.	S'allume en rouge pendant que l'image est projetée et en mode d'attente.
Plus de 2 000 heures	Reste affiché jusqu'à ce qu'une touche quelconque soit pressée.	

## Méthode de remplacement du bloc de lampe

### REMARQUE:

- Si la durée d'utilisation de la lampe a dépassée 2 000 heures (lorsque "PUISSANCE DE LA LAMPE" a été réglé sur "MODE STANDARD" et lorsque "AI" a été réglé sur "NON"), le projecteur passe en mode d'attente après environ 10 minutes de fonctionnement. Dès lors, faire les étapes ⑦ à ⑫ à la page suivante dans les 10 minutes.

- ① **Débrancher le cordon d'alimentation du projecteur en procédant comme indiqué à la page 28, puis vérifier si la zone environnant le bloc de lampe s'est bien refroidie.**
- ② **Utiliser un tournevis Phillips pour desserrer les vis de fixation du couvercle du bloc de lampe sur le fond du projecteur, puis enlever le couvercle du bloc de lampe.**

Couvercle du bloc de lampe

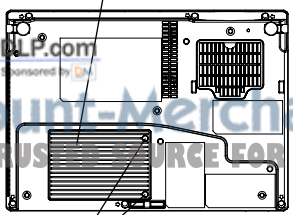

Vis de fixation du couvercle du bloc de lampe

- ③ **Utiliser un tournevis Phillips pour desserrer les deux vis de fixation du bloc de lampe jusqu'à ce que les vis tournent librement. Puis tenir les poignées du bloc de lampe et tirer doucement le bloc de lampe pour le faire sortir du projecteur.**

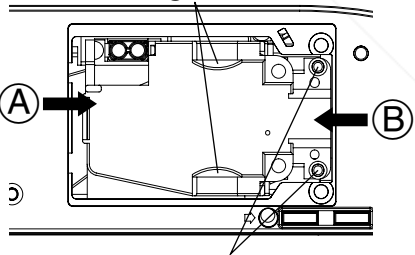

Vis de fixation du bloc de lampe

- ④ **Insérer le bloc de lampe neuf tout en s'assurant que le sens d'insertion est correct, puis utiliser un tournevis Phillips pour resserrer fermement les vis de fixation du bloc de lampe.**  
Lors de l'insertion du bloc de lampe neuf, veiller à le pousser aux points A et B.

- ⑤ **Installer le couvercle du bloc de lampe, puis utiliser un tournevis Phillips pour resserrer fermement les vis de fixation du couvercle du bloc de lampe.**

**REMARQUE:**

- S'assurer de bien installer le bloc de lampe et le couvercle du bloc de lampe. S'ils ne sont pas bien installés, cela peut déclencher le circuit de protection et le projecteur ne pourra pas être allumé.

- ⑥ **Brancher le cordon d'alimentation.**

- ⑦ **Appuyer sur la touche POWER pour projeter une image sur l'écran.**

**REMARQUE:**

- Si "DÉMARRAGE DIRECT" a été réglé sur "OUI" dans le menu "OPTION", la projection démarrera une fois que le cordon d'alimentation aura été connecté. Pour plus de détails, se référer à la page 51.

- ⑧ **Appuyer sur la touche MENU pour faire apparaître l'écran de menu, puis appuyer sur la touche ▲ ou ▼ pour sélectionner le menu "OPTION".**

- ⑨ **Appuyer sur la touche ENTER, puis appuyer sur la touche ▲ ou ▼ pour sélectionner "DURÉE DE LA LAMPE".**

- ⑩ **Maintenir la touche ENTER enfoncée pendant environ 3 secondes.**  
L'écran "DURÉE LAMPE" apparaîtra alors.

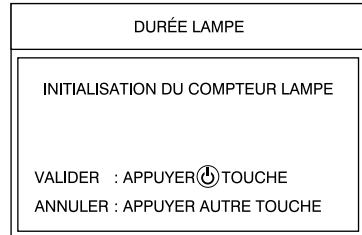

**REMARQUE:**

- Appuyer sur une touche autre que la touche POWER pour annuler l'écran "DURÉE LAMPE".

- ⑪ **Appuyer sur la touche POWER pour éteindre le projecteur.**

- ⑫ **Débrancher le cordon d'alimentation après que la touche POWER du projecteur s'allume en rouge.**

Le temps d'utilisation total du bloc de lampe est alors remis à zéro.



# Disclaimer

This user manual is provided as a free service by FixYourDLP.com. FixYourDLP is in no way responsible for the content of this manual, nor do we guarantee its accuracy. FixYourDLP does not make any claim of copyright and all copyrights remain the property of their respective owners.

About FixYourDLP.com

FixYourDLP.com (<http://www.fixyourdpl.com>) is the World's #1 resource for media product news, reviews, do-it-yourself guides, and manuals.

Informational Blog: <http://www.fixyourdpl.com>

Video Guides: <http://www.fixyourdpl.com/guides>

User Forums: <http://www.fixyourdpl.com/forum>

FixYourDLP's Fight Against Counterfeit Lamps:

<http://www.fixyourdpl.com/counterfeits>

## Sponsors:

RecycleYourLamp.org – Free lamp recycling services for used lamps:

<http://www.recycleyourlamp.org>

Lamp Research - The trusted 3rd party lamp research company:

<http://www.lampresearch.com>

Discount-Merchant.com – The worlds largest lamp distributor:

<http://www.discount-merchant.com>



**FixYourDLP.com**

Sponsored by 