



Disclaimer

This user manual is provided as a free service by FixYourDLP.com. FixYourDLP is in no way responsible for the content of this manual, nor do we guarantee its accuracy. FixYourDLP does not make any claim of copyright and all copyrights remain the property of their respective owners.

About FixYourDLP.com

FixYourDLP.com (<http://www.fixyourdpl.com>) is the World's #1 resource for media product news, reviews, do-it-yourself guides, and manuals.

Informational Blog: <http://www.fixyourdpl.com>

Video Guides: <http://www.fixyourdpl.com/guides>

User Forums: <http://www.fixyourdpl.com/forum>

FixYourDLP's Fight Against Counterfeit Lamps:

<http://www.fixyourdpl.com/counterfeits>

Sponsors:

RecycleYourLamp.org – Free lamp recycling services for used lamps:

<http://www.recycleyourlamp.org>

Lamp Research - The trusted 3rd party lamp research company:

<http://www.lampresearch.com>

Discount-Merchant.com – The worlds largest lamp distributor:

<http://www.discount-merchant.com>



FixYourDLP.com

Sponsored by 

Panasonic®

LCD Projector Commercial Use

Operating Instructions

ENGLISH

Model No. **PT-P1SDU**

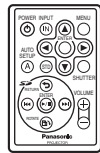
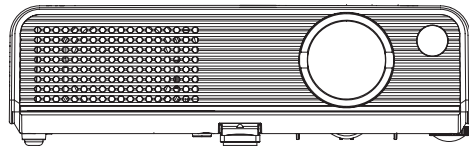

 FixYourDLP.com
Sponsored by 

Discount-Merchant.com (800) 281-8860
THE TRUSTED SOURCE FOR PROJECTOR LAMPS AND ACCESSORIES

Before operating this product, please read the instructions carefully and save this manual for future use.

TQBJ 0184

Dear Panasonic Customer:

This instruction booklet provides all the necessary operating information that you might require. We hope it will help you to get the most out of your new product, and that you will be pleased with your Panasonic LCD projector. The serial number of your product can be found on its bottom. You should note it in the space provided below and retain this booklet in case service is required.

Model number: **PT-P1SDU**

Serial number: _____

IMPORTANT SAFETY NOTICE

WARNING: TO REDUCE THE RISK OF FIRE OR ELECTRIC SHOCK, DO NOT EXPOSE THIS PRODUCT TO RAIN OR MOISTURE.

Power Supply: This LCD Projector is designed to operate on 100 V – 240 V, 50 Hz/60 Hz AC, house current only.

CAUTION: The AC power cord which is supplied with the projector as an accessory can only be used for power supplies up to 125 V, 7 A. If you need to use higher voltages or currents than this, you will need to obtain a separate 250 V power cord. If you use the accessory cord in such situations, fire may result.



The lightning flash with arrowhead symbol, within an equilateral triangle, is intended to alert the user to the presence of uninsulated “dangerous voltage” within the product’s enclosure that may be of sufficient magnitude to constitute a risk of electric shock to persons.



The exclamation point within an equilateral triangle is intended to alert the user to the presence of important operating and maintenance (servicing) instructions in the literature accompanying this product.

CAUTION:

This equipment is equipped with a three-pin grounding-type power plug. Do not remove the grounding pin on the power plug. This plug will only fit a grounding-type power outlet. This is a safety feature. If you are unable to insert the plug into the outlet, contact an electrician. Do not defeat the purpose of the grounding plug.

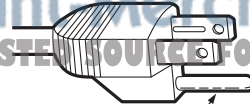

Do not remove

WARNING:

Do not look into the lens while the projector is being used.



- Strong light is emitted from the projector’s lens. If you look directly into this light, it can hurt and damage your eyes.
- Be especially careful not to let young children look into the lens. In addition, disconnect the power cord plug when you are away from the projector.

WARNING:

This equipment has been tested and found to comply with the limits for a Class B digital device, pursuant to Part 15 of the FCC Rules. These limits are designed to provide reasonable protection against harmful interference in a residential installation. This equipment generates, uses and can radiate radio frequency energy and, if not installed and used in accordance with the instructions, may cause harmful interference to radio communications. However, there is no guarantee that interference will not occur in a particular installation. If this equipment does cause harmful interference to radio or television reception, which can be determined by turning the equipment off and on, the user is encouraged to try to correct the interference by one or more of the following measures:

- Reorient or relocate the receiving antenna.
- Increase the separation between the equipment and receiver.
- Connect the equipment into an outlet on a circuit different from that to which the receiver is connected.
- Consult the dealer or an experienced radio/TV technician for help.

FCC CAUTION: To assure continued compliance, use only shielded interface cables when connecting to computers or peripheral devices. Any unauthorized changes or modifications to this equipment will void the users authority to operate.

WARNING:

- Not for use in a computer room as defined in the Standard for the Protection of Electronic Computer/Data Processing Equipment, ANSI/NFPA 75.
- For permanently connected equipment, a readily accessible disconnect device shall be incorporated in the building installation wiring;
- For pluggable equipment, the socket-outlet shall be installed near the equipment and shall be easily accessible.

Declaration of Conformity

Model Number: PT-P1SDU
Trade Name: **Panasonic**
Responsible party: Panasonic Corporation of North America
Address: (908) 281-1660 One Panasonic Way Secaucus New Jersey 07094
Telephone number: 1-800-528-8601 or 1-800-222-0741
Email: pbtsservice@panasonic.com

This device complies with Part 15 of the FCC Rules. Operation is subject to the following two conditions: (1) This device may not cause harmful interference, and (2) this device must accept any interference received, including interference that may cause undesired operation.

Contents

Preparation

IMPORTANT SAFETY NOTICE ...	2
Precautions with regard to safety	5
Accessories	9
Before use	10
Read this page first	12
Location and function of each part.....	14
Getting started	
Setting-up.....	20
Projection methods, Projector position, Projection distances	
Connections.....	22
Connecting to computer, Connecting to video equipment,	
Preparation for the remote control unit.....	24
Basic operation	
Turning on the power.....	26
Turning off the power.....	28
Useful functions	
Correcting the image position automatically.....	30
Turning off the picture and sound momentarily	31
Adjusting the volume	31
Using the SD memory card.....	32
Inserting and removing the SD memory card, SD selection screen	
Playing back images from a SD memory card.....	35
Button functions during playback	
Setting a detailed playback method for the SD memory card	37
MODE, AUTO PLAY, INTERVAL, EFFECT, AUDIO	
Making a presentation without using a computer.....	39
Adjustments and settings	
On-screen menus	40
Menu screens, Menu operation	

guide, Returning a setting to the factory default	
Adjusting the picture.....	44
PICTURE MODE, DAYLIGHTVIEW, DETAILED SETUP	
Adjusting the position.....	46
KEYSTONE, ASPECT, POSITION, DETAILED SETUP	
Other settings	49
AUTO SIGNAL, TV-SYSTEM, FRONT/REAR, DESK/CEILING, HIGHLAND, LAMP RUNTIME, SXGA MODE, CTRL PANEL, NR	
Changing the display language.....	51
Setting up the security function	52
SETUP, AMEND PASSWORD, TO REGISTER SD KEY 1(2), INSERTED SD KEY	
Care and maintenance	
When the TEMP indicator and the LAMP indicator are illuminated.....	54
Cleaning and replacing the air filter	56
Replacing the lamp unit	57
Before calling for service.....	60
Cleaning and maintenance	62
Others	
Specifications	63
Appendix	65
List of compatible signals, DCF standard, Guide screen for computer connection, Projection dimensions calculation methods	
Dimensions	69
Trademark	
acknowledgements	70
NOTES IMPORTANTES CONCERNANT LA SECURITE..	71
Précautions de sécurité	72
Avant l'utilisation.....	76
Remplacement du bloc de lampe...78	

Precautions with regard to safety

WARNING

If you notice smoke, strange smells or noise coming from the projector, disconnect the power cord plug from the wall outlet.

- Do not continue to use the projector in such cases, otherwise fire or electric shocks could result.
- Check that no more smoke is coming out, and then contact an Authorized Service Center for repairs.
- Do not attempt to repair the projector yourself, as this can be dangerous.

Do not install this projector in a place which is not strong enough to take the full weight of the projector.

- If the installation location is not strong enough, it may fall down or tip over, and severe injury or damage could result.

Installation work (such as ceiling suspension) should only be carried out by a qualified technician.

- If installation is not carried out correctly, there is the danger that injury or electric shocks may occur.

If foreign objects or water get inside the projector, or if the projector is dropped or the cabinet is broken, disconnect the power cord plug from the wall outlet.

- Continued use of the projector in this condition may result in fire or electric shocks.
- Contact an Authorized Service Center for repairs.

Do not overload the wall outlet.

- If the power supply is overloaded (for example, by using too many adapters), overheating may occur and fire may result.

Do not remove the cover or modify it in any way.

- High voltages can cause fire or electric shocks.
- For any inspection, adjustment and repair work, please contact an Authorized Service Center.

Clean the power cord plug regularly to prevent it from becoming covered in dust.

- If dust builds up on the power cord plug, the resulting humidity can damage the insulation, which could result in fire. Pull the power cord plug out from the wall outlet and wipe it with a dry cloth.
- If not using the projector for an extended period of time, pull the power cord plug out from the wall outlet.

Do not do anything that might damage the power cord or the power cord plug.

- Do not damage the power cord, make any modifications to it, place it near any hot objects, bend it excessively, twist it, pull it, place heavy objects on top of it or wrap it into a bundle.
- If the power cord is used while damaged, electric shocks, short-circuits or fire may result.
- Ask an Authorized Service Center to carry out any repairs to the power cord that might be necessary.

Do not handle the power cord plug with wet hands.

- Failure to observe this may result in electric shocks.

Insert the power cord plug securely into the wall outlet.

- If the plug is not inserted correctly, electric shocks or overheating could result.
- Do not use plugs which are damaged or wall outlet which are coming loose from the wall.

Do not place the projector on top of surfaces which are unstable.

- If the projector is placed on top of a surface which is sloped or unstable, it may fall down or tip over, and injury or damage could result.

Do not place the projector into water or let it become wet.

- Failure to observe this may result in fire or electric shocks.

Do not place the projector on soft materials such as carpets or sponge mats.

- Doing so may cause the projector to overheat, which can cause burns, fire or damage to the projector.

Do not place liquid containers on top of the projector.

- If water spills onto the projector or gets inside it, fire or electric shocks could result.
- If any water gets inside the projector, contact an Authorized Service Center.

Do not insert any foreign objects into the projector.

- Do not insert any metal objects or flammable objects into the projector or drop them onto the projector, as doing so can result in fire or electric shocks.

Keep the SD memory card (sold separately) and batteries out of the reach of infants.

- If the SD memory card and batteries are swallowed, death by suffocation may result. If you believe that the SD memory card and batteries may have been swallowed, seek medical advice immediately.

Do not allow the + and - terminals of the batteries to come into contact with metallic objects such as necklaces or hairpins.

- Failure to observe this may cause the batteries to leak, overheat, explode or catch fire.
- Store the batteries in a plastic bag and keep them away from metallic objects.

During a thunderstorm, do not touch the projector or the cable.

- Electric shocks can result.

Do not use the projector in a bath or shower.

- Fire or electric shocks can result.

Do not place your skin into the light beam while the projector is being used.

- Strong light is emitted from the projector's lens. If you place directly into this light, it can hurt or damage your skin.

Do not place your hands or other objects close to the air outlet port.

- Heated air comes out of the air outlet port. Do not place your hands or face, or objects which cannot withstand heat close to this port [allow at least 10cm (4") of space], otherwise burns or damage could result.

Replacement of the lamp should only be carried out by a qualified technician.

- The lamp has high internal pressure. If improperly handled, explosion might result.
- The lamp can easily become damaged if struck against hard objects or dropped, and injury or malfunctions may result.

When replacing the lamp, allow it to cool for at least one hour before handling it.

- The lamp cover gets very hot, and touching it can cause burns.

Before replacing the lamp, be sure to disconnect the power cord plug from the wall outlet.

- Electric shocks or explosions can result if this is not done.

Caution

Do not cover the air inlet port or the air outlet port.

- Doing so may cause the projector to overheat, which can cause fire or damage to the projector.
- Do not place the projector in narrow, badly ventilated places such as closets or bookshelves.
- Do not place the projector on cloth or papers, as these materials could be drawn into the air inlet port.

Do not set up the projector in humid or dusty places or in places where the projector may come into contact with smoke or steam.

- Using the projector under such conditions may result in fire or electric shocks.

When disconnecting the power cord, hold the plug, not the cord.

- If the power cord itself is pulled, the cord will become damaged, and fire, short-circuits or serious electric shocks may result.

Always disconnect all cables before moving the projector.

- Moving the projector with cables still attached can damage the cables, which could cause fire or electric shocks to occur.

Do not place any heavy objects on top of the projector.

- Failure to observe this may cause the projector to become unbalanced and fall, which could result in damage or injury.

Do not short-circuit, heat or disassemble the batteries or place them into water or fire.

- Failure to observe this may cause the batteries to overheat, leak, explode or catch fire, and burns or other injury may result.

When inserting the batteries, make sure the polarities (+ and -) are correct.

- If the batteries are inserted incorrectly, they may explode or leak, and fire, injury or contamination of the battery compartment and surrounding area may result.

Use only the specified batteries.

- If incorrect batteries are used, they may explode or leak, and fire, injury or contamination of the battery compartment and surrounding area may result.

Insulate the battery using tape or similar before disposal.

- If the battery comes into contact with metallic objects or other batteries, it may catch fire or explode.

Do not put your weight on this projector.

- You could fall or the projector could break, and injury may result.
- Be especially careful not to let young children stand or sit on the projector.

If not using the projector for an extended period of time, disconnect the power cord plug from the wall outlet.

- If dust builds up on the power cord plug, the resulting humidity may damage the insulation, which could result in fire.
- This projector continues to draw approximately 3 W of power even when the power is turned off.

Disconnect the power cord plug from the wall outlet as a safety precaution before carrying out any cleaning.

- Electric shocks can result if this is not done.

If the lamp has broken, ventilate the room immediately. Do not touch or bring your face close to the broken pieces.

- Failure to observe this may cause the user to absorb the gas which was released when the lamp broke and which contains nearly the same amount of mercury as fluorescent lamps, and the broken pieces may cause injury.
- If you believe that you have absorbed the gas or that the gas has got into your eyes or mouth, seek medical attention immediately.
- Ask your dealer to replace the lamp unit and check the inside of the projector.

Ask an Authorized Service Center to clean inside the projector at least once a year.

- If dust is left to build up inside the projector without being cleaned out, it can result in fire or problems with operation.

- It is a good idea to clean the inside of the projector before the season for humid weather arrives. Ask your nearest Authorized Service Center to clean the projector when required. Please discuss with the Authorized Service Center regarding cleaning costs.



We are constantly making efforts to preserve and maintain a clean environment. Please take non repairable units back to your dealer or a recycling company.

NOTICE:

- This product has a High Intensity Discharge (HID) lamp that contains a small amount of mercury. It also contains lead in some components. Disposal of these materials may be regulated in your community due to environmental considerations. For disposal or recycling information please contact your local authorities, or the Electronics Industries Alliance: <<http://www.eiae.org>>

Accessories

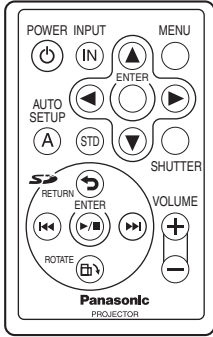
Check that all of the accessories shown below have been included with your projector.

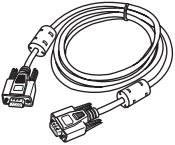
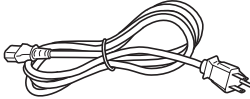
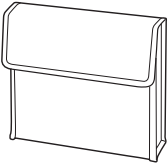
Card remote control unit (N2QAYC000001 x1)	Lithium battery for remote control unit (CR-2025 x1)	RGB signal cable [1.8 m (5'10"), K1HA15DA0002 x1]
		
	Power cord (K2CG3DR00005 x 1)	Softcase (TPEP017 x 1)
		

Before use

Caution when moving the projector

Be sure to check that the lens cover has been attached to the lens before moving the projector.

The projection lens is extremely susceptible to vibration and shocks. When moving the projector, use the accessory softcase. When placing the projector inside the softcase, position it so that the lens is facing upward.

Do not put anything else in the softcase other than the projector, cables, remote control unit and the SD memory card.

Cautions regarding setting-up

Avoid setting up in places which are subject to vibration or shocks.

The internal parts can be damaged, which may cause malfunctions or accidents.

Avoid setting up in places which are subject to sudden temperature changes, such as near an air conditioner.

The life of the lamp may be shortened.

Do not set up the projector near high-voltage power lines or near motors.

The projector may be subject to electromagnetic interference.

If installing the projector to the ceiling, ask a qualified technician to carry out all installation work.

You will need to purchase the separate installation kit (Model No.ET-PKP1). Furthermore, all installation work should only be carried out by a qualified technician.

If using this projector at high elevations (above 1 400 m), set the "HIGHLAND" to "ON". (Refer to page 50.)

Failure to observe this may result in malfunctions.

Notes on use

In order to get the best picture quality

Draw curtains or blinds over any windows and turn off any lights near the screen to prevent outside light or light from indoor lamps from shining onto the screen.

Do not touch the glass parts of the lens and the lens cover with your bare hands.

If the glass parts of the lens and the lens cover become dirty from fingerprints or anything else, it will be magnified and projected onto the screen.

Screen

Do not apply any volatile substances which may cause discoloration to the screen, and do not let it become dirty or damaged.

SD memory card slot

Make sure that there are no foreign objects inside the slot when inserting the SD memory card (sold separately). Failure to observe this may damage the card and the slot.

Lamp

The lamp may need to be replaced earlier due to variables such as individual lamp characteristics, usage conditions and the installation environment, especially when the projector is subjected to continuous use for more than 10 hours or the power is frequently turned on and off.

Liquid crystal panel

The liquid crystal panel of the projector is built with very high precision technology to provide fine picture details. Occasionally, a few non-active pixels may appear on the screen as fixed points of blue, green or red. Please note that this does not affect the performance of your LCD.



Discount-Merchant.com (800) 281-8860
THE TRUSTED SOURCE FOR PROJECTOR LAMPS AND ACCESSORIES



FixYourDLP.com

Sponsored by 

Discount-Merchant.com (800) 281-8860

THE TRUSTED SOURCE FOR PROJECTOR LAMPS AND ACCESSORIES

Location and function of each part

Projector <Top, right and front>

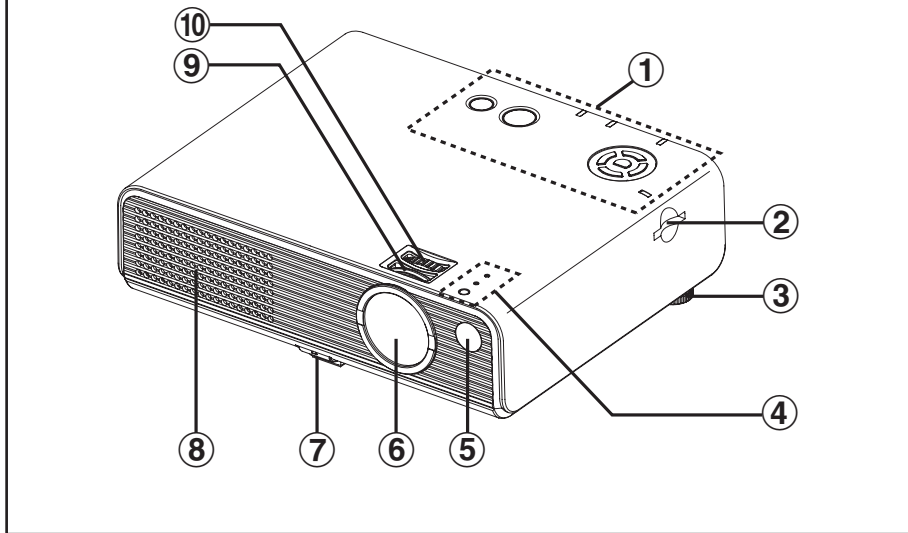

- ① **Projector control panel** (page 16)
- ② **SD memory card slot**
- ③ **Back adjustable leg** (page 27)
- ④ **Illumination sensor and LAMP/TEMP indicators** (page 16)
- ⑤ **Remote control signal receptor** (page 24)
- ⑥ **Lens cover** (page 62)
Use the projector with the lens cover attached.
- ⑦ **Front leg adjuster button** (page 27)
This button is used to unlock the front adjustable leg. Press to adjust the angle of tilt of the projector.
- ⑧ **Air inlet port**
Do not cover this port.
- ⑨ **Focus ring** (page 27)
- ⑩ **Zoom ring** (page 27)

Projector <Back and bottom>

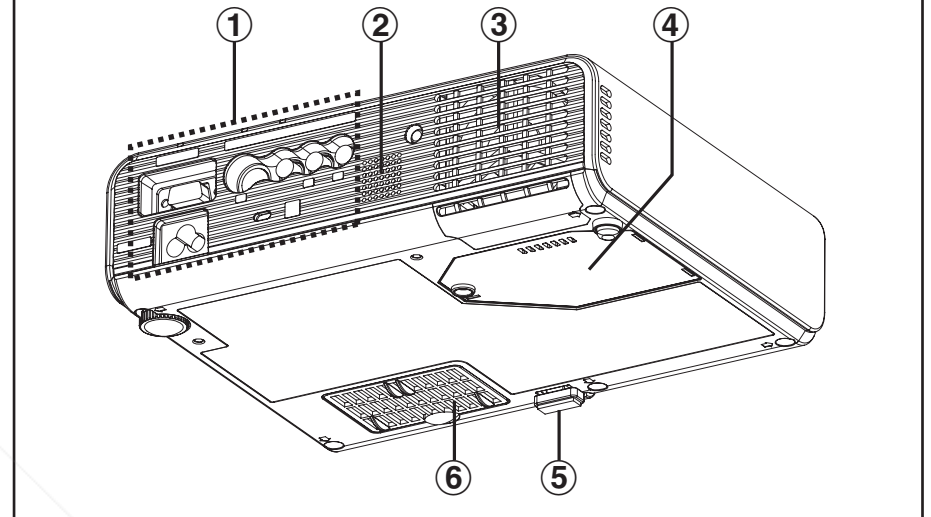

- ① **Connector panel** (page 19)
- ② **Speaker**
- ③ **Air outlet port**
Do not cover this port.
- ④ **Lamp unit cover** (page 58)
- ⑤ **Front adjustable leg** (page 27)
- ⑥ **Air inlet port, Air filter** (page 56)
Do not cover this port.

NOTE:

- During projection of an image, the cooling fan will operate, emitting a small noise as it operates. This noise may change depending on the ambient temperature. Turning the lamp on or off will cause this noise to increase a little.

WARNING

- Do not place your hands or other objects close to the air outlet port.**
- Heated air comes out of the air outlet port. Do not place your hands or face, or objects which cannot withstand heat close to this port [allow at least 10cm (4") of space], otherwise burns or damage could result.

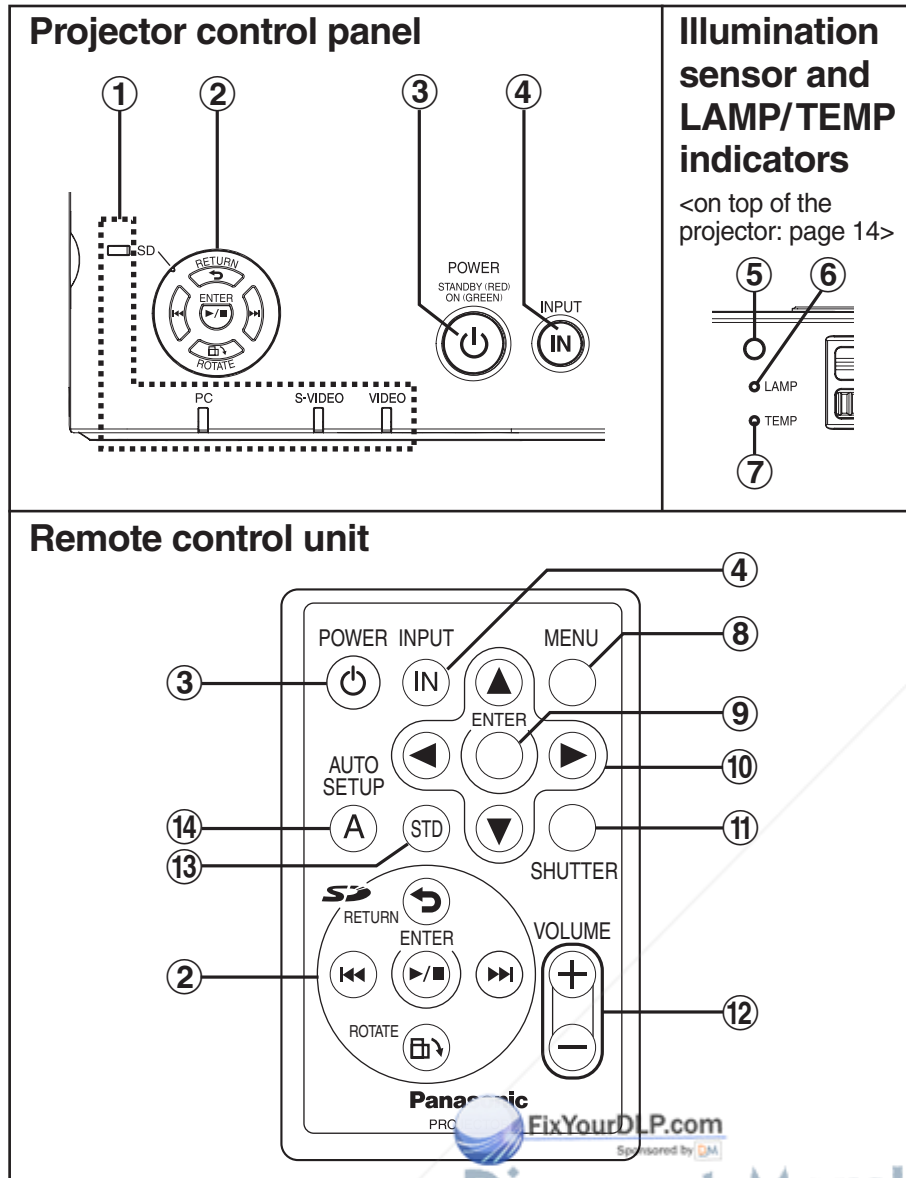

- ② **SD operation buttons** (pages 18 and 35)
 These buttons are used for operation when the SD selection screen is being displayed and when files in the SD memory card are being played back.
- ③ **POWER button** (pages 26, 28 and 29)
 This button is used to turn the power on and off. This button on the projector illuminates red when the projector is in standby mode, and it illuminates green when a picture starts to be projected.
- ④ **INPUT button** (page 27)
 This button is used to switch the input signals from the connected equipment.
- ⑤ **Illumination sensor** (page 44)
 This sensor detects the luminance when the “DAYLIGHTVIEW” function is operating. Do not cover the projector and do not place any object on the projector when using it.
- ⑥ **LAMP indicator** (page 55)
 This indicator illuminates when it is time to replace the lamp unit. It flashes if a circuit abnormality is detected.
- ⑦ **TEMP indicator** (page 54)
 This indicator illuminates if an abnormally high temperature is detected inside the projector or around it. If the temperature rises above a certain level, the power supply will be turned off automatically and the indicator will flash.
- ⑧ **MENU button** (pages 40 and 42)
 This button is used to display the “MAIN MENU”. When a menu screen is being displayed, this button can be used to return to a previous screen or to clear the screen.
- ⑨ **ENTER button** (page 42)
 This button is used to accept and to activate items selected in the on-screen menus.
- ⑩ **Arrow (▲▼◀▶) buttons** (page 42)
 These buttons are used to select and adjust items in the on-screen menus.
- ⑪ **SHUTTER button** (page 31)
 This button is used to momentarily turn off the picture and sound.
- ⑫ **VOLUME +/- buttons** (page 31)
 These buttons are used to adjust the volume of the sound output from the projector’s built-in speaker.
- ⑬ **STD (standard) button** (page 43)
 This button is used to reset the projector adjustment values to the factory default settings.
- ⑭ **AUTO SETUP button** (pages 27 and 30)
 If this button is pressed while a PC signal is being projected, the position of the image and the settings for “DOT CLOCK” and “CLOCK PHASE” will be adjusted automatically.

① **Input signal indicators**

These indicators illuminate when a signal is being input to the connector that has been selected using the INPUT button. The indicators flash when no signal is being input to the connector that was selected using the INPUT button and when signals that are not compatible with the projector are being input.

SD operation buttons

<Projector control panel: page 16>

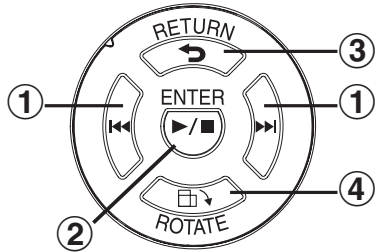

<Remote control unit: page 16>

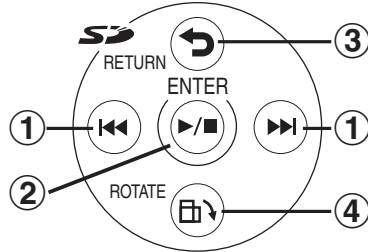

① SD ◀▶ button

These buttons are used to select folders and files on the SD selection screen.

<When a file is being played back>

Press the SD ◀ button to switch to the previous file, and the SD ▶ button to switch to the next file.

You can start and stop the slide show by holding down the SD ▶▶ button.

② SD ENTER button

This button is used to accept the selection made on the SD selection screen.

③ SD RETURN button

This button is used to return to the previous screen.

④ SD ROTATE button

Each press of this button rotates the still image being played back 90 degrees clockwise.

Connector panel

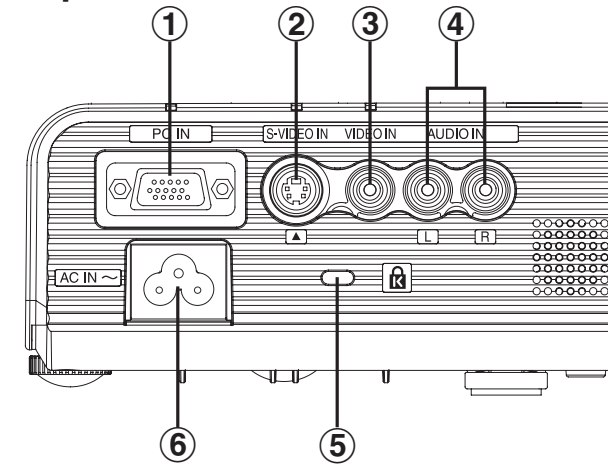

① PC IN connector (pages 22 and 23)

This connector is used to input PC signals and YPBPR signals.

② S-VIDEO IN connector (pages 23 and 47)

This connector is used to input signals from S-VIDEO-compatible equipment such as a DVD player. The connector is S1 signal compatible, and it automatically switches between 16:9 and 4:3 aspect ratios in accordance with the type of signal being input.

③ VIDEO IN connector (page 23)

This connector is used to input video signals from video equipment such as a video deck.

④ AUDIO IN L-R connectors (pages 22 and 23)

⑤ Security lock

This can be used to connect a commercially-available theft-prevention cable (manufactured by Kensington). This security lock is compatible with the Microsaver Security System from Kensington.

⑥ Power input socket (AC IN) (page 26)

The accessory power cord is connected here.

Do not use any power cord other than the accessory power cord.



Discount-Merchant.com (800) 281-8860
THE TRUSTED SOURCE FOR PROJECTOR LAMPS AND ACCESSORIES

Setting-up

Projection methods

In way of installing projector, any one of the following four projection methods are used. Select whichever projection method matches the setting-up method. (The projection method can be set from the "OTHER SETUP" menu. Refer to page 50 for details.)

• Front-desk projection

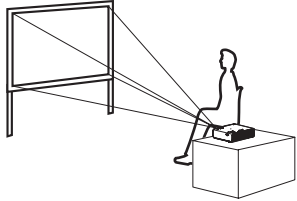

Menu items	Setting
FRONT/REAR	FRONT
DESK/CEILING	DESK

• Front-ceiling projection

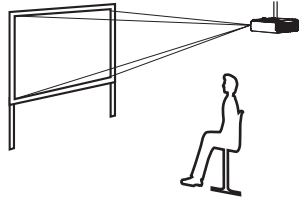

Menu items	Setting
FRONT/REAR	FRONT
DESK/CEILING	CEILING

• Rear-desk projection (Using a translucent screen)

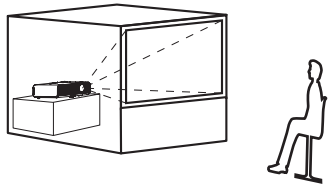

Menu items	Setting
FRONT/REAR	REAR
DESK/CEILING	DESK

• Rear-ceiling projection (Using a translucent screen)

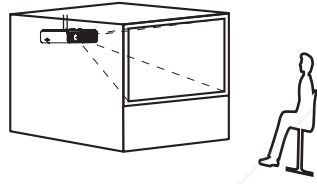

Menu items	Setting
FRONT/REAR	REAR
DESK/CEILING	CEILING

NOTE:

- You will need to purchase the separate ceiling bracket (ET-PKP1) when using the ceiling installation method.
- Do not set up the projector vertically or tilted horizontally, otherwise it may cause damage to the projector.
- It is recommended that you set up the projector in a place that is tilted at less than $\pm 30^\circ$ vertically. Setting up the projector in places that are tilted at more than $\pm 30^\circ$ vertically may shorten component life.

Projector position

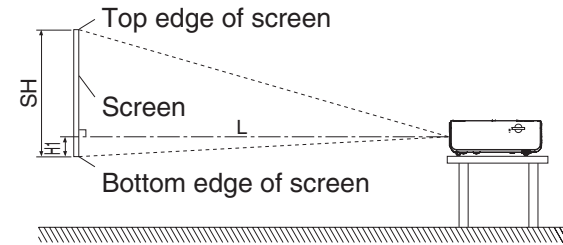

L: Projection distance
SH: Image height
SW: Image width
H1: Distance from center of lens to bottom edge of projected image

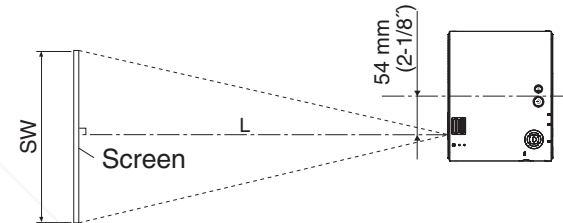

Projection distances

4:3 Screen size (diagonal)	Projection distance (L)		Height position (H1)
	Wide (LW)	Telephoto (LT)	
1.02 m(40")	—	1.2 m(3'11")	0.13 m(5-3/32")
1.14 m(45")	1.3 m(4'3")	1.4 m(4'7")	0.15 m(5-7/8")
1.27 m(50")	1.4 m(4'7")	1.6 m(5'2")	0.17 m(6-11/16")
1.52 m(60")	1.7 m(5'6")	1.9 m(6'2")	0.20 m(7-27/32")
1.78 m(70")	2.0 m(6'6")	2.2 m(7'2")	0.23 m(9-1/32")
2.03 m(80")	2.3 m(7'6")	2.6 m(8'6")	0.26 m(10-7/32")
2.29 m(90")	2.5 m(8'2")	2.9 m(9'6")	0.30 m(11-25/32")
2.54 m(100")	2.8 m(9'2")	3.2 m(10'5")	0.33 m(12-31/32")
3.05 m(120")	3.4 m(11'1")	3.9 m(12'9")	0.40 m(15-23/32")
3.81 m(150")	4.2 m(13'9")	4.9 m(16')	0.50 m(19-21/32")
5.08 m(200")	5.6 m(18'4")	6.6 m(21'7")	0.66 m(25-31/32")
6.35 m(250")	7.0 m(22'11")	8.2 m(26'10")	0.83 m(32-21/32")
7.62 m(300")	8.4 m(27'6")	9.9 m(32'5")	0.99 m(38-31/32")

NOTE:

- The dimensions in the table above are approximate.
- For details about projected image distances, refer to page 68.

Connections

Notes on connections

- Read the instruction manual for each peripheral device carefully before connecting it.
- Turn off the power supply for all peripheral devices before making any connections.
- If the cables necessary for connection are not included with the peripheral device or available as an option, you may need to prepare a proper cable for the device concerned.
- If there is a lot of jitter in the video signal, the projected image may flicker. In such cases, it will be necessary to connect a TBC (time base corrector).
- Refer to the list on page 65 for details on compatible signals which can be input to the projector.
- Only one audio system circuit is available for the AUDIO IN L-R connectors, so if you change the audio input source, you will need to remove and insert the appropriate plugs.

Connecting to computer

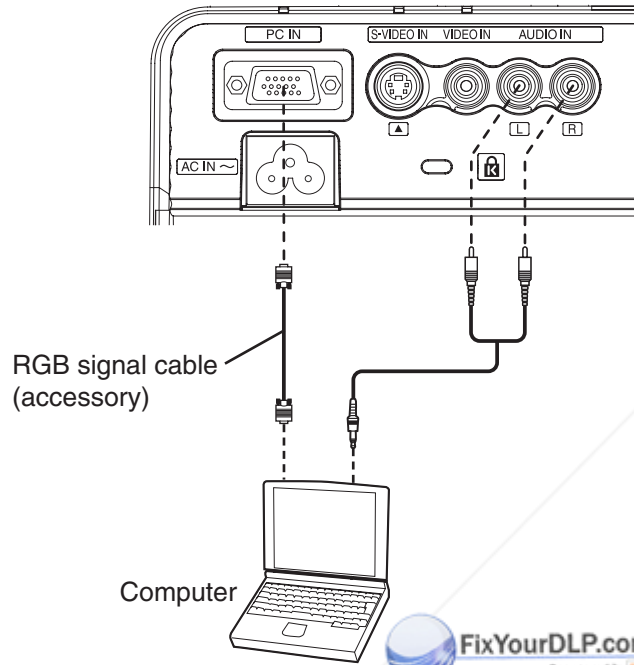

Connecting to video equipment

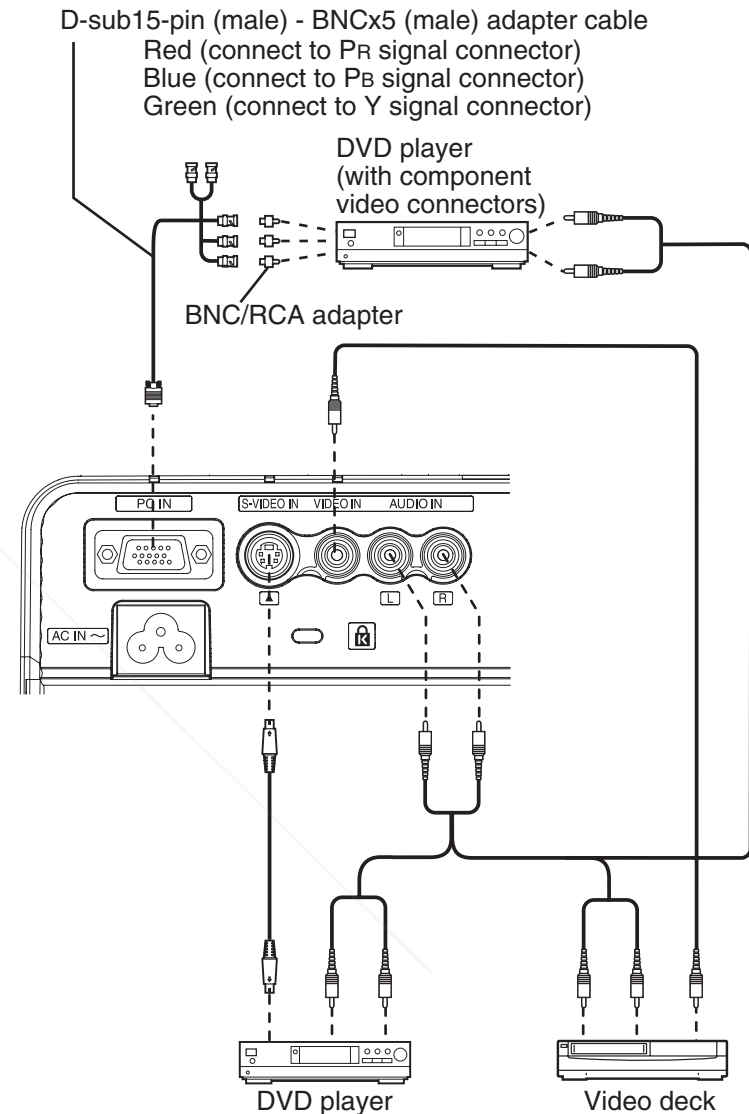

FixYourDLP.com
Sponsored by DM

Discount-Merchant.com (800) 281-8860
THE TRUSTED SOURCE FOR PROJECTOR LAMPS AND ACCESSORIES

Preparation for the remote control unit

Insert the accessory lithium battery while making sure that the polarities are correct.

- ① While pushing the battery holder tab to the left, pull out the battery holder.

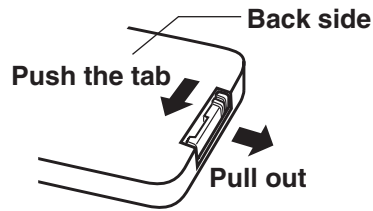

- ② Insert the battery into the battery holder so that the + side is facing upward.

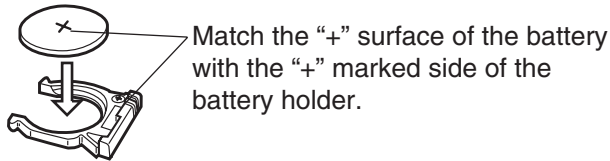

- ③ Insert the battery holder.

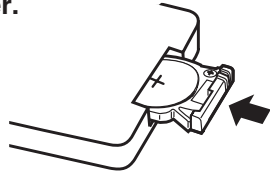

NOTE:

- Do not drop the remote control unit.
- Keep the remote control unit away from liquids.
- Remove the battery if not using the remote control unit for long periods.
- Be sure to use a Panasonic CR2025 battery as a replacement.
- If the remote control unit is held so that it is facing directly in front of the remote control signal receptor, the operating range is within approximately 7 m (23') from the surfaces of the receptor. Furthermore, the remote control unit can be operated from an angle of $\pm 30^\circ$ to the left or right and $\pm 15^\circ$ above or below the receptor.
- If the buttons on the remote control unit are kept pressed, the battery power will be consumed rapidly.
- If there are any obstacles in between the remote control unit and the receptor, the remote control unit may not operate correctly.
- If strong light is allowed to shine onto the remote control signal receptor, correct projector operation may not be possible. Place the projector as far away from light sources as possible.
- If facing the remote control unit toward the screen to operate the projector, the operating range of the remote control unit will be limited by the amount of light reflection loss caused by the characteristics of the screen used.

Fixtron.com
Discworld-Merchant.com (800) 281-8860
THE TRUSTED SOURCE FOR PROJECTOR LAMPS AND ACCESSORIES

Turning on the power

Make sure that all peripheral devices are connected properly before turning on the power.

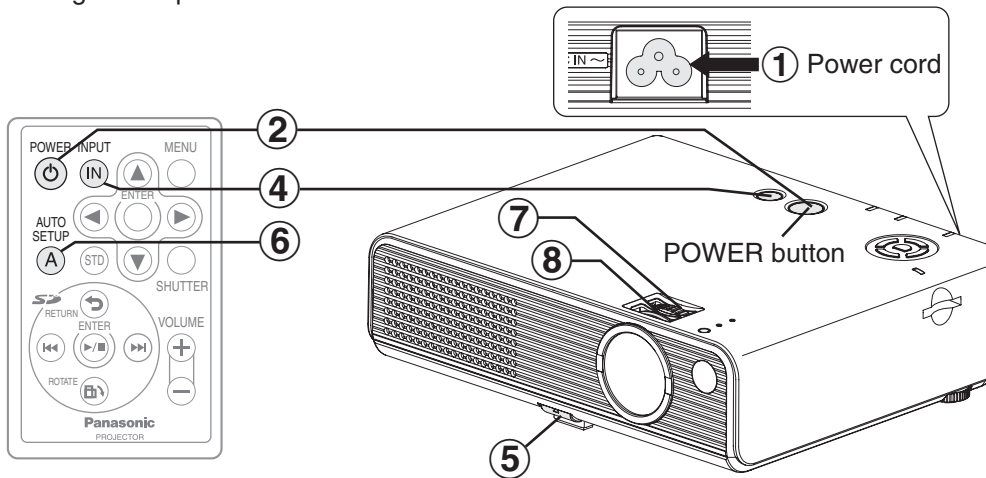

1 Connect the accessory power cord to the AC IN socket and insert the power cord plug into the wall outlet.

- The POWER button on the projector will illuminate red.
- If the SD memory card is inserted into the SD memory card slot, the lamp will turn on automatically and the projection will start. (The image displayed will vary depending on the "MODE" setting in the "SD PICTURE SETUP" menu. Refer to page 38 for details.)

2 Press the POWER button.

- The POWER button on the projector will flash green. After a short period, it will illuminate green, and a picture will be projected.
- The input signal indicators will illuminate while the projector is searching for an input signal (approximately 3 minutes). If the projector detects an input signal, it will use that signal for projection. If no signal is detected, the guide screen for computer connection will be displayed. The input signal search will be finished if the INPUT button or MENU button is pressed while the guide screen is being displayed.

3 Turn on the power of connected devices.

- Start the play function of a device such as a DVD player.

NOTE:

- If the power cord was disconnected during projection when the projector was used the last time, projection will start after the power cord is connected.
- A tinkling sound may be heard when the lamp unit is turned on, but this is not a sign of a malfunction.

4 Press the input select button to select the input signal.

Input select button	Changing signals
(IN)	

- A picture will be projected in accordance with the selected input signal.
- When YPbPr signals are being input to the PC IN connector using an adapter cable, "YPbPr" will be displayed.
- If you insert the SD memory card while other signals are being projected, the input signal will switch to "SD".

Follow the procedure below when you set the projector up first, and when you change the setup place.

5 Adjusting the angle

- Place the projector so that it is vertical to the screen.
- While pressing the front leg adjuster button, adjust the forward/back angle of tilt of the projector. This projector detects its own degree of tilt and corrects the keystone distortion automatically. If the projector is tilted horizontally, turn the back adjustable leg to adjust the horizontal tilt. Adjust so that the projected image is placed at the center of the screen.
- If the keystone distortion remains, adjust "KEYSTONE" in the "POSITION ADJUSTMENT" menu. (page 46)



6 Press the AUTO SETUP button (when PC signals are being input).

- Settings such as the position of the image will be corrected automatically. (page 30)



7 Adjusting the size

- Turn the zoom ring to adjust the size of the projected image.

8 Adjusting the focus

- Turn the focus ring to adjust the focus of the projected image.

Turning off the power

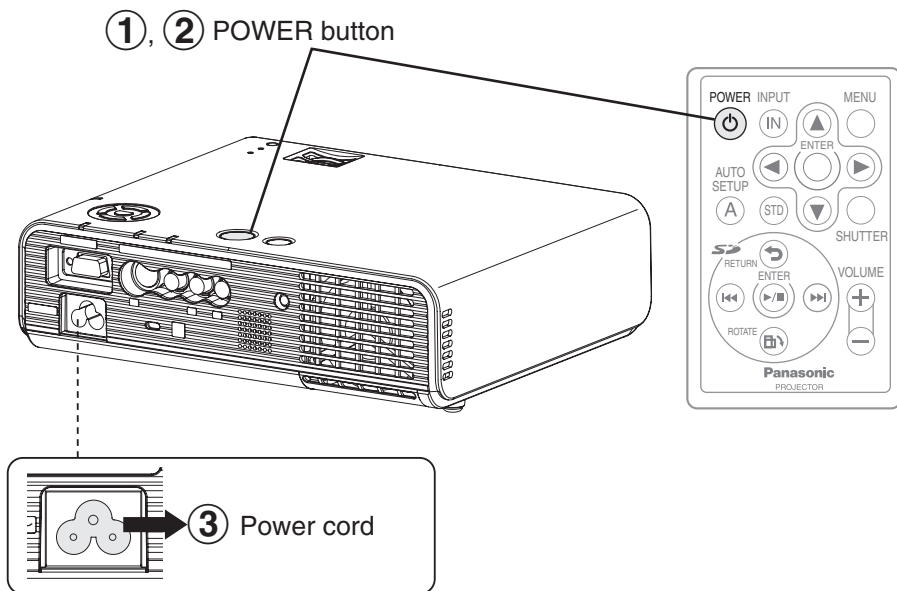

① Press the POWER button.

- The “POWER OFF” confirmation screen will be displayed.

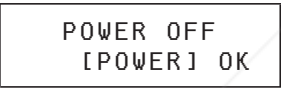

② Press the POWER button again.

- The lamp unit will switch off and the picture will stop being projected. (The POWER button on the projector will illuminate orange while the cooling fan is still operating.)

NOTE:

- Press any button other than the POWER button to cancel the “POWER OFF” screen.
- The “POWER OFF” screen will disappear in five seconds.

③ Disconnect the power cord after the POWER button on the projector illuminates red.

NOTE:

- You can also turn off the power by holding down the POWER button for at least 0.5 seconds.

Direct power off function

You can disconnect the power cord during projection or immediately after use and move the projector. The cooling fan will operate by the internal power supply to cool down the lamp.

- When this function is used, it may take more time for the lamp to turn back on again compared to when the lamp cools down with the power cord connected.
- Do not put the projector in the softcase while the POWER button on the projector is illuminated.

NOTE:

- Do not disconnect the power cord while the files in the SD memory card are being played back.

CAUTION

If not using the projector for an extended period of time, disconnect the power cord plug from the wall outlet.

- If dust builds up on the power cord plug, the resulting humidity may damage the insulation, which could result in fire.
- This projector continues to draw approximately 3 W of power even when the power is turned off.

POWER button on the projector

POWER button status		Projector status
Red	Illuminated	The projector is in standby mode and image projection is possible by pressing the POWER button.
Green	Flashing	The projector is preparing for projection after the power has been turned on while the POWER button on the projector is illuminated red. (After a short period, a picture will be projected.)
	Illuminated	A picture is being projected.
Orange	Illuminated	The lamp is cooling down after the power has been turned off or while direct power off function is operating.
	Flashing	The projector is preparing for projection after the power has been turned on while the POWER button on the projector is illuminated orange. (After a short period, a picture will be projected.)

Correcting the image position automatically (AUTO SETUP)

This projector can adjust the position of the image and the settings for “DOT CLOCK” and “CLOCK PHASE” when PC signals are being input.

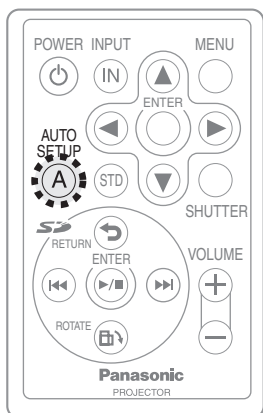

Press the **AUTO SETUP** button while PC signals are being projected.

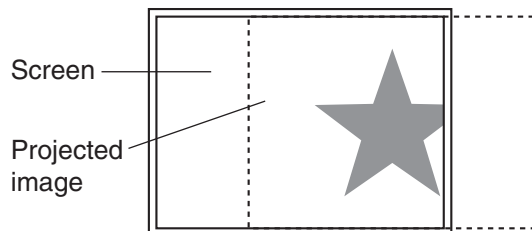

- Automatic positioning will be carried out.

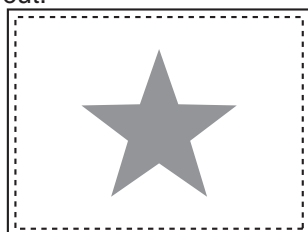

NOTE:

- If the dot clock frequency is 100 MHz or higher, “DOT CLOCK”, and “CLOCK PHASE” will not be adjusted automatically. Refer to page 48 for details.
- If the edges of the projected image are indistinct, or if a dark picture is being projected, the automatic setup processing may stop automatically before it is complete. If this happens, project a different picture and then press the AUTO SETUP button again.

Turning off the picture and sound momentarily (SHUTTER)

The “SHUTTER” function can be used to momentarily turn off the picture and sound from the projector when the projector is not being used for short periods of time, such as during breaks in meetings or when carrying out preparation. The projector uses less power in “SHUTTER” mode than it does in normal projection mode.

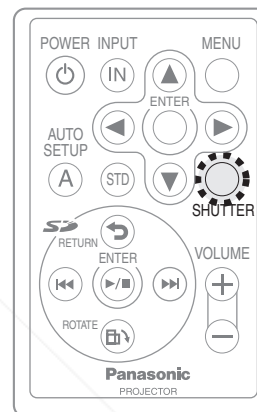

Press the **SHUTTER** button.

- The picture and sound will be turned off.
- Press any button on either the projector or remote control unit to return to normal operating mode.

Adjusting the volume (VOLUME)

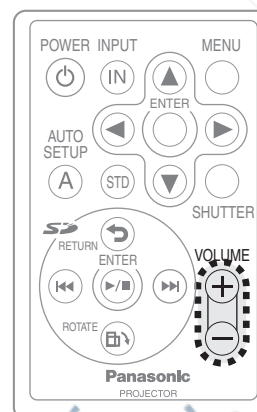

Press the **VOLUME +/-** button.

- Press the + button to raise the volume.
- Press the - button to lower the volume.



Discount-Merchant.com (800) 281-8860
THE TRUSTED SOURCE FOR PROJECTOR LAMPS AND ACCESSORIES

Using the SD memory card

Information on the SD memory card (sold separately)

The SD memory card is a semiconductor memory with a size of 24 mm x 32 mm x 2.1mm, as small as a postage stamp, and is expected to be a next-generation recording medium that will replace MDs (minidiscs), CDs (compact discs) and cassette tapes. It allows repetition of data reading, writing and deleting. This projector can be used to play back still image data and moving image data that has been recorded by digital cameras as well as presentation data whose format has been converted by ImageCreator 1.5.

Notes on using SD memory cards

- Do not disconnect the power cord and do not remove the SD memory card while files are being played back. Failure to observe this may result in data corruption or data loss.
- Be sure to make a backup of the data stored in the SD memory card. Note that important user data may be subject to potential corruption although it very rarely occurs.
- When using a miniSD™ card, be sure to attach the miniSD™ card adapter. Insert and remove the miniSD™ card with the adapter attached.
- If only the miniSD™ card adapter is inserted into the SD memory card slot, the projector will not operate correctly. Be sure to use the miniSD™ card adapter with the miniSD™ card inside.
- Correct operation of a MultiMedia Card in the projector is not guaranteed.
- Use of a Panasonic SD memory card is recommended.

Data that can be played back

Only folder and file names that comply with the DCF standard will be recognized. (Refer to page 66 for details on the DCF standard.)

Still image data:

The format for still images is Exif2.2-compliant JPEG.

- Still image data recorded by the LUMIX Panasonic digital camera.
- Still image data whose format has been converted by ImageCreator 1.5.

Moving image data:

The format for moving images is QuickTime Motion JPEG.

- Moving image data recorded by the LUMIX Panasonic digital camera.

ImageCreator 1.5

ImageCreator 1.5 is software that allows you to convert image formats for presentation files made by Microsoft PowerPoint® to a format that can be played back by this projector. You can download ImageCreator 1.5 from our website:

<http://panasonic.co.jp/pavc/projector>

Refer to the operating instructions for ImageCreator 1.5 that can also be downloaded from the website above for details on operation.

NOTE:

- We shall not be responsible for any damage, whether direct or indirect, caused by the use of or by the fault of the product.
- We shall not be responsible for any data corruption and loss caused by the product.

Inserting and removing the SD memory card

Inserting

- ① Insert the SD memory card with the label side facing upward until a click is heard.
- The input signal will switch to “SD” automatically. If the projector is in standby mode, the lamp will turn on automatically, and then the input signal will switch to “SD”.

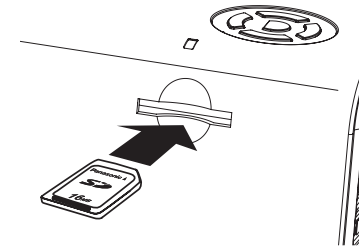

NOTE:

- If you try to force the SD memory card to go in the wrong way, it may damage the SD memory card and the card slot.

Removing

- ① Push in the middle of the SD memory card. (A click will be heard.)
- ② Remove the card.

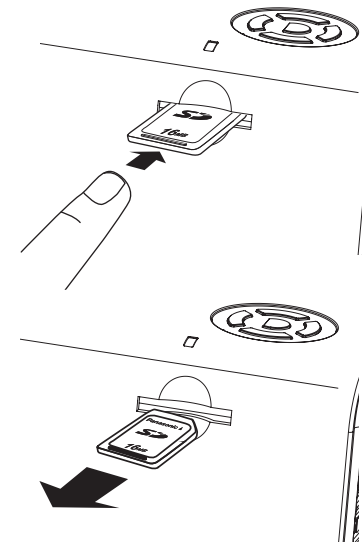

NOTE:

- Always be sure to check that the files in the SD memory card are not being played back before removing the SD memory card. Failure to observe this may result in data corruption or data loss.

SD selection screen

When you insert the SD memory card into the SD memory card slot, the input signal will automatically switch to “SD” and the SD selection screen will be displayed. (An image will be played back depending on the “MODE” setting in the “SD PICTURE SETUP” menu. Refer to page 38 for details.) When the SD selection screen is displayed and files in the SD memory card are being played back, use the SD operation buttons (page 18) for operation.

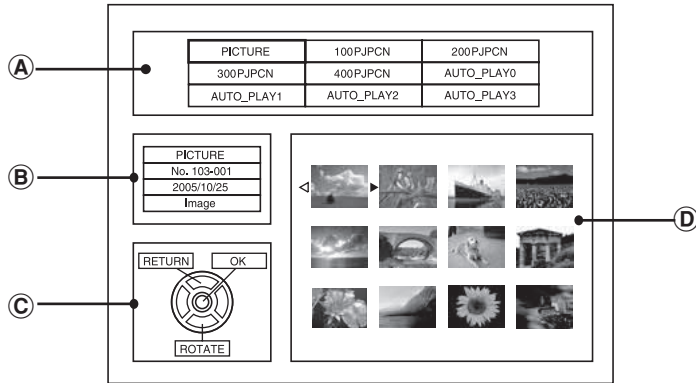

A: Folders

This displays the folders in the SD memory card.

NOTE:

- The “PICTURE” folder contains still image data and moving image data recorded by a LUMIX Panasonic digital camera.

B: Information on the folder and file

This displays the type of folder, the counting number, the date and the type of file starting from the top.

<Folder types>

PICTURE

The “PICTURE” folder contains still image data and moving image data recorded by a LUMIX Panasonic digital camera.

PRESENTATION

The folders that are categorized as “PRESENTATION” contain files for presentation that have been created by ImageCreator 1.5. The folders created by ImageCreator 1.5 are assigned a DCF-compliant folder name (three numerals followed by “PJPC”).

DPOF

Folders categorized as “DPOF” contain files for which various settings have been made by digital cameras. (For example, settings for slide shows.) You can make settings by DPOF-compatible digital cameras. The files with DPOF settings are stored in the “AUTO_PLAY#” folder in addition to the “PICTURE” folder. (The folder name consists of “AUTO_PLAY” followed by one numeral.)

<Counting number>

This displays the counting number of the selected file. [Folder number (three numerals)-file number (four numerals)]

<Date>

This displays the date when the selected file was created.

<File types>

Image

Still image

Movie

Moving image

C: Operation guide

This displays the buttons which can be used for operation.

D: Thumbnails

Thumbnails of images in the selected folder are displayed.

NOTE:

- If the thumbnail has not been incorporated into the image file in advance, it will take a longer time before the thumbnail appears.
- “?” is displayed for files whose thumbnails cannot be displayed for some reason. (For example, the data had been corrupted.)
- For moving images, the first frame will be displayed.

Playing back images from a SD memory card

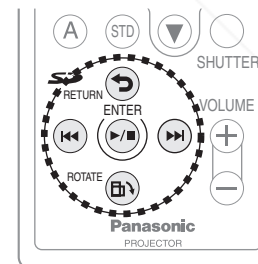

SD operation buttons
<Projector control panel>

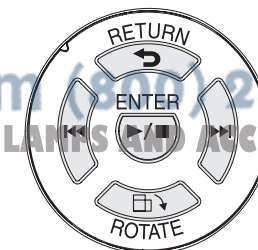

① Select a folder by pressing the SD ◀◀ or SD ▶▶ button.

Thumbnails will be displayed (page 34 D).

- If there are more than 9 folders, press the SD ▶▶ button when selecting the lower-right folder to display the next 9 (or less) folders.

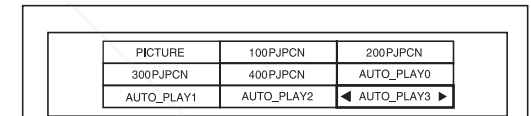

- If there are some folders that are not displayed, their folder names may not be compatible with the DCF standard. Press the SD ROTATE button to display the help screen. Press any SD operation button to return to the SD selection screen from the help screen.

② Press the SD ENTER button.

The cursor will move to the thumbnail area.

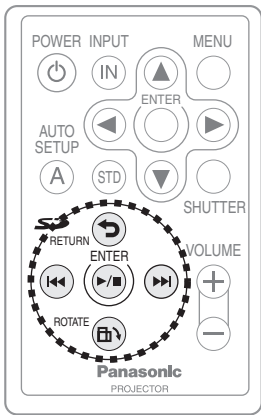

SD operation buttons
<Projector control panel>

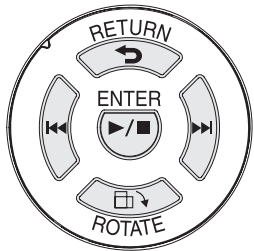

③ Select a file by pressing the SD ◀◀ or SD ▶▶ button.

- A maximum of 12 files can be displayed at a time. If there are more than 12 files, press the SD ▶▶ button when selecting the lower-right file to display the next 12 (or less) files.
- Press the SD RETURN button to return to the folder selection area.

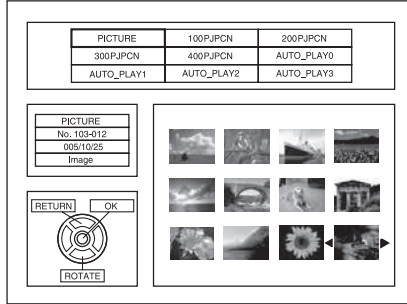

④ Press the SD ENTER button.

The selected file will be played back. If a moving image is selected, the playback will begin.

- If a still image is selected and “AUTO PLAY” in the “SD PICTURE SETUP” menu is set to “ON”, the slide show will begin.
- Photographs which are 6M (6 million pixels) or more and photographs which are 2M (2 million pixels) or more with wide setting may not be played back correctly. In such cases, use ImageCreator 1.5 to convert the image data and reduce the number of pixels to make projection smoother.



FixYourDLP.com
Sponsored by DLP

Button functions during playback

To switch the file:

Press the SD ◀◀ button to switch to the previous file, and the SD ▶▶ button to switch to the next file.

To start/stop the slide show:

Keep pressing the SD ▶▶ button for at least 3 seconds.

To rotate the image:

Each press of the SD ROTATE button rotates the still image being played back 90 degrees clockwise.

To display the SD selection screen:

Press the SD RETURN button.

NOTE:

- You cannot forward, rewind and freeze the moving images.

Setting a detailed playback method for the SD memory card

You can set the playback method for the SD memory card in detail by adjusting the items on the on-screen menu.

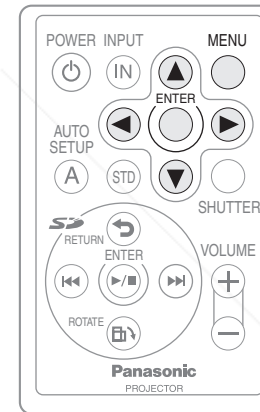

① Press the MENU button on the remote control unit to display the “MAIN MENU”.

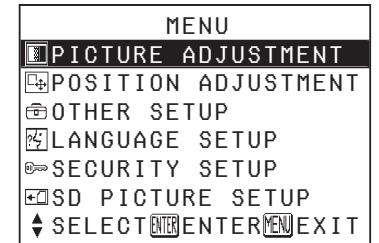

② Press the ▲ or ▼ button to select the “SD PICTURE SETUP” menu and then press the ENTER button.

The “SD PICTURE SETUP” menu will be displayed.

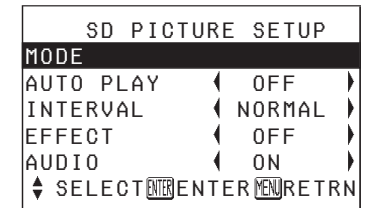

③ Press the ▲ or ▼ button to select an item, and then press the ◀ or ▶ button to change the setting.

For items without any selective setting, press the ENTER button. The next screen for the item will then be displayed.

MODE

This sets the image which is displayed on the screen when the SD memory card is inserted.



PRESENTATION

This mode is used for making a presentation without using a computer. If there is only one "PRESENTATION" folder, the first image will be played back. If there is more than one folder, the SD selection screen will be displayed.

MANUAL

The SD selection screen will be displayed.

AUTO PLAY

This sets the playback method for still images.

ON

The slide show will begin from the selected file.

The files contained in the same folder will be played back in order.

OFF

Only the selected file will be played back.

INTERVAL

This sets the duration of the period to change to the next file in the slide show.

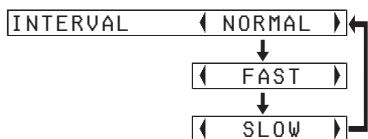

NORMAL

About 10 seconds

FAST

About 5 seconds

SLOW

About 30 seconds

NOTE:

- It may take time for the images to be displayed on the screen depending on the images. In such cases, the play interval may become longer than the set time.

EFFECT

This sets the effect that is applied when switching the still images in a slide show.

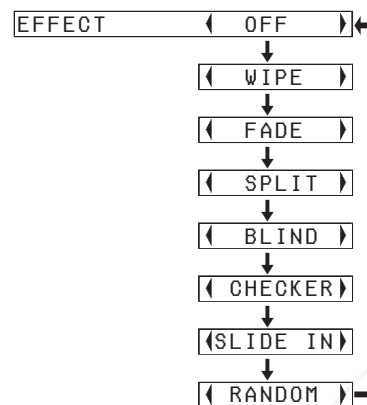

OFF

No effect is applied.

WIPE

An image is wiped by the next image from the left side.

FADE

An image darkens gradually and the next image appears in turn.

An image is split from the center and the next image appears.

BLIND

An image is divided into stripe pattern, and the next image appears.

CHECKER

An image is divided into checker pattern, and the next image appears.

SLIDE IN

The next image slides into the present image.

RANDOM

The various effects will be applied at random every time the image is switched.

AUDIO

ON

The sound is played back when a file which contains sound is played back.

OFF

The sound is not played back when a file which contains sound is played back.

Making a presentation without using a computer

You can make a smooth presentation without using a computer by following the procedures below.

Preparation

- ① Use ImageCreator 1.5 to convert the format of Microsoft PowerPoint presentation file to a format that can be played back by this projector.
- ② Store only one "PRESENTATION" folder created by ImageCreator 1.5 in the SD memory card.
- ③ Set "MODE" in the "SD PICTURE SETUP" menu to "PRESENTATION" (page 38).

- ① **Connect the accessory power cord to the AC IN socket and insert the power cord plug into the wall outlet.**

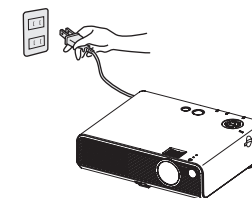

- ② **Insert the prepared SD memory card into the SD memory card slot.**

The lamp will turn on automatically, and the first image in the "PRESENTATION" folder will be played back.

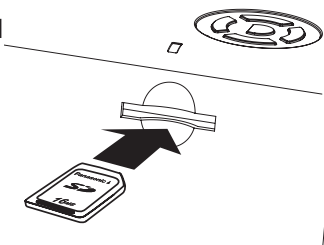

NOTE:

- If there is more than one "PRESENTATION" folder, the SD selection screen will be displayed so that you can select a folder.

- ③ **Operate by using the SD operation buttons. (Refer to page 18.)**

On-screen menus

Menu screens

The various settings and adjustments for this projector can be carried out by selecting the operations from on-screen menus.

The general arrangement of these menus is shown below.

MAIN MENU

MENU	
	PICTURE ADJUSTMENT
	POSITION ADJUSTMENT
	OTHER SETUP
	LANGUAGE SETUP
	SECURITY SETUP
	SD PICTURE SETUP
SELECT ENTER MENU	

- Press the MENU button to display the "MAIN MENU".
Refer to page 42 for details on how to operate the on-screen menus.



PICTURE ADJUSTMENT menu (page 44)

PICTURE ADJUSTMENT	
PICTURE MODE (STANDARD)	
DAYLIGHTVIEW	← AUTO →
DETAILED SETUP	
SELECT ENTER MENU	

DETAILED SETUP	
CONTRAST	32
BRIGHTNESS	32
COLOR ADJUSTMENT	
SELECT ENTER MENU	

- "COLOR ADJUSTMENT" will be displayed only when an S-VIDEO/VIDEO/YPbPr signal is being input.

POSITION ADJUSTMENT menu (page 46)

POSITION ADJUSTMENT	
KEYSTONE	
ASPECT	← 4:3 →
POSITION	
DETAILED SETUP	
SELECT ENTER MENU	

- If an SD signal is being input, only "KEYSTONE" will be displayed.
- "ASPECT" will not be displayed if a PC signal is being input.

OTHER SETUP menu (page 49)

OTHER SETUP	
AUTO SIGNAL	← ON →
TV-SYSTEM	← AUTO →
FRONT/REAR	← FRONT →
DESK/CEILING	← DESK →
HIGHLAND	← OFF →
LAMP RUNTIME	10H
SXGA MODE	← SXGA →
CTRL PANEL	← VALID →
NR	← OFF →
SELECT ENTER MENU	

- "TV-SYSTEM" will be displayed only when an S-VIDEO/VIDEO signal is being input.
- "SXGA MODE" will be displayed only when an PC(SXGA) signal is being input.

SECURITY SETUP menu (page 52)

SECURITY SETUP	
SETUP	← OFF →
AMEND PASSWORD	
TO REGISTER SD KEY 1	
TO REGISTER SD KEY 2	
INSERTED SD KEY	-
SELECT ENTER MENU	

When a PC/YPbPr signal is being input

DETAILED SETUP	
DOT CLOCK	32
CLOCK PHASE	16
SELECT ENTER MENU	

- "DOT CLOCK" will not be displayed if a YPbPr signal is being input.

When an S-VIDEO/VIDEO signal is being input

DETAILED SETUP	
STILL MODE	← OFF →
ADJ MENU	

LANGUAGE SETUP menu (page 51)

LANGUAGE SETUP	
ENGLISH	
DEUTSCH	
FRANÇAIS	
ESPAÑOL	
ITALIANO	
PORTUGUÊS	
РУССКИЙ	
日本語	
SELECT ENTER MENU	

LANGUAGE SETUP	
SVENSKA	
NORSK	
DANSK	
POLSKI	
ČEŠTINA	
MAGYAR	
SELECT ENTER MENU	

SD PICTURE SETUP menu (page 37)

SD PICTURE SETUP	
MODE	
AUTO PLAY	← OFF →
INTERVAL	← NORMAL →
EFFECT	← OFF →
AUDIO	← ON →
SELECT ENTER MENU	

Menu operation guide

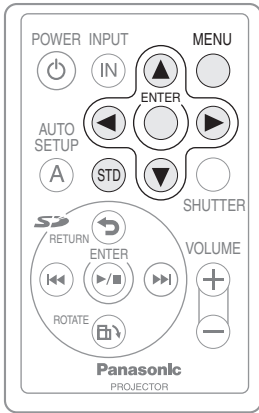

① Press the MENU button.
The "MAIN MENU" will be displayed.

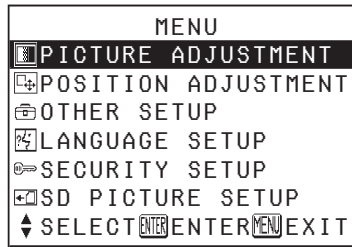

② Press the ▲ or ▼ button to select an item.
Selected item will be displayed in blue.

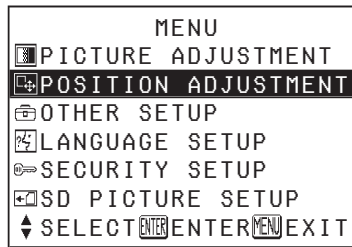

③ Press the ENTER button to accept the selection.
The selected menu screen will then be displayed.
(Example: "POSITION ADJUSTMENT" menu)

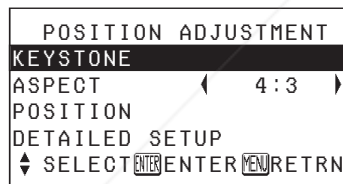

④ Press the ▲ or ▼ button to select an item, and then press the ◀ or ▶ button to change the setting.
For items without any selective setting, press the ENTER button.
The next screen for the item will then be displayed.

For items with bar scales, press the ENTER button or the ◀ or ▶ button to display the adjustment screen, and then press the ◀ or ▶ button to make the adjustment.

(Example: DOT CLOCK)



The bar scale will turn green when any adjustment changes the setting from the factory set value.

Unavailable on-screen menu items

This projector has unadjustable items and unusable functions depending on the signal being input.

When an item cannot be adjusted or a function cannot be used, the corresponding on-screen menu display does not appear, and the item or function will not work even if the ENTER button is pressed.

Returning a setting to the factory default

If you press the STD (standard) button on the remote control unit, you can return settings to the factory default settings. However, the operation of this function varies depending on which screen is being displayed.

• When a menu screen is being displayed

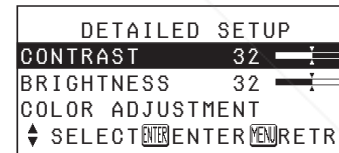

Only the item selected will be returned to the factory default setting, and the bar scale will appear white.

• When an individual adjustment screen is being displayed

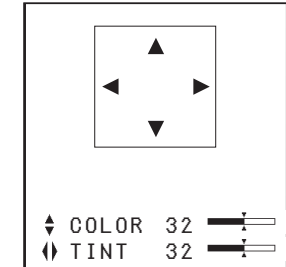

All items displayed will be returned to their factory default settings, and the bar scale will appear white.

NOTE:

- Press the MENU button to return to the previous screen.



Discount-Merchant.com (800) 281-8860
THE TRUSTED SOURCE FOR PROJECTOR LAMPS AND ACCESSORIES

NOTE:

- Triangle symbols above and below the bar scale indicate the factory default setting.

Indicates the standard factory default setting



Indicates the current adjustment value

Adjusting the picture

Press the ▲ or ▼ button on the remote control unit to select an item, and then press the ◀ or ▶ button to change the setting.

For items without any selective setting, press the ENTER button.

The next screen for the item will then be displayed.

For items with bar scales, press the ENTER button or the ◀ or ▶ button to display the adjustment screen, and then press the ◀ or ▶ button to make the adjustment.

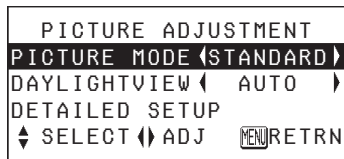

PICTURE MODE

When an S-VIDEO/VIDEO/YPbPr signal is being input

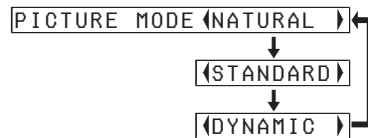

When a PC signal is being input

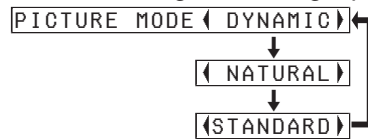

When an SD signal is being input

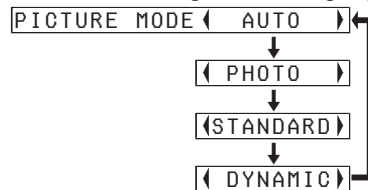

Select the picture mode that best matches the image source and room conditions.

The mode best used in dark rooms is "NATURAL". For rooms having regular lighting conditions in use, select "STANDARD". For exceptionally bright rooms, use "DYNAMIC".

"PHOTO" and "AUTO" are available only if an SD signal is being input. Set to "PHOTO" when projecting photographs. When set to "AUTO", the picture mode will be automatically switched to the best mode.

DAYLIGHTVIEW

This adjusts the vividness of the projected images when the projector is used under bright lighting.



AUTO

The vividness of the projected images will be adjusted according to the lighting condition of the room.

OFF

"DAYLIGHTVIEW" is disabled.

NOTE:

- "AUTO" may not function correctly if any objects are placed on the projector.
- "DAYLIGHTVIEW" will be disabled when "FRONT/REAR" in the "OTHER SETUP" menu is set to "REAR".

DETAILED SETUP

You can adjust the picture quality of the projected images in detail. Press the ENTER button to display the "DETAILED SETUP" menu.

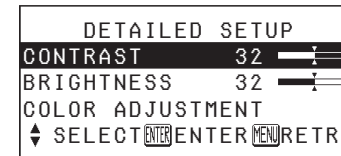

CONTRAST

This adjusts the contrast of the picture. (Adjust the "BRIGHTNESS" setting first if required before adjusting the "CONTRAST" setting.)

The picture is bright: ◀ button

The picture is dark: ▶ button

BRIGHTNESS

This adjusts the darker areas (black areas) in the picture.

Black areas are too light: ◀ button

Dark areas are too solid: ▶ button

COLOR ADJUSTMENT

(S-VIDEO/VIDEO/YPbPr only)

You can adjust the color of the projected image. Press the ENTER button to display the adjustment screen.

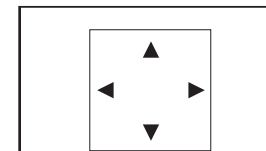

COLOR

The color is too pale: ▲ button

The color is too deep: ▼ button

TINT

[S-VIDEO/VIDEO (NTSC/NTSC 4.43)/YPbPr only]

This adjusts the flesh tones in the picture.

The flesh tones are greenish:

◀ button

The flesh tones are reddish:

▶ button

Adjusting the position

Press the ▲ or ▼ button on the remote control unit to select an item, and then press the ◀ or ▶ button to change the setting.

For items without any selective setting, press the ENTER button. The next screen for the item will then be displayed. For items with bar scales, press the ENTER button or the ◀ or ▶ button to display the adjustment screen, and then press the ◀ or ▶ button to make the adjustment.

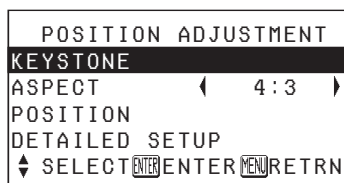

- If an SD signal is being input, only "KEYSTONE" will be displayed.
- "ASPECT" will not be displayed if a PC signal is being input.

KEYSTONE

This projector detects its own degree of tilt and corrects the keystone distortion automatically. However, keystone distortion may still affect the images in some cases (e.g. when the projector is tilted slightly and the tilt is corrected slowly by hand or when the screen itself is tilted). In such cases, you can correct the vertical keystone distortion manually.

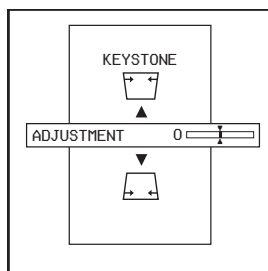

Picture condition	Operation
	Press the ▲ or ▶ button.
	Press the ▼ or ◀ button.

NOTE:

- Vertical keystone distortion can be corrected to $\pm 30^\circ$ of the angle of tilt by combining automatic correction and manual correction. However, the greater the correction amount, the more the picture quality will deteriorate, and the harder it will become to achieve a good level of focus. To obtain the best picture quality, set up the projector and screen in such a way that the amount of keystone correction required is as minimal as possible.
- The picture size will also change when correction of keystone distortion is carried out.
- The ratio of length and width of an image may become incorrect depending on the amount of the keystone correction.
- Keystone distortion of the on-screen display will not be corrected.
- If you correct the keystone distortion manually, the amount of correction will be stored by the projector even after the power is turned off. However, when you turn on the power, the amount of correction will be

reset if the tilt is different from the last time you used the projector. In such cases (e.g. when you change the setup place), correct the keystone distortion again.

ASPECT

(S-VIDEO/VIDEO/480i, 576i, 480p and 576p YPBPR only)

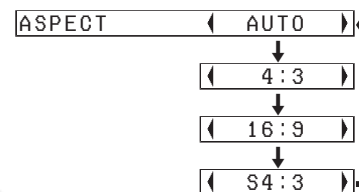

AUTO

(S-VIDEO only)

When an S1 video signal is being input, the aspect ratio is changed automatically to project a 16:9 picture.

4:3

The input signal is projected without change.

16:9

The picture is compressed to a ratio of 16:9 and projected.

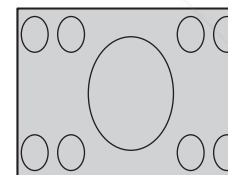

When a horizontally squeezed signal is being input.

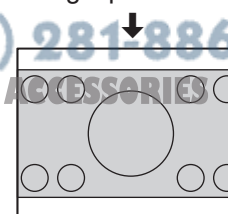

S4:3

The size of the input signal is compressed to 75% and projected. (This is useful for projecting a picture with a 4:3 aspect ratio onto a 16:9 screen.)

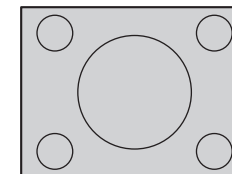

When a 4:3 signal is being input.

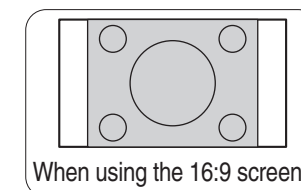
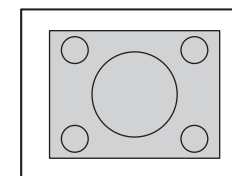

When using the 16:9 screen

S1 video signals

- S1 video signals are a type of video signal with an aspect ratio of 16:9 which include a detector signal. This detector signal is output by some sources such as wide-vision video decks.
- When "ASPECT" is set to "AUTO", the projector recognizes the detector signal and automatically switches the aspect ratio to 16:9.

NOTE:

- If using this projector in places such as cafes or hotels to display programmes for a commercial purpose or for public presentation, note that if the aspect ratio (16:9) selection function is used to change the aspect ratio of the screen picture, you may be infringing the rights of the original copyright owner for that programme under copyright protection laws.
- If a 4:3 picture is projected onto a 16:9 screen, distortion may occur around the edges of the picture so that part of the picture is no longer visible. Programmes which have 4:3 aspect ratios should be viewed in 4:3 mode to give proper consideration to the aims and intentions of the original programme's creator.

POSITION

(PC/YPbPr/S-VIDEO/VIDEO only)

Moves the picture position.

Press the ENTER button to display the "POSITION" screen.

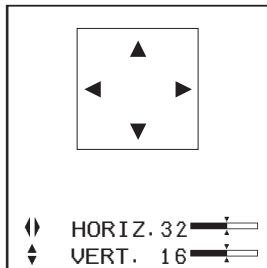

Press the ◀ or ▶ button to move the picture horizontally.
Press the ▲ or ▼ button to move the picture vertically.

DETAILED SETUP

You can adjust the noise and flicker of the projected images. Press the ENTER button to display the "DETAILED SETUP" menu.

When a PC/YPbPr signal is being input

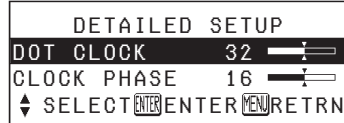

When an S-VIDEO/VIDEO signal is being input



DOT CLOCK

(PC only)

Periodic striped pattern interference (noise) may occur when a striped pattern such as the one below is projected. If this happens, press the ◀ or ▶ button to adjust so that any such noise is minimised.

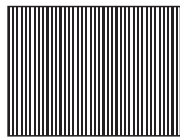

CLOCK PHASE

(PC/YPbPr only)

Adjust the "DOT CLOCK" setting first before carrying out this adjustment. Press the ◀ or ▶ button to adjust so that the noise level is least noticeable.

NOTE:

- If signals with a dot clock frequency of 100 MHz or higher are being input, interference may not be completely eliminated when the "DOT CLOCK" and "CLOCK PHASE" adjustments are carried out.

Other settings

Press the ▲ or ▼ button on the remote control unit to select an item, and then press the ◀ or ▶ button to change the setting.

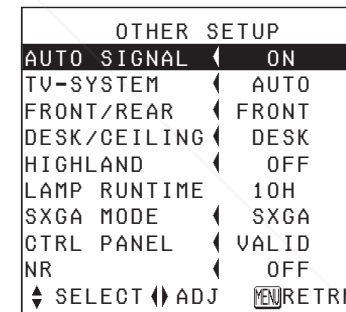

AUTO SIGNAL

This should normally be set to "ON".

ON

"AUTO SETUP" will be carried out when the input signal is changed to "PC".

OFF

"AUTO SETUP" will not function when the input signal is changed to "PC".

STILL MODE

(S-VIDEO/VIDEO only)

To reduce flickering of still images (vertical flicker), set "STILL MODE" to "ON".

NOTE:

- Set to "OFF" when playing back moving images.

TV-SYSTEM

(S-VIDEO/VIDEO only)

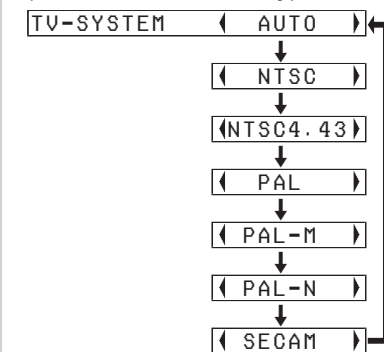

This should normally be set to "AUTO". If the signal is of such poor quality that the correct format cannot be automatically distinguished, change the setting manually to the required TV system.

NOTE:

- When set to "AUTO", the projector automatically distinguishes between NTSC/NTSC 4.43/PAL/PAL60/PAL-M/PAL-N/SECAM signals.

FRONT/REAR

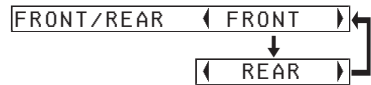

This setting should be changed in accordance with the projector setting-up method. (Refer to page 20.)

FRONT

When the projector is placed in front of a screen.

REAR

When using a translucent screen.

DESK/CEILING

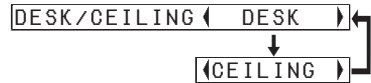

This setting should be changed in accordance with the projector setting-up method. (Refer to page 20.)

DESK

When the projector is placed on a desk or similar.

CEILING

When the projector is suspended from a ceiling using the ceiling bracket (sold separately).

HIGHLAND



Set "HIGHLAND" to "ON", when using this projector at high elevations (above 1 400 m) only.

LAMP RUNTIME

This setting displays the usage time for the lamp unit which is currently being used. When replacing the

lamp unit, follow the instructions on page 58, and reset "LAMP RUNTIME" to "0".

NOTE:

- The lamp's operating life varies depending on the usage conditions.

SXGA MODE

[PC(SXGA) only]

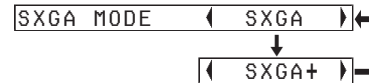

Adjust this item if the projected image overflows from the screen when an SXGA signal is being input.

SXGA

Select this item normally.

SXGA+

When the edges of the projected image are not visible, select this item.

CTRL PANEL

To disable the buttons on the projector, set "CTRL PANEL" to "INVALID". A confirmation screen will then be displayed. Select "OK" by using ◀ or ▶ button. To use the buttons on the projector, set to "VALID" by using the remote control unit.

NR (Noise Reduction)

[S-VIDEO/VIDEO only]

If the signal is of such poor quality that picture interference appears, set "NR" to "ON". To turn off the "NR" feature, set to "OFF".

Changing the display language

Press the ▲ or ▼ button on the remote control unit to select a language, and then press the ENTER button to accept the setting.

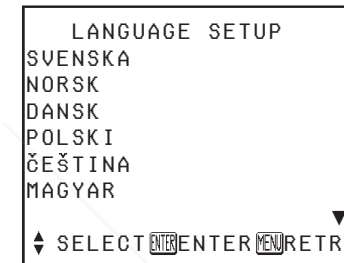

Setting up the security function

This projector is equipped with a security function. All of the controls other than the POWER button are disabled unless the password is entered correctly or the registered SD memory card is inserted properly.

Press the ▲ or ▼ button on the remote control unit to select “SECURITY SETUP”, and then press the ENTER button.

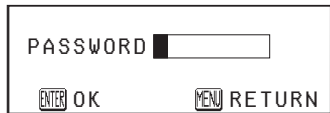
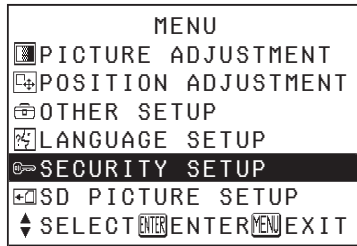

(When you use the “SECURITY SETUP” function for the first time)

Press the ▲, ►, ▼, ◀, ▲, ►, ▼ and ◀ buttons in order, then press the ENTER button.

(When a password change has been made before)

Type in the changed password, then press the ENTER button.

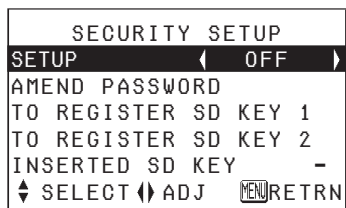

Press the ▲ or ▼ button to select an item, and then press the ◀ or ▶ button to change the setting. For items without any selective setting, press the ENTER button. The next screen for the item will then be displayed.

SETUP

You can select the security lock method for when the power is turned on.

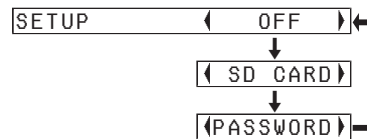

OFF

“SETUP” is disabled.

SD CARD

When the power is turned on, the screen below will be displayed. Inserting the registered SD card (SD key) will release the lock.

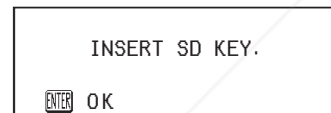

PASSWORD

When the power is turned on, the screen below will be displayed. Entering the password will release the lock.



NOTE:

- “SD CARD” will not be displayed when no SD memory card is registered.

AMEND PASSWORD

Passwords can be changed.

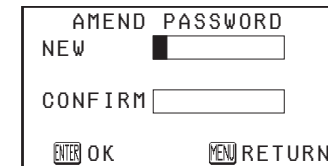

① Set a password by pressing the ▲, ▼, ◀, and ▶ buttons.

A maximum of 8 buttons can be set.

② Press the ENTER button.

③ Enter the password again for confirmation.

④ Press the ENTER button.

NOTE:

- The entered password will appear as *. It will not be displayed on the screen.
- If you enter the wrong password, the letters “PASSWORD” and “NEW” will become red. Enter the correct password again.

TO REGISTER SD KEY 1(2)

You can register up to 2 SD memory cards as a SD key.

NOTE:

- “SD key 2” can be registered after “SD key 1” has been registered. Register “SD key 2” in the same way as for “SD key 1”.

(When you register the SD key for the first time)

① The “INSERT SD KEY 1 FOR REGISTRATION.” screen will be displayed.



② Insert the SD memory card which you would like to register as a SD key 1.

③ Press the ENTER button.

(To change the registered SD key)

① The “INSERT SD KEY.” screen will be displayed.

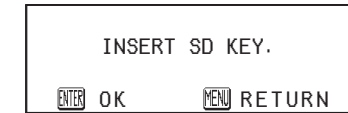

Insert the current SD key.

② Press the ENTER button.

The “INSERT SD KEY 1 FOR REGISTRATION.” screen will be displayed.

③ Remove the current SD key, insert the new SD memory card which you would like to register as a SD key and press the ENTER button.

NOTE:

- If you insert a SD memory card which has not been registered as SD key, the letters on the screen will become red. Insert the correct SD key again.

INSERTED SD KEY

This shows whether the inserted SD memory card is registered as a SD key.

-

The inserted SD memory card has not been registered as a SD key.

- 1
SD key 1
2
SD key 2

When the TEMP indicator and the LAMP indicator are illuminated

There are two indicators on the control panel of the projector which give information about the operating condition of the projector. These indicators illuminate or flash to warn you about problems that have occurred inside the projector, so if you notice that one of the indicators is on, turn off the power and check the table below for the cause of the problem.

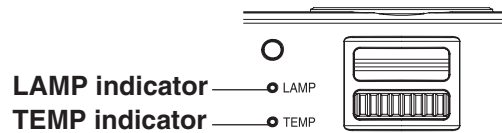

TEMP indicator		
Indicator display	Illuminated (red) (Lamp unit on)	Flashing (red) (Lamp unit off)
Problem	The surrounding temperature or the temperature inside the projector has become unusually high.	The surrounding temperature or the temperature inside the projector has become dangerously high, causing the lamp unit to automatically shut off.
Possible cause	<ul style="list-style-type: none"> • The ventilation holes may be covered. • The ambient temperature in the place of use may be too high. • The air filter may be blocked. 	
Remedy	<ul style="list-style-type: none"> • Uncover the ventilation holes. • Set up the projector in a place where the temperature is between 0 °C (32 °F) and 40 °C (104 °F) and the humidity is between 20% and 80% (with no condensation). [If you set the "HIGHLAND" to "ON" (page 28), set up the projector in a place where the temperature is between 0 °C (32 °F) and 35 °C (95 °F) and the humidity is between 20% and 80% (with no condensation).] • Disconnect the power cord by following the procedure on page 28, and then clean the air filter. (Refer to page 56.) 	

LAMP indicator		
Indicator display	Illuminated (red)	Flashing (red)
Problem	It is nearly time to replace the lamp unit.	An abnormality has been detected in the lamp circuit.
Possible cause	<ul style="list-style-type: none"> • Does "REPLACE LAMP" appear on the screen after the projector is turned on? 	<ul style="list-style-type: none"> • The power may have been turned on straight away after it was turned off. • There may be an abnormality in the lamp circuit. • The lamp unit may be blown.
Remedy	<ul style="list-style-type: none"> • This occurs when the operation time for the lamp unit is nearing 2 250 hours. Ask your dealer or an Authorized Service Center to replace the lamp unit. (page 57) 	<ul style="list-style-type: none"> • Wait for a while until the lamp unit cools down before turning the power back on again. • Disconnect the power cord by following the procedure on page 28, and then contact an Authorized Service Center. • Ask your dealer or an Authorized Service Center to replace the lamp unit. (page 57)

NOTE:

- Be sure to disconnect the power cord by following the procedure given in "Turning off the power" on page 28 before carrying out any of the procedures in the "Remedy" column.
- If the TEMP indicator is illuminated and the power turns off after the procedures in the "Remedy" column have been carried out, it means an abnormality has occurred. Please contact an Authorized Service Center so that the necessary repairs can be made.

Cleaning and replacing the air filter

If the air filter becomes clogged with dust, the internal temperature of the projector will rise, the TEMP indicator will illuminate and the projector's power will turn off (the TEMP indicator will flash after the power is turned off). **The air filter should be cleaned every 100 hours of use.**

Cleaning

Use a vacuum cleaner to clean off any accumulated dust.

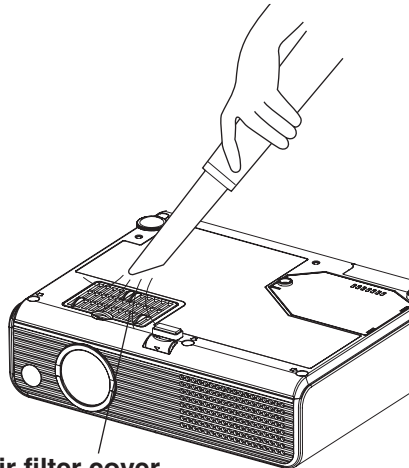

Air filter cover

NOTE:

- If the dust cannot be cleaned by a vacuum cleaner, remove the air filter and soak it in water, and then wash out the dust by hand. Be sure to install the air filter after it has dried.
- Do not use detergent when washing the air filter.
- If the dust cannot be removed by cleaning, it is time to replace the air filter. Please consult your dealer. Furthermore, if the lamp unit is being replaced, replace the air filter at this time also.

Replacement procedure

- ① **Turn off the power and disconnect the power cord.**
Be sure to disconnect the power cord by following the procedure given on page 28.
- ② **Gently turn the projector upside down, and then remove the air filter cover.**

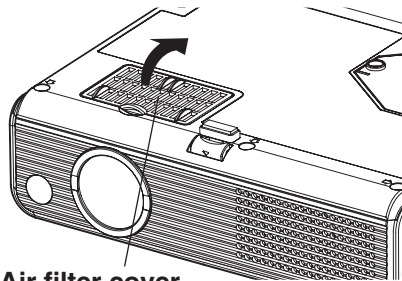

Air filter cover

- ③ **Replace the air filter, and then install the air filter cover.**

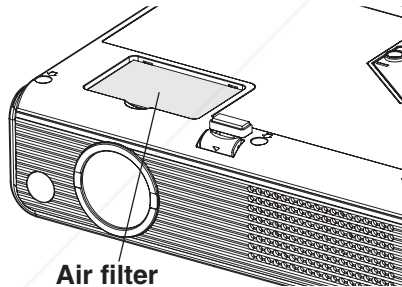

Air filter

NOTE:

- Be sure to install the air filter before using the projector. If the projector is used without the air filter installed, dust and other foreign particles will be drawn into the projector, and malfunctions will result.

Replacing the lamp unit

Warning

The lamp unit should only be replaced by a qualified technician.

When replacing the lamp, allow it to cool for at least one hour before handling it.

- The lamp cover gets very hot, and touching it can cause burns.

Notes on replacing the lamp unit

- The light generating lamp is made of glass, so dropping it or allowing it to hit hard objects may cause it to burst. Be careful when handling the lamp.
- Dispose of the removed old lamp with the same care that would be taken with a fluorescent light.
- A Phillips screwdriver is necessary for removing the lamp unit.

NOTE:

- The projector is not supplied with a replacement lamp unit. Please ask your dealer for details. Lamp unit product no.: **ET-LAP1**

CAUTION:

- Do not use any lamp unit other than the one with the product number indicated above.



Lamp unit replacement period

The lamp is a consumable product. Even when the full life of the bulb has not been exhausted, the brightness of the light will gradually decline. Therefore periodic replacement of the lamp is necessary.

The intended lamp replacement interval is 2 500 hours, but it is possible that the lamp may need to be replaced earlier due to variables such as a particular lamp's characteristics, usage conditions and the installation environment. Early preparation for lamp replacement is encouraged. The lamp will automatically shut off after approximately 10 minutes when 2 500 hours of use have been reached because of a much greater chance of it exploding after this time.

NOTE:

- While 2 500 hours is the intended replacement interval, it is not a period of time covered by warranty.

	On-screen display 	LAMP indicator 
More than 2 250 hours	Displayed for 30 seconds. Pressing any button will clear the display.	Illuminates red during image projection and standby mode.
More than 2 500 hours	Remains displayed until any button is pressed.	

Lamp unit replacement procedure

NOTE:

- If the lamp usage time has passed 2 500 hours, the projector will switch to standby mode after approximately 10 minutes of operation. The steps ⑦ to ⑬ on the next page should thus be completed within 10 minutes.

- ① Disconnect the power cord from the projector by following the procedure on page 28, and check that the area around the lamp unit has cooled down.
- ② Use a Phillips screwdriver to turn the lamp unit cover fixing screw at the bottom of the projector, and then remove the lamp unit cover.

Lamp unit cover

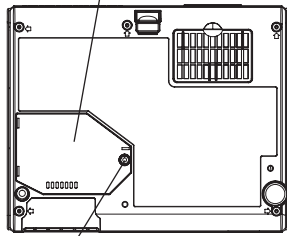

Lamp unit cover fixing screw

- ③ Use a Phillips screwdriver to loosen the lamp unit fixing screw until the screw turns freely. Then hold the handle of the lamp unit and gently pull the lamp unit out from the projector.

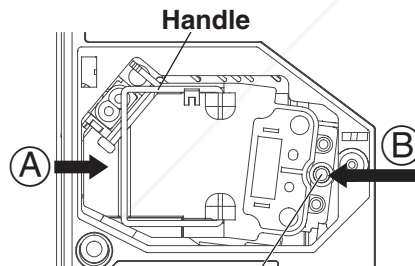

Lamp unit fixing screw

Insert the new lamp unit while making sure that the direction of insertion is correct, and then use a Phillips screwdriver to securely tighten the lamp unit fixing screw.

When inserting the new lamp unit, be sure to push it in at the point ① and ②.

- ⑤ Install the lamp unit cover, and then use a Phillips screwdriver to securely tighten the lamp unit cover fixing screw.

NOTE:

- Be sure to install the lamp unit and the lamp unit cover securely. If they are not securely installed, it may cause the protection circuit to operate so that the power cannot be turned on.

- ⑥ Connect the power cord.

- ⑦ Press the POWER button so that a picture is projected onto the screen.

NOTE:

- If the power cord was disconnected during projection when the projector was used the last time, projection will start after the power cord is connected.

- ⑧ Press the MENU button to display the "MAIN MENU", and then press the ▲ or ▼ button to select "OTHER SETUP".

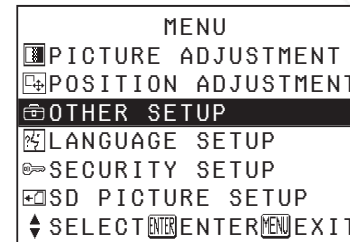

- ⑨ Press the ENTER button to display the "OTHER SETUP" menu, and then press the ▲ or ▼ button to select "LAMP RUNTIME".

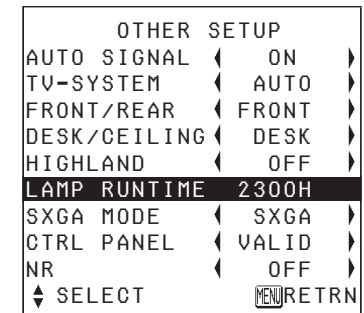

- ⑩ Press and hold the ENTER button for approximately 3 seconds. The "LAMP TIME RESET" screen will be displayed.



- ⑪ Select "OK" by pressing the ◀ or ▶ button on the remote control unit and then press the ENTER button. The "POWER OFF" confirmation screen will be displayed.



NOTE:

- The "POWER OFF" screen will disappear in five seconds.
- If the MENU button is pressed, the "LAMP TIME RESET" screen and the "POWER OFF" confirmation screen will be cancelled.

- ⑫ Press the POWER button to turn off the power.
- ⑬ Disconnect the power cord after the POWER button on the projector illuminates red. This will reset the cumulative usage time for the lamp unit to "0".

Before calling for service

Before calling for service, check the following points.

Problem	Possible cause	Page
Power does not turn on.	• The power cord may not be connected.	–
	• The main power supply is not being supplied to the wall outlet.	–
	• TEMP indicator is illuminated or flashing.	54
	• LAMP indicator is illuminated or flashing.	55
	• The lamp unit cover has not been securely installed.	–
No picture appears.	• The video signal input source may not be connected properly.	–
	• The input selection setting may not be correct.	27
	• The “BRIGHTNESS” adjustment setting may be at the minimum possible setting.	45
	• The “SHUTTER” function may be in use.	31
The picture is fuzzy.	• The lens focus may not have been set correctly.	27
	• The projector may not be at the correct distance from the screen.	21
	• The lens and the lens cover may be dirty. • The projector may be tilted too much.	– 20
The color is pale or grayish.	• “COLOR ADJUSTMENT” settings may be incorrect.	45
	• The input source which is connected to the projector may not be adjusted correctly.	–
No sound can be heard.	• The audio signal source may not be connected properly.	–
	• The volume adjustment may be at the lowest possible setting.	31
	• “AUDIO” in the “SD PICTURE SETUP” may be set to “OFF” while the SD signal is being projected.	39
The remote control unit does not operate.	• The battery may be weak.	–
	• The battery may not be inserted correctly.	24
	• The remote control signal receptor on the projector may be obstructed.	24
	• The remote control unit may be out of the operation range.	24
The buttons on the projector do not function.	• The “CTRL PANEL” may be set to “INVALID”. In order to set the “CTRL PANEL” to “VALID” without using the remote control unit, keep holding down the SD ENTER button on the projector and press the INPUT button for more than 2 seconds.	50

Problem	Possible cause	Page
The picture does not display correctly.	• The signal format (“TV-SYSTEM”) may not be set correctly.	49
	• There may be a problem with the video tape or other signal source.	–
	• A signal which is not compatible with the projector may be being input.	65
Picture from computer does not appear.	• The cable may be too long.	–
	• The external video output for the laptop computer may not be set correctly. (You may be able to change the external output settings by pressing the [Fn]+[F3] or [Fn]+[F10] keys simultaneously. The actual method varies depending on the type of computer, so refer to the documentation provided with your computer for further details.)	67

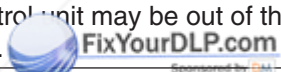

DiscountMerchant.com (800) 281-8860
THE TRUSTED SOURCE FOR PROJECTOR LAMPS AND ACCESSORIES

Cleaning and maintenance

Before carrying out cleaning and maintenance, be sure to disconnect the power cord plug from the wall outlet.

Wipe the cabinet with a soft, dry cloth.

If the cabinet is particularly dirty, soak the cloth in water with a small amount of neutral detergent in it, squeeze the cloth very well, and then wipe the cabinet. After cleaning, wipe the cabinet dry with a dry cloth. If using a chemically-treated cloth, read the instructions supplied with the cloth before use.

Do not wipe the lens or the lens cover with a cloth that is dusty or which produces lint.

If any dust or lint gets onto the lens or the lens cover, such dust or lint will be magnified and projected onto the screen. Use a blower to clean any dust and lint from the lens and the lens cover surface, or use a soft cloth to wipe off any dust or lint.

Removing and attaching the lens cover

Removing

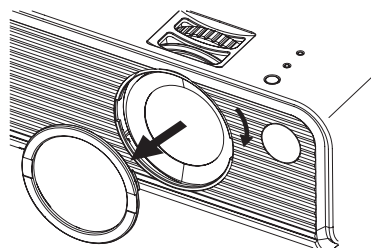

- Turn the ring to the right and remove the lens cover.

Attaching

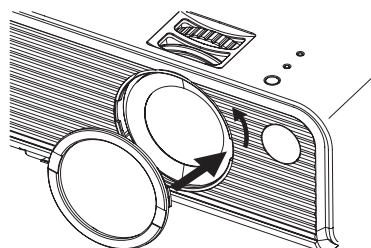

- Replace the lens cover and turn it to the left to lock it in place.

NOTE:

- The lens cover is made of glass, so dropping it or allowing it to hit hard objects may cause it to break. Be careful when handling the lens cover
- Use the projector with the lens cover attached.

Specifications

Power supply:	100 V - 240 V ~, 50 Hz/60 Hz
Power consumption:	180 W [During standby (when fan is stopped): Approx. 3 W]
Amps:	2.2 A - 1.0 A
LCD panel:	
Panel size (diagonal):	0.6 type (15.24 mm)
Aspect ratio:	4:3
Micro lens array:	Available
Display method:	3 transparent LCD panels (RGB)
Drive method:	Active matrix method
Pixels:	480 000 (800 x 600) x 3 panels
Lens:	Manual zoom (1.2 x) / Manual focus F 1.7 - 1.8 f 17.0 mm - 20.4 mm
Lamp:	UHM lamp (130 W)
Luminosity:	1 500 lm
Scanning frequency (for RGB signals):	
Horizontal scanning frequency:	15 kHz - 91 kHz
Vertical scanning frequency:	50 Hz - 85 Hz
Dot clock frequency:	Less than 100 MHz
YPbPr signals:	480i, 576i, 480p, 576p, 1 080/60i, 1 080/50i, 720/60p
Color system:	7 (NTSC/NTSC 4.43/PAL/PAL-M/PAL-N/ PAL60/SECAM)
Projection size:	965 mm - 7 620 mm (38" - 300")
Throw distance:	1.2 m - 9.9 m (3'11" - 32'5")
Optical axis shift:	4:1 (fixed)
Screen aspect ratio:	4:3
Installation:	Front/Rear/Ceiling/Desk (menu selection)
Speaker:	2.0 cm round x 1
Max. usable volume output:	0.5 W (mono)
Connectors	
PC IN:	Single-line, D-sub HD 15-pin (female)
During RGB input:	
R.G.B.:	0.7 V [p-p], 75 Ω
G.SYNC:	1.0 V [p-p], 75 Ω
HD/SYNC:	TTL, automatic positive/negative polarity compatible
VD:	TTL, automatic positive/negative polarity compatible
During YPbPr input:	
Y:	1.0 V [p-p] (Including sync), 75 Ω
PB, PR :	0.7 V [p-p], 75 Ω



Discount-Merchant.com (800) 281-8866

THE TRUSTED SOURCE FOR PROJECTOR LAMPS AND ACCESSORIES

VIDEO IN: Single-line, RCA pin jack
1.0 V [p-p], 75 Ω

S-VIDEO IN: Single-line, Mini DIN 4-pin
Y 1.0 V [p-p], C 0.286 V [p-p], 75 Ω

AUDIO IN: Single-line, 0.5 V [rms]
RCA pin jack x 2 (L-R)

SD memory card slot: SD memory card
(8 MB/16 MB/32 MB/64 MB/128 MB/
256 MB/512 MB/1 GB/2 GB)

Cabinet: Moulded plastic (PC/ABS)

Dimensions:

Width: 234 mm (9-3/16")

Length: 188 mm (7-3/8")

Height: 65 mm (2-17/32") (Not including the
projection parts)

Weight: 1.3 kg (2.9 lbs.)

Operating environment:

Temperature: 0 °C - 40 °C (32 °F - 104 °F)
[When the "HIGHLAND" is set to "ON"
(page 50): 0 °C - 35 °C (32 °F - 95 °F)]

Humidity: 20% - 80% (no condensation)

Certifications: UL60950, C-UL
FCC Class B

<Remote control unit>

Power supply: 3 V DC (Lithium CR2025 battery x 1)

Operating range: Approx. 7 m (23') (when operated directly
in front of signal receptor)

Weight: 32 g (1.1 ozs.) (including battery)

Dimensions:

Width: 54 mm (2-1/8")

Length: 86 mm (3-3/8")

Height: 8.2 mm (-5/16")

<Options>

Ceiling bracket ET-CPK1



Discount-Merchant.com (800) 281-8800
THE TRUSTED SOURCE FOR PROJECTOR LAMPS AND ACCESSORIES

Appendix

List of compatible signals

Compatible signals	Display resolution (dots)*1	Scanning frequency		Dot clock frequency (MHz)	Picture quality*2	Format
		H (kHz)	V (Hz)			
NTSC/NTSC4.43/ PAL-M/PAL60	720 x 480i	15.7	59.9		A	S-Video/Video
PAL/PAL-N/SECAM	720 x 576i	15.6	50.0		A	S-Video/Video
480i	720 x 480i	15.7	59.9	13.5	A	YPbPr
576i	720 x 576i	15.6	50.0	13.5	A	YPbPr
480p	720 x 483	31.5	59.9	27.0	A	YPbPr
576p	720 x 576	31.3	50.0	27.0	A	YPbPr
1 080/60i	1 920 x 1 080i	33.8	60.0	74.3	A	YPbPr
1 080/50i	1 920 x 1 080i	28.1	50.0	74.3	A	YPbPr
720/60p	1 280 x 720	45.0	60.0	74.3	A	YPbPr
VGA400	640 x 400	31.5	70.1	25.2	A	PC
	640 x 400	37.9	85.1	31.5	A	PC
VGA480	640 x 480	31.5	59.9	25.2	A	PC
	640 x 480	35.0	66.7	30.2	A	PC
	640 x 480	37.9	72.8	31.5	A	PC
	640 x 480	37.5	75.0	31.5	A	PC
	640 x 480	43.3	85.0	36.0	A	PC
SVGA	800 x 600	35.2	56.3	36.0	AA	PC
	800 x 600	37.9	60.3	40.0	AA	PC
	800 x 600	48.1	72.2	50.0	AA	PC
	800 x 600	46.9	75.0	49.5	AA	PC
	800 x 600	53.7	85.1	56.3	AA	PC
MAC16	832 x 624	49.7	74.6	57.3	A	PC
XGA	1 024 x 768	48.4	60.0	65.0	A	PC
	1 024 x 768	56.5	70.1	75.0	A	PC
	1 024 x 768	60.0	75.0	78.8	A	PC
	1 024 x 768	68.7	85.0	94.5	A	PC
	1 024 x 768i	35.5	87.0	44.9	A	PC
MXGA	1 152 x 864	64.0	71.2	94.2	A	PC
	1 152 x 864	67.5	74.9	108.0	B	PC
	1 152 x 864	76.7	85.0	121.5	B	PC
MAC21	1 152 x 870	68.7	75.1	100.0	B	PC
MSXGA	1 280 x 960	60.0	60.0	108.0	B	PC
SXGA	1 280 x 1 024	64.0	60.0	108.0	B	PC
	1 280 x 1 024	80.0	75.0	135.0	B	PC
	1 280 x 1 024	91.1	85.0	157.5	B	PC
	1 400 x 1 050	64.0	60.0	108.0	B	PC
	1 400 x 1 050	65.1	59.9	122.4	B	PC
UXGA	1 600 x 1 200	75.0	60.0	162.0	B	PC

*1 The "i" appearing after the resolution indicates an interlaced signal.

*2 The following symbols are used to indicate picture quality.

AA Maximum picture quality can be obtained.

A Signals are converted by the image processing circuit before picture is projected.

B Some loss of data occurs to make projection easier.

DCF standard

For data recorded by digital cameras, folder and file names that comply with the DCF standard will be automatically assigned. The DCF standard has the following requirements.

Files or folders that do not comply with these requirements cannot be recognised by the projector. If you change the folder and file names on computers, the projector may not be able to recognise them correctly.

Folder (directory) name

- **Folders are created as sub-folders of the DCIM folder on the SD memory card.**
Data located in folders other than the DCIM folder is not recognized.
- **Folder names consist of three numerals (folder number) followed by five alphanumeric characters. (Example: 100ABCDE)**
Numbers between 100 and 999 can be used for the three numerals and the alphanumeric characters can be taken from the following set of 37 characters: 0123456789ABCDEFGHIJKLMNPOQRSTUVWXYZ_(No distinction is made between upper-case and lower-case alphabetic characters. Double-byte characters cannot be used.)
- **Multiple folders using the same three-digit combination (folder number) cannot be recognised correctly.**
- **Folder sub-hierarchies are not supported.**

File name

- **File names consist of four alphanumeric characters followed by four numerals (file number), followed by “.JPG” (extension). (Example: ABCD0001.JPG)**
The alphanumeric characters can be taken from the following set of 37 characters: 0123456789ABCDEFGHIJKLMNPOQRSTUVWXYZ_and numbers between 0001 and 9999 can be used for the four numerals (No distinction is made between upper-case and lower-case alphabetic characters. Double-byte characters cannot be used.)
- **Multiple files using the same four-digit combination (file number) cannot be recognised correctly.**

File format

Only Exif2.2-compliant JPEG images are supported.

NOTE:

- If you convert image formats using ImageCreator 1.5, folder and file names that comply with the DCF standard will be automatically assigned. (Folder names consist of three numerals followed by “PJPCN” and file names consist of “JPCN” followed by four numerals. Refer to page 32 for details on ImageCreator 1.5.)

Example of folder structure

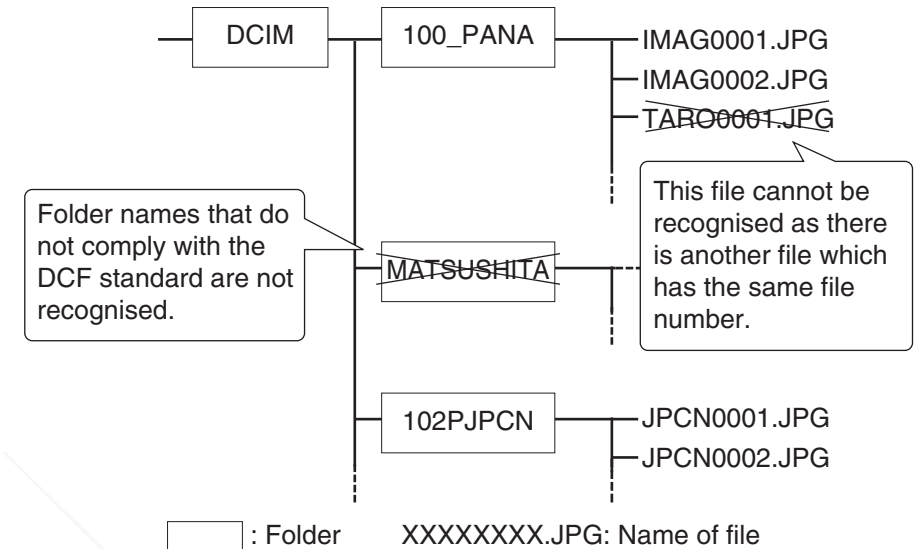

Guide screen for computer connection

Refer to the list below for details on the keyboard commands to change the output setting.

Manufacturer	Keyboard command	Manufacturer	Keyboard command
Panasonic NEC	Fn + F3	EPSON DELL	Fn + F8
TOSHIBA SHARP HP	Fn + F5	IBM SONY Other	Fn + F7 Fn +
FUJITSU	Fn + F10	Apple	F7

Dimensions

<Units: mm (inch)>

Projection dimensions calculation methods

If the screen size (diagonal) is SD (m), then the following formula is used to calculate the projection distance for the wide lens position (LW) and the projection distance for the telephoto lens position (LT).

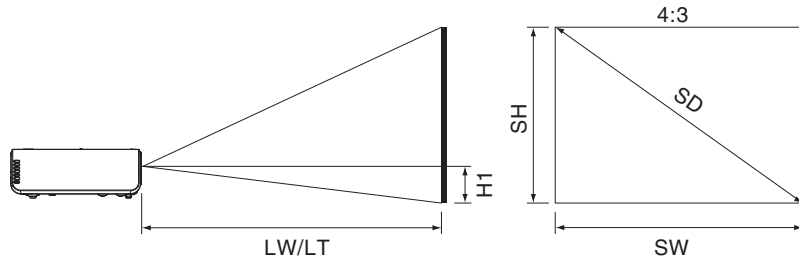

Minimum Projection Distance	$LW=0.028 \times SD / 0.0254 - 0.042$
Maximum Projection Distance	$LT=0.033 \times SD / 0.0254 - 0.043$

For 16:9 aspect ratios, the following formula can be used to calculate the projection distance.

Minimum Projection Distance	$LW=0.031 \times SD / 0.0254 - 0.042$
Maximum Projection Distance	$LT=0.036 \times SD / 0.0254 - 0.043$

*The values obtained from the formulas above are approximate.

NOTE:

- If 4:3 images are projected onto a 16:9 screen that has been set using the projection distance for a 16:9 screen, the 4:3 images will overflow the screen at the top and bottom. In such cases, set "ASPECT" to "S4:3". (Refer to page 47 for details.)

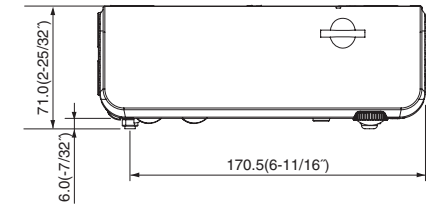
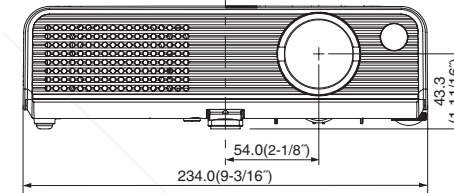
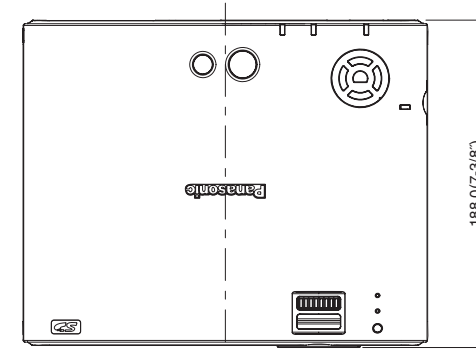
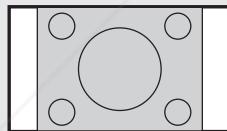

Discount-Merchant.com (800) 281-8860
 THE TRUSTED SOURCE FOR PROJECTOR LAMPS AND ACCESSORIES

Trademark acknowledgements

- The SD logo is a trademark.
- Windows and PowerPoint are trademarks or registered trademarks of Microsoft Corporation in the United States of America and other countries.
- VGA and XGA are trademarks of International Business Machines Corporation.
- Macintosh is a registered trademark of Apple Computer, Inc.
- S-VGA is a registered trademark of the Video Electronics Standards Association.

All other trademarks are the property of the various trademark owners.

Information on Disposal in other Countries outside the European Union



This symbol is only valid in the European Union.
If you wish to discard this product, please contact your local authorities or dealer and ask for the correct method of disposal.



Discount-Merchant.com (800) 281-8860
THE TRUSTED SOURCE FOR PROJECTOR LAMPS AND ACCESSORIES

NOTES IMPORTANTES CONCERNANT LA SECURITE

**AVERTISSEMENT: POUR REDUIRE LES RISQUES DE FEU OU DE CHOC
ÉLECTRIQUE, NE PAS EXPOSER CE PRODUIT À L'EAU
OU À L'HUMIDITÉ**

Alimentation: Ce projecteur LCD est conçu pour fonctionner sur secteur de 100 V - 240 V, 50 Hz/60 Hz seulement.

ATTENTION: Le cordon d'alimentation secteur fourni avec le projecteur peut être utilisé uniquement pour une alimentation électrique de 125 V, 7 A maximum. Si on veut l'utiliser avec une tension ou un courant plus forts, on doit se procurer un autre cordon d'alimentation de 250 V. Si on utilise le cordon fourni sous ces conditions, risque de provoquer un incendie.



Le symbole de la flèche en forme d'éclair, dans un triangle, avertit l'utilisateur de la présence de "tensions dangereuses" à l'intérieur du produit qui peuvent être de force suffisante pour constituer un risque de choc électrique aux personnes.



Le point d'exclamation dans un triangle avertit l'utilisateur de la présence d'instructions importantes concernant l'utilisation et l'entretien (réparation) dans la littérature accompagnant le produit.

ATTENTION: Cet appareil est équipé d'une fiche de courant à trois broches avec mise à la terre. Ne pas tirer la broche de mise à la terre de la fiche.

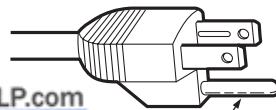

Ne pas retirer

Cette fiche ne pourra être utilisée que dans une prise avec mise à la terre. Ceci est une précaution sécuritaire. S'il est impossible d'insérer la fiche dans la prise, s'adresser à un électricien. Ne pas annuler la protection de la fiche à mise à la terre.

Others

FixYourDLP.com
Sponsored by

Discount-Merchant.com (800) 281-8860
THE TRUSTED SOURCE FOR PROJECTOR LAMPS AND ACCESSORIES

AVERTISSEMENTS:

Ne pas regarder directement dans l'objectif pendant que le projecteur fonctionne.



- Une lumière intense est émise par l'objectif du projecteur. Si l'on regarde directement dans cette lumière, elle risque de causer des blessures et de graves lésions aux yeux.
- Veiller particulièrement à ne pas laisser les jeunes enfants regarder dans l'objectif. En outre, débrancher la fiche du cordon d'alimentation de la prise de courant lorsqu'on laisse le projecteur sans surveillance.

AVERTISSEMENT:

- Ne peut être utilisé dans une salle d'ordinateurs telle que définie dans la norme ANSI/NFPA 75 Standard for Protection of Electronic Computer/Data Processing Equipment.
- Pour l'équipement branché en permanence, un dispositif de disconnexion d'accès facile doit être incorporé dans le câble d'installation du bâtiment;
- Pour l'équipement branchable, une prise secteur d'accès facile doit être installée près de l'équipement.

Précautions de sécurité

AVERTISSEMENT

Si l'on remarque une émission de fumée, d'odeurs suspectes ou de bruits provenant du projecteur, débrancher la fiche du cordon d'alimentation de la prise de courant.

- Ne pas continuer d'utiliser le projecteur dans ces cas, autrement cela peut entraîner un incendie ou des chocs électriques.
- Après s'être assuré que de la fumée ne se dégage plus, s'adresser à un centre technique agréé et demander que les réparations nécessaires soient faites.
- Le fait de réparer le projecteur soi-même est très dangereux, et ne doit jamais être fait.

Ne pas installer ce projecteur dans un endroit qui n'est pas assez résistant pour supporter le poids du projecteur.

- Si l'emplacement d'installation n'est pas assez résistant, le projecteur risque de tomber et causer de graves blessures et (ou) des dommages.

Demander à un technicien qualifié d'installer le projecteur par exemple s'il est installé au plafond.

- Si l'installation n'est pas faite correctement, cela peut entraîner des blessures ou des chocs électriques.

Si de l'eau ou des objets étrangers entrent dans le projecteur, si le projecteur tombe, ou si le boîtier est endommagé, débrancher immédiatement la fiche du cordon d'alimentation de la prise de courant.

- Si l'on continue d'utiliser le projecteur dans cette condition, cela peut entraîner un incendie ou des chocs électriques.
- S'adresser à un centre technique agréé pour que les réparations nécessaires puissent être faites.

Ne pas surcharger la prise de courant.

- Si l'alimentation est surchargée (par exemple, par l'utilisation de trop d'adaptateurs), cela risque de faire surchauffer le projecteur et peut entraîner un incendie.

Ne pas retirer le capot ou le modifier.

- Des hautes tensions qui peuvent causer de graves blessures sont présentes à l'intérieur du projecteur.
- Pour toute inspection, réglage ou réparation, s'adresser à un centre technique agréé.

Nettoyer la fiche du cordon d'alimentation régulièrement afin d'éviter toute accumulation de poussière.

- Si de la poussière s'accumule sur la fiche du cordon d'alimentation, l'humidité peut endommager l'isolant et entraîner un incendie. Débrancher la fiche du cordon d'alimentation de la prise de courant et l'essuyer avec un tissu sec.
- Si le projecteur n'est pas utilisé pendant une période prolongée, débrancher la fiche du cordon d'alimentation de la prise de courant.

Faire attention à ne pas endommager le cordon d'alimentation.

- Ne pas endommager le cordon d'alimentation, ne pas le modifier, ne pas le placer sous des objets lourds, ne pas le chauffer, ne pas le placer près d'objets chauffants, ne pas le tordre, ne pas le plier ou le tirer excessivement et ne pas le rouler en boule.
- Si le cordon d'alimentation est endommagé, cela peut entraîner un incendie et des chocs électriques.
- Si le cordon d'alimentation est endommagé, le faire réparer par un centre technique agréé.

Ne pas manipuler le cordon d'alimentation avec les mains mouillées.

- Cela peut entraîner des chocs électriques.

Brancher la fiche du cordon d'alimentation fermement dans la prise de courant.

- Si la fiche n'est pas complètement insérée, cela peut entraîner des chocs électriques ou la faire surchauffer.
- Si la fiche est endommagée ou la plaque de la prise desserrée, celles-ci ne devraient pas être utilisées.

Ne pas placer le projecteur sur des surfaces instables.

- Si le projecteur est placé sur une surface qui est inclinée ou instable, il risque de tomber ou de se renverser et cela peut causer des blessures ou des dommages.

Ne pas placer le projecteur dans l'eau ou ne pas le laisser se mouiller.

- Sinon cela peut causer un incendie ou des chocs électriques.

Ne pas placer le projecteur sur des matériaux comme du tapis ou du tissu éponge.

- Cela peut provoquer une surchauffe du projecteur, pouvant entraîner des brûlures, un incendie ou endommager le projecteur.

Ne pas placer des récipients de liquide sur le projecteur.

- Si de l'eau se renverse sur le projecteur ou pénètre dans celui-ci, il y aura risque d'incendie ou d'électrocution.
- Si de l'eau entre à l'intérieur du projecteur, entrer en contact avec un centre technique agréé.

Ne pas mettre d'objets étrangers dans le projecteur.

- Ne pas insérer d'objets métalliques ou inflammables dans les orifices de ventilation ou les faire tomber sur le projecteur, car cela peut causer un incendie ou des chocs électriques.

Conserver la carte mémoire SD (vendue séparément) et les piles hors de portée des enfants.

- Si la carte mémoire SD et des piles sont ingérées, il y aura risque de décès par étouffement. Si l'on suspecte que la carte mémoire SD et les piles ont été ingérées, appeler immédiatement un médecin.

Veiller à ce que les bornes + et - des piles n'entrent pas en contact avec des objets métalliques tels que colliers ou épingles à cheveux.

- Sinon, les piles risquent de fuir, de surchauffer, d'exploser ou de prendre feu.
- Ranger les piles dans un sac en plastique, et ne pas les ranger à proximité d'objets métalliques.

Pendant un orage, ne pas toucher le projecteur ou le câble.

- Il y a risque d'électrocution.

Ne pas utiliser l'appareil dans un bain ou une douche.

- Il y a risque d'incendie ou d'électrocution.

Veillez à ce que le faisceau lumineux n'éclaire pas directement votre peau pendant que vous utilisez le projecteur.

- Une lumière intense est émise par l'objectif du projecteur. Si vous vous placez dans ce faisceau lumineux, celui-ci risquera de vous blesser ou de vous abîmer la peau.

Ne pas placer les mains ou autres objets près de l'orifice de sortie d'air.

- De l'air chaud sort par l'orifice de sortie d'air. Ne pas placer les mains, le visage ou d'autres objets qui ne peuvent résister à la chaleur près de cette sortie d'air [laisser un espace d'au moins 10cm (4")], sinon des brûlures ou des dommages risqueraient de s'ensuivre.

Le remplacement de la lampe ne doit être effectué que par un technicien qualifié.

- La lampe a une pression interne élevée. Si elle est manipulée incorrectement, une explosion peut s'ensuivre.
- La lampe peut être facilement endommagée si elle est heurtée contre des objets durs ou si on le laisse tomber et des blessures et des mauvais fonctionnements peuvent s'ensuivre.

Lors du remplacement de la lampe, la laisser refroidir pendant au moins une heure avant de la manipuler.

- Le couvercle de la lampe devient très chaud, et on risque de se brûler si on le touche.

Avant de remplacer la lampe, veiller à débrancher la fiche du cordon d'alimentation de la prise de courant.

- Il y a risque d'électrocution ou d'explosion.

Attention

Ne pas obstruer les orifices d'entrée et de sortie d'air.

- Cela risque de faire surchauffer le projecteur, et causer un incendie ou endommager le projecteur.
- Ne pas installer le projecteur dans des endroits étroits, mal ventilés tels que des placards ou des étagères.
- Ne pas placer le projecteur sur des tissus ou du papier, ces matériaux peuvent être aspirés dans l'orifice d'entrée d'air.

Ne pas installer le projecteur dans des endroits humides ou poussiéreux ou dans des endroits où le projecteur peut entrer en contact avec de la fumée ou la vapeur.

- L'utilisation du projecteur dans de telles conditions peut causer un incendie ou des chocs électriques.

Pour débrancher le cordon d'alimentation, tenir la fiche et non pas le cordon.

- Si le cordon d'alimentation est tiré, le cordon sera endommagé et cela peut causer un incendie, des courts-circuits ou des chocs électriques sérieux.

Débrancher toujours tous les câbles avant de déplacer le projecteur.

- Le fait de déplacer le projecteur avec des câbles branchés peut endommager les câbles, ce qui pourrait causer un incendie ou des chocs électriques.

Ne pas placer d'objets lourds sur le projecteur.

- Cela peut déséquilibrer le projecteur et le faire tomber, ce qui peut entraîner des dommages ou des blessures.

Ne pas court-circuiter, chauffer ou démonter les piles, et ne pas les mettre dans l'eau ou dans le feu.

- Sinon, les piles risqueront de surchauffer, de fuir, d'exploser ou de prendre feu, et donc de causer des brûlures ou d'autres blessures.

Lorsqu'on insère les piles, veiller à ce que les polarités (+ et -) soient bien respectées.

- Si l'on insère les piles incorrectement, elles risqueront d'exploser ou de fuir, ce qui peut causer un incendie, des blessures ou une contamination du logement des piles et de la zone environnante.

Utiliser uniquement les piles spécifiées.

- Si l'on utilise des piles incorrectes, elles risqueront d'exploser ou de fuir, ce qui peut causer un incendie, des blessures ou une contamination du logement des piles et de la zone environnante.

Isoler la pile à l'aide d'adhésif ou autre avant de la mettre au rebut.

- Si la pile entre en contact avec des objets métalliques ou d'autres piles, elle peut prendre feu ou éclater.

Ne pas peser de tout son poids sur ce projecteur.

- On risque de tomber ou de casser l'appareil, ce qui peut causer des blessures.
- Veiller tout particulièrement à ce que les enfants ne se tiennent pas debout ou ne s'asseyent pas sur le projecteur.

Si l'on n'utilise pas le projecteur pendant une période prolongée, débrancher la fiche du cordon d'alimentation de la prise de courant.

- Si de la poussière s'accumule sur la fiche du cordon d'alimentation, l'humidité ainsi créée risquera d'endommager l'isolation, ce qui peut provoquer un incendie.

- Ce projecteur continue de consommer environ 3 W de courant, même lorsque l'alimentation électrique est coupée.

Débrancher la fiche du cordon d'alimentation de la prise de courant comme mesure de sécurité avant d'effectuer tout nettoyage.

- Sinon cela peut causer des chocs électriques.

Si la lampe est brisée, aérer la salle immédiatement. Ne pas toucher ou approcher le visage des morceaux brisés.

- Sinon, l'utilisateur risquera d'inhaler le gaz qui s'est dégagé lorsque la lampe s'est brisée, et qui contient à peu près la même quantité de mercure que les lampes fluorescentes, et d'être blessé par les morceaux brisés.
- Si l'on pense avoir inhalé le gaz, ou que le gaz a pénétré dans les yeux ou la bouche, consulter immédiatement un médecin.
- Demander à son revendeur de remplacer l'unité de lampe et de vérifier l'intérieur du projecteur.

Demander à un centre technique agréé de nettoyer l'intérieur du projecteur au moins une fois par an.

- S'il n'est pas nettoyé et que de la poussière s'accumule à l'intérieur du projecteur, cela peut causer un incendie ou des problèmes de fonctionnement.
- Il est recommandé de nettoyer l'intérieur du projecteur avant l'arrivée de la saison humide. Demander au centre technique agréé le plus proche de nettoyer le projecteur lorsque cela est requis. Se renseigner auprès du centre technique agréé pour le coût du nettoyage.

Nous faisons tous les efforts possibles afin de préserver l'environnement. Prière de rapporter l'appareil, s'il n'est pas réparable, à votre revendeur ou à un centre de recyclage.

Avant l'utilisation

Précaution à prendre lors du déplacement du projecteur

Veiller à ce que le capuchon d'objectif soit bien fixé à l'objectif avant de déplacer le projecteur.

L'objectif de projection est très sensible aux vibrations et aux chocs. Lorsqu'on déplace le projecteur, utiliser la housse fournie. Lorsqu'on place le projecteur dans la housse, le placer de façon que l'objectif soit orienté vers le haut. Ne rien mettre d'autre que le projecteur, les câbles, la télécommande et la carte mémoire SD dans la housse.

Avertissements concernant l'installation

Éviter de l'installer dans les endroits sujets à des vibrations ou à des chocs.

Les pièces internes peuvent être endommagées, ce qui peut causer des pannes ou des accidents.

Éviter d'installer le projecteur à des endroits sujets à des changements de température brusques, à proximité d'un climatiseur par exemple.

La durée de vie de la lampe risquerait d'être réduite.

Ne pas installer le projecteur près de lignes d'alimentation électrique à haute tension ou de moteurs.

Le projecteur peut être soumis à des interférences électromagnétiques.

Si le projecteur est installé au plafond, demander à un technicien qualifié de faire tous les travaux d'installation.

Il faut acheter le kit d'installation séparé (numéro de modèle: ET-PPK1).

En outre, tous les travaux d'installation doivent être exécutés uniquement par un technicien qualifié.

Si l'on utilise ce projecteur à un endroit élevé (au-dessus de 1 400 m), régler la "MONTAGNE" sur "OUI" (se référer à la page 50).

Sinon, des anomalies pourront se produire.

Notes sur l'utilisation

Afin d'obtenir la meilleure qualité d'image

Fermer les rideaux ou les volets de toutes les fenêtres et éteindre les lampes fluorescentes situées à proximité de l'écran afin que la lumière extérieure ou la lumière des lampes intérieures n'éclaire pas l'écran.

Ne pas toucher les pièces en verre de l'objectif et le capuchon d'objectif avec les mains nues.

Si les pièces en verre de l'objectif et le capuchon d'objectif sont salis par des traces de doigts ou autres, ces traces seront agrandies et projetées sur l'écran.

Écran

N'appliquer aucun produit volatil qui risque de décolorer l'écran, et veiller à ce que l'écran ne soit pas sale ou endommagé.

Fente de carte mémoire SD

Veiller à ce qu'il n'y ait aucun objet étranger dans la fente lorsqu'on insère la carte mémoire SD (vendue séparément). Sinon, on risquera d'endommager la carte et la fente.

Lampe

Il est possible qu'il faille remplacer la lampe plus tôt en raison de facteurs variables comme les caractéristiques de la lampe, des conditions d'utilisation et un environnement d'installation particuliers, notamment si elle est utilisée de façon continue pendant plus de 10 heures ou si l'alimentation est fréquemment mise en et hors circuit.

Affichage à cristaux liquides

L'affichage à cristaux liquides du projecteur a été fabriqué en utilisant une technologie de haute précision afin d'offrir une image très détaillée. Il est possible que parfois quelques pixels non actifs apparaissent sur l'écran sous forme de points fixes bleus, verts ou rouges. Bien noter que ceci n'affecte pas le bon fonctionnement de votre LCD.

Remplacement du bloc de lampe

AVERTISSEMENT

Le bloc de lampe ne devrait être remplacé que par un technicien qualifié.

Lors du remplacement de la lampe, la laisser refroidir pendant au moins une heure avant de la manipuler.

- Le couvercle de la lampe devient très chaud, et on risque de se brûler si on le touche.

Notes sur le remplacement du bloc de lampe

- La lampe produisant la lumière est en verre; il ne faut donc pas la laisser tomber ou la cogner contre des objets rigides, car elle risquerait d'éclater. Faire bien attention lorsqu'on manipule la lampe.
- Jeter la lampe usagée de la même manière qu'une lampe fluorescente.
- Il faut utiliser un tournevis Phillips pour déposer le bloc de lampe.

REMARQUE:

- Le projecteur n'est pas fourni avec un bloc de lampe de rechange. Demander les détails au revendeur. Numéro de produit du bloc de lampe: **ET-LAP1**

ATTENTION:

- Ne pas utiliser un bloc de lampe avec un numéro de pièce autre que celui indiqué ci-dessus.

Période de remplacement du bloc de lampe



La lampe est un produit qui doit être remplacé. Même si la durée de vie complète de l'ampoule n'est pas encore épuisée, la luminosité de la lampe diminuera progressivement. Il faut donc remplacer périodiquement la lampe.

L'intervalle de remplacement de la lampe prévu est de 2 500 heures; il est toutefois possible qu'il faille remplacer la lampe avant ce délai en raison d'éléments variables comme les caractéristiques particulières de la lampe, les conditions d'utilisation et l'environnement d'installation. Il est recommandé de toujours avoir un bloc de lampe de rechange prêt à l'emploi.

La lampe s'éteindra automatiquement après environ 10 minutes lorsque la limite de 2 500 heures d'utilisation est atteinte, car le risque d'explosion de la lampe devient beaucoup plus grand passé cette limite.

REMARQUE:

- Bien que le délai de 2 500 heures soit l'intervalle de remplacement prévu, l'obtention de cette durée n'est pas couverte par la garantie.

	Affichage à l'écran	Indicateur LAMP
		
Plus de 2 250 heures	Affiché pendant 30 secondes. L'affichage disparaît si l'on appuie sur n'importe quelle touche.	S'allume en rouge pendant que l'image est projetée et en mode d'attente.
Plus de 2 500 heures	Reste affiché jusqu'à ce qu'une touche quelconque soit pressée.	

Méthode de remplacement du bloc de lampe

REMARQUE:

- Si la durée d'utilisation de la lampe a dépassée 2 500 heures, le projecteur passe en mode d'attente après environ 10 minutes de fonctionnement. Dès lors, faire les étapes ⑦ à ⑬ à la page suivante dans les 10 minutes.

- ① **Débrancher le cordon d'alimentation du projecteur en procédant comme indiqué à la page 28, puis vérifier si la zone environnant le bloc de lampe s'est bien refroidie.**
- ② **Utiliser un tournevis Phillips pour tourner la vis de fixation du couvercle du bloc de lampe en bas du projecteur, puis retirer le couvercle du bloc de lampe.**

Couvercle du bloc de lampe

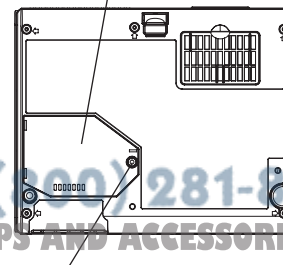

Vis de fixation du couvercle du bloc de lampe

- ③ **Utiliser un tournevis Phillips pour desserrer la vis de fixation du bloc de lampe jusqu'à ce que la vis tourne librement. Ensuite, tenir la poignée du bloc de lampe et tirer progressivement le bloc de lampe hors du projecteur.**

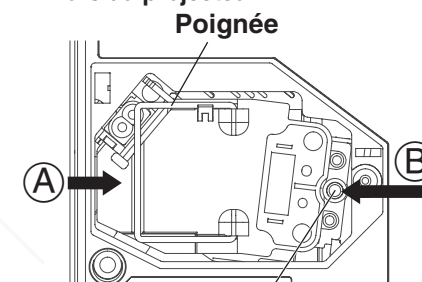

- ④ **Insérer le bloc de lampe neuf tout en s'assurant que le sens d'insertion est correct, puis utiliser un tournevis Phillips pour resserrer fermement la vis de fixation du bloc de lampe.**

Lors de l'insertion du bloc de lampe neuf, veiller à le pousser aux points A et B.



Discount-Merchant.com (800) 281-1860
THE TRUSTED SOURCE FOR PROJECTOR LAMPS AND ACCESSORIES

- ⑤ Installer le couvercle du bloc de lampe, puis utiliser un tournevis Phillips pour resserrer fermement la vis de fixation du couvercle du bloc de lampe.

REMARQUE:

- S'assurer de bien installer le bloc de lampe et le couvercle du bloc de lampe. S'ils ne sont pas bien installés, cela peut déclencher le circuit de protection et le projecteur ne pourra pas être allumé.

- ⑥ Brancher le cordon d'alimentation.

- ⑦ Appuyer sur la touche POWER pour projeter une image sur l'écran.

REMARQUE:

- Si le cordon d'alimentation a été débranché pendant la projection lorsque le projecteur a été utilisé la fois précédente, la projection s'enclenchera après qu'on ait branché le cordon d'alimentation.

- ⑧ Appuyer sur la touche MENU pour faire apparaître le "MENU PRINCIPAL", puis appuyer sur la touche ▲ ou ▼ pour sélectionner "AUTRES RÉGLAGES".

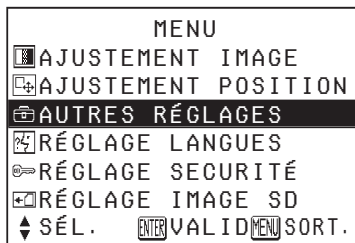

- ⑨ Appuyer sur la touche ENTER pour faire apparaître le menu "AUTRES RÉGLAGES", puis appuyer sur la touche ▲ ou ▼ pour sélectionner "DURÉE LAMPE".

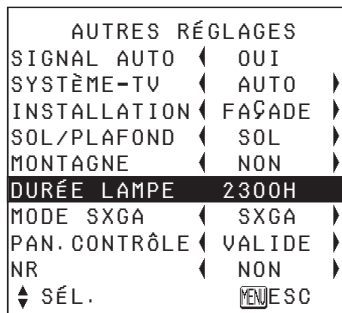

- ⑩ Maintenir la touche ENTER enfoncée pendant environ 3 secondes.

L'écran "R.A.Z. COMPTEUR LAMPE" apparaît alors.



- ⑪ Sélectionner "OUI" en appuyant sur la touche ◀ ou ▶ de la télécommande, puis appuyer sur la touche ENTER.

L'écran de confirmation "COUPE L'ALIMENTATION" apparaît alors.



REMARQUE:

- L'écran "COUPE L'ALIMENTATION" disparaît 5 secondes plus tard.
- Si l'on appuie sur la touche MENU, l'écran "R.A.Z. COMPTEUR LAMPE" et l'écran de confirmation "COUPE L'ALIMENTATION" seront annulés.

- ⑬ Débrancher le cordon d'alimentation après que la touche POWER du projecteur s'allume en rouge.

Le temps d'utilisation total du bloc de lampe est alors remis à zéro.



Disclaimer

This user manual is provided as a free service by FixYourDLP.com. FixYourDLP is in no way responsible for the content of this manual, nor do we guarantee its accuracy. FixYourDLP does not make any claim of copyright and all copyrights remain the property of their respective owners.

About FixYourDLP.com

FixYourDLP.com (<http://www.fixyourdlp.com>) is the World's #1 resource for media product news, reviews, do-it-yourself guides, and manuals.

Informational Blog: <http://www.fixyourdlp.com>

Video Guides: <http://www.fixyourdlp.com/guides>

User Forums: <http://www.fixyourdlp.com/forum>

FixYourDLP's Fight Against Counterfeit Lamps:

<http://www.fixyourdlp.com/counterfeits>

Sponsors:

RecycleYourLamp.org – Free lamp recycling services for used lamps:

<http://www.recycleyourlamp.org>

Lamp Research - The trusted 3rd party lamp research company:

<http://www.lampresearch.com>

Discount-Merchant.com – The worlds largest lamp distributor:

<http://www.discount-merchant.com>



FixYourDLP.com

Sponsored by 