



Disclaimer

This user manual is provided as a free service by FixYourDLP.com. FixYourDLP is in no way responsible for the content of this manual, nor do we guarantee its accuracy. FixYourDLP does not make any claim of copyright and all copyrights remain the property of their respective owners.

About FixYourDLP.com

FixYourDLP.com (<http://www.fixyourdpl.com>) is the World's #1 resource for media product news, reviews, do-it-yourself guides, and manuals.

Informational Blog: <http://www.fixyourdpl.com>

Video Guides: <http://www.fixyourdpl.com/guides>

User Forums: <http://www.fixyourdpl.com/forum>

FixYourDLP's Fight Against Counterfeit Lamps:

<http://www.fixyourdpl.com/counterfeits>

Sponsors:

RecycleYourLamp.org – Free lamp recycling services for used lamps:

<http://www.recycleyourlamp.org>

Lamp Research - The trusted 3rd party lamp research company:

<http://www.lampresearch.com>

Discount-Merchant.com – The worlds largest lamp distributor:

<http://www.discount-merchant.com>



FixYourDLP.com

Sponsored by 

Panasonic®

Network Function Edition

(PT-LB10NTU)



Discount-Merchant.com (800) 281-8860
THE TRUSTED SOURCE FOR PROJECTOR LAMPS AND ACCESSORIES

Contents (Network Function Edition)

Notes on Using the
Wireless Card4

Channels that can be used6

Examples of Network
Function Usage7

Software Installation8
System requirements.....8

Wireless Manager ME (Mobile Edition)9
Wireless LAN Driver.....10

Inserting and Removing the Wireless
Card to and from the Projector13

Inserting and Removing the Wireless
Card to and from a Computer14

Simple Wireless Connection
(Using the Initial Settings)15
Projector operations15

Computer operations.....16
Canceling the connection with
the projector17

Using Wireless Manager ME18
Startup.....18
Description of the connection select
window18
Description of the launcher and menu19
Live mode20
 Quitting live mode20
Multi live mode21
 4-screen style21
 Index style22
One shot mode23

Pointer mode24
 Quitting pointer mode24
Options.....24
 Picture quality selection24
 Live mode settings25
 Shortcut key settings25
Operations when password
entry is required for connection26
Adding and deleting connections26
 Adding a connection26
 Deleting a connection.....26

Displaying the Network Menu27

Contents (Network Function Edition) (cont.)

Other Applications

(Changing the Initial Settings).....28

Changing the network number28

Projector operations28

Computer operations.....28

Wireless connection with password.....29

Projector operations29

Computer operations.....29

Wireless user connections.....30

Projector operations30

Computer operations.....30

Changing the user settings.....31

Projector operations31

Computer operations.....31

Computer settings32

TCP/IP settings32

Settings for optional wireless card

(ET-CDWL3U) use34

Returning to the Initial
Settings37

Projector operations37

Computer operations.....37

Using WebBrowser

Control.....38

Projector settings.....38

Computer settings39

Starting up WebBrowser Control40

Top window40

Projector control41

Basic control window41

Option control window41

Monitor information window42

Network setting window42

Password changing window42

Using the ET-CDWL2U
(Optional wireless card).....43

Channels that can be used43

Installing the Wireless LAN Driver....44

Settings for ET-CDWL2U use49

Software Uninstall52

Wireless Manager ME52

Wireless LAN Driver.....52

Terminology53

Troubleshooting55

Trademarks57

 Discount-Merchant.com (800) 281-8860
THE TRUSTED SOURCE FOR PROJECTOR LAMPS AND ACCESSORIES

Please note the following.

- Panasonic cannot be held liable for any direct or indirect damages resulting from the use or malfunction of this projector.
- Panasonic cannot be held liable for damages arising from data corruption or loss as a result of using this projector.

Notes on Using the Wireless Card

The optional wireless card (ET-CDWL3U or ET-CDWL2U) uses radio waves in the 2.4 GHz band.

A radio station license is not required when using this wireless card, but be sure to read and fully understand the following items before use.

■ Do not use near other wireless equipment.

The following equipment may use radio waves in the same band as the wireless card. When the wireless card is used near these devices, radio wave interference may make communication impossible, or the communication speed may become slower.

- Microwave ovens, etc.
- Industrial, chemical and medical equipment, etc.
- In-plant radio stations for identifying moving objects such as those used in factory manufacturing lines, etc.
- Designated low-power radio stations



Discount-Merchant.com (800) 281-8860
THE TRUSTED SOURCE FOR PROJECTOR LAMPS AND ACCESSORIES

Notes on Using the Wireless Card (cont.)

- **If at all possible, avoid the use of cellular phones, TV sets or radios near the wireless card.**

Cellular phones, TV sets, radios and similar devices use different radio bands from the wireless card, so there is no effect on wireless card communication or the transmission and reception of these devices. However, radio waves from the wireless card may produce audio or video noise.

- **The wireless card radio waves cannot penetrate steel reinforcements, metal, concrete, etc.**

Communication is possible through walls and floors made from materials such as wood and glass (except glass containing wire mesh), but not through walls and floors made from steel reinforcements, metal, concrete, etc.



Discount-Merchant.com (800) 281-8860
THE TRUSTED SOURCE FOR PROJECTOR LAMPS AND ACCESSORIES

Notes on Using the Wireless Card (cont.)

■ Channels that can be used

The channels (frequency range) that can be used differ according to the country or region where the wireless card is used. Refer to the table below.

When using the ET-CDWL3U card (See page 43 for details on using the ET-CDWL2U card)

Country or region	Standard	Last two digits of the card product number**	Channels used	Frequency band (Center frequency)
Japan	ARIB STD33 & T66	27	1 - 13	2,412 MHz - 2,472 MHz
United States	FCC part 15	28	1 - 11	2,412 MHz - 2,462 MHz
Taiwan	DGT			
Malaysia	SIRIM			
England, Germany, France, Italy, Belgium, Austria, Sweden, Norway, Denmark, Switzerland, Holland, Finland, Portugal, Greece, Thailand, South Korea, Australia, New Zealand	ETSI 300.328	29	1 - 13	2,412 MHz - 2,472 MHz
Spain	ETSI 300.328	31	10, 11	2,457 MHz - 2,462 MHz
Singapore	IDA	30	10 - 13	2,457 MHz - 2,472 MHz



FixYourDLP.com

* Check the last two digits of the product number noted on the card rear label in the position shown in the right figure to determine the product region of the wireless card you have purchased.



Note:

Bringing a wireless card into a country other than the designated country is prohibited, and may infringe upon the wireless telegraphy laws of that country.

Examples of Network Function Usage

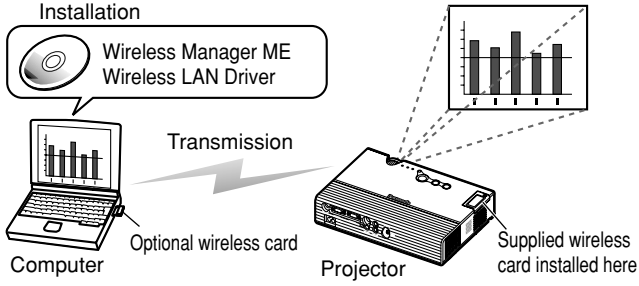
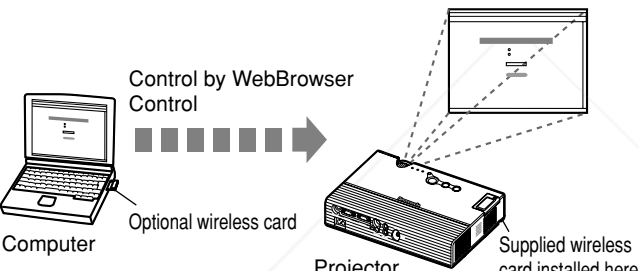
<p>Projecting a computer image by wireless operation</p> <p>Installation</p>  <p>Wireless Manager ME Wireless LAN Driver</p> <p>Transmission</p> <p>Computer</p> <p>Optional wireless card</p> <p>Projector</p> <p>Supplied wireless card installed here</p>	<p>Software Installation (See page 8)</p> <p>Simple wireless connection (See page 15)</p>
<p>Controlling the projector by WebBrowser Control</p>  <p>Control by WebBrowser Control</p> <p>Computer</p> <p>Optional wireless card</p> <p>Projector</p> <p>Supplied wireless card installed here</p>	<p>Simple wireless connection (See page 15)</p> <p>Using WebBrowser Control (See page 38)</p>



Discount-Merchant.com (800) 281-8860
THE TRUSTED SOURCE FOR PROJECTOR LAMPS AND ACCESSORIES

Software Installation

System requirements

The computer must meet the following requirements in order to use the supplied software.

- OS: Windows XP/2000/Me (Millennium Edition)/98SE (Second Edition)
CPU: Pentium III or faster or compatible processor (Celeron 633 MHz or faster is recommended. However, 800 MHz or faster is recommended when using live mode.)
RAM: 64 MB or more (128 MB or more for Windows XP/2000)
Empty hard disk capacity: 44 MB or more
Hardware conditions:
CD-ROM drive (for software installation and viewing the user's manual)
Built-in PC (PCMCIA) card slot (TYPE II or TYPE III)
The wireless card (ET-CDWL3U or ET-CDWL2U) must be installed and operating properly.
Web browser: Internet Explorer 6.0 or newer
Netscape Communicator 7.0 or newer

Note:

Note that operation is not guaranteed when used with system environments other than the above or on homemade computers.

Operation is not guaranteed for all computers that meet the above conditions.



Discount-Merchant.com (800) 281-8860
THE TRUSTED SOURCE FOR PROJECTOR LAMPS AND ACCESSORIES

Software Installation (cont.)

Wireless Manager ME (Mobile Edition)

Wireless Manager ME:

This software is used to send screen images from a computer to the projector via a wireless LAN.

Notes:

- Shut down all software currently active on Windows. Otherwise, installation may not be possible.
- Administrator authority is required for installation with Windows XP/2000.

1 Set the supplied CD-ROM in the CD-ROM drive.

The installer starts up automatically and the following screen appears.



Note:

If the installer does not start up automatically, double-click [EasyInstall] → [Easy_Inst.exe] in the CD-ROM.

2 Click [Wireless Manager ME].

Follow the instructions on the screen and install the software.



FixYourDLP.com

Sponsored by 

Discount-Merchant.com (800) 281-8860

THE TRUSTED SOURCE FOR PROJECTOR LAMPS AND ACCESSORIES

Software Installation (cont.)

Wireless LAN Driver

The Wireless LAN Driver must be installed in order to use the wireless card with a computer.

- Described below is an example of installing the driver when using the ET-CDWL3U card. (See page 44 for details when using the ET-CDWL2U card)
- When installing the driver while using a card other than the ET-CDWL3U or ET-CDWL2U, refer to the user's manual for that card.
- Some windows appear in English.

Notes:

- Be sure to install the Wireless LAN Driver in the computer before inserting the wireless card into the computer.
- If you insert the card into the computer by mistake before installing the driver, the card is recognized by the hardware auto detect function as an unknown device. Perform the following operations with the card inserted and then install the driver.

Windows XP/2000: Open [Control Panel] → [System] → [Hardware] → [Device Manager], and delete the unknown device or "Panasonic Wireless LAN PC Card".

Windows 98SE/Me: Open [Control Panel] → [System] → [Device Manager], and delete the unknown device or "Panasonic Wireless LAN PC Card".



Discount-Merchant.com (800) 281-8860
THE TRUSTED SOURCE FOR PROJECTOR LAMPS AND ACCESSORIES

Software Installation (cont.)

Windows 2000/98SE/Me:

- 1 Click [Wireless LAN Driver] at the window appearing in step 1 on page 9.**

The wireless LAN installer starts up.

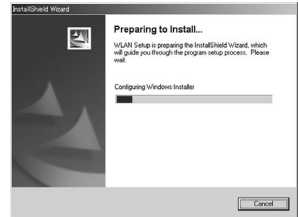

- 2 Click [Next].**

The License Agreement appears.

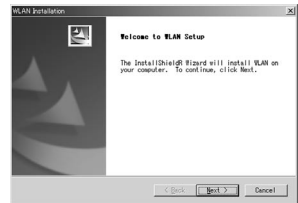

- 3 Designate the utility storage destination, and click [Next].**

The software is downloaded.

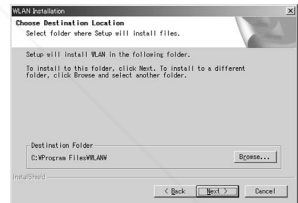

- 4 Make sure that the [Yes, I want to restart my computer now.] checkbox is checked, then click [Finish].**

The computer reboots.



- 5 Mount the optional wireless card (ET-CDWL3U) into the CF card adapter and insert it into the computer. (See page 14)**

When the permanent icon shown in the right can be confirmed, the installation is complete. When [Digital Signature Not Found] appears, click [Yes] and continue the installation.



Software Installation (cont.)

Windows XP:

Perform steps 1 to 4 of “Windows 2000/98SE/Me”, then perform the following operations.

- 5 Mount the optional wireless card (ET-CDWL3U) into the CF card adapter and insert it into the computer.** (See page 14)

The Found New Hardware Wizard starts up.



- 6 Make sure that the [Install the software automatically (Recommended)] checkbox is checked, then click [Next].**

A logo text message appears.

- 7 Click [Continue Anyway].**

The Wizard complete message appears.



- 8 Click [Finish].**

The logo authentication message appears.



Discount-Merchant.com (800) 281-8860

Check after installation:

Open [Start] → [All Programs] → [Connect To] → [Show all connections], and check that [Panasonic Wireless LAN PC Card] has been added to the wireless network connection icons.

Inserting and Removing the Wireless Card to and from the Projector

Insertion

- Before inserting the wireless card, turn off the power and keep it off for the duration of the procedure.
- Attempting to force in the wireless card facing the wrong direction may result in malfunction.

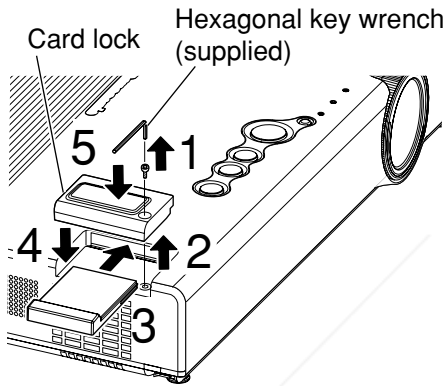

- 1** Remove the card lock screw.
- 2** Remove the card lock.
- 3** Insert the card until it locks into place.
- 4** Mount the card lock.
- 5** Secure the card lock with the screw.

Removal

Before inserting the wireless card, turn off the power and keep it off for the duration of the procedure.

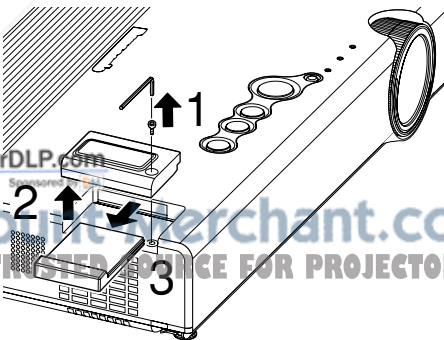

- 1** Remove the card lock screw.
- 2** Remove the card lock.
- 3** Remove the card.

Inserting and Removing the Wireless Card to and from a Computer

Insertion

- Be sure to install the Wireless LAN Driver before inserting the card. (See page 10 or page 43)
- The example given here describes the insertion of the ET-CDWL3U or ET-CDWL2U card. When using a different card, refer to the user's manual for that card.
- Be sure to also read the user's manual for the computer.
- Attempting to force in the wireless card facing the wrong direction may result in malfunction.

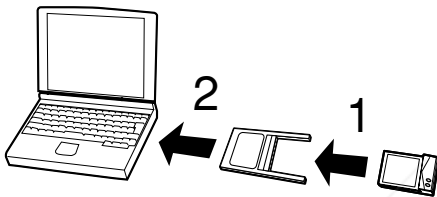

- 1** Mount the card in the adapter.
- 2** Insert the adapter into the PC card slot of the computer.

Removal

Shut down Wireless Manager ME if it is in use.

- 1** Click the [PC card] icon displayed in the task bar at the lower right of the screen.
When the [PC card] icon is not displayed:
Open [Start] → [Control Panel] → [PC card], place a check in the [Show control on the task bar] checkbox, and then click [OK].
- 2** Select [Panasonic Wireless LAN PC Card] and click [Stop].
- 3** Click [OK] and remove the wireless card.

Simple Wireless Connection (Using the Initial Settings)

When making a wireless connection between the projector and the computer using the default settings with the supplied wireless card and the optional wireless card (ET-CDWL3U or ET-CDWL2U), the IP address, communication mode and other necessary settings are made automatically when Wireless Manager ME is started up.

However, note that Wireless Manager ME and the Wireless LAN Driver must be installed.

For details on changing the initial settings and using the changed settings, refer to pages 28 to 36.

Notes:

- When not using the optional wireless card noted above, simple connection cannot be used with Windows Me/98SE.
- Operation is not guaranteed for all wireless cards and built-in wireless LAN adapters, even when using Windows XP/2000.
- You may not be able to use other network adapters during simple connection.

Projector operations

1 Insert the supplied wireless card into the projector.

(See page 13)

Only the supplied card can be used for the projector side.

2 Turn on the projector.



Discount-Merchant.com (800) 281-8860
THE TRUSTED SOURCE FOR PROJECTOR LAMPS AND ACCESSORIES

Simple Wireless Connection (Using the Initial Settings) (cont.)

Computer operations

1 Insert the optional wireless card into the computer.
(See page 14)

2 Turn on the computer.

3 Select [Start] → [Programs] → [Panasonic Wireless Display] → [Wireless Manager mobile edition].

- Wireless Manager ME starts up, and the connection select window shown below appears.



4 Select the connection and click [OK].

The launcher shown below appears and the connection with the projector is established.



Notes:

- The initial network number setting for both the projector and the computer is “1”. These numbers must match for the connection.
- Depending on the computer and wireless card used, automatic setup may not be possible. If this is the case, the [Network] setting on the screen in step 3 above will be switched to [USER] automatically. For details of the connection procedure, first close Wireless Manager ME, and then refer to page 30.

Simple Wireless Connection (Using the Initial Settings) (cont.)

Canceling the connection with the projector

- 1 Click [] on the launcher.

The following window appears.

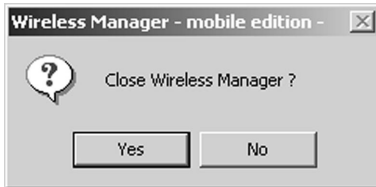

- 2 Click [Yes].

The computer returns to the original network settings when the connection is ended.

However, note that some time may be needed to return to the original network settings.

Using Wireless Manager ME

Startup

Select [Start] → [Programs] → [Panasonic Wireless Display] → [Wireless Manager mobile edition].

Description of the connection select window

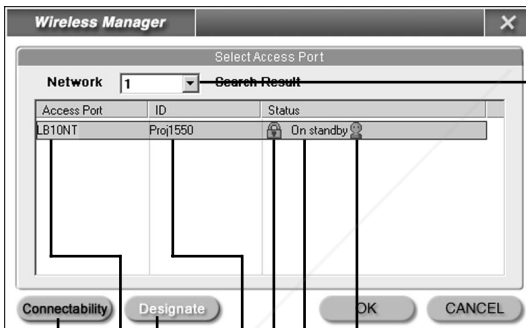

When the network number to be connected differs, select the network number to be connected. The network settings change according to this selection. This network number is stored in the computer, so connection is performed with the current number the next time Wireless Manager ME is started up.

This indicates the number of people connected to this projector.

This indicates the status of this projector.

This appears when password entry is needed for connection. (See page 26)

Projector unique ID

The equipment to be connected can be designated when [Network] is set to [USER].

Projector name

Click this to display the projector name at the upper left of the projection screen for the projector in question.

Note:

With Windows Me or Windows 98SE, [1] or [USER] is the only available selection option for the network number.

Using Wireless Manager ME (cont.)

Description of the launcher and menu

The launcher always appears on the computer screen, and can be used to perform various operations.

Right-click [] on the task tray to display the menu.

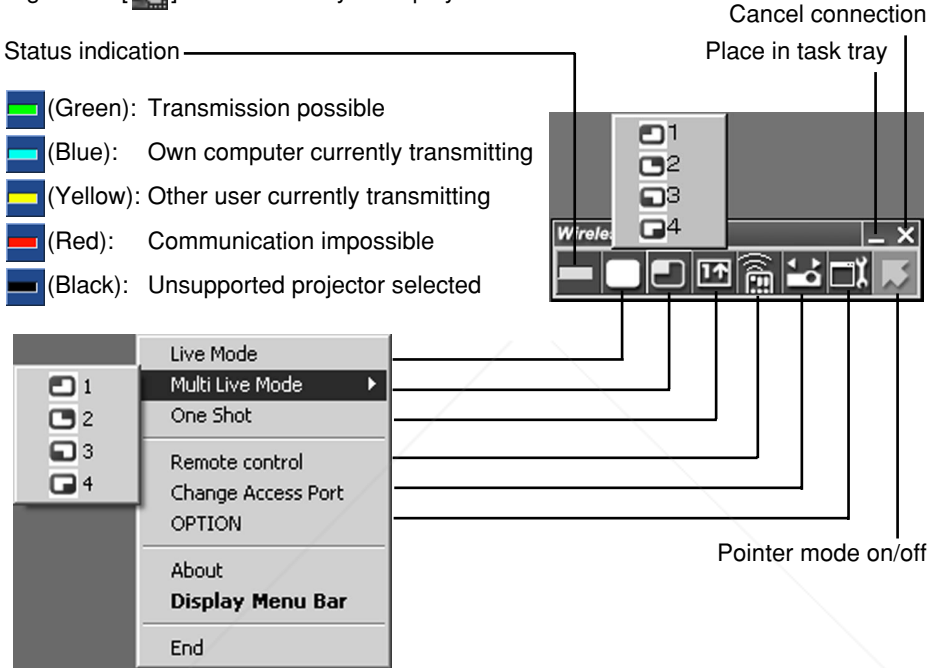

- Live Mode:** Displays the computer screen over the entire projection screen.
- Multi Live Mode:** Display the computer screen in one of the four areas on the projection screen.
- One Shot:** Transmits a snapshot of the current computer screen to the projector one time.
- Remote control:** Starts up WebBrowser Control.
- Change Access Port:** Displays the connection select window.
- OPTION:** Displays the option setting window.

Notes:

- With Windows 2000 or Windows XP, the launcher appears only on the computer screen and is not projected by the projector.
- When you do not wish to display the launcher on the computer screen, you can place the launcher in the task tray and use it as a menu from the task tray.

Using Wireless Manager ME (cont.)

Live mode

- 1 Check the status indication on the launcher to make sure that transmission is possible (check that the green lamp is lighted).**
- 2 Click [] on the launcher.**

The current computer screen is transmitted to the selected projector. In the live mode the projector is occupied by a single computer, so operations from other computers are not possible.

Note:

For presentations in full-screen live mode, the [▲ ▼] buttons on the remote control will function in the same way as the computer's up and down keys. This means that if you run a computer application that supports the [▲ ▼] buttons, the presentation screen can be changed using the remote control.

■ Quitting live mode

Click [] on the launcher.

Note:

Whether to keep the last image in the projector or clear it after quitting live mode can be set as an option. (See page 25)



FixYourDLP.com

Sponsored by 

Discount-Merchant.com (800) 281-8860
THE TRUSTED SOURCE FOR PROJECTOR LAMPS AND ACCESSORIES

Using Wireless Manager ME (cont.)

Multi live mode

This mode lets you transmit the images from four computers at the same time to a single projector. Furthermore, you can select either the “4-screen style” or the “Index style” for this mode, and switch alternately between the modes by pressing the [IndexWindow] button on the remote control or selecting [Index double] on the projector’s main menu (see page 27), and then pressing the [ENTER] button.

4-screen style



Index style



Notes:

- When the projector starts up, the 4-screen style is set for multi live mode.
- When the style setting is switched, live mode will be released for a computer in live mode. To resume the live mode, re-establish it from the launcher.

■ 4-screen style

1 Check the status indication on the launcher to make sure that transmission is possible (check that the green lamp is lighted).

2 Click [] on the launcher.

3 Select and click the projection position.

The computer image is transmitted to the selected quarter of the projection screen.



Switching to a different position

Select and click a different projection position in step 3 above.

Quitting multi live mode

Select and click the checked position in step 3 above.



Note:

In 4-screen style mode, the computer images from all the computers connected to the projector can be transmitted to the projector. (The last multi live request has priority.)

Using Wireless Manager ME (cont.)

■ Index style

1 Check the status indication on the launcher to make sure that transmission is possible (check that the green lamp is lighted).

2 Click [] on the launcher.

3 Select and click the projection position.

The computer image is transmitted to the area of the corresponding icon.

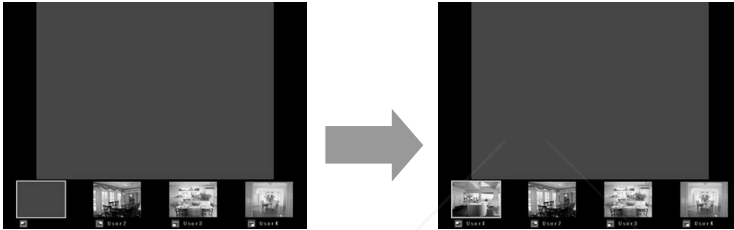

Enlarged display

- Use the [◀ ▶] buttons on the remote control to move the focus to the image to be enlarged, and press the [ENTER] button. The image is enlarged and displayed at the top of the projection screen.
- The image display will fill the entire screen if the [ENTER] button is pressed again.
- To return to the screen before, press the [ENTER] button again.



Note:

Sponsored by 

While an enlarged image is displayed, the [▲ ▼] buttons on the remote control will function in the same way as the computer's up and down keys. This means that if you run a computer application that supports the [▲ ▼] buttons, the presentation screen can be changed using the remote control.

Now use the [▲ ▼] button to set the window of the application that you want to run to the active status. (If you operate the launcher, you will set the launcher to the active status: as a result, you will need to set the window of the required application to the active status again.)

Using Wireless Manager ME (cont.)

Quitting multi live mode

Select and click the checked position in step 3 on the previous page.



Note:

In the index style mode, the green status display lamp remains lighted. You can transmit the computer images from other computers to the projector only for those icon areas which are not yet in use.

One shot mode

In this mode, a snapshot of the current computer screen is transmitted to the projector.

- 1 Check the status indication on the launcher to make sure that transmission is possible (check that the green lamp is lighted).**
- 2 Click [] on the launcher.**



Discount-Merchant.com (800) 281-8860
THE TRUSTED SOURCE FOR PROJECTOR LAMPS AND ACCESSORIES

Using Wireless Manager ME (cont.)

Pointer mode

You can change the shape of the pointer appearing on the projection screen in live mode to one that can be used for presentation purposes.

Click [] on the launcher.

■ Quitting pointer mode

Click [] on the launcher.

Options

You can make various settings related to image data transmission.

Click [] on the launcher.

The following window appears.

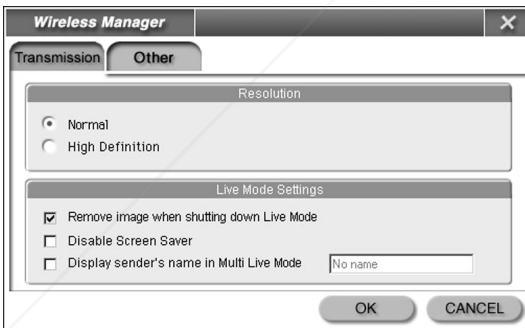

■ Picture quality selection

Select the quality of the image transmitted from the computer to the projector.

Select [Normal] or [High Definition].

Using Wireless Manager ME (cont.)

■ Live mode settings

You can set the computer operation in live mode and multi live mode.

[Remove image when shutting down Live Mode]:

Check this box to clear the projection screen from the projector when live mode ends. Normally the image when live mode ends remains projected.

[Disable Screen Saver]:

This disables the computer screen saver function while Wireless Manager ME is operating. Check this box to disable screen saver operation during live mode.

[Display sender's name in Multi Live Mode]:

The characters (max. 8) which have been entered are displayed at the upper right of the transmitted screen.

In the index style mode, they are also displayed on the right of the icon. ("No Name" appears when the check has been removed.)

■ Shortcut key settings

You can set shortcut key combinations that let you control the Wireless Manager ME functions by computer keyboard operations.

Click [Other].

[Live Mode]:

Shifts to full screen display.

[Multi Live Mode]:

Shifts to multi screen display.

[One Shot]:

Transmits the entire computer screen one time.

[Use "Pause" key to stop/continue Live Mode]:

Stops live mode and multi live mode.

[Use "PrintScreen" key to execute One Shot]:

Transmits the entire computer screen one time.

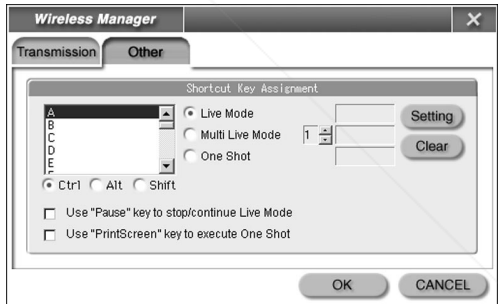

FixYourDLP.com

Note: Sponsored by 

In live mode and multi live mode, the one shot key switches the mode without stopping live mode.

Discount-Merchant.com (800) 281-8860
THE TRUSTED SOURCE FOR PROJECTOR LAMPS AND ACCESSORIES

Using Wireless Manager ME (cont.)

Operations when password entry is required for connection

When a projector with the [] mark is selected, the window shown to the right appears. Enter the password and click [OK].

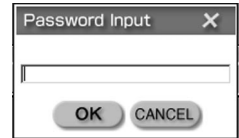

Notes:

- Click [CANCEL] at the password entry window to return to launcher (See page 16).
- When an incorrect password is entered, an error message appears. Click [OK] to return to the password entry window and enter the correct password again.

Adding and deleting connections

When [Network] is set to [USER] at the connection select window, connections can be added and deleted by the following operations.

■ Adding a connection

1 Click [Designate] at the connection select window.

The window shown to the right appears.



2 Click [ADD] and enter the IP address (including its periods) of the connection to be added, and then click [REGISTER].

The newly registered connection is added to the connection list in the window shown in step 1.



■ Deleting a connection

Select the connection to be deleted at the window shown in step 1 and click [DELETE].

Displaying the Network Menu

Perform the procedure below to display the network menu required when changing the initial settings.

1 Press the [MENU] button on the projector.

The main menu appears.

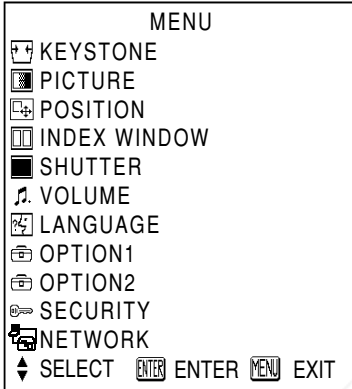

Concerning on-screen items which are not displayed:

Depending on the signals which are input to the projector, it may not be possible to adjust some of the items and use some of the functions.

In the case of an item that cannot be adjusted or a function that cannot be used, the corresponding on-screen item will not be displayed, and you will not be able to execute it even when you press the [ENTER] button.

2 Select [NETWORK] with the [▲ ▼] buttons, then press the [ENTER] button.

The network menu appears.

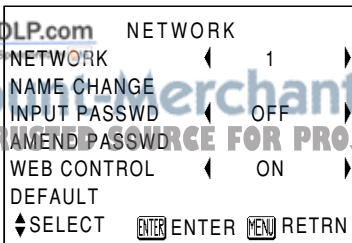

Other Applications (Changing the Initial Settings)

When making a wireless connection between a computer and the projector with settings other than the default settings, make the following settings.

Changing the network number

■ Projector operations

- 1 Select [NETWORK] at the network menu and press the [ENTER] button.
- 2 Select the number to be connected with the [◀ ▶] buttons and press the [ENTER] button.



■ Computer operations

Perform steps 1 to 3 on page 16, then perform the following operation.

- 4 Select the network group from the network number list.



Discount-Merchant.com (800) 281-8860
THE TRUSTED SOURCE FOR PROJECTOR LAMPS AND ACCESSORIES

Notes:

- With Windows Me or Windows 98SE, [1] or [USER] is the only available selection option for the network number.
- [USER] is used when the computer's network settings are to be performed manually for connection with the projector. (See page 32)

Other Applications (Changing the Initial Settings) (cont.)

Wireless connection with password

This setting is used to limit the users that can connect to the projector.

■ Projector operations

1 Select [INPUT PASSWD] on the network menu.

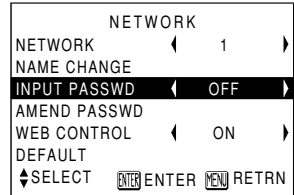

2 Select [ON] with the [◀ ▶] buttons.

3 Select [AMEND PASSWD] at the network menu and press the [ENTER] button.

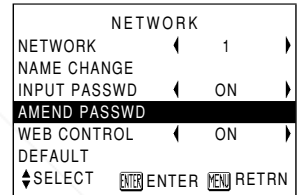

4 Enter the password using the [◀ ▶ ▲ ▼] buttons.

5 After entering the password, select [OK] and press the [ENTER] button.

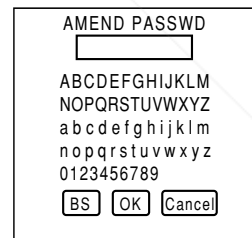

To cancel the change, select [Cancel] and press the [ENTER] button.



Discount-Merchant.com (800) 281-8860
THE TRUSTED SOURCE FOR PROJECTOR LAMPS AND ACCESSORIES

■ Computer operations

Refer to page 16.

Other Applications (Changing the Initial Settings) (cont.)

Wireless user connections

If the projector and computer could not be connected by following the steps on page 16, connect them by performing the steps below.

■ Projector operations

1 Select [NETWORK] on the network menu, and press the [ENTER] button.

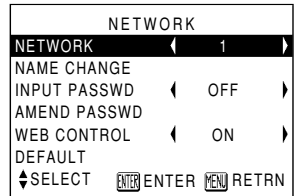

2 Select [USER] with the [◀ ▶] buttons, and press the [ENTER] button.



■ Computer operations

1 Start up the wireless card utility.

Make the same SSID, communication mode and WEP settings as the default projector network [USER] settings.

Default projector network [USER] settings	
SSID	: Panasonic Projector
Communication mode	: 802.11 AdHoc
WEP	: Off

2 Open the Windows TCP/IP Setting window.

Refer to the Windows manual for a detailed description.

For the subnet mask, register the same value as the default projector network [USER] setting.

For the IP address, enter the same value up to the “255” part of the default subnet mask setting for projector network [USER], and then enter a different value for the remainder.

Setting Example

Setting item	Default projector network [USER] setting	Example of computer setting
Subnet mask	255. 255. 255. 0	255. 255. 255. 0
IP address	192. 168. 10. 100	192. 168. 10. 101

3 Start up Wireless Manager ME, and select [USER] from the network number list. (See page 28)

Wait until the projector’s host name appears on the connection list, select the host name displayed, and proceed with the connections.

Other Applications (Changing the Initial Settings) (cont.)

Changing the user settings

Connect the projector and computer before taking the steps below.
(See page 15 or page 30)

■ Projector operations

- 1 Select [WEB CONTROL] on the network menu.
- 2 Use the [◀ ▶] buttons to select [ON].

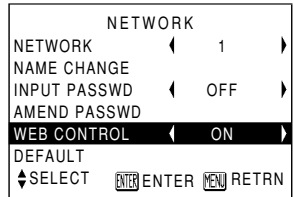

■ Computer operations

- 1 Click [📶] on the launcher (See page 16).
- 2 **Change the projector settings by WEB Control.**
Make the SSID, communication mode, IP address, subnet mask and WEP settings, and then quit WEB Control.

Note:

When [USER1] is set, the name does not appear in the connection list until the projector network is switched to [USER].

Other Applications (Changing the Initial Settings) (cont.)

Computer settings

■ TCP/IP settings

Windows XP/2000:

The screens show the example for Windows XP.

- (1) Right-click [My Network Places] to open the Properties window.



- (2) Right-click [Panasonic Wireless LAN PC Card] to open the Properties window.

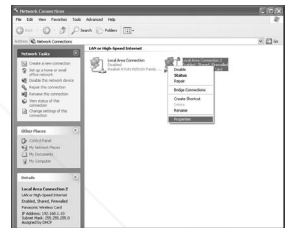

- (3) Select Internet Protocol (TCP/IP) and click [Properties].



- (4) Enter the same segment IP address as the IP address set by the projector.

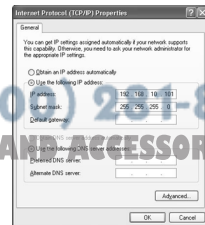

- (5) Enter the same value as the subnet mask set by the projector, set the gateway (only in infrastructure mode), and then click [OK] to return to the previous window.

- (6) Click [OK].

The new settings can be used without rebooting.

Other Applications (Changing the Initial Settings) (cont.)

■ **Settings for optional wireless card (ET-CDWL3U) use**

(See page 49 for ET-CDWL2U)

Windows XP:

The dedicated utility software is not necessary. Refer to the Windows XP manual for a detailed description.

- (1) Turn on the projector.
- (2) Select [Start] → [Connect To] → [Show all connections] → [Wireless network connection].
- (3) Right-click the [Panasonic Wireless LAN PC Card] icon and select [Show available wireless network].
The wireless network connection window appears.
- (4) Select the projector's SSID (default setting: Panasonic Projector) from the list of [Available wireless network], then click [Connect To].

Notes:

- When encryption (WEP setting) is set by the projector, enter the WEP key (character input) information to [Network Key] before clicking [Connect To]. (default setting: No WEP)
- To check the detailed network settings, click the [Wireless network settings] icon at the network connection window.



Discount-Merchant.com (800) 281-8860
THE TRUSTED SOURCE FOR PROJECTOR LAMPS AND ACCESSORIES

Other Applications (Changing the Initial Settings) (cont.)

Windows 2000/Me/98SE:

Note:

Do not use the utility software during simple connection, as this may cause a problem in connection with the projector.

- (1) Double-click the permanent icon at the lower right of the computer screen.
The utility software starts up.



- (2) Click [Profile].

- (3) Enter the network name and the SSID of the projector to be connected (default network [USER] setting: Panasonic Projector).

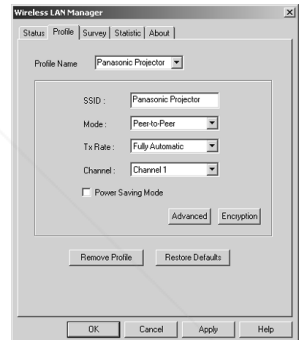

- (4) Select the communication mode of the projector to be connected (default network [USER] setting: Peer-to-Peer), and set the transfer rate (Tx Rate) to [Full Automatic].
Leave the Channel Setting (Channel) to default.

- (5) If encryption (WEP) has been set in the projector, click the encryption setting (Encryption).

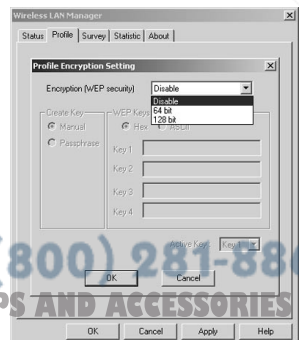

(Continued on next page)

Other Applications (Changing the Initial Settings) (cont.)

- (6) Select the encryption key length, which is set in the projector, and enter the WEP key.

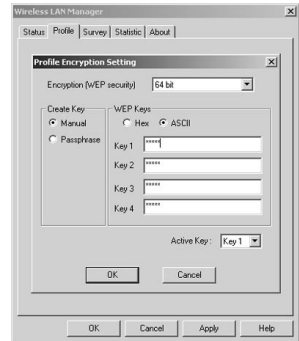

Notes:

- The communication mode does not support AdHoc mode. Select 802.11 AdHoc (Peer to Peer) or Infrastructure (Access Point).
- Some cards other than the optional wireless card (ET-CDWL3U or ET-CDWL2U) support only AdHoc mode. These cards cannot be used.
- When using encryption (WEP), change the setting from [Disable] to [64 bits] or [128 bits]. Set to [Disable] when not using encryption.
- WEP input can be selected from character input (ASC II) or hexadecimal input (Hex).
Character input: 5 characters for 64 bits, 13 characters for 128 bits
Hexadecimal input: 0 to 9 and A to F. 10 characters for 64 bits, 26 characters for 128 bits
- Set the WEP key to match the projector side setting. Leave the key (Active Key) to default: 1.

Returning to the Initial Settings

You can return the changed settings to the initial conditions.

Projector operations

- 1 Select **[DEFAULT]** at the network menu (See page 27) and press the **[ENTER]** button.

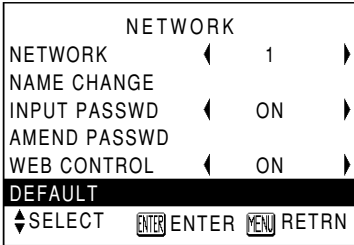

Note:
You will be prompted to enter the password if ON has been selected as the [INPUT PASSWD] setting on the security menu.

- 2 Select **[OK]** with the **[◀ ▶]** buttons and press the **[ENTER]** button.



Computer operations



Start the Wireless Manager ME and set the network number to **[1]** (see page 28).

Sponsored by Discount-Merchant.com (800) 281-8860
THE TRUSTED SOURCE FOR PROJECTOR LAMPS AND ACCESSORIES

Using WebBrowser Control

Projector settings

- 1** Select [WEB CONTROL] on the network menu (See page 27).
- 2** Select [ON] or [OFF] with the [◀ ▶] buttons.

WEB CONTROL

ON: WebBrowser Control is enabled.

OFF: WebBrowser Control is disabled.

Note:

The WebBrowser Control password is not set at the factory, and should be set on the web browser. In addition, if you forget the password, select [DEFAULT] at the network menu and initialize the network settings. (See page 37)



Discount-Merchant.com (800) 281-8860
THE TRUSTED SOURCE FOR PROJECTOR LAMPS AND ACCESSORIES

Using WebBrowser Control (cont.)

Computer settings

1 Right-click the [Internet Explorer] icon.

Open the Properties window.

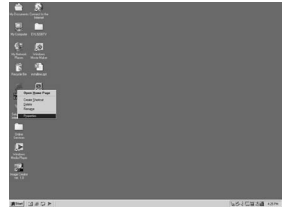

2 Open [Connections] → [LAN Settings]. If [Use automatic configuration script] has been checked, remove the check, and click [OK].

The setting window closes.



Notes:

- When a proxy server is already being used, these settings are automatically established if the network number is 1 to 4. (However, only for Internet Explorer Ver.6.0 or newer)
- In all other cases, under [Advanced] you must set the IP address of the projector to be connected for not using the proxy server as an exception.

3 Select [Security] and set the security level to [Default Level], or select [Custom Level] and check the [Enable] checkbox under [Active scripting].

Note: DLP.com

When using Netscape, select [Edit] → [Preferences] → [Advanced] and enable JavaScript.

Discount-Merchant.com (800) 281-8860

THE TRUSTED SOURCE FOR PROJECTOR LAMPS AND ACCESSORIES

Using WebBrowser Control (cont.)

Starting up WebBrowser Control

Click [] on the launcher (see page 16) or start up the browser software, and enter the IP address set by the projector.

(The example below describes the case when using Microsoft Internet Explorer.)



WebBrowser Control starts up.

■ Top window

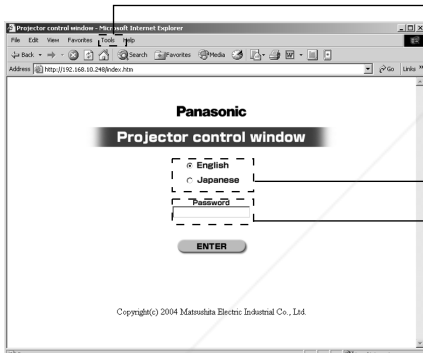

Set to not use a proxy server. (When using a proxy server, refer to page 39.)

Select English or Japanese.

Enter the password when a password is set.

Notes:

- If you forget the password, set a new password on the projector side. (The former password is protected by security, and cannot be viewed even by the projector.)
- The top window may not appear depending on the browser software. In this case start up WebBrowser Control again, or press the [Ctrl] + [R] keys.

Using WebBrowser Control (cont.)

Projector control

Click [Projector Control] in the menu.
You can make various projector settings.

■ Basic control window

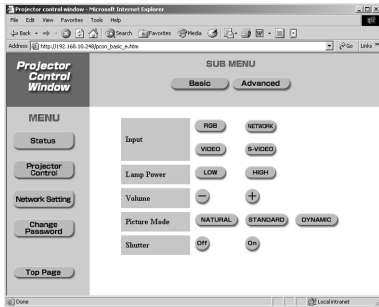

Notes:

- Connection with the projector may not be possible immediately after the power is turned on. In this case wait a bit and then make the connection again.
- When [WEB CONTROL] is not set to [ON] in the projector network settings, the basic controls and option controls do not operate.

■ Option control window

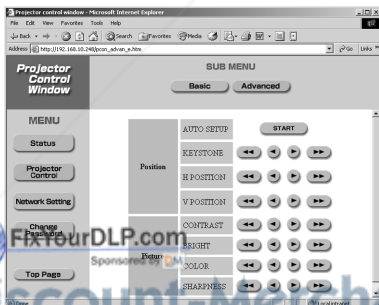

Note:

When the projector does not operate as controlled, check that the [WEB CONTROL] item in the projector's option menu is set to [ON].

Using WebBrowser Control (cont.)

■ Monitor information window

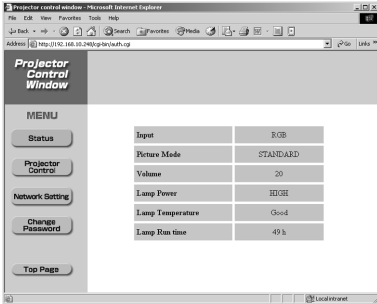

Note:

The monitor information is refreshed at fixed intervals, but the current exact information can be checked by clicking [View] → [Refresh].

■ Network setting window

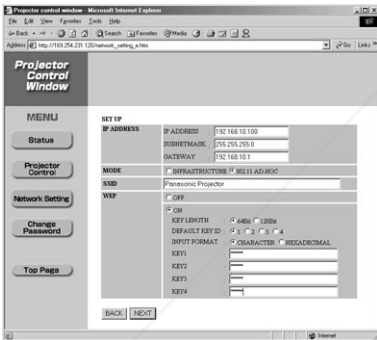

Click [Network Settings] → [NEXT] to display the network setting window, and enter the required data.

■ Password changing window

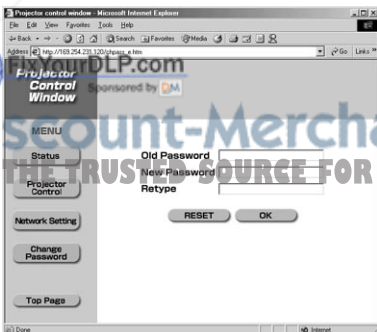

Enter the old password and new password, and click [OK].

Using the ET-CDWL2U (Optional wireless card)

■ Channels that can be used

The channels (frequency range) that can be used differ according to the country or region where the wireless card is used. Refer to the table below.

Country or region	Standard	Last two digits of the card product number*	Channels used	Frequency band (Center frequency)
Japan	ARIB STD33 & T66	22	1 - 13	2,412 MHz - 2,472 MHz
United States	FCC part 15	23	1 - 11	2,412 MHz - 2,462 MHz
Taiwan	DGT			
Malaysia	SIRIM			
England, Germany, France, Italy, Belgium, Austria, Sweden, Norway, Denmark, Switzerland, Holland, Finland, Portugal, Greece, Thailand, South Korea, Australia, New Zealand	ETSI 300.328	24	1 - 13	2,412 MHz - 2,472 MHz
Spain	ETSI 300.328	25	10, 11	2,457 MHz - 2,462 MHz
Singapore	IDA	26	10 - 13	2,457 MHz - 2,472 MHz



FixYourDLP.com

* Check the last two digits of the product number noted on the card rear label in the position shown in the right figure to determine the product region of the wireless card you have purchased.



Note:

Bringing a wireless card into a country other than the designated country is prohibited, and may infringe upon the wireless telegraphy laws of that country.

Using the ET-CDWL2U (Optional wireless card) (cont.)

■ Installing the Wireless LAN Driver

The Wireless LAN Driver must be installed in order for the wireless card to be used in the computer.

- The example of the procedure described below is for installing the ET-CDWL2U card.
- Some windows appear in English.

Notes:

- Be sure to install the Wireless LAN Driver in the computer before inserting the wireless card into the computer.
- If you insert the card into the computer by mistake before installing the driver, the card is recognized by the hardware auto detect function as an unknown device. Perform the following operations with the card inserted and then install the driver.

Windows XP/2000: Open [Control Panel] → [System] → [Hardware] → [Device Manager], and delete the unknown device or “Panasonic Wireless LAN PC Card”.

Windows 98SE/Me: Open [Control Panel] → [System] → [Device Manager], and delete the unknown device or “Panasonic Wireless LAN PC Card”.

1 Place the supplied CD-ROM in the CD-ROM drive.

If the installation window is displayed, click [Close].

2 Select [Start] → [Run].

3 Enter [e:\CDWL2\setup.exe] in the [Open] field, and click [OK].

This example assumes that the E: is the name of the CD-ROM drive.
If it is not, replace the first “e” with the correct letter that represents the drive.



Discount-Merchant.com (800) 281-8860
THE TRUSTED SOURCE FOR PROJECTOR LAMPS AND ACCESSORIES

Using the ET-CDWL2U (Optional wireless card) (cont.)

Windows 2000:

The wireless LAN installer starts up when steps 1 to 3 on page 44 have been performed. Now proceed as follows.

4 Click [Next].
The License Agreement appears.

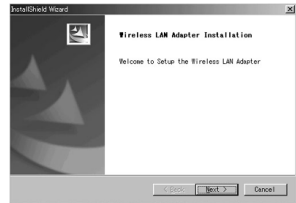

5 Click [Yes].

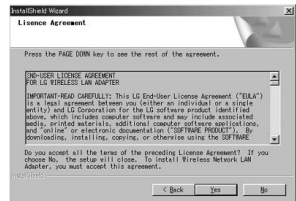

6 Specify where the utility is to be saved, and click [Next].
The software is now downloaded, and the [Digital Signature Not Found] message appears.

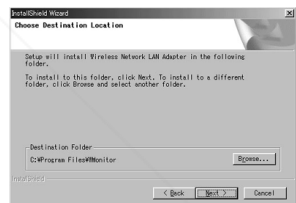

7 Click [Yes].
Follow the on-screen instructions and proceed.



8 Click [Finish].
The installation of the driver is now completed.

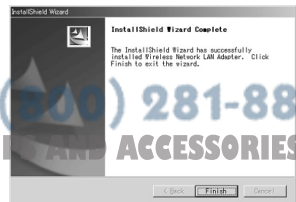

9 Mount the ET-CDWL2U card into the CF card adapter and insert it in the computer. (See page 14)

If the [Digital Signature Not Found] message appears, click [Yes] and continue the installation.

Using the ET-CDWL2U (Optional wireless card) (cont.)

Windows 98SE/Me:

The wireless LAN installer starts up when steps 1 to 3 on page 44 have been performed. Now proceed as follows.

- 4** Click [Next].
The License Agreement appears.

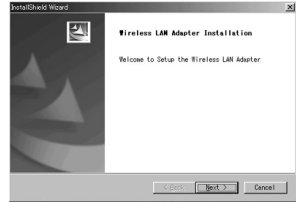

- 5** Click [Yes].

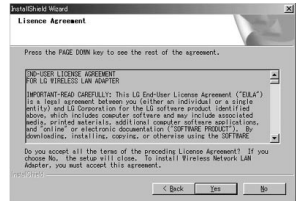

- 6** Specify where the utility is to be saved, and click [Next].
The software is downloaded.

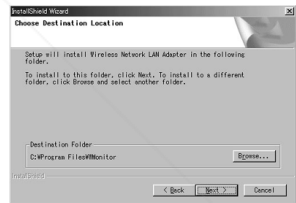

- 7** Make sure that [Yes, I want to restart my computer now.] checkbox is checked, then click [Finish].
The computer reboots.

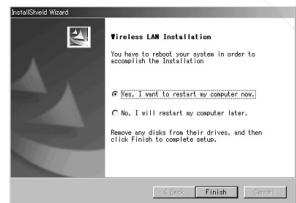

- 8** Mount the ET-CDWL2U card into the CF card adapter and insert it in the computer. (See page 14)

The installation of the driver is now completed if the permanent icon on the right can be confirmed. If this icon cannot be found, select [Start] → [Programs] → [Wireless Network] → [Wireless Network LAN Adapter].



Using the ET-CDWL2U (Optional wireless card) (cont.)

Windows XP:

The wireless LAN installer starts up when steps 1 to 3 on page 44 have been performed. Now proceed as follows.

4 Click [Next].
The License Agreement appears.

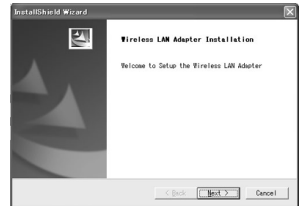

5 Click [Yes].



6 Specify where the utility is to be saved, and click [Next].
The logo authentication message appears.

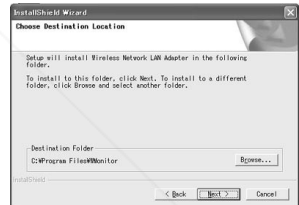

7 Click [Continue Anyway].



8 Click [Finish].

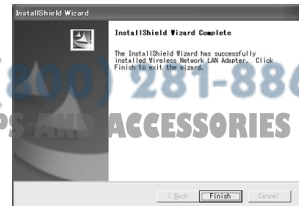

(Continued on next page)

Using the ET-CDWL2U (Optional wireless card) (cont.)

- 9 Mount the ET-CDWL2U card into the CF card adapter and insert it in the computer.** (See page 14)

The Found New Hardware Wizard starts up.



- 10 Make sure that [Install the software automatically (Recommended)] checkbox is checked, then click [Next].**

The logo text message appears.

- 11 Click [Continue Anyway].**

The wizard complete message appears.



- 12 Click [Finish].**

The logo authentication message appears.



Discount-Merchant.com (800) 281-8860
THE TRUSTED SOURCE FOR PROJECTOR LAMPS AND ACCESSORIES

Check after installation:

Open [Start] → [All Programs] → [Connect To] → [Show all connections], and check that [Panasonic Wireless LAN PC Card] has been added to the wireless network connection icons.

Using the ET-CDWL2U (Optional wireless card) (cont.)

■ Settings for ET-CDWL2U use

Windows XP:

The dedicated utility software is not necessary. Refer to the Windows XP manual for a detailed description.

- (1) Turn on the projector.
- (2) Select [Start] → [Connect To] → [Show all connections] → [Wireless network connection].
- (3) Right-click the [Panasonic Wireless LAN PC Card] icon and select [Show available wireless network].
The wireless network connection window appears.
- (4) Select the projector's SSID (default setting: Panasonic Projector) from the list of [Available wireless network], then click [Connect To].

Notes:

- When encryption (WEP setting) is set by the projector, enter the WEP key (character input) information to [Network Key] before clicking [Connect To]. (default setting: No WEP)
- To check the detailed network settings, click the [Wireless network settings] icon at the network connection window.



Discount-Merchant.com (800) 281-8860
THE TRUSTED SOURCE FOR PROJECTOR LAMPS AND ACCESSORIES

Using the ET-CDWL2U (Optional wireless card) (cont.)

Windows 2000/Me/98SE:

Note:

Do not use the utility software during simple connection, as this may cause a problem in connection with the projector.

- (1) Double-click the permanent icon at the lower right of the computer screen.
The utility software starts up.



- (2) Click the [Profile Setting] item, then click [Add].

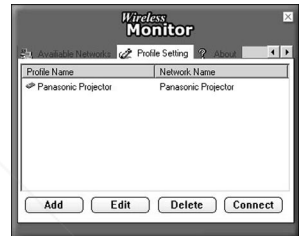

Note:

To change the setting contents, select the setting name to be changed with the mouse, then click [Edit].

- (3) Enter the network setting name, and click [Next]. Then enter the network name (SSID of the projector to be connected, default network [USER] setting: Panasonic Projector).

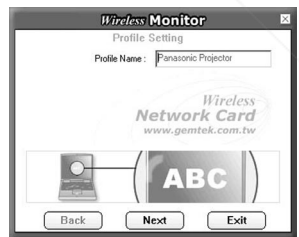

- (4) Select the communication mode of the projector to be connected (default network [USER] setting: 802.11 AdHoc), and set the transfer rate to [Automatic]. Then click [Next].

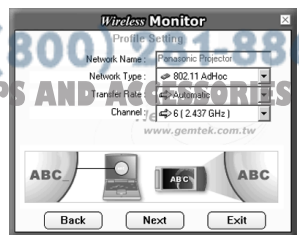

- (5) If encryption (WEP) has been set in the projector, set it here. (Default network [USER] setting: [Off])

(Continued on next page)

Using the ET-CDWL2U (Optional wireless card) (cont.)

Notes:

- The communication mode does not support AdHoc mode. Select 802.11 AdHoc (Peer to Peer) or Infrastructure (Access Point).
- Some cards other than the optional wireless card (ET-CDWL3U or ET-CDWL2U) support only AdHoc mode. These cards cannot be used.
- When using encryption (WEP), change the setting from [Off] to [64 (40) bits] or [128 bits], then click [Next]. Set to [Off] when not using encryption.
- WEP input can be selected from character input or hexadecimal input.
 Character input: 5 characters for 64 (40) bits, 13 characters for 128 bits
 Hexadecimal input: 0 to 9 and A to F. 10 characters for 64 (40) bits, 26 characters for 128 bits
- Set the WEP key to match the projector side setting. Leave the default key as "1".

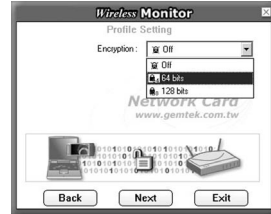

(6) Set [IP Setting] to [Disable], then click [Complete].

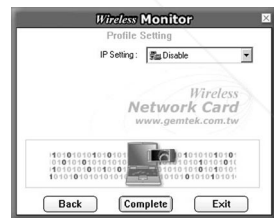

Note:

The connection status with the projector can be checked by the link status. Click [More...].

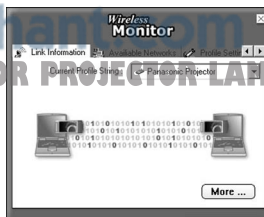

Software Uninstall

Wireless Manager ME

From the desktop, select [Start] → [Programs] → [Panasonic Wireless Display] → [Uninstall Wireless Manager mobile edition].

Follow the instructions appearing on the screen and uninstall the software.

Wireless LAN Driver

■ Windows XP:

- 1** Set the supplied CD-ROM in the CD-ROM drive.
- 2** Execute [Wireless Card] → [setup.exe] in the CD-ROM.
The uninstall software starts up.
- 3** Make sure that a check is placed in the [Remove] checkbox, then click [Next].
- 4** When the uninstall complete message appears, click [Finish].

■ Windows 2000/Me/98SE:

- 1** Select [Start] → [Programs] → [Wireless Network] and execute [Uninstalled].
- 2** Make sure that a check is placed in the [Remove] checkbox, then click [Next].
- 3** Make sure that a check is placed in the [Yes, I want to restart my computer now.] checkbox, then click [Finish].

Terminology

802.11 AdHoc (Peer to Peer) mode

This mode performs communication directly between the projector and a computer with a built-in wireless LAN or a computer with a wireless LAN card mounted. The SSID must be set.

Access point

A wireless station used to connect a wired LAN and a wireless LAN.

AdHoc mode

This mode performs communication directly between the projector and a computer using built-in wireless LAN or a computer with a wireless LAN card mounted. The projector and computer channel settings must be the same. Some cards do not support this mode.

Channel

When multiple access points that use the same frequency band during communication are installed near each other, radio wave interference may cause the communication speed to drop. The frequency band can be divided into 14 channels for communication to reduce this interference in a wireless LAN. (The number of channels differs according to the country of use.) However, there is still some interference between adjacent channels, so communication channels should be separated by 2 or 3 channels during actual use.

DHCP

Abbreviation for Dynamic Host Configuration Protocol. This function automatically assigns IP addresses to the connected equipment. If a device with the DHCP server function is present within a LAN, it automatically assigns IP addresses to the connected equipment. This is not supported on the projector side.

Gateway

This is a relay point for connecting different networks.

This refers to the hardware and software used when connecting a network with a network that uses a different protocol, etc. It adjusts the protocol and other differences between networks to allow connection with other networks.

Infrastructure mode

This mode performs communication via an access point connected to a wired LAN.

This makes it possible to transfer images to the projector through an access point even from a computer without a wireless LAN card mounted.

IP address

Internet Protocol (IP) is a protocol for distributing data, and the address corresponding to the data distribution destination is called the IP address. The same IP address cannot be used within the same LAN.

Terminology (cont.)

LAN

Abbreviation for Local Area Network. This is a network with a relatively narrow range such as inside a company. There are wired LAN and wireless LAN.

SSID

Abbreviation for Service Set ID. The SSID identification code must be set to distinguish equipment included in a wireless LAN that uses access points from equipment not included in that LAN.

This may appear as the "ESSID" or the "network name" for wireless LAN cards made by some manufacturers.

Subnet mask

This limits the range of the IP addresses assigned to computers in order to divide the network into a number of sections during TCP/IP connection. The value used to divide the network at this time is called the subnet mask.

TCP/IP

Abbreviation for Transmission Control Protocol/Internet Protocol. This is the standard internet protocol.

This protocol is a set of rules and agreements governing data communications between computers.

WEP

Abbreviation for Wired Equivalent Privacy. This is a method for encrypting communication data. The encryption key is created and notified only to the communicating user, so the communication data cannot be decrypted by a third party.



Discount-Merchant.com (800) 281-8860
THE TRUSTED SOURCE FOR PROJECTOR LAMPS AND ACCESSORIES

Troubleshooting

Check the following points once more before requesting repair.

Symptom	Checkpoint
The image from the computer does not appear.	<ul style="list-style-type: none"> • Is the external video output of the laptop computer set correctly? (When the [Fn] and [F3] keys are pressed at the same time, the external output setting may change for some computer models. Refer to the user's manual supplied with the computer.)
The computer does not recognize the wireless card.	<ul style="list-style-type: none"> • Is the wireless card inserted firmly all the way into the PC card slot of the computer? • Has the driver been installed? • Was the driver installed before inserting the wireless card? • Are there sufficient IRQ (interrupt signal) numbers? (Refer to the Windows Online Help.)
The transfer rate is slow.	<ul style="list-style-type: none"> • The transfer rate may be slower in some operating environments (depending on such factors as the location, radio signal conditions or distance). • When WEP is set the image data is converted, so transfer takes time.
Image display is slow in live mode.	<ul style="list-style-type: none"> • Is the computer CPU speed slow? Live mode depends largely upon the computer CPU performance. • When using Windows XP/2000, the speed may drop significantly if the user does not have administrator authority.



Discount-Merchant.com (800) 281-8860
THE TRUSTED SOURCE FOR PROJECTOR LAMPS AND ACCESSORIES

Troubleshooting (cont.)

Symptom	Checkpoint
<p>The projector cannot be located on the connection list of Wireless Manager ME.</p>	<ul style="list-style-type: none"> • Check if the computer and the projector are located too far apart, or if some object is obstructing the radio waves. • Check that the IP address and the subnet mask are set correctly. • Is TCP/IP installed in the computer? • Does the WEP setting match with the projector? Communication is not possible if the WEP function is set when using a wireless card other than the optional card or when using an access point. In these cases turn off the WEP function. • In [Infrastructure] mode, set the same [SSID] for the projector and the computer as that of the access point used. The [SSID] uses alphanumeric characters (case sensitive). In addition, check that the computer control function that allows communication with access points is disabled. • In [802.11 AdHoc (Peer to Peer)] mode, set the same SSID for the projector and the computer. The SSID is case sensitive. • Is a network device other than the wireless card enabled? Check the Windows Device Manager. • Is proxy-client software active? Disable this software when communicating with the projector. • Are you running a security program that contains a personal firewall function? Before communicating data using the projector, either close the software or set up an exemption.
<p>The Wireless Manager ME color display is strange and characters are difficult to read.</p>	<ul style="list-style-type: none"> • Right-click an empty location on the desktop and select [Properties]. Then, open the [Settings] tab of the [Display Properties] window and set [Color quality] to [Medium (16 bit)] or higher.



Discount-Merchant.com (800) 281-8860
THE TRUSTED SOURCE FOR PROJECTOR LAMPS AND ACCESSORIES

Trademarks

- Windows is a trademark or registered trademark of U.S. Microsoft Corporation in the U.S. and other countries.
- Other company names, product names or other names noted in this manual are trademarks or registered trademarks of the respective companies. Note that ® and TM marks are not indicated in the text of this manual.

Notes:

- Unauthorized use or reproduction of part or all of this product software and manuals is strictly prohibited.
- Panasonic cannot be held liable for any effects resulting from the use of this product software and manuals.
- Panasonic reserves the right to revise this product software specifications and manual contents without notice.

Panasonic®

Professional/Industrial Video

Panasonic Broadcast & Television Systems Company

Division of Matsushita Electric Corporation of America

FixYourDLP.com

3330 Cahuenga Blvd West Los Angeles, CA 90068 (323) 436-3500

Technical Support:

(800) 222-0741

E-Mail: pbtscservice@panasonic.com

Panasonic Canada Inc.

5770 Ambler Drive, Mississauga, Ontario L4W 2T3 (905) 624-5010

© 2004 Matsushita Electric Industrial Co., Ltd. All Rights Reserved.

M0304-1034



Disclaimer

This user manual is provided as a free service by FixYourDLP.com. FixYourDLP is in no way responsible for the content of this manual, nor do we guarantee its accuracy. FixYourDLP does not make any claim of copyright and all copyrights remain the property of their respective owners.

About FixYourDLP.com

FixYourDLP.com (<http://www.fixyourdpl.com>) is the World's #1 resource for media product news, reviews, do-it-yourself guides, and manuals.

Informational Blog: <http://www.fixyourdpl.com>

Video Guides: <http://www.fixyourdpl.com/guides>

User Forums: <http://www.fixyourdpl.com/forum>

FixYourDLP's Fight Against Counterfeit Lamps:

<http://www.fixyourdpl.com/counterfeits>

Sponsors:

RecycleYourLamp.org – Free lamp recycling services for used lamps:

<http://www.recycleyourlamp.org>

Lamp Research - The trusted 3rd party lamp research company:

<http://www.lampresearch.com>

Discount-Merchant.com – The worlds largest lamp distributor:

<http://www.discount-merchant.com>



FixYourDLP.com

Sponsored by 