



# Disclaimer

This user manual is provided as a free service by FixYourDLP.com. FixYourDLP is in no way responsible for the content of this manual, nor do we guarantee its accuracy. FixYourDLP does not make any claim of copyright and all copyrights remain the property of their respective owners.

About FixYourDLP.com

FixYourDLP.com (<http://www.fixyourdlp.com>) is the World's #1 resource for media product news, reviews, do-it-yourself guides, and manuals.

Informational Blog: <http://www.fixyourdlp.com>

Video Guides: <http://www.fixyourdlp.com/guides>

User Forums: <http://www.fixyourdlp.com/forum>

FixYourDLP's Fight Against Counterfeit Lamps:

<http://www.fixyourdlp.com/counterfeits>

## Sponsors:

RecycleYourLamp.org – Free lamp recycling services for used lamps:

<http://www.recycleyourlamp.org>

Lamp Research - The trusted 3rd party lamp research company:

<http://www.lampresearch.com>

Discount-Merchant.com – The worlds largest lamp distributor:

<http://www.discount-merchant.com>



**FixYourDLP.com**

Sponsored by 

# Operating Instructions

LCD Projector

Model No. **PT-L797PWU**  
**PT-L797VU**  
**PT-L597U**

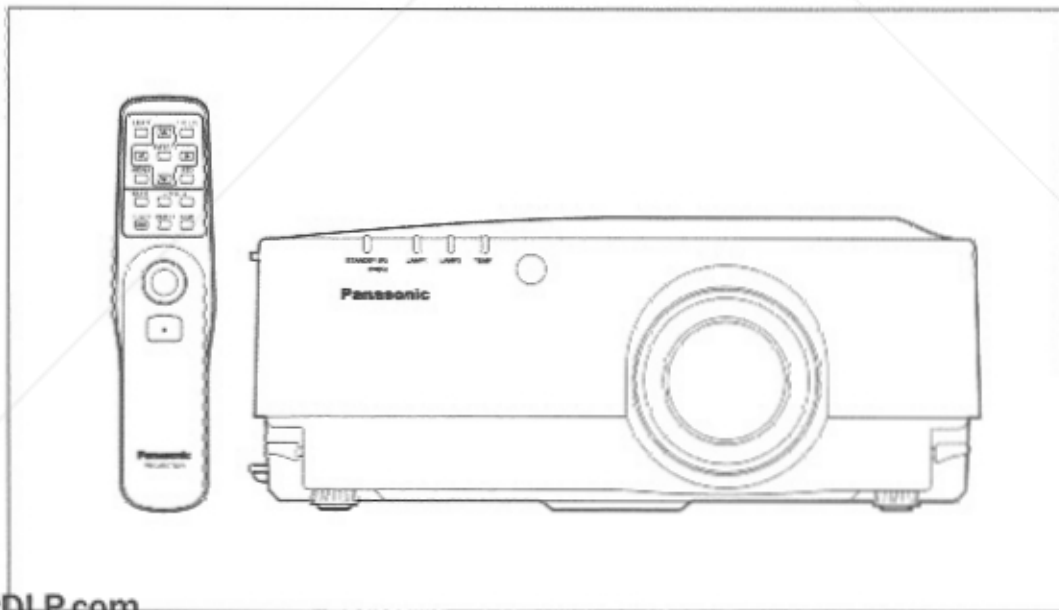

 FixYourDLP.com  
Sponsored by 

**Discount-Merchant.com (800) 281-8860**  
**Panasonic**  
THE TRUSTED SOURCE FOR PROJECTOR LAMPS AND ACCESSORIES

Read these instructions completely before operating this unit.

TQBJ 0055

# Dear Panasonic Customer:

This instruction booklet provides all the necessary operating information that you might require. We hope it will help you to get the most performance out of your new product, and that you will be pleased with your Panasonic LCD projector.

The serial number of your product may be found on its back. You should note it in the space provided below and retain this booklet in case service is required.

Model number: PT-L797PWU / PT-L797VU / PT-L597U

Serial number: \_\_\_\_\_

## Contents

Before use .....	1	Using other useful functions .....	33
IMPORTANT SAFETY NOTICE .....	2	System configuration example .....	41
Precautions with regard to safety .....	3	About the Macintosh adapter .....	43
Precautions on handling .....	5	Wireless mouse .....	43
Location and function of each part .....	6	Using the SERIAL connector .....	44
Before using the remote control unit .....	11	Using the REMOTE connector .....	46
Menu operation guide .....	13	Indicators .....	47
Turning the power on and off .....	15	Cleaning the air filter .....	48
Standard setting-up positions .....	16	Lamp unit replacement period .....	49
Adjusting the lens .....	19	Replacing the lamp unit .....	49
Changing the projection method .....	20	Before asking for service .....	52
Basic operation .....	21	Specifications .....	53
Selecting the picture mode .....	25	Trademark acknowledgements .....	54
Adjusting the picture to the desired setting .....	26	Accessories .....	55
Adjusting the white balance .....	27	Dimensions .....	55
Adjusting the sound to the desired setting .....	28	NOTES IMPORTANTES CONCERNANT LA SÉCURITÉ .....	56
Correcting the picture position automatically .....	29	Précautions concernant la sécurité .....	57
Adjusting the picture position .....	30	Précautions concernant la manipulation .....	59
Adjusting the video size .....	31	Période de remplacement de la lampe .....	60
About dot clock adjustment .....	32	Remplacement du bloc de lampe .....	60

## Before use

These operating instructions are for use with the PT-L797PWU, PT-L797VU and PT-L597U models. (Explanations basically apply to the PT-L797PWU and PT-L797VU models.)

Some of the functions and specifications differ depending on the model. (Refer to the "Specifications" section for details on specification differences.)

The table below shows the differences in functions. Use whichever functions match the projector which you have purchased.

### Function differences

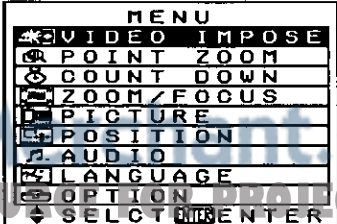
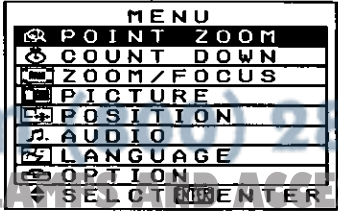
Item	PT-L797PWU / PT-L797VU	PT-L597U
<b>VIDEO IMPOSE</b>	Available	Not available
<b>Difference in on-screen display</b>		
<b>On-screen</b>	Displayed on-screen for the PT-L797PWU / PT-L797VU.	

# IMPORTANT SAFETY NOTICE

**WARNING:** To prevent damage which may result in fire or shock hazard, do not expose this appliance to rain or moisture.

**Power Supply:** This LCD Projector is designed to operate on 100–240 volts, 50/60 Hz AC, house current only.  
**CAUTION:** The AC power cord which is supplied with the projector as an accessory can only be used for power supplies up to 125 V, 10 A. If you need to use higher voltages or currents than this, you will need to obtain a separate 250-V power cord. If you use the accessory cord in such situations, fire may result.



The lightning flash with arrowhead symbol, within an equilateral triangle, is intended to alert the user to the presence of uninsulated “dangerous voltage” within the product’s enclosure that may be of sufficient magnitude to constitute a risk of electric shock to persons.



The exclamation point within an equilateral triangle is intended to alert the user to the presence of important operating and maintenance (servicing) instructions in the literature accompanying the product.

**CAUTION:** This equipment is equipped with a three-pin grounding-type power plug. Do not remove the grounding pin on the power plug. This plug will only fit a grounding-type power outlet. This is a safety feature. If you are unable to insert the plug into the outlet, contact an electrician. Do not defeat the purpose of the grounding plug.

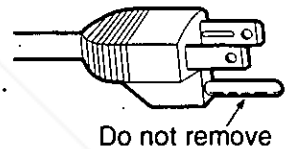

**WARNING:** This equipment has been tested and found to comply with the limits for a Class A digital device, pursuant to Part 15 of the FCC Rules. These limits are designed to provide reasonable protection against harmful interference when the equipment is operated in a commercial environment. This equipment generates, uses, and can radiate radio frequency energy and, if not installed and used in accordance with the instruction manual, may cause harmful interference to radio communications. Operation of this equipment in a residential area is likely to cause harmful interference in which case the user will be required to correct the interference at his own expense.

**CAUTION:** Any unauthorized changes or modifications to this equipment would void the users authority to operate.



**Discount-Merchant.com (800) 281-8860**  
**THE TRUSTED SOURCE FOR PROJECTOR LAMPS AND ACCESSORIES**

# Precautions with regard to safety

## WARNING

### Setting-up

**Do not install this projector in a place which is not strong enough to take the projector's full weight.**

- If the installation location is not strong enough, the projector may fall down, which could cause severe injury and/or damage.

**Ask a qualified technician to carry out installation work such as installing the projector in the ceiling.**

- If installation is not carried out correctly, it can cause injury or electric shocks to occur.

### When using the projector

**Do not place the projector on top of surfaces which are sloped or unstable.**

- The projector may fall down or tip over.

**Do not place any objects on top of the projector.**

- If water spills onto the projector or foreign objects get inside it, a short-circuit may occur which could result in fire or electric shocks. If any foreign objects get inside the projector, please consult an Authorized Service Center.

**Do not cover the air filter and the air outlet.**

- Doing so may cause the projector to overheat, which can cause fire or damage to the projector.

**Do not stick any foreign objects into the projector.**

- Do not insert any metal objects or flammable objects into the ventilation holes or drop them onto the projector, as doing so can cause fire or electric shocks to occur.

**Do not remove the cover or modify it in any way.**

- High voltages which can cause severe electric shocks are present inside the projector. For any inspection, adjustment and repair work, please contact an Authorized Service Center.

**Do not spill water on the projector.**

- This can cause fire or electric shocks to occur.

**Securely insert the power cord plug as far as it will go.**

- If the plug is not fully inserted, heat may be generated which could cause fire. If the plug is damaged or the wall socket plate is loose, they should not be used.

**Do not handle the power cord plug with wet hands.**

- Doing so may cause electric shocks to occur.

**Do not do anything that might damage the power cable.**

- Do not damage the cable, make any modifications to it, place heavy objects on top of it, heat it, place it near any hot objects, twist it, bend it excessively or pull it. To do so may cause fires and electric shocks to occur. If the power cable becomes damaged, have it repaired at an Authorized Service Center.

**Clean the power cable regularly to prevent it from becoming covered in dust.**

- If dust builds up on the power cord plug, the resultant humidity can damage the insulation, which could result in fire. Pull the power cord out from the wall outlet and wipe it with a dry cloth.
- If not using the projector for an extended period of time, pull the power cord plug out from the wall outlet.

### If problems occur during use

**If a problem occurs (such as no picture or no sound), or if smoke or an abnormal odor starts to come out from the projector, immediately pull the power cord plug out from the wall outlet.**

- If you continue to use the projector in this condition, fire or electric shocks could result. After checking that the smoke has stopped coming out, contact an Authorized Service Center so that the necessary repairs can be made. Repairing the projector yourself is extremely dangerous, and it should never be done.

**If water or foreign objects get inside the projector, if the projector is dropped, or if the cabinet becomes damaged, disconnect the power cord plug immediately.**

- A short may occur, which could cause fire. Contact an Authorized Service Center for any repairs that need to be made.

## CAUTION

### When using the projector

**Do not use the projector in places which are subject to humidity, dust, oil fumes or steam.**

- Fire or electric shocks could result.

**Do not place any heavy objects on top of the projector.**

- Doing so can cause the projector to become unbalanced and fall, which could result in damage and/or injury.

**Do not look into the lens while the projector is being used.**

- Strong light is emitted from the projector's lens. If you look directly into this light, it can hurt and damage your eyes.

**Do not bring your hands or other objects close to the air outlet port.**

- Heated air comes out of the air outlet port. Do not bring your hands or face, or objects which cannot withstand heat close to this port, otherwise burns or deformation could result.

**When disconnecting the power cable, hold the plug, not the cable.**

- If the power cable itself is pulled, the cable will become damaged, resulting in the possibility of fire or serious electric shocks.

**Be sure to disconnect all cables before moving the projector.**

- If the projector is moved while some of the cables are still connected, the cables may become damaged, and fire or electrical shocks could result.

### Cleaning and maintenance

**Take particular care when replacing the lamp unit.**

- The lamp contains gas under high pressure. If it is dropped or hit against other objects, it may break, which could cause injury or problems with operation.

**Ask an Authorized Service Center to clean inside the projector at least once a year.**

- If dust is left to build up inside the projector without being cleaned out, it can cause fire or problems with operation to occur. Ask your nearest Authorized Service Center to clean the projector when required. Consult your Authorized Service Center for details regarding cleaning costs.

**Disconnect the power plug from the wall outlet as a safety precaution before carrying out any cleaning.**

- Electric shocks can result if this is not done.



**Discount-Merchant.com (800) 281-8860**  
**THE TRUSTED SOURCE FOR PROJECTOR LAMPS AND ACCESSORIES**

# Precautions on handling

## Cautions regarding setting-up

Observe the following at all times when setting up the projector.

- Avoid setting up in places which are subject to vibration or shocks.  
If the projector is set up in locations with strong vibration, such as near a motor, or if it is installed inside a vehicle or on board a ship, the projector may be subjected to vibration or shocks which can damage the internal parts and cause malfunctions or accidents. Accordingly, set up the projector in a place which is free from such vibrations and shocks.
- Do not set up the projector near high-voltage power lines or near motors.  
The projector may be subject to electromagnetic interference if it is set up near high-voltage power lines or motors.
- Do not set up the projector directly on top of plastic sheet or carpet.  
Plastic sheets can stick to the air filter, which can cause the inside of the projector to overheat and the power supply to switch off.
- If installing the projector to the ceiling, ask a qualified technician to carry out all installation work.  
If the projector is to be suspended from the ceiling, you will need to purchase the separate installation kit (Model No.: ET-PK097). Furthermore, all installation work should only be carried out by a qualified technician.
- Do not install the projector near sources of strong light such as fluorescent lamps.  
If strong light such as light from fluorescent lamps falls onto the remote control signal receptor, it may cause problems with remote control operation. Keep the projector as far away from such light sources as possible.

## Notes on use

- In order to get the best picture quality  
If outside light or light from indoor lamps is shining onto the screen, the images projected will not have good contrast. Draw curtains or blinds over any windows, turn off any fluorescent lights near the screen and cover any highly-reflective floor and wall surfaces with carpet or wallpaper to prevent reflection.
- Do not touch the surfaces of the lens with your bare hands.  
If the surfaces of the lens becomes dirty from fingerprints or anything else, this will be magnified and projected onto the screen. Moreover, when not using the projector, retract the lens and then cover it with the accessory lens cap.
- About the screen  
If the screen you are using is dirty, damaged or discolored, attractive projections cannot be obtained. Do not apply any volatile substances to the screen, and do not let it become dirty or damaged.

### **Before carrying out cleaning and maintenance, be sure to disconnect the power cord plug from the wall outlet.**

#### **Wipe the cabinet with a soft, dry cloth.**

If the cabinet is particularly dirty, soak the cloth in water with a small amount of neutral detergent in it, squeeze the cloth very well, and then wipe the cabinet. After cleaning, wipe the cabinet dry with a dry cloth. If using a chemically-treated cloth, read the instructions supplied with the cloth before use.

#### **Do not wipe the lenses with a cloth that is dusty or which produces lint.**

If any dust or lint gets onto the lenses, such dust or lint will be magnified and projected onto the screen. Use the blower to clean any dust and lint from the lens surfaces, or use a chamois cloth to wipe off any dust or lint.

[FixYourDLP.com](http://FixYourDLP.com)

#### **About condensation**

Droplets of water form on the windows which are warmed suddenly in winter, and on the outside of beer bottles which are taken out of a fridge in summer.

This phenomenon is called condensation; if condensation should occur on the surfaces of the projection lenses or mirror inside the projector, the picture may become fuzzy or it may not be visible at all.

If there is high humidity, or if the projector is suddenly brought from a cold environment into a warm one, the projector will normally stop projecting. In such cases, the projector will normally resume projection as it becomes conditioned to the ambient temperature.

# Location and function of each part

## Remote control unit

### <Front view>

#### LIGHT button (page 12)

This button is used to illuminate the remote control unit buttons.

#### ENTER button

This button is used to accept and to activate items selected in the on-screen menu screens.

#### Arrow (▲, ▼, ◀ and ▶) buttons

These buttons are used to select and adjust items in the on-screen menu screens.

#### MENU button

This button is used to display and clear the MENU screen and to return to a previously-displayed screen.

#### MUTE button (pages 25)

This button is used to momentarily cancel the output of sound from the speakers. The functioning of this button can be changed so that it can be used to cancel both sound and picture simultaneously.

#### POWER button (page 15)

This button is used to turn the projector power supply on and off.

#### FREEZE button (page 24)

This button is used to momentarily freeze projection so that a still picture is displayed.

#### STD (standard) button (pages 24, 33 and 34)

This button is used to return all picture adjustment values to the standard setting values which were made at the time of shipment from the factory.

When the POINT ZOOM function or VIDEO IMPOSE function is being used, this button functions to switch the enlargement ratio or sub-screen's size.

#### VOL +/- buttons (page 24)

These buttons are used to adjust the volume of sound coming from the built-in speakers or to adjust the sound level of the signal being output from the AUDIO OUT terminal.

#### RGB button (page 21)

This button is used to switch the selected input source between RGB 1 and RGB 2.

#### VIDEO button (page 21)

This button is used to switch the selected input source between VIDEO and S-VIDEO.

#### Pointer button (page 43)

When the projector is connected to a personal computer by means of the accessory or optional mouse cable, this button can be used to move the cursor in place of the computer's mouse.

#### CLICK 2 button (page 43)

When the projector is connected to a personal computer by means of the accessory or optional mouse cable, this button operates in the same way as the right button on a standard mouse with two buttons.

### <Side view>

#### Transmitter (page 12)

The remote control signals are transmitted from both the front and the sides. Face this section toward the remote control signal receptor of the projector to operate the projector.

#### Click 1 button (page 43)

This button corresponds to the button on a single-button mouse, or to the left button on a standard mouse with two buttons.

#### Battery compartment cover (page 11)

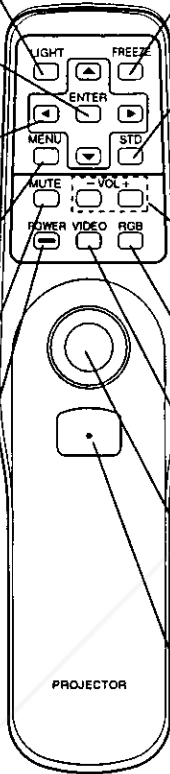

FixYourDLP.com  
Sponsored by  
Discount-Main.com (800) 281-8860  
THE TRUSTED SOURCE FOR PROJECTOR LAMPS AND ACCESSORIES



# Projector

<Top and front>

## Built-in speakers

These are built-in speakers which are capable of outputting stereo sound.

## LENS SHIFT dial (page 17)

Turning this dial moves the lens up and down. Use it to make fine adjustments to the lens position when setting up the projector.

## Focus ring (page 19)

This ring is used to adjust the image focus.

## Air outlet port

## Adjuster button (page 18)

This button is used to unlock the adjustable legs.

## Power indicator (page 15)

This indicator becomes red when the MAIN POWER switch is turned to ON. It changes to green when the power is turned on.

When this indicator is orange, it indicates that the power has been turned off but the cooling fan is still operating (for approximately 60 seconds), or that the power saving function has activated and the light source lamps have been switched off.

## LAMP indicator (page 47)

This indicator illuminates when the useful life of the lamp is coming to an end, and it flashes when there is a problem with the lamp unit.

## Projection lens

This lens enlarges the image and projects it onto the screen.

## Lens cap

## Remote control signal receptor (page 12)

This receives the infrared signal transmissions from the remote control unit.

## TEMP indicator (page 47)

This indicator illuminates or flashes as a warning if the temperature inside the projector reaches an abnormal level.

Discount-Merchant.com (800) 281-8860  
THE TRUSTED SOURCE FOR PROJECTOR LAMPS AND ACCESSORIES

## <Control panel>

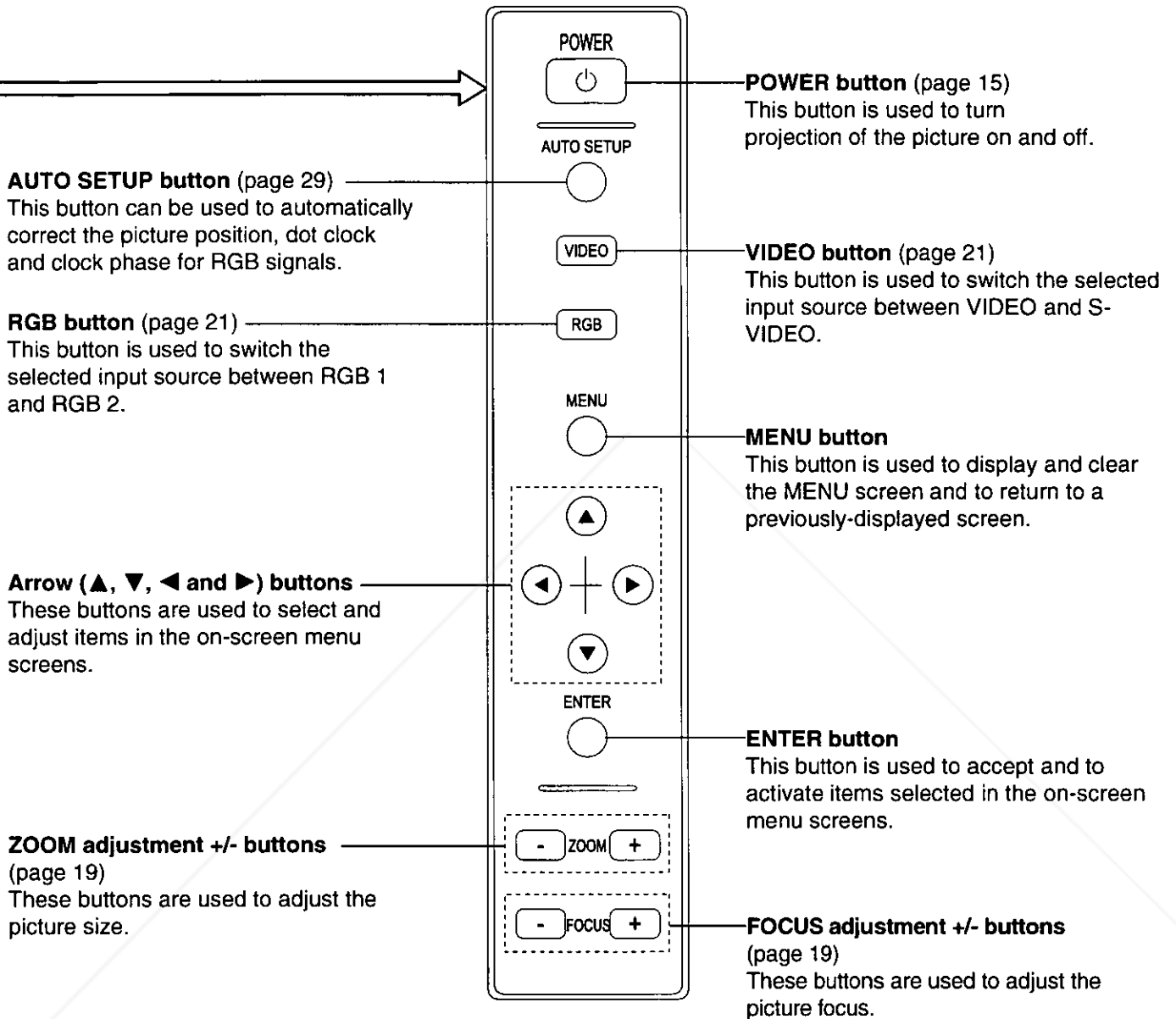

<Back and side>

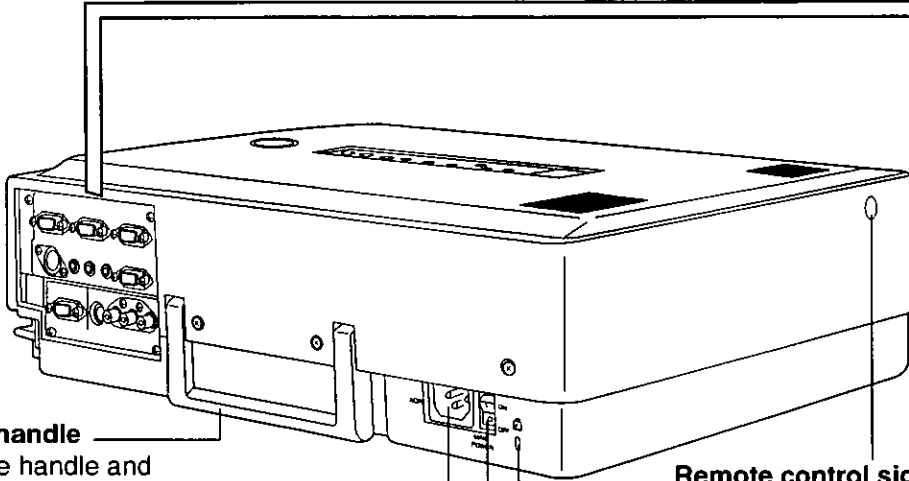

**Carrying handle**  
Pull out the handle and hold it when transporting the projector.

**Power input socket (AC IN)**  
The power cord which is supplied with the projector is connected here.

**MAIN POWER switch**  
(page 15)  
This switch turns the power supply to the projector on and off.

**Remote control signal receptor** (page 12)  
This receives the infrared signal transmissions from the remote control unit.

**SECURITY LOCK**  
This can be used to connect a commercially-available theft-prevention cable (manufactured by Kensington). This security lock is compatible with the Microsaver Security System from Kensington. Contact details for this company are given below.

Kensington Technology Group  
ACCO Brands, Inc.  
2855 Campus Drive  
San Mateo, CA 94403  
650.572.2700  
Fax 650.572.9675  
www.kensington.com  
www.gravis.com

<Bottom>

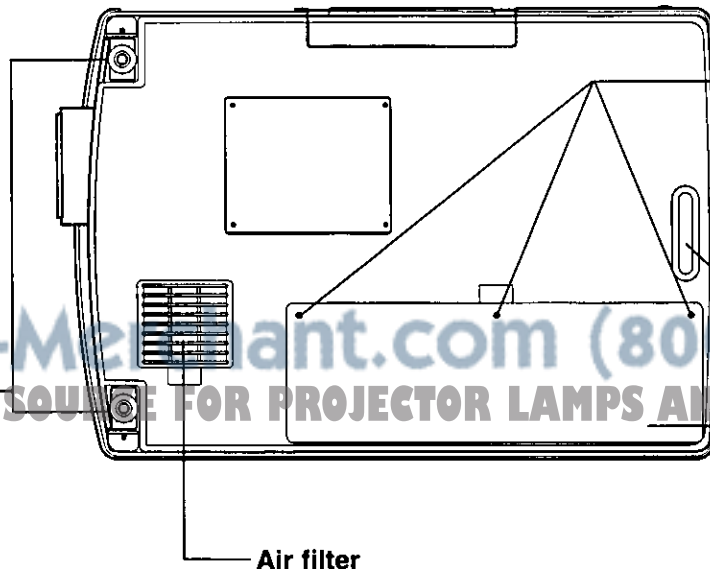

**Adjustable legs (two)**  
(page 18)  
These legs can be used to adjust the angle of inclination of the projector.

**Attachment screws for the lamp unit cover**  
(page 50)  
Remove these screws when replacing the lamp unit.

**Fixed leg**  
**Lamp unit cover**  
(page 50)  
Remove this cover to get access to the lamp unit.

**Air filter**



Discount-Mechant.com (800) 281-8860  
TRUSTED SOURCE FOR PROJECTOR LAMPS AND ACCESSORIES

**AUDIO OUT terminal** (pages 41 and 42)  
 This terminal is used to output the audio signals from the source which is connected to the AUDIO IN terminals for RGB or video signals. The signal which is output corresponds to the source which has been selected by pressing either the VIDEO or RGB button. The output level for this signal can be adjusted by using the VOL +/- buttons. If audio equipment is connected to this terminal, no sound will be output from the built-in speakers.

**RGB2 / YPbPr IN Connector and associated AUDIO IN jack** (page 42)  
 This connector is used to input a YPbPr or an RGB signal. A corresponding audio signal can be input to the AUDIO IN jack below it.

**RGB1 IN Connector and associated AUDIO IN jack** (page 42)  
 This connector and terminal are used to input RGB signals and the audio signals which accompany them.

**RGB OUT connector** (page 42)  
 This connector is used to output the RGB signals from the source which is connected to the RGB 1 or RGB 2 connector. The signal which is output corresponds to the source which has been selected by pressing the RGB button.

**<Side terminal board>**

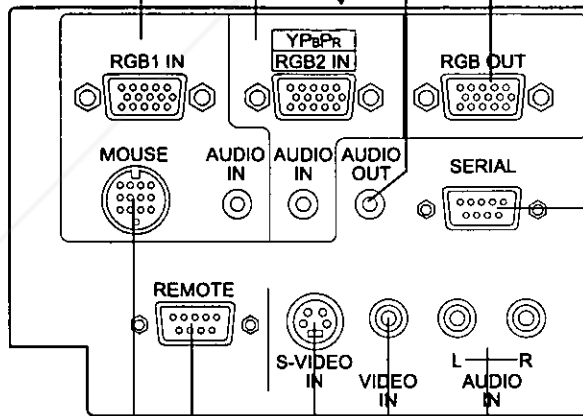

**SERIAL connector** (page 44)  
 This connector is used to connect a personal computer to the projector in order to externally control the projector.

**MOUSE connector** (pages 42 and 43)  
 This connector is used to connect an accessory or separate mouse cable. This lets you operate a personal computer using the pointer button and click buttons on the remote control unit instead of using a mouse.

**REMOTE connector** (page 46)  
 This connector lets you use an external control circuit to operate the projector by remote control.

**AUDIO IN (L-R) terminals for S-VIDEO/VIDEO input** (page 41)  
 These terminals are used to input audio signals which correspond to the signals input to the VIDEO IN or S-VIDEO IN terminal.

**VIDEO IN terminal** (page 41)  
 This terminal is used to input composite video signals.

**S-VIDEO IN terminal** (page 41)  
 This terminal is used to input S-VIDEO signals.



# Before using the remote control unit

## Inserting the batteries

Insert the AA batteries supplied with the remote control unit making sure that the polarities are correct.

### Open the battery compartment cover.

Push the section with the ▽ mark down firmly, and then pull the cover toward you to remove it.

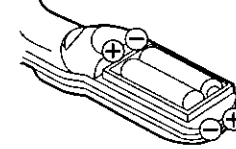
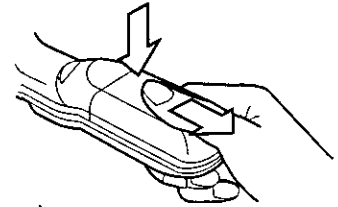

### Insert the batteries.

Insert the batteries so that their direction matches the polarity markings inside the compartment.

#### NOTE:

- Do not use rechargeable (Ni-Cd) batteries.

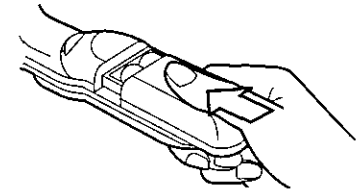

### Close the battery compartment cover.

Return the battery compartment cover to its original position.

## Notes on using the batteries

The following should be observed in order to prevent damage to or leaking of the batteries.

### Old Batteries

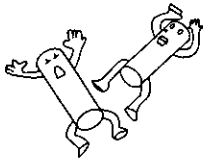

### New Batteries



Replace both batteries at the same time. Furthermore, do not burn spent batteries or put them in with combustible garbage.

Do not mix old and new batteries or batteries of different types (such as alkali and manganese batteries).

## DO NOT do any of the following:

NG

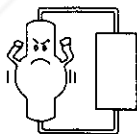

Do not recharge

NG

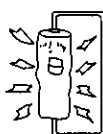

Do not short-circuit

NG

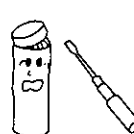

Do not open

NG



Do not heat or burn

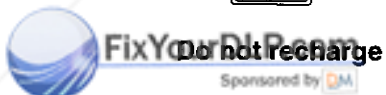

**Discount-Merchant.com (800) 281-8860**  
**THE TRUSTED SOURCE FOR PROJECTOR LAMPS AND ACCESSORIES**

## Operating range of the remote control unit

Point the remote control unit toward the remote control signal receptor on the front or the rear of the projector to operate the projector. Refer to the illustration below for the operating range of the remote control unit.

<Top view>

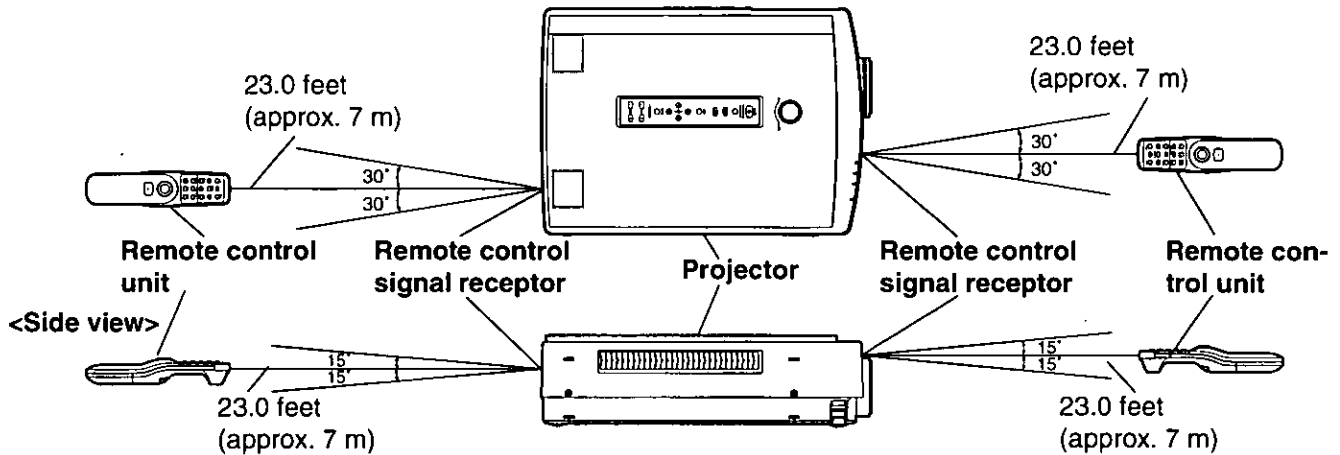

### NOTE:

- The operating distance is within 23.0 feet (approximately 7 meters) from directly in front of the front or rear remote control signal receptors. Furthermore, if using the rear 60° (left and right) function to transmit the remote control signals, the operating distance is also 23.0 feet (7 meters).
- If strong light is allowed to shine onto the remote control signal receptor, or if there are any obstacles between the remote control signal receptor and the remote control unit, correct remote control operation may not be possible.

## If facing the remote control unit toward the screen

The projector can also be operated by pointing the remote control unit toward the screen as shown in the illustration below.

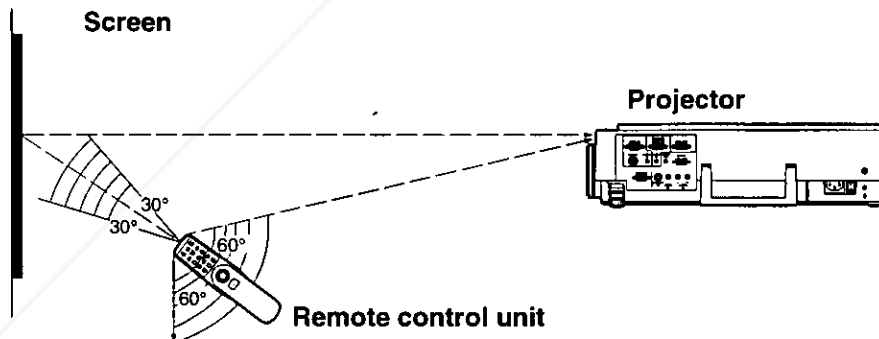

### NOTE:

- If facing the remote control unit toward the screen to operate the projector, the operating range of the remote control unit will be limited by the amount of light reflection loss caused by the characteristics of the screen used.
- The transmit function of the remote control unit can transmit within a range of 60° in the forward direction and 60° in the backward direction (60° on both left and right sides), assuming a method of use such as that shown above.

## Illuminating the remote control unit buttons

When the LIGHT button on the remote control unit is pressed, the buttons on the remote control unit are illuminated for approximately 10 seconds.



LIGHT button

### NOTE:

- If the LIGHT button is pressed once more while the remote control unit buttons are illuminated, the illumination period will be extended for a further 10 seconds.
- If any other buttons are pressed while the buttons are illuminated, the illumination will switch off, and will switch back on again for a further 10 seconds once the button which was pressed is then released.

# Menu operation guide

This section explains how to reach the desired selection or setting screens from the MENU screen. Refer to the page indicated for further details on each screen item.

- (1) Press the MENU button.
- (2) Use the arrow (▲, ▼, ◀ and ▶) buttons to select an item, and then press the ENTER button.

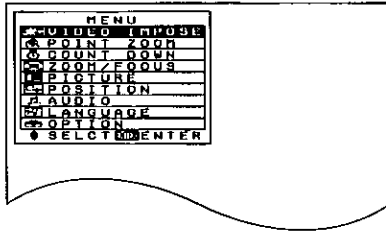

**VIDEO IMPOSE**  
[PT-L797 series only]  
(Refer to page 33.)  
Used to display a video signal image in a sub-screen on an RGB image.

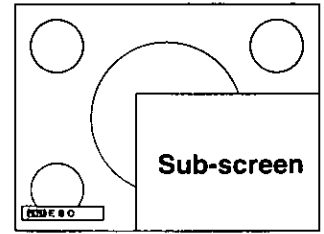

**POINT ZOOM**  
(Refer to page 34.)  
Used to enlarge and project a specific section of the input picture image.

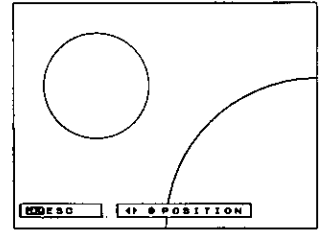

**COUNT DOWN**  
(Refer to page 36.)  
Used to set and activate the countdown timer.

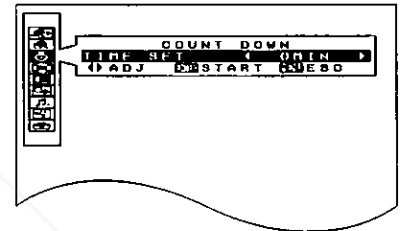

**ZOOM/FOCUS**  
(Refer to page 19.)  
Used to adjust the picture size and focus.

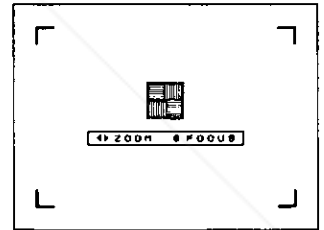

When an RGB/YPbPr signal is being projected

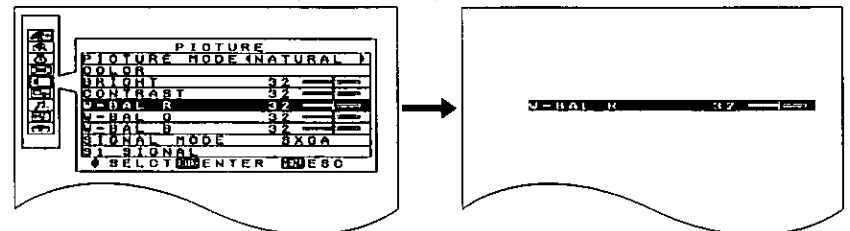

**PICTURE** (Refer to pages 23, 25-27.)  
Used to carry out picture adjustments and to switch the signal format.

When a VIDEO/S-VIDEO signal is being projected

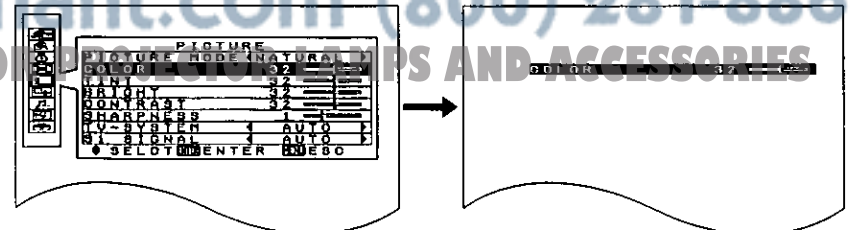

(1) Press the MENU button.

(2) Use the arrow (▲, ▼, ◀ and ▶) buttons to select an item, and then press the ENTER button.

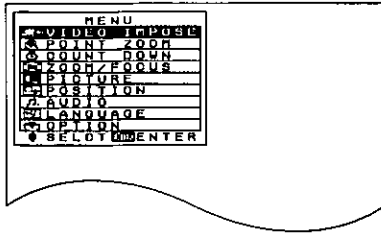

**POSITION**  
(Refer to pages 29-33.)  
Used to adjust the horizontal and vertical position of the picture and to adjust other properties such as the size.

When an RGB/YPbPr signal is being projected

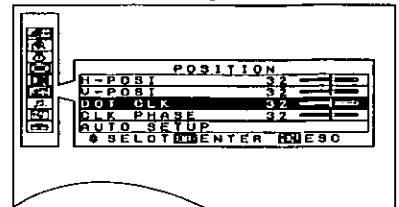

When a VIDEO/S-VIDEO signal is being projected

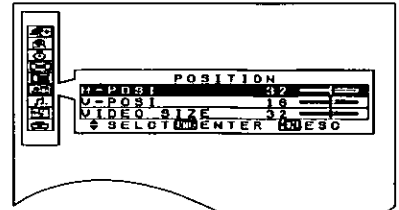

**AUDIO**  
(Refer to page 28.)  
Used to adjust the volume and left/right balance for the sound being output from the built-in speakers.

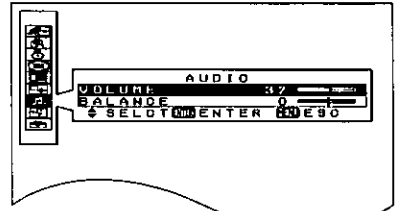

**LANGUAGE**  
(Refer to page 36.)  
Used to switch the on-screen display language.

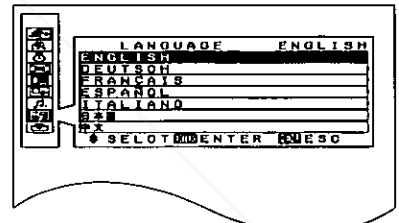

**OPTION**  
(Refer to pages 20, 33, 35, 37, 38, 39 and 51.)  
Used for detailed setting of useful functions.

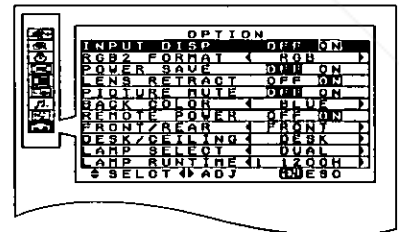

### White character display of on-screen items

This projector has unadjustable items and unusable functions depending on the signal being input. When an item cannot be adjusted or a function cannot be used, the corresponding on-screen menu display appears in white characters, and the item or function will not work even if the ENTER button is pressed.

#### Display example:

When the sound has been muted using the MUTE button on the remote control unit, the AUDIO item will be displayed in white characters.

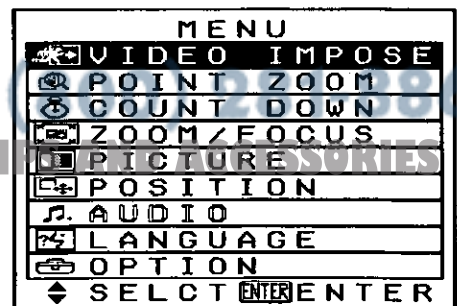



# Turning the power on and off

If the MAIN POWER switch on the projector is pressed while the cooling fan is still operating, the operating life of the projector lamp will be shortened. Be sure to follow the procedures given below when turning the projector power supply on and off.

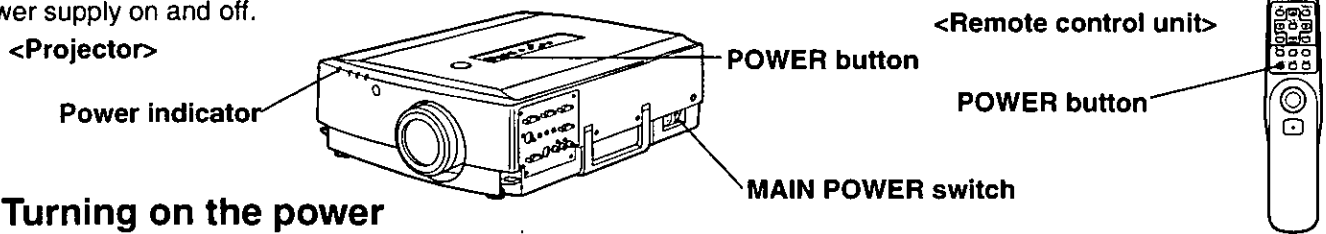

## □ Turning on the power

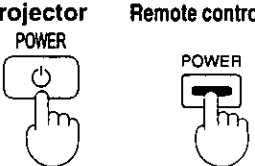
<p><b>1. Press the MAIN POWER switch.</b></p> 	<p><b>Press the MAIN POWER switch on the projector to the ON position.</b></p> <p style="text-align: center;">↓</p> <p>The power indicator will illuminate red and the projector will switch to standby mode.</p>
<p><b>2. Press the POWER button.</b></p> 	<p><b>Press the POWER button on either the top of the projector or on the remote control unit.</b></p> <p>The power indicator will alternate between green and orange. ↓</p> <p>The power indicator will illuminate green and a picture will be projected onto the screen after about 20 seconds.</p>

## □ Turning off the power

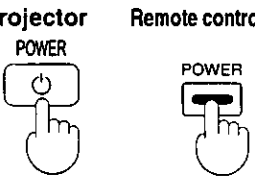
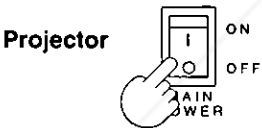
<p><b>1. Press the POWER button.</b></p> 	<p><b>Press the POWER button on either the top of the projector or on the remote control unit.</b></p> <p style="text-align: center;">↓</p> <p>The power indicator will illuminate orange and the projector will switch to standby mode.</p>
<p><b>2. Wait for the cooling fan to stop.</b></p>	<p><b>Wait for a while (approximately 60 seconds) until the cooling fan stops operating. (When the fan stops, the power indicator will illuminate red.)</b></p>
<p><b>3. Press the MAIN POWER switch.</b></p> 	<p><b>Press the MAIN POWER switch on the projector to the OFF position.</b></p> <p style="text-align: center;">↓</p> <p>The power indicator will switch off and the power supply will be turned off.</p>

### NOTE:

- If the power is turned off using the POWER button, the cooling fan will continue to operate (for approximately 60 seconds) while the inside of the projector is still at a high temperature. Do not turn the MAIN POWER switch to the OFF position, disconnect the power cord plug from the wall socket or shut off the mains power supply until the cooling fan stops operating.
- If not using the projector for long periods of time, turn the MAIN POWER switch at the front of the projector to the OFF position.
- If the power is accidentally turned off while the projector is being used, wait a while for the lamps to cool down before turning the power back on again. If you turn the power back on immediately, the lamps will not illuminate again until an interval of approximately 40 seconds has passed.
- The REMOTE POWER function may cause the operation of the POWER button on the remote control unit to be disabled temporarily. For details about this function, refer to page 35.
- If the MAIN POWER switch has not been turned off, the projector will still draw Max. 10W of power, even when the POWER button has been turned off and the fan has stopped.
- There may be cases where the lamp does not turn on straight away. In such cases, the projector will try to turn the lamp on again after 60 seconds have passed. (During this time, the power indicator will alternately flash green and orange.)
- The projector is equipped with a lens retracting function which will cause the lens to be retracted automatically when the power is turned off. However, the lens will not then return to the previously adjusted position even if the power is turned back on again. If you do not wish this function to operate, turn the function setting off while referring to "Using the lens retracting function" on page 37.
- A tinkling sound may be heard while the power indicator is turned off, but this is not a sign of a malfunction.

# Standard setting-up positions

After determining the appropriate position for the projector by referring to the illustrations and standard setting-up dimensions given below, set up the projector. The distance **L** from the projector to the screen and the height **H** do not vary, regardless of whether the projector is being used in the floor, ceiling, front or rear positions.

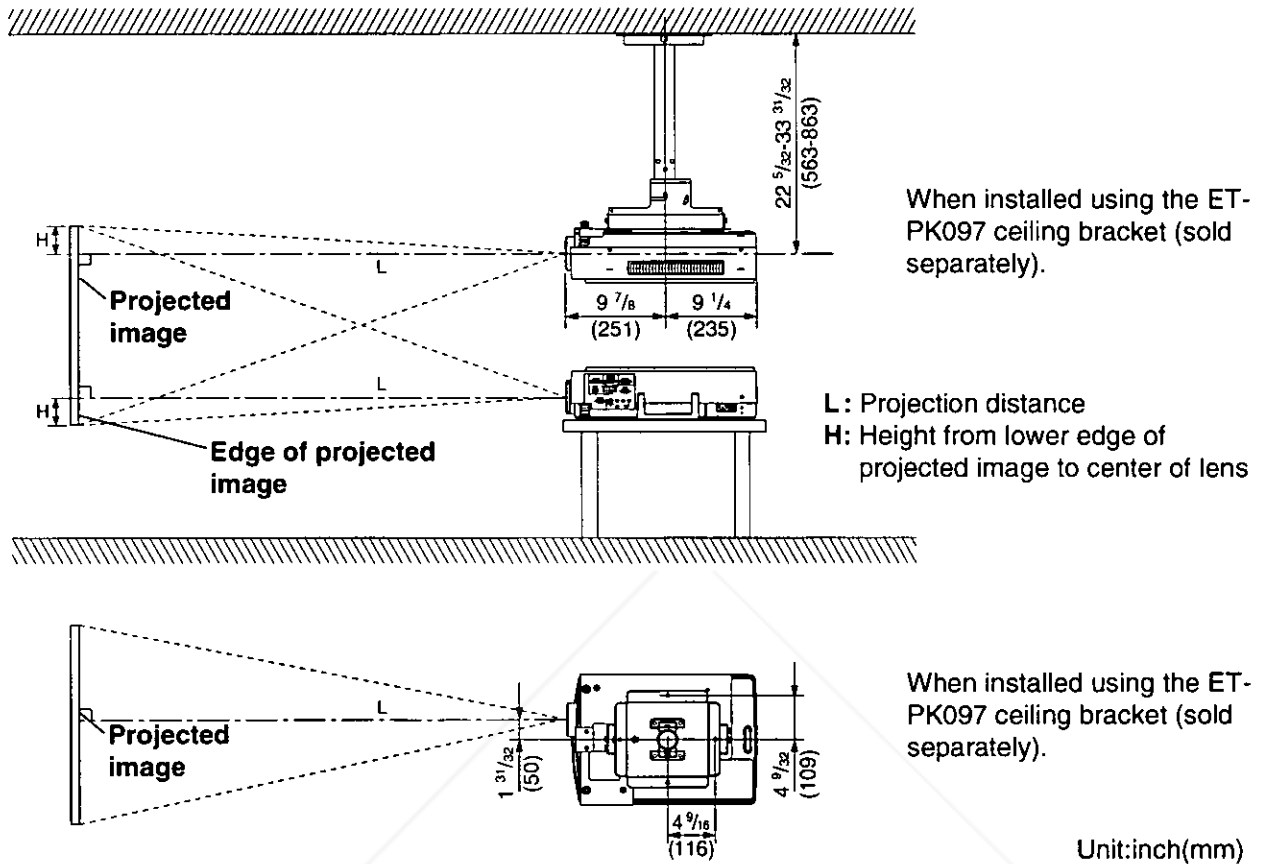

## Standard setting-up dimensions

Because the projector uses a electronic zoom lens, it is possible to adjust the projection distance. And because there is also a function provided for adjusting the height of the lens, the height of the projector can also be adjusted relative to the position of the screen. For details, refer to pages 17 and 18.

Projection size	Projection distance (L)		Height from edge of projected image to center of lens (H)
	PT-L797PWU	PT-L797VU/PT-L597U	
30	4'4"-5'2"(1.3-1.6 m)	4'4"-5'2"(1.3-1.6 m)	0-9"(0-0.22 m)
40	5'11"-7'2"(1.8-2.2 m)	5'11"-6'10"(1.8-2.1 m)	0-1'(0-0.30 m)
50	7'7"-8'10"(2.3-2.7 m)	7'3"-8'10"(2.2-2.7 m)	0-1'3"(0-0.38 m)
60	8'11"-10'9"(2.7-3.3 m)	8'11"-10'9"(2.7-3.3 m)	0-1'6"(0-0.45 m)
70	10'6"-12'9"(3.2-3.9 m)	10'3"-12'9"(3.1-3.9 m)	0-1'9"(0-0.53 m)
80	11'10"-14'5"(3.6-4.4 m)	12'2"-14'5"(3.7-4.4 m)	0-2'(0-0.60 m)
90	13'6"-16'4"(4.1-5.0 m)	13'2"-16'4"(4.0-5.0 m)	0-2'3"(0-0.68 m)
100	14'10"-18'4"(4.5-5.6 m)	14'10"-18'4"(4.5-5.6 m)	0-2'6"(0-0.76 m)
120	17'9"-22'(5.4-6.7m)	17'9"-22'(5.4-6.7m)	0-3'(0-0.92 m)
150	22'4"-27'6"(6.8-8.4 m)	22'4"-27'10"(6.8-8.5 m)	0-3'9"(0-1.14 m)
200	29'11"-37'(9.1-11.3 m)	29'7"-37'(9.0-11.3 m)	0-5'(0-1.52 m)
250	37'5"-46'3"(11.4-14.1 m)	37'1"-46'7"(11.3-14.2 m)	0-6'3"(0-1.90 m)
300	44'8"-55'9"(13.6-17.0 m)	44'8"-56'1"(13.6-17.1 m)	0-7'6"(0-2.28 m)

### NOTE:

- In addition, if the projector is not completely vertical with respect to the screen and horizontal with respect to the floor, distortion of the projected image will result. Adjust the projector horizon by the procedure given on page 18.
- The values in the table shown above are approximate.

## □ Adjusting the position of the projected picture

The vertical position of the projected picture can be adjusted by changing the height of the projection lens using the LENS SHIFT dial which is on top of the projector.

After determining the projection distance and the setting-up position, adjust the vertical position of the projected picture by carrying out the following procedure.

Press the LENS SHIFT dial on top of the projector. ....The dial will pop up and it will be possible to turn it to make adjustments.

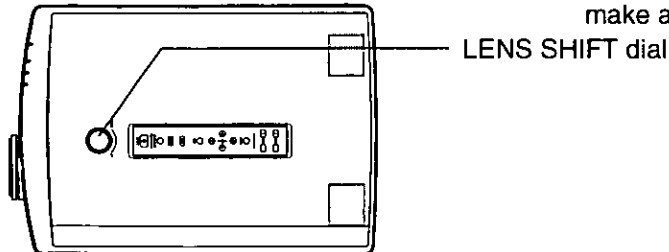

If the LENS SHIFT dial is turned clockwise, the position of the projected image will be raised.

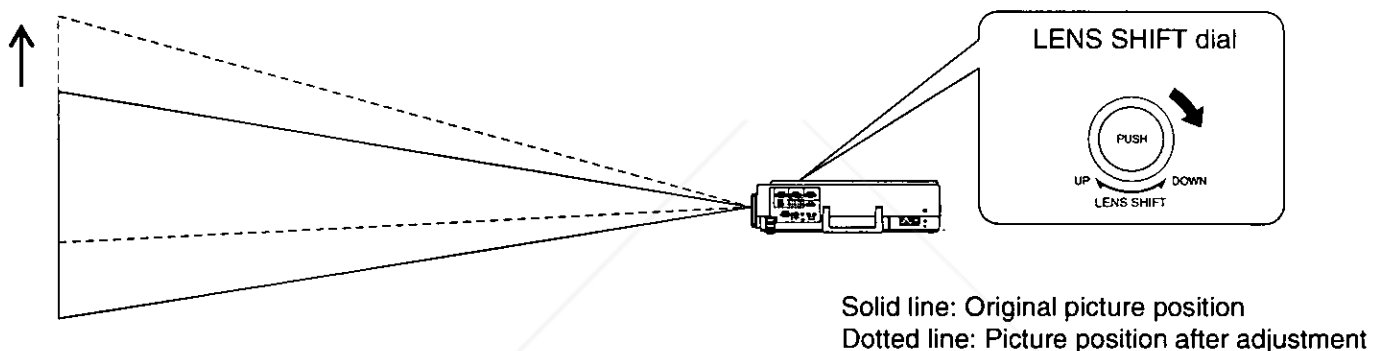

If the LENS SHIFT dial is turned counterclockwise, the position of the projected image will be lowered.

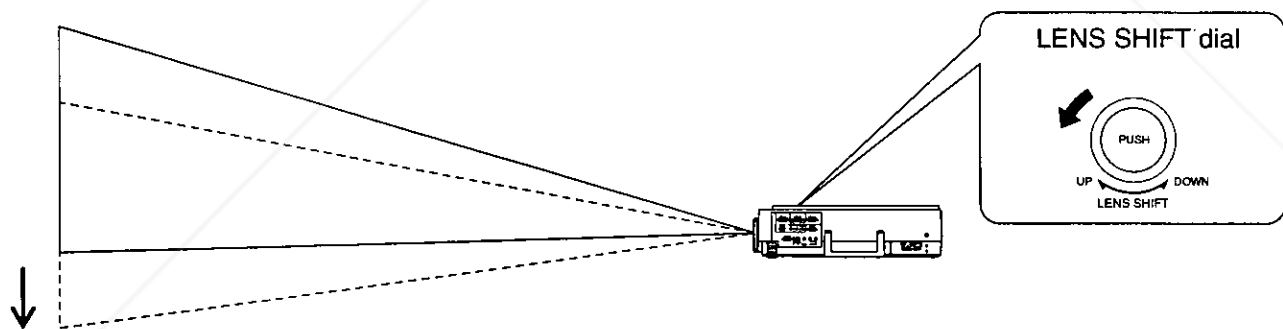

Press the LENS SHIFT dial on top of the projector. ....The dial will pop back in again and adjustment will no longer be possible.



**Discount-Merchant.com (800) 281-8860**  
**THE TRUSTED SOURCE FOR PROJECTOR LAMPS AND ACCESSORIES**

## □ Setting the projector up horizontally

If the projector is not set up so that it is horizontal, it will not be possible to obtain a distortion-free picture. If placing the projector on top of a table or similar surface, carry out the following procedure below to ensure that no distortion of the picture occurs.

### Adjustment procedure

1. Lift the front of the projector until the projector as a whole is horizontal. While holding it in this position, press the adjuster buttons under the sides of the projector (1 each at left and right). When the buttons are pressed, the left and right adjustable legs will drop down until they reach the setting-up surface.

**NOTE:**

- Do not release the buttons until both legs have reached the setting-up surface.

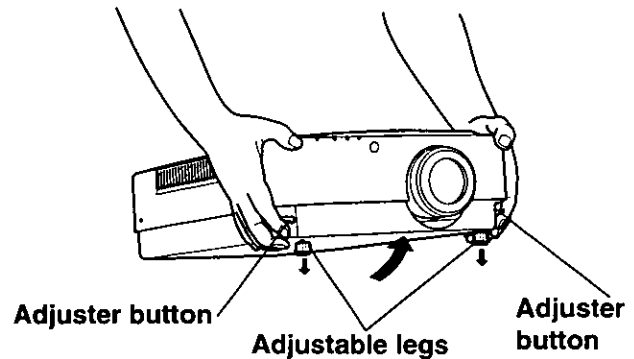

2. Release the adjuster buttons. (The adjustable legs will lock as soon as the buttons are released.)

3. Turn the adjustable legs by hand in either direction to make fine adjustments to the level of the projector so that the projector is perfectly horizontal.

**NOTE:**

- The legs can be extended by up to 2<sup>3</sup>/<sub>8</sub>" (60 mm). If you try to extend them any further than this, they will merely spin freely.

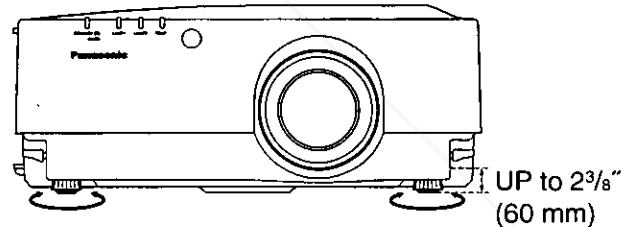

## <Retracting the adjustable legs>

After lifting the front of the projector slightly, press and hold the adjuster buttons and then gently lower the projector.

**NOTE:**

- Be sure to support the projector firmly while pressing the adjuster buttons. If the adjuster buttons are pressed without supporting the projector, the adjustable legs will suddenly unlock and the projector will fall down, which could damage the projector.

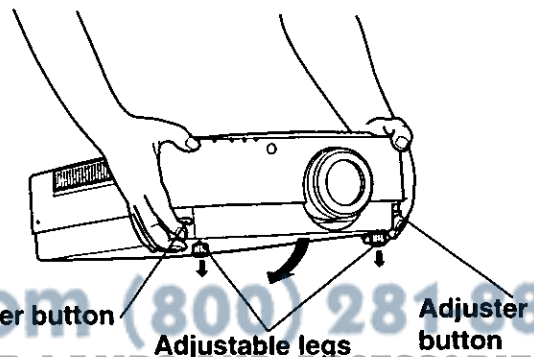

# Adjusting the lens

This projection lens used in this projector is equipped with electronic zoom and electronic focus. These settings can be adjusted directly using the ZOOM button and the FOCUS button on the projector operating panel, or they can be adjusted by selecting "ZOOM/FOCUS" from the on-screen menu screen. In addition, focussing can be carried out manually by turning the focus ring on the projection lens.

## NOTE:

- If direct adjustment is carried out while some other on-screen display is on the screen, the adjustment screen will not be displayed but the adjustment operation will still work.
- The projector is equipped with a function which retracts the lens when the projector power supply is turned off. However, the lens will not return to the previously-adjusted position when the power is turned back on again. Refer to page 37 for details on turning this function on and off.

## Adjustment procedure <for direct adjustment>

1. Press the FOCUS +/- buttons on the projector operating panel to adjust the focus.
  - Stop pressing the buttons when the picture image on the screen comes into the sharpest focus.

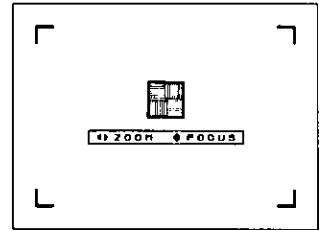

2. Press the ZOOM +/- buttons on the projector operating panel to adjust the picture size. If "+" button is pressed ... the picture size becomes larger. If "-" button is pressed ... the picture size becomes smaller. Once the screen size reaches the maximum or minimum size, display arrows appear in red in the four corners of the picture image.
3. Press the FOCUS +/- buttons to make fine adjustments to the focus.

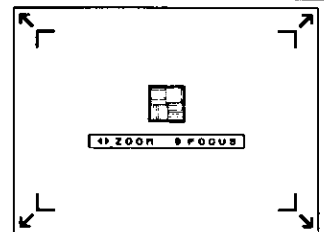

## NOTE:

- If approximately five seconds pass without any buttons being pressed, the adjustment screen will be cleared.

## Adjustment procedure <for on-screen display operation>

1. Press the MENU button. ... The MENU screen will be displayed.
2. Use the "▲" and "▼" arrow buttons to move the cursor to "ZOOM/FOCUS".

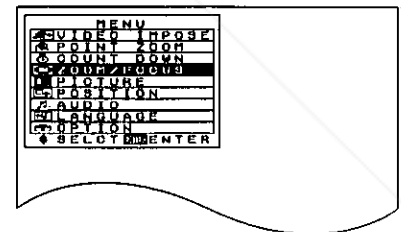

3. Press the ENTER button. ... The ZOOM/FOCUS individual adjustment screen will be displayed.
4. Use the "▲" and "▼" arrow buttons to adjust the focus.
5. Use the "◀" and "▶" arrow buttons to adjust the screen size. If "▶" button is pressed ... the picture size becomes larger. If "◀" button is pressed ... the picture size becomes smaller. Once the screen size reaches the maximum or minimum size, display arrows appear in red in the four corners of the picture image.
6. Use the "▲" and "▼" arrow buttons to make fine adjustments to the focus.

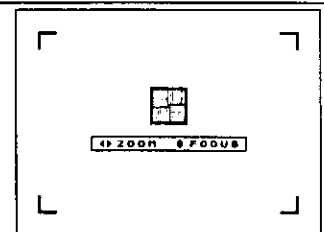

## NOTE:

- If no button is pressed for approximately 5 seconds while an individual adjustment screen is being displayed, the display will return to the MENU screen.
- If the MENU button is pressed, the display will return to the MENU screen, or the MENU screen will be cleared if it is already being displayed.

# Setting the projection method

You can set the projection method for this projector in accordance with the way the projector is set up. If the screen display is upside-down or back-to-front, change the projection method by following the procedure given below. The factory default settings are FRONT for FRONT/REAR and DESK for DESK/CEILING.

## Setting procedure (when changing to REAR/CEILING)

1. Press the MENU button. ... The MENU screen will be displayed.
2. Press the "▲" or "▼" button to move the cursor to "OPTION".

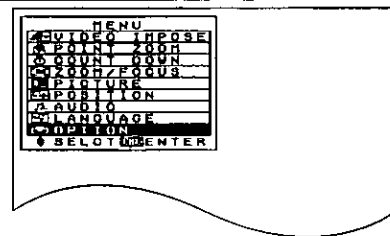

3. Press the ENTER button. ... The OPTION screen will be displayed.
4. Press the "▲" or "▼" button to move the cursor to "FRONT/REAR".
5. Press the "◀" and "▶" buttons to select "REAR".
  - The selection will change between "FRONT" and "REAR" each time one of the "◀" or "▶" buttons is pressed.

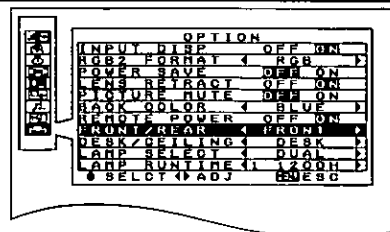

6. Press the "▲" or "▼" button to move the cursor to "DESK/CEILING".
7. Press the "◀" or "▶" button to select "CEILING".
  - The selection will change between "DESK" and "CEILING" each time one of the "◀" or "▶" buttons is pressed.

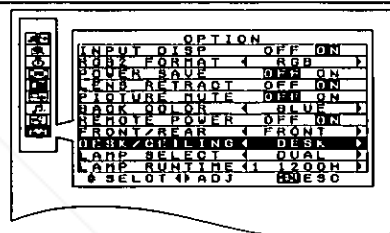

		DESK/CEILING	
		DESK	CEILING
FRONT/ REAR	FRONT	<p>(Factory default setting)</p>	
	REAR		

**THE TRUSTED SOURCE FOR PROJECTOR LAMPS AND ACCESSORIES**

### NOTE:

- If the MENU button is pressed, the display will return to the MENU screen, or the MENU screen will be cleared if it is already being displayed.

# Basic operation

## □ Changing the input signal

The input source for picture signals and the corresponding audio signals can be changed by pressing the VIDEO or RGB buttons on the projector operating panel or on the remote control unit. In addition, the name of the input source selected will be displayed on the screen for approximately 5 seconds.

### Press the VIDEO button

(The source switches between VIDEO and S-VIDEO each time the button is pressed.)

The projector is shipped from the factory with the system format (NTSC, PAL, etc) selection function set to "AUTO", so that the system format is selected automatically when VIDEO/S-VIDEO signals are being input.

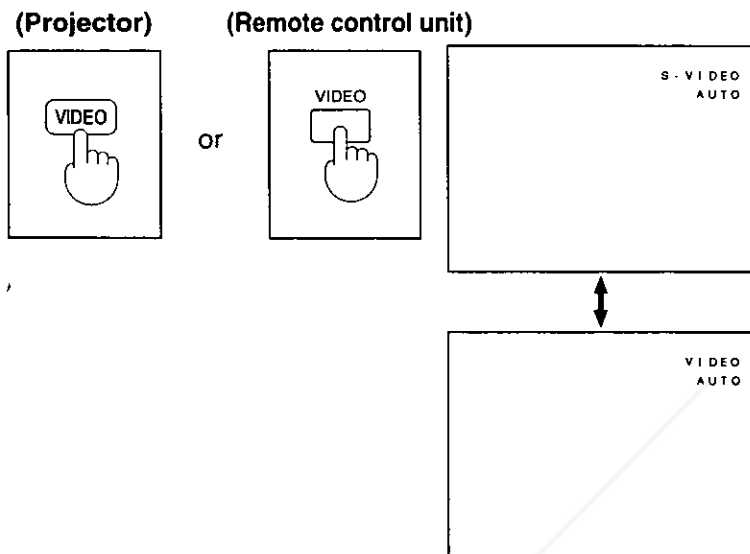

The signal from the source which is connected to the S-VIDEO IN connector is projected.

A function has been provided for switching automatically to 16:9 when S1 video signals are input. Refer to page 40 for details.

The signal from the source which is connected to the VIDEO IN connector is projected.

A function has been provided for manually switching the projected image to 16:9. Refer to page 40 for details.

### Press the RGB button

(The source switches between RGB 1 and RGB 2 each time the button is pressed.)

When RGB signals are being input, the projection mode will be matched automatically to one of the modes which have been pre-set inside the projector.

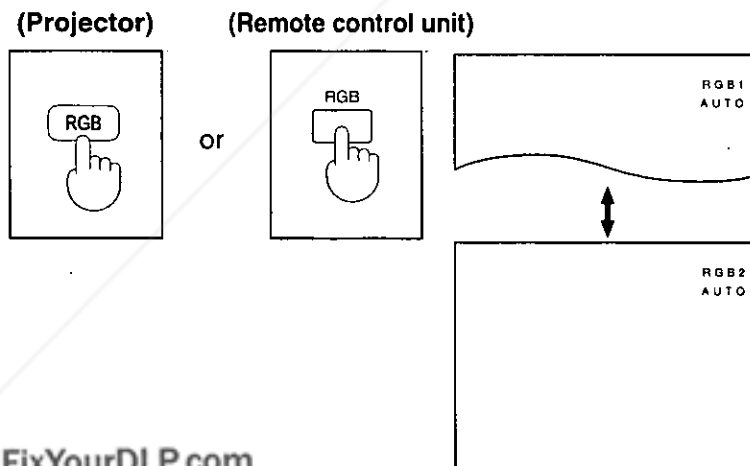

The signal from the source which is connected to the RGB 1 IN connector is projected.

The signal from the source which is connected to the RGB 2 IN connector is projected.

A function has been provided for switching between RGB input and YPbPr input. Refer to page 33 for details.

A function has been provided for manually switching the projected image to 16:9. Refer to page 40 for details.



Discount-Merchant.com (800) 281-8860

#### NOTE:

- There is only one audio system circuit provided for the AUDIO IN L-R terminals for S-VIDEO and VIDEO signals. Because of this, if using both S-VIDEO signals and VIDEO signals, it will be necessary to change over the connectors.
- Refer to page 22 for a list of the different types of RGB signal which can be input, and to page 23 for details on the format selection when VIDEO/S-VIDEO signals are being input.
- When RGB 1 or RGB 2 has been selected, the signal selected will be output from the RGB OUT connector.

## <RGB signals that can be input>

The table below lists the different types of RGB signals that can be input.

If a signal which differs greatly from any of the types listed below is input, the picture image may not be displayed correctly, or a blue background (or black background) may be displayed.

Display mode name	Signal data			Remedy
	No. of dots	Horizontal scanning frequency(kHz)	Vertical scanning frequency(Hz)	
VGA400	640 × 400	24.8	56.4	
	640 × 400	31.5	70.1	
VGA480	640 × 480	31.5	59.9	
	640 × 480	35.0	66.7	
	640 × 480	37.9	72.8	
	640 × 480	37.5	75.0	
	640 × 480	43.3	85.0	
SVGA	800 × 600	32.1	51.0	
	800 × 600	35.2	56.3	
	800 × 600	37.9	60.3	
	800 × 600	48.1	72.1	
	800 × 600	46.9	75.0	
	800 × 600	53.7	85.1	
XGA	1024 × 768	48.4	60.0	
	1024 × 768	56.5	70.1	
	1024 × 768	60.0	75.0	
	1024 × 768	65.5	81.6	
	1024 × 768	68.7	85.0	
	1024 × 768 i	35.5	86.8	
	1024 × 768	80.7	100.8	
MXGA	1024 × 768	94.0	120.0	PT-L797 series only
	1152 × 864	63.9	70.0	
	1152 × 864	67.5	75.0	
	1152 × 864	77.1	85.0	PT-L797 series only
	1120 × 750	50.1	60.1	
SXGA	1120 × 750 i	32.6	80.0	
	1280 × 1024	52.4	50.0	
	1280 × 1024	64.0	60.0	
	1280 × 1024	72.4	66.3	
	1280 × 1024	78.2	71.7	
	1280 × 1024	80.0	75.0	PT-L797 series only
	1280 × 1024 i	46.2	86.0	
1280 × 1024 i	47.6	88.9		
MAC16	832 × 624	49.7	74.6	
MAC21	1152 × 870	68.6	75.0	
HDTV	1920 × 1035 i	33.8	60.0	
720p	1280 × 720	45.0	60.0	
NTSC	720 × 480 i	15.7	59.9	
PAL	720 × 576 i	15.6	50.0	
480p	720 × 483	31.5	59.9	

FixYourDLP.com

OTE:

Sponsored by DM

- The display resolution of PT-L797 series is 1,024 × 768 dots. If the display resolution indicated in the above data does not match this resolution, the resolution will be converted to 1,024 × 768 dots.
- The display resolution of PT-L597 series is 800 × 600 dots. If the display resolution indicated in the above data does not match this resolution, the resolution will be converted to 800 × 600 dots.
- Display resolutions followed by a "i" indicate interlaced signals.



## <Checking the display mode for RGB signals>

Use the following procedure to check the display mode for the RGB signals which are currently being input.

### Operating procedure

1. Press the MENU button. ... The MENU screen will be displayed.
2. Use the “▲” and “▼” arrow buttons to move the cursor to “PICTURE”.

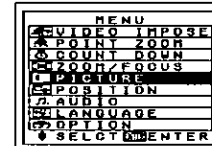

3. Press the ENTER button. ... The PICTURE screen will be displayed.
  - The display mode for the RGB signals which are currently being input will appear in the “SIGNAL MODE” item.

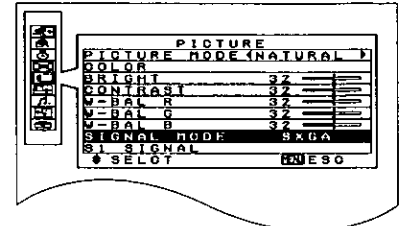

### NOTE:

- If the MENU button is pressed, the display will return to the MENU screen, or the MENU screen will be cleared if it is already being displayed.

## <VIDEO/S-VIDEO signal format selection>

If the correct signal format is not selected and the picture does not appear as normal when VIDEO or S-VIDEO signals are being input, select the format by the following procedure. This function is set to “AUTO” at the time of shipment from the factory, so that the projector can normally be used with this setting left as it is.

### Operating procedure

1. Press the MENU button. ... The MENU screen will be displayed.
2. Use the “▲” and “▼” arrow buttons to move the cursor to “PICTURE”.

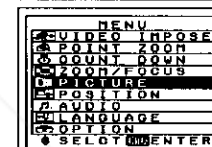

3. Press the ENTER button. ... The PICTURE screen will be displayed.
4. Use the “▲” and “▼” arrow buttons to move the cursor to “TV-SYSTEM”.
5. Use the “◀” and “▶” arrow buttons to switch the setting to “AUTO”, “NTSC”, “NTSC4.43”, “PAL”, “PAL-M”, “PAL-N” or “SECAM” until a normal picture is obtained.

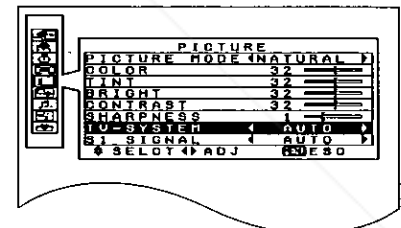

	Horizontal scanning frequency [kHz]	Vertical scanning frequency [Hz]	Color subcarrier frequency [MHz]
<b>AUTO</b>	“NTSC”, “NTSC4.43”, “PAL”, “PAL-M”, “PAL-N” or “SECAM” is selected automatically.		
<b>NTSC</b>	15.75	60.00	3.58
<b>NTSC4.43</b>			4.43
<b>PAL</b>	15.63	50.00	3.58
<b>PAL-M</b>			
<b>PAL-N</b>	15.63	50.00	4.25 or 4.41
<b>SECAM</b>			

### NOTE:

- If using a signal source with poor picture quality, such as a dubbed tape, it may not be possible to get the picture to display properly.
- If the MENU button is pressed, the display will return to the MENU screen, or the MENU screen will be cleared if it is already being displayed.
- NTSC and PAL-M have the same scanning frequencies and color sub-carrier frequencies, but they have different color modulation methods. Because of this, if the incorrect setting is selected, color pictures may appear in black-and-white.

## ❑ Freezing the picture

Projection can be switched between a frozen (still) picture and a moving picture each time the FREEZE button on the remote control unit is pressed.

(Remote control unit)

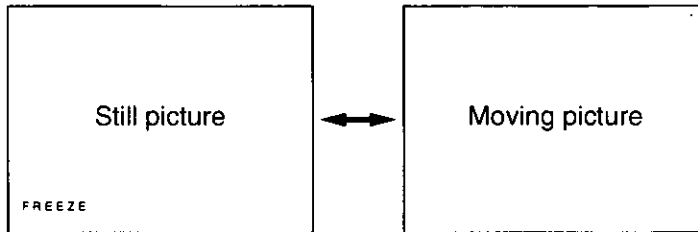
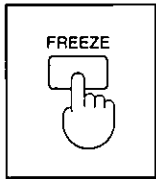

### NOTE:

- Picture adjustments, position adjustments and VIDEO IMPOSE (PT-L797 series only) and POINT ZOOM operations cannot be carried out while a still picture is being displayed.

## ❑ Returning adjustment values to the factory default settings (standard values)

If the STD button on the remote control unit is pressed while the PICTURE screen, POSITION screen or AUDIO screen is being displayed, or while an individual adjustment screen is being displayed, the adjustment values will be returned to their standard values at the time of shipment from the factory.

(Remote control unit)

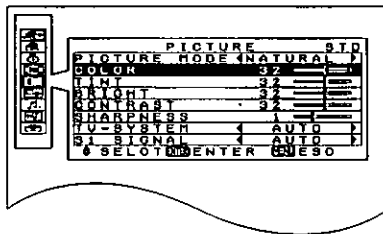
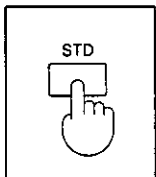

While the PICTURE or POSITION screen is being displayed ... "STD" will appear in green in the top-right corner of the screen, and the value being adjusted will be returned to the standard value.

While the AUDIO screen is being displayed ... "STD" will appear in green in the top-right corner of the screen, and only the BALANCE setting will be returned to the standard value.

While an individual adjustment screen is being displayed ... The adjustment level will be displayed in green and only the item displayed will be returned to the standard value.

### NOTE:

- The TV-SYSTEM setting in the PICTURE screen (when VIDEO/S-VIDEO signals are being input) and the VOLUME setting in the AUDIO screen will not return to the standard values when the STD button is pressed.

## ❑ Adjusting the volume

The volume can be adjusted using the VOL +/- buttons on the remote control unit.

(Remote control unit)

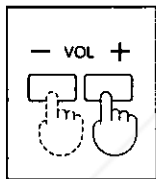

If "+" button is pressed ... the volume becomes louder.  
If "-" button is pressed ... the volume becomes quieter.

- If audio equipment is connected to the AUDIO OUT terminal, the output level from this terminal will be adjusted.

### NOTE:

- During volume adjustment, the output level will be displayed on the screen for approximately 5 seconds.
- Volume adjustment can also be carried out by selecting AUDIO from the on-screen menu screen. Refer to page 28 for further details.
- If this button is pressed while some other on-screen display is on the screen, the adjustment level and the bar scale will not be displayed but the adjustment operation will still work.

**THE TRUSTED SOURCE FOR PROJECTOR LAMPS AND ACCESSORIES**

## □ Turning off the sound

If the MUTE button on the remote control unit is pressed, "MUTE" will be displayed on the screen as shown in the illustration below and the sound will be muted. If the MUTE button is pressed once more, the on-screen display will be cleared and the normal sound volume will be restored. The volume output level will remain displayed on the screen for approximately three seconds.

### Remote control unit

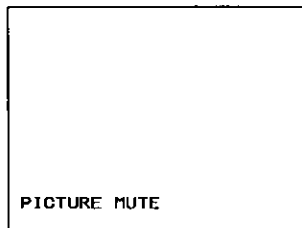
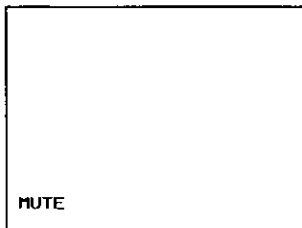
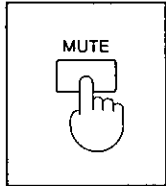

### NOTE:

- If the MUTE button is pressed while the on-screen display for another function is currently on the screen, the volume will still be muted but the "MUTE" on-screen display will not appear.
- If the power supply is turned off or either of the VOL (+/-) buttons is pressed, the mute setting will be canceled.
- It is also possible to have the picture turn off together with the sound when the MUTE button is pressed. Refer to page 38 for details on how to change this setting. When the picture has been turned off in this way, the words "PICTURE MUTE" will be displayed on the screen.

## Selecting the picture mode

In order to obtain better picture quality, two types of picture mode are available for VIDEO/S-VIDEO signals and RGB signals.

Use the procedure given below to select the desired mode (NATURAL/DYNAMIC).

### Setting procedure

1. Press the MENU button. ... The MENU screen will be displayed.
2. Use the "▲" and "▼" arrow buttons to move the cursor to "PICTURE".

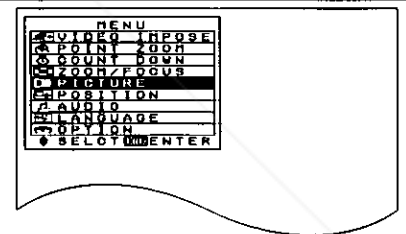

3. Press the ENTER button. ... The PICTURE screen will be displayed.
4. Use the "▲" and "▼" arrow buttons to move the cursor to "PICTURE MODE".
5. Use the "◀" and "▶" arrow buttons to switch the setting to "NATURAL" or "DYNAMIC" until the best picture is obtained.

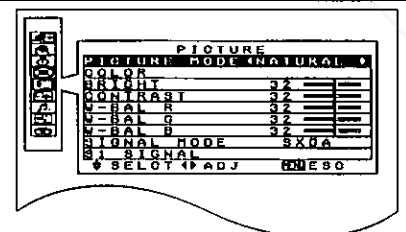

NATURAL: The picture obtained is appropriate when using this projector in places with standard brightness.

DYNAMIC: The picture obtained is appropriate when using this projector in brighter places.

### NOTE:

- Once a picture mode is selected by the above procedure, the picture can then be adjusted further as desired. Refer to the following page for details on adjustment methods.
- If the MENU button is pressed, the display will return to the MENU screen, or the MENU screen will be cleared if it is already being displayed.
- If the STD button is pressed while the PICTURE screen is being displayed, "STD" will be displayed in the top-right corner of the screen and the adjustment value being displayed (except for TV-SYSTEM) will be returned to the factory default setting in accordance with the picture mode selected.

# Adjusting the picture to the desired setting

You can adjust the picture settings for any of the input signal sources selected according to the procedure on page 21. The items which can be adjusted vary depending on the type of input signal. The adjustment procedure below describes the on-screen displays when the S-VIDEO signal or the VIDEO signal is being projected.

## Adjustment procedure <for the COLOR setting>

1. Press the MENU button to display the MENU screen.
2. Press the "▲" and "▼" buttons to select "PICTURE".

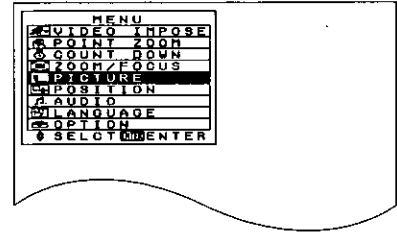

3. Press the ENTER button to display the PICTURE screen.
4. Press the "▲" and "▼" buttons to select "COLOR".

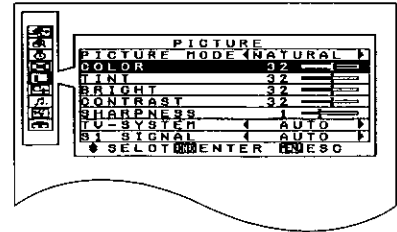

5. Press the ENTER, "◀" or "▶" button to display the COLOR individual adjustment screen.
6. Continue pressing the "◀" and "▶" buttons to adjust the color. The current setting will be displayed on the screen by numerals and a bar.
  - The adjustment operation and the changes made will vary depending on which adjustment item is selected. Refer to the table below for details.

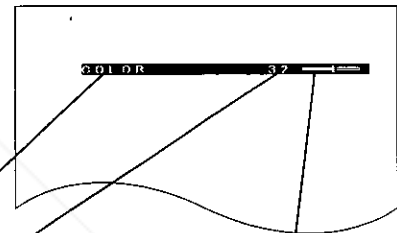

Adjustment function display

Numeric adjustment level display

Bar display

Adjustment Item	Button	Adjustment Details	Adjustment Range	Remarks
COLOR	Press the "▶" button.	The color becomes vivid.	Max. value 63	S-VIDEO/VIDEO /Y <sub>P</sub> P <sub>R</sub> only
	Press the "◀" button.	The color becomes pastel.	Min. value 0	
TINT	Press the "▶" button.	Flesh tones become greenish.	Max. value 63	NTSC, NTSC 4.43 (S-VIDEO/VIDEO) only
	Press the "◀" button.	Flesh tones become reddish.	Min. value 0	
BRIGHT	Press the "▶" button.	The screen becomes brighter.	Max. value 63	
	Press the "◀" button.	The screen becomes darker.	Min. value 0	
CONTRAST	Press the "▶" button.	The bright portion of the picture becomes brighter.	Max. value 63	
	Press the "◀" button.	The bright portion of the picture becomes darker.	Min. value 0	
SHARPNESS	Press the "▶" button.	The picture details becomes sharper.	Max. value 7	S-VIDEO/VIDEO only
	Press the "◀" button.	The picture details becomes softer.	Min. value 0	

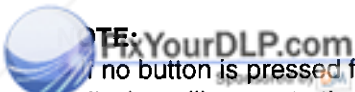

If no button is pressed for approximately 5 seconds while an individual adjustment screen is being displayed, the display will return to the PICTURE screen.

- If the MENU button is pressed, the display will return to the MENU screen, or the MENU screen will be cleared if it is already being displayed.
- Refer to page 23 for details on the TV-SYSTEM settings which appear in the PICTURE screen, and to page 25 for the PICTURE MODE settings.
- Refer to the next page for details on adjustment of the WHITE BALANCE R/G/B (W-BAL-R/G/B) settings which appear when RGB signals are being input and the PICTURE screen is being displayed.

# Adjusting the white balance

When RGB signals from a personal computer or other signal source are being projected, the picture may become over-saturated with red or blue color, and the white color may not be at the desired degree of whiteness. In such cases, adjust the white balance by the following procedure. (Only effective when RGB signals are being projected.)

## Adjustment procedure <for white balance adjustment of the red component>

1. Press the MENU button to display the MENU screen.
2. Press the "▲" and "▼" buttons to select "PICTURE".

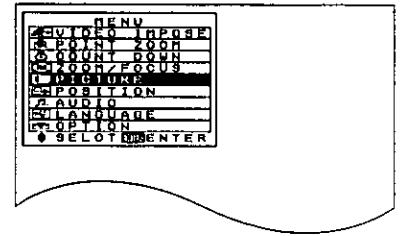

3. Press the ENTER button to display the PICTURE screen.
4. Press the "▲" and "▼" buttons to select "W-BAL R".

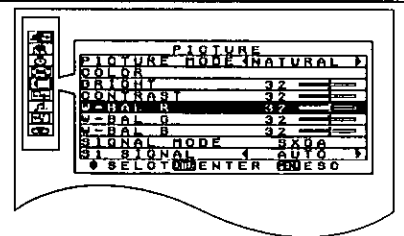

5. Press the ENTER, "◀" or "▶" button to display the W-BAL R individual adjustment screen.
6. Continue pressing the "◀" and "▶" buttons to adjust the W-BAL R setting. The current setting will be displayed on the screen by numerals and a bar.

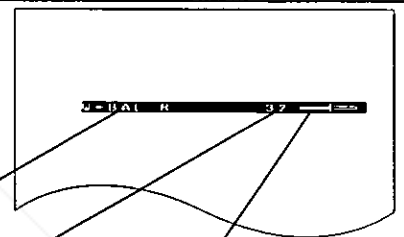

Adjustment function display

Numeric adjustment level display

Bar display

Adjustment Item	Button	Adjustment Details	Adjustment Range
W-BAL R	Press the "▶" button.	The red component becomes stronger.	Max. value 63 Min. value 0
	Press the "◀" button.	The red component becomes weaker.	
W-BAL G	Press the "▶" button.	The green component becomes stronger.	
	Press the "◀" button.	The green component becomes weaker.	
W-BAL B	Press the "▶" button.	The blue component becomes stronger.	
	Press the "◀" button.	The blue component becomes weaker.	

### NOTE:

- If these adjustments are not made correctly, none of the colors will be reproduced correctly. If you make an error in adjustment so that the colors do not match correctly, press the STD (Standard) button while one of the individual adjustment screens is being displayed. The value and the bar display will appear in yellow and only the item being displayed will be reset to the factory pre-setting.
- If the MENU button is pressed, the display will return to the MENU screen, or the MENU screen will be cleared if it is already being displayed.
- Separate adjustments can be carried out for RGB 1 and RGB 2.

# Adjusting the sound to the desired setting

You can adjust the volume and balance to the desired settings.

## Adjustment procedure <for volume adjustment>

1. Press the MENU button to display the MENU screen.
2. Press the “▲” and “▼” buttons to select “AUDIO”.

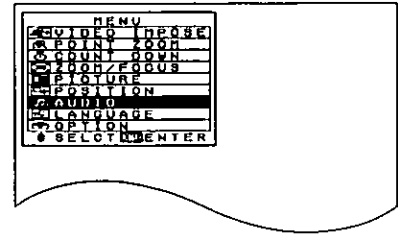

3. Press the ENTER buttons to display the AUDIO screen.
4. Press the “▲” and “▼” buttons to select “VOLUME”.
  - To adjust the balance, select “BALANCE” instead.

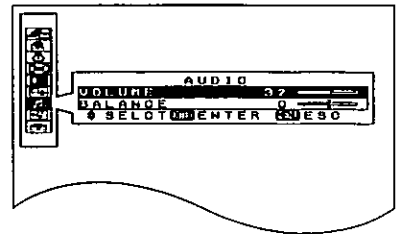

5. Press the ENTER, “◀” or “▶” button to display the VOLUME individual adjustment screen.
6. Continue pressing the “◀” and “▶” buttons to adjust the volume setting. The current setting will be displayed on the screen by numerals and a bar.
  - The adjustment range is between 0 and 63. (However, the adjustment range for the balance setting is -32+31.)
  - While “VOLUME” is selected, the volume of the sound coming from the built-in speakers and the output level of the signal from the AUDIO OUT terminal will change.
  - While “BALANCE” is selected, the left and right balance of the sound coming from the built-in speaker and the output level of the signal from the AUDIO OUT terminal will change.

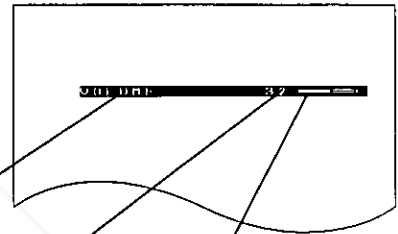

Adjustment function display

Numeric adjustment level display

Bar display

## NOTE:

- If no button is pressed for approximately 5 seconds while an individual adjustment screen is being displayed, the display will return to the AUDIO screen.
- If the MENU button is pressed, the display will return to the MENU screen, or the MENU screen will be cleared if it is already being displayed.
- Volume adjustment from the AUDIO screen works in exactly the same way as using the VOL +/- volume adjustment buttons on the remote control unit.
- If audio equipment is connected to the AUDIO OUT terminal, no sound will be output from the projector's built-in speakers, and the output level from the AUDIO OUT terminal will be adjusted. However, if the volume adjustment level is set to “0”, no audio signal will be output.

Discount-Merchant.com (800) 281-8860  
THE TRUSTED SOURCE FOR PROJECTOR LAMPS AND ACCESSORIES

# Correcting the picture position automatically

When a picture consisting of RGB signals is being projected from a source such as a personal computer, the horizontal position, vertical position, dot clock and clock phase can all be adjusted simultaneously. (This is only possible when RGB signals other than HDTV(1080i), 720p, 480p, NTSC(480i) and PAL(625i) are being projected.) Follow the procedure given below to use this function.

## Correction procedure <for direct operation>

1. Input a picture which consists of a screen full of black lettering or black lines from the connected video signal source.
2. Press the AUTO SETUP button on the projector's operation panel to start automatic correction.

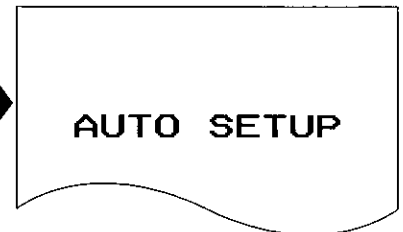
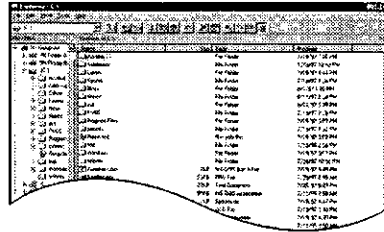

## Correction procedure <for on-screen display operation>

1. Input a picture which consists of a screen full of black lettering or black lines from the connected video signal source.

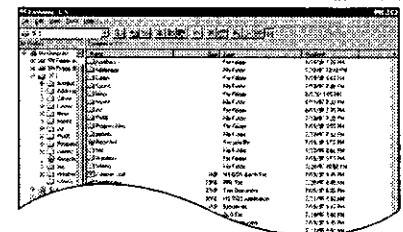

2. Press the MENU button. ... The MENU screen will be displayed.
3. Use the "▲" and "▼" arrow buttons to move the cursor to "POSITION".

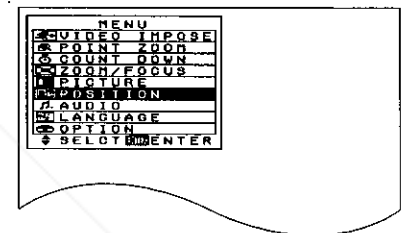

4. Press the ENTER button. ... The POSITION screen will be displayed.
5. Use the "▲" and "▼" arrow buttons to move the cursor to "AUTO SETUP".

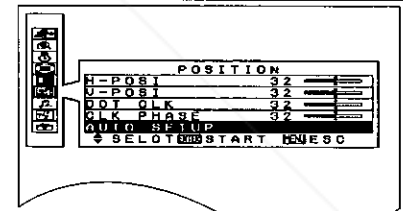

6. Press the ENTER button. ... The automatic position correction operation will then start.



### NOTE:

- If the edges of the picture image cannot be determined, or if a dark picture is being input when using the automatic position correction operation, "AUTO SETUP INCOMPLETE" will be displayed.

In such cases, press the MENU button to return to the POSITION screen, change the picture to one such as that listed in step 1., and then repeat the operation.

If an interlaced signal with a resolution greater than 1024 × 768 dots (800 × 600 dots for the PT-L597U) is being input, automatic clock phase correction will not be possible. If any distortion or uneven contours appear in the picture, adjust the clock phase while referring to page 32.

- During automatic position correction operations, the characters "AUTO SETUP" will display on the screen.
- Once automatic position correction completes normally, the display will return to the POSITION screen.
- If the MENU button is pressed during automatic position correction, automatic position correction will be stopped and the display will return to the POSITION screen.
- The use of automatic position correction may not be possible with some types of personal computer.
- Automatic position correction can be carried out for different input signals, and the corrected values will be stored in memory.

# Adjusting the picture position

If the picture is not correctly positioned within the display area of the screen so that part of the edge of the picture does not appear, adjust the position of the picture.

The adjustment procedure below describes the on-screen displays when an S-VIDEO or VIDEO signal is being projected.

## Adjustment procedure <for horizontal position adjustment>

1. Press the MENU button to display the MENU screen.
2. Press the "▲" and "▼" buttons to select "POSITION".

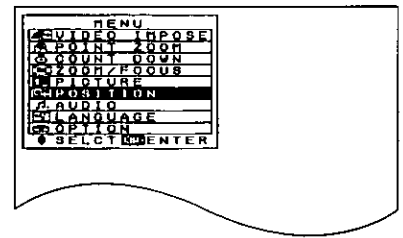

3. Press the ENTER button to display the POSITION screen.
4. Press the "▲" and "▼" buttons to select "H-POSI".
  - To adjust the vertical position of the picture, select "V-POSI" instead.

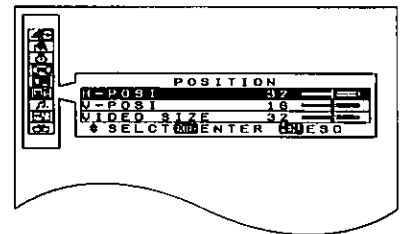

5. Press the ENTER, "◀" or "▶" button to display the H-POSI individual adjustment screen.
6. Continue pressing the "◀" and "▶" buttons to adjust the H-POSI setting. The current setting will be displayed on the screen by numerals and a bar.

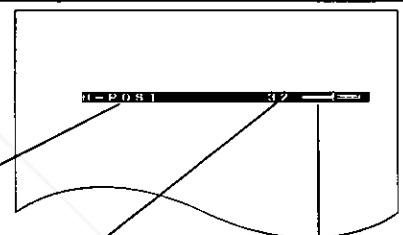

Adjustment function display

Numeric adjustment level display

Bar display

## <When adjusting the horizontal position (H-POSI)>

If the "▶" button is pressed, the picture moves to the right.

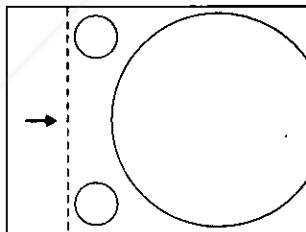

If the "◀" button is pressed, the picture moves to the left.

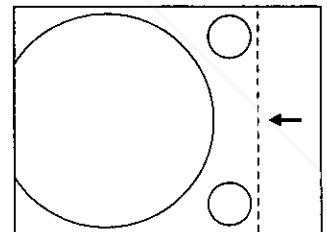

## <When adjusting the vertical position (V-POSI)>

If the "▶" button is pressed, the picture moves up.

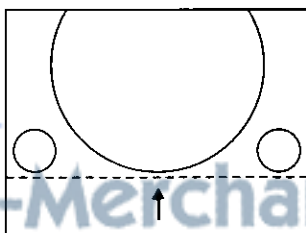

If the "◀" button is pressed, the picture moves down.

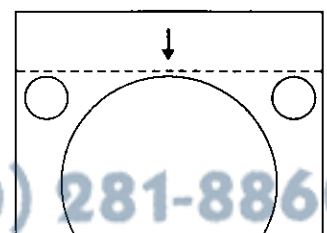

## NOTE: THE TRUSTED SOURCE FOR PROJECTOR LAMPS AND ACCESSORIES

- If approximately five seconds pass without any buttons being pressed while an individual adjustment screen is being displayed, the display will return to the POSITION screen.
- If the MENU button is pressed, the display will return to the MENU screen, or the MENU screen will be cleared if it is already being displayed.



# Adjusting the video size

The video size can be adjusted to overscan and underscan sizes only when an S-VIDEO or VIDEO signal is being projected. Adjust by the following procedure.

## Adjustment procedure

1. Press the MENU button to display the menu screen.
2. Press the "▲" and "▼" buttons to select "POSITION".

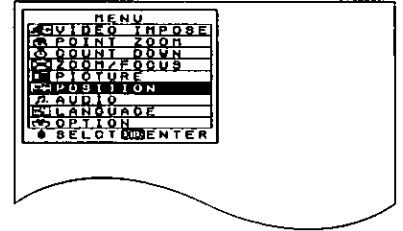

3. Press the ENTER button to display the POSITION screen.
4. Press the "▲" and "▼" buttons to select "VIDEO SIZE".

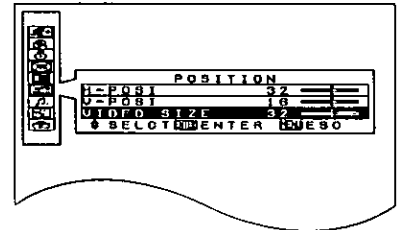

5. Press the ENTER, "◀" or "▶" button to display the VIDEO SIZE individual adjustment screen.
6. Continue pressing the "◀" and "▶" buttons to adjust the VIDEO SIZE setting. The current setting will be displayed on the screen by numerals and a bar.

Adjustment function display

Numeric adjustment level display

Bar display

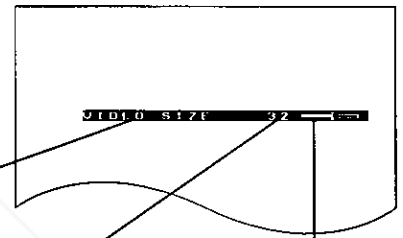

### <For overscanning>

Press the "▶" arrow button.  
... The picture will expand.

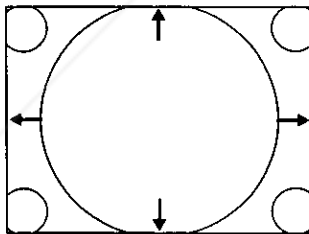

### <For underscanning>

Press the "◀" arrow button.  
... The picture will contract.

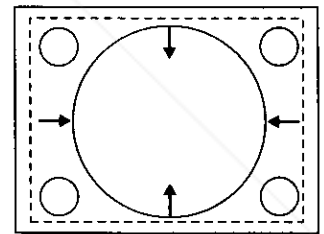

### NOTE:

- If video size adjustment results in the picture position tending to one side, adjust the position while referring to page 30.
- If no button is pressed for approximately 5 seconds while an individual adjustment screen is being displayed, the display will return to the POSITION screen.
- If the MENU button is pressed, the display will return to the MENU screen, or the MENU screen will be cleared if it is already being displayed.



FIXTOOLDEP.COM  
Sponsored by DM

Discount-Merchant.com (800) 281-8860

THE TRUSTED SOURCE FOR PROJECTOR LAMPS AND ACCESSORIES

# About dot clock adjustment

When RGB signals are being input, you can make fine adjustments to the dot clock frequency and also adjust the clock phase. When using equipment such as a computer to send signals containing detailed patterns to the projector, stripe patterns (noise) may appear in the projected picture. You can use dot clock adjustment to eliminate these stripe patterns as much as possible. Adjust the dot clock frequency (DOT CLK) first, and then adjust the clock phase (CLK PHASE). (This is only effective when RGB signals are being projected.)

## Adjusting the dot clock frequency

### Adjustment procedure

The procedure below starts from the POSITION screen.

1. Press the “▲” and “▼” buttons to select “DOT CLK”.

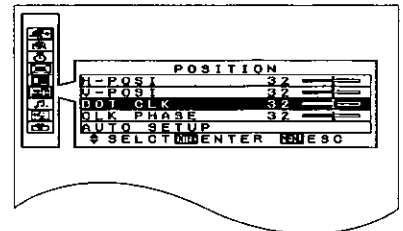

2. Press the ENTER, “◀” or “▶” button to display the DOT CLK individual adjustment screen.
3. Continue pressing the “◀” and “▶” buttons to adjust the DOT CLK setting. The current setting will be displayed on the screen by numerals and a bar.

Adjustment function display

Numeric adjustment level display

Bar display

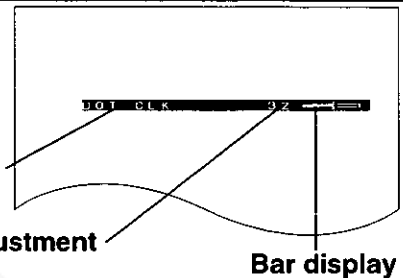

## Adjusting the clock phase

### Adjustment procedure

The procedure below starts from the POSITION screen.

1. Press the “▲” and “▼” buttons to select “CLK PHASE”.

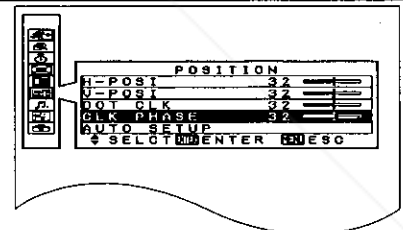

2. Press the ENTER, “◀” or “▶” button to display the CLK PHASE individual adjustment screen.
3. Continue pressing the “◀” and “▶” buttons to adjust the CLK PHASE setting. The current setting will be displayed on the screen by numerals and a bar.

Adjustment function display

Numeric adjustment level display

Bar display

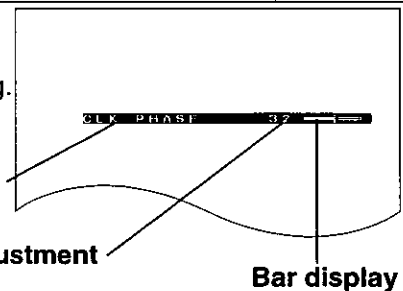

### NOTE:

- If approximately five seconds pass without any buttons being pressed while an individual adjustment screen is being displayed, the display will return to the POSITION screen.
- If the MENU button is pressed, the display will return to the MENU screen, or the MENU screen will be cleared if it is already being displayed.
- If the STD (Standard) button is pressed while one of the individual adjustment screens is being displayed, the value and the bar display will appear in yellow and only the item displayed will be reset to the factory pre-setting.
- Separate adjustment is possible for each input signal, and the results of adjustment are stored in memory.

# Using other useful functions

## □ Using the video impose function (PT-L797 series only)

This projector can be used to display a VIDEO/S-VIDEO signal image in a sub-screen on an RGB image (video impose).

### Setting procedure

1. Press the MENU button. ... The MENU screen will be displayed.
2. Use the “▲” and “▼” arrow buttons to move the cursor to “VIDEO IMPOSE”.

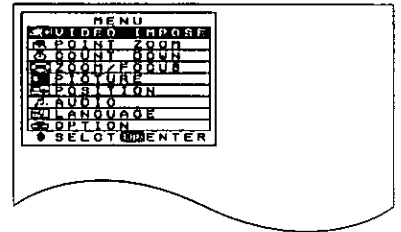

3. Press the ENTER button. ... The VIDEO IMPOSE screen will be displayed.

- The position of the sub-screen can be changed by pressing the “▲”, “▼”, “◀” and “▶” arrow buttons.
- The size of the sub-screen can be changed to one of two sizes using the STD button.

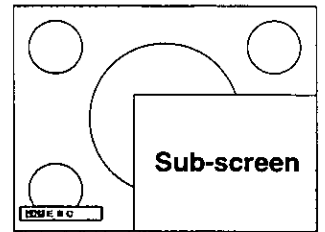

### NOTE:

- The video impose function is only effective when RGB signals are being input.
- If the FREEZE button is pressed before VIDEO IMPOSE is selected, the video impose function will not operate.
- If the VIDEO button or the RGB button is pressed while the video impose function is operating, the video impose function will be canceled and the screen will switch back to projecting the input video signal.
- If the FREEZE button is pressed while the video impose function is operating, a still picture can be obtained.
- Video/S-Video signals with an aspect ration of 16:9 will be displayed at 4:3 when using the video impose function.
- Picture distortion may occur if the video impose function is used for special playback of signals from a video deck. If this happens, use a TBC (time base corrector).

## □ Switching between RGB and YP<sub>b</sub>P<sub>r</sub> signal input

You can use menu operations to switch between RGB and YP<sub>b</sub>P<sub>r</sub> input modes according to the type of signal being input to the RGB2 input connector at the rear of the unit.

### Setting procedure <Switching to YP<sub>b</sub>P<sub>r</sub>>

1. Press the MENU button. ... The MENU screen will be displayed.
2. Press the “▲” or “▼” button to move the cursor to OPTION.

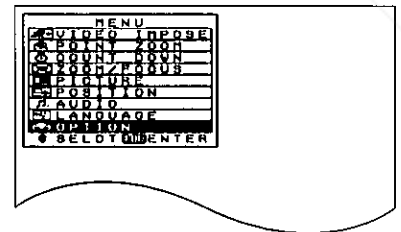

3. Press the ENTER button. ... The OPTION screen will be displayed.

4. Press the “▲” or “▼” button to move the cursor to RGB2 FORMAT.
5. Press the “◀” or “▶” button to select YP<sub>b</sub>P<sub>r</sub>.

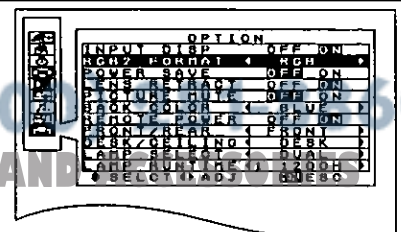

### NOTE:

- This setting only applies to the RGB2 input terminal. The RGB1 input connector will only receive and display RGB signals, regardless of this parameter setting.

## □ Enlarging part of the input picture

You can enlarge and project specific portions of the input picture and select the enlargement ratio for this portion. Follow the procedure given below.

### Operating procedure

1. Press the MENU button. ... The MENU screen will be displayed.
2. Use the “▲” and “▼” arrow buttons to move the cursor to “POINT ZOOM”.

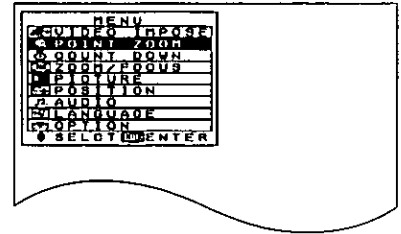

3. Press the ENTER button. ... The enlargement area selection screen will be displayed. (A frame allowing you to select the part to be enlarged will be displayed.)
4. Use the “▲”, “▼”, “◀” and “▶” arrow buttons to move the frame to the area to be enlarged.  
Press the “▲” and “▼” arrow buttons to move the frame up and down.  
Press the “◀” and “▶” arrow buttons to move the frame to the left and right.

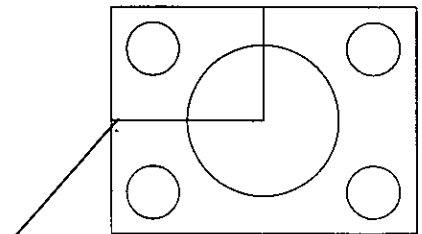

Enlargement area selection frame

5. Press the STD button to select the enlargement ratio (only when an RGB image is being projected).  
When set to double enlargement, the frame will become bigger, and when set to triple enlargement, the frame will become smaller.

### NOTE:

- The STD button can be used to select double enlargement or triple enlargement only while the enlargement area selection frame is being displayed.

6. Press the ENTER button. ... The enlarged part of the picture will be displayed.
7. Use the “▲”, “▼”, “◀” and “▶” arrow buttons to adjust the position of the enlarged picture.  
Use the “▲” and “▼” arrow buttons to move the position up and down.  
Use the “◀” and “▶” arrow buttons to move the position to the left and right.

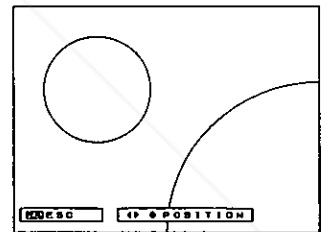

8. Press the STD button to change to the enlargement ratio adjustment screen.
9. Use the “▲”, “▼”, “◀” and “▶” buttons to adjust the enlargement ratio.  
Press the “▲” or “▶” button to increase the enlargement ratio.  
Press the “▼” or “◀” button to decrease the enlargement ratio.

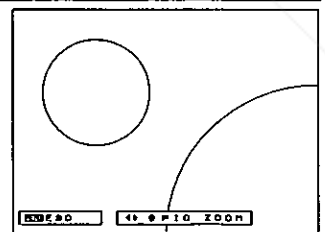

### NOTE:

If the FREEZE button is pressed before the enlargement function is selected, the video impose function will not operate.

- If the MENU button is pressed, the display will return to the MENU screen, or the MENU screen will be cleared if it is already being displayed.
- If the FREEZE button is pressed while the enlargement function is operating, a still picture can be obtained.
- If the STD button is pressed once more while the enlargement size adjustment screen is being displayed, the display will return to the screen for adjusting the display position for the enlarged picture.
- The adjustment range for the enlargement size varies as follows according to the type of input signal.

During projection of Video/S-Video signals	x1.0 - x2.0
During projection of RGB signals	x1.0 - x3.0

## □ Turning off the input signal display and the Operable Button Guide display

You can prevent the input signal indication from being displayed each time the input source is switched. Similarly, you can prevent display of the operable button guide with, for instance, POINT ZOOM and VIDEO IMPOSE, by the following procedure.

### Setting procedure

1. Press the MENU button. ... The MENU screen will be displayed.
2. Use the “▲” and “▼” arrow buttons to move the cursor to “OPTION”.

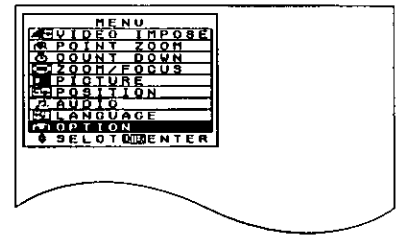

3. Press the ENTER button. ... The OPTION screen will be displayed.
4. Use the “▲” and “▼” arrow buttons to move the cursor to “INPUT DISP”.
5. Use the “◀” and “▶” arrow buttons to switch the setting to OFF.
  - If the setting is switched to ON, the input signal names and operable button guide displays will appear on the screen. (Factory default setting)

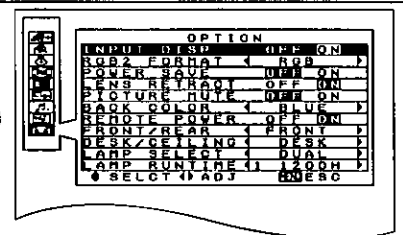

### NOTE:

- If the MENU button is pressed, the display will return to the MENU screen, or the MENU screen will be cleared if it is already being displayed.

## □ Disabling the POWER button of the remote control unit

The POWER button on the remote control unit can be disabled to prevent the chance of turning the power off by mistake when using the remote control unit. This setting can be made by following the procedure given below.

### Setting procedure

1. Press the MENU button to display the MENU screen.
2. Press the “▲” and “▼” buttons to select “OPTION”.

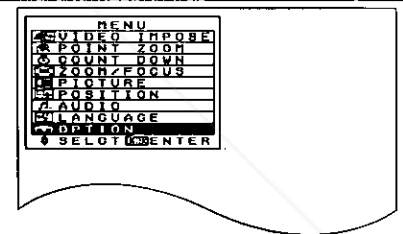

3. Press the ENTER button to display the OPTION screen.
4. Press the “▲” and “▼” buttons to select “REMOTE POWER”.
5. Press the “◀” and “▶” buttons to select “OFF”.
  - If this is set to “ON”, the POWER button on the remote control unit can be used to turn the power on and off. (Factory pre-setting)

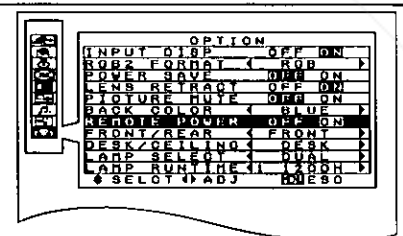

### NOTE:

- If the MENU button is pressed, the display will return to the MENU screen, or the MENU screen will be cleared if it is already being displayed.

## □ Changing the on-screen display language

When the projector is shipped from the factory, the on-screen display language is set to English. Data for seven different languages is stored in the projector, so that you can select any one of these languages by following the procedure below.

### Setting procedure <To change the language to German>

1. Press the MENU button. ... The MENU screen will be displayed.
2. Use the “▲” and “▼” arrow buttons to move the cursor to “LANGUAGE”.

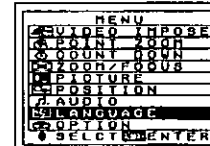

3. Press the ENTER button. ... The LANGUAGE screen will be displayed.
4. Use the “▲” and “▼” arrow buttons to move the cursor to “DEUTSCH”.
  - The languages available are English (ENGLISH), German (DEUTSCH), French (FRANÇAIS), Spanish (ESPAÑOL), Italian (ITALIANO), Japanese (日本語) and Chinese (中文).

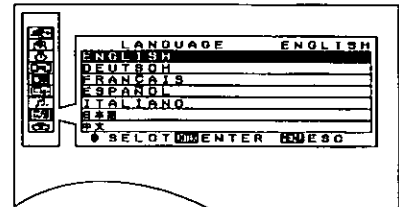

5. Press the ENTER button. ... The menus, setting and adjustment screens and the operable button guide displays will then appear in the language selected.

#### NOTE:

- If the MENU button is pressed, the setting screen or MENU screen will be cleared.
- The list of language selections in the LANGUAGE screen appear in the same way for all languages and does not change.

## □ Using the countdown timer

The countdown timer can be used at times such as during breaks in meetings by displaying the amount of time remaining for something on the screen. The countdown time can be set to a maximum of 60 minutes, in units of 1 minute. The setting procedure is as follows.

### Setting procedure

1. Press the MENU button to display the MENU screen.
2. Press the “▲” and “▼” buttons to select “COUNT DOWN”.

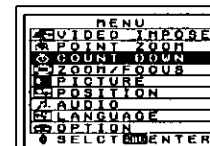

3. Press the ENTER button to display the COUNT DOWN screen.
4. Continue pressing the “◀” and “▶” buttons to set the time.
  - The setting can be made in units of one minute up to a maximum of 60 minutes.
  - This function can be disabled by setting the time to “0”.

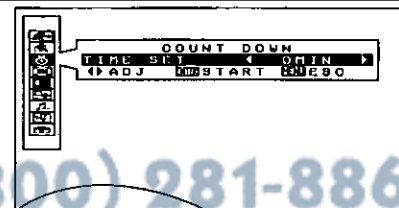

5. Press the ENTER button. ... The countdown timer will then start.

#### NOTE:

- During the countdown, the screen will appear in the background color as described on page 38.
- If the MENU button is pressed during the countdown, the timer display will be cleared and the screen will return to the COUNTDOWN setting screen.
- If the FREEZE button is pressed to produce a still picture and the countdown timer is then set or activated, the countdown will take place with the still picture still displayed.

## □ Using the power save function

The power save function operates as follows: If the projector continues projecting for 10 minutes or more while there is no input signal to be projected, the light source lamp will shut off automatically to save power. After 20 minutes, the power supply will be turned off and the projector will enter standby mode. At the time of shipment from the factory, the power save function is set to OFF, so that if you would like to use this function, you can turn it on by the following procedure.

### Setting procedure

1. Press the MENU button. ... The MENU screen will be displayed.
2. Use the “▲” and “▼” arrow buttons to move the cursor to “OPTION”.

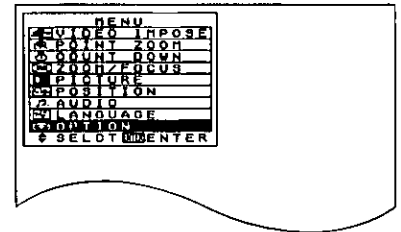

3. Press the ENTER button. ... The OPTION screen will be displayed.
4. Use the “▲” and “▼” arrow buttons to move the cursor to “POWER SAVE”.
5. Use the “◀” and “▶” arrow buttons to switch the setting to ON.

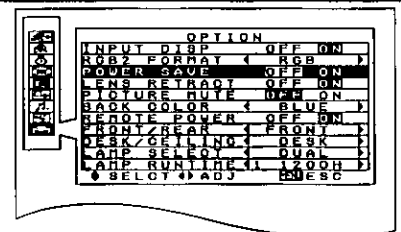

### NOTE:

- If the light source lamp has turned off as a result of the power save function, the power indicator will appear orange. If a signal is then input, the power source lamp will switch back on and the picture will be projected. If the power supply has been turned off by this function, it can be turned back on by pressing the POWER button.
- If the MENU button is pressed, the display will return to the MENU screen, or the MENU screen will be cleared if it is already being displayed.
- If this function activates while the lens retract function is set to ON, you will need to re-adjust the lens according to the procedure on page 18.
- This function does not operate while the countdown timer is operating.

## □ Using the lens retracting function

This function causes the projector lens to be retracted automatically when the projector switches to standby mode, and extends the lens again when the projector starts back up again. Having this function set to “ON” is useful if the projector will not be used for an extended period of time, or when the projector is to be transported somewhere. However, once the lens has been retracted, it will be necessary to readjust the zoom and focus of the lens once the projector has been started up again. At the time of shipment from the factory this function is set to “ON”.

### Setting procedure

1. Press the MENU button to display the MENU screen.
2. Press the “▲” and “▼” buttons to select “OPTION”.

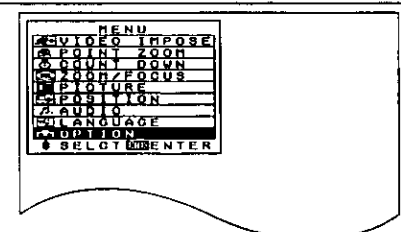

3. Press the ENTER button to display the OPTION screen.
4. Press the “▲” and “▼” buttons to select “LENS RETRACT”.
5. Press the “◀” and “▶” buttons to change the setting to “ON”
  - If you set this function to “ON”, the lens will be extended and retracted each time the power is turned on and off.

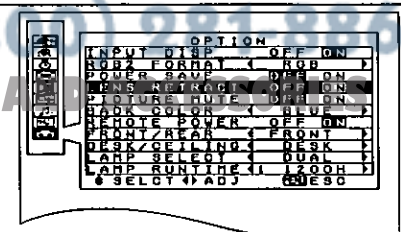

### NOTE:

- If this function is set to “OFF”, the lens will remain extended at all times.
- If the MENU button is pressed, the display will return to the MENU screen, or the MENU screen will be cleared if it is already being displayed.

## □ Setting the background color (screen color) when no signal is input or when the video signal is muted

The projector can be set to project either a solid blue image or a solid black image onto the screen if nothing is connected to the projector's input terminals, or if equipment is connected but no signal is being input from it. This setting is also effective when picture muting is active and when the countdown timer is running.

At the time of shipment from the factory, the color is set to "BLUE".

### Setting procedure

1. Press the MENU button to display the MENU screen.
2. Press the "▲" and "▼" buttons to select "OPTION".

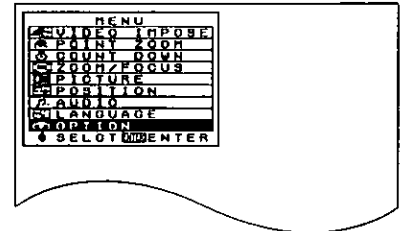

3. Press the ENTER button to display the OPTION screen.
4. Press the "▲" and "▼" buttons to select "BACK COLOR".
5. Press the "◀" and "▶" buttons to change the setting to "BLUE" or "BLACK".
  - This will set the color to be projected when no signal is being input.

### NOTE:

- If a signal that the projector cannot recognize is input, the projector will consider this to be no signal.
- If the MENU button is pressed, the display will return to the MENU screen, or the MENU screen will be cleared if it is already being displayed.

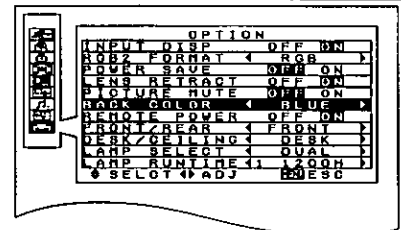

## □ Using the MUTE remote control unit button to turn off both sound and picture

At the time of shipment from the factory, the MUTE button on the remote control unit is set so that only the sound is muted when the button is pressed. If you would like the picture to be muted along with the sound, set the PICTURE MUTE function to "ON" by the following procedure.

### Setting procedure

1. Press the MENU button to display the MENU screen.
2. Press the "▲" and "▼" buttons to select "OPTION".

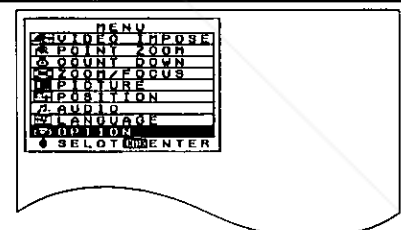

3. Press the ENTER button to display the OPTION screen.
4. Press the "▲" and "▼" buttons to select "PICTURE MUTE".
5. Press the "◀" and "▶" buttons to change the setting to "ON".
  - If the function is set to "ON", the picture will be muted along with the sound when the MUTE button is pressed.
  - If the function is set to "OFF", only the sound will be muted when the MUTE button is pressed. (Factory pre-setting)

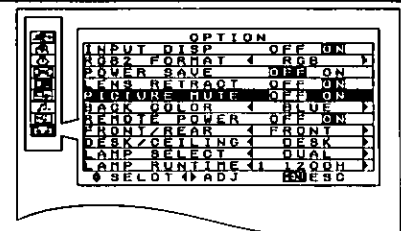

### NOTE:

- Press the MENU button to clear the setting screen and the MENU screen.
- When PICTURE MUTE is on, the color projected will be the same color as the BACK COLOR setting.

FXYouDLP.com  
Sponsored by DM

DiscountMerchant.com (800) 281-8860

THE TRUSTED SOURCE FOR PROJECTOR LAMPS AND ACCESSORIES



## □ Changing the light source lamps (Dual mode/Single mode)

The two light source lamps which are built into this projector can be changed between “DUAL” and “SINGLE” modes of brightness according to the conditions and purpose of use. Furthermore, “SINGLE” mode has two further modes where the lamps can be selected automatically or specified individually.

### Setting procedure

1. Press the MENU button. ... The MENU screen will be displayed.
2. Use the “▲” and “▼” arrow buttons to move the cursor to “OPTION”.

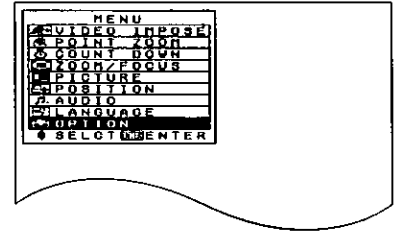

3. Press the ENTER button. ... The OPTION screen will be displayed.
4. Use the “▲” and “▼” arrow buttons to move the cursor to “LAMP SELECT”.
5. Press the “◀” or “▶” button to select the desired setting while referring to the table below.
6. Turn off the power supply and then turn it back on again. The setting made above will then be enabled.

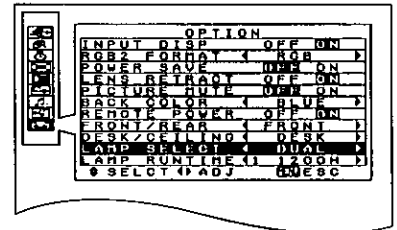

Setting	Illumination condition
DUAL	Two lamps illuminate.
SINGLE	One lamp illuminates. The lamp with the shortest usage time is selected automatically.
SINGLE1	One lamp illuminates. Lamp unit 1 always illuminates.
SINGLE2	One lamp illuminates. Lamp unit 2 always illuminates.

### NOTE:

- After the setting has been changed on-screen, it will not yet be enabled. You must turn the power off and then back on again.
- If one of the lamps has not been installed, it may take approximately 90 seconds for the other lamp to illuminate when “SINGLE” mode is selected. In this case, set to “SINGLE 1” or “SINGLE 2” mode.
- If the MENU button is pressed, the screen display will return to the MENU screen or the MENU screen will be cleared.
- If “SINGLE1” or “SINGLE2” is set but the corresponding lamp cannot illuminate, the other lamp will illuminate automatically.

## □ Checking the light source lamp usage times

You can use the following procedure to check the respective usage times for the two light source lamps which are built into this projector.

### Operating procedure

1. Press the MENU button to display the MENU screen.
2. Press the “▲” and “▼” buttons to select “OPTION”.

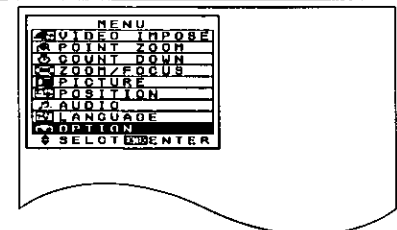

3. Press the ENTER button to display the OPTION screen.
  - The LAMP RUNTIME item will show a lamp number and the usage time for that lamp.
  - The display will change between the usage times for lamp 1 and lamp 2 each time one of the “◀” or “▶” buttons is pressed.

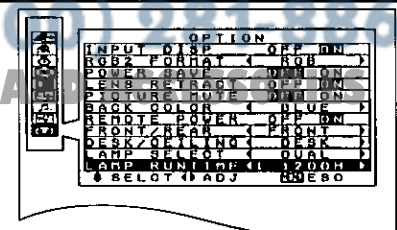

### NOTE:

- If the MENU button is pressed, the display will return to the MENU screen, or the MENU screen will be cleared if it is already being displayed.

## □ Changing the aspect ratio for projected images

This projector can automatically change the aspect ratio in accordance with the type of signal being input to the S-VIDEO terminal, or the aspect ratio can be changed manually to ratios such as 16:9 or 4:3.

### Setting procedure

1. Press the MENU button to display the MENU screen.
2. Press the “▲” and “▼” buttons to select “PICTURE”.

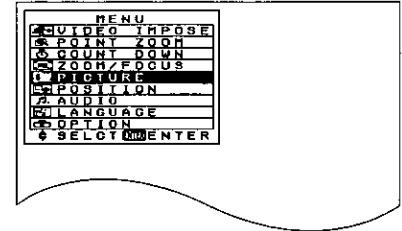

3. Press the ENTER button to display the PICTURE screen.
4. Press the “▲” and “▼” buttons to select “S1 SIGNAL”.
5. Press the “◀” and “▶” buttons to select the desired setting while referring to the table below.

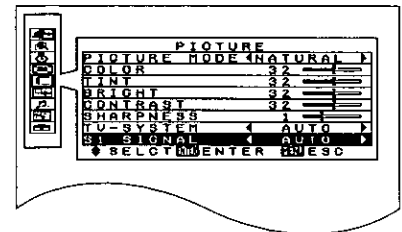

### Setting details

	Details of operation	Remarks
<b>AUTO</b>	When an S1 video signal is input to the S-VIDEO terminal, the aspect ratio is changed automatically to project a 16:9 picture.	Only applies to S-Video signals in NTSC format.
<b>16:9</b>	The picture is compressed to a ratio of 16:9 and projected.	Only applies to Video/S-Video signals, and NTSC (480i), PAL (625i) and 480p signals which are being input to the RGB/YPbPr connector.
<b>4:3</b>	The input signal is projected without change.	
<b>S4:3</b>	The size of the input signal is compressed to 75% and projected. (This is useful for projecting a picture with a 4:3 aspect ratio onto a 16:9 screen.)	

### S1 video signals

- S1 video signals are a type of video signal with an aspect ratio of 16:9 which include a detector signal. This detector signal is output by some sources such as wide-vision video decks. If the AUTO setting above is selected, this projector will recognize the detector signal and automatically switch the aspect ratio to 16:9 in order to project the picture.

### NOTE:

- If the MENU button is pressed, the screen display will return to the MENU screen or the MENU screen will be cleared.



**Discount-Merchant.com (800) 281-8860**  
THE TRUSTED SOURCE FOR PROJECTOR LAMPS AND ACCESSORIES

# System configuration example

## Notes on system configuration

- Turn off the power supply of each system component before connecting any of the components.
- Read the instruction manual for each system component before connecting it.
- If the necessary cables for connecting any system components are not supplied with the component or available as an option, you may need to fashion a cable to suit the component concerned.
- If there is a lot of jitter in the video signal input from the video source, the picture on the screen may flicker. In such cases, it will be necessary to connect a TBC (time base corrector).
- The projector can be connected to video signal sources which out put VIDEO, S-VIDEO and analog RGB signals (TTL synchronized signals).
- The projector has built-in speakers. However, you will need to connect a separate audio system to the AUDIO OUT terminal if your needs specify high sound volumes. No sound will come out of the projector's built-in speaker while the AUDIO OUT terminal is being used.
- It may not be possible to connect some types of computer.

## Example of connection to audio-visual equipment

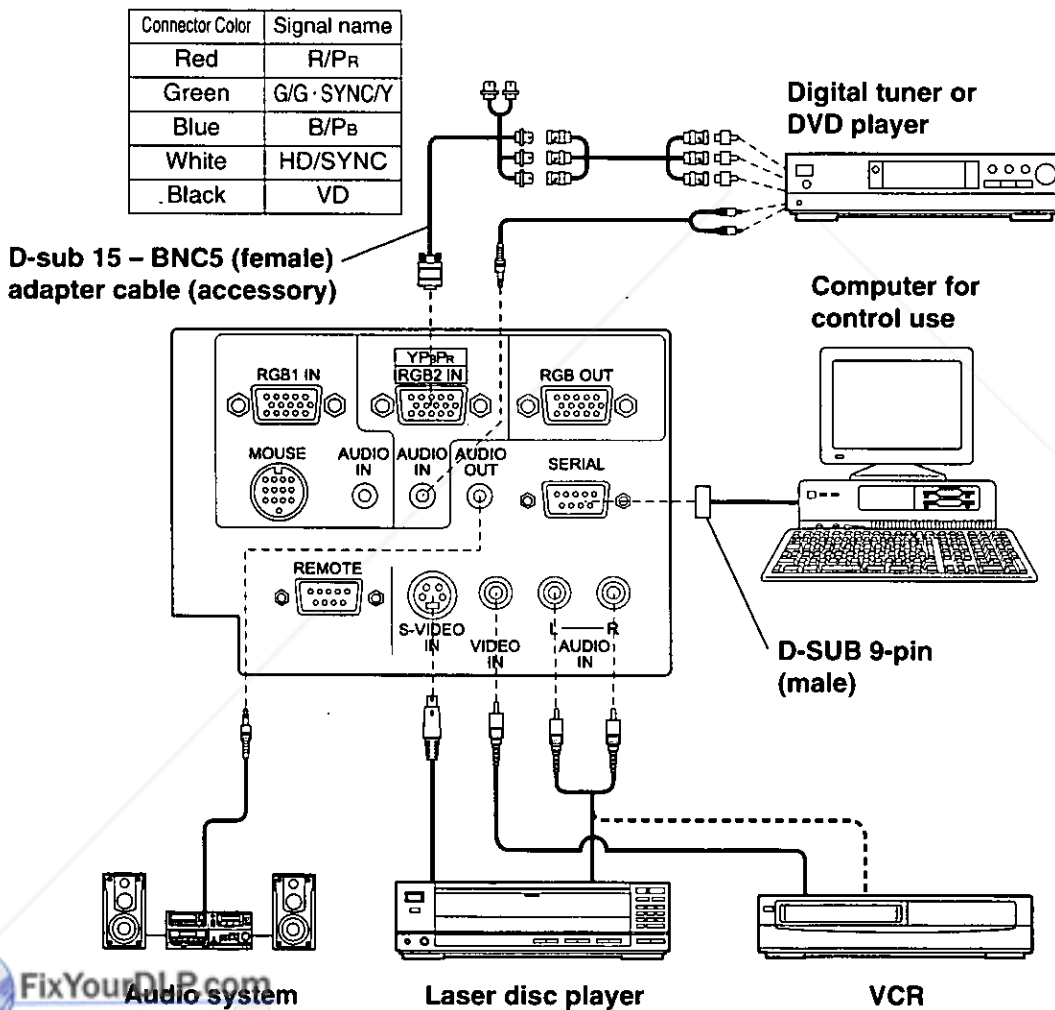

### NOTE:

- Only one audio signal input system is available for the AUDIO IN (L-R) terminals for S-VIDEO/VIDEO signals, so if you wish to change the audio input source, you will need to remove and insert the appropriate plugs.
- If the video signal source is connected using a cable with a BNC junction plug, use the BNC/RCA adapter to convert the pin jack.
- If an audio system is connected to the AUDIO OUT terminal, the sound volume balance and muting can be controlled by the remote control unit which is supplied with the projector. However, if the volume is set to "0", no audio signal will be output from the AUDIO OUT terminal.

## Example of connection to a computer

- Pin configuration and signal names for RGB connector

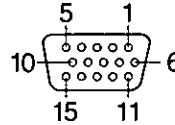

Pin No.	Signal name
1	R/P <sub>R</sub>
2	G/G-SYNC/Y
3	B/P <sub>B</sub>
9	NC
12	SDA
13	HD/SYNC
14	VD
15	SCL
4-8, 10, and 11	GND

### NOTE:

- Pin No. 12 and pin No. 15 on 15-pin connectors will only work if the computer supports them.\
- YP<sub>B</sub>P<sub>R</sub> only applies to the RGB2 input connector.

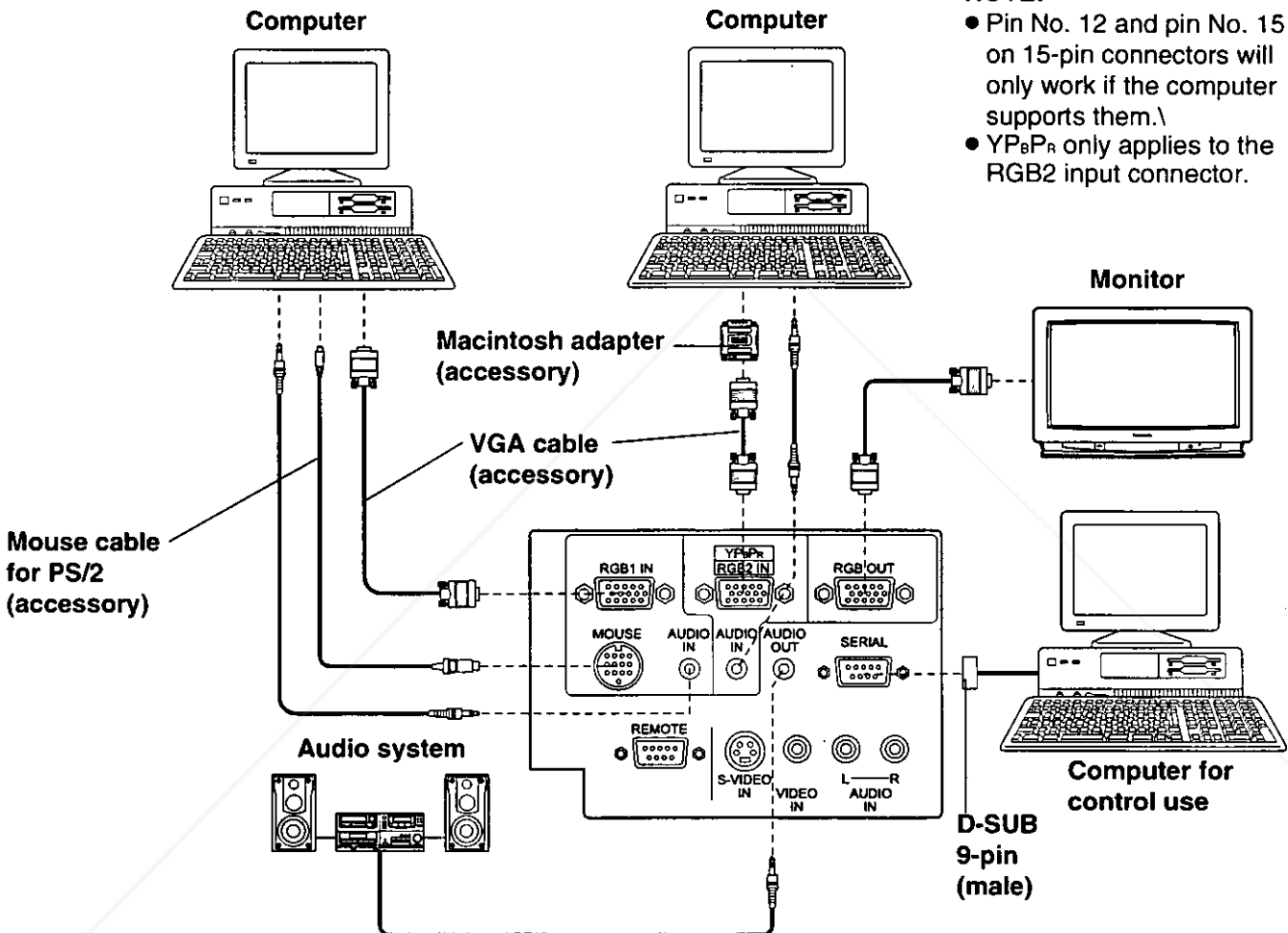

### NOTE:

- If the mouse connector on the projector is connected to the mouse connector on the computer with the accessory or separate mouse cable, you can then use the remote control unit in place of the computer's mouse. However, this function operates only when input to the RGB 1 connector has been selected. For further details, refer to page 43.
- If you wish to use the infrared mouse function, turn on the main power to the projector before turning on the personal computer.
- If using a personal computer with a suspend/resume function, the infrared mouse function may not operate until the computer is restarted.
- Refer to the data on page 22 for the different types of RGB signal that can be input to this projector by connecting a personal computer.
- The signal output from the RGB OUT connector will be the signal which is input from the signal source which is connected to the RGB 1 or RGB 2 connector.

# About the Macintosh adapter

An adapter for use with Macintosh computers is included with this unit. If image signals are to be input to this unit from a Macintosh computer, connect this adapter to the accessory VGA cable at the end which is to be connected to the computer. The resolution of the video signals output from the Macintosh computer can be switched by changing the adapter DIP switch settings.

Set the DIP switches to match the desired resolution according to the table given below.

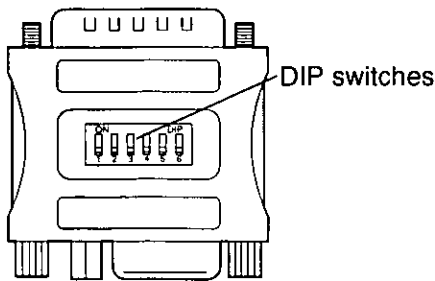

Display mode name/No. of dots	S1	S2	S3	S4	S5	S6
MAC 13 / 640 × 480	ON	ON	OFF	OFF	OFF	OFF
MAC 16 / 832 × 624	OFF	ON	OFF	ON	OFF	OFF
MAC 19 / 1024 × 768	OFF	ON	ON	OFF	OFF	OFF
MAC 21 / 1152 × 870	ON	ON	ON	ON	OFF	OFF

## Wireless mouse

A wireless mouse function is provided. This function lets you use the remote control unit to control a personal computer in place of the personal computer's mouse. This is done by connecting the projector to a personal computer using the mouse cable (6'7" (2.0 m)) which is supplied with the projector.

This projector is compatible with the following types of mouse only. Other types of mouse cannot be used.

- PS/2 mouse
- Macintosh mouse
- Serial mouse

### Example of connection

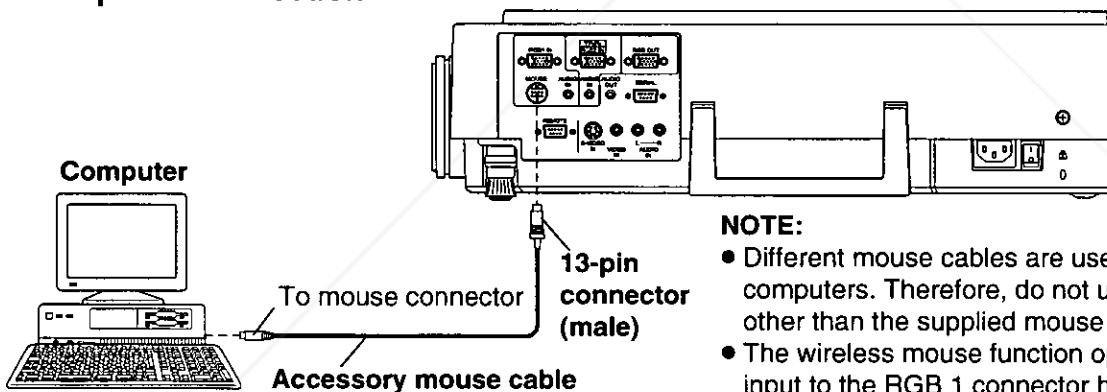

#### NOTE:

- Different mouse cables are used for different types of computers. Therefore, do not use any mouse cables other than the supplied mouse cables.
- The wireless mouse function operates only when input to the RGB 1 connector has been selected.

### Operation

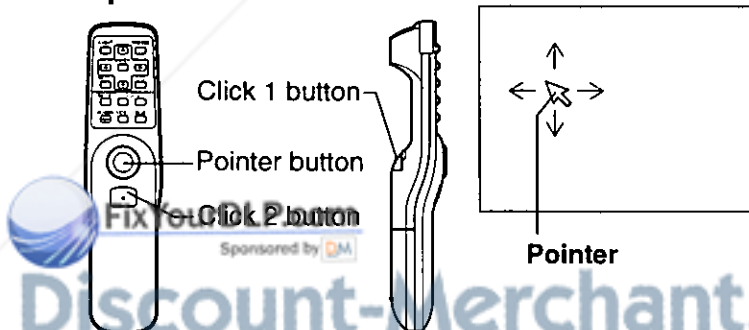

#### • Pointer button

While gently pressing the pointer button with your thumb, push the pointer button back and forward and to the left and right. The pointer (arrow) will move back and forward and to the left and right on the screen.

#### • Click 1 button

This button corresponds to the button on a single-button mouse, or to the left button on a standard mouse with two buttons.

#### • Click 2 button

This button corresponds to the right button on a standard mouse with two buttons.

Discount-Merchant.com (800) 281-6060  
THE TRUSTED SOURCE FOR PROJECTOR LAMPS AND ACCESSORIES

# Using the SERIAL connector

The serial connector which is on the side terminal board of the projector conforms to the RS-232C interface specification, so that the projector can be controlled by a personal computer which is connected to this connector.

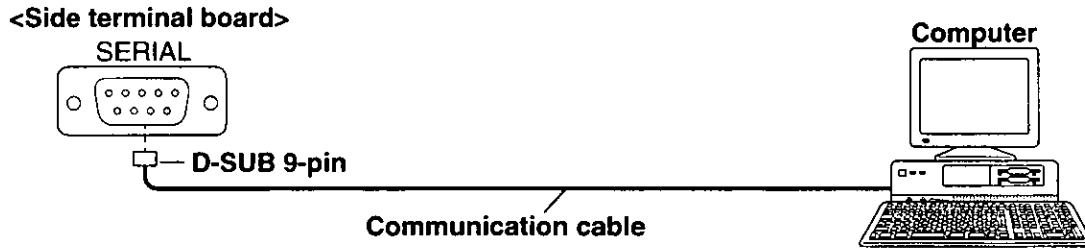

## NOTE:

- Use a proper communication cable which is suitable for the personal computer to connect the serial connector and the personal computer.

## Pin layout and signal names for SERIAL connector

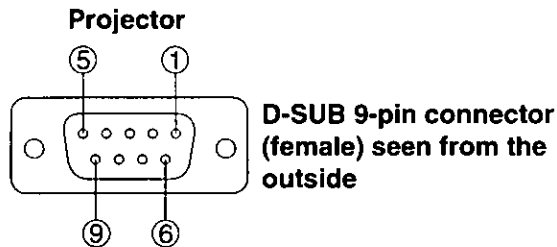

Pin No.	Signal name	Contents
①		NC
②	TXD	Transmitted data
③	RXD	Received data
④		Connected internally
⑤	GND	GND
⑥		NC
⑦	CTS	Connected internally
⑧	RTS	
⑨		NC

## Communication settings

Signal level	Determined by the RS-232C interface
Synchronizing method	Asynchronous
Baud rate	9600 bps
Parity	None
Character length	8 bits
Stop bit	1 bit
X parameter	None
S parameter	None

## Basic format

Each packet which is sent from the computer starts with STX. Following this is the command itself and the parameters for that command (if any), and the packet then ends with ETX. Add parameters when necessary according to the control contents.

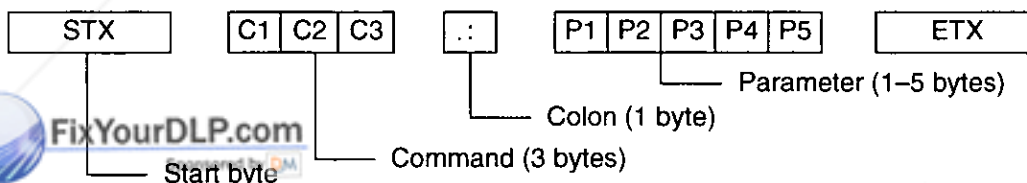

## NOTE:

- If sending multiple commands, check that a response has been received from the projector for one command before sending the next command. When a command which do not require parameters is sent, the colon (:) is not required.
- If an incorrect command is sent from the personal computer, the "ER401" command will be sent from the projector to the personal computer.
- If you are using the REMOTE connector to control the projector externally, commands sent to the SERIAL connector will no longer be accepted.

## Control commands

The commands which the personal computer can use to control the projector are shown in the following table.

Command	Control Contents	Remarks
PON	Power ON	In standby mode, all commands other than the PON command are ignored. • The PON command is ignored during lamp ON control. • If a PON command is received while the cooling fan is operating after the lamps have switched off, the lamps are not turned back on again until approximately 40 seconds have passed since they turned off, in order to protect the lamps.
POF	Power OFF	
AVL	Volume	Parameter 000 = Adjustment value 0 : 063 = Adjustment value 63
AMT	Mute (Picture mute)	Parameter 0 = MUTE OFF 1 = MUTE ON • If the picture mute function is on, this command can be used to toggle the video mute on and off.
IIS	Input signal selection	Parameter VID=VIDEO      SVD=S-VIDEO RG1=RGB1      RG2=RGB2
ORF	RGB2 format selection	0=RGB      1=YPrPb
QSS	Lamp ON condition query	Parameter 0 = Standby 1 = Lamp ON control active 2 = Lamp ON 3 = Lamp OFF control active
QLS	Lamp ON check query	Parameter 0 = Both lamps 1 and 2 are OFF 1 = Only lamp 1 is ON 2 = Only lamp 2 is ON 3 = Both lamps 1 and 2 are ON

### Cable specifications

### At the projector

### At the computer (DTE specifications)

1	NC	NC	1
2			2
3			3
4	NC	NC	4
5			5
6	NC	NC	6
7			7
8			8
9	NC	NC	9



Discount-Merchant.com (800) 281-8860  
 THE TRUSTED SOURCE FOR PROJECTOR LAMPS AND ACCESSORIES

# Using the REMOTE connector

You can use the REMOTE connector which is built into this projector to operate the projector remotely using an operation panel which is located at a distance from the place where the projector has been set up.

## Setting-up example

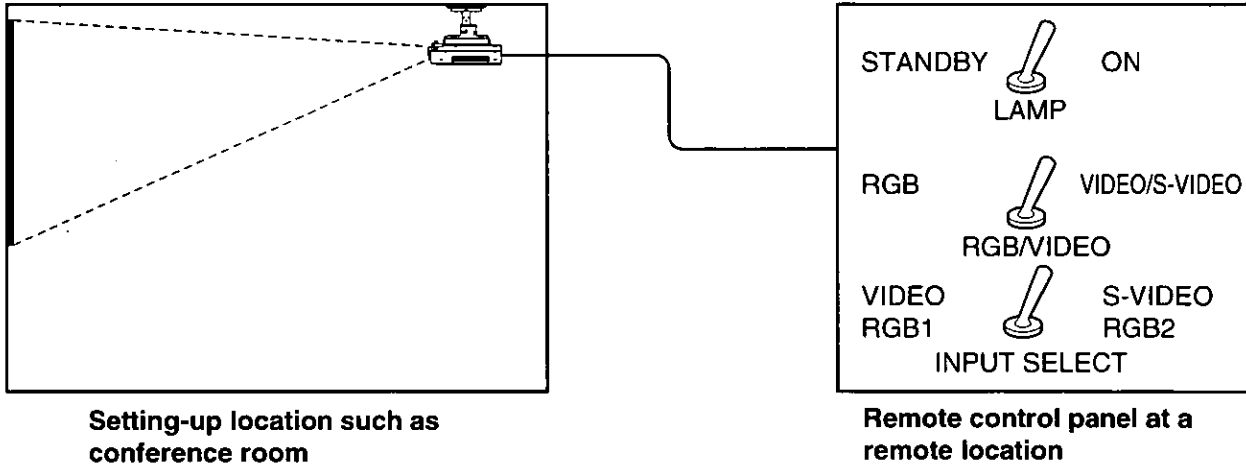

## Pin layout and signal names for the SERIAL connector

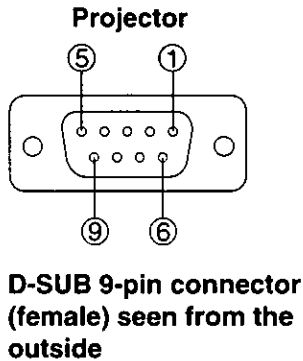

Pin No.	Pin Name	Details	
		Shorted to ①	Open
②	Lamp ON	On	Off (Standby)
③	RGB/VIDEO	VIDEO(S-VIDEO)	RGB
⑤	Input select	*1	S-VIDEO
		*2	RGB2
			VIDEO
			RGB1

\*1: When ③ is VIDEO  
\*2: When ③ is RGB

### NOTE:

- Do not short pins ①, ②, ③ and ⑤ while pin ④ is still open, otherwise the projector will not be able to receive any signals from the remote control panel.





**Discount-Merchant.com (800) 281-8860**  
THE TRUSTED SOURCE FOR PROJECTOR LAMPS AND ACCESSORIES

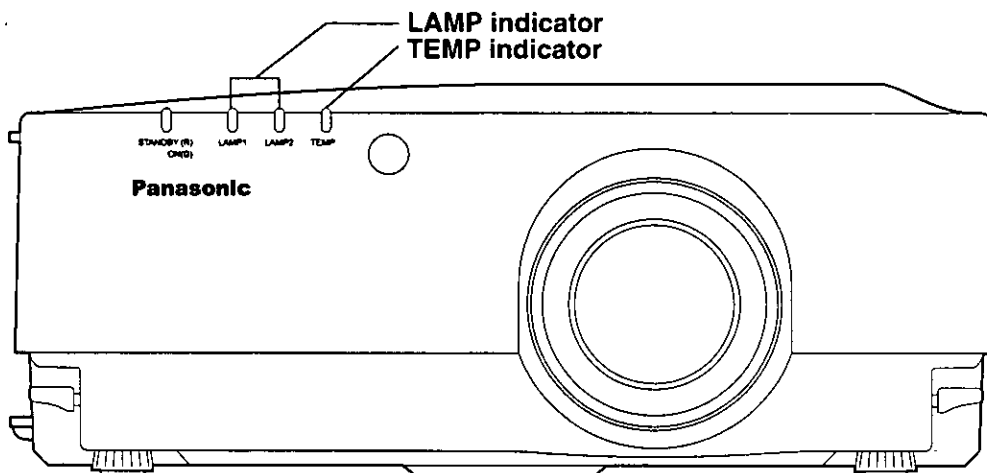

# Indicators

There are two indicators on the front of the projector which give information about the operating condition of the projector. These indicators illuminate or flash to warn you about problems that have occurred inside the projector, so if you notice that one of the indicators is on, turn off the power and check the table below for the cause of the problem.



Indicator name	Indicator display	Problem	Possible cause	Remedy
TEMP indicator 	Illuminated (red) (Lamp(s) ON)	The internal projector temperature is too high.	<ul style="list-style-type: none"> <li>The ventilation holes may be covered.</li> <li>The ambient temperature in the place of use may be too high.</li> <li>The air filter may be blocked.</li> </ul>	<ul style="list-style-type: none"> <li>Uncover the ventilation holes.</li> <li>Set up the projector in a place where the temperature is between 32°F (0°C) and 104°F (40°C) and the humidity is between 20% and 80% (with no condensation).</li> <li>Turn off the main power supply by following the procedure on page 15, and then clean the air filter (refer to page 48).</li> </ul>
	Flashing (red) (Lamp(s) OFF)	Lamp(s) have turned off automatically because the internal temperature has risen to an abnormally high level.		
	Illuminated (red) (Lamp(s) OFF)	Lamp(s) have turned off (switched to the standby condition) automatically because the internal temperature has become abnormally high or a sudden temperature change has occurred.		
LAMP indicator 	Illuminated (red)	It is nearly time to replace the lamp unit.	Does "REPLACE LAMP" appear on the screen after the projector is turned on?	This occurs when the operation time for the lamp unit is nearing 1,800 hours. Ask your dealer or an Authorized Service Center to replace the lamp unit.
	Flashing (red)	The lamp switches off automatically.	The power may have been turned on immediately after it was turned off.  There may be an abnormality in the lamp circuit.	Wait for a while until the lamp unit cools down before turning the power back on again.  Turn off the main power supply by following the procedure on page 15, and then contact an Authorized Service Center.

**NOTE:**

- Be sure to turn off the main power by following the procedure given in "Turning the power on and off" on page 15 before carrying out any of the procedures in the "Remedy" column.
- If the main power turns off after the TEMP indicator starts flashing, it means that an abnormality has occurred. Please contact an Authorized Service Center so that the necessary repairs can be made.

# Cleaning the air filter

If the air filter becomes clogged with dust, the internal temperature of the projector will rise, the TEMP indicator will flash and the projector will be switched automatically to standby mode.

## Cleaning procedure

### 1. Turn off the main power supply and disconnect the power cord plug from the wall outlet.

Turn off the main power supply according to the procedure given in "Turning off the power" on page 15 before disconnecting the plug from the wall outlet.

### 2. Place the projector on top of a blanket so that it will not become scratched.

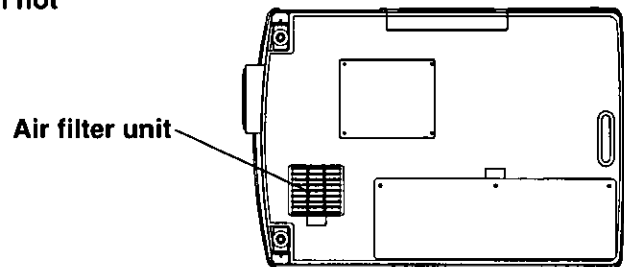

### 3. Remove the air filter cover.

Hold the indents on the air filter cover with your hands and pull the air filter unit out of the projector.

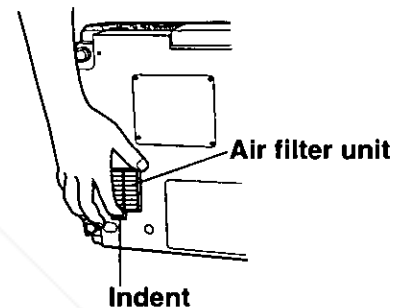

### 4. Clean the air filter.

Use a vacuum cleaner to clean off any accumulated dust.

#### NOTE:

- Be careful not to let the air filter get drawn into the vacuum cleaner.



### 5. Install the air filter and the air filter cover.

Place the air filter into the air filter cover, and then slide the air filter cover into the projector until the hollows in the air filter cover are aligned with the hollows in the projector.

#### NOTE:

- Be sure to install the air filter cover before using the projector.

If the projector is used without the air filter cover installed, dust and other foreign particles will be drawn into the projector, and malfunctions will result.

#### NOTE:

- If the dust cannot be removed by cleaning, it is time to replace the air filter. Please consult the place of purchase. Furthermore, if the lamp unit is being replaced, replace the air filter at this time also.

# Lamp unit replacement period

The lamp used as the light source must be replaced after approximately 1,800 hours of use. If the lamp is not replaced after the cumulative usage time has passed 2,000 hours, the projector will automatically switch to standby mode.

- **Screen display once cumulative usage time exceeds 1,800 hours**

If you continue to use the lamp unit after 1,800 hours of total usage time have passed, the on-screen display shown at right will appear as a reminder each time the projector is turned on. This display will continue to appear until a button is pressed.

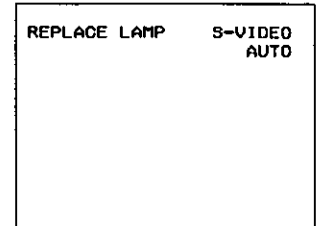

## Replacing the lamp unit

### Notes on replacing the lamp unit

- Because the lamp unit in this projector incorporates a UHM lamp, the temperature inside the lamp rises during use and the lamp becomes very hot. After turning off the MAIN POWER switch and disconnecting the power cord from the wall socket, wait for the lamp to cool down before replacing the lamp unit.
- Take extreme care when handling the removed lamp unit, as it contains gas under high pressure and can easily become damaged if it is struck against hard objects or dropped.
- The old lamp unit may shatter if it is handled roughly after removal. Ask an authorized waste disposal agency to dispose of the old lamp unit.
- A Phillips screwdriver is necessary for removing the lamp unit. Make sure that your hands are not slippery when using the screwdriver.

### NOTE:

- The projector is not supplied with a replacement lamp unit. Please ask your dealer for details.  
Lamp unit product no.: ET-LA097N (with one unit) ET-LA097NW (with two units)

**CAUTION:** Do not use any lamp unit other than the one with the product number indicated above.

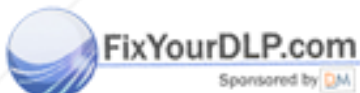

**Discount-Merchant.com (800) 281-8860**  
**THE TRUSTED SOURCE FOR PROJECTOR LAMPS AND ACCESSORIES**

## □ Replacement procedure

### NOTE:

- If the lamp unit is replaced after it has been used for more than 2,000 hours, the projector will switch to standby mode after approximately 10 minutes of operation. Steps 6. to 9. on the following page should thus be completed within 10 minutes.

1. Disconnect the power cord plug from the wall outlet and check that the area around the lamp unit has cooled down.

2. Use a Phillips screwdriver to remove the screws which attach the lamp unit cover to the bottom of the projector, and then remove the lamp unit cover.

### NOTE:

- Read the CAUTION on the lamp unit cover before continuing.

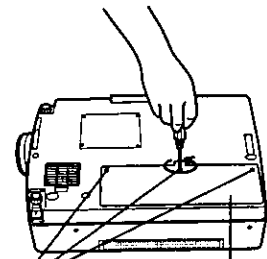

Attachment screws for the lamp unit cover

Lamp unit cover

3. Use a Phillips screwdriver to turn the two lamp unit attachment screws until they turn freely. Hold the handle which is attached to the lamp unit and gently pull the lamp unit out from the projector.

### CAUTION:

- The lamp unit will be hot after it has been used, and you might receive burns if you touch it while it is still hot.

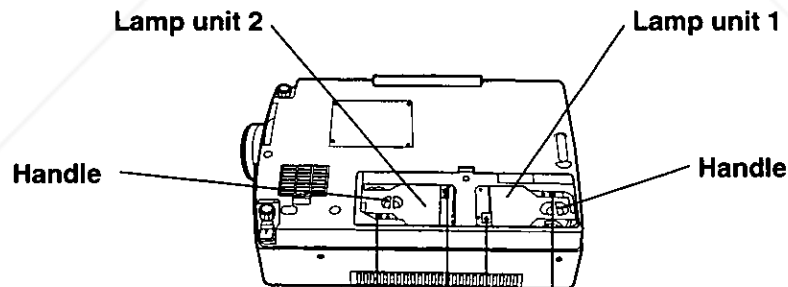

Attachment screws for Lamp Unit 2

Attachment screws for Lamp Unit 1

4. Insert the new lamp unit, while making sure that the direction of insertion is correct, and then use a Phillips screwdriver to turn the lamp unit attachment screws until they are securely tightened.

5. Securely install the lamp unit cover, and then securely tighten the screws that attach it.

### NOTE:

- Be sure to install the lamp unit and the lamp unit cover securely. If they are not securely installed, it may cause the protection circuit to operate so that the power cannot be turned on.

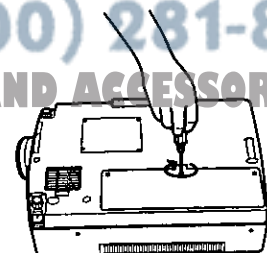

6. Insert the power cord plug into the wall outlet and then press the MAIN POWER switch to turn on the power.

**NOTE:**

- If the power does not turn on when the MAIN POWER switch is pressed, turn the MAIN POWER switch off again and check that the lamp unit and the lamp unit cover are securely installed. Then turn the MAIN POWER switch back on.

7. Press the POWER button on the projector or remote control unit so that a picture is projected onto the screen.

8. (1) Press the MENU button to display the MENU screen.

(2) Press the “▲” and “▼” buttons to select “OPTION”.

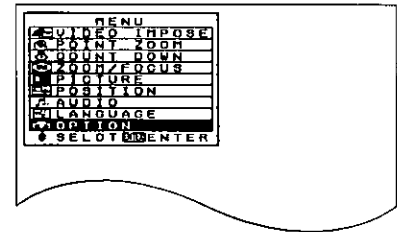

9. (1) Press the ENTER button. ... The OPTION screen will be displayed.

(2) Press the “◀” or “▶” button to move the cursor to LAMP RUNTIME.

(3) Press and hold the ENTER button on the projector control panel for three seconds or more. ... LAMP TIME will change to show L1 RESET [POWER OFF] or L2 RESET [POWER OFF].

(4) Press the “◀” or “▶” button to change the setting to the lamp which is being replaced.

L1 RESET: When replacing lamp 1

L2 RESET: When replacing lamp 2

L1 + L2 RESET: When replacing both lamp 1 and lamp 2

**NOTE:**

- This operation will not work if the ENTER button on the remote control unit is pressed in step (3) above.
- If the MENU button is pressed, the lamp time resetting screen will be canceled, and the display will return to the previous screen or the MENU screen will be cleared.

(5) Press the POWER button to turn off the power. The cumulative time for the lamp unit(s) replaced will then be reset to zero.

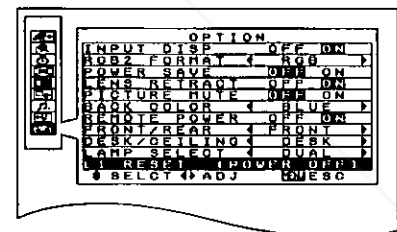
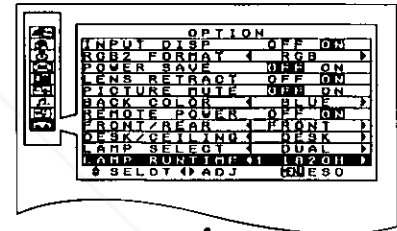

## Before asking for service, check the following points.

Problem	Possible cause
Power does not turn on.	<ul style="list-style-type: none"> <li>● The power cord is not connected.</li> <li>● The main power switch on the projector is turned off.</li> <li>● The main power supply is not being supplied to the wall outlet.</li> <li>● TEMP indicator is illuminated or flashing. Correct the problem while referring to the instructions on page 47.</li> <li>● LAMP indicator is illuminated or flashing. Correct the problem while referring to the instructions on page 47.</li> <li>● The lamp unit cover has not been correctly installed.</li> <li>● The REMOTE POWER function has been set to "OFF". (Refer to page 35.)</li> </ul>
No picture appears.	<ul style="list-style-type: none"> <li>● The lens cap may still be attached to the lens.</li> <li>● The video signal input source may not be connected properly.</li> <li>● The input selection setting may not be correct. (Refer to page 21.)</li> <li>● The BRIGHT adjustment setting may be at the minimum possible setting. (Refer to page 26.)</li> <li>● The PICTURE MUTE function has been set to "ON". (Refer to page 38.)</li> <li>● The power save function has activated. (Refer to page 37.)</li> </ul>
The picture is fuzzy.	<ul style="list-style-type: none"> <li>● The lens focus may not have been set correctly, or the projector may not be at the correct distance from the screen. (Refer to pages 16 and 19.)</li> <li>● The lens may be dirty.</li> <li>● The projector may not be set up so that it is perpendicular to the screen. (Refer to page 16.)</li> </ul>
COLOR is too light or TINT is poor.	<ul style="list-style-type: none"> <li>● COLOR or TINT adjustment may be incorrect. (Refer to page 26.)</li> <li>● The input source which is connected to the projector may not be adjusted correctly.</li> </ul>
No sound can be heard.	<ul style="list-style-type: none"> <li>● The audio signal source may not be connected properly.</li> <li>● The volume adjustment may be at the lowest possible setting. (Refer to pages 24 and 28.)</li> <li>● The MUTE function may be active. (Refer to pages 25 and 38.)</li> </ul>
Remote control unit does not operate.	<ul style="list-style-type: none"> <li>● The batteries may be spent, or they may not be inserted correctly. (Refer to page 11.)</li> <li>● There may be an object between the remote control unit and the projector which is blocking the infrared signals. (Refer to page 12.)</li> <li>● The remote control unit may be out of the operation range. (Refer to page 12.)</li> <li>● Is the REMOTE connector being used to carry out external control? (Refer to page 46.)</li> </ul>
The picture does not display correctly.	<ul style="list-style-type: none"> <li>● The correct input signal may not be selected. (Refer to page 21.)</li> <li>● The input signal setting mode (TV-SYSTEM) may not be set correctly. (Refer to page 23.)</li> <li>● There may be a problem with the VCR tape or other signal source.</li> </ul>



**Discount-Merchant.com (800) 281-8860**  
**THE TRUSTED SOURCE FOR PROJECTOR LAMPS AND ACCESSORIES**

# Specifications

Power supply:	100–240 V ~, 50/60 Hz
Power consumption:	480 W (During stand by (when fan is stopped): Max.10 W)
Max amps:	5.5–2.5 A
LCD panel:	
Micro lens array (MLA):	Available
PT-L797PWU:	Not available
PT-L797VU/PT-L597U:	1.3"
Panel size (diagonal):	3 transparent LCD panels (RGB)
Display method:	Active matrix method
Drive method:	
Pixels:	
PT-L797PWU/PT-L797VU:	786,432(1024 × 768) × 3 panels
PT-L597U:	480,000(800 × 600) × 3 panels
Lens:	Electronic zoom / focus lens (1:1–1.3)
	Retractable lens mechanism
PT-L797PWU:	F 2.0–2.2, f 59.6–74.5
PT-L797VU/PT-L597U:	F 2.7–3.0, f 59.0–75.9
Lamp:	Two UHM lamps (160 W × 2)
Luminosity:	
PT-L797PWU:	2200 lm/ANSI
PT-L597U:	1700 lm/ANSI
PT-L797VU:	1500 lm/ANSI
Scanning frequency:	

	PT-L797PWU PT-L797VU	PT-L597U
VIDEO S-VIDEO	H 15.75/15.63 kHz V 50/60 Hz	
RGB (Dot clock)	H 15–94 kHz V 50–120 Hz (135 MHz or less)	H 15–81 kHz V 50–100 Hz (110 MHz or less)

YP <sub>B</sub> P <sub>R</sub> signals:	NTSC(480i), 480p, PAL(625i), 720p, HDTV(1080i)
Color system:	6(NTSC/NTSC 4.43/PAL/PAL-M/PAL-N/SECAM)
Projection size (diagonal):	30–300 inches
Throw distance:	
PT-L797PWU:	4'4"–55'9" (1.3–17.0 m)
PT-L797VU/PT-L597U:	4'3"–56'1" (1.3–17.1 m)
Optical axis shift:	10/10–0/10
Screen aspect ratio:	4:3
Installation:	Front/Rear (Menu selection method)
Speaker:	1 9/16" × 1 1/8" (4 cm × 2.85 cm) ellipse × 2 (stereo)
Max. usable volume output:	4W (2 W + 2 W) (10% THD)
Connection terminals:	

RGB1 IN:	Single-line D-SUB HD 15-pin (female)
R.G.B.:	0.7 Vp-p (1.0 Vp-p at G-SYNC signal) , 75 Ω
HD/SYNC:	TTL high impedance, automatic plus/minus polarity compatible
VD:	TTL high impedance, automatic plus/minus polarity compatible
RGB2/YP <sub>B</sub> P <sub>R</sub> IN:	Single-line D-SUB HD 15-pin (female)
Y:	1.0 Vp-p, 75 Ω
P <sub>B</sub> P <sub>R</sub> :	±0.35 Vp-p, 75 Ω
R.G.B.:	0.7 Vp-p (1.0 Vp-p at G-SYNC signal) , 75 Ω
HD/SYNC:	TTL high impedance, automatic plus/minus polarity compatible
VD:	TTL high impedance, automatic plus/minus polarity compatible

RGB OUT:	Single-line D-SUB HD 15-pin (female)
Y:	1.0 Vp-p, 75 Ω
P <sub>B</sub> P <sub>R</sub> :	±0.35 Vp-p, 75 Ω
R.G.B.:	0.7 Vp-p (1.0 Vp-p at G-SYNC signal), 75 Ω
HD:	TTL high-impedance
VD:	TTL high-impedance
AUDIO IN:	Double-line 0.5 Vrms M3 jack (Stereo MINI)
S-VIDEO IN:	Single-line, Mini DIN 4-pin Y1.0 Vp-p, C 0.286Vp-p, 75 Ω
VIDEO IN:	Single-line, RCA pin jack 1.0 Vp-p, 75 Ω
AUDIO IN L-R:	0.5 Vrms RCA pin jack × 2 (L-R)
AUDIO OUT terminal:	M3 jack (Stereo MINI) × 1 (monitoring output and stereo compatible) 0–2.0 Vrms (variable)
SERIAL input connector:	D-SUB 9-pin (female) For computer-controlled operation
REMOTE connector:	D-sub 9-pin (female) For external control
MOUSE input connector:	13-pin round connector For wireless mouse function (PS/2, Macintosh and serial computer compatible)
Power cord length:	9'6" (2.9 m)
Cabinet:	Magnesium alloy
Dimensions:	
Width:	13 <sup>1</sup> / <sub>16</sub> " (332 mm)
Height:	5 <sup>9</sup> / <sub>32</sub> " (134 mm)
Length:	18 <sup>1</sup> / <sub>2</sub> " (470 mm) (not including lens extension length)
Weight:	
PT-L797PWU:	20.3 lbs. (9.2 kg)
PT-L797VU/PT-L597U:	19.6 lbs. (8.9 kg)
Operating environment:	
Temperature:	32°F–104°F (0–40°C)
Humidity:	20–80% (no condensation)
Certifications:	UL1950, C-UL FCC
<Remote control unit>	
Power supply:	3 V DC (two AA-size batteries)
Operation range:	23.0' (Approx. 7 m) (When operated from directly in front of the signal receptor)
Weight:	0.225 lbs. (Approx. 102g) (with batteries)
Dimensions:	
Width:	1 <sup>13</sup> / <sub>16</sub> " (46 mm)
Height:	1 <sup>11</sup> / <sub>32</sub> " (34 mm)
Length:	7 <sup>17</sup> / <sub>32</sub> " (191 mm)

- ◆ Design and specifications are subject to change without notice. Weight and dimensions shown are approximate.



## Trademark acknowledgements

- PS/2, VGA and XGA are trademarks of International Business Machines Corporation.
- Macintosh is a registered trademark of Apple Computer, Inc.
- PC-98 is a trademark of NEC Corporation.
- S-VGA is a registered trademark of the Video Electronics Standards Association.
- Windows is a registered trademark of Microsoft Corporation.

All other trademarks are the property of the various trademark owners.



# Accessories

Remote control unit (TNQE126-2):

AA-size batteries:

Power cord (TSXA053):

VGA cable (TSXF163):

Macintosh adapter (TJSF39100):

D-sub 15 – BNC 5 adapter cable (TSXF189):

Video/Audio cable (TSXF015):

PS/2 mouse cable (TSXF096):

Macintosh mouse cable (TSXF105):

Serial mouse cable (TSXF106):

PC audio cable (TSXF150):

Lens cap (TKKL5077):

Optional accessories:

1

2

1 (125 V, 10 A)

1 (6'7" [2.0 m], D-SUB HD 15-pin [male] ↔ D-SUB HD 15-pin [male])

1 (D-SUB HD 15-pin [female] ↔ D-SUB 15-pin [male])

1 (1'8" [0.5 m], D-SUB HD 15-pin [male] ↔ BNC jack [female])

1 (4'11" [1.5 m], RCA pin)

1 (6'7" [2.0 m], 13-pin round [male] ↔ DIN 6-pin [male])

1 (6'7" [2.0 m], 13-pin round [male] ↔ mini DIN 4-pin [male])

1 (6'7" [2.0 m], 13-pin round [male] ↔ D-SUB 9-pin [male])

1 (2.0 m [6'7"], M3 stereo mini plug)

1

CEILING MOUNT BRACKET ET-PK097

# Dimensions

UNIT: inch(mm)

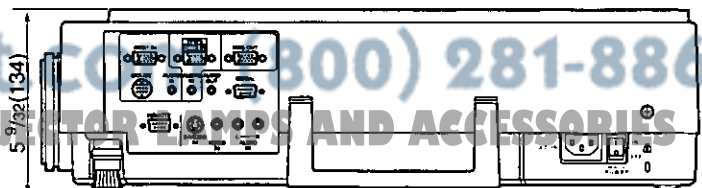
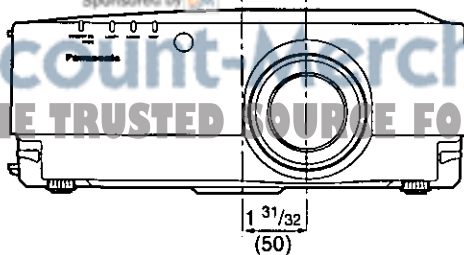
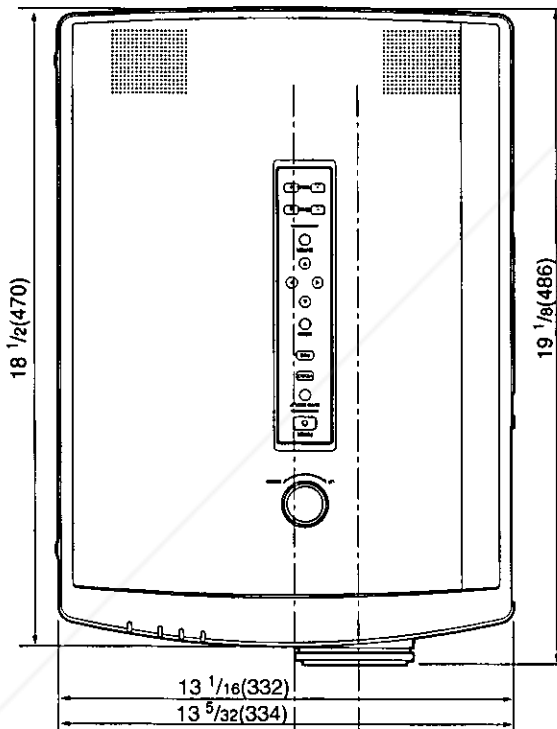

FixYourDLP.com  
Sponsored by DM

Discount-Merchants.com (800) 281-8860  
THE TRUSTED SOURCE FOR PROJECTORS AND ACCESSORIES

# NOTES IMPORTANTES CONCERNANT LA SÉCURITÉ

**AVERTISSEMENT:** Afin d'éviter des dommages qui risquent de causer un incendie ou des chocs électriques, ne pas exposer cet appareil à la pluie ou à l'humidité.

**Alimentation:** Ce projecteur LCD est conçu pour fonctionner sur secteur de 100-240 volts, 50/60 Hz seulement.

**ATTENTION:** Le cordon d'alimentation secteur fourni avec le projecteur peut être utilisé uniquement pour une alimentation électrique de 125 V, 10 A maximum. Si on veut l'utiliser avec une tension ou un courant plus forts, on doit se procurer un autre cordon d'alimentation de 250 V. Si on utilise le



Le symbole de la flèche en forme d'éclair, dans un triangle, avertit l'utilisateur de la présence de "tensions dangereuses" à l'intérieur du produit qui peuvent être de force suffisante pour constituer un risque de choc électrique aux personnes.



Le point d'exclamation dans un triangle avertit l'utilisateur de la présence d'instructions importantes concernant l'utilisation et l'entretien (réparation) dans la littérature accompagnant le produit.

**ATTENTION:** Cet appareil est équipé d'une fiche de courant à trois broches avec mise à la terre. Ne pas retirer la broche de mise à la masse de la fiche. Cette fiche ne pourra être utilisée que dans une prise avec mise à la terre. Ceci est une précaution sécuritaire. S'il est impossible d'insérer la fiche dans la prise, s'adresser à un électricien. Ne pas annuler la protection de la fiche à mise à la terre.

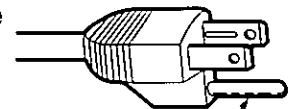

Ne pas retirer

# Précautions concernant la sécurité

## AVERTISSEMENT

### Installation

**Ne pas installer ce projecteur dans un endroit qui n'est pas assez résistant pour supporter le poids du projecteur.**

- Si l'emplacement d'installation n'est pas assez résistant, le projecteur risque de tomber et causer de graves blessures et (ou) des dommages.

**Demander à un technicien qualifié d'installer le projecteur par exemple s'il est installé au plafond.**

- Si l'installation n'est pas faite correctement, cela peut entraîner des blessures ou des chocs électriques.

### Lors de l'utilisation du projecteur

**Ne pas placer le projecteur sur des surfaces inclinées ou instables.**

- Le projecteur risque de tomber ou de glisser.

**Ne rien placer sur le projecteur.**

- Si de l'eau se renverse sur le projecteur ou des objets entrent dans le projecteur, s'adresser à un centre technique agréé.

**Ne pas couvrir le filtre et la sortie d'air.**

- Cela risque de faire surchauffer le projecteur, et causer un incendie ou endommager le projecteur.

**Ne pas mettre d'objets étrangers dans le projecteur.**

- Ne pas insérer d'objets métalliques ou inflammables dans les orifices de ventilation ou les faire tomber sur le projecteur, car cela peut causer un incendie ou des chocs électriques.

**Ne pas retirer le couvercle ou le modifier.**

- Des hautes tensions qui peuvent causer de graves blessures sont présentes à l'intérieur du projecteur. Pour toute inspection, réglage ou réparation, s'adresser à un centre technique agréé.

**Ne pas renverser d'eau sur le projecteur.**

- Cela peut causer un incendie ou des chocs électriques.

**Brancher la prise d'alimentation complètement.**

- Si la fiche n'est pas complètement insérée, cela peut la faire surchauffer et causer un incendie. Si la fiche est endommagée ou la plaque de la prise est desserrée, elles ne devraient pas être utilisées.

**Ne pas manipuler le cordon d'alimentation avec les mains mouillées.**

- Cela peut entraîner des chocs électriques.

**Faire attention de ne pas endommager le cordon d'alimentation.**

- Ne pas endommager le cordon d'alimentation, ne pas le modifier, ne pas placer d'objets lourds, ne pas le chauffer, ne pas le placer près d'objets chauffants, ne pas le tordre, ne pas le plier ou le tirer excessivement. Cela peut entraîner un incendie et des chocs électriques. Si le cordon d'alimentation est endommagé, le faire réparer par un centre technique agréé.

**Nettoyer le cordon d'alimentation régulièrement afin d'éviter toute accumulation de poussière.**

- Si de la poussière s'accumule sur le cordon d'alimentation, l'humidité peut endommager l'isolant et entraîner un incendie. Débrancher le cordon d'alimentation de la prise de courant et l'essuyer avec un chiffon sec.
- Si le projecteur ne sera pas utilisé pendant une période prolongée, débrancher le cordon d'alimentation de la prise de courant.

### En cas de problème pendant l'utilisation

**En cas de problème (pas d'image ou de son), ou si le projecteur dégage de la fumée ou une odeur étrange débrancher immédiatement la fiche d'alimentation de la prise de courant.**

- Si l'on continue d'utiliser le projecteur dans cette condition, cela peut entraîner un incendie ou des chocs électriques. Après s'être assuré que de la fumée ne se dégage plus, s'adresser à un centre technique agréé et demander que les réparations nécessaires soient faites. Le fait de réparer le projecteur soi-même est très dangereux, et ne doit jamais être fait.

**Si de l'eau ou des objets étrangers entrent dans le projecteur, si le projecteur tombe, ou si le boîtier est endommagé, débrancher immédiatement la fiche d'alimentation de la prise de courant.**

- Un court-circuit peut se produire et causer un incendie. S'adresser à un centre technique agréé pour que les réparations nécessaires puissent être faites.

## PRÉCAUTION

### Lors de l'utilisation du projecteur

**Ne pas utiliser le projecteur là où il sera sujet à l'humidité, la poussière, la vapeur d'huile ou de la vapeur.**

- Cela peut causer des chocs électriques.

**Ne pas placer d'objets lourds sur le projecteur.**

- Cela peut déséquilibrer le projecteur et le faire tomber, ce qui peut entraîner des dommages et/ou des blessures.

**Ne pas regarder directement dans la lentille pendant que le projecteur fonctionne.**

- Une lumière intense est émise par la lentille du projecteur. Si l'on regarde directement dans cette lumière, elle risque de causer de graves lésions.

**Ne pas placer ses mains ou autres objets près de la sortie d'air.**

- De l'air chaud sort par l'ouverture de sortie d'air. Ne pas placer les mains ou la figure, ou d'autres objets qui ne peuvent résister à la chaleur près de cette sortie d'air, sinon cela peut causer des blessures ou une déformation.

**Lors du débranchement du cordon d'alimentation, tenir la fiche, et non pas le cordon.**

- Si l'on tire sur le cordon, cela risque de l'endommager entraînant la possibilité d'un incendie ou de chocs électriques graves.

**S'assurer de débrancher tous les câbles avant de déplacer le projecteur.**

- Si le projecteur est déplacé avec des câbles encore branchés, cela peut les endommager et entraîner un incendie ou des chocs électriques.

### Nettoyage et entretien

**Faire attention lors du remplacement du bloc de lampe.**

- La lampe contient du gaz sous haute pression. Si elle tombe ou si elle est cognée, elle risque de se casser, ce qui peut causer des blessures ou des problèmes de fonctionnement.

**Demander à un centre technique agréé de nettoyer l'intérieur du projecteur au moins une fois par an.**

- S'il n'est pas nettoyé et que la poussière s'accumule à l'intérieur du projecteur, cela peut causer un incendie ou des problèmes de fonctionnement. Se renseigner auprès du centre technique agréé pour le coût du nettoyage.

**Avant de nettoyer le projecteur, débrancher le cordon d'alimentation.**

- Sinon, cela peut causer des chocs électriques.



**Discount-Merchant.com (800) 281-8860**  
**THE TRUSTED SOURCE FOR PROJECTOR LAMPS AND ACCESSORIES**

# Précautions concernant la manipulation

## Avertissements concernant l'installation

Respecter les points suivants à chaque installation du projecteur.

- Éviter l'installation dans des endroits sujets à vibrations ou chocs.  
Si le projecteur est installé dans des endroits sujets à vibrations, comme près d'un moteur, ou s'il est installé à l'intérieur d'un véhicule ou sur un bateau, le projecteur peut être soumis à des vibrations ou chocs qui peuvent endommager les composantes internes et causer un mauvais fonctionnement ou des accidents. Installer donc le projecteur dans un endroit qui n'est pas sujet à vibrations ou chocs.
- Ne pas installer le projecteur près de lignes à haute-tension ou près de moteurs.  
Le projecteur peut être affecté par des interférences électromagnétiques s'il est installé près de lignes à haute-tension ou près de moteurs.
- Ne pas installer le projecteur directement sur une feuille en plastique ou sur un tapis.  
La feuille de plastique peut coller au filtre à air, ce qui peut causer une surchauffe interne du projecteur et déclencher la coupure de l'alimentation.
- Si le projecteur est installé au plafond, demander à un technicien qualifié de faire l'installation.  
Si le projecteur doit être installé au plafond, il faudra se procurer un ensemble d'installation vendu séparément (Modèle ET-PK097). De plus, l'installation doit être entièrement réalisée par un technicien qualifié.
- Ne pas installer le projecteur à proximité de sources d'éclairage intense telles que des lampes fluorescentes.  
Si le récepteur de signal de télécommande est éclairé par une lumière intense telle que celle provenant de lampes fluorescentes, le fonctionnement de la télécommande risquera d'être perturbé. Eloigner le projecteur le plus possible de telles sources d'éclairage.

## Remarques concernant l'utilisation

- Afin d'obtenir la meilleure qualité possible d'image  
Si la lumière du jour ou la lumière de lampes d'éclairage éclaire l'écran, les images projetées n'auront pas le contraste adéquat. Fermer les rideaux des fenêtres, éteindre les éclairages fluorescents près de l'écran et couvrir tout plancher ou mur à haute réflexion de tapis ou papier peint pour éviter la réflexion.
- Ne pas toucher la surface de lentille avec les mains nues.  
Ne pas toucher à la lentille avec les mains nues. Si la surface de la lentille porte des traces de doigts ou autre, elles seront projetées sur l'écran. De plus, ne pas oublier de rétracter la lentille et la couvrir avec le protecteur fourni lorsque le projecteur n'est pas utilisé.
- À propos de l'écran  
Si l'écran utilisé est sale, endommagé ou décoloré, la qualité de l'image s'en ressentira. Ne pas appliquer de produit chimique volatil sur l'écran et ne pas le laisser se salir ou s'endommager.

**Avant de faire toute opération de nettoyage ou d'entretien, s'assurer d'avoir débranché la fiche du cordon d'alimentation de la prise de courant.**

**Essuyer le boîtier avec un chiffon doux et sec.**

Si le boîtier est très sale, tremper le chiffon dans de l'eau avec une petite quantité de détergent neutre, bien essorer le chiffon, puis essuyer le boîtier. Après le nettoyage, sécher le boîtier avec un chiffon doux et sec. Lors de l'utilisation d'un chiffon traité chimiquement, lire les instructions accompagnant le chiffon avant l'utilisation.

**Ne pas essuyer la lentille avec un chiffon poussiéreux ou qui produit de la peluche.**

Si de la poussière ou de la peluche se dépose sur la lentille, cette poussière ou peluche sera grossie et projetée sur l'écran. Utiliser un aspirateur pour retirer toute poussière ou peluche sur les surfaces des lentilles, ou utiliser une peau de chamois pour nettoyer la poussière ou la peluche.

**À propos de la condensation**

Des gouttelettes d'eau se forment sur les fenêtres chauffées rapidement en hiver, et sur l'extérieur de bouteilles sorties du réfrigérateur en été.

Ce phénomène s'appelle la condensation; si de la condensation se produit sur les surfaces de la lentille de projection ou sur le miroir à l'intérieur du projecteur, l'image sera floue ou risque même de ne pas être visible.

Si l'humidité est élevée, ou si le projecteur est déplacé rapidement d'un endroit froid à un endroit chaud, la projection sera arrêtée automatiquement. Dans ce cas, la projection reprendra lorsque le projecteur atteint la température ambiante.

# Période de remplacement de la lampe

La lampe utilisée comme source de lumière doit être remplacée après environ 1800 heures d'utilisation. Si la lampe n'est pas remplacée après que l'utilisation totale atteigne 2000 heures, le projecteur passera automatiquement en mode d'attente.

- **Affichage à l'écran lorsque l'utilisation totale dépasse 1800 heures**

Si l'on continue d'utiliser le bloc de lampe après 1800 heures d'utilisation totale, l'affichage à l'écran indiqué à droite apparaîtra à chaque fois que le projecteur est allumé. Cet affichage restera affiché jusqu'à ce qu'une touche soit pressée.

REEMPLACER LAMPE S-VIDEO  
AUTO

## Remplacement du bloc de lampe

### Remarques concernant le remplacement du bloc de lampe

- Étant donné que le bloc de lampe de ce projecteur utilise une ampoule au UHM, la température interne de la lampe augmente pendant l'utilisation et la lampe devient très chaude. Après avoir mis l'interrupteur MAIN POWER sur OFF et avoir débranché le cordon d'alimentation de la prise de courant, attendre que la lampe se refroidisse avant de remplacer le bloc de lampe.
- Faire très attention lors de la manipulation du bloc de lampe retirée, car elle contient un gaz sous haute pression et peut facilement être endommagée si cognée contre des objets durs ou si elle tombe.
- Le bloc de lampe retirée peut exploser si manipulée rudement après le retrait.  
Demander à une agence de mise au rebut agréée de s'occuper de mettre au rebut le bloc de lampe retirée.
- Un tournevis Phillips sera nécessaire lors du retrait du bloc de lampe. S'assurer que ses mains ne glissent pas lors de l'utilisation du tournevis.

### REMARQUE:

- Un bloc de lampe de remplacement n'est pas fournie avec le projecteur. Pour plus de détails, s'adresser au revendeur.  
No. de produit du bloc de lampe: ET-LA097N (avec un bloc) ET-LA097NW (avec 2 blocs)

**ATTENTION:** Ne pas utiliser un bloc de lampe avec un numéro de pièce autre que celui indiqué ci-dessus.

### □ Remplacement du bloc de lampe

#### REMARQUE:

- Si le bloc de lampe est remplacé après une durée d'utilisation de plus de 2000 heures, le projecteur passera en mode d'attente après environ 10 minutes d'utilisation. Dès lors, faire les étapes 6. à 9. à la page suivante dans les 10 minutes.

1. Débrancher le cordon d'alimentation de la prise de courant et s'assurer que les pièces autour du bloc de lampe se sont refroidies.

Utiliser un tournevis Phillips pour enlever les vis fixant le couvercle du bloc de lampe au bas du projecteur, puis enlever le couvercle du bloc de lampe.

#### REMARQUE:

- Lire ATTENTION sur le couvercle du bloc de lampe avant de continuer.

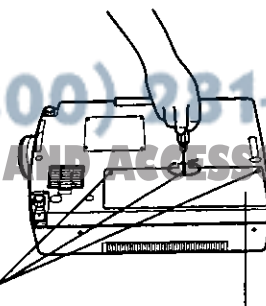

Vis de fixation du couvercle  
du bloc de lampe

Couvercle du bloc de lampe

- Utiliser un tournevis Phillips pour desserrer les deux vis de fixation du bloc de lampe jusqu'à ce qu'elles tournent librement.  
Tenir la poignée fixée au bloc de lampe et tirer doucement le bloc de lampe du projecteur.

**ATTENTION:**

- Le bloc de lampe sera chaude après son utilisation et il est possible de se brûler si on la touche alors qu'elle est encore chaude.

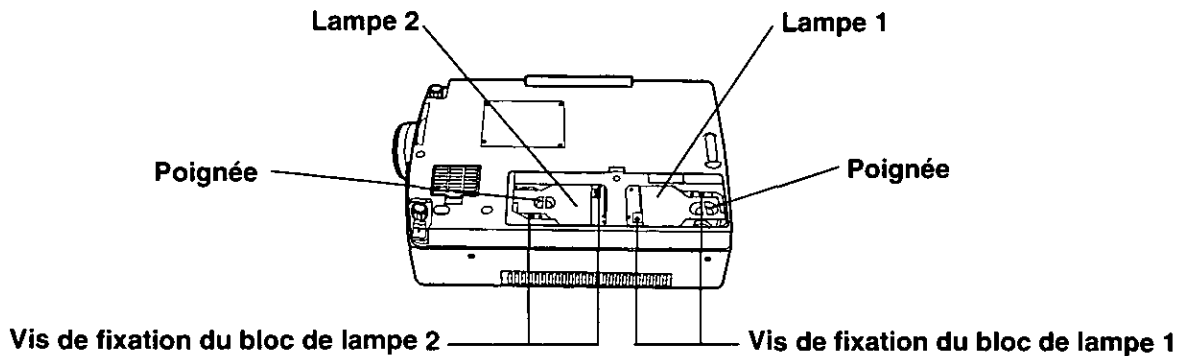

- Insérer le nouveau bloc de lampe, tout en s'assurant que la direction d'insertion est la bonne, puis utiliser un tournevis Phillips pour resserrer les vis de fixation du bloc de lampe jusqu'à ce qu'elles soit bien serrées.

- Installer le couvercle du bloc de lampe, puis serrer les vis de fixation à l'aide du tournevis cruciforme Phillips.

**REMARQUE:**

- S'assurer que le bloc de lampe et le couvercle sont correctement installés. S'ils ne sont pas correctement installés le circuit de protection risque de se déclencher et le projecteur ne pourra pas être allumé.

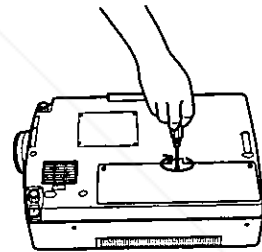

- Brancher la fiche du cordon d'alimentation dans la prise de courant et appuyer sur l'interrupteur d'alimentation principale (MAIN POWER) pour allumer appareil.

**REMARQUE:**

- Si le projecteur ne s'allume pas lorsque l'on appuie sur l'interrupteur d'alimentation principale (MAIN POWER), mettre l'interrupteur sur OFF de nouveau et vérifier que le bloc de lampe et le couvercle sont correctement installés. Mettre l'interrupteur d'alimentation principale (MAIN POWER) sur ON de nouveau.

- Appuyer sur la touche d'alimentation (POWER) sur le projecteur ou la télécommande pour projeter une image sur l'écran.

- (1) Appuyer sur la touche de menu (MENU) pour faire apparaître l'écran

MENU

- Appuyer sur les touches de flèche "▲" et "▼" pour sélectionner "OPTION".



9. -(1) Appuyer sur la touche ENTER. ... L'écran OPTION s'affichera.  
 (2) Appuyer sur la touche "▲" ou "▼" pour placer le curseur sur DURÉE LAMPE.  
 (3) Appuyer sur et maintenir la touche ENTER sur le panneau de commande du projecteur pendant 3 secondes ou plus. ... DURÉE LAMPE changera pour montrer RAZ L1 [POWER OFF] ou RAZ L2 [POWER OFF].  
 (4) Appuyer sur la touche "◀" ou "▶" pour changer le réglage de la lampe devant être remplacée.

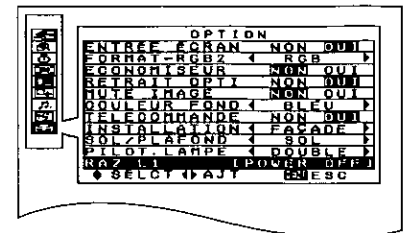
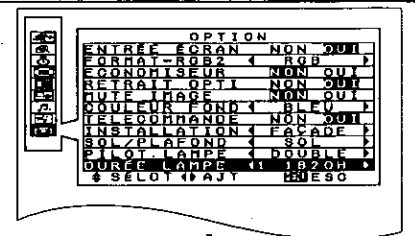

RAZ L1: lors du remplacement de la lampe 1  
 RAZ L2: lors du remplacement de la lampe 2  
 RAZ L1 + L2: lors du remplacement de la lampe 1 et de la lampe 2

**REMARQUE:**

- Cette opération ne pourra pas s'effectuer si l'on appuie sur la touche ENTER de la télécommande dans l'étape (3) ci-dessus.
- Si l'on appuie sur la touche MENU, l'écran de remise à zéro de la durée de lampe sera annulé et l'affichage retournera à l'écran précédent, ou l'écran MENU sera libéré.

- (5) Appuyer sur la touche POWER pour mettre l'alimentation électrique hors tension. La durée cumulée du (des) bloc(s) de lampe remplacées seront alors remises à zéro.



**Discount-Merchant.com (800) 281-8860**  
**THE TRUSTED SOURCE FOR PROJECTOR LAMPS AND ACCESSORIES**



---

# Panasonic<sup>®</sup>

Professional/Industrial Video

---

**Panasonic Broadcast & Television Systems Company**

Division of Matsushita Electric Corporation of America

One Panasonic Way 4E-7 Secaucus, NJ 07094 (201) 392-4443  
3330 Cahuenga Blvd West Los Angeles, CA 90068 (323) 436-3500

**Technical Support:**

(300) 524-1448

(800) 526-6610

FAX: (201) 392-6514

E-Mail: [pbtssupport@panasonic.com](mailto:pbtssupport@panasonic.com)

**Panasonic Canada Inc.**

5770 Ambler Drive, Mississauga, Ontario L4W 2T3 (905) 624-5010

Merchant.com (800) 281-8860

SOURCE FOR PROJECTOR LAMPS AND ACCESSORIES

Printed in Japan  
S0699-1069B



# Disclaimer

This user manual is provided as a free service by FixYourDLP.com. FixYourDLP is in no way responsible for the content of this manual, nor do we guarantee its accuracy. FixYourDLP does not make any claim of copyright and all copyrights remain the property of their respective owners.

About FixYourDLP.com

FixYourDLP.com (<http://www.fixyourdlp.com>) is the World's #1 resource for media product news, reviews, do-it-yourself guides, and manuals.

Informational Blog: <http://www.fixyourdlp.com>

Video Guides: <http://www.fixyourdlp.com/guides>

User Forums: <http://www.fixyourdlp.com/forum>

FixYourDLP's Fight Against Counterfeit Lamps:

<http://www.fixyourdlp.com/counterfeits>

## Sponsors:

RecycleYourLamp.org – Free lamp recycling services for used lamps:

<http://www.recycleyourlamp.org>

Lamp Research - The trusted 3rd party lamp research company:

<http://www.lampresearch.com>

Discount-Merchant.com – The worlds largest lamp distributor:

<http://www.discount-merchant.com>



**FixYourDLP.com**

Sponsored by 