



# Disclaimer

This user manual is provided as a free service by FixYourDLP.com. FixYourDLP is in no way responsible for the content of this manual, nor do we guarantee its accuracy. FixYourDLP does not make any claim of copyright and all copyrights remain the property of their respective owners.

About FixYourDLP.com

FixYourDLP.com (<http://www.fixyourdpl.com>) is the World's #1 resource for media product news, reviews, do-it-yourself guides, and manuals.

Informational Blog: <http://www.fixyourdpl.com>

Video Guides: <http://www.fixyourdpl.com/guides>

User Forums: <http://www.fixyourdpl.com/forum>

FixYourDLP's Fight Against Counterfeit Lamps:

<http://www.fixyourdpl.com/counterfeits>

## Sponsors:

RecycleYourLamp.org – Free lamp recycling services for used lamps:

<http://www.recycleyourlamp.org>

Lamp Research - The trusted 3rd party lamp research company:

<http://www.lampresearch.com>

Discount-Merchant.com – The worlds largest lamp distributor:

<http://www.discount-merchant.com>



**FixYourDLP.com**

Sponsored by 

# Operating Instructions

LCD Projector

Model PT-L291U

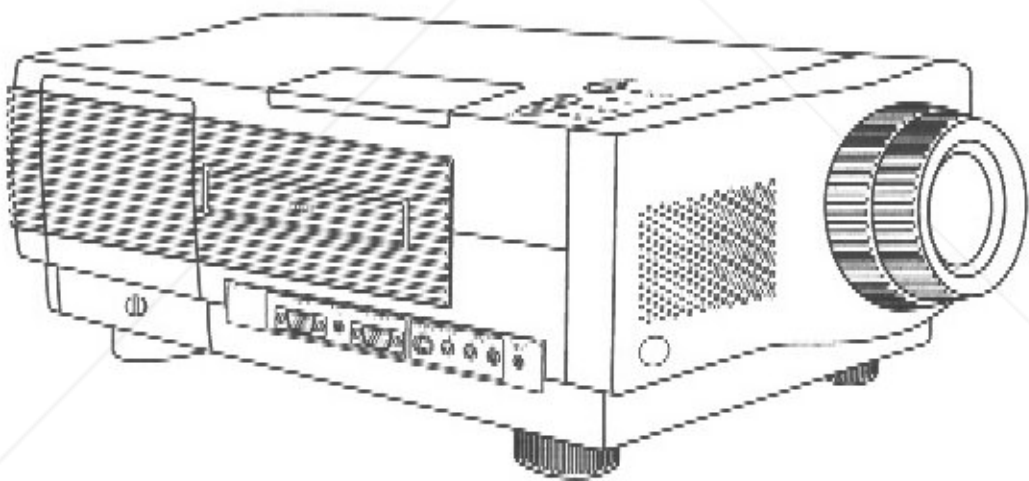

 FixYourDLP.com  
Sponsored by 

**Discount-Merch.com** **Panasonic** (800) 281-8860

**THE TRUSTED SOURCE FOR PROJECTOR LAMPS AND ACCESSORIES**

Please read these completely before operating this LCD Projector.

# Things You Should Know

**Caution** This equipment has been tested and found to comply with the limits for a Class B digital device, pursuant to Part 15 of the FCC Rules. These limits are designed to provide reasonable protection against harmful interference in a residential installation. This equipment generates, uses, and can radiate radio frequency energy and, if not installed and used in accordance with the instructions, may cause harmful interference to radio communications. However, there is no guarantee that interference will not occur in a particular installation. If this equipment does cause harmful interference to radio or television reception, which can be determined by turning the equipment off and on, the user is encouraged to try to correct the interference by one or more of the following measures:

- Reorient or relocate the receiving antenna
- Increase the separation between the equipment and receiver
- Connect the equipment into an outlet on a circuit different from that to which the receiver is connected
- Consult the dealer or an experienced radio/TV technician for help

**FCC Warning:** To assure continued compliance, use only the provided grounded power supply cord and shielded interface cables when connecting this device to a computer. Also, any unauthorized changes or modifications to this equipment could void the user's authority to operate this device.

## Congratulations

on your purchase of one of the most sophisticated and reliable products on the market today. Used properly, we're sure it will bring you in your family years of service enjoyment. Please take time to fill in the information below. The serial number is on the tag located on the back of your LCD Projector. You'll want to keep this manual handy as your convenient LCD Projector information source. For your own protection and prolonged operation of your LCD Projector, please be sure to read the "Important Safeguards" carefully, before use.

Date of Purchase \_\_\_\_\_  
Dealer Purchased From \_\_\_\_\_  
Dealer Address \_\_\_\_\_  
Dealer Phone No \_\_\_\_\_  
Model No **PT-L291U** \_\_\_\_\_  
Serial No \_\_\_\_\_

## Table of Contents

Things You Should Know	1
Important Safeguards	2, 3
Contents of LCD Projector Box	4
LCD Projector Features	5, 6
Product Information	7, 8
Positioning the LCD Projector and Screen	9
Initial Set Up of the LCD Projector	10
Specifications	11
Video/Computer Cables & Adaptors	12
Pin Assignment	12
Connecting the LCD Projector	13, 14, 15, 16
Basic LCD Projector Operation	17, 18
Video Adjustment	19, 20, 21
Timing Specifications	22, 23
Maintenance	24, 25, 26
Trouble Shooting	27, 28, 29

© 1996 Matsushita Electric Industrial Co., Ltd

All product/brand names are trademarks or registered trademarks of the respective holders

# Important Safeguards



**CAUTION: Please read all of these instructions before you operate your LCD Projector. Save these instructions for future reference.**

Electrical energy can perform many useful functions. This LCD Projector has been engineered and manufactured to meet applicable safety standards. But **IMPROPER USE CAN RESULT IN POTENTIAL ELECTRICAL SHOCK OR FIRE HAZARDS**. In order not to defeat the safeguards incorporated into this LCD Projector, observe the following basic rules for its installation, use and servicing.

- 1 Unplug the LCD Projector from the wall outlet before cleaning.
- 2 Do not use liquid cleaners or aerosol cleaners. Use a soft dry cloth to clean the LCD Projector unit. If the unit is very dirty, wet a cloth with neutral detergent, squeeze it tight, wipe the unit with it, and finish by wiping with a dry cloth. Do not use a chemical duster or polisher-cleaner because it can adversely affect the unit and peel the paint coat.
- 3 Do not use attachments not recommended by Panasonic, as they may cause hazards.
- 4 Do not use the LCD Projector near water, for example, near a bathtub, washbowl, kitchen sink, laundry tub, in a wet basement, near a swimming pool, etc. Never spill liquid into the LCD Projector.
- 5 Do not place the LCD Projector on an unstable cart, stand, or table. The LCD Projector may fall, which may cause serious injury to a child or an adult, and/or serious damage to the unit. Use only with a cart or stand recommended by its manufacturer, as being suitable for use with an LCD Projector.
- 6 Ceiling, wall or shelf mounting for installation should use a mounting kit approved by the manufacturer for use with an LCD Projector and should follow the manufacturer's instructions.
- 7 LCD Projector equipment and cart combinations should be moved with care. Quick stops, excessive force, and uneven surfaces may cause the equipment and cart combination to overturn.
- 8 Slots and openings in the cabinet back and bottom are provided for ventilation. To ensure reliable operation of the LCD Projector and to protect it from overheating, these openings must not be blocked or covered. These openings should never be covered with cloth or other material. The bottom opening should not be blocked by placing the LCD Projector on a bed, sofa, rug, or other similar surface. The LCD Projector should not be placed near or over a radiator or heating vent. The LCD Projector should not be placed in a built-in installation such as a bookcase unless proper ventilation is provided.
- 9 The LCD Projector should be operated only from the type of power source indicated on the back of the LCD Projector or in the specifications. If you are not sure of the type of power supplied to your business, consult your LCD Projector dealer or local power company.
- 10 Do not allow anything to rest on the power cord. Do not place the LCD Projector where the cord will be walked on.
- 11 Follow all warnings and instructions marked on the LCD Projector.
- 12 As a safety feature, this LCD Projector is equipped with a 3-prong grounded plug. The 3-prong grounded plug will fit only into a grounding type power outlet. If the plug does not fit, use an adaptor that is properly grounded or have an electrician install a grounded type outlet. Do not attempt to modify this AC plug.
- 13 For added protection of the LCD Projector during a lightning storm, or when it is left unattended or not in use for long periods of time, unplug it from the wall outlet and disconnect any cable systems. This will prevent damage to the projector due to lightning and power-line surges.
- 14 Do not overload wall outlets and extension cords with too many products, because this can result in fire or electric shock.



- 15** Never push objects of any kind into the LCD Projector through cabinet slots as they may touch dangerous voltage points or short out parts, which could result in a fire or electric shock
- 16** Do not attempt to service the LCD Projector yourself. Opening or removing covers may expose you to dangerous voltage or other hazards. Refer all servicing to qualified service personnel.
- 17** Unplug the LCD Projector equipment from the wall outlet and refer servicing to qualified service personnel under the following conditions:
  - A When the power cord or plug is damaged or frayed
  - B If liquid has been spilled into the LCD Projector
  - C If the LCD Projector has been exposed to rain or water
  - D If the LCD Projector does not operate normally when you follow the operating instructions. Adjust only those controls that are covered by the operating instructions, improper adjustment of other controls may cause damage and will often require extensive work by a qualified technician to restore the LCD Projector to normal operation
  - E If the LCD Projector has been dropped or the cabinet has been damaged
  - F When the LCD Projector exhibits a distinct change in performance – this indicates a need for service
- 18** Upon completion of any service or repairs to the LCD Projector, ask the service technician to perform a routine safety check to determine that the LCD Projector is in safe operating condition
- 19** When replacement parts are required, be sure the service technician has used replacement parts specified by the manufacturer that have the same characteristics as the original parts. Unauthorized substitutions may result in fire, electric shock, or other hazards
- 20** Air filter must be cleaned every 100 lamp on hours.  
LCD Projector may become too hot if filter is not cleaned when required
- 21** If lens becomes dirty, or smudged, clean with a clean, dampened cloth. Never touch the lens with your fingers
- 22** Do not look directly into the aperture and lens while operating as this may result in damage to your eyes



**Discount-Merchant.com (800) 281-8860**  
**THE TRUSTED SOURCE FOR PROJECTOR LAMPS AND ACCESSORIES**

# *Contents of LCD Projector Box*

Please confirm that the following items are packed in the LCD Projector box. They are provided to help you use or set up your LCD Projector.

- (1) LCD Projector
- (2) Remote Control
- (3) 2 "AA" Batteries
- (4) 9.8 Foot UL/CSA Power Cord
- (5) PC/AT VGA Cable
- (6) VGA MAC Adaptor
- (7) PC Audio Cable
- (8) Video RCA Cable
- (9) RCA - BNC pin Adaptor
- (10) Audio RCA Cable
- (11) Operating Instructions (Please read completely before operating )
- (12) Warranty Card
- (13) Service Center List



**Discount-Merchant.com (800) 281-8860**  
**THE TRUSTED SOURCE FOR PROJECTOR LAMPS AND ACCESSORIES**

# LCD Projector Features

## 1 High Brightness and Resolution

922k-pixel, 300-lumen (ANSI) offers clear images even when ambient light level is high

## 2 Compact and Lightweight

Completely portable, you can give attractive presentations at any location by connecting the PT-L291U to a notebook computer, etc

## 3 30 to 650 Inch Screen Capability

30" (2.5 feet) to 650" (54.2 feet) throw distance (See table on page 9)

## 4 Compatible with Most Personal Computers

The RGB input accepts signals from VGA and MAC compatible computers with no additional hardware  
Other compatible computers require a separate cable

## 5 Rear Screen Projection

The LCD Projector is equipped with a reverse scan function which allows the image to be reversed for rear projection (See operation on page 18)

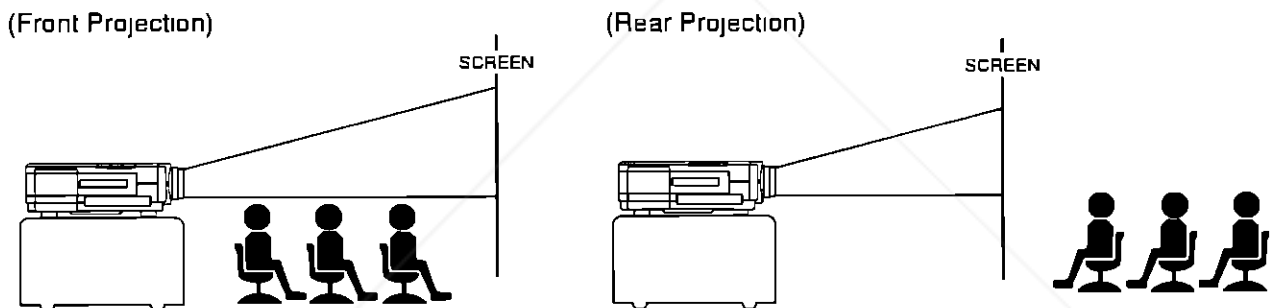

## 6 IR Remote Control

Front and rear sensors allow you to control the projector from almost anywhere in the room

## 7 Stereo Audio Output

For external audio equipment connection Audio follows video source



**Discount-Merchant.com (800) 281-8860**  
**THE TRUSTED SOURCE FOR PROJECTOR LAMPS AND ACCESSORIES**

## 8 Blue Screen with No Video Input

The LCD Projector is equipped with an internal Blue Screen function which turns the screen blue when the video equipment connected to the input jack is turned off, or when there is nothing connected to the input jack

- If the power is turned on when no video signal is input to the LCD Projector, the screen will turn blue

The "FOCUS" overlay appears only until the video equipment is connected to the input jack and turned on

If no video signal input is received (the screen is blue) for 15 minutes, the lamp will turn off automatically

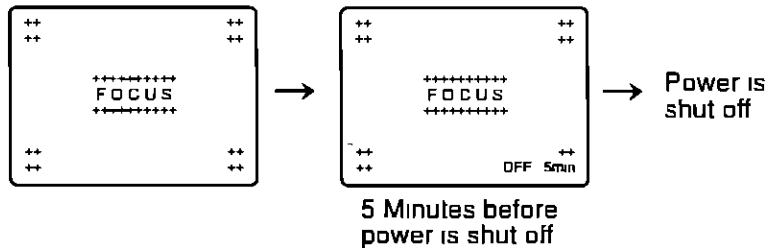

- The following display will appear when the RGB input is within the LCD Projector's frequency range, but is not one of the LCD Projector's programmed formats (As found on page 23 )
- Should an RGB signal be input which is out of the LCD Projector's frequency range, no indication will be present



## 9 Manual Shutter Function

Blanks out the screen and mutes the sound

Press the SHUTTER button or key to blank the video to black and mute the audio

Press the button or key once again to return to the normal screen and sound

## 10 Audio Mute

Press the MUTE button or key to instantly mute the sound

Press again to restore the previous sound level

## 11 On Screen Displays

Information screens and menus make setting up and operating the LCD Projector extremely easy

## 12 Automatic Universal Power Supply with Automatic Power Down

This unit has an operating voltage range of AC 100 - 240V The lamp power is automatically turned off if there is no video input for 15 minutes



Discount-Merchant.com

Sponsored by DM

**Discount-Merchant.com (800) 281-8860**  
**THE TRUSTED SOURCE FOR PROJECTOR LAMPS AND ACCESSORIES**



# Product Information

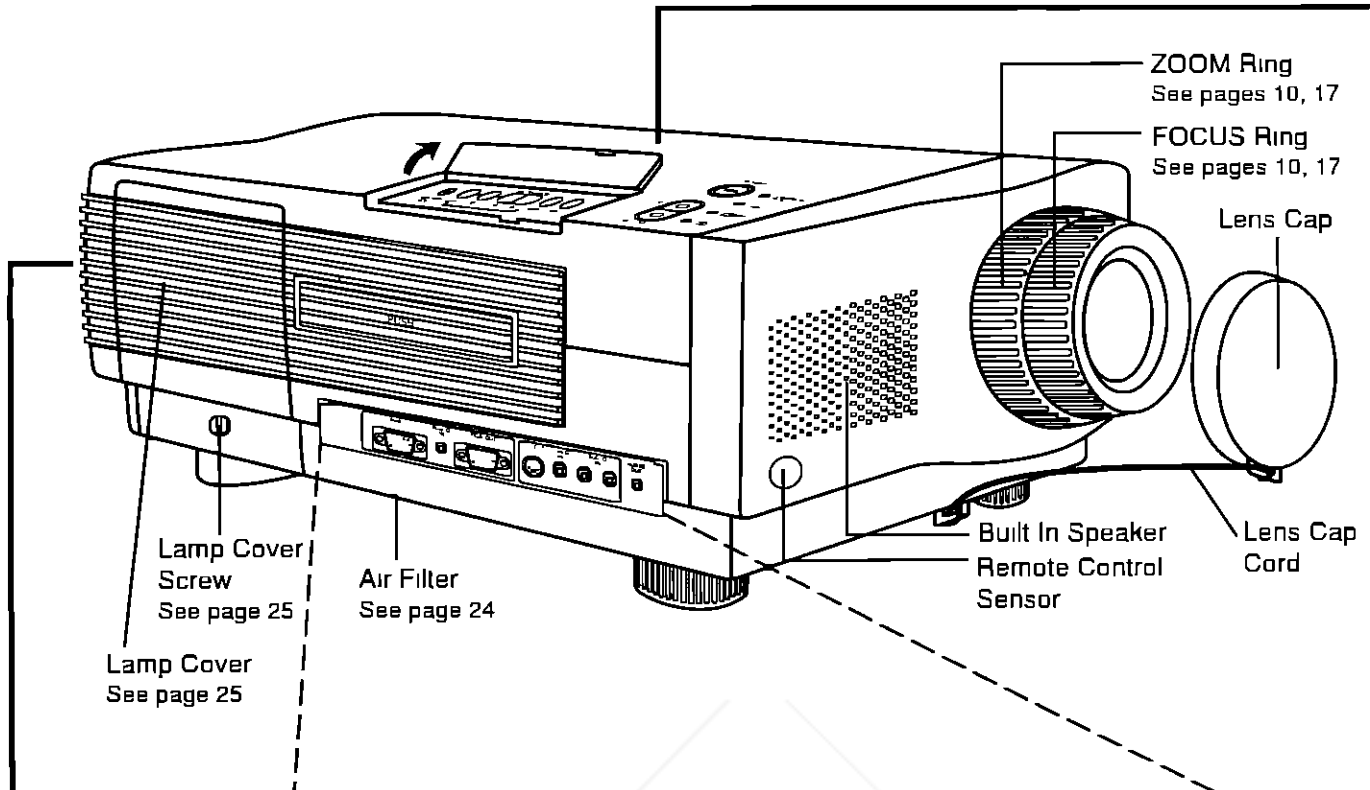

## Side View

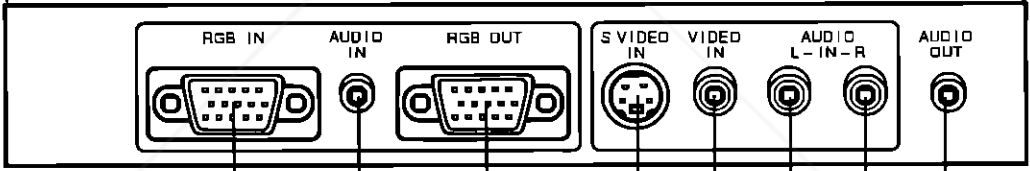

- RGB Input Connector  
See pages 14 - 16
- Audio Input Connector  
See pages 14 - 16
- RGB Output Connector  
See pages 14 - 16
- S-Video Input Connector  
See page 13
- Video Input Connector  
See page 13
- Audio Input Connector (L/R)  
See page 13
- Audio Output Connector  
See pages 13 - 16

## Rear View

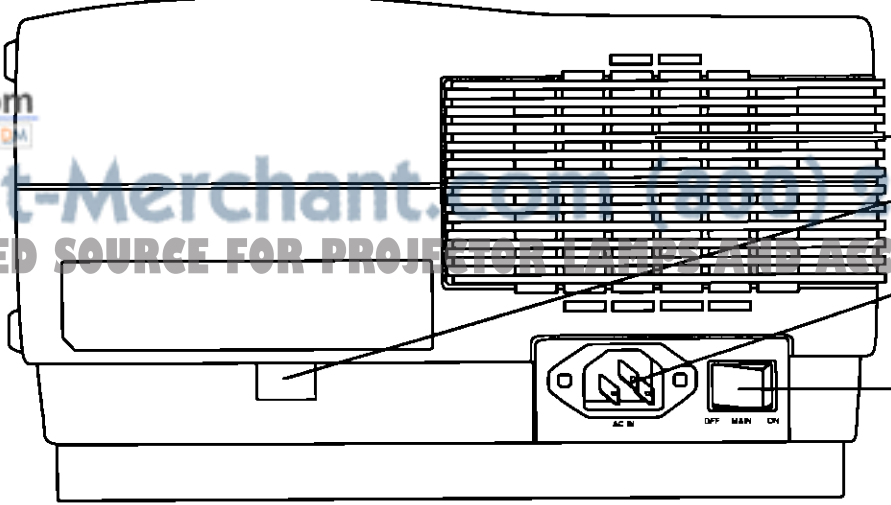

- Intake Vent
- Remote Control Sensor
- AC Socket (100 - 240 V)  
See page 10
- Main Power Switch  
See page 10, 17, 24

 FixYourDLP.com  
 Sponsored by 

**Discount-Merchants.com** 1-800-828-8800  
 THE TRUSTED SOURCE FOR PROJECTOR REPAIR PARTS AND ACCESSORIES

## Top View

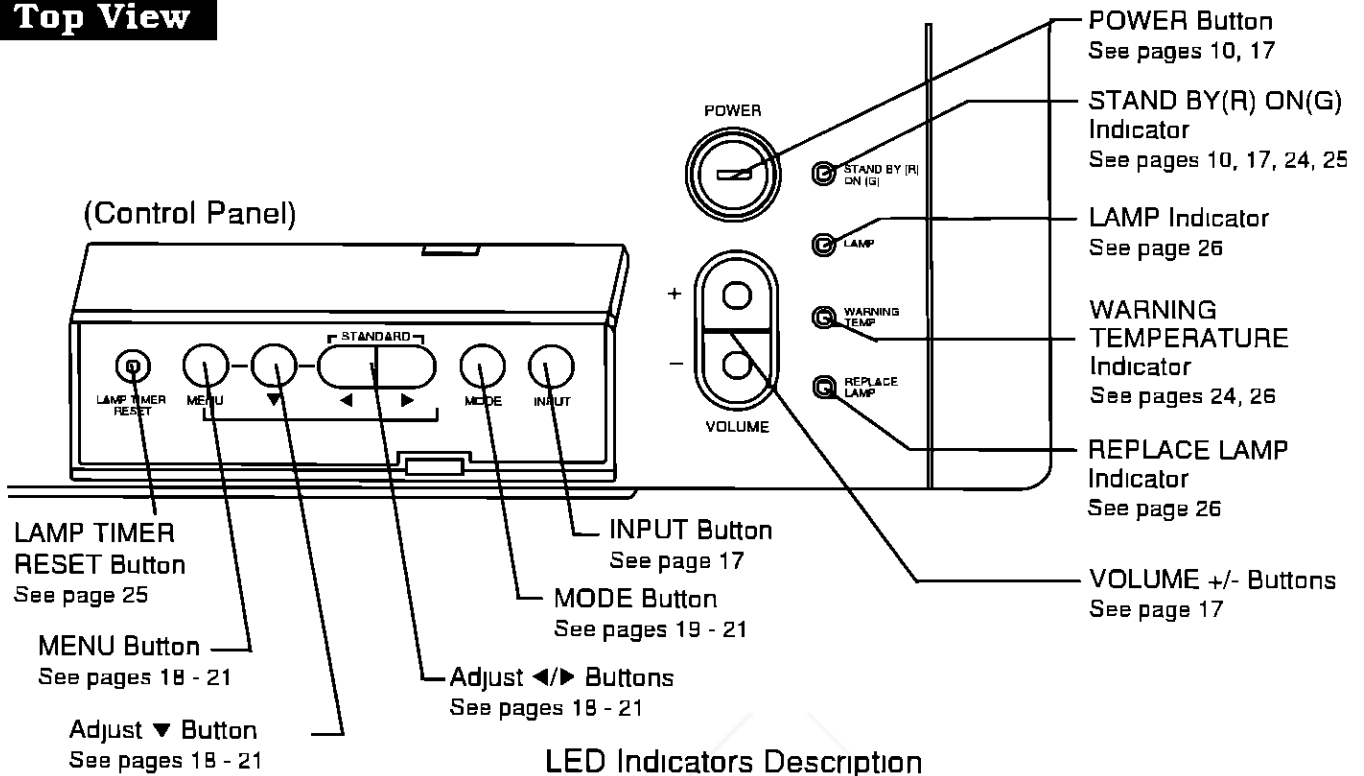

### LED Indicators Description

STAND BY (R) ON (G)	RED = Power On    Flashing RED = Cooling Fan GREEN = Lamp On    Flashing GREEN = Warming Up
LAMP	RED = Error
WARNING TEMP	RED Flashing = Temperature Error
REPLACE LAMP	RED Flashing > 1,000 hrs RED ≥ 1,100 hrs

## REMOTE CONTROL

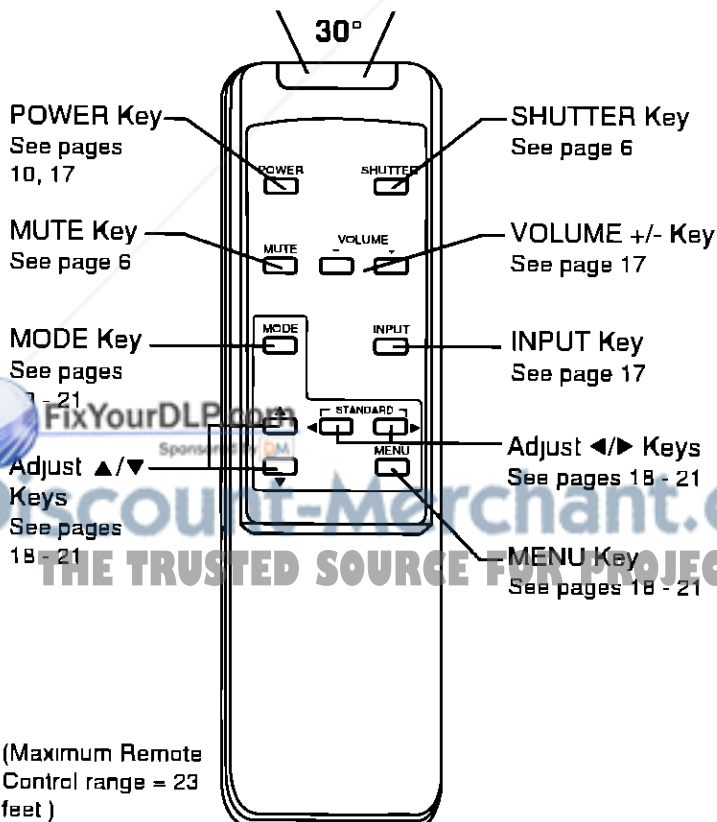

### Load the 2 "AA" batteries in the Remote Control

**1** Slide the lid in the direction of the arrow

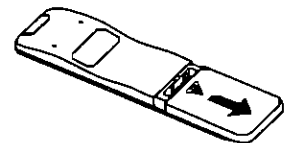

**2** Install 2 "AA" batteries as indicated inside the Battery Compartment

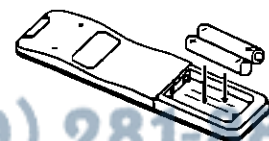

**3** Replace the lid and snap into place

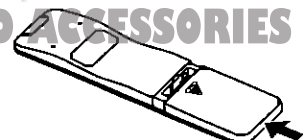

### Battery replacement caution

- Do not mix old and new batteries (Also never mix alkaline with manganese batteries)

# Positioning the LCD Projector and Screen

The screen should be positioned so that it is not directly touched by sunlight or room light as this will wash out the colors of the picture making it hard to see. When possible, close all blinds, curtains, etc. and dim the lights. Also, the LCD Projector should be at a 90° angle to the screen for the best picture results. To determine the distance for the desired size, please refer to the LCD Projector/Screen Relationship Chart below.

## Top View

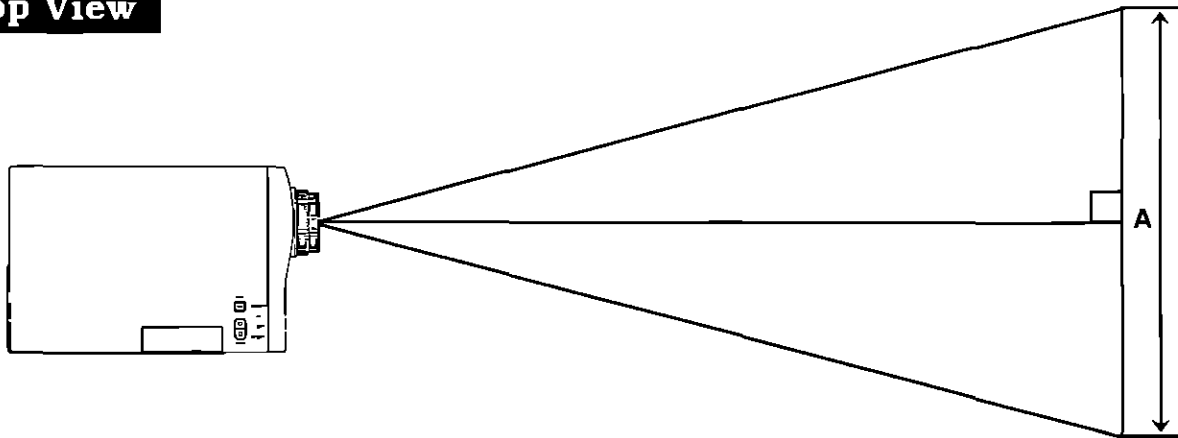

## Side View

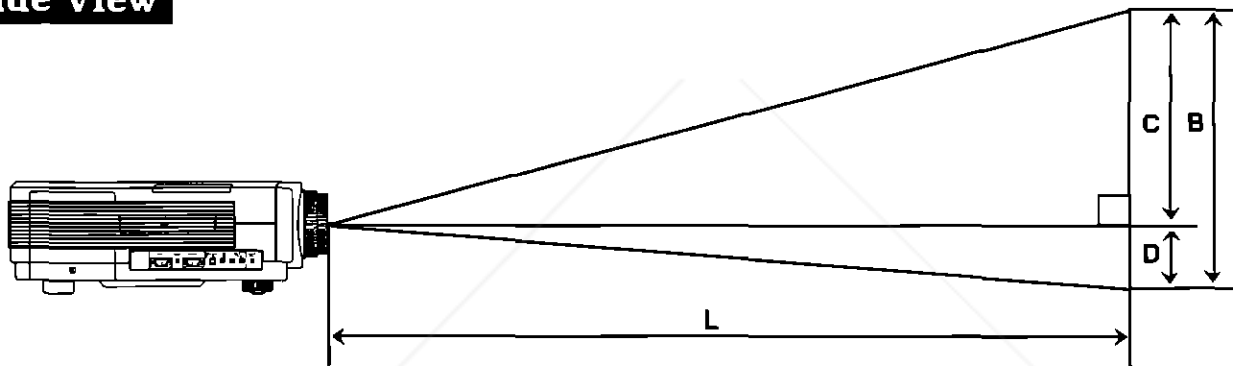

- Your LCD Projector is equipped with an image reverse feature. So, in addition to front projection, you can also reverse the image for rear projection. (See page 18)

## LCD Projector /Screen Relative Position Chart

The picture can be adjusted to the desired size within the range of the zoom lens.

Screen size	Throw distance (L)	Measure (A)	Measure (B)	Measure (C)	Measure (D)
20 inches	2.46 – 3.61 ft (0.75 – 1.1 m)	1.35 ft (0.41 m)	0.98 ft (0.3 m)	0.89 ft (0.27 m)	1.18 in (3 cm)
40 inches	4.92 – 7.22 ft (1.5 – 2.2 m)	2.66 ft (0.81 m)	2.00 ft (0.61 m)	1.80 ft (0.55 m)	2.36 in (6 cm)
60 inches	7.55 – 10.83 ft (2.3 – 3.3 m)	3.94 ft (1.2 m)	2.99 ft (0.91 m)	2.69 ft (0.82 m)	3.54 in (9 cm)
80 inches	9.84 – 14.44 ft (3.0 – 4.4 m)	5.25 ft (1.6 m)	3.94 ft (1.2 m)	3.54 ft (1.08 m)	4.72 in (12 cm)
100 inches	12.47 – 18.04 ft (3.8 – 5.5 m)	6.56 ft (2.0 m)	4.92 ft (1.5 m)	4.43 ft (1.35 m)	5.91 in (15 cm)
200 inches	24.93 – 36.09 ft (7.6 – 11.0 m)	13.45 ft (4.1 m)	9.84 ft (3.0 m)	8.86 ft (2.7 m)	11.81 in (30 cm)
300 inches	37.40 – 54.13 ft (11.4 – 16.5 m)	20.01 ft (6.1 m)	15.09 ft (4.6 m)	13.58 ft (4.14 m)	18.11 in (46 cm)

- If the LCD Projector and the screen are not properly placed, the picture will be distorted producing a keystone image as shown at right.



## Caution: When you set up the LCD Projector

- do not place it in humid or dusty places, or places where the air is sooty or full of cigarette smoke. If the lens, mirror, or other optical components become dirty, the picture will blur or darken, making viewing difficult.
- do not expose to extreme heat or cold. Operating temperature 5°C – 40°C (41°F – 104°F)

# Initial Set Up of the LCD Projector

Place the LCD Projector on a stable, flat surface according to the LCD Projector/ Screen Relative Position Chart on page 9

- Remove the lens cap

**1 Insert Power Cord into LCD Projector AC socket and connect to properly grounded wall outlet.**

**2 Set the Main Power Switch to ON.**

- The STAND BY(R) ON(G) indicator lights red  
(It takes about 45 seconds for image to appear clearly)

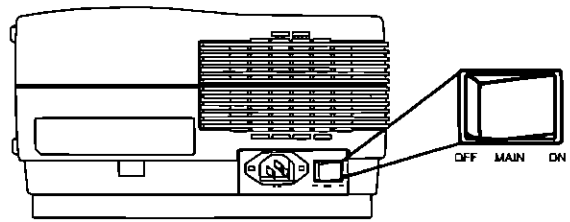

**3 Press POWER on the LCD Projector or remote control ON.**

- The STAND BY(R) ON(G) indicator changes to green

**4 Use the FOCUS and ZOOM Rings to adjust the focus and size of the image**

**5 Use the Height/ Level Adjusters**

to adjust the vertical angle of the projector as specified on page 9 (See illustration below)

**6 Use the FOCUS and ZOOM Rings**

to readjust the focus and size of the image

## Side View

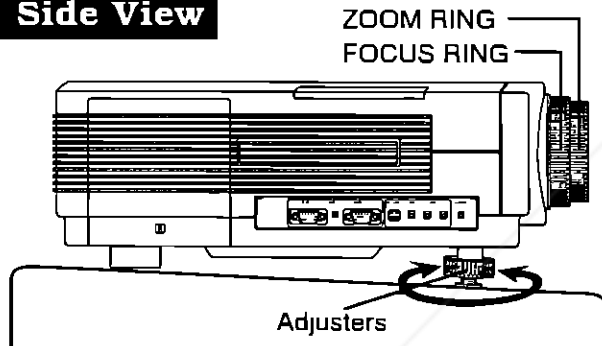

Center the projected image on the screen

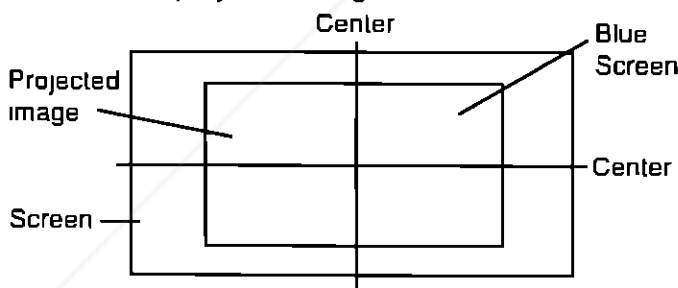

## Front View

**To Raise:**  
turn adjusters  
in direction of  
arrows

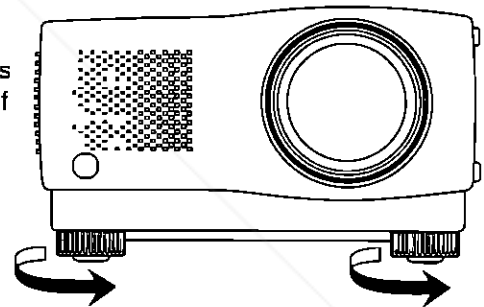

**To Lower:**  
turn adjusters  
in direction of  
arrows

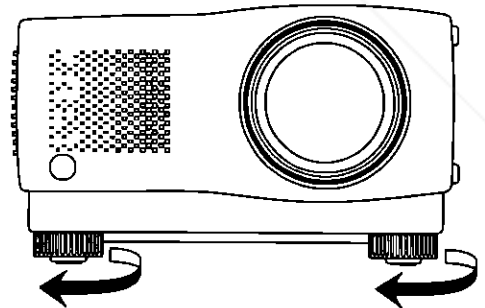

## Notes:

When adjustments are made improperly, the picture may become distorted, depending on the relative positions of the LCD Projector and the screen

- To prevent the LCD Projector from wobbling, adjust both adjusters so that they firmly contact the mounting surface

## Moving the LCD Projector

First, turn Main Power Switch OFF and disconnect Power Cord. Second, disconnect all other cables

Press in on handle to release or store handle

- Make sure the lens cap is in place to prevent damage to the lens

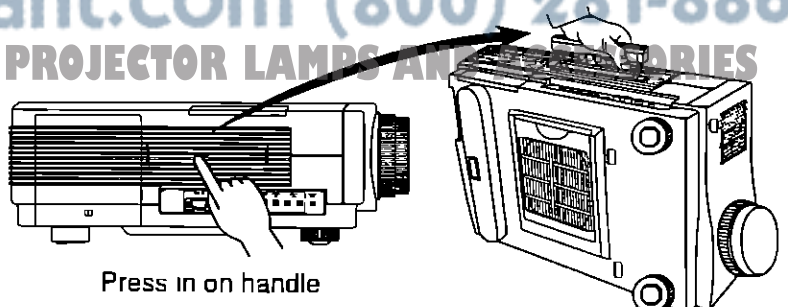

# Specifications

LCD panels		1 3" Poly silicon LCD panel 3X, RGB shutter method, using Translucent TN crystal panels
Drive method		Active Matrix 4 3 Aspect Ratio panels, TFT (Thin Film Transistor)
No of pixels		921,600 stripe pixels (480 X 640 X 3)
Lens		1 - 1 44 zoom lens, F2 8 - 3 1, f 50 - 72mm Manual Focus
Projector lamp		Metal halide 250W
Contrast ratio		150 1
Brightness		300 lumen / ANSI
Colors		16,777,216
Screen size		20" - 300" (measured diagonally)
Projection (throw) distance		2 5' - 54 2'
Keystone Correction		1 9 Low position
Video input signal		NTSC Composite video, 1 Vp-p, sync negative, 75Ω terminated
S-Video input signal		Y (luminance signal) 1 Vp-p, sync negative, 75Ω terminated C (chrominance signal) burst 0 286 Vp-p, 75Ω terminated
RGB input signal	Video signal	RGB Analog (0 7 Vp-p, 1 0 Vp-p with sync on green, 75Ω) Unlimited numbers of colors
	Sync signal	H/V separate, H/V combined, or Sync-on-Green
	H-Frequency	15 73 - 39 38 KHz (TTL Level) ← Refer to page 23
	V-Frequency	59 7 - 85 1 Hz (TTL Level) ← Refer to page 23
Terminals		NTSC Video Input One RCA jack S-Video Input One 4-pin mini DIN connector Computer Display Input One 15 pin mini D-Sub Computer Display Output One 15 pin mini D-Sub Video Audio Input 2 RCA jacks (L + R) Computer Audio Input M3 stereo jack Through Audio output M3 stereo jack
Controls	External Button Switches	Main Power ON/OFF, Power ON/OFF, Volume +/-
	Under Cover Button Switches	Mode, Input, Menu, ▼, ◀, ▶, Lamp Timer Reset
	Remote Control Key Switches	Power ON/OFF, Volume +/-, Shutter, Mute, Mode, Input Menu, ▲, ▼, ◀, ▶
Audio output		1 5 W
Speaker		3 1" round X 1
Operating Temperature		41°F to 104°F (5°C to 40°C)
Operating Humidity		10% - 80 % (non-condensation)
Storage Temperature		-13°F to 140°F (-25°C to 60°C)
Storage Humidity		5% - 85% (non-condensation)
Power Supply		100 - 240 V AC (50 or 60 Hz) Automatic
Power Consumption		390 W
Dimensions W X H X D		11 - 7/16" X 6 - 7/8" X 19"
Weight		21 lbs
Approvals		FCC, UL, C-UL

Note Specifications and design subject to change without notice

# Video/ Computer Cables & Adaptors

These accessories are supplied in order to connect the LCD Projector to Computer/ AV equipment  
The numbers in the left column correspond with the numbers in the connection diagrams on pages 13-16

No	CABLE/ADAPTOR	PORT				LENGTH
		Projector side		Computer/AV products side		
1	PC/AT VGA Cable	D-Sub M 15P (male)		D-Sub M 15P (male)		6 56 ft (2 0m)
2	VGA MAC Adaptor	D-sub M 15P (female)			MAC 15P (male)	—
3	PC Audio Cable	M3 stereo mini pin (male)		M3 stereo mini pin (male)		6 56 ft (2 0m)
4	Video RCA Cable	RCA pin (male)		RCA pin (male)		4 92 ft (1 5 m)
5	RCA-BNC pin Adaptor	RCA pin (male)			BNC pin (female)	—
6	Audio RCA Cable	RCA pin (male) X 2		RCA pin (male) X 2		4 92 ft (1 5 m)

## Pin Assignment

Follow the instructions below when connecting to a computer

**A. Signal connector:** 15-pin mini D-sub (PC/AT compatible model) Connect the signal cable to the 15-pin mini D-sub connector on the LCD Projector unit

**B Signal connector** 15-pin D-sub (MAC)

To convert a MAC 15-pin D-sub connector to a 15-pin mini D-sub connector, use a VGA-MAC adaptor (included) and connect it to the 15-pin mini D-sub connector on the LCD Projector unit

MAC (13" Display, Separate Sync only)

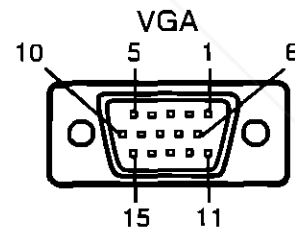
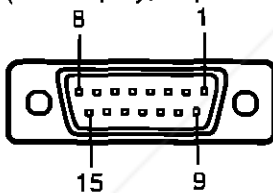

Pin No	Signal
1	Ground for red video signal
2	Red video signal
3	Composite sync
4	Ground
5	Green video signal
6	Ground for green video signal
7	Unused
8	Unused
9	Blue video signal
10	Unused
11	Ground
12	Vertical synchronizing signal
13	Ground for blue video signal
14	Ground
15	Horizontal synchronizing signal

Pin No	Signal
1	Red video signal
2	Green video signal
3	Blue video signal
4	Unused
5	Unused (Through out)
6	Ground for red video signal
7	Ground for green video signal
8	Ground for blue video signal
9	Unused
10	Ground
11	Unused
12	Unused
13	Horizontal synchronizing signal
14	Vertical synchronizing signal
15	Unused

**Note** When using a Composite Sync Output type Macintosh, please use a Composite Sync type VGA MAC Adaptor (pin 3 and pin 13 connected)

# Connecting the LCD Projector

## Connecting to audio/video output equipment (Video signal)

- Always turn off the Main Power Switch of the LCD Projector while connecting to video equipment, in order to protect both the LCD Projector and the equipment being connected

### 1. NTSC Video

(Diagram numbers correspond with numbers on page 12)

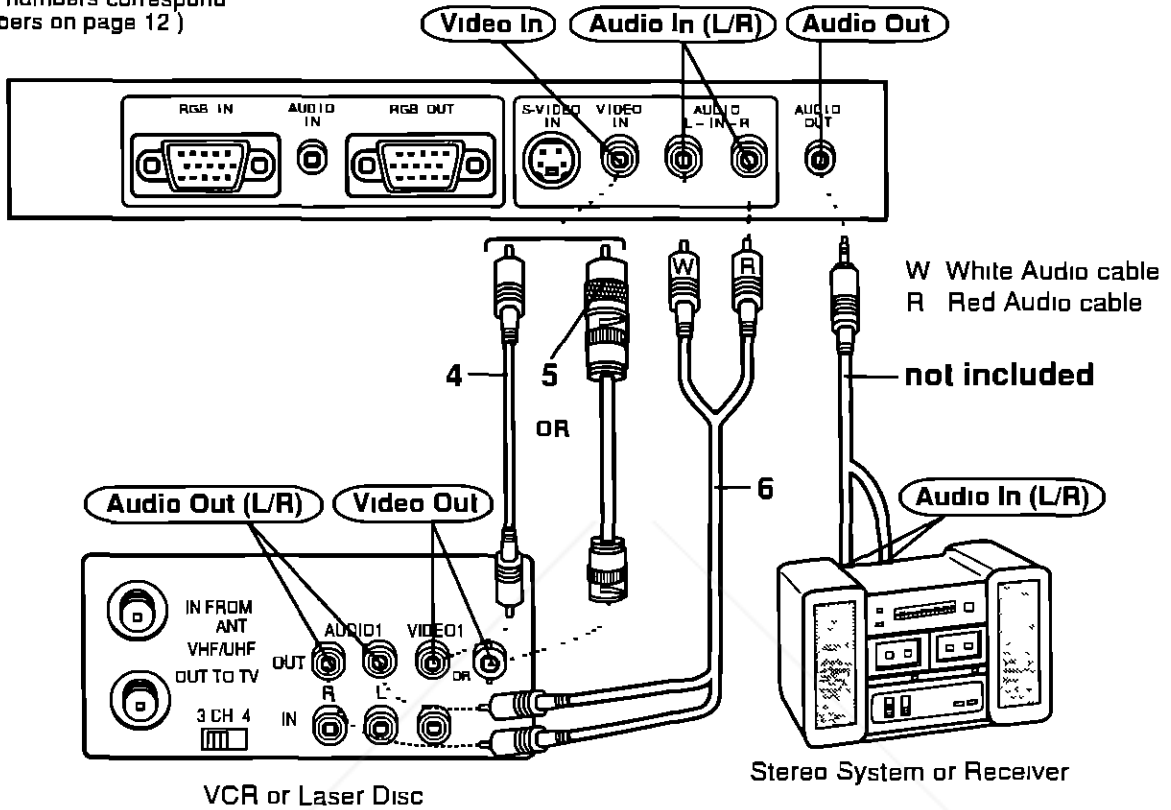

### 2. S-Video

(Diagram numbers correspond with numbers on page 12)

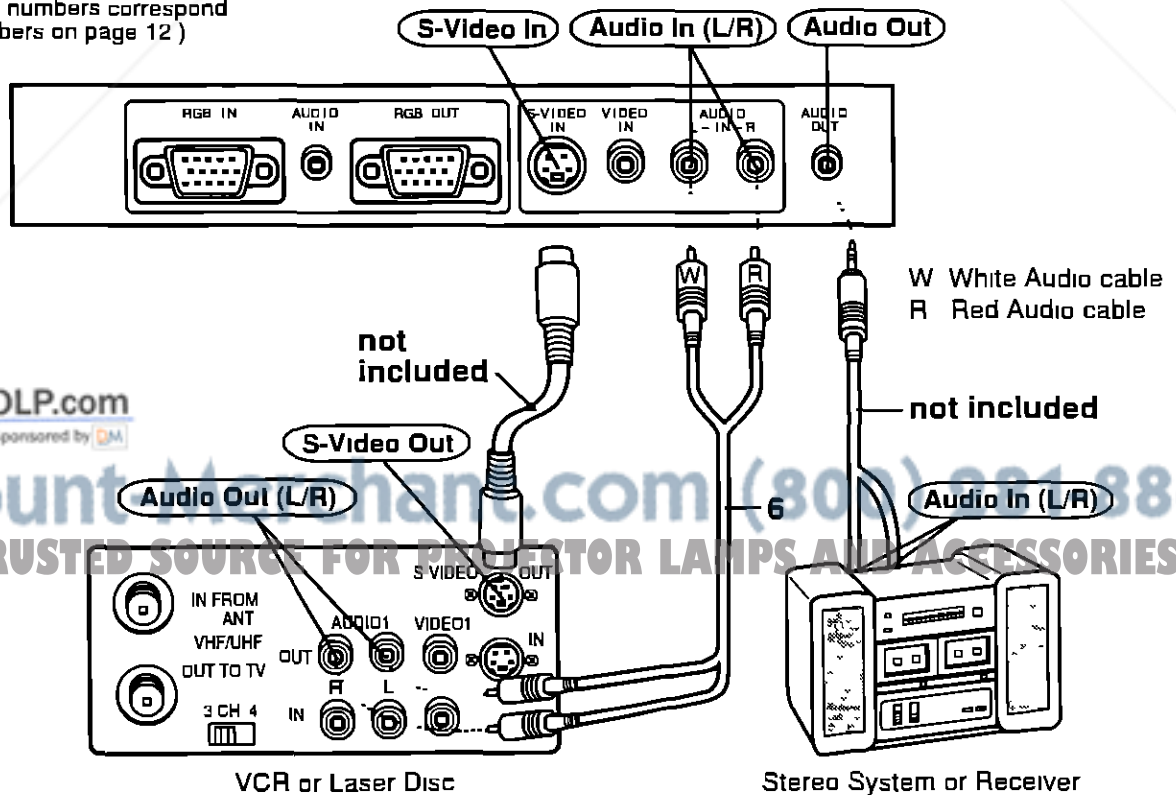

## Connecting to a computer (RGB signal)

- Always turn off the Main Power Switch on the LCD Projector while connecting to computer equipment, in order to protect both the LCD Projector and the equipment being connected
- The RGB input accepts signals from VGA and MAC compatible computers without the need for any additional hardware
- Plug the VGA signal cable (supplied) correctly into the RGB IN terminal on the LCD Projector and into the RGB signal output terminal on the computer, and secure the plugs by tightening the thumb screws
- Connect the MAC/VGA adaptor (supplied) to the RGB-signal output or input terminal on your Macintosh Series computer. Then, firmly plug the VGA signal cable into both the RGB IN or RGB OUT terminal on the LCD projector and the MAC/VGA adaptor on the computer, and secure the plugs by tightening the thumb screws
- To view images simultaneously on the monitor and projection screen, connect your computer monitor to the LCD Projector's RGB OUT terminal
- When connecting the LCD Projector to a compatible computer other than a VGA or Macintosh series, a separate cable is needed

### 1. PC (Desk Top)

(Diagram numbers correspond with numbers on page 12)

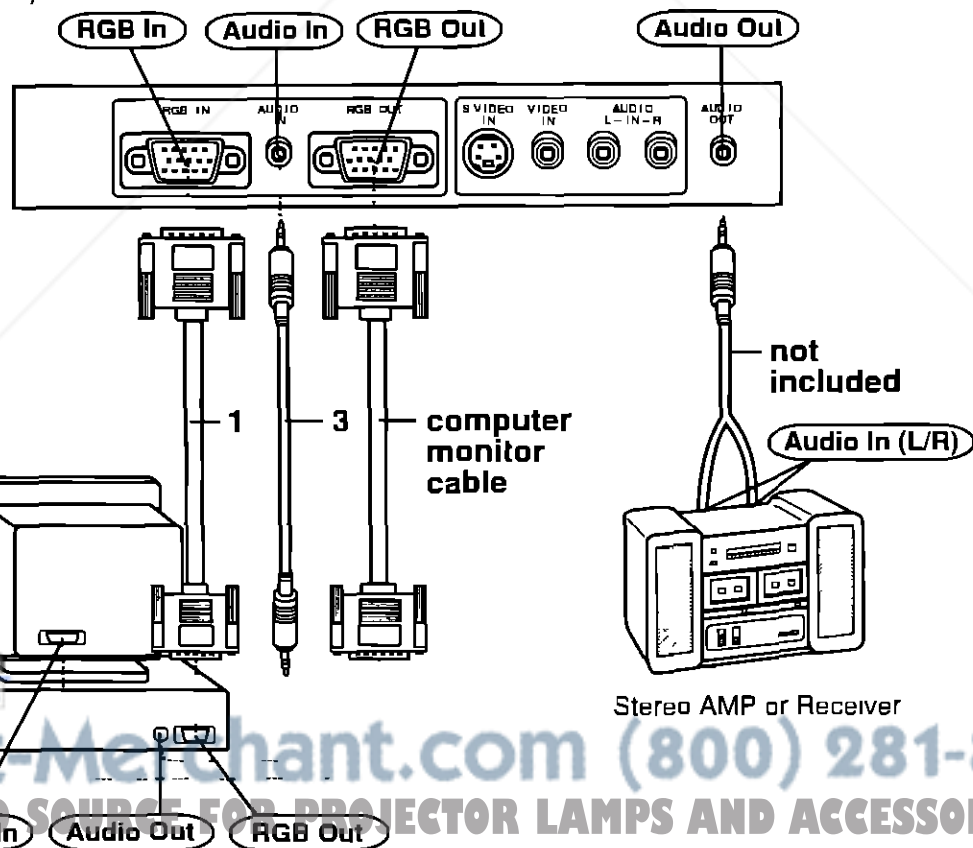



## 2. PC (Lap Top)

(Diagram numbers correspond with numbers on page 12)

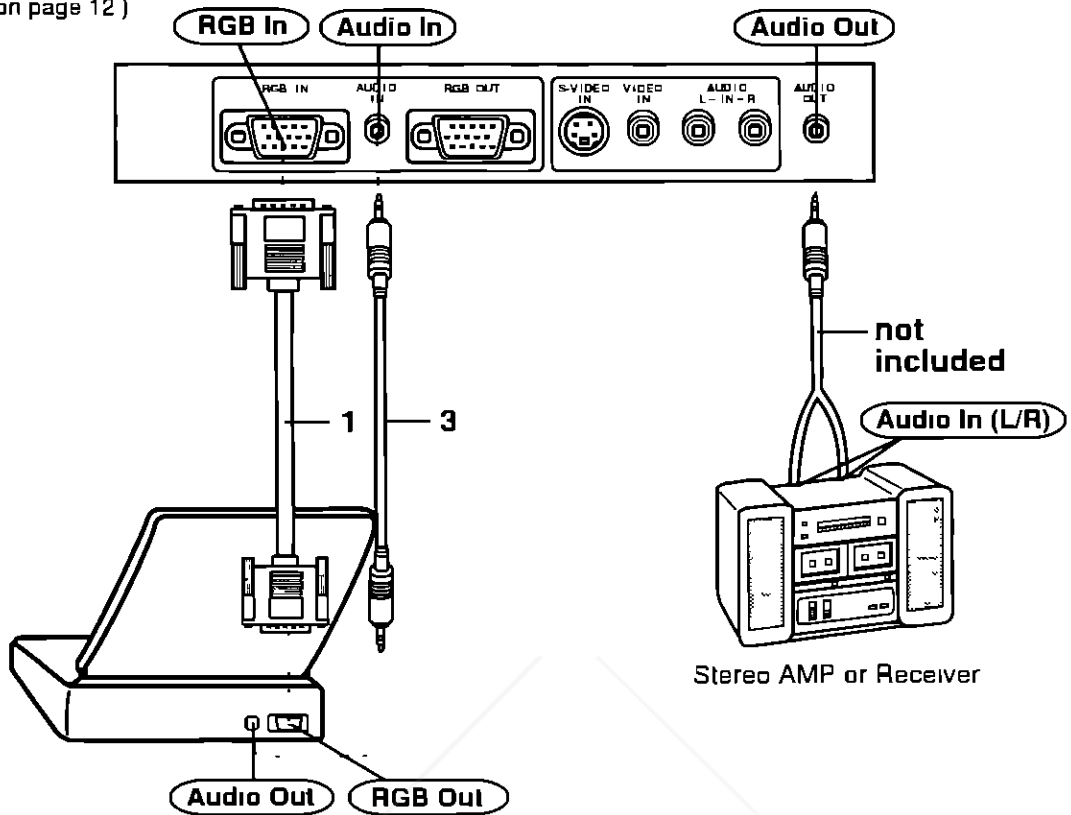

## 3. Macintosh (Desk Top)

(Diagram numbers correspond with numbers on page 12)

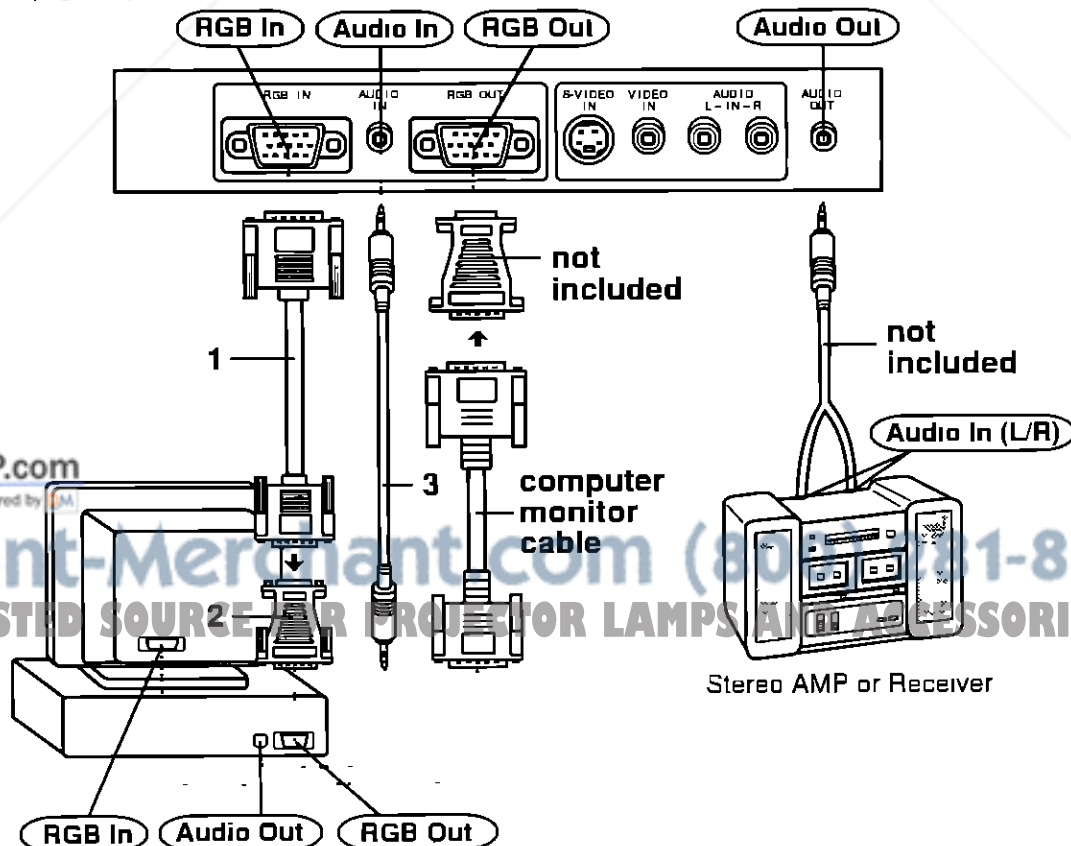

## 4. Macintosh (Power Book)

(Diagram numbers correspond with numbers on page 12)

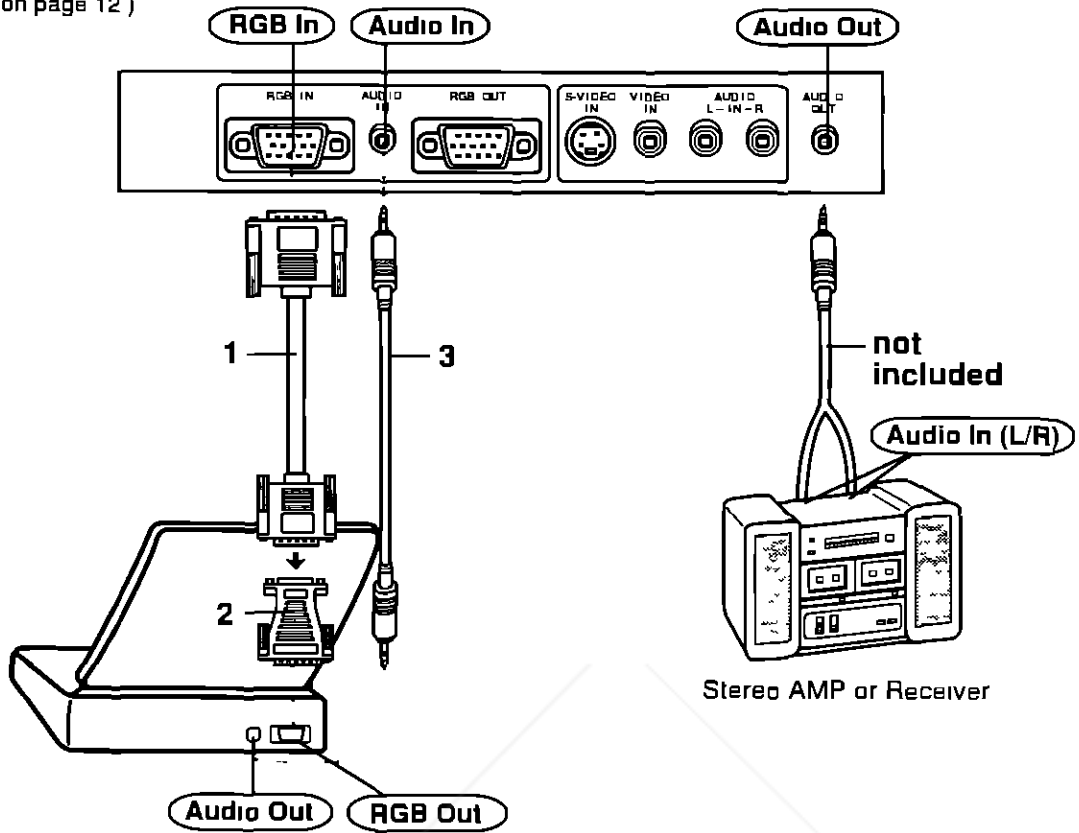

## 5. Macintosh (Power Mac)

(Diagram numbers correspond with numbers on page 12)

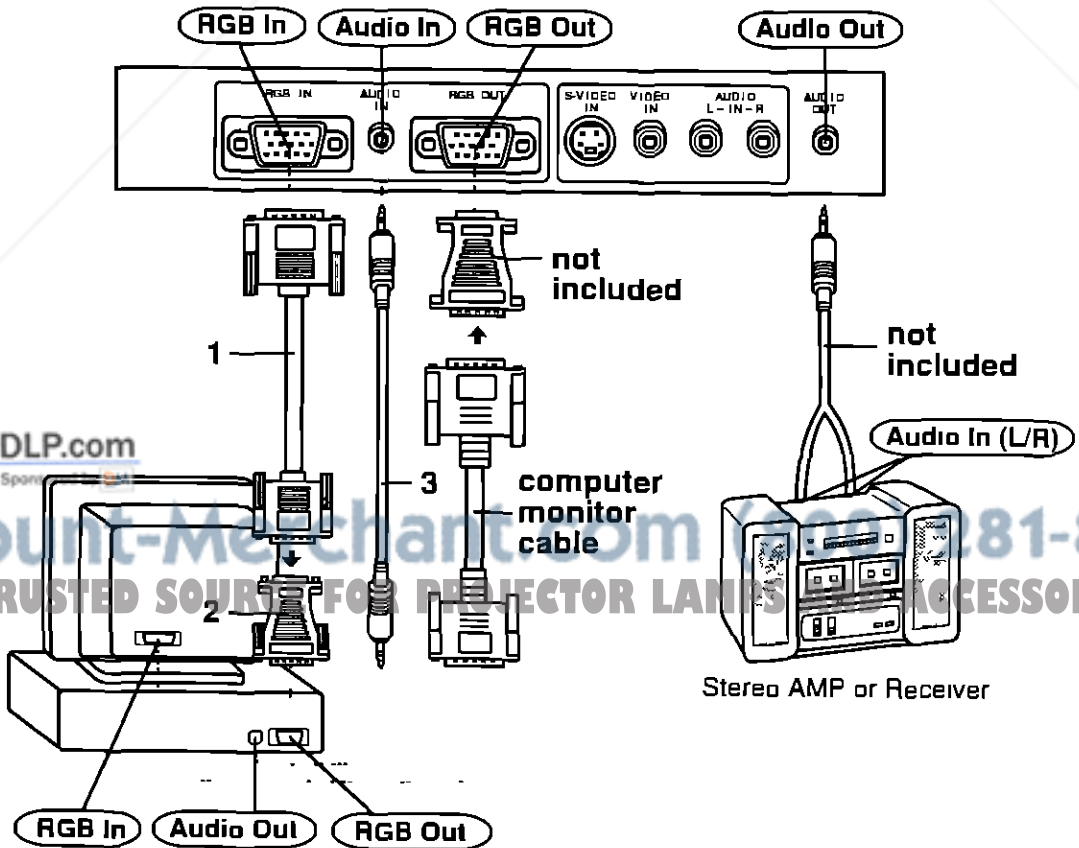

# Basic LCD Projector Operation

## Before you begin, make sure...

- All connections are made (See pages 10 and 13 to 16 )
- LCD Projector is positioned properly (See page 9 )
- LCD Projector is plugged in.
- Lens cap is removed.
- You have read Important Safeguards (See pages 2, 3 )

### 1 Press the Main Power Switch ON.

The STAND BY(R) ON(G) indicator lights red on the top panel

- The first time you turn on the power, or whenever the STAND BY(R) ON(G) indicator is not lit, press the Main Power Switch (ON/OFF) to turn on the power

### 2 Press POWER on the LCD Projector or remote control ON

When POWER is turned on, the red STAND BY(R) ON(G) indicator changes to green

When POWER is turned off, the green STAND BY(R) ON(G) indicator changes to flashing red while the LCD Projector cools down and then to solid red when fan stops

When the power is on, the STAND BY(R) ON(G) indicator indicates the operating condition of the lamp	
Red	Main Power On (Lamp Off)
Green	lamp is ready
Flashing green	warming up
Flashing red	Cooling Fan operating

See page 26, "Maintenance Indicators", for details

### 3 Open control panel door and press INPUT, or press INPUT on the remote control to select the desired input mode

Continue to press INPUT to set the desired input mode  
Each press will change the display as shown below

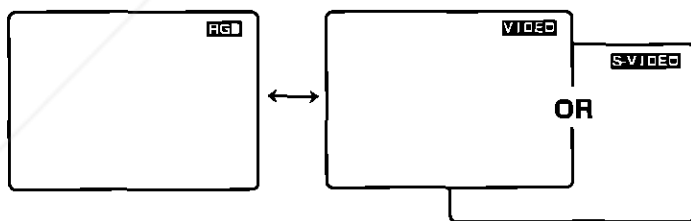

FixYourDI.com  
If units connected with both VIDEO and S-VIDEO cables, the S-VIDEO mode has priority

### 4 Turn on your computer (RGB) or start video playback (Video or S-Video).

- Adjust FOCUS and ZOOM Rings if necessary

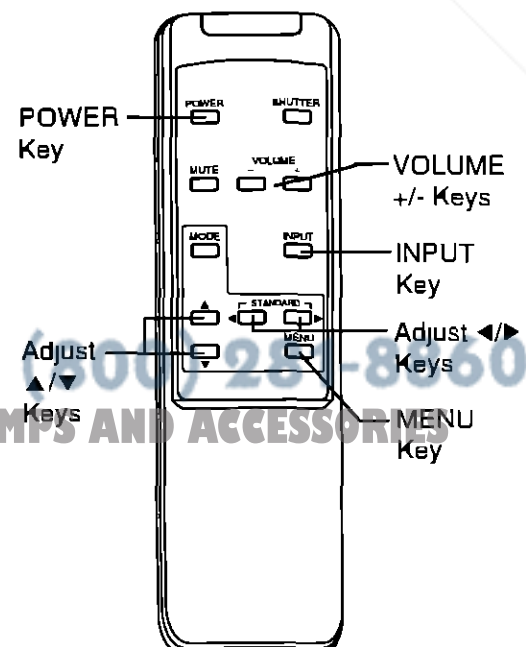
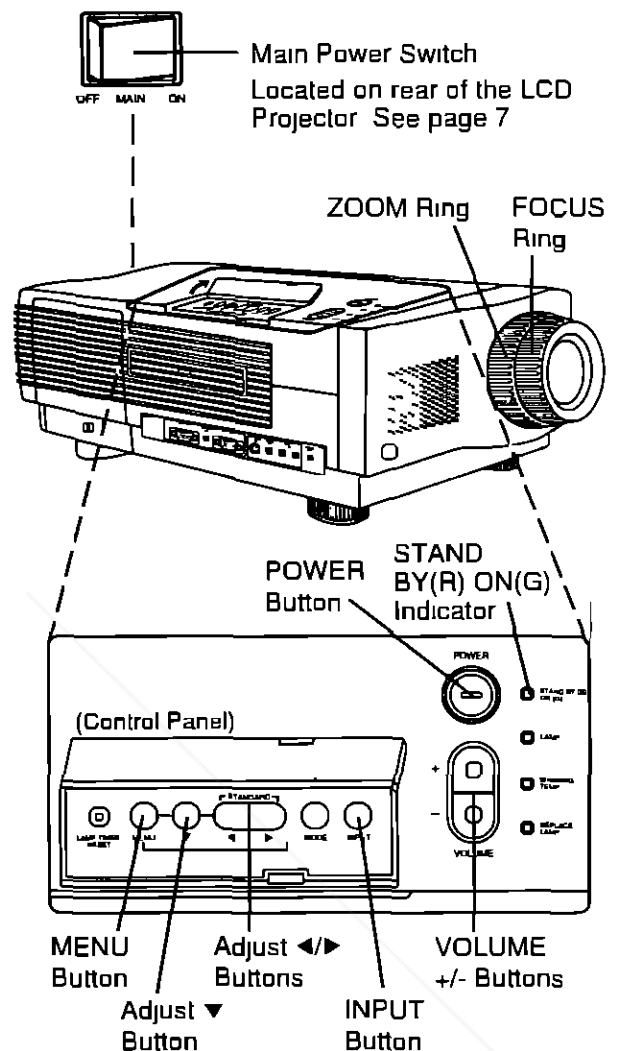

- 5 Press VOLUME +/-** on the LCD Projector or remote control to adjust the volume level of the built-in speaker
- The number of segments (0 - 63) increases or decreases as the volume is adjusted

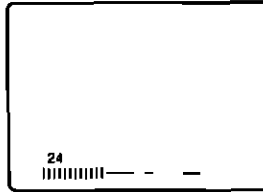

**6 Press POWER on the LCD Projector or remote control OFF.**

- Do not turn off the Main Power Switch until the LCD Projector cooling fan has stopped and STAND BY(R) ON(G) indicator turns solid red.



You may use keys on the remote control or buttons on the LCD Projector for the following operation

**● Rear Screen Mode Projection**

The image can be flipped to a mirror image of the input video signal for rear screen projection  
See page 5 for illustration

- 1 Press **MENU** to display the menu
- 2 Press **▲** or **▼** to select **SET UP PROJECTOR**, and then **◀** or **▶** to display the screen
- 3 Press **◀** or **▶** to select "ON" or "OFF"
  - Select OFF to return to the standard projection format
  - Select ON to flip to a mirror image of the input signal
- 4 Press **MENU** twice to exit

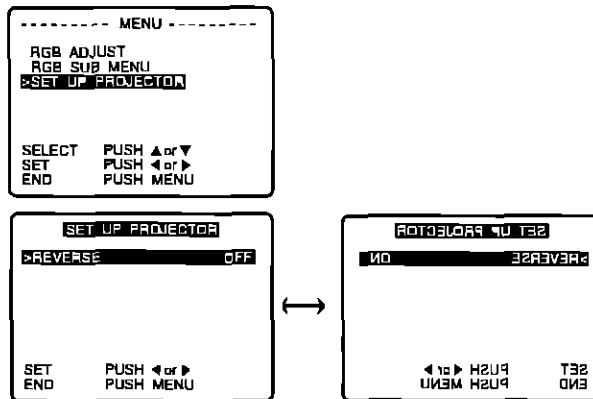

**Discount-Merchant.com (800) 281-8860**  
THE TRUSTED SOURCE FOR PROJECTOR LAMPS AND ACCESSORIES

# Projected Image Adjustment

This LCD projector's picture is set to standard specifications at the factory. However, you can adjust the image to suit your own preferences by using the VIDEO or RGB ADJUST feature. Three memory modes allow you to adjust and save up to three sets of settings for each input signal (S-VIDEO/ VIDEO and RGB). For video signal input, five items can be adjusted "COLOR", "TINT", "BRIGHT", "PICTURE", and "SHARPNESS". For RGB signal input, six items can be adjusted "BRIGHT", "PICTURE", "V POS", "H POS", "H SIZE", and "PHASE".

## Video Input Image Adjustment

S-VIDEO or VIDEO input is selected (page 17)  
Use buttons on the remote control or LCD Projector

**1 Press MENU** to display the menu

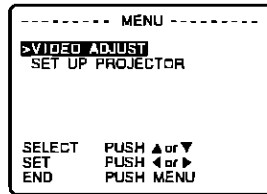

**2 Press ▲ or ▼** to select VIDEO ADJUST, and ◀ or ▶ to display the screen

- 3 different sets of control adjustments can be memorized for different projection situations

**3 Press MODE repeatedly** to choose one of the three memory modes for adjustment (page 21)

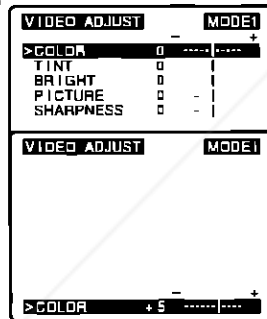

**4 Press ▲ or ▼** to select, and ◀ or ▶ to display the item to be adjusted

**5 Press ◀ or ▶** to adjust as described below

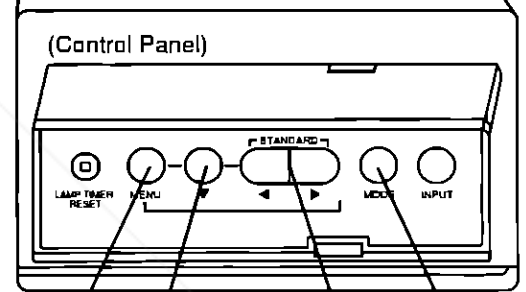
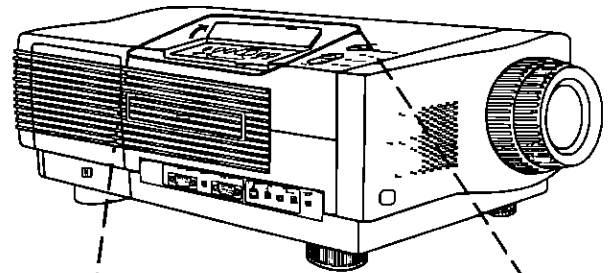

MENU Button    Adjust ▼ Button    Adjust ◀/▶ Buttons    MODE Button

### Adjustments For S-Video/ Video Input

#### COLOR Control (Adjust color intensity level)

Press ▶ to deepen the color  
Press ◀ to make the color paler

#### TINT Control (Adjust hue for realistic tones)

Press ▶ for more green  
Press ◀ for more purple

#### BRIGHT Control (Adjust black level to room brightness)

Press ▶ to brighten the image  
Press ◀ to darken the background

#### PICTURE Control (Adjust overall picture intensity)

Press ▶ for a stronger picture  
Press ◀ for a fainter picture

#### SHARPNESS Control (Adjust picture sharpness)

Press ▶ to sharpen the edges of the image  
Press ◀ to soften the edges of the image

#### Recall Standard Settings

Press ◀ and ▶ together. If the menu showing all items is displayed, all items will be reset. If a single item is displayed, only that item will be reset.

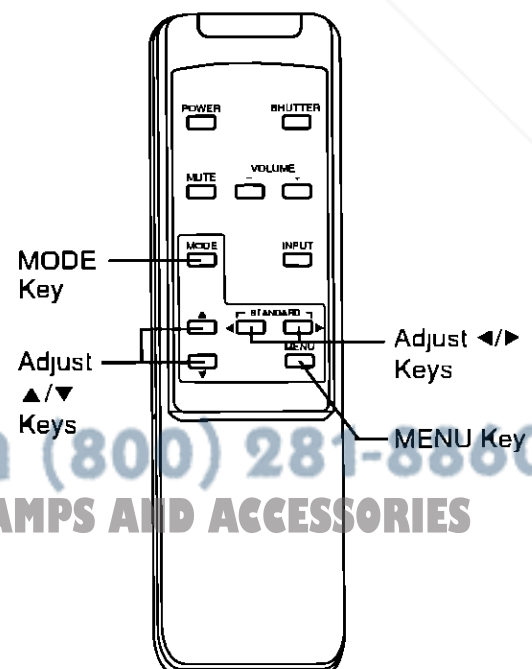

**6 Press MENU once** to display the video adjust menu, **or twice** to exit

## RGB Input Image Adjustment

RGB input is selected (page 17)

Use buttons on the remote control or LCD Projector For V POS, H POS, and H SIZE adjustments, see the PC output timing relative value chart at right

- 1 Press MENU** to display the menu
- 2 Press ▲ or ▼** to select RGB ADJUST, and **◀ or ▶** to display the screen
  - 3 different sets of control adjustments can be memorized to accommodate for different projection situations
- 3 Press MODE repeatedly** to choose one of the three memory modes for adjustment (page 21)
- 4 Press ▲ or ▼** to select, and **◀ or ▶** to display the item to be adjusted
- 5 Press ◀ or ▶** to adjust as described below

## PC Output Timing Relative Value Chart

Model	Vertical Position	Horizontal Position	Horizontal size
MAC 640	-28 - +32	-24 - +24	-50 - +90
VGA	-20 - +32	-24 - +24	-50 - +90
VGA350	-10 - + 5	-24 - +24	-50 - +90
VGA400	-10 - + 5	-24 - +24	-50 - +90
MAC LC	-16 - + 8	-24 - +24	-50 - +90
VESA	-16 - +32	-24 - +24	-50 - +50

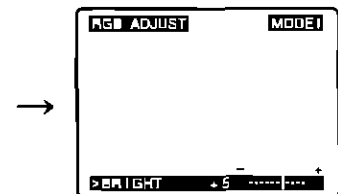
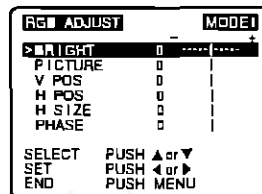
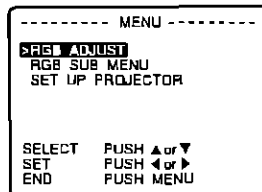

### Adjustments For RGB Input

#### BRIGHT Control

(Adjust black level to room brightness)  
 Press ▶ to brighten the image  
 Press ◀ to darken the background

#### PICTURE Control

(Adjust overall picture intensity)  
 Press ▶ for a stronger picture  
 Press ◀ for a fainter picture

#### V POS (Vertical Position) Control

(Adjust vertical position within projected screen)  
 Press ◀ to move down or ▶ to move up

#### H POS (Horizontal Position) Control

(Adjust horizontal position within projected screen)  
 Press ◀ to move left or ▶ to move right

#### H (Horizontal) SIZE Control

(Adjust data display, timing, and attain the correct horizontal image size)  
 Press ◀ or ▶ until screen is free of black lines  
 Use test pattern shown at right

#### PHASE Control

(Adjust vertical line strength so that text is readable)  
 Press ◀ or ▶ so that the white horizontal lines are clear and distinct. Use test pattern shown at right

#### Recall Standard Settings (only BRIGHT and PICTURE)

Press ◀ and ▶ together. If the menu showing all items is displayed, BRIGHT and PICTURE will be reset. If a single item is displayed, only that item will be reset.

#### Vertical Position



#### Horizontal Position

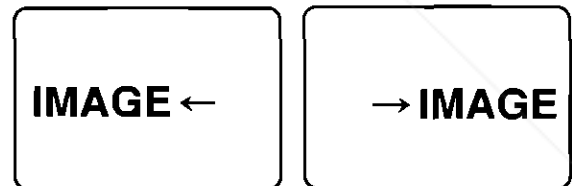

#### Horizontal Size

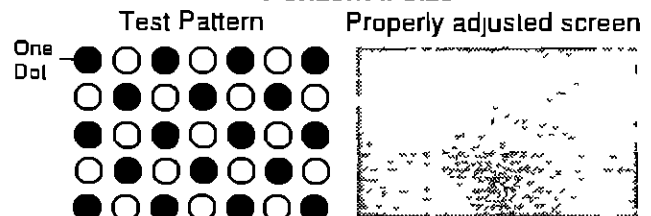

#### Phase

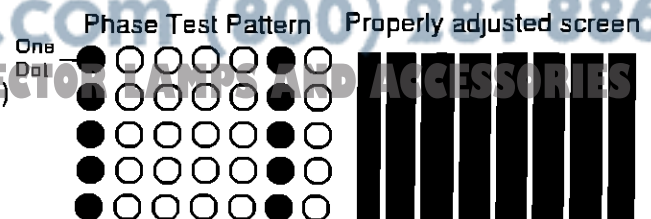

- 6 Press MENU once** to redisplay the RGB ADJUST menu, **or twice** to exit

## Adjusting the RGB Input Levels

RGB input levels are preset at the factory and in most cases will not need adjustment. However, depending on the connected computer, the levels may need adjustment. Up to 3 sets of parameters can be memorized for RGB input.

**1 Press MENU** to display the menu

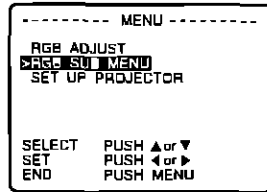

**2 Press ▲ or ▼** to select RGB SUB MENU, and then **◀ or ▶** to display the screen

- 3 different sets of control adjustments can be memorized to accommodate for different projection situations

**3 Press MODE repeatedly** to choose one of the three memory modes for adjustment

**4 Press ▲ or ▼** to select, and **◀ or ▶** to display the item to be adjusted

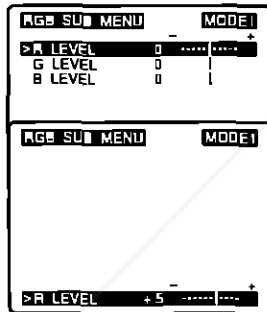

**5 Press ◀ or ▶** to adjust the value level

### Recall Standard Settings

Press **◀** and **▶** together. If the menu showing all items is displayed, all items will be reset. If a single item is displayed, only that item will be reset.

- Factory setting is "0" for each R, G and B level

**6 Press MENU once** to return to the RGB input level menu **or twice** to exit

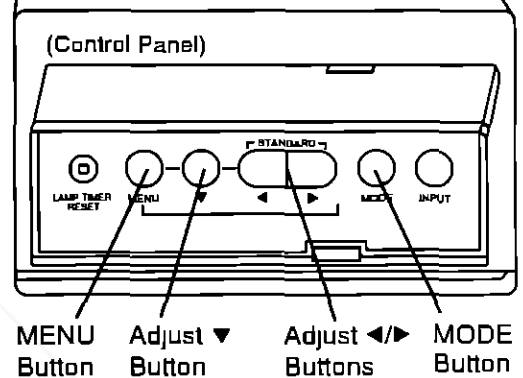
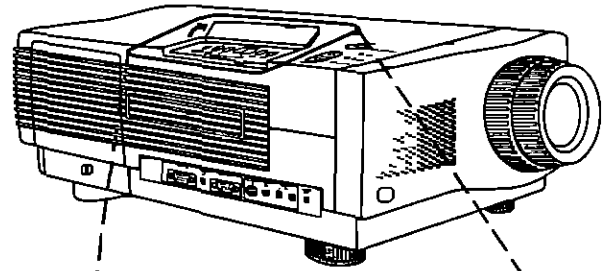

MENU Button    Adjust ▼ Button    Adjust ◀/▶ Buttons    MODE Button

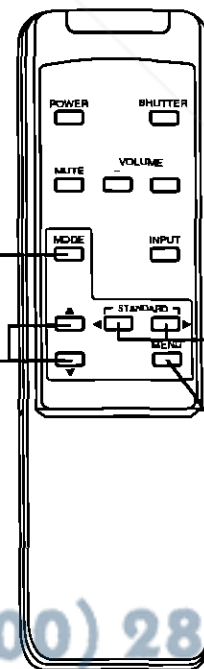

MODE Key    Adjust ▲/▼ Keys    Adjust ◀/▶ Keys    MENU Key

## Selecting the Picture Memory

Press MODE on the remote control or LCD Projector to select the desired picture mode

When MODE is pressed, the preset settings will first be displayed on the screen for about 5 seconds

- Each time you press MODE, the display will change as shown below

▶ MODE1 ▶ MODE2 ▶ MODE3

# Timing Specifications

## Separate Sync.

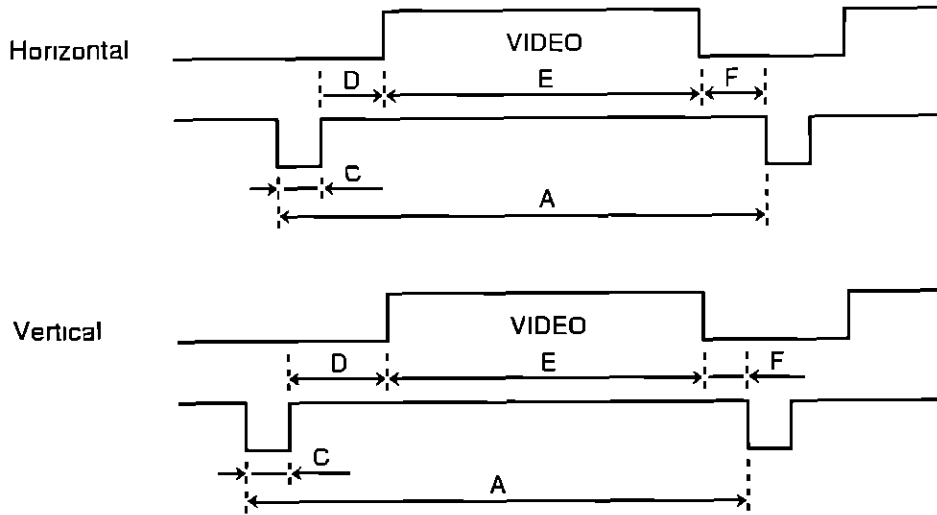

## H/V Composite Sync.

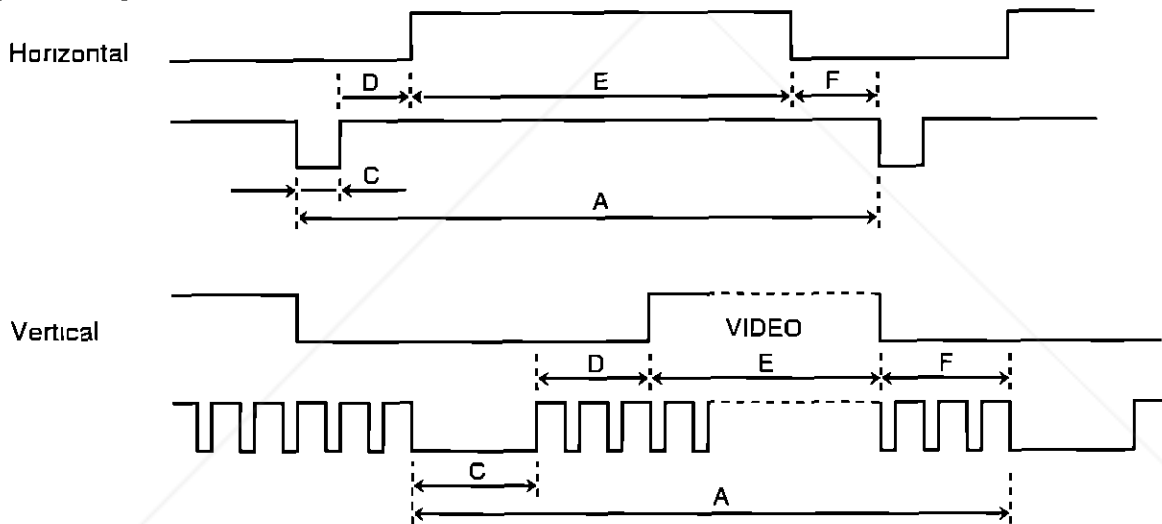

## Sync. on Green

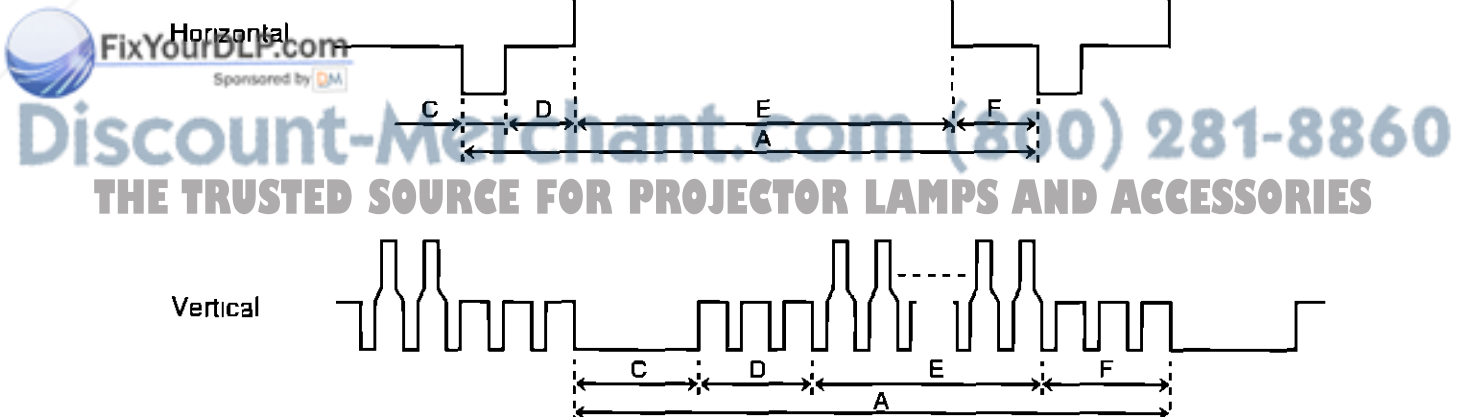



# Factory Preset Timing

		Preset timing		
		IBM 640 X 400 at 70 Hz	IBM 640 X 350 at 70 Hz	IBM 640 X 480 at 60 Hz
DOT CLOCK		25 1745 MHz	25 1745 MHz	25 1745 MHz
H O R I Z	f H	31 4681 KHz	31 4681 KHz	31 4681 KHz
	A - PERIOD	31 778 µs ( 800 dots)	31 778 µs ( 800 dots)	31 778 µs ( 800 dots)
	B - BLANKING	6 356 µs ( 160 dots)	6 356 µs ( 160 dots)	6 356 µs ( 160 dots)
	C - SYNC WIDTH	3 813 µs ( 96 dots)	3 813 µs ( 96 dots)	3 813 µs ( 96 dots)
	D - BACK PORCH	1 907 µs ( 48 dots)	1 907 µs ( 48 dots)	1 907 µs ( 48 dots)
	E - ACTIVE TIME	25 423 µs ( 640 dots)	25 423 µs ( 640 dots)	25 423 µs ( 640 dots)
	F - FRONT PORCH	0 636 µs ( 16 dots)	0 636 µs ( 16 dots)	0 636 µs ( 16 dots)
V E R T	f V	70 0849 Hz	70 0849 Hz	59 939 Hz
	A - PERIOD	14 268 ms ( 449 lines)	14 268 ms ( 449 lines)	16 684 ms ( 525 lines)
	B - BLANKING	1 557 ms ( 49 lines)	3 146 ms ( 99 lines)	1 430 ms ( 45 lines)
	C - SYNC WIDTH	0 064 ms ( 2 lines)	0 064 ms ( 2 lines)	0 064 ms ( 2 lines)
	D - BACK PORCH	1 112 ms ( 35 lines)	1 907 ms ( 60 lines)	1 049 ms ( 33 lines)
	E - ACTIVE TIME	12 711 ms ( 400 lines)	11 122 ms ( 350 lines)	15 253 ms ( 480 lines)
	F - FRONT PORCH	0 381 ms ( 12 lines)	1 176 ms ( 37 lines)	0 318 ms ( 10 lines)
SYNC POLARITY (H/V)		Negative / Positive	Positive / Negative	Negative / Negative

		Reservation timing		
		VESA 640 X 480 at 72 Hz	MAC II 640 X 480	MAC LC 640 X 480
DOT CLOCK		31 5 MHz	30 2410 MHz	31 334 MHz
H O R I Z	f H	37 861 KHz	35 0012 KHz	34 97 KHz
	A - PERIOD	26 413 µs ( 832 dots)	28 570 µs ( 864 dots)	28 598 µs ( 896 dots)
	B - BLANKING	6 095 µs ( 192 dots)	7 407 µs ( 224 dots)	8 171 µs ( 256 dots)
	C - SYNC WIDTH	1 270 µs ( 40 dots)	2 803 µs ( 63 dots)	2 043 µs ( 64 dots)
	D - BACK PORCH	4 063 µs ( 128 dots)	3 241 µs ( 98 dots)	2 426 µs ( 76 dots)
	E - ACTIVE TIME	20 317 µs ( 640 dots)	21 163 µs ( 640 dots)	20 425 µs ( 640 dots)
	F - FRONT PORCH	0 762 µs ( 24 dots)	2 083 µs ( 63 dots)	3 702 µs ( 116 dots)
V E R T	f V	72 8808 Hz	66 6689 Hz	66 61 Hz
	A - PERIOD	13 735 ms ( 520 lines)	15 000 ms ( 525 lines)	15 013 ms ( 525 lines)
	B - BLANKING	1 057 ms ( 40 lines)	1 286 ms ( 45 lines)	1 287 ms ( 45 lines)
	C - SYNC WIDTH	0 079 ms ( 3 lines)	0 086 ms ( 3 lines)	0 086 ms ( 3 lines)
	D - BACK PORCH	0 740 ms ( 28 lines)	1 114 ms ( 39 lines)	1 115 ms ( 39 lines)
	E - ACTIVE TIME	12 678 ms ( 480 lines)	13 714 ms ( 480 lines)	13 726 ms ( 480 lines)
	F - FRONT PORCH	0 238 ms ( 9 lines)	0 086 ms ( 3 lines)	0 886 ms ( 3 lines)
SYNC POLARITY (H/V)		Negative / Negative	Sync on Green or Composit	Negative / Negative

		Reservation timing		
		VESA 640 X 350 at 85 Hz	VESA 640 X 400 at 85 Hz	VESA 640 X 480 at 75 Hz
DOT CLOCK		31 5 MHz	31 5 MHz	31 5 MHz
H O R I Z	f H	37 861 KHz	37 861 KHz	37 500 KHz
	A - PERIOD	26 413 µs ( 832 dots)	26 413 µs ( 832 dots)	26 667 µs ( 840 dots)
	B - BLANKING	6 095 µs ( 192 dots)	6 095 µs ( 192 dots)	6 349 µs ( 200 dots)
	C - SYNC WIDTH	2 032 µs ( 64 dots)	2 032 µs ( 64 dots)	2 032 µs ( 64 dots)
	D - BACK PORCH	3 048 µs ( 96 dots)	3 048 µs ( 96 dots)	3 809 µs ( 120 dots)
	E - ACTIVE TIME	20 317 µs ( 640 dots)	20 317 µs ( 640 dots)	20 317 µs ( 640 dots)
	F - FRONT PORCH	1 016 µs ( 32 dots)	1 016 µs ( 32 dots)	0 507 µs ( 16 dots)
V E R T	f V	85 080 Hz	85 080 Hz	75 0000 Hz
	A - PERIOD	11 754 ms ( 445 lines)	11 754 ms ( 445 lines)	13 333 ms ( 500 lines)
	B - BLANKING	2 509 ms ( 95 lines)	1 189 ms ( 45 lines)	0 533 ms ( 20 lines)
	C - SYNC WIDTH	0 079 ms ( 3 lines)	0 079 ms ( 3 lines)	0 080 ms ( 3 lines)
	D - BACK PORCH	1 585 ms ( 60 lines)	1 083 ms ( 41 lines)	0 427 ms ( 16 lines)
	E - ACTIVE TIME	9 244 ms ( 350 lines)	10 565 ms ( 400 lines)	12 800 ms ( 480 lines)
	F - FRONT PORCH	0 845 ms ( 32 lines)	0 026 ms ( 1 line )	0 027 ms ( 1 line )
SYNC POLARITY (H/V)		Positive / Negative	Negative / Positive	Negative / Negative

# Maintenance

## Air Filter

The air filter should be cleaned about every 100 hours. Also, clean the air filter if the WARNING TEMP indicator lights up. Clean the filter more often when the projector is used in a dusty or smoky location. Replace the filter when it is clogged or dirty even after cleaning. Order new filter part number ET-AF201.

## Cleaning the Filter

Tools required Vacuum Cleaner

- Wait until the cooling fan stops and the STAND BY(R) ON(G) indicator turns off

**1 Set the Main Power Switch to OFF and unplug the power cord.**

**2 Remove the Filter Holder.**

Place the Projector on its side with the handle facing up. Grasp the filter holder by the depressed portion and slide it out to remove.

**3 Remove the Filter.**

Hold the filter holder and lift up on the long tab to remove the filter from the filter holder.

**4 Clean the Filter.**

Gently remove any accumulated dust from the air filter with your vacuum cleaner.

**CAUTION:** Operating LCD Projector with torn or damaged Filter may cause damage to LCD Projector.

**5 Replace the Filter.**

Replace the air filter so that all the locking tabs snap into place in the filter holder.

**6 Replace the Filter Holder.**

Line up the filter so that the guide tabs of the LCD Projector fit into the grooves in the sides of the Filter Holder and slide it back into place.

### Note:

- The LCD Projector power cannot be turned on unless the filter holder is correctly installed.

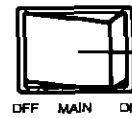
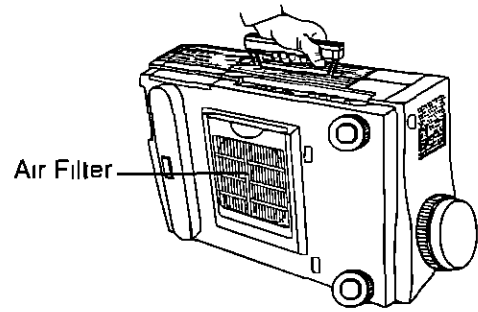

Main Power Switch  
Located on rear of the LCD Projector. See page 7.

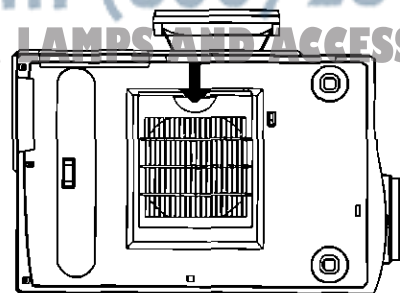
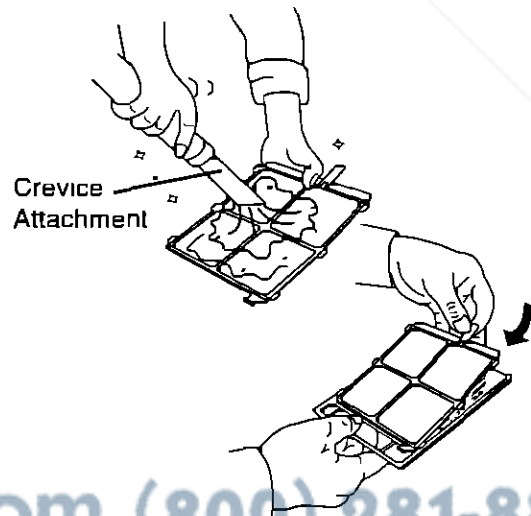
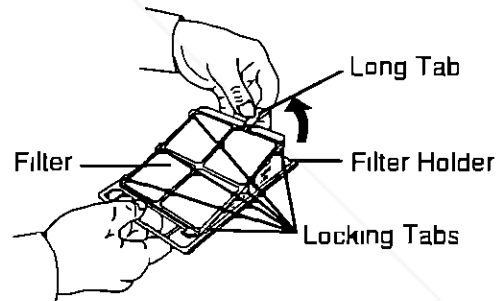
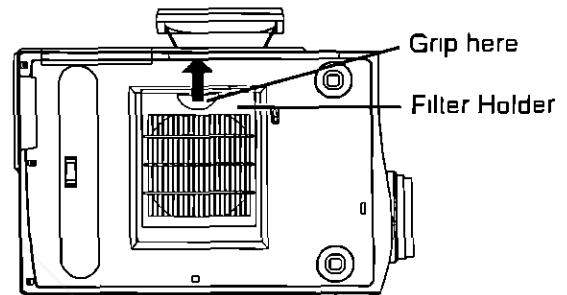

# Maintenance

## Lamp

The LCD Projector lamp has a limited operating life of approximately 1100 hours. "LAMP TIME REMAINING 100h" will be displayed on-screen when operation time reaches 1000 hours. Then, each time the power is turned on, the Lamp life remaining will be displayed.

- A 10 second warning display (20 seconds when the LCD Projector power is turned on) will appear every 10 hours from 1000 hours of operation until 1090 hours. The warning will then be displayed every hour from 1090 hours of operation time. The warning display will flash from 1100 hours and continue to be displayed in negative digits.

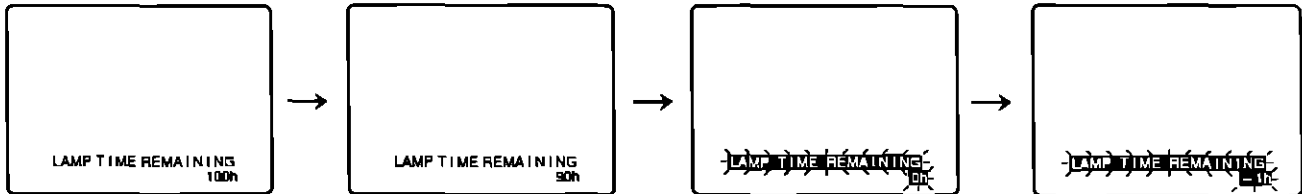

## Lamp Replacement

Order Lamp ET-LA201

Tools required: A coin

- 1 After the cooling fan has stopped, and **STAND BY(R)** **ON(G)** indicator turns solid red. Set the Main Power Switch to OFF. Then, unplug the LCD Projector by removing Power cord from LCD Projector AC socket.

- 2 First read caution and warning labels on Lamp cover. Then, remove the Lamp cover screw (1) by using coin, and take off the lamp cover.

- 3 Caution, be very careful. Lamp housing may still be hot to touch. Remove the lamp unit screw (1), then grasp the Lamp unit handle and carefully pull it from the LCD Projector. Keep Lamp housing opening to your right. Do not touch Lamp or point Lamp opening at anyone.

**WARNING:** The lamp may be hot. Be careful when handling.

**CAUTION:** High-pressure lamp may explode if improperly handled.

- 4 Carefully remove Lamp ET-LA201 from its package now. Do not touch Lamp or point Lamp opening at anyone. Do not drop, impact of dropping may cause Lamp to explode. Install a new lamp unit (ET-LA201) available from your Panasonic Service Center.

- 5 Replace the Lamp unit screw and the Lamp cover screw using a coin to tighten.

- 6 Plug the LCD Projector back in by inserting Power cord in LCD Projector AC socket and set the Main Power Switch to ON.

- 7 Press the LAMP TIMER RESET button by using a ball point pen. Do not reset unless Lamp is replaced. The Lamp Replacement indicator goes out.

- 8 Properly dispose of old Lamp.

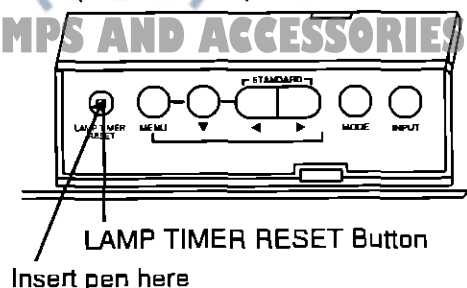
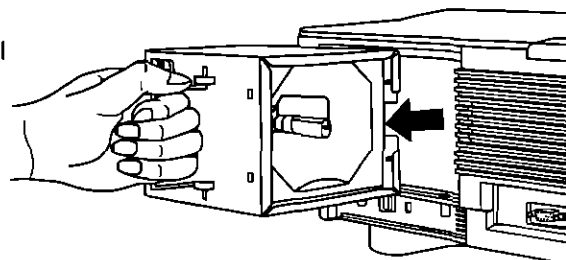
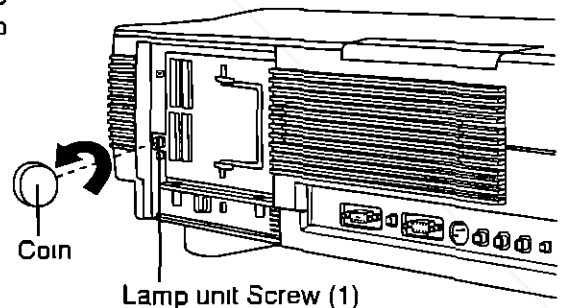
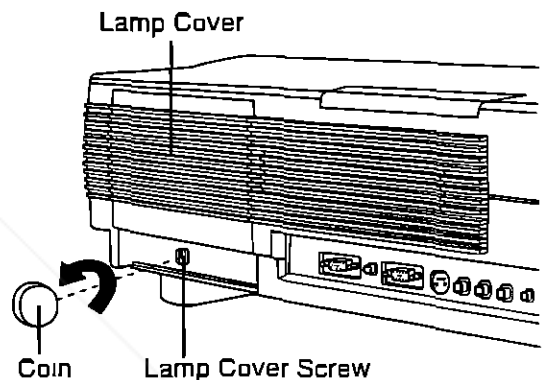

# Maintenance

## Warning Indicators

The warning lights on the LCD Projector indicate problems inside the projector

- There are three warning lights, a LAMP indicator which warns of a problem with the lamp, a WARNING TEMP indicator which warns that the projector is too hot, and a REPLACE LAMP indicator which lets you know when to change the bulb
- If a problem causes either the LAMP indicator or the WARNING TEMP indicator to light red, the power will automatically shut off. After turning off the Main Power Switch, follow the procedures given below

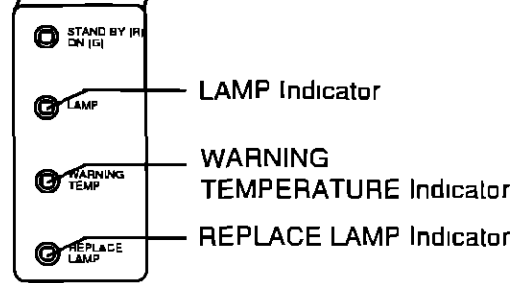
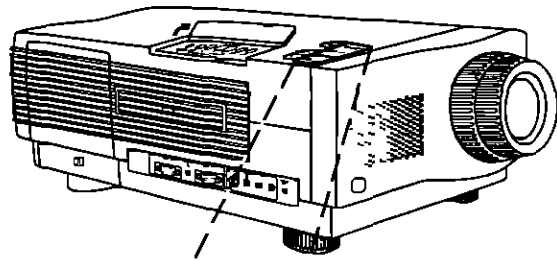

Warning Indicator	Symptom	Problem	Possible Solution
LAMP indicator	The lamp does not light up	<ul style="list-style-type: none"> <li>- Burnt-out lamp</li> <li>- Lamp circuit failure</li> </ul>	- Take the projector to your nearest Panasonic Service Center
WARNING TEMP indicator	The internal temperature is abnormally high	- Blocked air intake	- Relocate projector to a proper location
		- Clogged air filter	- Clean the filter (See page 24)
		<ul style="list-style-type: none"> <li>- Cooling fan breakdown</li> <li>- Internal circuit failure</li> </ul>	- Take the projector to your nearest Panasonic Service Center
	The power cannot be turned on	- Misinstalled Filter Holder	- Filter Holder is properly installed (See page 24)
REPLACE LAMP indicator	REPLACE LAMP indicator starts flashing red 100 hours before lamp is completely used up. The indicator then turns to solid red		- Replace the lamp (See page 25)

### Notes:

- If the WARNING TEMP indicator light comes on after servicing, please wait until the projector has cooled down completely before turning the power back on (At least 5 minutes)
- When the power is turned off and then turned on again, as during a brief rest, the LAMP indicator may be lit, preventing the power from going on. When this happens, unplug the power plug from the AC outlet and plug it back in again.

**Discount-Merchant.com (800) 281-8860**  
**THE TRUSTED SOURCE FOR PROJECTOR LAMPS AND ACCESSORIES**

# Trouble Shooting

If the LCD Projector unit fails, check the following before calling your dealer for service

## Troubleshooting Chart

Yes ———> No - - - ->

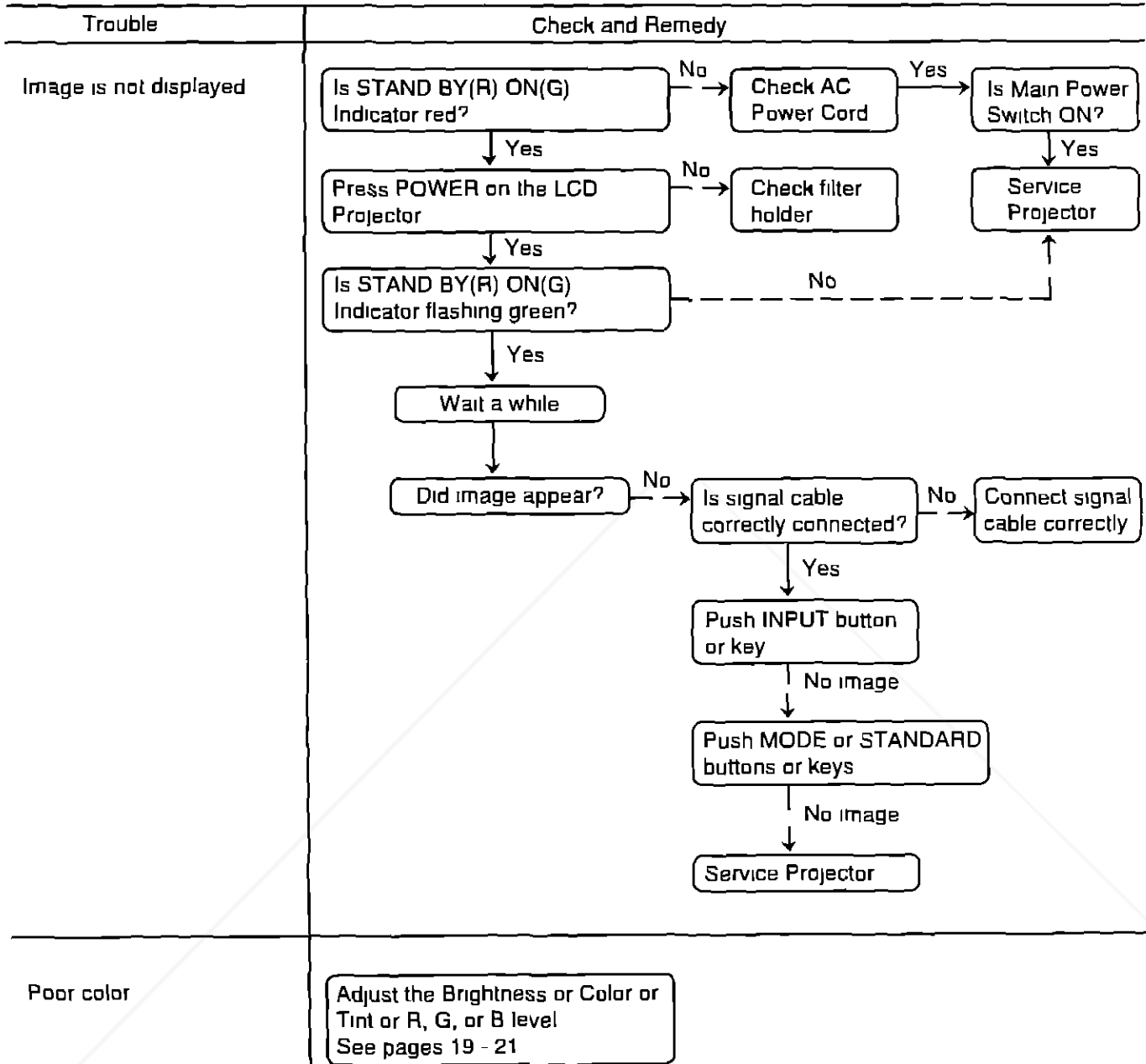

**Discount-Merchant.com (800) 281-8860**  
**THE TRUSTED SOURCE FOR PROJECTOR LAMPS AND ACCESSORIES**

Trouble	Check and Remedy
Image is blurred	<pre> graph TD     A[Adjust the Focus Ring] -- Yes --&gt; B{Is the distance between LCD Projector and screen correct?}     B -- No --&gt; B1[Adjust the distance]     B -- Yes --&gt; C{Has the lens become dirty?}     C -- Yes --&gt; C1[Clean the lens]     C -- No --&gt; D{Are signal connection pin assignments correct? See page 12}     D -- No --&gt; D1[Use a signal connector with correct pin assignments]     D -- Yes --&gt; E{Is signal cable connected correctly?}     E -- No --&gt; E1[Connect signal cable correctly]                     </pre>
Image does not match up with projector screen	<pre> graph TD     A{Is computer in 640 X 480 mode?} -- No --&gt; A1[Change computer to 640 X 480 mode]     A -- Yes --&gt; B[Adjust the H-position or V-position See page 21]                     </pre>
Picture rolls	<pre> graph TD     A{Are signal connector pin assignments correct? See page 12} -- No --&gt; A1[Use a signal connector with correct pin assignments]     A -- Yes --&gt; B{Is signal cable connected correctly?}     B -- No --&gt; B1[Connect signal cable correctly]     B -- Yes --&gt; C{Does computer's sync signals match LCD Projector specifications (See pages 22 - 23 specifications, Input signals, Horizontal frequency &amp; Vertical frequency)}                     </pre>



Discount-[www.fixyourdlp.com](http://www.fixyourdlp.com) (800) 281-8860  
 THE TRUSTED SOURCE FOR PROJECTOR LAMPS AND ACCESSORIES

Yes ———> No - - ->

Trouble	Check and Remedy
No sound	<pre> graph TD     Q1[Check if Audio cable is correctly connected] -- No --&gt; R1[Connect Audio cable correctly]     Q1 -- Yes --&gt; Q2[Push INPUT button or key]     Q2 -- No --&gt; Q3[Push VOLUME + button or key]           </pre>
LCD Projector can not be remote controlled	<pre> graph TD     Q1[Are remote control batteries fresh?] -- No --&gt; R1[Replace the batteries See page 8]     Q1 -- Yes --&gt; Q2[Is remote sensor on the unit blocked by obstacles?]     Q2 -- Yes --&gt; R2[Remove all obstacles]     Q2 -- No --&gt; Q3[Are operating distance and angle within specifications? Distance 23 feet (7m) Angle 30°]           </pre>



**Discount-Merchant.com (800) 281-8860**  
**THE TRUSTED SOURCE FOR PROJECTOR LAMPS AND ACCESSORIES**

## Safety Precautions

- **If the LCD Projector is not operating properly, immediately switch it off and call the dealer where you purchased the unit**  
Do not operate the unit if it emits any smoke, an abnormal noise, or a foul odor. Immediately unplug the power cable from the electrical outlet and call your dealer.
- **Caution: Never remove the rear cover.**  
To prevent electric shock, do not remove the rear cover. There are no user serviceable parts inside. Refer servicing to qualified service personnel.
- **Do not put anything inside the unit.**  
If anything accidentally gets into the unit, unplug the power cable and call your dealer. Continued operation may cause fire or electric shock.



**Discount-Merchant.com (800) 281-8860**  
**THE TRUSTED SOURCE FOR PROJECTOR LAMPS AND ACCESSORIES**



---

# Panasonic®

Professional/Industrial Video

---

## **Panasonic Broadcast & Television Systems Company**

Division of Matsushita Electric Corporation of America

### **Executive Office.**

One Panasonic Way (3F-5), Secaucus, New Jersey 07094

### **EASTERN ZONE:**

43 Hartz Way, Secaucus, NJ 07094 (201) 348-7620

### **CENTRAL ZONE:**

1707 N Randall Rd, Elgin, IL 60123 (708) 468-5200

### **SOUTHERN ZONE:**

Dallas Region 4500 Amon Carter Blvd, Fort Worth, TX 76155 (817) 685-1117

Atlanta Region 1228 North Brook Parkway, Suite 170, Suwanee, GA 30174 (404) 338-6855

### **WESTERN ZONE:**

Los Angeles Region 6550 Katella Ave, Cypress, CA 90630 (714) 373-7275

Government Marketing Department: 52 West Gude Drive, Rockville, MD 20850 (301) 738-3840

Matsushita Electric Corporation of America

Corporate Sales Group, Hawaii Region

99-859 Iwaiwa ST, Aiea, HI 96701-3267 (808) 488-7779

Matsushita Electric of Canada Limited

5770 Ambler Drive, Mississauga, Ontario L4W 2T3 (905) 624-5010

Panasonic Sales Company

Division of Matsushita Electric of Puerto Rico, Inc.

San Gabriel Industrial Park, 65th Infantry Ave, K M 9 5, Carolina, PR 00630 (809) 750-4300

Printed in Japan  
LSQT0024 (A)



# Disclaimer

This user manual is provided as a free service by FixYourDLP.com. FixYourDLP is in no way responsible for the content of this manual, nor do we guarantee its accuracy. FixYourDLP does not make any claim of copyright and all copyrights remain the property of their respective owners.

About FixYourDLP.com

FixYourDLP.com (<http://www.fixyourdlp.com>) is the World's #1 resource for media product news, reviews, do-it-yourself guides, and manuals.

Informational Blog: <http://www.fixyourdlp.com>

Video Guides: <http://www.fixyourdlp.com/guides>

User Forums: <http://www.fixyourdlp.com/forum>

FixYourDLP's Fight Against Counterfeit Lamps:

<http://www.fixyourdlp.com/counterfeits>

## Sponsors:

RecycleYourLamp.org – Free lamp recycling services for used lamps:

<http://www.recycleyourlamp.org>

Lamp Research - The trusted 3rd party lamp research company:

<http://www.lampresearch.com>

Discount-Merchant.com – The worlds largest lamp distributor:

<http://www.discount-merchant.com>



**FixYourDLP.com**

Sponsored by 