



Disclaimer

This user manual is provided as a free service by FixYourDLP.com. FixYourDLP is in no way responsible for the content of this manual, nor do we guarantee its accuracy. FixYourDLP does not make any claim of copyright and all copyrights remain the property of their respective owners.

About FixYourDLP.com

FixYourDLP.com (<http://www.fixyourdpl.com>) is the World's #1 resource for media product news, reviews, do-it-yourself guides, and manuals.

Informational Blog: <http://www.fixyourdpl.com>

Video Guides: <http://www.fixyourdpl.com/guides>

User Forums: <http://www.fixyourdpl.com/forum>

FixYourDLP's Fight Against Counterfeit Lamps:

<http://www.fixyourdpl.com/counterfeits>

Sponsors:

RecycleYourLamp.org – Free lamp recycling services for used lamps:

<http://www.recycleyourlamp.org>

Lamp Research - The trusted 3rd party lamp research company:

<http://www.lampresearch.com>

Discount-Merchant.com – The worlds largest lamp distributor:

<http://www.discount-merchant.com>



FixYourDLP.com

Sponsored by 

Panasonic

Functional Instructions

DLP™ Based Projector **Commercial Use**

Model No. **PT-DZ6710**

PT-DZ6700

PT-DW6300

PT-D6000

PT-D5000

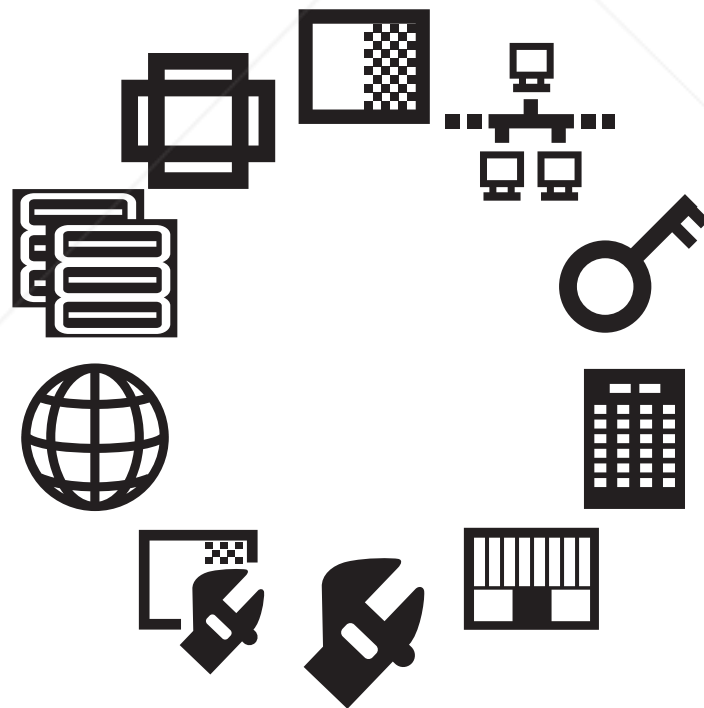

Discount-Merchant.com (800) 281-8860

THE TRUSTED SOURCE FOR PROJECTOR LAMPS AND ACCESSORIES

The information of these instructions are shared use with multiple models of DZ6710 series, DZ6700 series, DW6300 series, D6000 series and D5000 series.

TQBJ0299-3

ENGLISH

Contents

Getting Started

| | |
|---|-----------|
| Setting up | 3 |
| Screen size and throw distance..... | 3 |
| Geometric adjustment..... | 8 |
| Front leg adjusters and throwing angle..... | 9 |
| Connections | 10 |
| Before connection to the projector..... | 10 |
| Pin assignments and signal names..... | 10 |
| Connecting example: Computers..... | 11 |
| Connecting example: AV equipment..... | 11 |

Settings

| | |
|-----------------------------------|-----------|
| Menu Navigation | 12 |
| Main menu and Sub-menu..... | 12 |
| Navigating through the menu..... | 15 |
| PICTURE menu | 16 |
| PICTURE MODE..... | 16 |
| CONTRAST..... | 16 |
| BRIGHTNESS..... | 16 |
| COLOR..... | 16 |
| TINT..... | 16 |
| COLOR TEMPERATURE..... | 16 |
| WHITE GAIN..... | 17 |
| SYSTEM DAYLIGHT VIEW..... | 17 |
| SHARPNESS..... | 17 |
| NOISE REDUCTION..... | 17 |
| AI..... | 17 |
| SYSTEM SELECTOR..... | 17 |
| POSITION menu | 18 |
| SHIFT..... | 18 |
| ASPECT..... | 18 |
| ZOOM..... | 19 |
| CLOCK PHASE..... | 19 |
| GEOMETRY..... | 19 |
| KEYSTONE..... | 21 |
| ADVANCED MENU | 22 |
| DIGITAL CINEMA REALITY..... | 22 |
| BLANKING..... | 22 |
| INPUT RESOLUTION..... | 22 |
| CLAMP POSITION..... | 22 |
| EDGE BLENDING *..... | 23 |
| RASTER POSITION..... | 24 |
| DISPLAY OPTION menu | 25 |
| COLOR MATCHING *..... | 25 |
| COLOR CORRECTION..... | 25 |
| CONTRAST MODE *..... | 25 |
| SCREEN SETTING..... | 25 |
| AUTO SIGNAL..... | 25 |
| AUTO SETUP..... | 26 |
| DVI-D IN..... | 26 |
| SDI IN..... | 26 |
| ON-SCREEN DISPLAY..... | 26 |
| BACK COLOR..... | 27 |
| STARTUP LOGO..... | 27 |
| FREEZE..... | 27 |
| SIDE BY SIDE..... | 27 |
| PROJECTOR SETUP menu | 28 |
| PROJECTOR ID..... | 28 |
| INSTALLATION..... | 28 |
| HIGH ALTITUDE MODE..... | 28 |
| COOLING CONDITION..... | 28 |
| LAMP SELECT..... | 29 |
| LAMP RELAY..... | 29 |

| | |
|-------------------------------|-----------|
| LAMP POWER *..... | 29 |
| STANDBY MODE..... | 29 |
| RS-232C..... | 29 |
| REMOTE2 MODE..... | 29 |
| STATUS..... | 30 |
| FILTER COUNTER RESET..... | 30 |
| NO SIGNAL SHUT-OFF..... | 30 |
| FUNCTION BUTTON..... | 30 |
| DATE AND TIME..... | 31 |
| SAVE ALL USERS DATA..... | 31 |
| LOAD ALL USERS DATA..... | 31 |
| INITIALIZE..... | 31 |
| SERVICE PASSWORD..... | 31 |
| TEST PATTERN | 32 |
| TEST PATTERN..... | 32 |
| SIGNAL LIST | 33 |
| SECURITY menu | 35 |
| SECURITY PASSWORD..... | 35 |
| SECURITY PASSWORD CHANGE..... | 35 |
| DISPLAY SETTING..... | 35 |
| TEXT CHANGE..... | 35 |
| MENU LOCK..... | 36 |
| MENU LOCK PASSWORD..... | 36 |
| CONTROL DEVICE SETUP..... | 36 |
| NETWORK menu | 37 |
| NETWORK SETUP..... | 37 |
| NETWORK CONTROL..... | 37 |
| NETWORK STATUS..... | 37 |

Appendix

| | |
|---|-----------|
| Technical Information | 38 |
| Network connection..... | 38 |
| LAN terminal..... | 38 |
| Accessing with the web browser..... | 39 |
| PJLink™ protocol..... | 44 |
| Serial terminal..... | 45 |
| REMOTE 2 IN terminal..... | 47 |
| SIDE BY SIDE function signal combination table..... | 48 |
| Trademark acknowledgements..... | 49 |
| Index | 50 |

For Your DLP.com

Sponsored by DLP

Best-Merchants.com (800) 281-8860

THE TRUSTED SOURCE FOR PROJECTOR LAMPS AND ACCESSORIES

* Not available for PT-D5000.

Setting up

Screen size and throw distance

When planning the projector and screen geometry, refer to the figures below and the information on the following pages for reference. After the projector is roughly positioned, picture size and vertical picture positioning can be finely adjusted with the powered zoom lens and lens shifting mechanism.

Projected image
Shown as 16:10

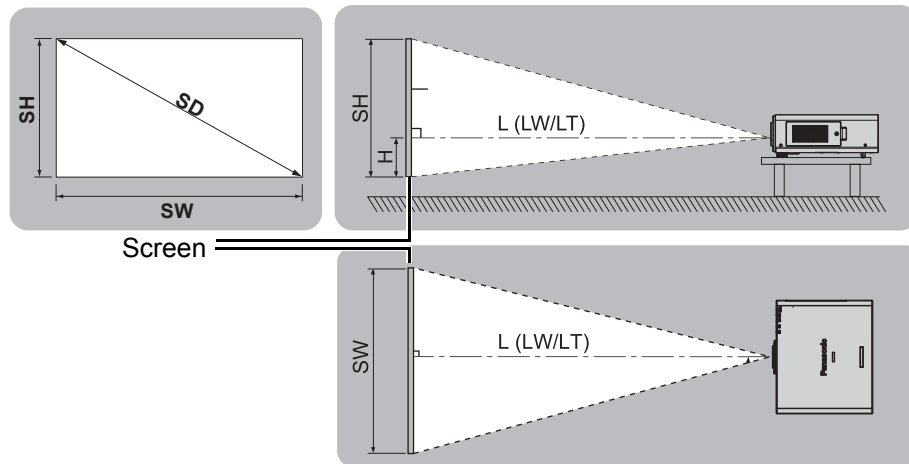

| | |
|-----------|---|
| L (LW/LT) | Projection distance |
| SH | Height of the projection area |
| SW | Width of the projection area |
| H | Vertical distance between the lens centre level and the bottom edge of the projected image. |
| SD | Diagonal length of the projection area |

NOTE:

- All following measurements and the calculation results are approximate and may differ slightly from the actual measurements.
- The throw ratio is based on the value during projection onto an 80-inch screen size.
- Lens shift is not available when using the ET-DLE055, and so the height position (H) is $SH/2$.
- See the operating instructions that is provided with the projector.
- Special care should be used when DLP projectors are used in the same room as high power laser equipment. Direct or indirect hitting of a laser beam on to the lens can severely damage the Digital Mirror Devices™ in which case there is a loss of warranty.

Setting up

Getting Started

Projection distance by projection lens

PT-DZ6710/PT-DZ6700

● 16:10 (Unit: m)

| Lens type | | | Standard zoom lens | | Optional lens | | | | | | | | | | Height |
|---------------|----------------|-----------------|--------------------|------------------|----------------|----------------|-----------------|-----------------|-----------------|------------------|-----------------|------------------|-------------------|-----------------------|--------|
| Lens names | | | | | ET-DLE055 | ET-DLE150 | ET-DLE250 | ET-DLE350 | ET-DLE450 | | | | | | |
| Through ratio | | | 1.8 - 2.4:1 | | 0.8:1 | 1.3 - 1.9:1 | | 2.3 - 3.6:1 | | 3.6 - 5.4:1 | | 5.5 - 8.6:1 | | | |
| SD | SH | SW | LW | LT | Fixed | LW | LT | LW | LT | LW | LT | LW | LT | H | |
| 50" | 0.673 2'2" | 1.077 3'6" | 1.90 6'2" | 2.57 8'5" | 0.83 2'8" | 1.38 4'6" | 2.01 6'7" | 2.42 7'11" | 3.87 12'8" | 3.80 12'5" | 5.82 19'1" | 5.66 18'6" | 9.12 29'11" | 0 - 0.34 0 - 1'1" | |
| 60" | 0.808 2'7" | 1.292 4'2" | 2.30 7'6" | 3.10 10'2" | 1.00 3'3" | 1.66 5'5" | 2.43 7'11" | 2.92 9'6" | 4.65 15'3" | 4.59 15' | 7.00 22'11" | 6.85 22'5" | 11.01 36'1" | 0 - 0.4 0 - 1'3" | |
| 70" | 0.942 3'1" | 1.508 4'11" | 2.69 8'9" | 3.63 11'10" | 1.18 3'10" | 1.95 6'4" | 2.84 9'3" | 3.42 11'2" | 5.44 17'10" | 5.38 17'7" | 8.19 26'10" | 8.04 26'4" | 12.89 42'3" | 0 - 0.47 0 - 1'6" | |
| 80" | 1.077 3'6" | 1.723 5'7" | 3.09 10'1" | 4.16 13'7" | 1.35 4'5" | 2.23 7'3" | 3.25 10'7" | 3.92 12'10" | 6.23 20'5" | 6.16 20'2" | 9.38 30'9" | 9.24 30'3" | 14.78 48'5" | 0 - 0.54 0 - 1'9" | |
| 90" | 1.212 3'11" | 1.939 6'4" | 3.48 11'5" | 4.69 15'4" | 1.53 5' | 2.52 8'3" | 3.66 12' | 4.42 14'6" | 7.02 23' | 6.95 22'9" | 10.57 34'8" | 10.43 34'2" | 16.66 54'7" | 0 - 0.61 0 - 2' | |
| 100" | 1.346 4'4" | 2.154 7' | 3.88 12'8" | 5.22 17'1" | 17.00 55'9" | 2.81 9'2" | 4.08 13'4" | 4.92 16'1" | 7.81 25'7" | 7.74 25'4" | 11.76 38'6" | 11.62 38'1" | 18.55 60'10" | 0 - 0.67 0 - 2'2" | |
| 120" | 1.615 5'3" | 2.585 8'5" | 4.67 15'3" | 6.27 20'6" | 2.05 6'8" | 3.38 11'1" | 4.90 16' | 5.91 19'4" | 9.39 30'9" | 9.31 30'6" | 14.14 46'4" | 14.00 45'11" | 23.32 76'6" | 0 - 0.81 0 - 2'7" | |
| 150" | 2.019 6'7" | 3.231 10'7" | 5.85 19'2" | 7.86 25'9" | 2.58 8'5" | 4.24 13'10" | 6.14 20'1" | 7.41 24'3" | 11.75 38'6" | 11.68 38'3" | 17.71 58'11" | 17.58 57'8" | 27.97 91'9" | 0 - 1.01 0 - 3'3" | |
| 200" | 2.692 8'9" | 4.308 14'1" | 7.83 25'8" | 10.50 34'5" | 3.45 11'3" | 5.67 18'7" | 8.20 26'10" | 9.91 32'6" | 15.70 51'6" | 15.61 51'2" | 23.66 77'7" | 23.54 77'2" | 37.39 122'8" | 0 - 1.35 0 - 4'5" | |
| 250" | 3.365 11' | 5.385 17'8" | 9.80 32'1" | 13.15 43'1" | | 7.10 23'3" | 10.26 33'7" | 12.41 40'8" | 19.64 64'5" | 19.55 64'1" | 29.61 97'11" | 29.50 96'9" | 46.81 153'6" | 0 - 1.68 0 - 5'6" | |
| 300" | 4.039 13'3" | 6.462 21'2" | 11.78 38'7" | 15.79 51'9" | | 8.53 27'11" | 12.33 40'5" | 14.91 48'11" | 23.59 77'4" | 23.49 77' | 35.56 116'8" | 35.46 116'4" | 56.24 184'6" | 0 - 2.02 0 - 6'7" | |
| 350" | 4.712 15'5" | 7.539 24'8" | 13.75 45'1" | 18.44 60'5" | | 9.96 32'8" | 14.39 47'2" | 17.40 57'1" | 27.53 90'3" | 27.42 89'11" | 41.51 136'2" | 41.42 135'10" | 65.66 215'5" | 0 - 2.36 0 - 7'8" | |
| 400" | 5.385 17'8" | 8.616 28'3" | 15.73 51'7" | 21.08 69'1" | | 11.39 37'4" | 16.45 53'11" | 19.90 65'3" | 31.48 103'3" | 31.36 102'10" | 47.46 155'8" | 47.38 155'5" | 75.08 246'3" | 0 - 2.69 0 - 8'9" | |
| 500" | 6.731 22'1" | 10.770 35'4" | 19.68 64'6" | 26.37 86'6" | | 14.25 46'9" | 20.58 67'6" | 24.90 81'8" | 39.37 129'2" | 39.24 128'8" | 59.36 194'9" | 59.30 194'6" | 93.93 308'2" | 0 - 3.37 0 - 11' | |
| 600" | 8.077 26'5" | 12.923 42'4" | 23.63 77'6" | 31.66 103'10" | | 17.11 56'1" | 24.70 81' | 29.89 98' | 47.26 155' | 47.11 154'6" | 71.26 233'9" | 71.22 233'7" | 112.77 369'11" | 0 - 4.04 0 - 13'3" | |

● 16:9 (Unit: m)

| Lens type | | | Standard zoom lens | | Optional lens | | | | | | | | | | Height |
|---------------|----------------|-----------------|--------------------|-----------------|---------------|----------------|----------------|-----------------|-----------------|------------------|------------------|-----------------|------------------|-------------------------------|--------|
| Lens names | | | | | ET-DLE055 | ET-DLE150 | ET-DLE250 | ET-DLE350 | ET-DLE450 | | | | | | |
| Through ratio | | | 1.8 - 2.4:1 | | 0.8:1 | 1.3 - 1.9:1 | | 2.3 - 3.6:1 | | 3.6 - 5.4:1 | | 5.5 - 8.6:1 | | | |
| SD | SH | SW | LW | LT | Fixed | LW | LT | LW | LT | LW | LT | LW | LT | H | |
| 50" | 0.623 2' | 1.107 3'7" | 1.96 6'5" | 2.65 8'8" | 0.85 2'9" | 1.42 4'7" | 2.07 6'9" | 2.49 8'2" | 3.98 13' | 3.91 12'9" | 5.98 19'7" | 5.82 19'1" | 9.39 30'9" | -0.06 - 0.31 -2" - 1' | |
| 60" | 0.747 2'5" | 1.328 4'4" | 2.36 7'8" | 3.19 10'5" | 1.03 3'4" | 1.71 5'7" | 2.49 8'2" | 3 9'10" | 4.79 15'8" | 4.72 15'5" | 7.2 23'7" | 7.05 23'1" | 11.32 37'1" | -0.08 - 0.37 -3" - 1'2" | |
| 70" | 0.872 2'10" | 1.55 5'1" | 2.77 9'1" | 3.73 12'2" | 1.21 3'11" | 2 6'6" | 2.92 9'6" | 3.51 11'6" | 5.6 18'4" | 5.53 18'1" | 8.43 27'7" | 8.28 27'1" | 13.26 43'6" | -0.09 - 0.44 -3" - 1'5" | |
| 80" | 0.996 3'3" | 1.771 5'9" | 3.17 10'4" | 4.28 14' | 1.39 4'6" | 2.3 7'6" | 3.34 10'11" | 4.03 13'2" | 6.41 21' | 6.34 20'9" | 9.65 31'7" | 9.5 31'2" | 15.2 49'10" | -0.10 - 0.50 -3" - 1'7" | |
| 90" | 1.121 3'8" | 1.992 6'6" | 3.58 11'8" | 4.82 15'9" | 1.57 5'1" | 2.59 8'5" | 3.77 12'4" | 4.54 14'10" | 7.22 23'8" | 7.15 23'5" | 10.87 35'7" | 10.73 35'2" | 17.13 56'2" | -0.11 - 0.56 -4" - 1'10" | |
| 100" | 1.245 4'1" | 2.214 7'3" | 3.99 13'1" | 5.36 17'7" | 1.75 5'8" | 2.89 9'5" | 4.19 13'8" | 5.05 16'6" | 8.03 26'4" | 8.03 26'1" | 12.09 39'7" | 12.09 39'2" | 19.07 62'6" | -0.13 - 0.62 -5" - 2' | |
| 120" | 1.494 4'10" | 2.657 8'8" | 4.8 15'8" | 6.45 21'1" | 2.11 6'11" | 3.47 11'4" | 5.04 16'6" | 6.08 19'11" | 9.65 31'7" | 9.58 31'5" | 14.54 47'8" | 14.4 47'2" | 22.94 75'3" | -0.15 - 0.75 -5" - 2'5" | |
| 150" | 1.866 6'1" | 3.327 10'10" | 6.02 19'9" | 8.08 26'6" | 2.65 8'8" | 4.36 14'3" | 6.31 20'8" | 7.62 25' | 12.08 39'7" | 12 39'4" | 18.21 59'8" | 18.08 59'3" | 28.75 94'3" | -0.19 - 0.93 -7" - 3' | |
| 200" | 2.491 8'2" | 4.428 14'6" | 8.05 26'4" | 10.8 35'5" | 3.55 11'7" | 5.83 19'1" | 8.43 27'7" | 10.19 33'5" | 16.14 52'11" | 16.05 52'7" | 24.32 79'9" | 24.2 79'4" | 38.44 126'1" | -0.25 - 1.25 -9" - 4'1" | |
| 250" | 3.113 10'2" | 5.535 18'1" | 10.08 33' | 13.52 44'4" | | 7.29 23'11" | 10.55 34'7" | 12.76 41'10" | 20.19 66'2" | 20.1 65'11" | 30.44 99'10" | 30.33 99'6" | 48.12 157'10" | -0.31 - 1.56 -1' - 5'1" | |
| 300" | 3.736 12'3" | 6.644 21'9" | 12.11 39'8" | 16.23 53'2" | | 8.76 28'8" | 12.67 41'6" | 15.32 50'3" | 24.25 79'6" | 24.14 79'2" | 36.55 119'10" | 36.45 119'7" | 57.81 189'7" | 0.37 - 1.87 -4'2" - 6'1" | |
| 350" | 4.358 14'3" | 7.748 25'5" | 14.14 46'4" | 18.95 62'2" | | 10.23 33'6" | 14.79 48'6" | 17.89 58'8" | 28.3 92'10" | 28.19 92'5" | 42.67 139'11" | 42.58 139'8" | 67.49 221'5" | -0.44 - 2.18 -1'5" - 7'1" | |
| 400" | 4.981 16'4" | 8.855 29' | 16.17 53' | 21.67 71'1" | | 11.7 38'4" | 16.91 55'5" | 20.46 67'1" | 32.35 106'1" | 32.24 105'9" | 48.78 160' | 48.71 159'9" | 77.18 253'2" | -0.50 - 2.49 -1'7" - 8'2" | |
| 500" | 6.226 20'5" | 11.069 36'3" | 20.23 66'4" | 27.11 88'11" | | 14.64 48' | 21.15 69'4" | 25.59 83'11" | 40.46 132'8" | 40.33 132'3" | 64.01 210' | 60.96 200' | 96.55 316'9" | -0.62 - 3.11 -2' - 10'2" | |
| 600" | 7.472 24'6" | 13.283 43'6" | 24.29 79'8" | 32.54 106'9" | | 17.58 57'8" | 25.39 83'3" | 30.72 100'9" | 48.57 159'4" | 48.42 158'10" | 73.24 240'3" | 73.21 240'2" | 115.92 380'3" | -0.75 - 3.74 -2'5" - 12'3" | |

● PT-DW6300

● 16:10 (Unit: m)

| Lens type | | | Standard zoom lens | | Optional lens | | | | | | | | | | Height |
|---------------|----------------|-----------------|--------------------|------------------|----------------|-----------------|-----------------|------------------|-----------------|-----------------|-----------------|-----------------|------------------|-------------------------------|--------|
| Lens names | | | | | ET-DLE055 | ET-DLE150 | ET-DLE250 | ET-DLE350 | ET-DLE450 | | | | | | |
| Through ratio | | | 1.8 - 2.4:1 | | 0.8:1 | 1.4 - 2.0:1 | | 2.4 - 3.8:1 | | 3.8 - 5.7:1 | | 5.6 - 9.0:1 | | H | |
| SD | SH | SW | LW | LT | Fixed | LW | LT | LW | LT | LW | LT | LW | LT | | |
| 50" | 0.673 2'2" | 1.077 3'6" | 1.92 6'3" | 2.56 8'4" | 0.87 2'10" | 1.45 4'9" | 2.12 6'11" | 2.54 8'4" | 4.06 13'3" | 4 13'1" | 6.11 20' | 5.96 19'6" | 9.6 31'5" | -0.07 - 0.34 -2" - 1'1" | |
| 60" | 0.808 2'7" | 1.292 4'2" | 2.32 7'7" | 3.08 10'1" | 1.06 3'5" | 1.75 5'8" | 2.55 8'4" | 3.07 10' | 4.89 16' | 4.83 15'10" | 7.36 23'7" | 7.21 23'7" | 11.57 37'11" | -0.08 - 0.40 -3" - 1'3" | |
| 70" | 0.942 3'1" | 1.508 4'11" | 2.72 8'11" | 3.61 11'10" | 1.24 4' | 2.05 6'8" | 2.98 9'9" | 3.59 11'9" | 5.72 18'9" | 5.65 18'6" | 8.61 28'2" | 8.46 27'9" | 13.55 44'5" | -0.09 - 0.47 -3" - 1'6" | |
| 80" | 1.077 3'6" | 1.723 5'7" | 3.11 10'2" | 4.13 13'6" | 1.42 4'7" | 2.35 7'8" | 3.42 11'2" | 4.12 13'6" | 6.55 21'5" | 6.48 21'3" | 9.86 32'4" | 9.71 31'10" | 15.53 50'11" | -0.11 - 0.54 -4" - 1'9" | |
| 90" | 1.212 3'11" | 1.939 6'4" | 3.51 11'6" | 4.65 15'3" | 1.61 5'3" | 2.65 8'8" | 3.85 12'7" | 4.64 15'2" | 7.38 24'2" | 7.31 23'11" | 11.11 36'5" | 10.96 35'11" | 17.51 57'5" | -0.12 - 0.61 -4" - 2" | |
| 100" | 1.346 4'4" | 2.154 7' | 3.91 12'9" | 5.18 16'11" | 1.79 5'10" | 2.95 9'8" | 4.28 14' | 5.17 16'11" | 8.2 26'10" | 8.13 26'8" | 12.36 40'6" | 12.22 40'1" | 19.49 63'11" | -0.14 - 0.67 -5" - 2'2" | |
| 120" | 1.615 5'3" | 2.585 8'5" | 4.7 15'5" | 6.23 20'5" | 2.16 7'1" | 3.55 11'7" | 5.15 16'10" | 6.21 20'4" | 9.86 32'4" | 9.79 32'1" | 14.86 48'9" | 14.72 48'3" | 23.45 76'11" | -0.16 - 0.81 -6" - 2'7" | |
| 150" | 2.019 6'7" | 3.231 10'7" | 5.9 19'4" | 7.8 25'7" | 2.71 8'10" | 4.45 14'7" | 6.45 21'1" | 7.79 25'6" | 12.35 40'6" | 12.27 40'3" | 18.61 61' | 18.47 60'7" | 29.38 96'4" | -0.2 - 1.01 -7" - 3'3" | |
| 200" | 2.692 8'9" | 4.308 14'1" | 7.88 25'10" | 10.42 34'2" | 3.63 11'10" | 5.95 19'6" | 8.61 28'2" | 10.41 34'1" | 16.49 54'1" | 16.4 53'9" | 24.85 81'6" | 24.73 81'1" | 39.28 128'10" | -0.27 - 1.35 -10" - 4'5" | |
| 250" | 3.365 11' | 5.385 17'8" | 9.87 32'4" | 13.04 42'9" | | 7.45 24'5" | 10.78 35'4" | 13.03 42'8" | 20.63 67'8" | 20.53 67'4" | 31.1 102' | 30.99 101'8" | 49.17 161'3" | -0.34 - 1.68 -11" - 5'6" | |
| 300" | 4.039 13'3" | 6.462 21'2" | 11.86 38'10" | 15.66 51'4" | | 8.96 29'4" | 12.95 42'5" | 15.65 51'4" | 24.77 81'3" | 24.67 80'11" | 37.35 122'6" | 37.25 122'2" | 59.06 193'9" | -0.4 - 2.02 -13" - 6'7" | |
| 350" | 4.712 15'5" | 7.539 24'8" | 13.85 45'5" | 18.28 59'11" | | 10.46 34'3" | 15.11 49'6" | 18.28 59'11" | 28.91 94'10" | 28.8 94'5" | 43.59 143' | 43.51 142'8" | 68.96 226'2" | -0.47 - 2.36 -16" - 7'8" | |
| 400" | 5.385 17'8" | 8.616 28'3" | 15.83 51'11" | 20.9 68'6" | | 11.96 39'2" | 17.28 56'8" | 20.9 68'6" | 33.06 108'5" | 32.94 108' | 49.84 163'6" | 49.76 163'3" | 78.85 258'8" | -0.54 - 2.69 -19" - 8'9" | |
| 500" | 6.731 22'1" | 10.77 35'4" | 19.81 64'11" | 26.15 85'9" | | 14.96 49' | 21.61 70'10" | 26.14 85'9" | 41.34 135'2" | 41.2 135'2" | 62.33 204'5" | 62.28 204'3" | 98.64 323'7" | -0.67 - 3.37 -2'2" - 1'1" | |
| 600" | 8.077 26'5" | 12.923 42'4" | 23.78 78' | 31.39 102'11" | | 17.96 58'11" | 25.94 85'1" | 31.39 102'11" | 49.62 162'9" | 49.47 162'3" | 74.82 245'5" | 74.8 245'4" | 118.43 388'6" | -0.81 - 4.04 -2'7" - 13'3" | |

● 16:9 (Unit: m)

| Lens type | | | Standard zoom lens | | Optional lens | | | | | | | | | | Height |
|---------------|----------------|-----------------|--------------------|------------------|---------------|-----------------|-----------------|------------------|-----------------|------------------|------------------|------------------|------------------|-------------------------------|--------|
| Lens names | | | | | ET-DLE055 | ET-DLE150 | ET-DLE250 | ET-DLE350 | ET-DLE450 | | | | | | |
| Through ratio | | | 1.8 - 2.4:1 | | 0.8:1 | 1.4 - 2.0:1 | | 2.4 - 3.8:1 | | 3.8 - 5.7:1 | | 5.6 - 9.0:1 | | H | |
| SD | SH | SW | LW | LT | Fixed | LW | LT | LW | LT | LW | LT | LW | LT | | |
| 50" | 0.623 2' | 1.107 3'7" | 1.98 6'5" | 2.63 8'7" | 0.9 2'11" | 1.49 4'10" | 2.18 7'1" | 2.62 8'7" | 4.18 13'8" | 4.11 13'5" | 6.29 20'7" | 6.13 20'1" | 9.87 32'4" | -0.14 - 0.31 -5" - 1' | |
| 60" | 0.747 2'5" | 1.328 4'4" | 2.39 7'10" | 3.17 10'4" | 1.09 3'6" | 1.8 5'10" | 2.62 8'7" | 3.15 10'4" | 5.03 16'6" | 4.96 16'3" | 7.57 24'10" | 7.42 24'4" | 11.9 39' | -0.16 - 0.37 -6" - 1'2" | |
| 70" | 0.872 2'10" | 1.55 5'1" | 2.79 9'1" | 3.71 12'2" | 1.28 4'2" | 2.11 6'11" | 3.07 10' | 3.69 12'1" | 5.88 19'3" | 5.81 19' | 8.85 29' | 8.7 28'6" | 13.94 45'8" | -0.19 - 0.44 -7" - 1'5" | |
| 80" | 0.996 3'3" | 1.771 5'9" | 3.2 10'5" | 4.25 13'11" | 1.46 4'9" | 2.42 7'11" | 3.51 11'6" | 4.23 13'10" | 6.73 22' | 6.66 21'10" | 10.14 33'3" | 9.99 32'9" | 15.97 52'4" | -0.22 - 0.50 -8" - 1'7" | |
| 90" | 1.121 3'8" | 1.992 6'6" | 3.61 11'10" | 4.79 15'8" | 1.65 5'4" | 2.72 8'11" | 3.96 12'11" | 4.77 15'7" | 7.58 24'10" | 7.51 24'7" | 11.42 37'5" | 11.28 37' | 18.01 59'11" | -0.25 - 0.56 -9" - 1'10" | |
| 100" | 1.245 4'1" | 2.214 7'3" | 4.02 13'2" | 5.32 17'5" | 1.84 6' | 3.03 9'11" | 4.4 14'5" | 5.31 17'5" | 8.44 27'8" | 8.36 27'5" | 12.71 41'8" | 12.56 41'2" | 20.04 65'8" | -0.27 - 0.62 -10" - 2" | |
| 120" | 1.494 4'10" | 2.657 8'8" | 4.84 15'10" | 6.4 20'11" | 2.22 7'3" | 3.65 11'11" | 5.29 17'4" | 6.39 20'11" | 10.14 33'3" | 10.06 33' | 15.27 50'1" | 15.14 49'8" | 24.11 79'11" | -0.33 - 0.75 -1' - 2'5" | |
| 150" | 1.868 6'1" | 3.321 10'10" | 6.06 19'10" | 8.02 26'3" | 2.79 9'1" | 4.58 15' | 6.63 21'9" | 8.01 26'3" | 12.69 41'7" | 12.61 41'4" | 19.13 62'9" | 19.00 62'4" | 30.21 99'11" | -0.41 - 0.93 -1'4" - 3" | |
| 200" | 2.491 8'2" | 4.428 14'6" | 8.11 26'7" | 10.71 35'1" | 3.73 12'2" | 6.12 20' | 8.86 29' | 10.7 35'1" | 16.95 55'7" | 16.86 55'3" | 25.55 83'9" | 25.43 83'5" | 40.38 132'5" | -0.55 - 1.25 -19" - 4'1" | |
| 250" | 3.113 10'2" | 5.535 18'1" | 10.15 33'3" | 13.41 43'11" | | 7.66 25'1" | 11.08 36'4" | 13.4 43'11" | 21.21 69'7" | 21.11 69'3" | 31.97 104'10" | 31.86 104'6" | 50.54 165'9" | -0.69 - 1.56 -23" - 5'1" | |
| 300" | 3.736 12'3" | 6.641 21'9" | 12.19 39'11" | 16.1 52'9" | | 9.21 30'2" | 13.31 43'8" | 16.09 52'9" | 25.46 83'6" | 25.36 83'2" | 38.39 125'11" | 38.29 125'7" | 60.71 199'2" | -0.82 - 1.87 -28" - 6'1" | |
| 350" | 4.358 14'3" | 7.748 25'5" | 14.23 46'8" | 18.79 61'7" | | 10.75 50'11" | 15.53 61'7" | 18.79 61'7" | 29.72 97'6" | 29.61 97'1" | 44.81 147' | 44.72 146'8" | 70.88 232'6" | -0.96 - 2.18 -3'1" - 7'1" | |
| 400" | 4.981 16'4" | 8.855 29' | 16.27 53'4" | 21.49 70'6" | | 12.29 40'3" | 17.76 58'3" | 21.48 70'5" | 33.98 111'5" | 33.86 111'1" | 51.23 168' | 51.16 167'10" | 81.05 265'10" | -1.1 - 2.49 -3'7" - 8'2" | |
| 500" | 6.226 20'5" | 11.069 36'3" | 20.36 66'9" | 26.87 88'1" | | 15.38 50'5" | 22.21 72'10" | 26.87 88'1" | 42.49 139'4" | 42.35 138'11" | 64.07 210'2" | 64.02 210' | 101.39 332'7" | -1.37 - 3.11 -4'5" - 10'2" | |
| 600" | 7.472 24'6" | 13.283 43'6" | 24.44 80'2" | 32.26 105'10" | | 18.46 60'6" | 26.67 87'6" | 32.26 105'10" | 51 167'3" | 50.85 166'9" | 76.91 252'3" | 76.89 252'3" | 121.73 399'4" | -1.64 - 3.74 -5'4" - 12'3" | |

Setting up

Getting Started

● PT-D6000/PT-D5000

● 16:10 (Unit: m)

| Lens type | | | Standard zoom lens | | Optional lens | | | | | | | | | | Height |
|---------------|----------------|----------------|--------------------|-----------------|---------------|-----------------|-----------------|-----------------|------------------|-----------------|-----------------|------------------|------------------|------------------------|--------|
| Lens names | | | | | ET-DLE055 | ET-DLE150 | ET-DLE250 | ET-DLE350 | ET-DLE450 | | | | | | |
| Through ratio | | | 1.8 - 2.4:1 | | 0.8:1 | 1.3 - 2.0:1 | | 2.4 - 3.7:1 | | 3.7 - 5.6:1 | | 5.5 - 8.9:1 | | | |
| SD | SH | SW | LW | LT | Fixed | LW | LT | LW | LT | LW | LT | LW | LT | H | |
| 50" | 0.762 2'6" | 1.016 3'4" | 1.79 5'10" | 2.38 7'9" | 0.81 2'7" | 1.34 4'4" | 1.97 6'5" | 2.36 7'8" | 3.78 12'4" | 3.71 12'2" | 5.68 18'7" | 5.53 18'1" | 8.91 29'2" | 0 - 0.38 0 - 1'2" | |
| 60" | 0.914 2'11" | 1.219 3'11" | 2.16 7'1" | 2.86 9'4" | 0.98 3'2" | 1.62 5'3" | 2.37 7'9" | 2.85 9'4" | 4.55 14'11" | 4.48 14'8" | 6.84 22'5" | 6.69 21'11" | 10.75 35'3" | 0 - 0.46 0 - 1'6" | |
| 70" | 1.067 3'6" | 1.422 4'7" | 2.53 8'3" | 3.35 10'11" | 1.15 3'9" | 1.9 6'2" | 2.77 9'1" | 3.34 10'11" | 5.32 17'5" | 5.25 17'2" | 8.01 26'3" | 7.86 25'9" | 12.6 41'4" | 0 - 0.53 0 - 1'8" | |
| 80" | 1.219 3'11" | 1.626 5'4" | 2.9 9'6" | 3.84 12'7" | 1.32 4'3" | 2.18 7'1" | 3.18 10'5" | 3.83 12'6" | 6.09 19'11" | 6.02 19'9" | 9.17 30'1" | 9.02 29'7" | 14.44 47'4" | 0 - 0.61 0 - 2' | |
| 90" | 1.372 4'6" | 1.829 6' | 3.27 10'8" | 4.33 14'2" | 1.49 4'10" | 2.46 8' | 3.58 11'8" | 4.32 14'2" | 6.86 22'6" | 6.79 22'3" | 10.33 33'10" | 10.19 33'5" | 16.28 53'4" | 0 - 0.69 0 - 2'3" | |
| 100" | 1.524 5' | 2.032 6'8" | 3.64 11'11" | 4.82 15'9" | 1.66 5'5" | 2.74 8'11" | 3.98 13' | 4.8 15'8" | 7.63 25' | 7.56 24'9" | 11.5 37'8" | 11.35 37'2" | 18.12 59'5" | 0 - 0.76 0 - 2'5" | |
| 120" | 1.829 6' | 2.438 7'11" | 4.38 14'4" | 5.79 18'11" | 2.01 6'7" | 3.3 10'9" | 4.79 15'8" | 5.78 18'11" | 9.18 30'1" | 9.1 29'10" | 13.82 45'4" | 13.68 44'10" | 21.81 71'6" | 0 - 0.91 0 - 2'11" | |
| 150" | 2.286 7'6" | 3.048 10' | 5.49 18' | 7.26 23'9" | 2.52 8'3" | 4.14 13'6" | 6 19'8" | 7.24 23'9" | 11.49 37'8" | 11.41 37'5" | 17.31 56'9" | 17.18 56'4" | 27.33 89'7" | 0 - 1.14 0 - 3'8" | |
| 200" | 3.048 10' | 4.064 13'4" | 7.34 24' | 9.7 31'9" | 3.38 11'1" | 5.54 18'2" | 8.02 26'3" | 9.69 31'9" | 15.34 50'3" | 15.26 50' | 23.13 75'10" | 23 75'5" | 36.54 119'10" | 0 - 1.52 0 - 4'11" | |
| 250" | 3.81 12'6" | 5.08 16'8" | 9.19 30'1" | 12.14 39'9" | | 6.94 22'9" | 10.03 32'10" | 12.13 39'9" | 19.2 62'11" | 19.11 62'8" | 28.94 94'11" | 28.83 94'7" | 45.76 150'1" | 0 - 1.91 0 - 6'3" | |
| 300" | 4.572 15' | 6.096 20' | 11.04 36'2" | 14.58 47'10" | | 8.33 27'3" | 12.05 39'6" | 14.57 47'9" | 23.06 75'7" | 22.96 75'3" | 34.76 114' | 34.66 113'8" | 54.97 180'4" | 0 - 2.29 0 - 7'6" | |
| 350" | 5.334 17'6" | 7.112 23'4" | 12.89 42'3" | 17.02 55'10" | | 9.73 31'11" | 14.07 46'1" | 17.01 55'9" | 26.91 88'3" | 26.81 87'11" | 40.57 133'1" | 40.48 132'9" | 64.18 210'6" | 0 - 2.67 0 - 8'9" | |
| 400" | 6.096 20' | 8.128 26'8" | 14.74 48'4" | 19.46 63'10" | | 11.13 36'6" | 16.08 52'9" | 19.45 63'9" | 30.77 100'11" | 30.65 100'6" | 46.39 152'2" | 46.31 151'11" | 73.39 240'9" | 0 - 3.05 0 - 10' | |
| 500" | 7.62 25' | 10.16 33'4" | 18.44 60'5" | 24.34 79'10" | | 13.92 45'8" | 20.12 66' | 24.33 79'9" | 38.48 126'2" | 38.35 125'9" | 58.02 190'4" | 57.96 190'1" | 91.81 301'2" | 0 - 3.81 0 - 12'6" | |
| 600" | 9.144 30' | 12.192 40' | 22.14 72'7" | 29.22 95'10" | | 16.72 54'10" | 24.15 79'2" | 29.22 95'10" | 46.19 151'6" | 46.05 151' | 69.65 228'6" | 69.61 228'4" | 110.23 361'7" | 0 - 4.57 0 - 14'11" | |

● 16:9 (Unit: m)

| Lens type | | | Standard zoom lens | | Optional lens | | | | | | | | | | Height |
|---------------|----------------|-----------------|--------------------|-----------------|---------------|----------------|-----------------|-----------------|-----------------|-----------------|------------------|------------------|------------------|-------------------------------|--------|
| Lens names | | | | | ET-DLE055 | ET-DLE150 | ET-DLE250 | ET-DLE350 | ET-DLE450 | | | | | | |
| Through ratio | | | 1.8 - 2.4:1 | | 0.8:1 | 1.3 - 2.0:1 | | 2.4 - 3.7:1 | | 3.7 - 5.6:1 | | 5.6 - 8.9:1 | | | |
| SD | SH | SW | LW | LT | Fixed | LW | LT | LW | LT | LW | LT | LW | LT | H | |
| 50" | 0.623 2' | 1.107 3'7" | 1.95 6'4" | 2.6 8'6" | 0.89 2'11" | 1.47 4'9" | 2.15 7' | 2.58 8'5" | 4.12 13'6" | 4.06 13'3" | 6.2 20'4" | 6.05 19'10" | 9.74 31'11" | -0.21 - 0.31 -8" - 1' | |
| 60" | 0.747 2'5" | 1.328 4'4" | 2.35 7'8" | 3.13 10'3" | 1.07 3'6" | 1.77 5'9" | 2.59 8'5" | 3.11 10'2" | 4.96 16'3" | 4.9 16' | 7.47 24'6" | 7.32 24' | 11.74 38'6" | -0.25 - 0.37 -9" - 1'2" | |
| 70" | 0.872 2'10" | 1.55 5'1" | 2.76 9' | 3.66 12' | 1.26 4'1" | 2.08 6'9" | 3.03 9'11" | 3.64 11'11" | 5.8 19' | 5.74 18'9" | 8.74 28'8" | 8.59 28'2" | 13.75 45'1" | -0.29 - 0.44 -11" - 1'5" | |
| 80" | 0.996 3'3" | 1.771 5'9" | 3.16 10'4" | 4.19 13'8" | 1.44 4'8" | 2.38 7'9" | 3.47 11'4" | 4.18 13'8" | 6.64 21'9" | 6.57 21'6" | 10 32'9" | 9.85 32'3" | 15.76 51'8" | -0.33 - 0.50 -1' - 1'7" | |
| 90" | 1.121 3'8" | 1.992 6'6" | 3.56 11'8" | 4.72 15'5" | 1.63 5'4" | 2.69 8'9" | 3.91 12'9" | 4.71 15'5" | 7.48 24'6" | 7.41 24'3" | 11.27 36'11" | 11.12 36'5" | 17.76 58'3" | -0.37 - 0.56 -1'2" - 1'10" | |
| 100" | 1.245 4'1" | 2.214 7'3" | 3.97 13' | 5.25 17'2" | 1.82 5'11" | 2.99 9'9" | 4.34 14'2" | 5.24 17'2" | 8.32 27'3" | 8.25 27' | 12.54 41'1" | 12.39 40'7" | 19.77 64'10" | -0.41 - 0.62 -1'4" - 2' | |
| 120" | 1.494 4'10" | 2.657 8'8" | 4.77 15'7" | 6.32 20'8" | 2.19 7'2" | 3.6 11'9" | 5.22 17'1" | 6.3 20'8" | 10 32'9" | 9.93 32'6" | 15.07 49'5" | 14.93 48'11" | 23.79 78' | -0.49 - 0.75 -1'7" - 2'5" | |
| 150" | 1.868 6'1" | 3.321 10'10" | 5.98 19'7" | 7.91 25'11" | 2.75 9' | 4.52 14'9" | 6.54 21'5" | 7.9 25'11" | 12.52 41' | 12.44 40'9" | 18.87 61'10" | 18.74 61'5" | 29.81 97'9" | -0.62 - 0.93 -2" - 3' | |
| 200" | 2.491 8'2" | 4.428 14'6" | 8 26'2" | 10.57 34'8" | 3.68 12' | 6.04 19'9" | 8.74 28'8" | 10.56 34'7" | 16.72 54'10" | 16.64 54'7" | 25.21 82'8" | 25.09 82'3" | 39.84 130'8" | -0.82 - 1.25 -2'8" - 4'1" | |
| 250" | 3.113 10'2" | 5.535 18'1" | 10.01 32'10" | 13.23 43'4" | | 7.56 24'9" | 10.94 35'10" | 13.22 43'4" | 20.93 68'8" | 20.83 68'4" | 31.54 103'5" | 31.44 103'1" | 49.88 163'7" | -1.03 - 1.56 -3'4" - 5'1" | |
| 300" | 3.736 12'3" | 6.641 21'9" | 12.03 39'5" | 15.89 52'1" | | 9.08 29'9" | 13.13 43' | 15.88 52'1" | 25.13 82'5" | 25.02 82'1" | 37.88 124'3" | 37.78 123'11" | 59.91 196'6" | -1.23 - 1.87 -4' - 6'1" | |
| 350" | 4.358 14'3" | 7.748 25'5" | 14.04 46' | 18.54 60'9" | | 10.61 34'9" | 15.33 50'3" | 18.54 60'9" | 29.33 96'2" | 29.22 95'10" | 44.22 145' | 44.13 144'9" | 69.95 229'5" | -1.44 - 2.18 -4'8" - 7'1" | |
| 400" | 4.981 16'4" | 8.855 29' | 16.06 52'8" | 21.2 69'6" | | 12.13 39'9" | 17.53 57'6" | 21.2 69'6" | 33.53 110' | 33.41 109'7" | 50.55 165'10" | 50.48 165'7" | 79.98 262'4" | -1.64 - 2.49 -5'4" - 8'2" | |
| 500" | 6.226 20'5" | 11.069 36'3" | 20.09 65'10" | 26.52 87' | | 15.18 49'9" | 21.92 71'10" | 26.52 87' | 41.93 137'6" | 41.79 137'1" | 63.22 207'4" | 63.17 207'3" | 100.05 328'2" | -2.06 - 3.11 -6'9" - 10'2" | |
| 600" | 7.472 24'6" | 13.283 43'6" | 24.12 79'1" | 31.84 104'5" | | 18.22 59'9" | 26.31 86'3" | 31.84 104'5" | 50.33 165'1" | 50.18 164'7" | 75.89 248'11" | 75.87 248'11" | 120.12 394'1" | -2.47 - 3.74 -8'1" - 12'3" | |

Calculation formulas for projection distance by lens types

| Names | Type | Through ratio | Aspect ratio | Projection distance formula |
|-----------------------|------------------------------|---------------|--------------|--|
| • PT-DZ6710/PT-DZ6700 | | | | |
| Standard zoom lens | | 1.8 - 2.4:1 | 16:10 | LW = 0.0395 x SD - 0.0744 LT = 0.0529 x SD - 0.0734 |
| | | | 16:9 | LW = 0.0406 x SD - 0.0745 LT = 0.0544 x SD - 0.0734 |
| ET-DLE055 | Fixed-focus lens | 0.8:1 | 16:10 | LW = 0.0175 x SD - 0.0476 |
| | | | 16:9 | LT = 0.0180 x SD - 0.0476 |
| ET-DLE150 | Wide-angle zoom lens | 1.3 - 1.8:1 | 16:10 | LW = 0.0286 x SD - 0.0540 LT = 0.0413 x SD - 0.0498 |
| | | | 16:9 | LW = 0.0294 x SD - 0.0540 LT = 0.0424 x SD - 0.0498 |
| ET-DLE250 | Intermediate-focus zoom lens | | 16:10 | LW = 0.0500 x SD - 0.0800 LT = 0.0789 x SD - 0.0792 |
| | | | 16:9 | LW = 0.0513 x SD - 0.0800 LT = 0.0811 x SD - 0.0792 |
| ET-DLE350 | Long-focus zoom lens | 3.8 - 6.0:1 | 16:10 | LW = 0.0787 x SD - 0.1351 LT = 0.1190 x SD - 0.1346 |
| | | | 16:9 | LW = 0.0809 x SD - 0.1351 LT = 0.1223 x SD - 0.1346 |
| ET-DLE450 | Ultra-long-focus zoom lens | | 16:10 | LW = 0.1192 x SD - 0.3017 LT = 0.1885 x SD - 0.2991 |
| | | | 16:9 | LW = 0.1225 x SD - 0.3017 LT = 0.1937 x SD - 0.2991 |
| • PT-DW6300 | | | | |
| Standard zoom lens | | 1.8 - 2.4:1 | 16:10 | LW= 0.0397 x SD - 0.0650 LT= 0.0524 x SD - 0.0638 |
| | | | 16:9 | LW= 0.0408 x SD - 0.0650 LT= 0.0539 x SD - 0.0638 |
| ET-DLE055 | Fixed-focus lens | 0.8:1 | 16:10 | LW= 0.0184 x SD - 0.0476 |
| | | | 16:9 | LT= 0.0189 x SD - 0.0476 |
| ET-DLE150 | Wide-angle zoom lens | 1.3 - 1.8:1 | 16:10 | LW= 0.0300 x SD - 0.0540 LT= 0.0433 x SD - 0.0498 |
| | | | 16:9 | LW= 0.0309 x SD - 0.0540 LT= 0.0445 x SD - 0.0498 |
| ET-DLE250 | Intermediate-focus zoom lens | | 16:10 | LW= 0.0524 x SD - 0.0800 LT= 0.0828 x SD - 0.0792 |
| | | | 16:9 | LW= 0.0539 x SD - 0.0800 LT= 0.0851 x SD - 0.0792 |
| ET-DLE350 | Long-focus zoom lens | 3.8 - 6.0:1 | 16:10 | LW= 0.0827 x SD - 0.1351 LT= 0.1249 x SD - 0.1346 |
| | | | 16:9 | LW= 0.0850 x SD - 0.1351 LT= 0.1284 x SD - 0.1346 |
| ET-DLE450 | Ultra-long-focus zoom lens | | 16:10 | LW= 0.1252 x SD - 0.3017 LT= 0.1979 x SD - 0.2991 |
| | | | 16:9 | LW= 0.1286 x SD - 0.3017 LT= 0.2034 x SD - 0.2991 |
| • PT-D6000/PT-D5000 | | | | |
| Standard zoom lens | | 1.8 - 2.4:1 | 16:10 | LW = 0.0370 x SD - 0.0650 LT = 0.0488 x SD - 0.0638 |
| | | | 16:9 | LW = 0.0403 x SD - 0.0650 LT = 0.0532 x SD - 0.0638 |
| ET-DLE055 | Fixed-focus lens | 0.8:1 | 16:10 | LW = 0.0171 x SD - 0.0476 |
| | | | 16:9 | LT = 0.0186 x SD - 0.0476 |
| ET-DLE150 | Wide-angle zoom lens | 1.3 - 1.8:1 | 16:10 | LW = 0.0280 x SD - 0.0540 LT = 0.0403 x SD - 0.0498 |
| | | | 16:9 | LW = 0.0305 x SD - 0.0540 LT = 0.0439 x SD - 0.0498 |
| ET-DLE250 | Intermediate-focus zoom lens | | 16:10 | LW = 0.0488 x SD - 0.0800 LT = 0.0771 x SD - 0.0792 |
| | | | 16:9 | LW = 0.0532 x SD - 0.0800 LT = 0.0840 x SD - 0.0792 |
| ET-DLE350 | Long-focus zoom lens | 3.8 - 6.0:1 | 16:10 | LW = 0.0770 x SD - 0.1351 LT = 0.1163 x SD - 0.1346 |
| | | | 16:9 | LW = 0.0839 x SD - 0.1351 LT = 0.1267 x SD - 0.1346 |
| ET-DLE450 | Ultra-long-focus zoom lens | | 16:10 | LT = 0.1165 x SD - 0.3017 LT = 0.1842 x SD - 0.2991 |
| | | | 16:9 | LT = 0.1270 x SD - 0.3017 LT = 0.2007 x SD - 0.2991 |

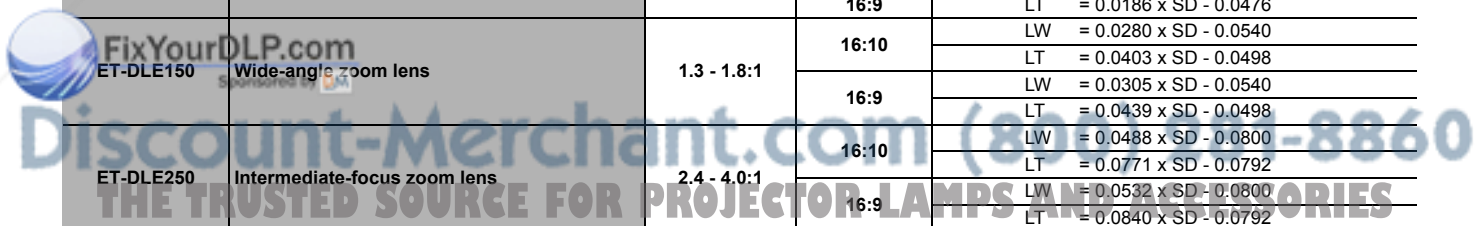

Geometric adjustment

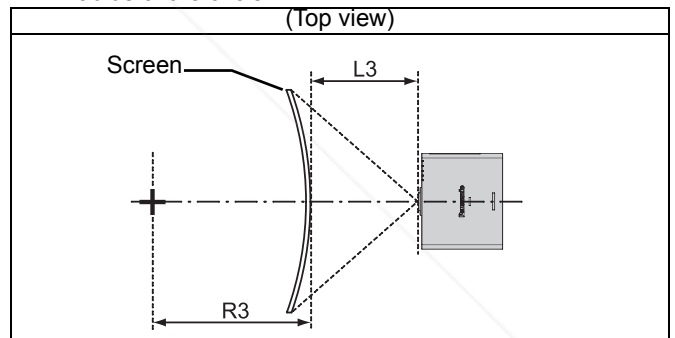
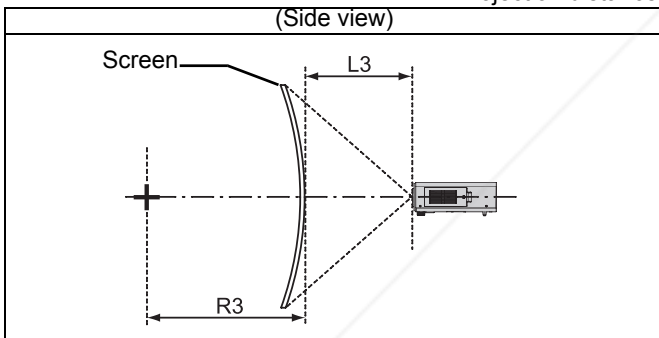
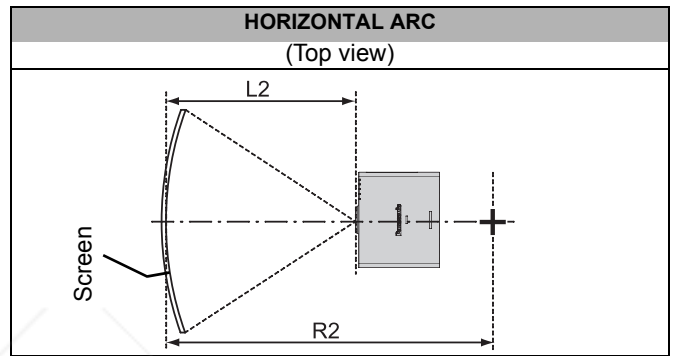
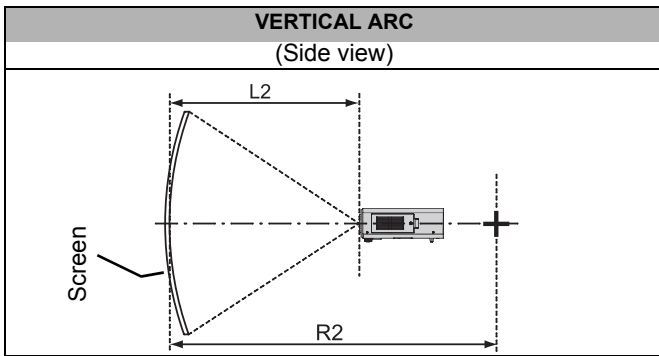
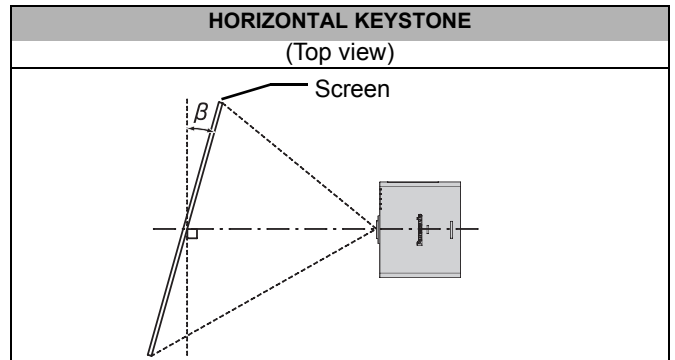
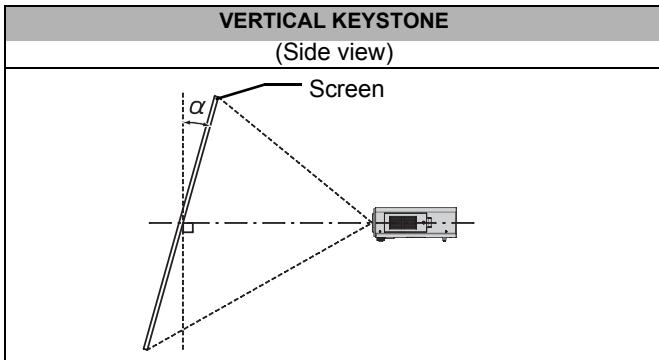

L2: Projection distance

R2: Radius of the circle

L3: Projection distance

R3: Radius of the circle

| | | Standard | ET-DLE055 | ET-DLE150 | ET-DLE250 | ET-DLE350 | ET-DLE450 |
|-----------------------------|---|----------|-----------|-----------|-----------|-----------|-----------|
| Keystone correction | VERTICAL KEYSTONE Correction angle α (°) | 40 | 30 | 40 | 40 | 40 | 40 |
| | HORIZONTAL KEYSTONE Correction angle β (°) | 15 | 15 | 15 | 15 | 15 | 15 |
| Keystone and arc correction | VERTICAL KEYSTONE Correction angle α (°) | 5 | 5 | 5 | 5 | 10 | 10 |
| | HORIZONTAL KEYSTONE Correction angle β (°) | 5 | 5 | 5 | 5 | 10 | 15 |
| | R2/L2 minimum value | 1.2 | 3 | 1.6 | 1.2 | 0.8 | 0.6 |
| | R3/L3 minimum value | 2.4 | 6 | 3.2 | 2.4 | 1.6 | 1 |
| | R2/L2 minimum value | 0.6 | 1.5 | 0.8 | 0.6 | 0.4 | 0.3 |
| Arc correction | R3/L3 minimum value | 1.2 | 4.3 | 1.6 | 1.2 | 0.8 | 0.5 |

NOTE:

- When using geometric adjustment, if the amount of compensation is too great, excessive blurring may result.
- The curved screens illustrated are simply sections of a full circle.

Front leg adjusters and throwing angle

You can screw up/down the front leg adjusters to control the angle of the projector for adjusting the throwing angle.

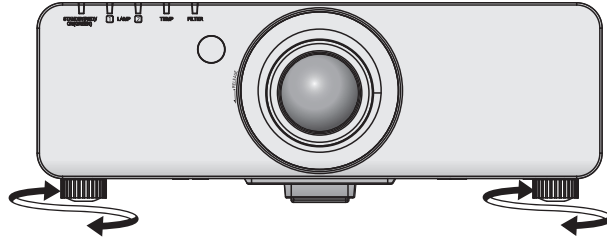
**NOTE:**

- Heated air comes out of the air exhaust port. Do not touch the air exhaust port directly.

Connections

Before connection to the projector

- Read and follow the operating and connecting instructions of each peripheral device.
- The peripheral devices must be turned off.
- Use cables that match each peripheral device to be connected.
- If the input signal is affected by signal jitter, the projected image may have poor image quality and timebase correction is effective.
- Confirm the type of video signals.
- The projector accepts the following signals: VIDEO, S-VIDEO, analogue-RGB (with TTL sync. Level) and digital signal.
- Some computer models are not compatible with the projector.
- When using long cables to connect with each of equipment to the projector, there is a possibility that the image will not be output correctly unless a compensator is used.

Pin assignments and signal names

S-VIDEO IN

| Pin No. | Signal names |
|---------|--------------------|
| 1 | Ground (luminance) |
| 2 | Ground (colour) |
| 3 | Luminance signal |
| 4 | Colour signal |

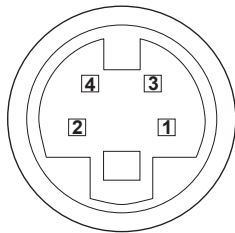

RGB2 IN

| Pin No. | Signal names |
|---------|--------------|
| 1 | R/Pr |
| 2 | G/G • SYNC/Y |
| 3 | B/Pb |
| 12 | DDC data |
| 13 | HD/SYNC |
| 14 | VD |
| 15 | DDC clock |

4, 9:
Not assigned

5 - 8, 10, 11:
GND terminals

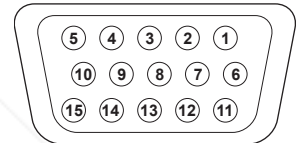

DVI-D IN

| Pin No. | Signal names |
|---------|----------------------|
| 1 | TMDS Data 2- |
| 2 | TMDS Data 2+ |
| 3 | TMDS Data 2/4 shield |
| 4 | |
| 5 | |
| 6 | DDC clock |
| 7 | DDC data |
| 8 | |
| 9 | TMDS Data 1- |
| 10 | TMDS Data 1+ |
| 11 | TMDS Data 1/3 shield |
| 12 | |

| Pin No. | Signal names |
|---------|----------------------|
| 13 | |
| 14 | +5V |
| 15 | GND |
| 16 | Hot Plug Detect |
| 17 | TMDS Data 0- |
| 18 | TMDS Data 0+ |
| 19 | TMDS Data 0/5 shield |
| 20 | |
| 21 | |
| 22 | TMDS clock shield |
| 23 | TMDS clock+ |
| 24 | TMDS clock- |

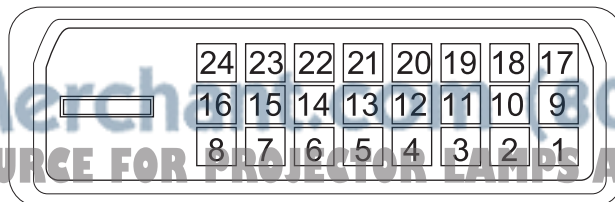

Connecting example: Computers

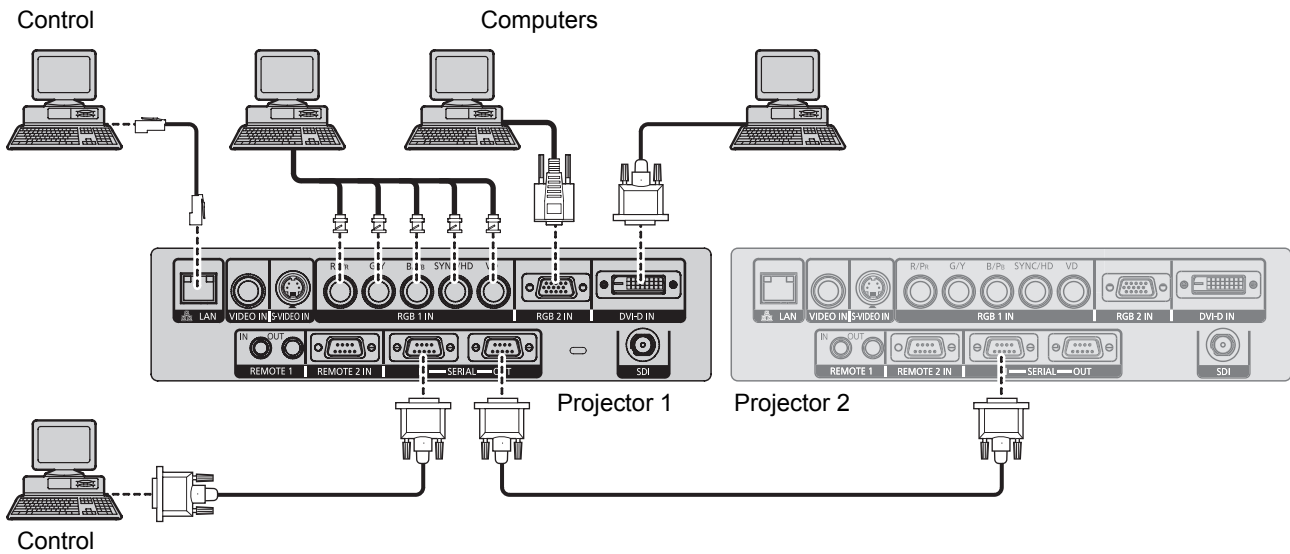

NOTE:

- For the specifications of the RGB signals that can be applied from the computer, see the data sheet of the operating instructions that is provided with the projector.
- If your computer has the resume feature (last memory), the computer may not function properly until the resume capability is disabled.
- When the SYNC ON GREEN signal is input, do not input sync signals to the SYNC/HD and VD terminals.
- When using DVI-D input, EDID settings may be required for the connected device. See “DVI-D IN” on page 26.

Connecting example: AV equipment

Connecting with VIDEO IN/S-VIDEO IN

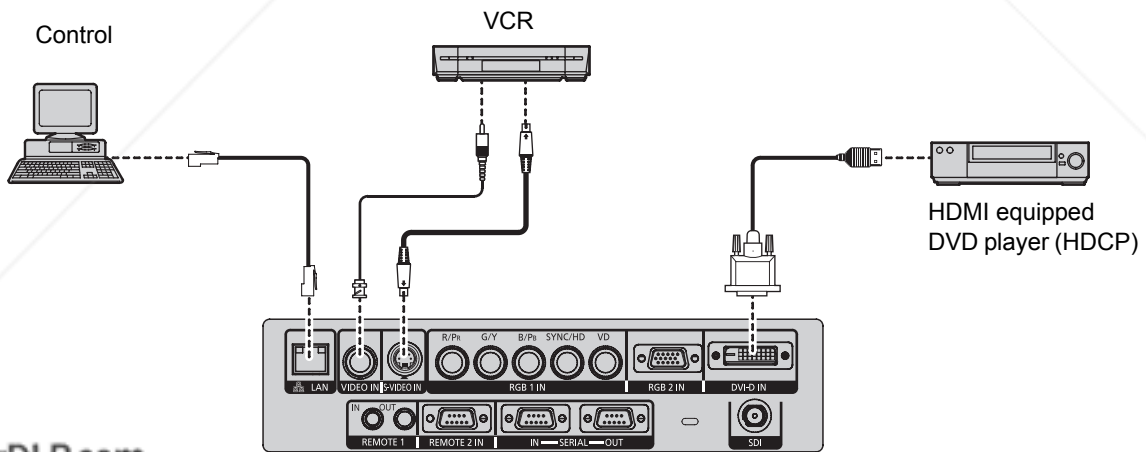

NOTE:

- When connecting with a VCR, be sure to use the one with a built-in time base corrector (TBC) or use a TBC between the projector and the VCR.
- If non-standard burst signals are connected, the image may be distorted. If this is the case, connect a TBC between the projector and the VCR.
- The DVI-D signals input terminal supports only a single link.
- The HDMI - DVI-D conversion cable is required to connect an HDMI compliant device.
- It is possible to connect the DVI-D input terminal with an HDMI- or DVI-D compliant device, but with some devices the images may not appear or other problems may be encountered in operation.



Discount Merchant.com (800) 281-8860
 THE TRUSTED SOURCE FOR PROJECTOR LAMPS AND ACCESSORIES

Menu Navigation

Main menu and Sub-menu

The menu options are structured and categorised. You can navigate through the menu with ▲ ▼ ◀ ▶ buttons. See "Menu Navigation" on page 12.

- The underlined items are factory default settings.
>
- Some default settings vary by the selected input signal.
- Sub-menu items vary according to the selected input signal.
- Some settings are adjustable without any signals.

PICTURE

| | | | |
|-----------------------------|-----------|-----------|----------|
| PICTURE MODE | | page 16 | |
| STANDARD | CINEMA | | |
| NATURAL | DYNAMIC | | |
| GRAPHIC | | | |
| CONTRAST | | page 16 | |
| (Default: 0) | | | |
| BRIGHTNESS | | page 16 | |
| (Default: 0) | | | |
| COLOR | | page 16 | |
| (Default: 0) | | | |
| TINT | | page 16 | |
| (Default: 0) | | | |
| COLOR TEMPERATURE | | page 16 | |
| DEFAULT | USER | | |
| MIDDLE | HIGH | | |
| WHITE GAIN | | page 17 | |
| (Default: 10) | | | |
| SYSTEM DAYLIGHT VIEW | | page 17 | |
| OFF | 1 | | |
| 2 | 3 | | |
| SHARPNESS | | page 17 | |
| (Default: 6) | | | |
| NOISE REDUCTION | | page 17 | |
| 1 | 2 | | |
| 3 | OFF | | |
| AI | | page 17 | |
| ON | OFF | | |
| SYSTEM SELECTOR | | page 17 | |
| AUTO | NTSC | NTSC 4.43 | PAL |
| PAL-M | PAL-N | SECAM | PAL60 |
| RGB | YCBCR | VGA60 | 480p |
| 480pRGB | YPBPR | 1080/60i | 1035/60i |
| 720/60p | 1080/24p | 1080/50i | 1080/30p |
| 1080/25p | 1080/24sF | 720/50p | 480i |
| 576i | | | |
| POSITION | | page 18 | |
| SHIFT | | page 18 | |
| ASPECT | | | |
| DEFAULT | VID AUTO | S1 AUTO | |
| VID AUTO(PRI.) | | THROUGH | |
| 16:9 | 4:3 | H-FIT | |
| V-FIT | HV-FIT | | |
| ZOOM | | page 19 | |
| INTERNAL | FULL | | |

| | |
|--------------------|---------|
| CLOCK PHASE | page 19 |
| (Default: 16) | |

| | |
|-----------------|---------|
| GEOMETRY | page 19 |
|-----------------|---------|

(PT-DZ6710 only)

| | |
|--------|----------|
| OFF | KEYSTONE |
| CURVED | PC |

GEOMETRY:KEYSTONE

VERTICAL KEYSTONE
VERTICAL SUB KEYSTONE
HORIZONTAL KEYSTONE
HORIZONTAL SUB KEYSTONE
LINEARITY

GEOMETRY:CURVED

LENS THROW RATIO
VERTICAL KEYSTONE
HORIZONTAL KEYSTONE
VERTICAL ARC
HORIZONTAL ARC
VERTICAL BALANCE
HORIZONTAL BALANCE

| | |
|-----------------|---------|
| KEYSTONE | page 21 |
|-----------------|---------|

(PT-DZ6700, PT-DW6300 and PT-D6000 only)

VERTICAL KEYSTONE
VERTICAL SUB KEYSTONE
LINEARITY

ADVANCED MENU

| | |
|-------------------------------|---------|
| DIGITAL CINEMA REALITY | page 22 |
|-------------------------------|---------|

| | |
|-----------|-----------|
| AUTO | OFF |
| 25p FIXED | 30p FIXED |

| | |
|-----------------|---------|
| BLANKING | page 22 |
|-----------------|---------|

| | |
|-------|-------|
| UPPER | LOWER |
| LEFT | RIGHT |

| | |
|-------------------------|---------|
| INPUT RESOLUTION | page 22 |
|-------------------------|---------|

| | |
|-------------|---------------|
| TOTAL DOTS | DISPLAY DOTS |
| TOTAL LINES | DISPLAY LINES |

| | |
|-----------------------|---------|
| CLAMP POSITION | page 22 |
|-----------------------|---------|

| | |
|------------------------|---------|
| EDGE BLENDING * | page 23 |
|------------------------|---------|

| | |
|-----|----|
| OFF | ON |
|-----|----|

GAMMA

| | | |
|-----|-----|---|
| 2.2 | 1.8 | 2 |
|-----|-----|---|

BRIGHT ADJUST

| | |
|---------------|----------------|
| BRIGHT INSIDE | BRIGHT OUTSIDE |
| OUTSIDE AREA | |

| | |
|------------------------|---------|
| RASTER POSITION | page 24 |
|------------------------|---------|

| | |
|----------|------------|
| VERTICAL | HORIZONTAL |
|----------|------------|

DISPLAY LANGUAGE

| | |
|----------|---------|
| ENGLISH | РУССКИЙ |
| DEUTSCH | 한국어 |
| FRANÇAIS | 中文 |
| ESPAÑOL | 日本語 |
| ITALIANO | |



DISPLAY OPTION

| | |
|--------------------------------------|----------------------|
| COLOR MATCHING * | page 25 |
| OFF 7 COLORS | 3 COLORS MEASURED |
| COLOR CORRECTION | page 25 |
| OFF | USER |
| CONTRAST MODE * | page 25 |
| NORMAL | HIGH |
| SCREEN SETTING | page 25 |
| SCREEN FORMAT | |
| 16:10 | 16:9 4:3 |
| SCREEN POSITION | |
| AUTO SIGNAL | page 25 |
| ON | OFF |
| AUTO SETUP | page 26 |
| DEFAULT USER | WIDE |
| DVI-D IN | page 26 |
| DVI EDID | |
| EDID3 | EDID1 EDID2(PC) |
| DVI SIGNAL LEVEL | |
| 0-255:PC | 16-235 |
| SDI IN | page 26 |
| (PT-DZ6710 only) | |
| 64-940 | 4-1019 |
| ON-SCREEN DISPLAY | page 26 |
| OSD POSITION | |
| 1 2 3 | |
| 4 5 6 | |
| 7 8 9 | |
| OSD DESIGN | |
| 1 2 3 | |
| 4 5 6 | |
| OSD MEMORY | |
| ON | OFF |
| INPUT GUIDE | |
| ON | OFF |
| WARNING MESSAGE | |
| ON | OFF |
| BACK COLOR | page 27 |
| BLACK LOGO1 | BLUE LOGO2 |
| STARTUP LOGO | page 27 |
| LOGO2 LOGO1 | NONE |
| FREEZE | page 27 |
| SIDE BY SIDE | page 27 |
| (PT-DZ6710/PT-DZ6700/PT-DW6300 only) | |
| VIDEO | S-VIDEO |
| RGB1 | RGB2 |
| DVI-D | SDI |
| OFF | |



PROJECTOR SETUP

| | |
|---------------------|---------|
| PROJECTOR ID | page 28 |
| ALL | 1 - 64 |

INSTALLATION page 28

FRONT/FLOOR FRONT/CEILING
REAR/FLOOR REAR/CEILING

HIGH ALTITUDE MODE page 28

OFF ON

COOLING CONDITION page 28

FLOOR SETTING
VERTICAL DOWN SETTING
CEILING SETTING
VERTICAL UP SETTING

LAMP SELECT page 29

DUAL SINGLE
LAMP1 LAMP2

LAMP RELAY page 29

OFF 00:00 - 23:00

LAMP POWER * page 29

HIGH LOW

STANDBY MODE page 29

NORMAL ECO

RS-232C page 29

(IN) BAUDRATE
(IN) PARITY
(OUT) BAUDRATE
(OUT) PARITY
RESPONSE(ID ALL)
GROUP
RESPONSE(ID GROUP)

REMOTE2 MODE page 29

DEFAULT USER

STATUS page 30

FILTER COUNTER RESET page 30

NO SIGNAL SHUT-OFF page 30

DISABLE
10 MIN. 20 MIN. 30 MIN. 40 MIN. 50 MIN.
60 MIN. 70 MIN. 80 MIN. 90 MIN.

FUNCTION BUTTON page 30

DISABLE
SUB MEMORY LIST
SYSTEM SELECTOR
SYSTEM DAYLIGHT VIEW
FREEZE
SIDE BY SIDE

DAY AND TIME page 31

TIME ZONE ADJUST CLOCK

SAVE ALL USER DATA page 31

LOAD ALL USER DATA page 31

INITIALIZE page 31

SERVICE PASSWORD page 31



TEST PATTERN

TEST PATTERN page 32



SIGNAL LIST page 33

REGISTERED SIGNAL STATUS
SUB MEMORY LIST

* Not available for PT-D5000.

Menu Navigation



SECURITY

| | |
|---|---------|
| SECURITY PASSWORD OFF ON | page 35 |
| SECURITY PASSWORD CHANGE | page 35 |
| DISPLAY SETTING OFF LOGO1 TEXT LOGO2 | page 35 |
| TEXT CHANGE | page 35 |
| MENU LOCK OFF ON | page 36 |
| MENU LOCK PASSWORD | page 36 |
| CONTROL DEVICE SETUP CONTROL PANEL ENABLE DISABLE REMOTE CONTROLLER ENABLE DISABLE | page 36 |



NETWORK

| | |
|---|---------|
| NETWORK SETUP HOST NAME DHCP IP ADDRESS SUBNET MASK DEFAULT GATEWAY STORE | page 37 |
| NETWORK CONTROL WEB CONTROL PJLink CONTROL COMMAND CONTROL COMMAND PORT STORE | page 37 |
| NETWORK STATUS DHCP IP ADDRESS SUBNET MASK DEFAULT GATEWAY DNS1 DNS2 MAC ADDRESS | page 37 |

Navigating through the menu

Displaying the main menu

Press the **MENU** button to display the main menu.

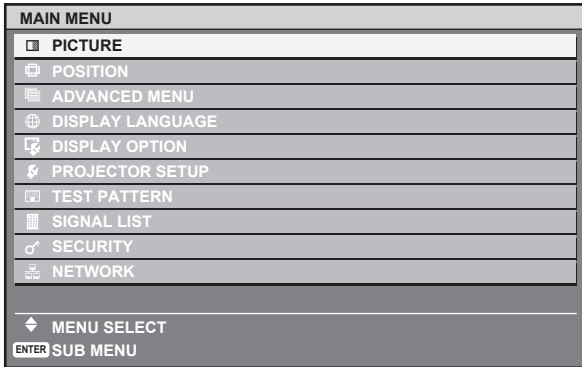

Adjusting with the bar scale items

The triangle mark under the bar indicates factory default setting and the square indicates the current setting.



Returning to the previous menu

Press the **MENU** button to return to the previous menu. Press repeatedly to escape from the menu mode and return to the projection.

Operating procedure

1. Press **▲ ▼** to scroll to the required main menu item and press the **ENTER** button to select.
 - The selected item is highlighted in orange and the sub-menu is displayed.
 - See "Main menu and Sub-menu" on page 12.

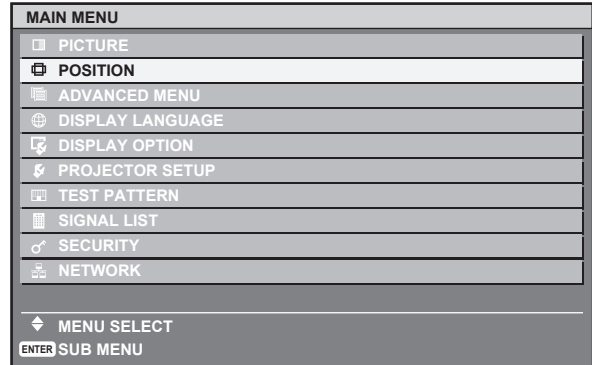

2. Press **▲ ▼** to scroll to the required sub-menu item and press **◀ ▶** or the **ENTER** button to adjust.
 - The selected item is called up and the other menu items disappear from the screen. Called up item will disappear after 5 seconds and return to the menu mode.
 - If there is a lower level, the next level will be displayed.
 - You can reset some setting values to factory default by pressing the **DEFAULT** button.

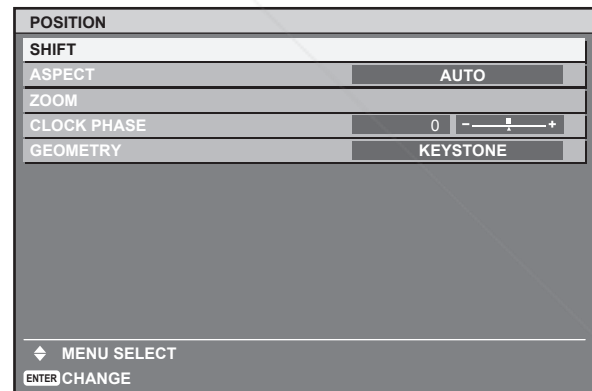

3. Press **◀ ▶** to adjust or set the selected item.
 - For items using a bar scale, the current settings are displayed on the left of the bar scale.
 - You can cycle through the options of an item by pressing **◀ ▶**.



4. Press the **MENU** button to return to the previous menu.

NOTE:

See "INITIALIZE" on page 31 to reset the settings.

PICTURE menu

Remote control



- See "Navigating through the menu" on page 15.
- See "Main menu and Sub-menu" on page 12.

PICTURE MODE

Depending on the projection environment, you can use these preset parameter settings to optimise image projection. Press ◀ ▶ to cycle through the options.

| | |
|-----------------|---|
| STANDARD | Setting for a general image |
| CINEMA | Setting for a cinema type movie |
| NATURAL | Reproduces the original colour of the image |
| DYNAMIC | Bright and sharp setting |
| GRAPHIC | Setting for image from computers |

NOTE:

- Factory default is **STANDARD** for moving images and **GRAPHIC** for RGB system.

CONTRAST

You can adjust the contrast of the projected image. Adjust the **BRIGHTNESS** in advance if necessary.

Call up the bar scale by pressing ◀, ▶ or the **ENTER** button, and press ◀ ▶ to adjust the value.

| | |
|---|--------|
| ◀ | Lower |
| ▶ | Higher |

Setting range: -31 to +31

BRIGHTNESS

You can adjust the brightness of the projected image. Call up the bar scale by pressing ◀, ▶ or the **ENTER** button, and press ◀ ▶ to adjust the value.

| | |
|---|----------|
| ◀ | Darker |
| ▶ | Brighter |

Setting range: -31 to +31

COLOR

You can adjust the colour saturation of the projected image. Call up the bar scale by pressing ◀, ▶ or the **ENTER** button, and press ◀ ▶ to adjust the value.

| | |
|---|---------|
| ◀ | Lighter |
| ▶ | Darker |

Setting range: -31 to +31

TINT

You can adjust the skin tone in the projected image. Call up the bar scale by pressing ◀, ▶ or the **ENTER** button, and press ◀ ▶ to adjust the value.

| | |
|---|---------------|
| ◀ | More reddish |
| ▶ | More greenish |

Setting range: -31 to +31

COLOR TEMPERATURE

You can adjust the white balance of the projected image. Select the required option and press ◀, ▶ or the **ENTER** button to call up the bar scale.

| | |
|----------------|--------------------------|
| DEFAULT | Balanced white |
| USER | More detailed adjustment |
| MIDDLE | More reddish |
| HIGH | More bluish |

● Adjusting more detailed white balance

You can adjust white balance of RGB individually in high and low level.

1. Select **USER** and press the **ENTER** button.
2. Select **WHITE BALANCE HIGH** or **WHITE BALANCE LOW**, and call up the scale bars by pressing ◀, ▶ or the **ENTER** button.
3. Press ◀ ▶ to adjust the value of each colour.

Setting range

WHITE BALANCE HIGH: 0 to 255 (Default: 255)

WHITE BALANCE LOW: 0 to 63 (Default: 32)

NOTE:

- With excessive unbalanced adjustment, such as extremely high with extremely low setting, all the colours may be displayed abnormally. Press the **DEFAULT** button to reset the selected item to the default setting.
- Adjust **COLOR TEMPERATURE** with signal image. Internal test pattern is not for **COLOR TEMPERATURE** adjustment.

WHITE GAIN

You can adjust the brightness of white area of the image. Call up the bar scale by pressing ◀, ▶ or the **ENTER** button, and press ◀ ▶ to adjust the value.

| | |
|-------------------------|--------------------|
| ◀ | More natural white |
| ▶ | Whiter |
| Setting range: 0 to +10 | |

SYSTEM DAYLIGHT VIEW

You can keep the projected image bright and vivid even in well-lit rooms where the ambient light sources cannot be controlled, such as when a door opens or when window coverings fail to block out sunlight. Press ◀ ▶ to cycle through the options.

| | |
|-----|----------|
| OFF | Deactive |
| 1 | Low |
| 2 | Middle |
| 3 | High |

SHARPNESS

You can adjust the sharpness of the projected image. Call up the bar scale by pressing ◀, ▶ or the **ENTER** button, and press ◀ ▶ to adjust the value.

| | |
|-------------------------|------------|
| ◀ | Less sharp |
| ▶ | More sharp |
| Setting range: 0 to +15 | |

NOISE REDUCTION

You can select the automatic noise reduction system strength. Press ◀ ▶ to cycle through the options.

| | |
|-----|----------|
| OFF | Deactive |
| 1 | Low |
| 2 | Middle |
| 3 | High |

AI

You can switch on/off the auto iris control system. Press ◀ ▶ to switch between **ON** or **OFF**.

| | |
|-----|----------|
| ON | Active |
| OFF | Deactive |

SYSTEM SELECTOR

When the input signal is changed, the projector detects the colour system and selects the matched setting automatically, or you can select manually. Press ◀ ▶ to cycle through the options.

| | |
|---|------------------------|
| ● VIDEO/S-VIDEO terminal | |
| AUTO ▶ NTSC ▶ NTSC 4.43 ▶ PAL ▶ PAL-M ▶ PAL-N ▶ SECAM ▶ PAL60 | |
| <ul style="list-style-type: none"> AUTO is usually recommended. Selecting options of AUTO are NTSC/NTSC 4.43/PAL/PAL-M/PAL-N/SECAM/PAL60. | |
| ● RGB 1 IN/RGB 2 IN terminal | |
| ● 480i/576i/576p signals | RGB ▶ YCbCr |
| ● VGA60/480p signals: | VGA60 ▶ 480p ▶ 480pRGB |
| ● Other signals | RGB ▶ YPbPr |
| <ul style="list-style-type: none"> See "List of compatible signals" in the Operating Instructions that provided with the projector. | |
| ● SDI terminal (PT-DZ6710 only) | |
| AUTO ▶ 108060i ▶ 103560i ▶ 72060p ▶ 108024p ▶ 108050i ▶ 108030p ▶ 108025p ▶ 108024sF ▶ 72050p ▶ 480i ▶ 576i | |

POSITION menu

Remote control



- See "Navigating through the menu" on page 15.
- See "Main menu and Sub-menu" on page 12.

SHIFT

You can move the projected image for fine adjustment. Press the **ENTER**, and **◀ ▶** to move horizontally and **▲ ▼** vertically.

Vertical adjustment

▲
Moves up the image.

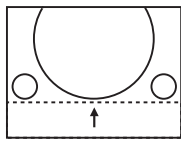

▼
Moves down the image.

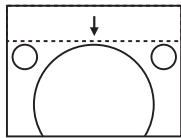

Horizontal adjustment

◀
Moves left the image.

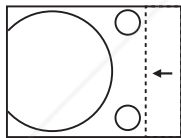

▶
Moves right the image.

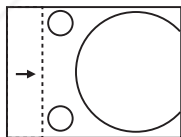

ASPECT

You can change the aspect ratio according to the selected **SCREEN FORMAT** setting of **SCREEN SETTING** in **DISPLAY OPTION** menu. Select the required option in **SCREEN FORMAT** in advance, and then change the aspect ratio. Press **◀ ▶** to cycle through the options.

Aspect ratio options

● DEFAULT

The image will be displayed in the aspect ratio of input signal.

● VID AUTO

Signals which contain video ID will be detected, and automatically switch the aspect ratio between 4:3 and 16:9. Effective with VIDEO and S-VIDEO (NTSC) signals.

● S1 AUTO

Detects signals which contain S1 signal in input signal, and automatically switch the aspect ratio between 4:3 and 16:9. Effective with S-VIDEO (NTSC) signals.

● VID AUTO(PRI.)

Detects signals which contain video ID or S1 signal in input signal, and automatically switch the aspect ratio between 4:3 and 16:9. Detects video ID on a priority basis. Effective with S-VIDEO and NTSC signals.

● THROUGH

The image will be displayed with the resolution of input signal.

● 16:9

When a 16:10, 16:9, 15:9 or 15:10 signal is detected, the image will be projected without any change, and other signals will be adjusted to 16:9.

● 4:3

When a 4:3 or 5:4 signal is detected, the image will be projected without any change, and other signals will be adjusted to 4:3 with preserving original ratio.

● H-FIT

The 4:3/5:4 image will be stretched to the horizontal limit of the **SCREEN FORMAT** setting size with preserving original ratio and the vertical edge will be cropped.

● V-FIT

The 16:9 (16:10)/15:9 image will be stretched to the vertical limit of the **SCREEN FORMAT** setting size with preserving original ratio and the horizontal edge will be cropped.

● HV-FIT

The image will be stretched to the vertical and horizontal limit of the **SCREEN FORMAT** setting size without preserving original ratio and the vertical and horizontal edge will not be cropped.

Menu items displaying pattern depends on signals

| |
|--|
| ● Signals from RGB 1 IN/RGB 2 IN/DVI-D IN and SDI (PT-DZ6710 only) DEFAULT ► THROUGH ► 16:9 ► 4:3 ► H-FIT ► V-FIT ► HV-FIT ► DEFAULT |
| ● Signals from S-VIDEO IN VID AUTO ► S1 AUTO ► VID AUTO(PRI.) ► THROUGH ► 16:9 ► 4:3 ► H-FIT ► V-FIT ► HV-FIT ► VID AUTO |
| ● Signals from other terminals VID AUTO ► THROUGH ► 16:9 ► 4:3 ► H-FIT ► V-FIT ► HV-FIT ► VID AUTO |

NOTE:

- If you project an image with an unmatched aspect ratio, the image may distort or some portions may be cropped. Select an aspect ratio which preserves the intention of the image creator.
- The order of **ASPECT** types is defined not only by the input method but also by the input signals.
- If you project a copyrighted image enlarged or distorted by using **ASPECT** function in commercial use in a public place, such as a restaurant or hotel, you might infringe on the copyright of the creator which is protected by copyright law.
- Selectable aspect ratio options vary according to input signals.

ZOOM

You can control the digital zoom scale vertically and horizontally, and digital zoom area. See "SCREEN SETTING" on page 25.

Zooming range: 50% to 999%

● When ASPECT setting is DEFAULT

You can change the zoom area in the setting of **SCREEN FORMAT** in **SCREEN SETTING**.

| | |
|-----------------|---|
| INTERNAL | Zoom area is the factory default setting of SCREEN FORMAT in SCREEN SETTING . |
| FULL | Zoom area is the setting of SCREEN FORMAT in SCREEN SETTING . |

Press ◀ ▶ to change the zoom scale of **VERTICAL** and **HORIZONTAL**.

● When ASPECT setting is THROUGH

Digital zoom is not available.

● When ASPECT setting is others

Zoom area is the setting of **SCREEN FORMAT** in **SCREEN SETTING**.

Press ◀ ▶ to change the zoom scale of **VERTICAL** and **HORIZONTAL**.

CLOCK PHASE

If you have interference patterns of the projected image, which is sometimes referred to as moire or noise, you can fine adjust the timing of the clock. (Signals from **RGB 1 IN/RGB 2 IN** only)

NOTE:

- With PT-DW6300 and PT-D6000, if the projecting signal's dot clock frequency is higher than 150 MHz, the adjustment may not make a difference.

GEOMETRY

(PT-DZ6710 only)

You can project on to specially shaped screens, such as distortional and cylindrical shaped screens, using unique image processing system. Press ◀ ▶ to cycle through the options.

| | |
|-----------------|---|
| OFF | Deactive |
| KEYSTONE | Adjusts projected image when distorted to a trapezoid. |
| CURVED | Adjusts projected image when distorted to a curved surface. |
| PC | For performing geometry correction from a connected computer. |

NOTE:

- **GEOMETRY** adjustment should be carried out by a person who is familiar with the projector or by a service person because a high level of skill is required to make successful adjustment.

POSITION menu

● GEOMETRY:KEYSTONE

Select **KEYSTONE** and press the **ENTER** button to display the options.

VERTICAL KEYSTONE

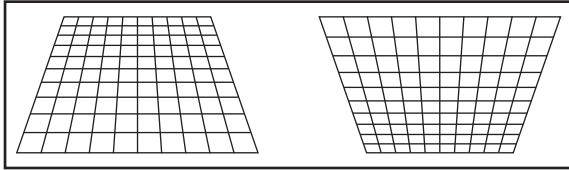

VERTICAL SUB KEYSTONE

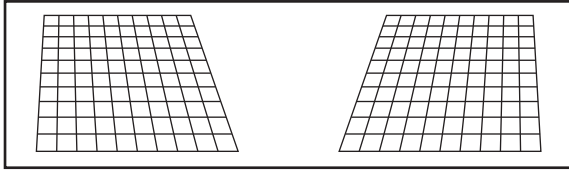

HORIZONTAL KEYSTONE

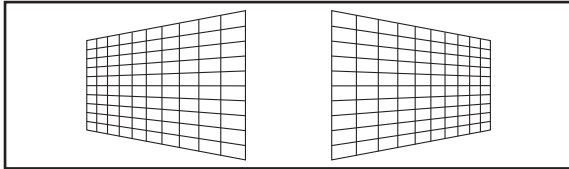

HORIZONTAL SUB KEYSTONE

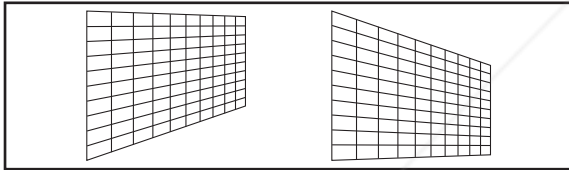

LINEARITY

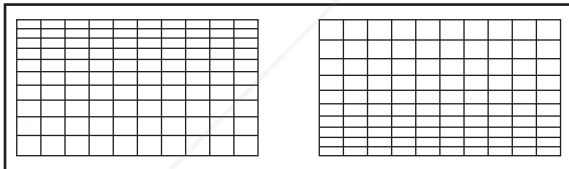

● GEOMETRY:CURVED

Select **CURVED** and press the **ENTER** button to display the options.

LENS THROW RATIO

Press ◀ ▶ to adjust throw ratio of the attached lens.

VERTICAL KEYSTONE

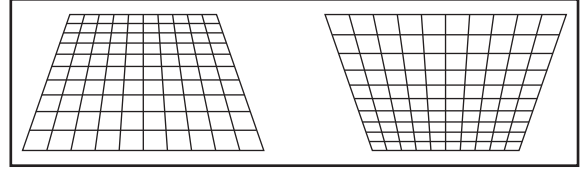

HORIZONTAL KEYSTONE

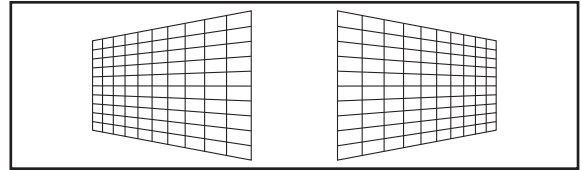

VERTICAL ARC

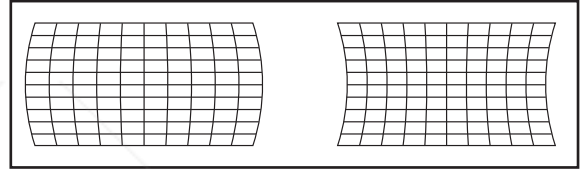

HORIZONTAL ARC

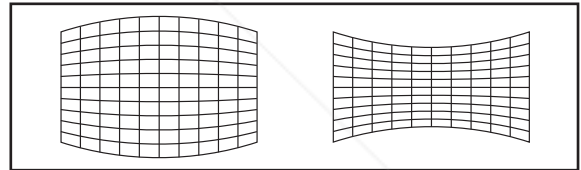

VERTICAL BALANCE

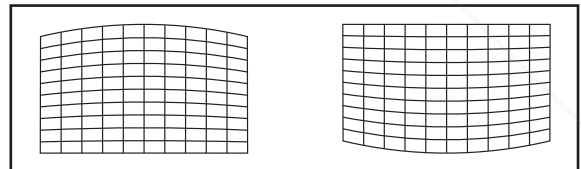

HORIZONTAL BALANCE

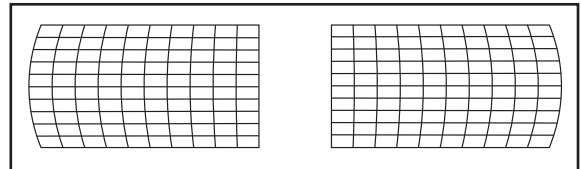

NOTE:

- When **GEOMETRY** setting is set, displayed menu or startup logo might be projected outside of the actual image area.
- When **GEOMETRY** is selected, **EDGE BLENDING** adjustment may be ineffective.

KEYSTONE

(PT-DZ6700/PT-DW6300/PT-D6000/PT-D5000 only)

If the projector is aligned non-perpendicularly to the screen, or if the projection screen has an angled surface, you can correct keystone.

VERTICAL KEYSTONE

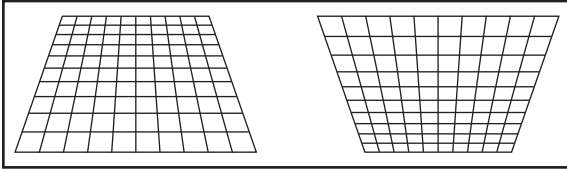

VERTICAL SUB KEYSTONE

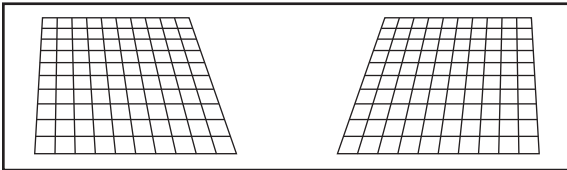

LINEARITY

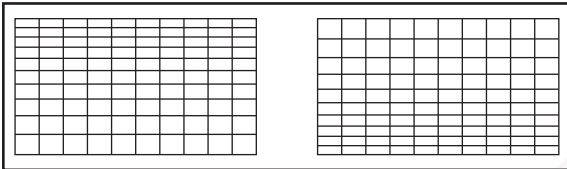

NOTE:

- When **KEYSTONE** setting is set, displayed menu or startup logo might be projected outside of the actual image area.
- For a better quality image, installing the projector with a minimum of distortion is recommended.
- Some distortion may be retained for lens shift adjustment.
- The result of the keystone correction will affect the aspect ratio and the size of the image.

ADVANCED MENU

Remote control



- See "Navigating through the menu" on page 15.
- See "Main menu and Sub-menu" on page 12.

DIGITAL CINEMA REALITY

You can improve the vertical resolution for PAL (or SECAM) 576i, NTSC 480i, 1080/50i or 1080/60i signals. Press ◀ ▶ to cycle through the options.

| | |
|------------------|---|
| AUTO | Detects PAL (or SECAM) 576i, 1080/50i, NTSC 480i and 1080/60i input signals and change the setting properly. |
| OFF | Deactive |
| 25p FIXED | Detects only PAL (or SECAM) 576i and 1080/50i signals, and adjust the vertical resolution of the image to 2:2 pulldown. |
| 30p FIXED | Detects only NTSC 480i and 1080/60i signals, and adjust the vertical resolution of the image to 2:3 pulldown. |

NOTE:

- **25p FIXED** or **30p FIXED** setting with signals that is not 2:2 pulldown may result low quality.

BLANKING

You can perform fine adjustments for blanking if noise appears at the ends of the screen or the image protrudes out of the screen during image projection using a VCR and so on. Press ▲ ▼ to select the edge to adjust, and ◀ ▶ to move the inner edge of the blank.

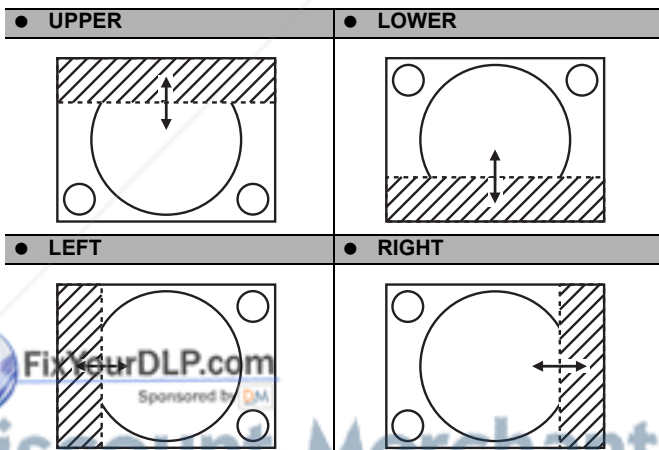

◀: Moves the inner edge of the blank area to outside.

▶: Moves the inner edge of the blank area to inside.

Setting range

| Models | Vertical | Horizontal |
|---------------------|----------|------------|
| PT-DZ6710/PT-DZ6700 | 0 - 599 | 0 - 959 |
| PT-DW6300 | 0 - 399 | 0 - 639 |
| PT-D6000/PT-D5000 | 0 - 383 | 0 - 511 |

INPUT RESOLUTION

Input resolution adjustment achieves the best image when the screen flickers or halo is observed around the contour, vertical stripes or stuck pixels appear on the screen. Press ▲ ▼ to select the required option to change, and ◀ ▶ to change the value. The initially displayed values vary according to the selected input signal.

- **TOTAL DOTS**
- **DISPLAY DOTS**
- **TOTAL LINES**
- **DISPLAY LINES**

NOTE:

- The vertical stripes will not appear on the all white signal image.
- The picture may be distorted during the adjusting operation, but this is not a fault.
- The input resolution can be adjusted only when RGB signal input is applied with RGB1 and RGB2 IN.
- With PT-DW6300/PT-D6000/PT-D5000, automatic adjustment is not available if signals having a dot clock frequency of more than 150 MHz are supplied.

CLAMP POSITION

When black part of the image is losing its colour or becomes green, you can adjust to the best colour. Press ◀ ▶ to change the value.

Setting range: 0 to 255

NOTE:

- Available with signals from **RGB 1 IN/RGB 2 IN** only.

EDGE BLENDING

(Not available for PT-D5000)

The built-in edge blending feature allows multiple projector images to be seamlessly overlapped by adding a brightness ramp. Press ▲ ▼ to select the required option.

| | |
|------------|---|
| OFF | Deactive |
| ON | Adds a brightness ramp to the overlapped area and adjustable the overlapping position manually. |

● Adjusting EDGE BLENDING

1. Select **ON** and press the **ENTER** button to display the detailed options.
2. Switch between **ON/OFF** of the required connecting edge.
3. Press ◀ ▶ to adjust the value of **START** and **WIDTH**.
 - **WIDTH** of the both projectors must be the same value.

Vertical connecting

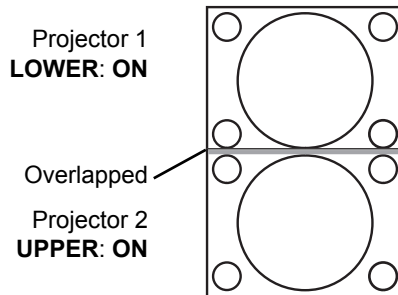

Horizontal connecting

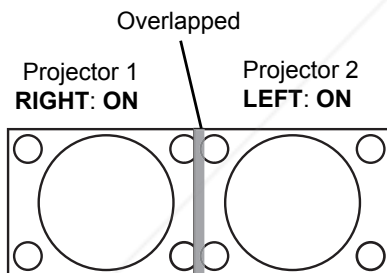

● Adjusting with colour markers

You can adjust with colour markers, which indicate the overlapping area.

1. Press ▼ several times until **MARKER** is displayed.
2. Select **MARKER** and press ◀ ▶ to switch between **ON/OFF**.
 - Green and red lines will be displayed.
 - Green line indicates **START** point, and red line indicates **WIDTH** from **START** point.
 - Adjust **START** and **WIDTH** for superimposing the green line to the red.

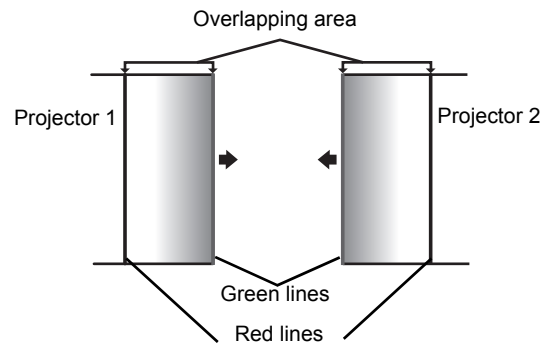

● Selecting gamma level

You can adjust gamma level of the lapping area for fine adjustment.

1. Select **GAMMA** and press the **ENTER** button.
2. Press ◀ ▶ to cycle through the options.
 - Options are 2.2, 1.8 and 2.0.
3. Press the **ENTER** button to apply the setting.

ADVANCED MENU

● Adjusting brightness around borderline of the image area

You can adjust brightness around borderline of the image area to minimise the difference between the overlapping area and the image. Select **BRIGHT ADJUST** and press the **ENTER** button. Press **▲ ▼** to select a colour, and **◀ ▶** to change the value.

| | |
|-----------------------|---|
| BRIGHT INSIDE | <ul style="list-style-type: none"> ● INTERLOCKED: ON Adjust WHITE only. ● INTERLOCKED: OFF Adjust RED, GREEN and BLUE individually. Setting range: 0 to +255 |
| BRIGHT OUTSIDE | <ul style="list-style-type: none"> ● INTERLOCKED: ON Adjust WHITE only. ● INTERLOCKED: OFF Adjust RED, GREEN and BLUE individually. Setting range: 0 to +255 |
| OUTSIDE AREA | If, after the BRIGHT INSIDE adjustment, only the vicinity of the borders of the areas where the pictures overlap and where the pictures do not overlap becomes bright, proceed to adjust the width of connecting side. |

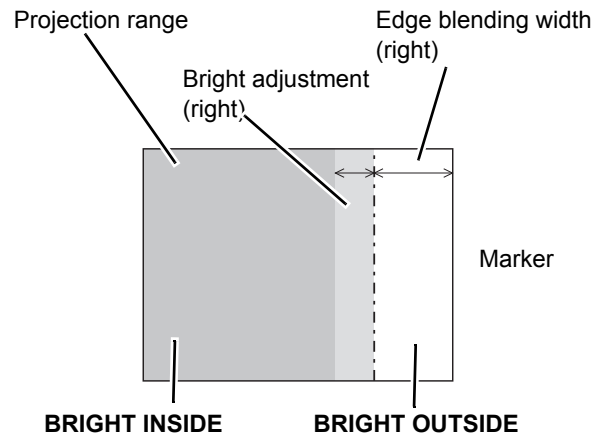

NOTE:

- Alternatively, if only the vicinity of the borders has brightened as a result of the width adjustments, proceed with the **BRIGHT OUTSIDE** adjustment.
- When a rear screen or screen with a high gain is used, the joints may appear to be discontinuous depending on the viewing position.

RASTER POSITION

When there is gap between the image area and the projecting area, you can move the image inside of the projecting area.

| | |
|-------------------|--|
| VERTICAL | Press ▲ ▼ to move the image up or down. |
| HORIZONTAL | Press ◀ ▶ to move the image to the left or right. |

DISPLAY OPTION menu

Remote control



- See "Navigating through the menu" on page 15.
- See "Main menu and Sub-menu" on page 12.

COLOR MATCHING

(Not available for PT-D5000)

When multiple projectors are used simultaneously, you can adjust the difference of the colours. Press ◀ ▶ to cycle through the options.

| | |
|----------|--|
| OFF | Deactive. |
| 3 COLORS | Adjusting RGB gain of RED, GREEN, BLUE and WHITE . Press ◀ ▶ to change the value and switch ON/OFF the AUTO TEST PATTERN . Setting range: 0 to +2048 (Setting value depends on your selected colours.) |
| 7 COLORS | Adjusting RGB gain of RED, GREEN, BLUE, CYAN, MAGENTA, YELLOW and WHITE . Press ◀ ▶ to change the value and switch ON/OFF the AUTO TEST PATTERN . Setting range: 0 to +2048 (Setting value depends on your selected colours.) |
| MEASURED | Adjusting colours based on measured values using colorimeter. Input measured result in MEASURED DATA , and adjust in TARGET DATA . Press ◀ ▶ to change the value and switch ON/OFF the AUTO TEST PATTERN . <ul style="list-style-type: none"> • PICTURE MODE in PICTURE menu need to be set to DYNAMIC for using colorimeter. |

NOTE:

- If the **TARGET DATA** is outside the colour range of the projector, the colours will not be projected correctly.
- When each colour option is selected while **AUTO TEST PATTERN** is activated, its one colour pattern will be displayed.
- Adjusting red gain of red colour changes its luminance, and likewise blue gain of blue and green gain of green.
- **COLOR MATCHING** adjustment should be carried out by a person who is familiar with the projector or by a service person because a high level of skill is required to make successful adjustment.
- Press the **DEFAULT** button to restore the factory default settings.

• **AI, COLOR CORRECTION** and **COLOR TEMPERATURE** are not available with **COLOR MATCHING**.

COLOR CORRECTION

You can adjust 6 colours and register the result for each of 4 types of signals, **VIDEO, S-VIDEO, RGB** and **YPbPr/YCbCr**.

| | |
|------|--|
| OFF | Deactive |
| USER | Adjust 6 colours, RED, GREEN, BLUE, CYAN, MAGENTA and YELLOW . |

CONTRAST MODE

(Not available for PT-D5000)

You can switch the contrast mode for operating environment.

| | |
|--------|--------------------|
| NORMAL | Maximum brightness |
| HIGH | Maximum contrast |

SCREEN SETTING

SCREEN FORMAT

Select the required screen format by pressing ◀ ▶. The **SCREEN FORMAT** setting will affect on the **ASPECT** setting. See "ASPECT" on page 18.

| | |
|---------------------|----------------------------------|
| PT-DZ6710/PT-DZ6700 | 16:10 ^{*1} ▶ 16:9 ▶ 4:3 |
| PT-DW6300 | 16:10 ^{*1} ▶ 16:9 |
| PT-D6000/PT-D5000 | 4:3 ^{*1} ▶ 16:9 |

*1. **SCREEN POSITION** is not available.

SCREEN POSITION

You can change the displaying position of the projecting area. Press ◀ ▶ to adjust the value.

| | | |
|---------------------|----------------|----------------|
| PT-DZ6710/PT-DZ6700 | Setting range: | |
| | 16:10 | Not available. |
| | 16:9 | -60 to +60 |
| PT-DW6300 | Setting range: | |
| | 16:10 | Not available. |
| | 16:9 | -40 to +40 |
| PT-D6000/PT-D5000 | Setting range: | |
| | 4:3 | Not available. |
| | 16:9 | -96 to +96 |

AUTO SIGNAL

You can turn **ON/OFF** automatically detecting system of the **AUTO SETUP** feature.

| | |
|-----|---|
| OFF | Only when the AUTO SETUP button is pressed, the projected image position will be adjusted. |
| ON | When the projector detects a COMPUTER or DVI signal, adjust the projected image position automatically. |

DISPLAY OPTION menu

AUTO SETUP

You can change the **AUTO SETUP** feature for specific signals. Press ◀ ▶ to cycle through the options and press the **ENTER** button to perform the **AUTO SETUP**.

| | |
|----------------|---|
| DEFAULT | For 4:3 or 5:4 signals Applicable resolution: 640 x 400, 640 x 480, 800 x 600, 832 x 624, 960 x 720, 1 024 x 768, 1 152 x 864, 1 152 x 870, 1 280 x 960, 1 280 x 1 024, 1 600 x 1 200, 1 400 x 1 050 |
| WIDE | For wide signals Applicable resolution: 720 x 400, 848 x 480, 1 280 x 720, 1 024 x 600, 1 120 x 750, 1 440 x 900, 1 680 x 1 050 |
| USER | For specific resolution signals Select the required MODE and change the DISPLAY DOTS value by pressing ◀ ▶. |

DVI-D IN

NOTE:

- The **DVI-D IN** setting for the best quality depends on the output equipment. Refer the instructions of the connected equipment.
- DVI** signal is very sensitive, and malfunction may occur or other problems could be encountered with some **DVI** equipment.

DVI EDID

You can switch the EDID setting and signal level for variable **DVI** signals.

| | |
|------------------|--|
| EDID3 | Switch between fine settings for a moving image and for a still image. |
| EDID1 | Fine setting for mainly a moving image, such as signals from a DVD player. |
| EDID2(PC) | Fine setting for mainly a still image, such as computer. |

DVI SIGNAL LEVEL

| | |
|-----------------|--|
| 0-255:PC | (PC scale) For connecting to a computer via DVI-D IN terminal |
| 16-235 | (TV scale) For connecting to AV equipment via DVI-D IN terminal, such as a DVI - HDMI conversion cable connection |

SDI IN

FixYourDLP.com
PT-DZ6710 only

You can select signal amplitude type.

| | |
|---------------|--|
| 64-940 | Normal setting |
| 4-1019 | For when grey colour is too close to black |

NOTE:

- Available with **YPBPR** or **RGB** of HD-SDI signal.
- Usually **64-940** setting is recommended.

ON-SCREEN DISPLAY

OSD POSITION

You can change the displaying position of the main menu. Press ◀ ▶ to cycle through the options.

| | | |
|------------------------|--------------------------|-------------------------|
| 1 Upper left | 4 Upper centre | 7 Upper right |
| 2 Left | 5 Centre | 8 Right |
| 3 Lower left | 6 Lower centre | 9 Lower right |

OSD DESIGN

You can change the background colour of the menu. Press ◀ ▶ to select the required option.

| | | | |
|----------|--------|----------|-------|
| 1 | Yellow | 4 | Green |
| 2 | Blue | 5 | Pink |
| 3 | White | 6 | Brown |

OSD MEMORY

The current menu cursor position will be retained temporarily unless the projector switched off.

| | |
|------------|------------------------------------|
| ON | Memorise the menu cursor position. |
| OFF | Reset the cursor position. |

INPUT GUIDE

The name of current selected input terminal will be displayed where the position that is selected in **OSD POSITION**.

| | |
|------------|---|
| ON | Displays the current selected input terminal. |
| OFF | Deactive |

WARNING MESSAGE

You can prevent the display of warning messages.

| | |
|------------|---|
| ON | All of the warning messages will be displayed. |
| OFF | None of the warning messages will be displayed. |

NOTE:

- When the **WARNING MESSAGE** is set to **OFF**, use the projector with utmost care due to none of the warning messages will be displayed.

BACK COLOR

You can choose a blank screen colour for when the projector is idle. Press ◀ ▶ to select the required option.

| | |
|--------------|------------------------------|
| BLACK | Displays black pattern. |
| BLUE | Displays solid blue. |
| LOGO1 | Displays user defined image. |
| LOGO2 | Displays PANASONIC logo. |

NOTE:

- Special software is required to define the **LOGO1** image. Contact to an Authorised Service Centre.

STARTUP LOGO

You can switch the logo on/off that is displayed when starting up the projector. Press ◀ ▶ to select the required option. **STARTUP LOGO** will be displayed for 30 seconds.

| | |
|--------------|------------------------------|
| LOGO2 | Displays PANASONIC logo. |
| NONE | Deactive |
| LOGO1 | Displays user defined image. |

NOTE:

- Special software is required to define the **LOGO1** image. Contact to an Authorised Service Centre.

FREEZE

Press the **ENTER** button to capture the image, and you can see it as a still picture while the AV equipment are continuing. Press the **ENTER** button to escape and return to the continuing image.

SIDE BY SIDE

(PT-DZ6710/PT-DZ6700/PT-DW6300 only)

You can project the image and another source of image at the same time in double window style.

1. Press the **ENTER** button.
 - Displays the main image on the left, sub image on the right.
2. Press the **MENU** button.
 - Displays the sub menu with current displayed signal information.
3. ▲ ▼ to select the sub image signal and press the **ENTER** button.
 - Select **OFF** to escape from the **SIDE BY SIDE** mode. To enter the **SIDE BY SIDE** mode again, select **SIDE BY SIDE** of the menu.

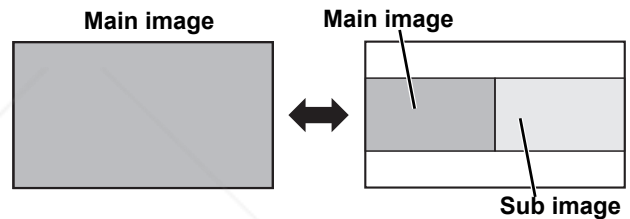

NOTE:

- **FREEZE** control is available with the first image only.
- While **SIDE BY SIDE** is activated, **ZOOM** and **AUTO SETUP** are not available.
- While **SIDE BY SIDE** is activated, the main menu will not be displayed.
- The second image will apply to the value of the **PICTURE** settings of the first image except **CONTRAST** and **BRIGHTNESS**.
- **COMPUTER** and **NETWORK** signals will not keep the adjusted aspect ratio.
- Some combination of the signals are not available. See "SIDE BY SIDE function signal combination table" on page 48.

PROJECTOR SETUP menu

Remote control



- See "Navigating through the menu" on page 15.
- See "Main menu and Sub-menu" on page 12.

PROJECTOR ID

The projector has an ID number setting function that helps the user to control multiple projectors either simultaneously or separately with a single remote control. Press ◀ ▶ to cycle through the options.

| | |
|--------|---|
| ALL | Available to control from any ID numbered remote control or computer. |
| 1 - 64 | Available to control from the same ID numbered remote control. |

NOTE:

- See "Remote control ID" in the operating instructions booklet that is provided with the projector.

INSTALLATION

When installing the projector, select the projection method according to the projector position. Press ◀ ▶ to cycle through the options.

| | |
|---------------|---|
| FRONT/FLOOR | Setting on a desk/floor and projecting from front |
| FRONT/CEILING | Mounting on the ceiling and projecting from front |
| REAR/FLOOR | Setting on a desk/floor and projecting from rear |
| REAR/CEILING | Mounting on the ceiling and projecting from rear |

NOTE:

- See "Projection method" in the operating instructions booklet that is provided with the projector.

HIGH ALTITUDE MODE

If you use the projector at high elevation, the **HIGH ALTITUDE MODE** setting needs to be **ON** to set the fan speed high. Press ◀ ▶ to select the required option.

| | |
|-----|------------------------|
| OFF | The fan speed is low. |
| ON | The fan speed is high. |

NOTE:

- At 1 400 - 2 700 m (4 593 - 8 858 ft) sea level, the setting must be **ON**.
- The loudness of fan noise depends on the **HIGH ALTITUDE MODE** setting.

COOLING CONDITION

You can control the fan speed for projecting angle. Press ◀ ▶ to cycle through the options.

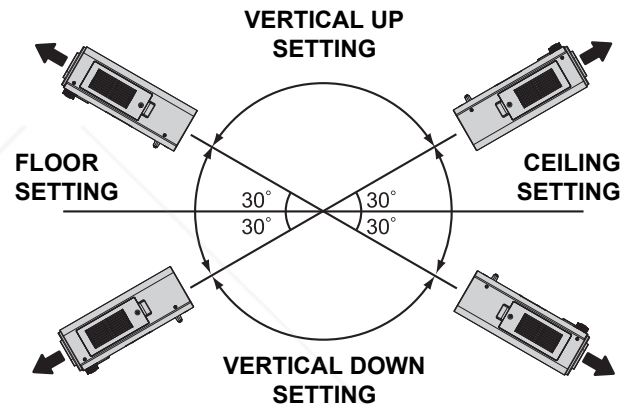

NOTE:

- When the projector is angled, **COOLING CONDITION** setting must be set correctly. Failure to observe this may result in malfunctions, or the life of the lamp or the other components may be shortened.

LAMP SELECT

You can select a lamp lighting pattern for using environment. Press ◀ ▶ to cycle through options, and the **ENTER** button.

| | |
|---------------|--|
| DUAL | All lamps will light. |
| SINGLE | Selects a lamp with shorter duration of use. |
| LAMP1 | Selects the Lamp unit 1. |
| LAMP2 | Selects the Lamp unit 2. |

NOTE:

- If, in the **SINGLE**, **LAMP1** or **LAMP2** mode, one lamp remains off or the currently active lamp exceeds 2 000^{*1} hours of cumulative operating time (when **HIGH** is selected as the **LAMP POWER** setting^{*2}), the other lamp will light. If, in the **DUAL** mode, one lamp remains off or the currently active lamp exceeds 2 000^{*1} hours of cumulative operating time (when **HIGH** is selected as the **LAMP POWER** setting^{*2}), the other lamp alone will light. However, if both lamps remain off or the 2 000^{*1} hours of cumulative operating time (when **HIGH** is selected as the **LAMP POWER** setting^{*2}) are exceeded, the projector will enter the standby mode.
- The colours of the items indicate the status.
Green: Current setting
Yellow: Current setting (when a lamp fails or fails to light)
Red: Lamp that has failed to light
White: Any other status.
- If the projector is repeatedly used for short periods of time, the lamps will need to be replaced more frequently.

*1. 3 000 hours for PT-D5000 only.

*2. Not available for PT-D5000.

LAMP RELAY

If using the projector for a continuous period of 24 hours or more, this setting can be used to automatically switch the lamps that are turned on in order to reduce the lamp deterioration that can occur as a result of continuous use.

| | |
|----------------------|---|
| OFF | Deactive |
| 00:00 - 23:00 | 1 hour interval from 00:00 to 23:00 |

NOTE:

- Only when **DUAL** or **SINGLE** is selected in **LAMP SELECT**, **LAMP RELAY** is available. If **LAMP1** or **LAMP2** is selected, **LAMP RELAY** function is not available.

| LAMP SELECT setting | Repeated operation |
|---------------------|--|
| SINGLE | LAMP1 and LAMP2 light alternately by the set time, and the shorter duration of use lamp will light first. |
| DUAL | After both lamps light for the set time, only one lamp is turned off for 2 hours, then for only the other lamp for next 2 hours. The longer duration of use lamp will be turned off first. |

LAMP POWER

(Not available for PT-D5000)

The luminance of the projection lamp can be changed depending on user's needs or the viewing conditions.

| | |
|-------------|--|
| HIGH | Set when high brightness is necessary. |
| LOW | Set when high brightness is not necessary. |

NOTE:

- When set to **LOW**, it is possible to reduce power consumption, reduce operating noise and extend lamp service life.

STANDBY MODE

You can select the electrical consumption while in standby mode.

NOTE:

- With **ECO** setting, **NETWORK** function, **RS-232C** output and some of **RS-232C** commands are not available. When switch on the projector, projection will start about 10 seconds late.

RS-232C

This sets the communication parameters at the serial terminals.

| | |
|---------------------------|---|
| (IN) BAUDRATE | Select 9600 , 19200 or 38400 . |
| (IN) PARITY | Select NONE , EVEN or ODD . |
| (OUT) BAUDRATE | Select 9600 , 19200 or 38400 . |
| (OUT) PARITY | Select NONE , EVEN or ODD . |
| RESPONSE(ID ALL) | Select ON or OFF . |
| GROUP | Select A to Z . |
| RESPONSE(ID GROUP) | Select ON or OFF . |

REMOTE2 MODE

You can customise the **REMOTE 2 IN** terminal function.

- DEFAULT** The pin assignment of the **REMOTE 2 IN** terminal is used as the projector default setting.
- USER** For changing an optional input module or customising the pin assignments.

| | |
|--------------------|---|
| PIN1 | GND |
| PIN2 | POWER ▶ NONE |
| PIN3 - PIN7 | RGB1 ▶ RGB2 ▶ VIDEO ▶ S-VIDEO ▶ DVI-D ▶ BALLAST VERSION ▶ REWIND ALL FILTER ▶ NONE |
| PIN8 | SHUTTER ▶ NONE |
| PIN9 | ENABLE ▶ DISABLE |

PROJECTOR SETUP menu

STATUS

You can see the status of the projector about the following items.

| Items | Description |
|------------------------|---|
| INPUT | Displays the input selection state. |
| NAME | Displays the input signal name. |
| SIGNAL FREQUENCY | Displays the frequency of the input signal. |
| PROJECTOR RUNTIME | Displays the projector runtime. |
| LAMP1 | Displays the lighting time of LAMP1 . |
| LAMP2 | Displays the lighting time of LAMP2 . |
| INTAKE AIR TEMP. | Displays the intake air temperature of the projector. |
| OPTICS MODULE TEMP. | Displays the temperature inside the projector. |
| AROUND LAMP TEMP. | Displays the temperature around the lamp of the projector. |
| REMAINING FILTER | Displays the filter runtime. |
| QUANTITY | Displays the filter remaining quantity. |
| PROJECTOR TYPE | Displays type of projector. |
| SERIAL NUMBER | Displays the serial number of the projector. |
| MAIN VERSION | Displays the main version of the firmware of the projector unit. |
| SUB VERSION | Displays the sub version of the firmware of the projector unit. |
| NETWORK VERSION | Displays the network version of the projector unit. |
| ON COUNT | |
| POWER ON TIMES | Displays the number of times the power has been tuned on. |
| LAMP1 ON | Displays the number of times LAMP1 has been lit. |
| LAMP2 ON | Displays the number of times LAMP2 has been lit. |
| SHUTTER | Displays the number of times the shutter function has been used. |
| LAMP1 LOW * | Displays the LAMP1 lighting time with LOW setting in LAMP POWER . |
| HIGH * | Displays the LAMP1 lighting time with HIGH setting in LAMP POWER . |
| LAMP2 LOW * | Displays the LAMP2 lighting time with LOW setting in LAMP POWER . |
| HIGH * | Displays the LAMP2 lighting time with HIGH setting in LAMP POWER . |
| NUMBER OF ENTRY SIGNAL | Displays the number of registered signals. |
| REMOTE2 STATUS | Displays REMOTE 2 IN control status. |

* Not available for PT-D5000.

FILTER COUNTER RESET

After you replaced the Auto Cleaning Filter (ACF), **REMAINING FILTER** of **STATUS** need to be reset to "0".

1. Press the **ENTER** button.
2. Select **OK** by pressing **◀**, then press the **ENTER** button.
3. The **REMAINING FILTER** of **STATUS** will be reset to "0".
 - Display the **STATUS** and confirm the figure.

NOTE:

- See "Replacing the Auto Cleaning Filter (ACF)" in the operating instructions booklet that is provided with the projector.

NO SIGNAL SHUT-OFF

You can set the timer to switch off the power of the projector after a certain period of time automatically when no signal is detected. Press **◀▶** to select the required period from 10 to 90 minutes at intervals of 10 minutes.

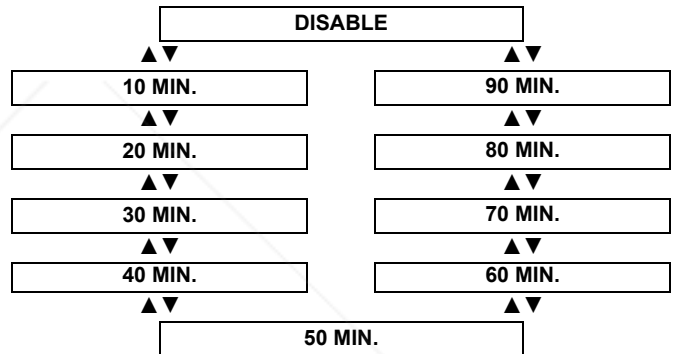

FUNCTION BUTTON

You can assign a certain menu function to the **FUNCTION** button as shortcut. Press **◀▶** to select the required menu option, and the **ENTER** button.

| Options | Functions | Refer |
|----------------------|---|-------|
| DISABLE | Deactivate the FUNCTION button. | - |
| SUB MEMORY LIST | Displays the assigned SUB MEMORY LIST . | 34 |
| SYSTEM SELECTOR | Switches SYSTEM SELECTOR options. | 17 |
| SYSTEM DAYLIGHT VIEW | Switches the SYSTEM DAYLIGHT VIEW setting. | 17 |
| FREEZE | Freezes the image. | 27 |
| SIDE BY SIDE | Start the SIDE BY SIDE mode. | 27 |

DATE AND TIME

You can set the time zone and correct the time and date of internal clock.

| | |
|---------------------|---|
| TIME ZONE | Select the current located time zone. |
| ADJUST CLOCK | Adjust YEAR, MONTH, DAY, HOUR and MINUTE by pressing ◀ ▶, then select APPLY and press the ENTER button. |

SAVE ALL USERS DATA

You can save various setting values as a backup to the internal memory of the projector.

1. Press the **ENTER** button.
 - The **SECURITY PASSWORD** will be asked to perform.
2. Perform the **SECURITY PASSWORD**.
 - The confirmation screen will be displayed.
 - See "SECURITY PASSWORD" on page 35.
3. Press ◀ to select **OK**, then press the **ENTER** button.

NOTE:

- E-mail settings of **NETWORK** that is controlled by web browser, and the image data for **LOGO1** in **BACK COLOR** and **STARTUP LOGO** will not be saved.

LOAD ALL USERS DATA

You can load the saved data in **SAVE ALL USER DATA**.

1. Press the **ENTER** button.
 - The **SECURITY PASSWORD** will be asked to perform.
2. Perform the **SECURITY PASSWORD**.
 - The confirmation screen will be displayed.
 - See "SECURITY PASSWORD" on page 35.
3. Press ◀ to select **OK**, then press the **ENTER** button.
4. The projector returns to the standby mode to reflect the saved data.

INITIALIZE

You can reset the settings to the factory defaults by the selected mode.

1. Select the required mode to initialise.
2. Press the **ENTER** button.
3. Perform the **SECURITY PASSWORD**.
 - The confirmation screen will be displayed.
 - See "SECURITY PASSWORD" on page 35.
4. Press ◀ to select **OK**, then press the **ENTER** button.
 - When initialising by **ALL USER DATA**, switch off the power and restart the projector.

| | |
|-----------------------|--|
| ALL USER DATA | All setting values including registered signals in SIGNAL LIST , e-mail settings of NETWORK , and registered image data for LOGO1 in BACK COLOR and STARTUP LOGO will return to factory settings. |
| ENTRY SIGNAL | All registered signal settings in SIGNAL LIST will return to factory settings. |
| NETWORK/E-MAIL | All setting values in NETWORK including e-mail settings will return to factory settings. |
| LOGO IMAGE | The registered image data for LOGO1 in BACK COLOR and STARTUP LOGO will return to factory settings. |

SERVICE PASSWORD

SERVICE PASSWORD is for a service person.

TEST PATTERN

Remote control



- See “Navigating through the menu” on page 15.
- See “Main menu and Sub-menu” on page 12.

TEST PATTERN

You can use 7 test patterns to adjust the signal image.

1. Display an input signal image.
2. Press the **MENU** button to display the main menu.
3. Select **TEST PATTERN** menu.
4. Press ◀ ▶ to select the required test pattern.
 - Press the **ON SCREEN** button to clear the screen if necessary.

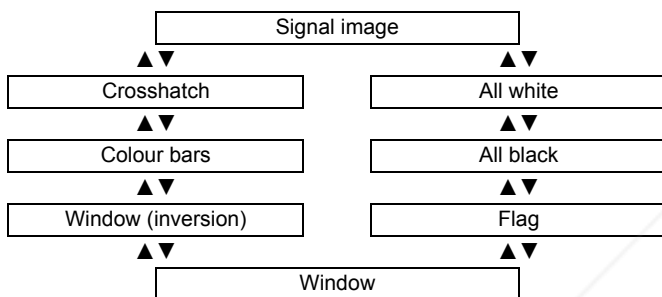

NOTE:

- **POSITION** menu adjusting is not effective with the test patterns.

SIGNAL LIST

Remote control



- See “Navigating through the menu” on page 15.
- See “Main menu and Sub-menu” on page 12.

SIGNAL LIST and SUB MEMORY LIST

You can register a input signal as a **SIGNAL LIST** data, and several sets of adjusted settings for the signal as **SUB MEMORY LIST** data.

NOTE:

- You can register data up to 96 in total number of the signal data and any corresponding sub memory data.
- The names of the registered data are automatically determined by the input signals and memory numbers.
- If a menu is being displayed, the new signals will be registered at the instant they are input.

Managing the list and the registered data

Registering a signal to the list

When a new format input signal is applied to the projector, press the **MENU** button to register to the **SIGNAL LIST**.

NOTE:

- The memories are numbered over 12 pages (A to L: 8 data items can be registered on each page), and the data is registered in the unused memory with the lowest number. If all the memories are used, the data of the old signals is overwritten in sequence.
- When a new input signal is applied while the menu is displayed, the signal will be registered to the list.

Displaying the signal list and the status

1. Select **SIGNAL LIST** in the main menu.
2. Press the **ENTER** button.
 - Display the **REGISTERED SIGNAL LIST**.
3. Select the required signal data.
4. Press the **ENTER** button.
 - Displays the **REGISTERED SIGNAL STATUS**.

| | |
|-------------------|-------------------------------------|
| NAME | Input signal name |
| MEMORY NO. | Location address of registered data |
| INPUT | Connected input terminal |
| fH | Horizontal frequency |
| fV | Vertical frequency |
| SYNC.STATE | Polarity synchronisation |

Renaming a registered data

You can rename the automatically determined registered signal data.

1. Display the **REGISTERED SIGNAL LIST** and select the required signal data.
2. Press the **ENTER** button.
 - Displays the **REGISTERED SIGNAL STATUS** of the signal.
3. Press the **ENTER** button.
 - Displays the character list.
4. Select the required character by pressing **▲ ▼ ◀ ▶** and press the **ENTER** button.
 - Repeat until complete the name.
 - You can enter the characters up to 16.
5. Select **OK** and press the **ENTER** button.
 - Displays the **REGISTERED SIGNAL STATUS** with **NAME** renamed.
 - Select **CANCEL** and press the **ENTER** button to return to the **REGISTERED SIGNAL STATUS** without any change.

Deleting a registered data

You can delete a registered data from the **REGISTERED SIGNAL LIST**.

1. Display the **REGISTERED SIGNAL LIST** and select the required signal data.
2. Press the **DEFAULT** button.
 - Displays the **REGISTERED SIGNAL STATUS** of the signal for confirmation to delete.
3. Press the **ENTER** button.
 - Displays **REGISTERED SIGNAL LIST** and confirm the data is deleted.
 - Press the **MENU** button to cancel and return to the **REGISTERED SIGNAL LIST** without any change.

SIGNAL LIST

Managing the sub memory list

You can restore the sub memory data when using signals from the same input source. Sub memory data contains the setting information of screen and image adjustments, such as **BRIGHTNESS**, **CONTRAST** or **ASPECT**.

Registering the current settings to the list

1. Press ◀ or ▶ while the menu is cleared from the screen after adjustment.
 - The signal must be registered before creating a sub memory data of the signal.
 - Displays the list of corresponding sub memory data to the signal.
 - If the creating data is the first sub memory data of the signal, the status of the signal will be displayed to confirm.
2. Select an empty data slot to register and press the **ENTER** button.
 - Displays the **REGISTERED SIGNAL STATUS** and change the name if necessary.
 - You can return to the previous step by pressing the **MENU** button.
3. Select **OK** and press the **ENTER** button.
 - Displays sub memory status and return to the projection.
 - **MEMORY NO.** indicates as follows.

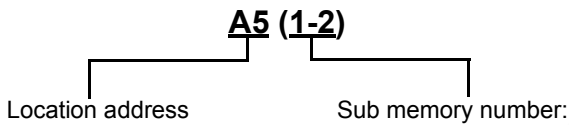

NOTE:

- The memories are numbered over 12 pages (A to L: 8 data items can be registered on each page), and the data is registered in the unused memory with the lowest number. If all the memories are used, the data of the old signals is overwritten in sequence.

Displaying the sub memory list and restoring the settings

1. Press ◀ or ▶ while the menu is cleared from the screen after adjustment.
 - Displays the **SUB MEMORY LIST**.
2. Select the required sub memory data and press the **ENTER** button.
 - Displays the **REGISTERED SIGNAL STATUS**.
3. Press the **ENTER** button.
 - Restores the settings in the data.

Deleting a sub memory data

1. Press ◀ or ▶ while the menu is cleared from the screen after adjustment.
 - Displays the **SUB MEMORY LIST**.
2. Select the required sub memory data and press the **ENTER** button.
 - Displays the **REGISTERED SIGNAL STATUS**.
3. Press the **DEFAULT** button.
 - Displays the **SUB MEMORY LIST** with change.
 - You can return to the previous step by pressing the **MENU** button.

SECURITY menu

Remote control



- See "Navigating through the menu" on page 15.
- See "Main menu and Sub-menu" on page 12.

Entering the SECURITY menu

Every time when you apply to the **SECURITY** menu, you will be asked to perform the password operation. When you apply to the **SECURITY** menu before you change the password to your original, perform to input the following factory default password operation.

- Press **▲▶▼◀▶▲▶▼◀** and the **ENTER** button.

After you change the password

When you apply to the **SECURITY** menu after you change the password to your original in the **SECURITY PASSWORD CHANGE** menu, input the original password operation.

SECURITY PASSWORD

You can activate the security system and the password operation will be asked to perform when the projecting mode started. Unless you perform the correct password operation, all of the button controls will be disabled except the **POWER STANDBY** and **SHUTTER** buttons.

| | |
|-----|----------|
| OFF | Deactive |
| ON | Active |

NOTE:

- When you activated the security system, make sure to change the password to your original for safety.
- The factory default password is valid until you change the password in **SECURITY PASSWORD CHANGE** menu.

SECURITY PASSWORD CHANGE

You can change the password operation to your original.

1. Press a series of button operation up to 8 as a password by using **▲▼◀▶** and **▶**.
2. Press the **ENTER** button.
3. Press the exact same series of button operation you entered in the **NEW** password box for confirmation.
 - If a series of button operation is incorrect, you will be asked to perform again.
4. Press the **ENTER** button.

NOTE:

- The entered password operations will appear as asterisks in the box.

DISPLAY SETTING

You can set your original text, such as company name or URL information, to display regularly on the projected image while projecting.

| | |
|-------|--|
| OFF | Deactive |
| TEXT | Displays user defined text in TEXT CHANGE on the screen while projecting. |
| LOGO1 | Displays user defined image over the image. |
| LOGO2 | Displays PANASONIC logo over the image. |

TEXT CHANGE

You can enter your original text up to 22 characters for **DISPLAY SETTING**.

1. Enter your original text.
 - Use **▲▼◀▶** to specify the location of the required character.
2. Press the **ENTER** button.
 - The selected character will be displayed in the text box.
3. Repeat until finish your original text.
 - Select **<** or **>** and press the **ENTER** button to move the cursor in the text box.
 - Select **BS** and press the **ENTER** button to erase a character.
4. Select **OK** and press the **ENTER** button.
 - Select **CANCEL** or press the **MENU** button to return to the previous step.

NOTE:

- Special software is required to define the **LOGO1** image. Contact to an Authorised Service Centre.

SECURITY menu

MENU LOCK

You can lock the **MENU** button function and the password will be asked to display the menu every time.

| | |
|-----|---|
| OFF | Deactivate the MENU LOCK system. |
| ON | Activate the MENU LOCK system. |

NOTE:

- The factory default password is "AAAA".
- The factory default password is valid until you change the password in **MENU LOCK PASSWORD** menu.
- When the projector is initialised, the password will be changed to the factory default setting, "AAAA".

MENU LOCK PASSWORD

You can change the password for **MENU LOCK** system to your original.

1. Enter the original password.
 - Use ▲ ▼ ◀ ▶ to specify the location of the required character.
2. Press the **ENTER** button.
 - The selected character will be displayed in the text box.
3. Repeat until finish your original text.
 - Select < or > and press the **ENTER** button to move the cursor in the text box.
 - Select BS and press the **ENTER** button to erase a character.
4. Select **OK** and press the **ENTER** button.
 - Select **CANCEL** or press the **MENU** button to return to the previous step.

NOTE:

- Change the **MENU LOCK PASSWORD** regularly and make it uneasy to guess.

CONTROL DEVICE SETUP

CONTROL PANEL

You can disable the control panel buttons on the projector body. Press ◀ or ▶ to switch the option.

| | |
|---------|--|
| ENABLE | Enable the control panel buttons. |
| DISABLE | Disable the control panel buttons. The confirmation screen will be displayed. Select OK by pressing the ◀, and the ENTER button. |

REMOTE CONTROLLER

You can disable the remote control buttons. Press ◀ or ▶ to switch the option.

| | |
|---------|---|
| ENABLE | Enable the remote control buttons. |
| DISABLE | Disable the remote control buttons. The confirmation screen will be displayed. Select OK by pressing the ◀, and the ENTER button. |

NOTE:

- If you disable both of the control panel and remote control buttons, you cannot return to the standby mode. Use this function with utmost care.
- If you press a disabled button, you will be asked to perform the security password operation. The password screen will disappear after 10 seconds without any operation.

NETWORK menu

Remote control



- See "Navigating through the menu" on page 15.
- See "Main menu and Sub-menu" on page 12.

NETWORK SETUP

Make the initial network settings before using the network connection.

1. Select the required item to change.
2. Press the **ENTER** button.
3. Use **▲ ▼ ◀ ▶** to change the settings.
4. Select **STORE** and press the **ENTER** button.
 - The confirmation screen will be displayed. Select **OK** and press the **ENTER** button.

| | |
|------------------------|--|
| HOST NAME | Change as needed when using a DHCP server. |
| DHCP | <ul style="list-style-type: none"> • ON: When using DHCP server, automatically acquire an IP ADDRESS. • OFF: IP ADDRESS need to be entered manually. |
| IP ADDRESS | Enter correct IP ADDRESS numbers. When DHCP is ON , automatically filled. |
| SUBNET MASK | Enter correct SUBNET MASK numbers. When DHCP is ON , unnecessary to fill. |
| DEFAULT GATEWAY | Enter correct DEFAULT GATEWAY numbers. When DHCP is ON , unnecessary to fill. |
| STORE | Save the above settings. |

NOTE:

- Make sure the DHCP server is ready to use.
- For details of **IP ADDRESS**, **SUBNET MASK** and **DEFAULT GATEWAY**, ask the network administrator.

NETWORK CONTROL

You can switch on/off the projector network controlling method.

1. Select the required item to change.
2. Press the **ENTER** button.
3. Use **◀ ▶** to change the settings.
4. Select **STORE** and press the **ENTER** button.
 - The confirmation screen will be displayed. Select **OK** and press the **ENTER** button.

| | |
|---------------------------|--|
| WEB CONTROL | For when controlling from a computer with the web browser. |
| PJLink CONTROL | For when controlling from a computer with the PJLink™ protocol. |
| COMMAND CONTROL *1 | For when controlling from a computer via SERIAL terminal. |
| COMMAND PORT | Enter the command port number for COMMAND CONTROL . |
| STORE | Save the above settings. |

*1. If settings have been made without an administrator password of the web browser control, add 2-byte "00" instead of STX, and a line-feed code (0Dh) instead of ETX.

If settings have been made with an administrator password, of the web browser control, add a 32-byte hash value and "00" instead of STX and a line-feed code (0Dh) instead of ETX.

The hash value is created by MD5 combining "admin1:", password, ":" and random numbers. The random numbers are 8-byte values sent from the projector when connecting.

NETWORK STATUS

You can display the current network status of the projector. Press the **ENTER** button to display.

- **DHCP**
- **IP ADDRESS**
- **SUBNET MASK**
- **DEFAULT GATEWAY**
- **DNS1**
- **DNS2**
- **MAC ADDRESS**

Technical Information

Network connection

You can control the projector from a computer with web browser, for adjusting the menu settings, displaying status of the projector and transmission of E-mail messages if there is a problem with the projector.

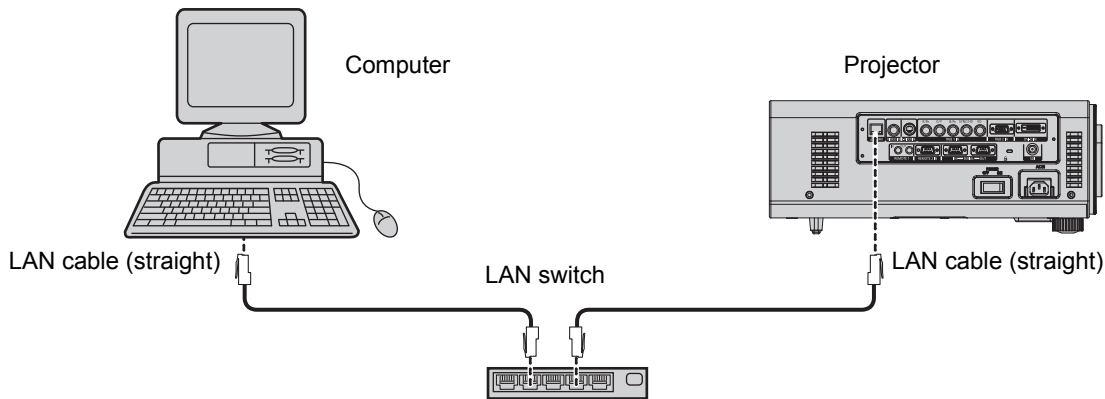

NOTE:

- A LAN cable is required to use the network function. A cross cable is required when connecting directly to a computer. Straight cables are used when connecting through a switch or router.
- A web browser is required to use this function. Make sure that a web browser is available in the system.
- Use Microsoft Windows 98SE/Me/NT4.0/2000/XP/Vista for the OS of your personal computer.
- The Web browser should be Internet Explorer 6.0 or newer.
- To use the E-mail function, communication with E-mail server must be established. Make sure that E-mail feature is available in your system.
- Use a straight insulated LAN cable which supports category 5 or above.
- The length of LAN cable must be 100 m or shorter.

LAN terminal

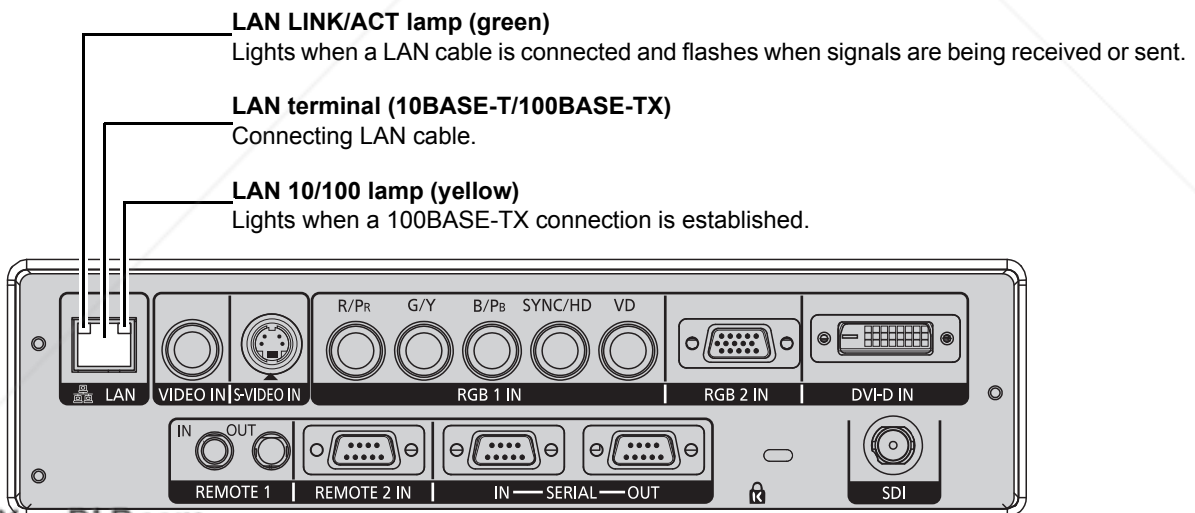

NOTE:

- If the LAN terminal is touched by electrostatically charged hands or body, failure may be caused by the discharge of static electricity. Be careful not to touch metallic part of LAN terminal or LAN cable.
- Connect indoor equipment to the LAN.

Accessing with the web browser

Projector Control Window

1. Activate the web browser of the computer.
2. Enter the **IP ADDRESS** set by the projector into the URL input field of the web browser.
 - See "NETWORK STATUS" on page 37.
3. Enter your user name and password.
 - The factory default settings are "user1" (user privileges) or "admin1" (administrator privileges) for the user name and panasonic (lowercase) for the password.



4. Click **OK** and display the **Projector Control Window**.
5. Click the required item button on the left.

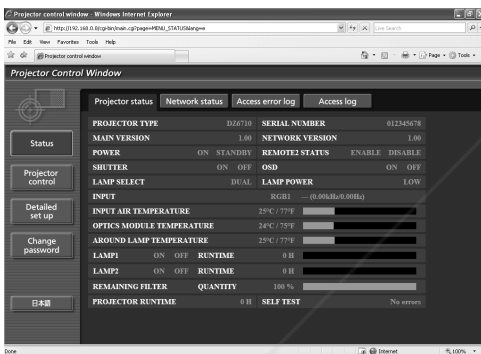

NOTE:

- Avoid activating two or more web browser simultaneously to work out setting or control actions.
- Change the password first of all.
- Administrator privileges enable the use of all functions. User privileges enable the use of only **Projector status**, **Error information**, **Network status**, **Basic control**, and **Change password**.
- If the password is incorrectly entered three times in a row, the lock is set for several minutes.

Change password

Administrator mode

1. Select **Administrator** to change and click **NEXT**.

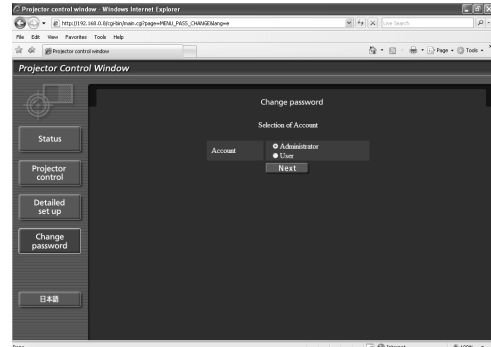

2. Enter **User name** and **Password**.

Administrator account

Current setting

| | |
|------------------|---|
| User name | Enter the current user name. |
| Password | Enter the current password for the user name. |

New setting

| | |
|------------------------|-------------------------------|
| User name | Enter new user name. |
| Password | Enter new password. |
| Password(Retyp) | Enter the new password again. |

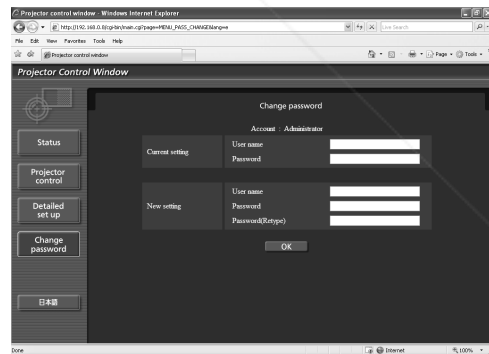

Technical Information

| User account | |
|------------------|-------------------------------|
| New setting | |
| User name | Enter new user name. |
| Password | Enter new password. |
| Password(Retype) | Enter the new password again. |

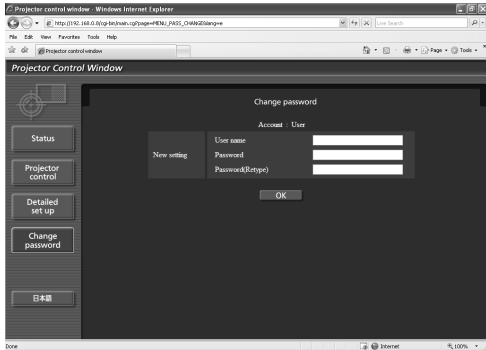

3. Click **OK**.

User mode

A user can change password only. Enter your old password and new password, then click **OK**.

| User account | |
|--------------|-------------------------------|
| New setting | |
| User name | Enter new user name. |
| Password | Enter new password. |
| Retype | Enter the new password again. |

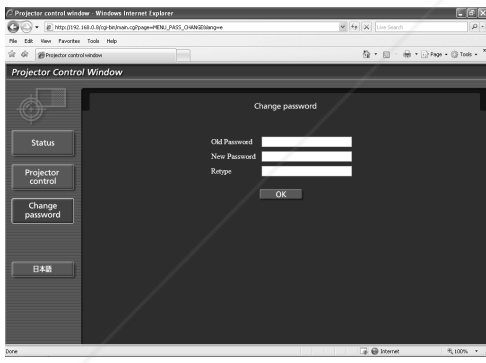

Projector Control

Basic control

Click the **Basic control** tab on the top.

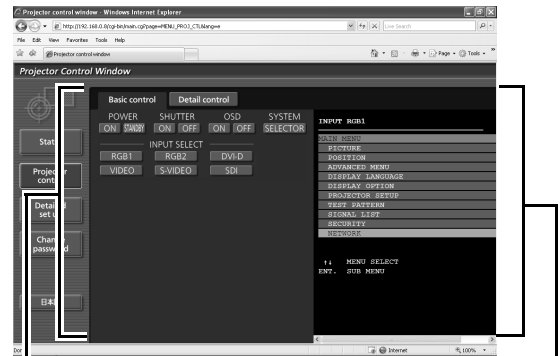

Indicates projecting status. Even when the screen is cleared by pressing the **ON SCREEN** button of the remote control, the information will be displayed.

Adjustable items

- **POWER** Switches projector **ON** or **STANDBY**.
- **SHUTTER** Temporary halt the projection.
- **OSD** Turn on/off the on screen display.
- **SYSTEM** Changes colour system.
- **INPUT SELECT** Changes terminal of input signal.

Detail control

Click the **Detail control** tab on the top. You can control the projector as same as controlling the remote control.

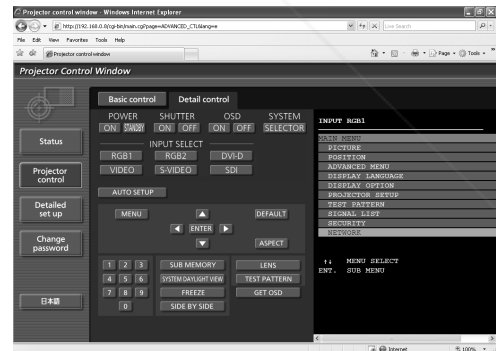

| Web browser buttons | Remote control buttons*1 |
|---|---|
| POWER: ON/STANDBY | POWER ON and STANDBY |
| SHUTTER: ON/OFF | SHUTTER |
| OSD: ON/OFF | ON SCREEN |
| INPUT SELECT: RGB1/RGB2/ DVI-D/VIDEO/S-VIDEO/SDI | RGB1/RGB2/DVI-D/VIDEO/ S-VIDEO/SDI |
| AUTO SETUP | AUTO SETUP |
| MENU | MENU |
| ▲ ▼ ◀ ▶ ENTER | ▲ ▼ ◀ ▶ ENTER |
| DEFAULT | DEFAULT |
| ASPECT | ASPECT See "ASPECT" on page 18. |
| Numeric buttons | Numeric buttons |
| LENS | FOCUS/ZOOM/SHIFT |
| TEST PATTERN | TEST PATTERN See "TEST PATTERN" on page 32. |

| Web browser buttons | Remote control buttons*1 |
|--|--|
| SUB MEMORY/SYSTEM DAYLIGHT VIEW/FREEZE/ SIDE BY SIDE | FUNCTION (Assignable functions in the menu) See "FUNCTION BUTTON" on page 30. |

*1. See the operation instruction booklet that is provided with the projector.

Detailed set up

Network config

Click the **Network config** tag on the top. When all options are filled, click **NEXT**. The confirmation screen will be displayed.

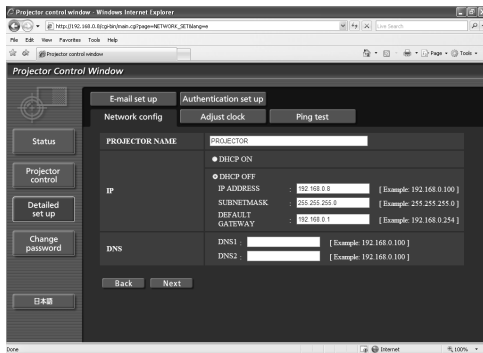

Adjust clock

Click the **Adjust clock** tag on the top.

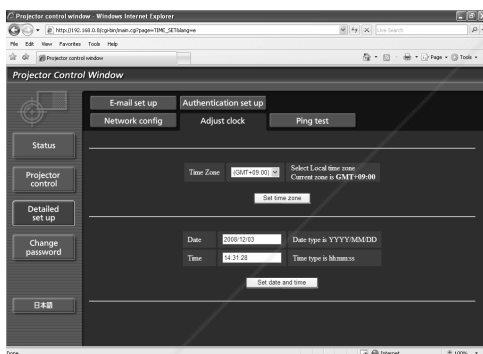

| Items | Description |
|-----------|---|
| Time Zone | Select the located time zone, then click Set time zone . |
| Date | Enter the current date by YYYY/MM/DD , then click Set date and time . |
| Time | Enter the current time by hh:mm:ss , then click Set date and time . |

Ping test

Click the **Ping test** tag on the top.

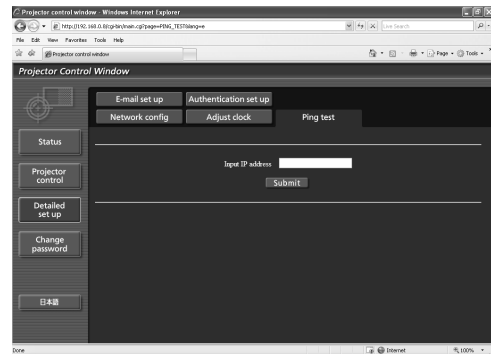

| Items | Description |
|------------------|---|
| Input IP address | Enter the required IP address, such as E-mail server, POP server or DNS server, then click Submit to check whether the connection is functioned. |
| Connect success | <pre>PING 188.245.80.10 (188.245.80.10): 56 data bytes 64 bytes from 188.245.80.10: icmp_seq=0 ttl=255 time=0.7 ms 64 bytes from 188.245.80.10: icmp_seq=1 ttl=255 time=0.4 ms 64 bytes from 188.245.80.10: icmp_seq=2 ttl=255 time=0.4 ms 64 bytes from 188.245.80.10: icmp_seq=3 ttl=255 time=0.4 ms --- 188.245.80.10 ping statistics --- 4 packets transmitted, 4 packets received, 0% packet loss round-trip min/avg/max = 0.4/0.4/0.7 ms</pre> |
| Connect failure | <pre>PING 188.245.80.100 (188.245.80.100): 56 data bytes --- 188.245.80.100 ping statistics --- 4 packets transmitted, 0 packets received, 100% packet loss</pre> |

Authentication set up

Click the **Authentication set up** tag on the top. When all options are filled, click **Submit**.

| Items | Description |
|------------------|--|
| Auth | Select the authentication method specified by your internet service provider. |
| SMTP Auth | Select the required option for when SMTP Auth is selected in Auth . |
| Pop server name | Enter the POP server name. Available input characters: Alphanumeric characters (A - Z, a - z, 0 - 9), hyphen (-), period (.) |
| User name | Enter POP server user name. |
| Password | Enter POP server password. |
| SMTP server port | Enter the port number for the SMTP server. (normally "25") |
| POP server port | Enter the port number for the POP server. (normally "10") |

Technical Information

E-mail set up

Click the **E-mail set up** tag on the top. When all options are filled, click **Submit**.

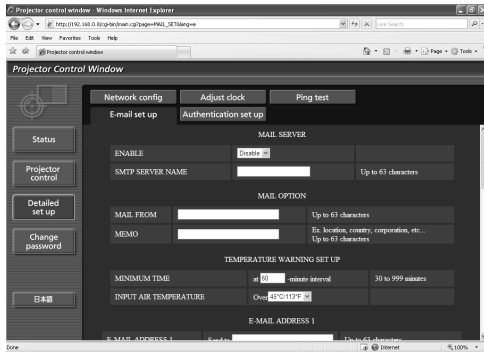

| Items | Description |
|-----------------------------------|---|
| MAIL SERVER | |
| ENABLE | Select Enable to use the E-mail function. |
| SMTP SERVER NAME | Enter the IP address or server name of the E-mail server (SMTP). The DNS server must be set if the server name is entered. |
| MAIL OPTION | |
| MAIL FROM | Enter the E-mail address of the projector control. (maximum 63 characters) |
| MEMO | Enter the information to identify the projector, such as location. (maximum 63 characters) |
| TEMPERATURE WARNING SET UP | |
| MINIMUM TIME | Modify the minimum time interval of temperature warning mail. The projector will not send another mail for 60 minutes even the temperature of the projector is reached over the INPUT AIR TEMPERATURE setting. |
| INPUT AIR TEMPERATURE | Modify the threshold temperature for sending temperature warning value, control sends temperature warning mail. |

| Items | Description |
|---|--|
| E-MAIL ADDRESS 1/E-MAIL ADDRESS 2 | |
| E-MAIL ADDRESS 1/ E-MAIL ADDRESS 2 | Register the recipient E-mail address. Available to register up to 2 E-mail address. |
| MAIL CONTENTS | Select NORMAL version or SIMPLE version of the contents. |
| ERROR | Sends E-mail when detects an error. |
| LAMP1 RUNTIME | Sends E-mail when lamp runtime of the lamp1 reaches the set time. |
| LAMP2 RUNTIME | |
| LAMP2 RUNTIME | Sends E-mail when lamp runtime of the lamp2 reaches the set time. |
| INPUT AIR TEMPERATURE | Sends E-mail when input air temperature is reached INPUT AIR TEMPERATURE in TEMPERATURE WARNING SET UP set time. |
| PERIODIC REPORT | Sends E-mail on checked times of the checked days. |

E-mail report sample

```

==== Panasonic projector report(CONFIGURE) ====
Projector Type      :DZ6710
Serial No          :012345678

---- E-mail setup data ----
TEMPERATURE WARNING SETUP
MINIMUM TIME       at [ 60] minutes interval
INPUT AIR TEMPERATURE Over [ 30C / 86F ]

ERROR              [ OFF ]
LAMP1 RUNTIME      [ OFF ] at REMAIN [ 400] H
LAMP2 RUNTIME      [ OFF ] at REMAIN [ 200] H
LAMP2 RUNTIME      [ OFF ] at REMAIN [ 400] H
LAMP2 RUNTIME      [ OFF ] at REMAIN [ 200] H
FILTER REMAIN      [ OFF ] at REMAIN [ 400] H
FILTER REMAIN      [ OFF ] at REMAIN [ 200] H
INPUT AIR TEMPERATURE [ OFF ]
PERIODIC REPORT    [ OFF ]
    
```

Error report sample

```

==== Panasonic projector report(ERROR) ====
Projector Type      :DZ6710
Serial No          :012345678

---- check system ----
MAIN CPU BUS       [      OK      ]
FAN                [      OK      ]
INPUT AIR TEMPERATURE [ FAILED ]
OPTICS MODULE TEMPERATURE [      OK      ]
AROUND LAMP TEMPERATURE [      OK      ]
LAMP1 REMAIN TIME  [      OK      ]
LAMP2 REMAIN TIME  [      OK      ]
LAMP1 STATUS       [      OK      ]
LAMP2 STATUS       [      OK      ]
SHUTTER           [      OK      ]
INPUT AIR TEMPSENSOR [      OK      ]
OPTICS MODULE TEMPSENSOR [      OK      ]
AROUND LAMP
    
```

STATUS

Projector status

Click the **Projector status** tab on the top.

| | |
|------------------------------------|---|
| PROJECTOR TYPE | Displays the type of projector. |
| MAIN VERSION | Displays the firmware version of the projector main unit. |
| INPUT | Displays the input switching status. |
| INPUT AIR TEMPERATURE | Displays temperature of projector's intake air. |
| OPTICS MODULE TEMPERATURE | Displays temperature inside the projector. |
| AROUND LAMP TEMPERATURE | Displays temperature around lamp units. |
| LAMP1 RUNTIME/LAMP2 RUNTIME | Displays the lamp lit hours. |
| PROJECTOR RUNTIME | Displays used hours of the projector. |
| SELF TEST | Displays self diagnosis information. |

Error information

When **Error (Detail)** is displayed in **SELF TEST** in the status list, click **(Detail)** to display the error details.

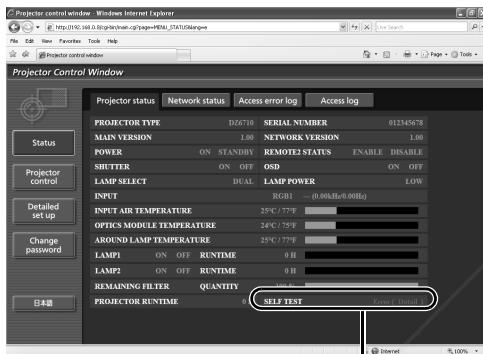

Click **(Detail)**

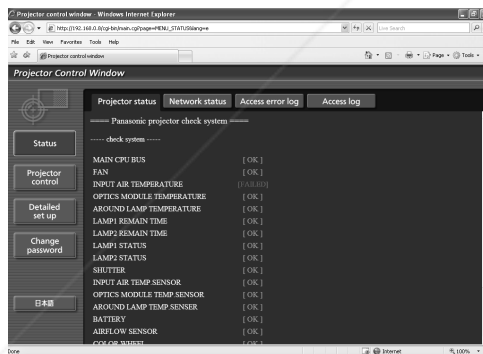

| Parameter | Description |
|----------------------------------|--|
| MAIN CPU BUS | Trouble has occurred in the microcomputer circuitry. Consult your dealer. |
| FAN | Trouble has occurred in the fan or its drive circuit. Consult your dealer. |
| INPUT AIR TEMPERATURE | The input air temperature is too high. It may be that the projector is being used in an operating environment where the temperature is high such as near a heating appliance. |
| OPTICS MODULE TEMPERATURE | The temperature inside the projector is high. It may be that the projector is being used in an operating environment where the temperature is high such as near a heating appliance. |
| AROUND LAMP TEMPERATURE | The temperature around the lamp is too high. It may be that the projector's ventilation holes are blocked. |
| LAMP1 REMAIN TIME | The lamp runtime has exceeded the prescribed cumulative time, and it is now time to replace the lamp. |
| LAMP2 REMAIN TIME | The lamp runtime has exceeded the prescribed cumulative time, and it is now time to replace the lamp. |
| LAMP1 STATUS | The lamp has failed to light. Wait a short while for the lamp to cool off, and then turn on the power. |
| LAMP2 STATUS | The lamp has failed to light. Wait a short while for the lamp to cool off, and then turn on the power. |
| SHUTTER | Trouble has occurred in the shutter circuitry. Consult your dealer. |
| INPUT AIR TEMP.SENSOR | Trouble has occurred in the sensor used to detect the input air temperature. Consult your dealer. |
| OPTICS MODULE TEMP.SENSOR | Trouble has occurred in the temperature detection sensor inside the projector. Consult your dealer. |
| AROUND LAMP TEMP.SENSOR | Trouble has occurred in the sensor used to detect the exhaust air temperature. Consult your dealer. |
| BATTERY | The backup battery has been run out. Consult your dealer. |
| AIRFLOW SENSOR | Trouble has occurred in the sensor used to detect the airflow volume. Consult your dealer. |
| COLOR WHEEL | Trouble has occurred in the colour wheel or colour wheel or its drive circuit. Consult your dealer. |
| COVER OPEN | The lamp unit cover is not attached securely. Check the lamp unit compartment. |
| ACF UNIT | The air cleaning filter (ACF) is not installed or trouble has occurred. See the operating instructions booklet that is provided with the projector. |
| FILTER REMAIN | The filter remaining is getting less. See the operating instructions booklet that is provided with the projector. |

Technical Information

PJLink™ protocol

The network function of the projector supports PJLink™ class 1, and the PJLink™ protocol can be used to perform projector setting and projector status query operations from a computer.

Control commands

| Command | Control details | Parameters/Notes |
|---------------|----------------------------|--|
| POWR | Power supply control | 0 = Standby 1 = Power ON |
| POWR ? | Power supply status query | 0 = Standby 1 = Power ON 2 = Cool-down in progress 2 = Warm-up in progress |
| INPT | Input selection | 11 = RGB1 12 = RGB2 21 = VIDEO 22 = S-VIDEO |
| INPT ? | Input selection query | 31 = DVI-D 32 = SDI (PT-DZ6710 only) |
| AVMT | Shutter control | 30 = Shutter mode off (picture mute cancelled) |
| AVMT ? | Shutter mode query | 31 = Shutter mode on (picture mute) |
| ERST ? | Error status query | 1st byte: Indicates fan errors, range 0 - 2. 2nd byte: Indicates lamp errors, range 0 - 2. 3rd byte: Indicates temperature errors, range 0 - 2. 4th byte: Indicates cover open errors, range 0 - 2. 5th byte: Indicates filter errors, range 0 - 2. 6th byte: Indicates other errors, range 0 - 2. Definitions for each value from 0 - 2 are as follows. 0 = No error known 2 = Error 1 = Warning |
| LAMP ? | Lamp status query | 1st digits (1 - 5 digits): Lamp 1 cumulative operating time 2nd digit: 0 = Lamp 1 off, 1 = Lamp 1 on 3rd digits (1 - 5 digits): Lamp 2 cumulative operating time 4th digit: 0 = Lamp 2 off, 1 = Lamp 2 on |
| INST ? | Input selection list query | The following are returned as parameters. "11 12 21 22 31" for PT-DZ6700, PT-DW6300, PT-D6000 and PT-D5000 "11 12 21 22 31 32" for PT-DZ6710 |
| NAME ? | Projector name query | The name set for PROJECTOR NAME in NETWORK menu. |
| INF1 ? | Manufacturer name query | "Panasonic" is returned. |
| INF2 ? | Model name query | "DZ6710, DZ6700, DW6300, D6000 or D5000 is returned. |
| INF0 ? | Other information query | Information such as version number is returned. |
| CLSS ? | Class information. | "1" is returned |

PJLink™ security authorization

When using PJLink™ with security authorization, either of the password set for administrator privileges and the password set for user privileges with web browser control can be used as the password for PJLink™. When using PJLink™ without security authorization, set use without the password for administrator privileges and the password for user privileges of web browser control.

PJLink™ is a pending trademark in Japan, the United States, and other countries and regions. For specifications regarding PJLink™, refer to the Japan Business Machine and Information System Industries Association website.

URL: <http://pjlink.jbmia.or.jp/>

FixYourDLP.com
 Sponsored by 



Discount-Merchant.com (800) 281-8860
THE TRUSTED SOURCE FOR PROJECTOR LAMPS AND ACCESSORIES

Serial terminal

The serial connector which is on the connector panel of the projector conforms to the RS-232C interface specification, so that the projector can be controlled by a personal computer which is connected to this connector.

Connection

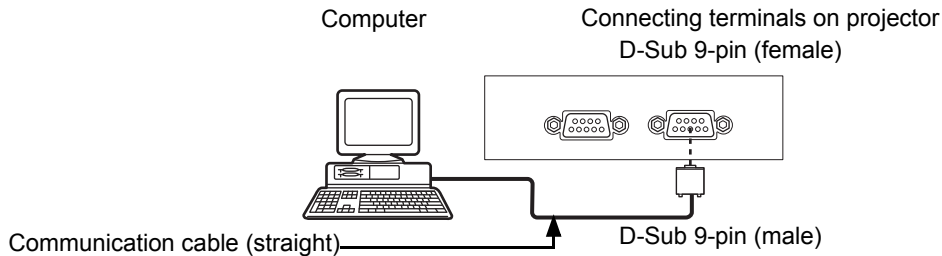
● Single projector



● Multiple projectors

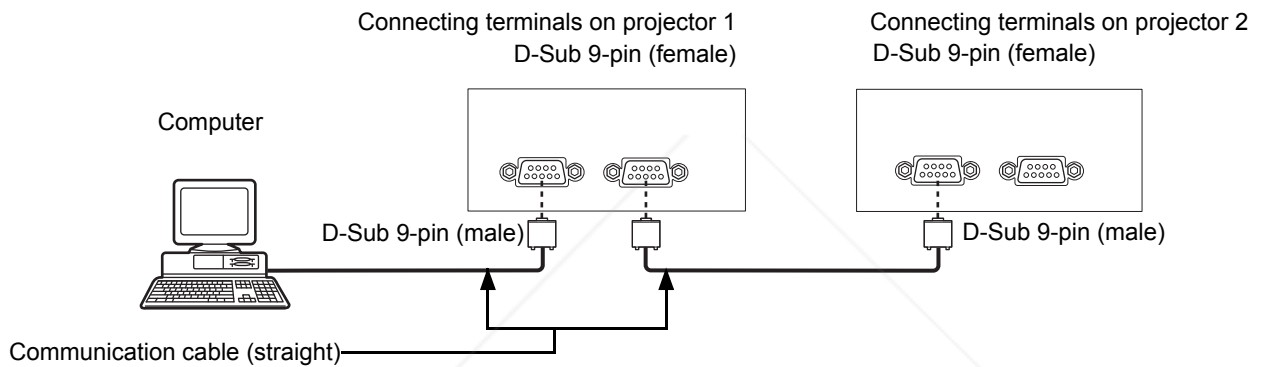

Pin assignments and signal names

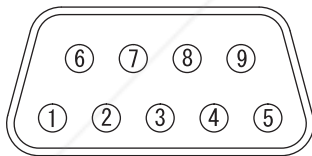

| Pin No. | Female | | Male | |
|---------|-------------|----------------------|-------------|----------------------|
| | Signal name | Contents | Signal name | Contents |
| 1 | | NC | | NC |
| 2 | TXD | Transmitted data | RXD | Received data |
| 3 | RXD | Received data | TXD | Transmitted data |
| 4 | | Connected internally | | Connected internally |
| 5 | GND | Earth | GND | Earth |
| 6 | | NC | | NC |
| 7 | CTS | Connected internally | RTS | Connected internally |
| 8 | RTS | | CTS | |
| 9 | | NC | | NC |

Communication settings

See "RS-232C" on page 29.

| | | | |
|--------------|--------------|------------------|--------|
| Signal level | RS-232C | Character length | 8 bits |
| Sync. method | Asynchronous | Stop bit | 1 bit |
| Baud rate | 9 600 bps | X parameter | None |
| Parity | None | S parameter | None |

Technical Information

Basic format

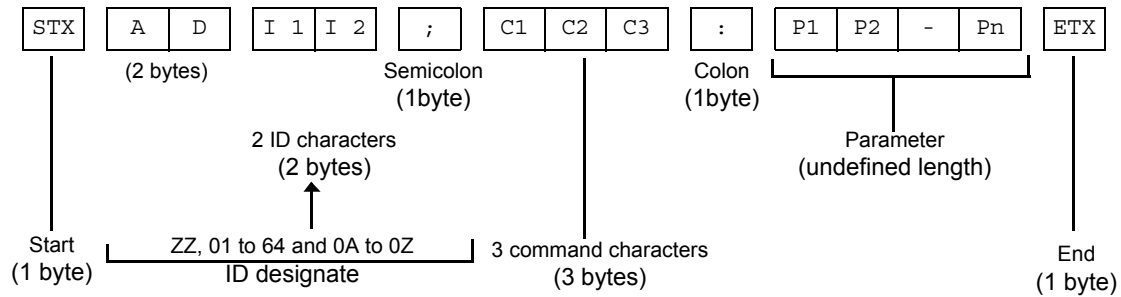

NOTE:

- No command can be sent or received for 10 to 60 seconds after the lamp starts lighting. Try sending any command after that period has elapsed.
- When transmitting multiple commands, be sure to wait until 0.5 seconds has elapsed after receiving the response from the projector before sending the next command. When sending commands without parameters, a colon (:) is not necessary.
- When the wrong command is sent, the "ER401" or "ER402" status is sent from the projector to the personal computer.
- Projector ID supported on the RS-232C interface is ZZ (ALL) and a group of 01 to 64 and 0A to 0Z.
- The "STX" character code is 02 and the "ETX" character code is 03.
- If a command is sent with a projector ID specified, the projector will return answer back only in the following cases:
 If it coincides with the projector ID
 If the ID specification is ALL and responding (ID ALL) is on
 If the ID specification is Group and responding (ID Group) is on

Cable specifications

(When connected to a computer)

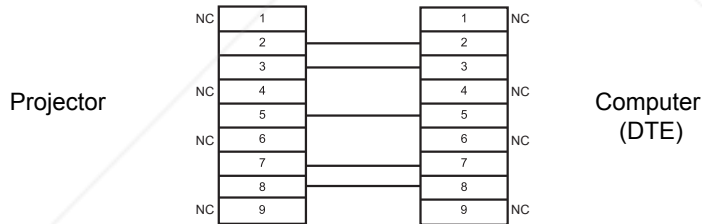

Control commands

| Command | Control contents | Parameter/Remarks |
|---------|----------------------------|---|
| PON | Power ON | In standby mode, all commands other than the PON command are ignored. ● The PON command is ignored during lamp ON control. |
| POF | Power OFF | |
| QPW | Power query | 000 = Standby 001 = Power ON |
| IIS | Switch input modes | VID = VIDEO RG1 = RGB1 DVI = DVI SVD = S-VIDEO RG2 = RGB2 SDI = SDI (PT-DZ6710 only) |
| QSL | Query for active lamp mode | 0 = DUAL 2 = Only LAMP 1 is on ● SINGLE will use the lamp (LAMP 1 or LAMP 2) with shorter operating hours. 1 = SINGLE 3 = Only LAMP 2 is on |
| LPM | Active lamp mode | 0 = DUAL 2 = Only LAMP 1 is on 1 = SINGLE 3 = Only LAMP 2 is on |
| OLP* | Lamp power setting | 0 = HIGH 1 = LOW |

* Not available for PT-D5000.

REMOTE 2 IN terminal

Using the **REMOTE 2 IN** terminal provided on the connection terminals of the main unit, it is possible to operate the projector from a control panel etc. furnished in a distant location where infrared remote control signal cannot be received.

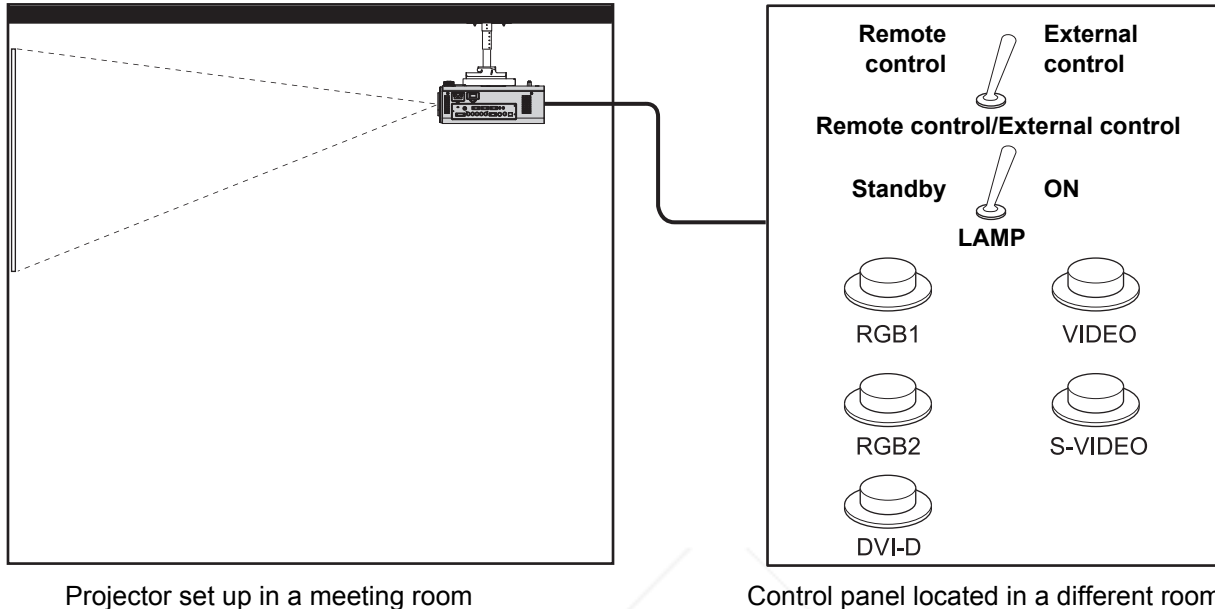

Projector set up in a meeting room

Control panel located in a different room

Pin assignments and control

| Pin No. | Signal name | Open (H) | Short (L) |
|---------|-------------|------------------------------|--------------------------------|
| 1 | GND | | GND |
| 2 | POWER | OFF | ON |
| 3 | RGB1 | Other | RGB1 |
| 4 | RGB2 | Other | RGB2 |
| 5 | VIDEO | Other | VIDEO |
| 6 | S-VIDEO | Other | S-VIDEO |
| 7 | DVI-D | Other | DVI-D |
| 8 | SHUTTER | OFF | ON |
| 9 | RST / SET | Controlled by remote control | Controlled by external contact |

NOTE:

- The following buttons on the remote control and the operation area of the projector can no longer be operated when pins 1 and 9 are shortened: **POWER** button and **SHUTTER** button. Neither will it be possible to use the RS-232C commands or network functions corresponding to these functions.
- If you short pin 1 and pin 9, and also short one of the pins from 3 to 7 and pin 1, then the following buttons on the projector operating area and the remote control can no longer be operated: **POWER**, **RGB1**, **RGB2**, **DVI-D**, **VIDEO**, **S-VIDEO**, **SDI** and **SHUTTER** buttons. Neither will it be possible to use the RS-232C commands or network functions corresponding to these functions.

SIDE BY SIDE function signal combination table

(PT-DZ6710/PT-DZ6700/PT-DW6300 only)

● Side by Side function signal combination table

| Main image | | RGB1 | | RGB2 | | VIDEO | S-VIDEO | DVI-D | | SDI*1 |
|------------|-------|-------|-------|-------|-------|-------|---------|-------|-------|-------|
| | | Still | Movie | Still | Movie | | | Still | Movie | |
| Sub image | | Still | Movie | Still | Movie | VIDEO | S-VIDEO | Still | Movie | SDI*1 |
| RGB1 | Still | N/A | N/A | OK | OK | OK | OK | OK | OK | OK |
| | Movie | N/A | N/A | OK | N/A | N/A | N/A | OK | N/A | N/A |
| RGB2 | Still | OK | OK | N/A | N/A | OK | OK | OK | OK | OK |
| | Movie | OK | N/A | N/A | N/A | N/A | N/A | OK | N/A | N/A |
| VIDEO | | OK | N/A | OK | N/A | N/A | N/A | OK | N/A | N/A |
| S-VIDEO | | OK | N/A | OK | N/A | N/A | N/A | OK | N/A | N/A |
| DVI-D | Still | OK | OK | OK | OK | OK | OK | N/A | N/A | N/A |
| | Movie | OK | N/A | OK | N/A | N/A | N/A | N/A | N/A | N/A |
| SDI*1 | | OK | N/A | OK | N/A | N/A | N/A | N/A | N/A | N/A |

*1. PT-DZ6710 only.

● Movie signals

525i, 625i, 525p, 625p, 1 080/60i, 1 080/50i, 1 080/60p, 1 080/50p, 720/60p, 720/60p, NTSC, PAL and SECAM.

Restoring the MENU LOCK PASSWORD to default

1. Press the **MENU** button to display the password asking screen.
2. Press the **AUTO SETUP** button for more than 2 seconds.
3. **▼** for more than 2 seconds.
4. Press the **MENU** to display the password asking screen.
5. Enter the factory default password, "AAAA", by pressing **▲ ▼ ◀ ▶**.
6. Select **OK** and press the **ENTER** button.

Trademark acknowledgements

- Microsoft and Microsoft logos, Windows, Windows® XP, and Windows Vista® are the registered trademarks or trademarks of Microsoft Corporation in the United States and/or other countries.
- Other types of names such as company names and product names appearing in this instruction manual are trademarks or registered trademarks of their respective holders. The ® and TM marks are not indicated in this instruction manual.



Discount-Merchant.com (800) 281-8860
THE TRUSTED SOURCE FOR PROJECTOR LAMPS AND ACCESSORIES

Index

| | | | |
|------------------------------|----|--------------------------------|----|
| A | | L | |
| ADVANCED MENU | 22 | LAMP POWER | 29 |
| AI | 17 | LAMP RELAY | 29 |
| ASPECT | 18 | LAMP SELECT | 29 |
| AUTO SETUP | 26 | LOAD ALL USERS DATA | 31 |
| AUTO SIGNAL | 25 | | |
| B | | M | |
| BACK COLOR | 27 | Menu | |
| BLANKING | 22 | Navigation | 15 |
| BRIGHTNESS | 16 | Structure | 12 |
| C | | MENU LOCK | 36 |
| CLAMP POSITION | 22 | MENU LOCK PASSWORD | 36 |
| CLOCK PHASE | 19 | | |
| COLOR | 16 | N | |
| COLOR CORRECTION | 25 | NETWORK | 37 |
| COLOR MATCHING | 25 | Network | |
| COLOR TEMPERATURE | 16 | Connection | 38 |
| Connection | | Detailed set up | 41 |
| AV equipment | 11 | LAN terminal | 38 |
| Computers | 11 | Projector Control | 40 |
| Network | 38 | NETWORK CONTROL | 37 |
| Serial | 45 | NETWORK SETUP | 37 |
| CONTRAST | 16 | NETWORK STATUS | 37 |
| CONTRAST MODE | 25 | NO SIGNAL SHUT-OFF | 30 |
| CONTROL DEVICE SETUP | 36 | NOISE REDUCTION | 17 |
| CONTROL PANEL | 36 | | |
| COOLING CONDITION | 28 | O | |
| D | | ON-SCREEN DISPLAY | 26 |
| DATE | 31 | OSD DESIGN | 26 |
| DIGITAL CINEMA REALITY | 22 | OSD MEMORY | 26 |
| DISPLAY LANGUAGE | 12 | OSD POSITION | 26 |
| DISPLAY OPTION | 25 | | |
| DISPLAY SETTING | 35 | P | |
| DVI EDID | 26 | PICTURE | 16 |
| DVI SIGNAL LEVEL | 26 | PICTURE MODE | 16 |
| DVI-D IN | 26 | Pin assignments | |
| E | | DVI-D | 10 |
| EDGE BLENDING | 23 | REMOTE2 | 47 |
| F | | RGB2 | 10 |
| FILTER COUNTER RESET | 30 | S-VIDEO | 10 |
| FREEZE | 27 | PJLink | |
| Front leg adjusters | 9 | Control commands | 44 |
| FUNCTION BUTTON | 30 | Security authorization | 44 |
| G | | POSITION | 18 |
| GEOMETRY | 19 | Projector Control Window | 39 |
| CURVED | 20 | PROJECTOR ID | 28 |
| Geometric adjustment | 8 | PROJECTOR SETUP | 28 |
| KEYSTONE | 20 | | |
| H | | R | |
| HIGH ALTITUDE MODE | 28 | RASTER POSITION | 24 |
| I | | REMOTE 2 IN terminal | 47 |
| INITIALIZE | 31 | REMOTE CONTROLLER | 36 |
| INPUT GUIDE | 26 | REMOTE2 MODE | 29 |
| INPUT RESOLUTION | 22 | RS-232C | 29 |
| INSTALLATION | 28 | | |
| K | | S | |
| KEYSTONE | 21 | SAVE ALL USERS DATA | 31 |
| | | SCREEN FORMAT | 25 |
| | | SCREEN POSITION | 25 |
| | | SCREEN SETTING | 25 |
| | | Screen size | 3 |
| | | SDI IN | 26 |
| | | SECURITY | 35 |
| | | SECURITY PASSWORD | 35 |
| | | SECURITY PASSWORD CHANGE | 35 |

| | |
|------------------------------|--------|
| Serial | |
| Basic format | 46 |
| Cable specifications | 46 |
| Communication settings | 45 |
| Control commands | 46 |
| Pin assignments | 45 |
| Serial terminal | 45 |
| SERVICE PASSWORD | 31 |
| SHARPNESS | 17 |
| SHIFT | 18 |
| SIDE BY SIDE | 27 |
| Combination table | 48 |
| SIGNAL LIST | 33 |
| STANDBY MODE | 29 |
| STARTUP LOGO | 27 |
| STATUS | 30, 43 |
| SUB MEMORY LIST | 33 |
| SYSTEM DAYLIGHT VIEW | 17 |
| SYSTEM SELECTOR | 17 |
| T | |
| TEST PATTERN | 32 |
| TEXT CHANGE | 35 |
| Throw distance | 3 |
| Throwing angle | 9 |
| TIME | 31 |
| TINT | 16 |
| W | |
| WARNING MESSAGE | 26 |
| WHITE GAIN | 17 |
| Z | |
| ZOOM | 19 |



Discount-Merchant.com (800) 281-8860
THE TRUSTED SOURCE FOR PROJECTOR LAMPS AND ACCESSORIES



Discount-Merchant.com (800) 281-8860
THE TRUSTED SOURCE FOR PROJECTOR LAMPS AND ACCESSORIES

Panasonic Corporation

Web Site : <http://panasonic.net/avc/projector/>
© Panasonic Corporation 2009

Printed in Japan
P0209-5069F



Disclaimer

This user manual is provided as a free service by FixYourDLP.com. FixYourDLP is in no way responsible for the content of this manual, nor do we guarantee its accuracy. FixYourDLP does not make any claim of copyright and all copyrights remain the property of their respective owners.

About FixYourDLP.com

FixYourDLP.com (<http://www.fixyourdpl.com>) is the World's #1 resource for media product news, reviews, do-it-yourself guides, and manuals.

Informational Blog: <http://www.fixyourdpl.com>

Video Guides: <http://www.fixyourdpl.com/guides>

User Forums: <http://www.fixyourdpl.com/forum>

FixYourDLP's Fight Against Counterfeit Lamps:

<http://www.fixyourdpl.com/counterfeits>

Sponsors:

RecycleYourLamp.org – Free lamp recycling services for used lamps:

<http://www.recycleyourlamp.org>

Lamp Research - The trusted 3rd party lamp research company:

<http://www.lampresearch.com>

Discount-Merchant.com – The worlds largest lamp distributor:

<http://www.discount-merchant.com>



FixYourDLP.com

Sponsored by 