



# Disclaimer

This user manual is provided as a free service by FixYourDLP.com. FixYourDLP is in no way responsible for the content of this manual, nor do we guarantee its accuracy. FixYourDLP does not make any claim of copyright and all copyrights remain the property of their respective owners.

About FixYourDLP.com

FixYourDLP.com (<http://www.fixyourdpl.com>) is the World's #1 resource for media product news, reviews, do-it-yourself guides, and manuals.

Informational Blog: <http://www.fixyourdpl.com>

Video Guides: <http://www.fixyourdpl.com/guides>

User Forums: <http://www.fixyourdpl.com/forum>

FixYourDLP's Fight Against Counterfeit Lamps:

<http://www.fixyourdpl.com/counterfeits>

## Sponsors:

RecycleYourLamp.org – Free lamp recycling services for used lamps:

<http://www.recycleyourlamp.org>

Lamp Research - The trusted 3rd party lamp research company:

<http://www.lampresearch.com>

Discount-Merchant.com – The worlds largest lamp distributor:

<http://www.discount-merchant.com>



**FixYourDLP.com**

Sponsored by 

**BenQ**

PE7800 Digital Projector

Home Theater

User's Manual



**Discount-Merchant.com (800) 281-8860**

**THE TRUSTED SOURCE FOR PROJECTOR LAMPS AND ACCESSORIES**

**welcome**

## Copyright

Copyright © 2004 by BENQ Corporation. All rights reserved. No part of this publication may be reproduced, transmitted, transcribed, stored in a retrieval system or translated into any language or computer language, in any form or by any means, electronic, mechanical, magnetic, optical, chemical, manual or otherwise, without the prior written permission of BENQ Corporation.

## Disclaimer

BENQ Corporation makes no representations or warranties, either expressed or implied, with respect to the contents hereof and specifically disclaims any warranties, merchantability or fitness for any particular purpose. Further, BENQ Corporation reserves the right to revise this publication and to make changes from time to time in the contents hereof without obligation of BENQ Corporation to notify any person of such revision or changes.

\*Windows, Internet Explorer and Outlook Express are trademarks of Microsoft Corporation. DLP, Digital Micromirror Device and DMD are trademarks of Texas Instruments. Others are copyrights of their respective companies or organizations.

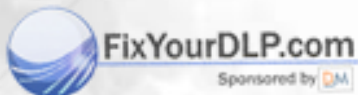

**Discount-Merchant.com (800) 281-8860**  
**THE TRUSTED SOURCE FOR PROJECTOR LAMPS AND ACCESSORIES**

# Table of Contents

|                                                                                   |           |
|-----------------------------------------------------------------------------------|-----------|
| <b>Safety, Regulatory and Legal Information .....</b>                             | <b>5</b>  |
| Warning Label .....                                                               | 5         |
| FCC Statement (for United State users) .....                                      | 5         |
| EEC Statement (for European users) .....                                          | 5         |
| MIC Statement .....                                                               | 5         |
| Precautions .....                                                                 | 6         |
| Safety Instructions .....                                                         | 7         |
| Moisture Condensation .....                                                       | 8         |
| Avoid Volatile Liquid .....                                                       | 8         |
| Disposal .....                                                                    | 8         |
| <b>Overview .....</b>                                                             | <b>9</b>  |
| Features .....                                                                    | 9         |
| Shipping Contents .....                                                           | 10        |
| Installing or Replacing Batteries .....                                           | 10        |
| Projector Exterior View .....                                                     | 11        |
| Front / Upper Side .....                                                          | 11        |
| Rear Side .....                                                                   | 11        |
| Bottom Side .....                                                                 | 11        |
| Connector Panel .....                                                             | 12        |
| Controls and Functions .....                                                      | 13        |
| Control Panel .....                                                               | 13        |
| Remote Control .....                                                              | 14        |
| <b>Connecting .....</b>                                                           | <b>15</b> |
| Connecting Video Inputs .....                                                     | 15        |
| Connecting to DVD players .....                                                   | 15        |
| Connecting Progressive Component (DTV Y/PB/PR) .....                              | 15        |
| Connecting RGBHV (DTV RGB) .....                                                  | 16        |
| Connecting Video Equipment, a PC or another Computer using the DVI-I Connector .. | 16        |
| <b>Setting Up Your Projector .....</b>                                            | <b>17</b> |
| Preparations .....                                                                | 17        |
| Adjust the Height .....                                                           | 17        |
| Setting Up the Screen .....                                                       | 18        |
| Ceiling Installation for 16 : 9 Screen .....                                      | 18        |
| Floor Installation for 16 : 9 Screen .....                                        | 18        |
| <b>Basic Operation .....</b>                                                      | <b>19</b> |
| Turning the Power on .....                                                        | 19        |
| Zoom / Focusing .....                                                             | 19        |
| Selecting Input Source .....                                                      | 19        |
| Selecting Aspect Ratio .....                                                      | 20        |
| Selecting the Video Memory .....                                                  | 20        |
| Setting Menu .....                                                                | 20        |
| PIP (Picture-In-Picture)/POP (Picture-On-Picture) functions .....                 | 21        |
| Turning the Power Off .....                                                       | 21        |
| <b>Menus .....</b>                                                                | <b>22</b> |
| Menu Structure .....                                                              | 22        |



Discount-Merchant.com (800) 281-8860  
 THE TRUSTED SOURCE FOR PROJECTOR LAMPS AND ACCESSORIES

|                                                                    |           |
|--------------------------------------------------------------------|-----------|
| Using the Menu .....                                               | 23        |
| PICTURE Menu .....                                                 | 23        |
| DISPLAY Menu .....                                                 | 24        |
| ENVIRONMENT Menu .....                                             | 26        |
| INSTALLATION Menu .....                                            | 27        |
| PRO-PICTURE Menu .....                                             | 28        |
| <b>Additional Information .....</b>                                | <b>30</b> |
| Warning Message .....                                              | 30        |
| Replacing the Lamp (Contact your BenQ dealer for assistance) ..... | 31        |
| Indicators .....                                                   | 32        |
| Troubleshooting .....                                              | 33        |
| Specifications .....                                               | 34        |
| Optical Characteristics .....                                      | 34        |
| Electrical Characteristics .....                                   | 34        |
| Input/Output .....                                                 | 34        |
| General Characteristics .....                                      | 34        |
| Dimensions .....                                                   | 35        |

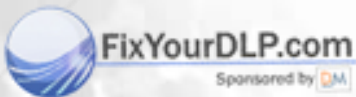

**Discount-Merchant.com (800) 281-8860**  
**THE TRUSTED SOURCE FOR PROJECTOR LAMPS AND ACCESSORIES**

# 1 Safety, Regulatory and Legal Information

Thank you for your purchase of this quality BenQ video projector! It has been designed to provide you with a home theater viewing experience. For the best result, please read this manual carefully as it is your guide through the control menus and operation.

## Warning Label

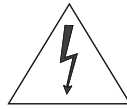
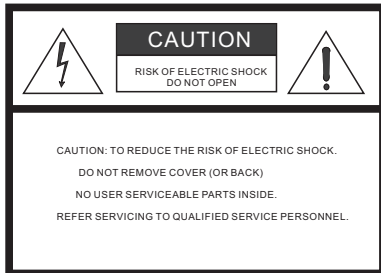

This symbol is intended to alert the user to the presence of dangerous voltage within the product's enclosure that may cause electric shock.



This symbol is intended to alert the user to the presence of important operating and maintenance (servicing) instructions in the literature accompanying the appliance.

## FCC Statement (for United State users)

This equipment has been tested and found to comply with the limits for a Class B digital device, pursuant to Part 15 of the FCC Rules. These limits are designed to provide reasonable protection against harmful interference in a residential installation.

**CLASS B:** This equipment generates, uses and can radiate radio frequency energy and, if not installed and used in accordance with the instructions, may cause harmful interference to radio communications. However, there is no guarantee that interference will not occur in a particular installation. If this equipment does cause harmful interference to radio or television reception, which can be determined by turning the equipment off and on, the user is encouraged to try to correct the interference by one or more of the following measures:

- Reorient or relocate the receiving antenna.
- Increase the distance between the equipment and receiver.
- Connect the equipment into an outlet on a circuit different from that to which the receiver is connected.
- Consult the dealer or an experienced radio/TV technician for help.

## EEC Statement (for European users)

This machine was tested against the 89/336/EEC (European Economic Community) for EMC (Electro Magnetic Compatibility) and fulfills these requirements.

## MIC Statement

### A class equipment (Business purpose info/telecommunications equipment)

As this equipment has undergone EMC registration for business purpose, the seller and/or the buyer is asked to beware of this point and in case a wrongful sale or purchase has been made, it is asked that a change to household use be made.

### B class equipment (Household purpose info/telecommunications equipment)

As this equipment has undergone EMC registration for household purpose, this product can be used in any area including residential areas.



Discount-Merchant.com (800) 281-8860  
THE TRUSTED SOURCE FOR PROJECTOR LAMPS AND ACCESSORIES

## Precautions

Your BenQ projector is designed and tested to meet the latest standards for safety of information technology equipment. However, to ensure safe use of this product, it is important that you follow the instructions mentioned in this manual and marked on the product.

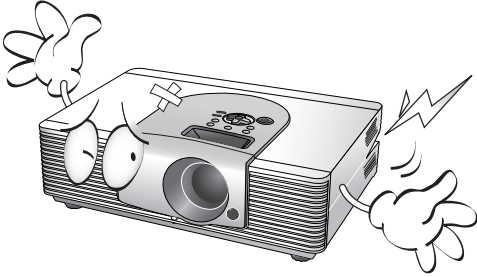
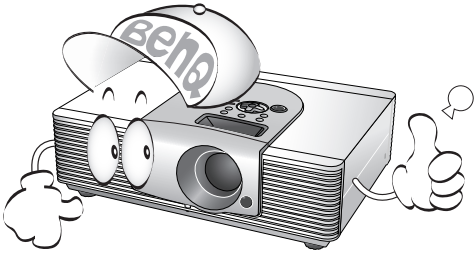
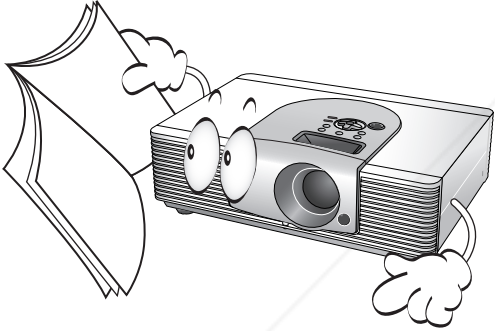
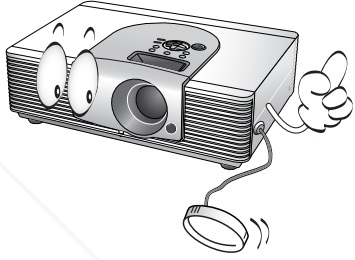
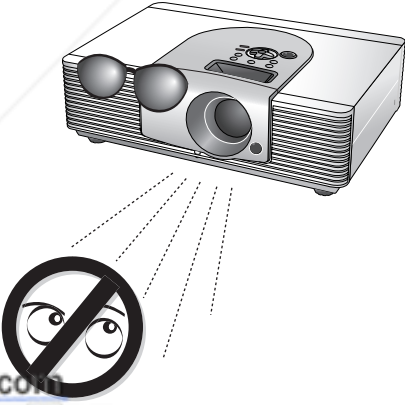
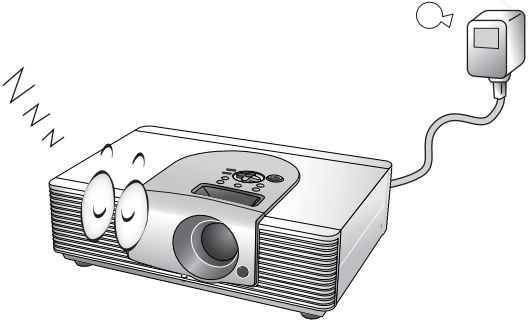
| Precautions                                                                                                                                                                                                                                                 |                                                                                                                                                                                                                                                                                                                                                                                                                                                                                                                                                                             |
|-------------------------------------------------------------------------------------------------------------------------------------------------------------------------------------------------------------------------------------------------------------|-----------------------------------------------------------------------------------------------------------------------------------------------------------------------------------------------------------------------------------------------------------------------------------------------------------------------------------------------------------------------------------------------------------------------------------------------------------------------------------------------------------------------------------------------------------------------------|
| <ul style="list-style-type: none"><li>• <b>To prevent shock, do not open the cabinet.</b> There are no user serviceable parts inside.</li></ul>                            | <ul style="list-style-type: none"><li>• <b>Refer servicing to qualified service personnel.</b></li></ul>                                                                                                                                                                                                                                                                                                                                                                                  |
| <ul style="list-style-type: none"><li>• <b>Please read this user's manual before you operate your projector.</b> Save this user's manual for future reference.</li></ul>  | <ul style="list-style-type: none"><li>• <b>Always open the lens shutter or remove the lens cap when the projector lamp is on.</b></li></ul>                                                                                                                                                                                                                                                                                                                                              |
| <ul style="list-style-type: none"><li>• <b>Do not look straight at the projector lens during operation.</b> The intense light beam may damage your eyes.</li></ul>       | <ul style="list-style-type: none"><li>• In some countries, the line voltage is NOT stable. This projector is designed to operate safely with a mains voltage between 100 and 240 volts AC, but could fail if power cuts or surges of <math>\pm 10</math> volts occur. <b>In areas where the mains voltage may fluctuate or cut out, it is recommended that you connect your projector through a power stabilizer, surge protector or uninterruptible power supply (UPS).</b></li></ul>  |

# Safety Instructions

## Safety Instructions

1. The lamp becomes extremely hot during operation. Allow the projector to cool for approximately 45 minutes prior to removing the lamp assembly for replacement.

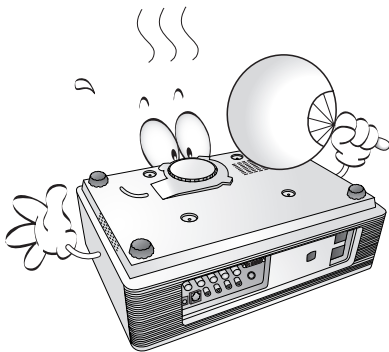

2. Do not operate lamps beyond the rated lamp life. Excessive operation of lamps beyond the rated life could cause them to explode on rare occasions.

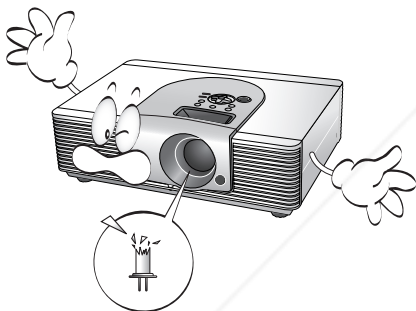

3. Never replace the lamp assembly or any electronic components unless the projector is unplugged.

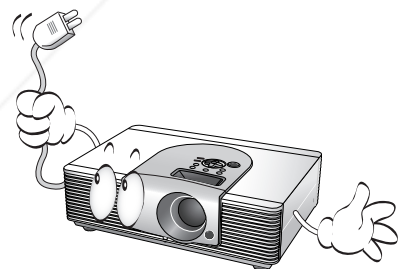

4. Do not place this product on an unstable cart, stand, or table. The product may fall, sustaining serious damage.



5. To reduce the risk of electric shock, do not disassemble this appliance. Take it to a qualified technician when service or repair is required. Incorrect reassembly can cause malfunction of the projector or electric shock when the appliance is subsequently used.

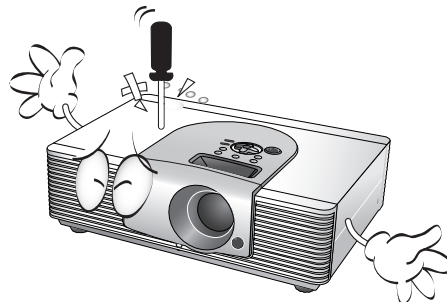

6. This product is capable of displaying inverted images for ceiling mount installation. Please use BenQ's Ceiling Mounting Kit for mounting the unit and ensure it is securely installed.

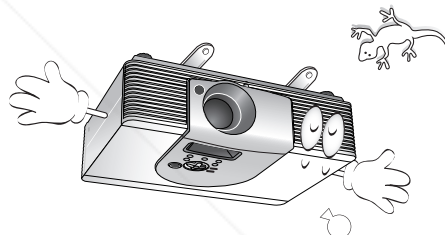

7. Do not block the ventilation holes.
  - Do not place this unit on a blanket, bedding or any other soft surface.
  - Do not cover this unit with a cloth or any other item.
  - Do not place inflammables near the projector.

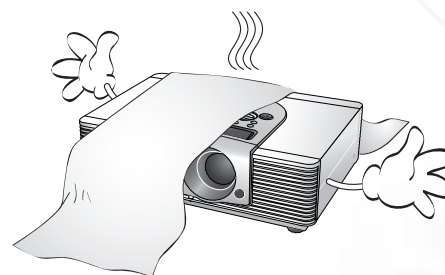

If the ventilation holes are seriously obstructed, overheating inside the unit may cause damage to the lamp, the projector to fail or result in fire.



## Safety Instructions (Continued)

8. Do not place this unit in any of the following environments.
- Space where is poorly ventilated or confined. Allow at least 50 cm clearance from walls and free flow of air around the projector.
  - Locations where temperatures may become excessively high, such as the inside of a car with all windows rolled up.
  - Locations where excessive humidity, dust, or cigarette smoke may contaminate optical components, shortening the projector's lifespan and darkening the screen.
  - Locations near fire alarms
  - Locations with an ambient temperature above 35°C / 95°F

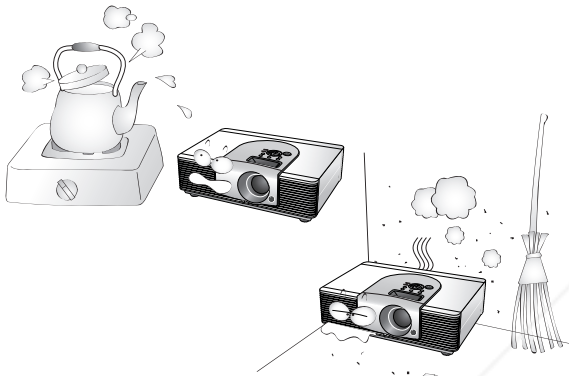

9. Always place the unit on a level, horizontal surface during operation.
- Do not use if tilted at an angle of more than 10 degrees left to right, nor at angle of more than 15 degrees front to back. Using the unit when it is not fully horizontal may cause a malfunction of, or damage to, the lamp or other components.

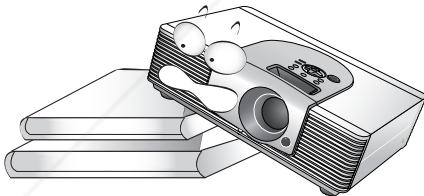

10. Do not stand the unit on end vertically.

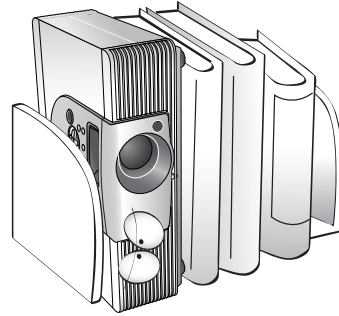

Doing so may cause the unit to fall over, causing injury or resulting in damage to the unit.

11. Do not step on this unit or place any objects upon it.

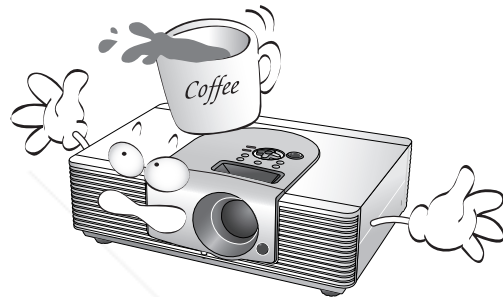

Besides probable physical damage to the unit, doing so may result in accidents and possible injury.

12. Do not place liquids near or on the projector. Liquids spilled into the projector may cause it to fail. If the projector does become wet, disconnect it from the power supply's wall socket and call BenQ to have the projector serviced.

## Moisture Condensation

Never operate the projector immediately after moving it from a cold location to a hot location. When the projector is exposed to such a change in temperature, moisture may condense on the crucial internal parts. To prevent the projector from possible damage, do not use the projector for at least 2 hours when there is a sudden change in temperature.

## Avoid Volatile Liquid

Do not use volatile liquids, such as insecticide or some types of cleaner, near the projector. Do not have rubber or plastic products touching the projector for a long time. They will leave marks on the finish. If cleaning with a chemically saturated cloth, be sure to follow the product's safety instructions.

## Disposal

This product contains the following materials which are harmful to human bodies and environment.

- Lead, which is contained in solder.
- Mercury, which is used in lamp.

To dispose the product or used lamps, consult your local environment authorities for regulations.

## 2 Overview

### Features

■ **High Picture Quality**

This single DMD DLP™ projector provides excellent picture quality, a high contrast ratio and very good color uniformity.

■ **Dynamic Performance and Rich Gray-Scale**

With a 6-segment color wheel, the projector can attain refresh rates of up to 300 Hz which provides dynamic performance and rich gray-scale without the 'color flicker' or 'rainbow effect' associated with other single-DMD DLP™ projectors.

■ **Sealed Optical Engine with a High-Quality Lens Design**

The optical engine uses a high-quality lens for maximizing optical performance. The sealed optical engine prevents light leakage and any dust from entering the engine, which could cause annoying 'spots' in the projected image.

■ **Low-Noise Operation**

The projector's unique cooling system design prevents annoying fan noise, and is rated at less than 30 dB.

■ **Wide Variety of Inputs**

The projector can support a wide variety of video formats including Composite, S-Video, Component (YPbPr / YCbCr) and DVI-I (digital and analogue RGB). The two component inputs are used to connect the projector to HDTV receivers and DVD players. They use RCA connectors to minimize signal degradation that may be caused by installations that have longer cables.

■ **HDTV Ready**

The projector is compatible with 480i, 480P, 576i, 576p, 1080i and 720P formats.

■ **De-interlacing with 3:2 Pull-Down**

Using BenQ's proprietary de-interlacing technology, the projector provides exceptional scaling and film-to-video (3:2 pull-down) conversion for the most artifact-free images possible.

■ **PIP/POP function**

The Picture-In-Picture (PIP) and Picture-On-Picture (POP) functions allow you to display two inputs on the screen at the same time.

■ **Video Memory**

This projector allows users to store up to three different configurations in its video memories to optimize the image for different types of signal.















■ **Multilingual OSD (On-Screen Display) menus**



**Discount-Merchant.com (800) 281-8860**  
**THE TRUSTED SOURCE FOR PROJECTOR LAMPS AND ACCESSORIES**

# Shipping Contents

The projector is shipped with the cables required for connection to a PC and video equipment. Carefully unpack and verify that you have all of the items shown below. If any of these items are missing, please contact your place of purchase.

|                                                                                     |                                                                                     |                                                                                     |                                                                                      |
|-------------------------------------------------------------------------------------|-------------------------------------------------------------------------------------|-------------------------------------------------------------------------------------|--------------------------------------------------------------------------------------|
|    |    |  |   |
| Projector                                                                           | User's manual                                                                       | User's manual CD                                                                    | Warranty card                                                                        |
|   |    |    |   |
| Remote control                                                                      | Batteries                                                                           | BNC-RCA adapter                                                                     | 12V DC-plug                                                                          |
|                                                                                     |   |   |  |
|                                                                                     | US (110V)                                                                           | EU (220V)                                                                           | UK (240V)                                                                            |
|                                                                                     |                                                                                     |                                                                                     |  |
|                                                                                     |                                                                                     |                                                                                     | Component video cable                                                                |
|  |  |  |  |
| S-Video cable                                                                       | D-Sub - DVI-I cable                                                                 | Composite video cable                                                               | DVI-DVI cable                                                                        |

## Installing or Replacing Batteries

Push on the cover and slide it to open. Install two AAA batteries with the correct polarity, then close the cover.

### Notes on Batteries

- Make sure that the polarities are correct when installing the batteries.
- Do not mix an old battery with a new one, or mix different types of batteries.
- If the remote control will not be used for an extended period of time, remove the batteries to avoid damage from battery leakage.



# Projector Exterior View

## Front / Upper Side

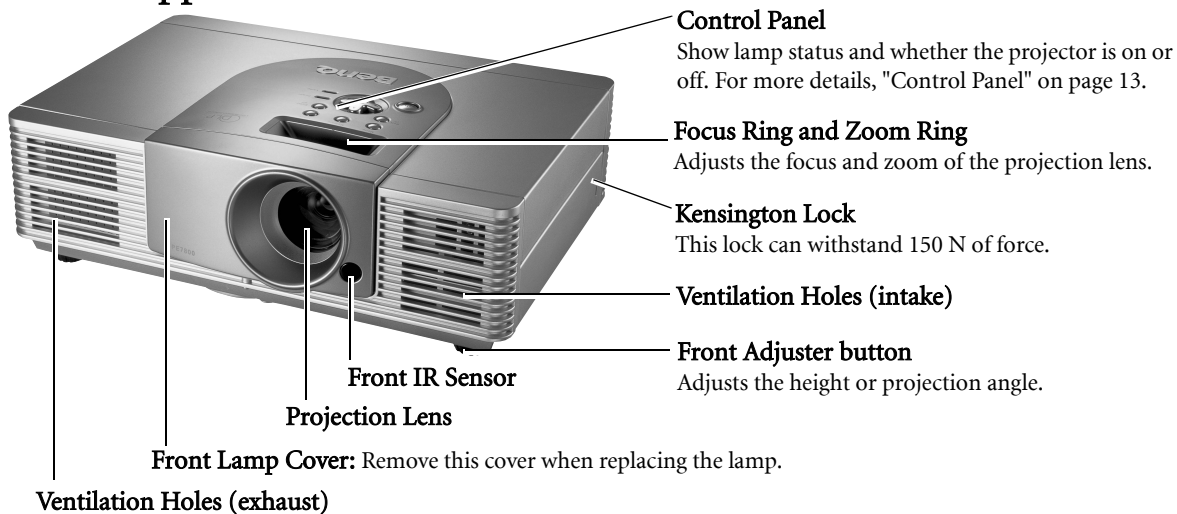

## Rear Side

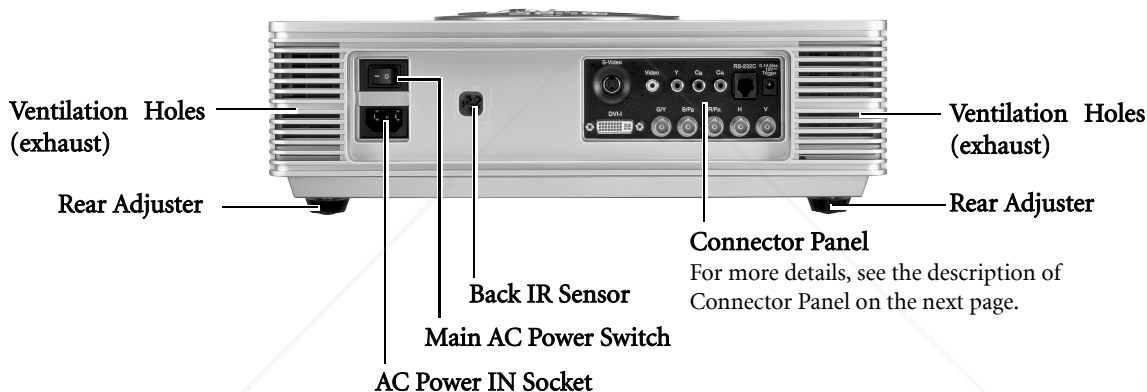

## Bottom Side

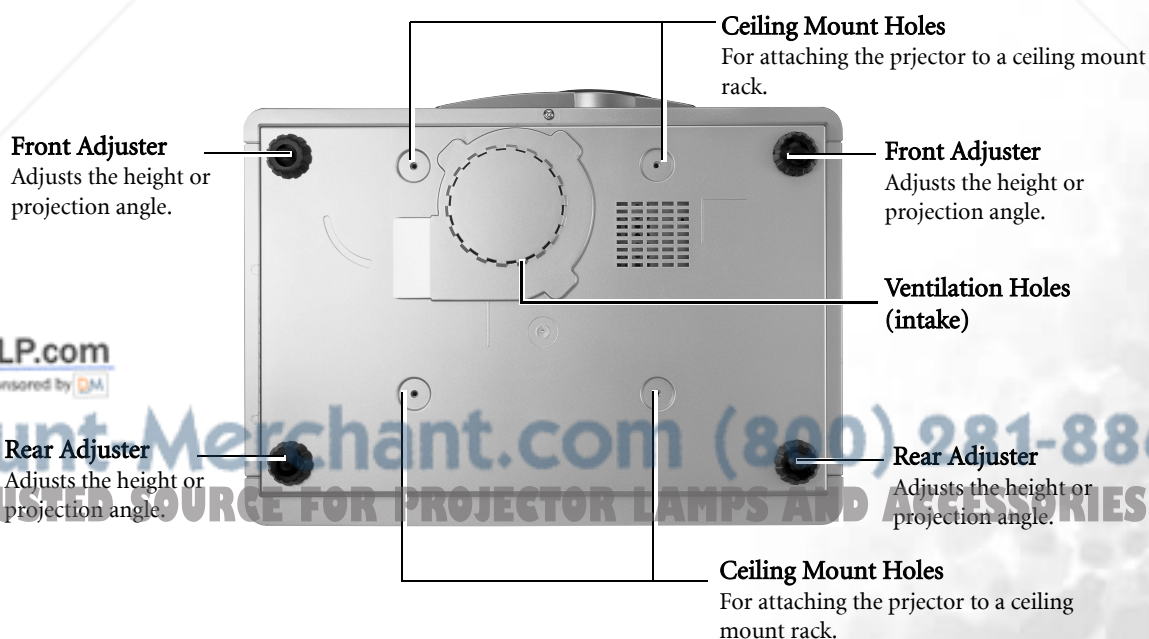

## Connector Panel

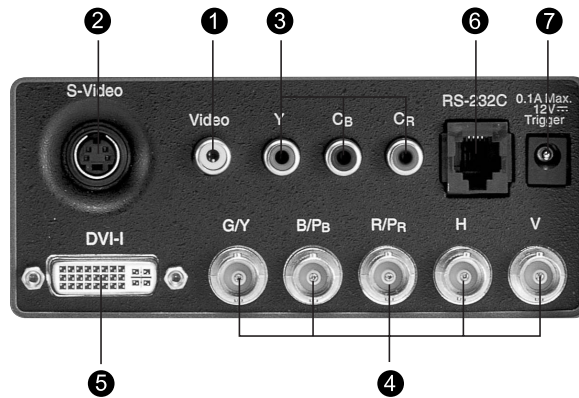

1. **Video (RCA jack)**  
Composite video signal input.
2. **S-Video (mini DIN 4-pin)**  
Y/C (S-video) signal input
3. **Component (RCA jacks)**  
480i Component (Y/Cb/Cr) video signal input
4. **RGB/ HDTV (BNC)**  
DTV Y/Pb/Pr or DTV RGB video signal input.
5. **Computer (DVI-I)**  
RGB Computer and DVI signal input.
6. **RS-232C (phone jack)**  
RS-232C control signal input.
7. **12V Trigger (mini jack)**  
+12V output, active when the projector is turned on.

# Controls and Functions

## Control Panel



1. **POWER (Refer to pages 19, 21 and 32 for more information.)**  
Press this key for ONE second to turn the projector on when it is in the standby mode. Or press this key twice to turn the unit off.
2. **ARROWS (▲/◀/▼/▶) (Refer to page 23 for more information.)**  
Used to select the desired menu items and to make adjustments.
3. **EXIT**  
Exits and saves the menu settings.
4. **MENU (Refer to page 22 for more information.)**  
Turns the on-screen display control menu on or off.
5. **MEMORY (Refer to page 20 and 26 for more information.)**  
Sequentially recalls settings 1 ~ 3 saved to memory.
6. **INPUT (Refer to page 19 and 24 for more information.)**  
Switches input sources sequentially.
7. **ENTER (Refer to page 23 for more information.)**  
Opens the selected item of the menu.
8. **POWER light**  
Indicates whether the unit is on or off
  - The orange light shows when the AC power cord is plugged into the wall outlet (standby mode). Once in the standby mode, you can press the POWER key on the projector or the ON key on the remote control for ONE second to turn the projector on.
  - The green light shows when the power is turned on and the projector is operating.
  - Flashes orange for the first 60 seconds during powering up, indicating that the lamp is warming up.
  - Flashes orange for two minutes after the projector is turned off to indicate that the lamp is cooling.
9. **LAMP indicator light (Refer to page 32 for more information.)**  
Indicates the status of lamp.  
Shows a red light when the lamp has developed a problem. Please contact your BenQ dealer for assistance.
10. **Zoom Ring (Refer to page 19 for more information.)**  
Adjusts the size of the image
  - Rotate clockwise to enlarge the image or rotate counter-clockwise to make the image smaller.
11. **Focus Ring (Refer to page 19 for more information.)**  
Adjusts the focus of the projected image.

# Remote Control

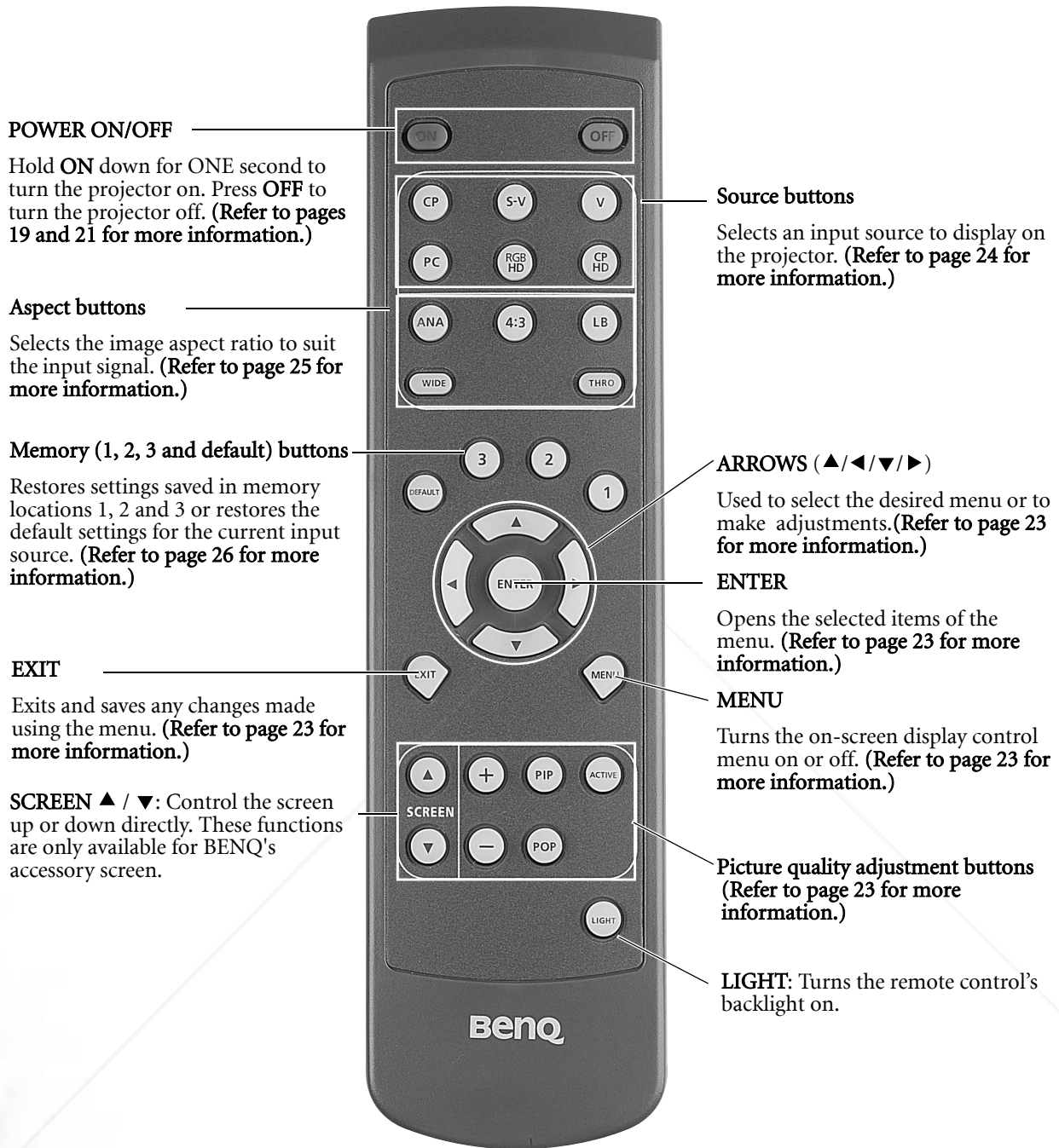

**POWER ON/OFF**  
Hold **ON** down for ONE second to turn the projector on. Press **OFF** to turn the projector off. (Refer to pages 19 and 21 for more information.)

**Aspect buttons**  
Selects the image aspect ratio to suit the input signal. (Refer to page 25 for more information.)

**Memory (1, 2, 3 and default) buttons**  
Restores settings saved in memory locations 1, 2 and 3 or restores the default settings for the current input source. (Refer to page 26 for more information.)

**EXIT**  
Exits and saves any changes made using the menu. (Refer to page 23 for more information.)

**SCREEN ▲ / ▼:** Control the screen up or down directly. These functions are only available for BENQ's accessory screen.

**Source buttons**  
Selects an input source to display on the projector. (Refer to page 24 for more information.)

**ARROWS (▲/◀/▼/▶)**  
Used to select the desired menu or to make adjustments. (Refer to page 23 for more information.)

**ENTER**  
Opens the selected items of the menu. (Refer to page 23 for more information.)

**MENU**  
Turns the on-screen display control menu on or off. (Refer to page 23 for more information.)

**Picture quality adjustment buttons**  
(Refer to page 23 for more information.)

**LIGHT:** Turns the remote control's backlight on.

## Notes on Remote Control Operation

■ Make sure that there is nothing between the remote control and the IR sensor on the projector that might obstruct the infrared beam.

■ The effective range of the remote control is up to 8 meters from the front of the projector or 8 meters from the rear of the projector. The remote control must be held at an angle within 30 degrees of the projector's IR remote control sensor.

**FixYourDLP.com**  
 sponsored by  
**Discount-Merchant.com** (800) 981-9860  
**THE TRUSTED SOURCE FOR PROJECTOR LAMPS AND ACCESSORIES**

# 3 Connecting

When connecting any signal source to the projector, be sure to:

1. Turn off all equipment before making any connections.
2. Use the correct signal cables for each source.
3. Ensure the cables are firmly inserted.
4. Connect all audio signals to external speakers. This projector is not equipped with speakers.

## Connecting Video Inputs

### Connecting to DVD players

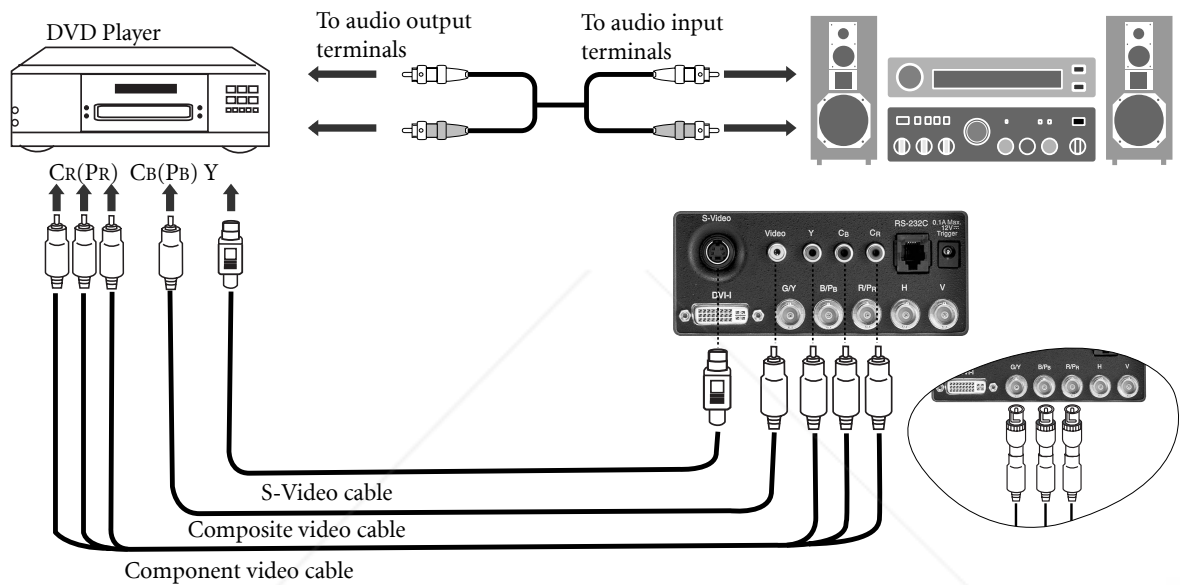

**ⓘ** If the selected video image is not displayed after the projector is turned on and the correct video source has been selected, please check that the video source is turned on and operating correctly. Also check that the signal cables have been connected correctly.

### Connecting Progressive Component (DTV Y/PB/PR)

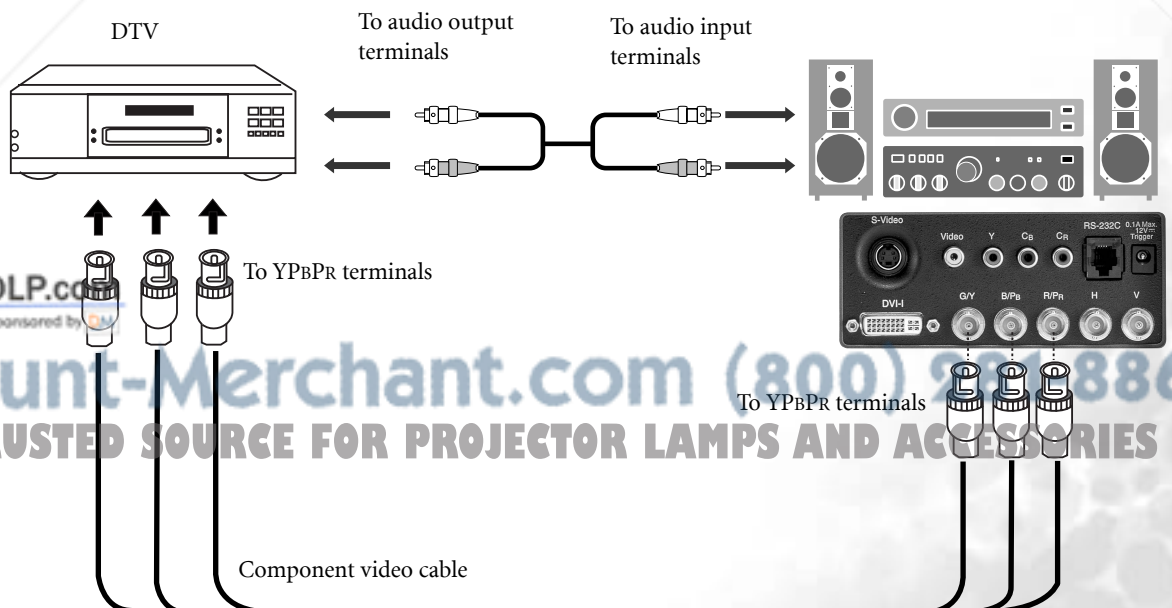

FixYourDLP.com  
Sponsored by  
**Discount-Merchant.com (800) 928-8860**  
THE TRUSTED SOURCE FOR PROJECTOR LAMPS AND ACCESSORIES



## Connecting RGBHV (DTV RGB)

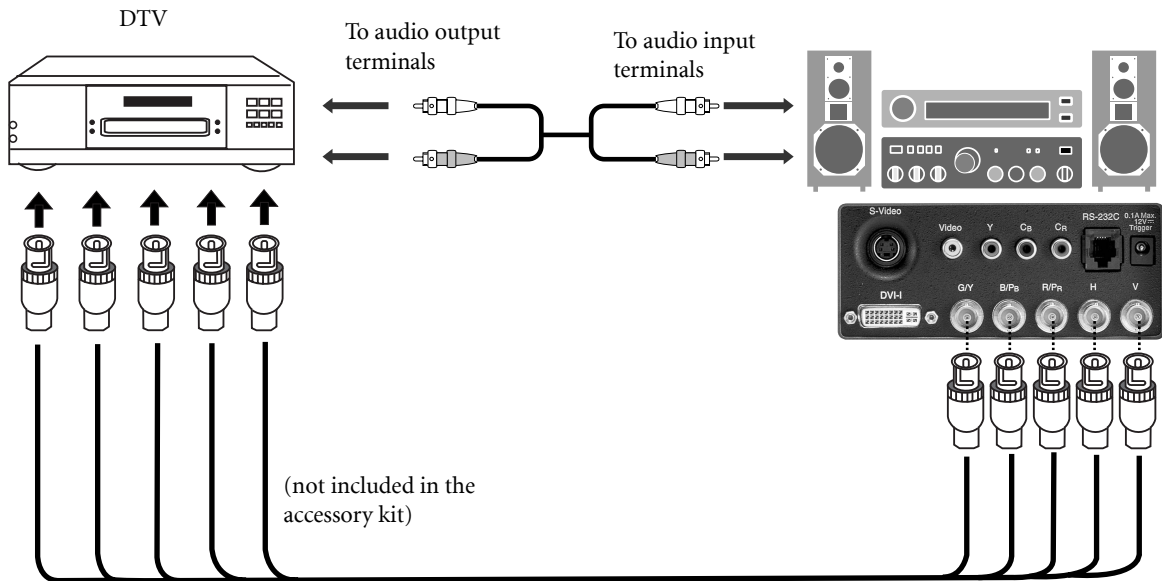

## Connecting Video Equipment, a PC or another Computer using the DVI-I Connector

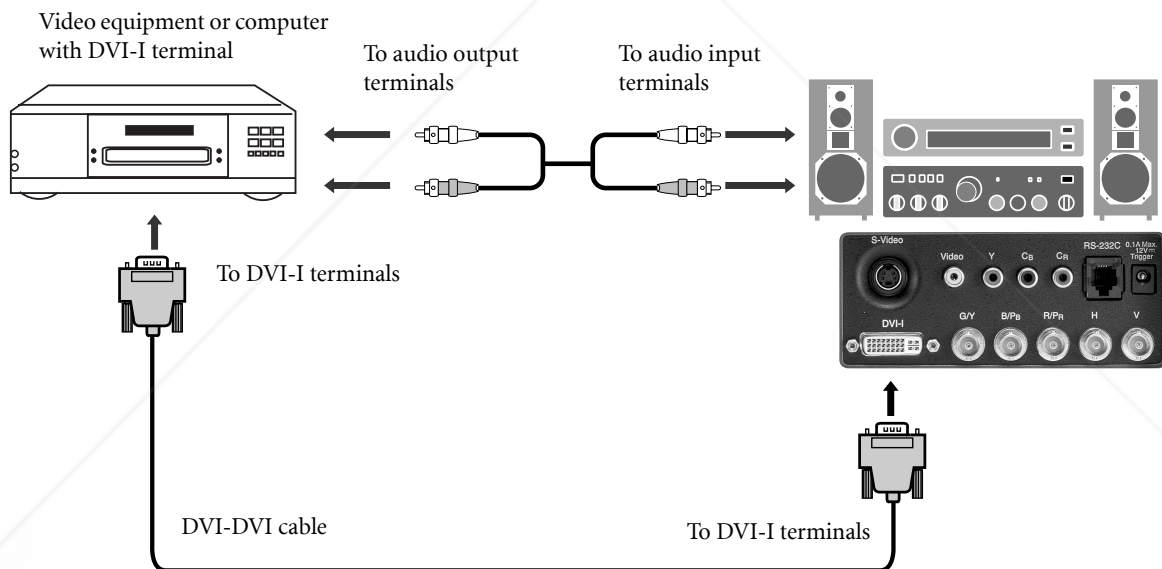

## 4 Setting Up Your Projector

### Preparations

1. Remove the lens cap.
2. Turn all of the connected equipment on.
3. Plug the supplied power cord into the AC inlet on the rear of this unit.
4. Plug the power cord into a wall socket and turn the wall switch on.
5. Turn on the main power switch at the rear of this unit (next to the AC inlet). The POWER light will light up in orange. Press **POWER ON/OFF** key on the remote control or **POWER** key on the projector for ONE second to turn the projector on.



### Adjust the Height

There are four adjustment screws on the bottom of the projector. These adjustment screws change the image height and projection angle. They can lift the projection angle by up to 15 degrees. To adjust the projector, you can screw the height adjustments to fine-tune the projection angle.

**☞ If the screen and the projector are not perpendicular to each other, the projected image becomes vertical trapezoidal. To correct this problem, adjust the value of Keystone in the Installation menu. See page 27 for more information.**



# Setting Up the Screen

## Ceiling Installation for 16 : 9 Screen

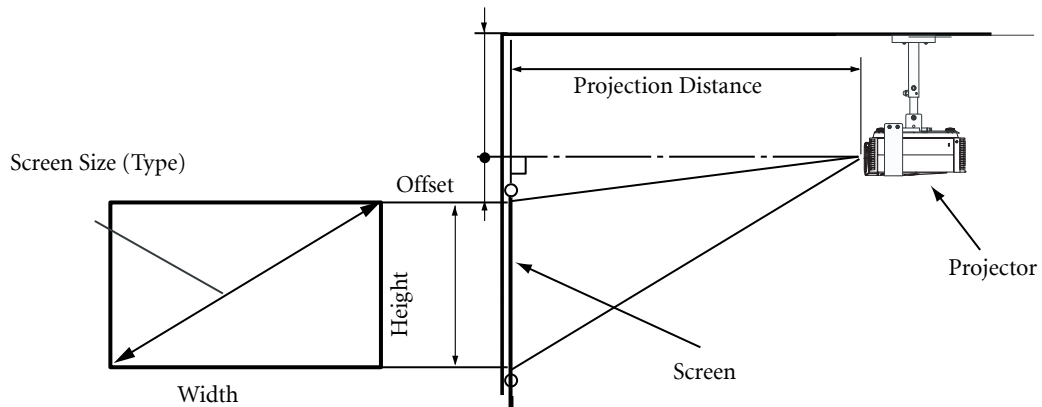

## Floor Installation for 16 : 9 Screen

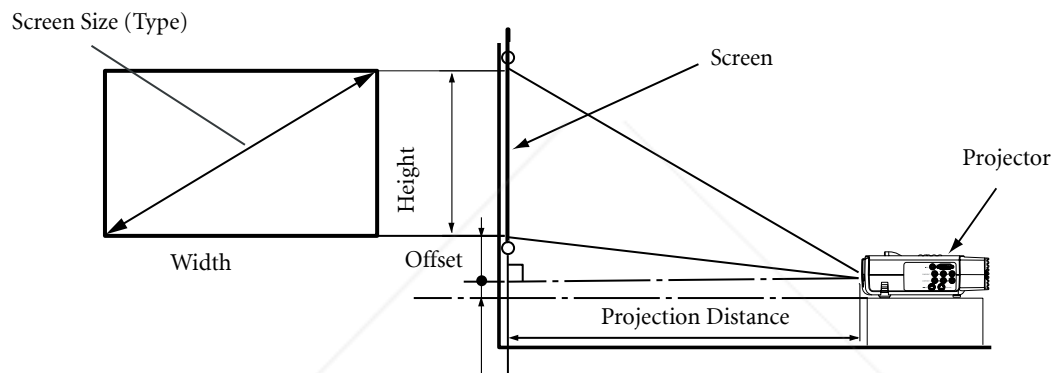

### 16 : 9 screen size (inch)

| Screen Size |        |       | Projection Distance |                    | Offset     |
|-------------|--------|-------|---------------------|--------------------|------------|
| Type        | Height | Width | Min.<br>(W x 1.63)  | Max.<br>(W x 1.99) | (W x 0.12) |
| 45.9        | 22.5   | 40.0  | 65.2                | 79.6               | 4.8        |
| 68.9        | 33.8   | 60.0  | 97.8                | 119.4              | 7.2        |
| 91.8        | 45.0   | 80.0  | 130.4               | 159.2              | 9.6        |
| 103.3       | 50.6   | 90.0  | 146.7               | 179.1              | 10.8       |
| 114.8       | 56.3   | 100.0 | 163.0               | 199.0              | 12.0       |
| 126.2       | 61.9   | 110.0 | 179.3               | 218.9              | 13.2       |
| 137.7       | 67.5   | 120.0 | 195.6               | 238.8              | 14.4       |
| 149.2       | 73.1   | 130.0 | 211.9               | 258.7              | 15.6       |
| 160.7       | 78.8   | 140.0 | 228.2               | 278.6              | 16.8       |
| 183.6       | 90.9   | 160.0 | 260.8               | 318.4              | 19.2       |
| 206.6       | 101.3  | 180.0 | 293.4               | 358.2              | 21.6       |
| 229.5       | 112.5  | 200.0 | 326.0               | 398.0              | 24.0       |

The above numbers are approximate and may be slightly different from the actual measurements.

FixYourDLP.com  
Sponsored by DLP

**Discount-Merchant.com (800) 281-8860**  
THE TRUSTED SOURCE FOR PROJECTOR LAMPS AND ACCESSORIES

## 5 Basic Operation

### Turning the Power on

Follow the steps below.

1. Make sure the Power light is orange when power is applied and the main AC power switch is turned on.
2. Press and hold the **ON** key on the remote control or the **POWER** key on the projector for ONE second to turn the projector on. The **POWER** light will flash orange while warming up, then show a steady green.
3. "Searching...." will be displayed on the screen before the projector identifies the input signal. This message will remain on the screen until a valid signal is detected.
4. If the horizontal frequency of the input signal exceeds the range of the projector (XGA), a message reading "Unsupported timing" will be displayed on the screen. This message will remain on-screen until you change the input signal.



 The **ON** key on the remote control and the **POWER** key on the projector may not work while the projector is cooling. (The Power light blinks orange while the projector is cooling.)

### Zoom / Focusing

- Adjust the projected image to the size that you need using the lens' zoom ring. Then focus the image by rotating the focus ring.

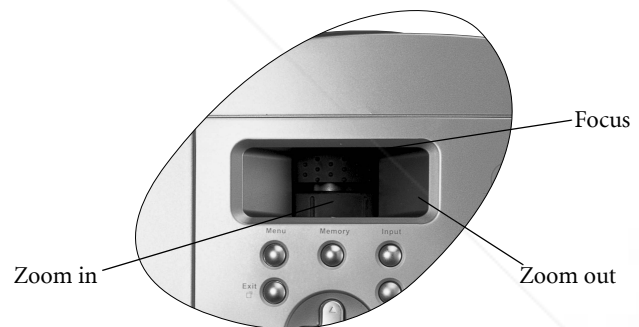

### Selecting Input Source

- When the projector is turned on, it will search for the input source you last selected.
- You may directly select the input source by using the remote control.



## Selecting Aspect Ratio

- Select an aspect ratio to suit the format of the video signal. There are five aspect ratios available:
  1. **ANA (ANAMORPHIC)**: Scales an image so that it is displayed in the center of the screen with a 16:9 aspect ratio.
  2. **Standard (4:3)**: Scales an image so that it is displayed in the center of the screen with a 4:3 aspect ratio.
  3. **LB (LETTERBOX)**: Enlarges an image with letterbox format to display it in full-screen format with a 16:9 aspect ratio. The upper and lower portions of the image are cropped. Use this setting for Cinemascope and Vista video wide screen formats.
  4. **THRO (Through)**: One-to-one mapping is performed on the input signal without any scaling with the image displayed at the center of the screen.
  5. **WIDE**: A 4:3 aspect ratio image is enlarged NON-linearly in horizontal direction to accommodate 16:9 full-screen display.
- Refer to page 25 for more information.



## Selecting the Video Memory

- Press the video memory key on the remote control to recall the settings directly.
- There are four video settings : MEMORY 1, MEMORY 2 and MEMORY 3 and DEFAULT. The DEFAULT key can be used to restore the default setting for the current input source.
- Refer to page 26 for more information.



## Setting Menu

- Press the **MENU** button to turn the on-screen display menu on or off.
- Use the **ARROW** buttons (▲/◀/▼/▶) to select items in the menu or to make various adjustments.
- Press the **ENTER** button to enter the setting for the current items in the menu, or press **EXIT** to leave and save the settings for the current items in the menu.
- Refer to page 23 for more information.



# PIP (Picture-In-Picture)/POP (Picture-On-Picture) functions

- Press the PIP button to enable the PIP function.
  1. For PIP purposes, there are two groups of inputs classified according to their display modes:
    - Video Group: Video, S-Video and Component Y/Cb/Cr inputs
    - Graphic Group: HDTV input and Computer input.
  2. The PIP function allows the projector to display one input from the Graphic Group within one input from the Video Group, or display one input from Video Group within one input from the Graphic Group.
  3. Press the PIP button to switch to the main window or turn off the PIP function.
  4. Select the input source for the main window by pressing the INPUT button.
- Press the POP key to enable the POP function.
- Press the ACTIVE button to switch to the active window. You can change the input signal setting in the active window.
- Press + or - to adjust the size of the PIP window.
- Adjust the position of the PIP window with the ARROW keys (▲/◀/▼/▶).
- **SCREEN ▲ / ▼**: Control the screen up or down directly. These functions are only available for BENQ's accessory screen.



## Turning the Power Off

Follow the steps below.

1. Press the **OFF** key on the remote control or the **POWER** key on the projector.
2. The **POWER** light flashes green and the fans run for two minutes to cool the lamp. The projector will not respond to any commands until the cooling process is complete.
3. Then, the **POWER** light is a steady orange once the cooling process has finished. The fans will continue to run for about two minutes after the light changes to orange.
4. The fans stop and the light is orange.
5. If the projector will not be used for an extended period, turn the main power switch off and unplug the power cord from the power outlet.



## Menu Structure

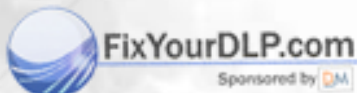
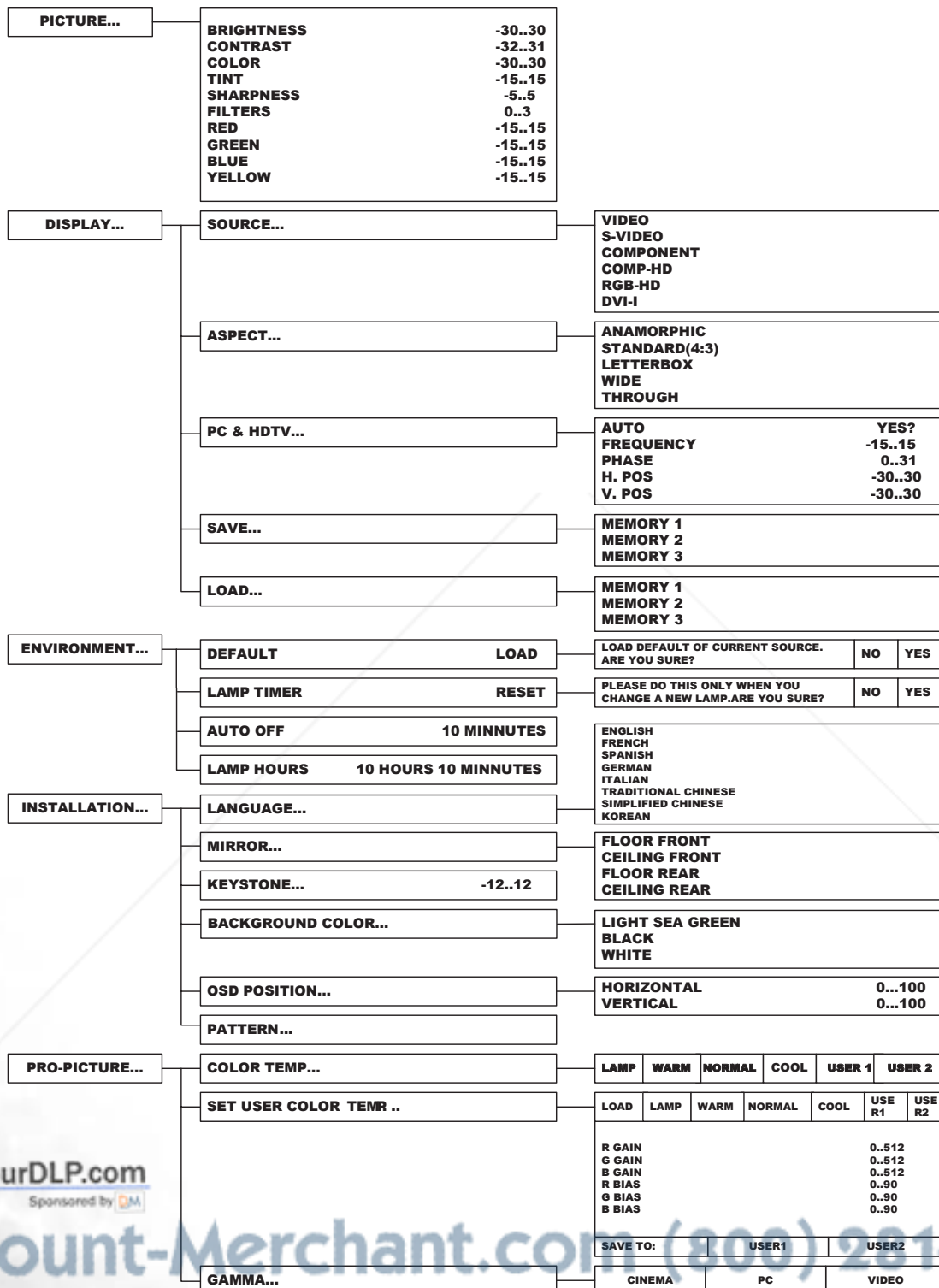

Discount-Merchant.com (800) 281-8860

THE TRUSTED SOURCE FOR PROJECTOR LAMPS AND ACCESSORIES

# Using the Menus

The projector is equipped with on-screen display (OSD) menus for making various adjustments and settings. There are eight different menu languages. Refer to "INSTALLATION Menu" on page 27 for more details.



The following example describes the adjustment of the keystone.

1. Press the MENU button to turn the on-screen menu on.

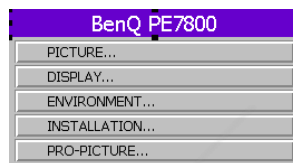

2. Use ▲ or ▼ to select INSTALLATION and press ENTER.
3. Use ▲ or ▼ to select KEYSTONE and press ENTER.

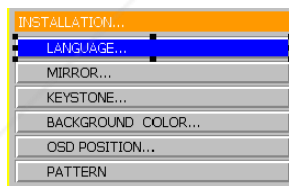

4. Adjust keystone values by pressing ◀ or ▶.



5. Press the EXIT button to leave and save the settings.

To leave the menu without saving, press the MENU button again.

## PICTURE Menu

These settings can be stored in three separate video memories, in which each can have different parameters for different input sources.

There are ten items in this menu: BRIGHTNESS — CONTRAST — COLOR — TINT — SHARPNESS — FILTERS — RED — GREEN — BLUE — YELLOW.

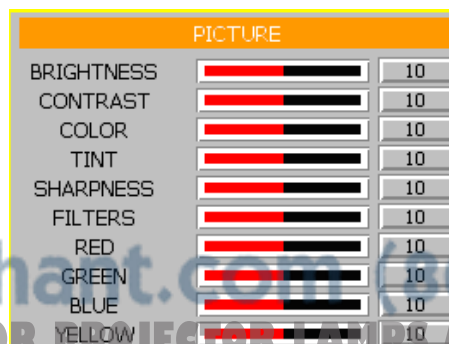

1. **BRIGHTNESS:** Adjusts the picture brightness to values between 0 and 60. The higher the value, the brighter the picture. And lower the setting, darker the picture.
2. **CONTRAST:** Adjusts the picture contrast to values between 0 and 30. The higher the value, the greater the contrast.



3. **COLOR:** Adjusts the color intensity to values between 0 and 60. The higher the value, the more vivid and brighter the color.
4. **TINT:** Adjusts the color tones to values between 0 and 30. The higher the value, the more reddish the picture becomes. The lower the value, the more greenish the picture becomes.  
 **Applies to NTSC video signal, only.**
5. **SHARPNESS:** Adjusts the picture sharpness to values between -10 and +10. The higher the value, the sharper the picture.
6. **FILTERS:** Turn the video and data filters on or off. Filters can reduce noise in the picture to produce a sharper image. There are four filters for video input (0 ~ 3) and two filters for graphic input (0 ~ 1). The higher the setting, the less the noise.
7. **RED:** Adjusts red hues independently to values between 0 and 30. The higher the setting, the greater the intensity of red color in the image.
8. **GREEN:** Adjusts green hues independently to values between 0 and 30. The higher the setting, the greater the intensity of green color in the image.
9. **BLUE:** Adjusts blue hues independently to values between 0 and 30. The higher the setting, the greater the intensity of blue color in the image.
10. **YELLOW:** Adjusts yellow hues independently to values between 0 and 30. The higher the setting, the greater the intensity of yellow color in the image.

## DISPLAY Menu

Use this menu to set the way that the projector displays the picture.

There are five items in this menu: SOURCE — ASPECT — PC & HDTV — SAVE — LOAD.



1. **SOURCE:** Selects the video source that will be displayed. .
  - VIDEO: Composite video signal.
  - S-VIDEO: S-Video video signal.
  - COMPONENT: Component Y/Cb/Cr input
  - COMP-HD: DTV Y/Pb/Pr input
  - RGB-HD: DTV RGBHV signal input
  - DVI-I: Computer signal input. Selects DVI-A (Analog) or DVI-D (Digital) signal automatically.



2. **ASPECT:** There are five aspect ratios that can be selected for different video signal:

- **ANAMORPHIC:** Scales an image so that it is displayed in the center of the screen with a 16:9 aspect ratio.

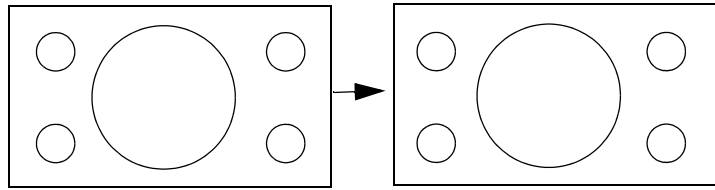

**BEFORE:** 16:9 images (1080i, 720p)

**AFTER:** Projects images on a full 16:9 screen

- **Standard (4:3):** Scales an image so that it is displayed in the center of the screen with a 4:3 aspect ratio.

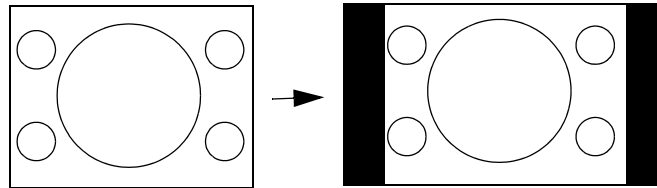

**BEFORE:** Picture images with a ratio of 4:3 (480i, 576i, 480p, 576p and PC)

**AFTER:** Projects images at a 4:3 ratio

- **LETTERBOX:** Enlarges an image with letterbox format to display it in full-screen format with a 16:9 aspect ratio. The upper and lower portions of the image are cropped. Use this setting for Cinemascope and Vista video wide screen formats.

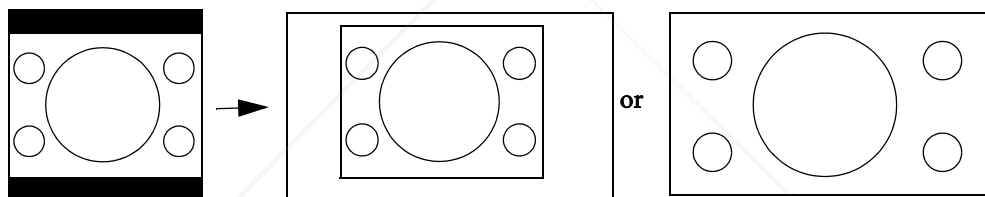

**BEFORE:** Cinemascope and Vista signals with a ratio of 4:3

**AFTER**

**AFTER**

- **WIDE:** Expands an image with a 4:3 aspect ratio NON-linearly along the horizontal axis to provide full screen display at a 16:9 aspect ratio.

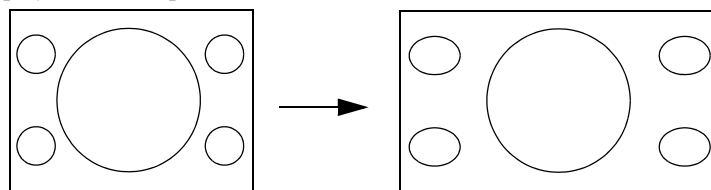

**BEFORE:** Projects images with a ratio of 4:3 (480i, 576i, 480p, 576p and PC)

**AFTER:** Expands projected image in horizontal direction to fit a full 16:9 screen

- **THROUGH :** One-to-one mapping is performed without any scaling of the image. The image is displayed at the center of the screen.



**BEFORE:** 16:9 images (1080i, 720p)

**AFTER:** Projected images are reduced to a half. (1080i)

**AFTER:** Projected images are compressed to a full screen size. (720p)



FixYourDLP.com

Sponsored by DM

Discount-Merchant.com (800) 281-8860  
THE TRUSTED SOURCE FOR PROJECTOR LAMPS AND ACCESSORIES

3. **PC&HDTV:** The following settings are only available with a PC or Digital Television RGB signal:
  - **AUTO:** Adjusts the phase, frequency and position automatically.
  - **FREQ.:** Adjusts the frequency of the sampling clock that captures the input signal.
  - **PHASE:** Adjusts the phase of the clock.
  - **H. POS.:** Adjusts the horizontal position of the image.
  - **V. POS.:** Adjusts the vertical position of the image.

 **The available adjustment range of the vertical position depends on the type of the input signal that is being displayed. The vertical position cannot be changed with some types of signal.**

4. **SAVE:** There are three video memories in which users can store settings, including all items in the Picture and Pro-Picture menus except for SET USER COLOR TEMP.

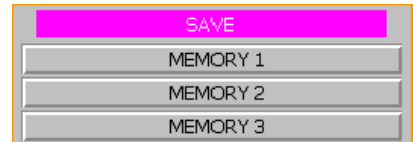

| Input source        | Number of available memories |
|---------------------|------------------------------|
| VIDEO               | 3                            |
| S-VIDEO             | 3                            |
| COMP-HD             | 3                            |
| DVI-ANALOG/ DIGITAL | 3                            |

- To store the settings:
    - i.) Adjusts the items in the Picture and Pro-Picture menus to desired values.
    - ii.) Go to the Display menu and select SAVE, press Enter. The SAVE OSD will be shown as the picture above.
    - iii.) Select MEMORY 1, MEMORY 2 or MEMORY 3 and press ENTER to store the settings.
    - iv.) To leave the OSD, press MENU.
5. **LOAD:** Loads the settings from one of three video memories.

## ENVIRONMENT Menu

In this menu, global settings for the projector can be made.

There are four items available: DEFAULT — LAMP TIMER — AUTO OFF — LAMP HOURS.

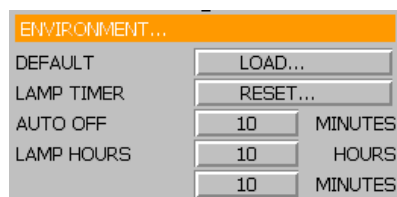

1. **DEFAULT:** Loads the default value of the current input source.
2. **LAMP TIMER:** Resets the lamp timer. This should only be done after the lamp has been replaced.
3. **AUTO OFF:** Sets the auto-shutdown timer. The timer can be set to a value between 10 minutes and 3 hours.
4. **LAMP HOURS:** Please refer to page 30 for detailed information.

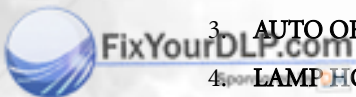

**Discount-Merchant.com (800) 281-8860**  
**THE TRUSTED SOURCE FOR PROJECTOR LAMPS AND ACCESSORIES**

# INSTALLATION Menu

This menu contains items necessary for installation.

There are six items available: LANGUAGE, MIRROR, KEYSTONE, BACKGROUND COLOR, OSD POSITION and PATTERN.

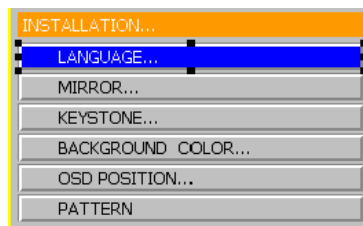

1. **LANGUAGE:** There are eight languages that can be selected for the menus: English, French, Spanish, German, Italian, Traditional Chinese, Simplified Chinese and Korean.
2. **MIRROR:** The projector can be installed on a ceiling or behind a screen, or with one or more mirrors. There are four settings for choice. But the settings are only working with the 1080i, 720p, 525p and 625p input signals and the input signals from DVI terminal. Contact your dealer for the ceiling mount bracket if you need to install the projector on a ceiling.

- **FLOOR FRONT:** Select this setting with the projector set on the floor and audience viewing the projected images from the front side of the screen. This is the most common setting.

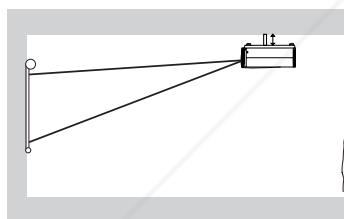
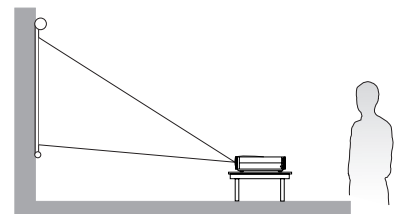

- **CEILING FRONT:** Select this setting with the projector suspended from the ceiling and audience viewing the projected images from the front side.

- **FLOOR REAR:** Select this setting when the projector is placed near the floor and behind the screen. A special rear projection screen is required.

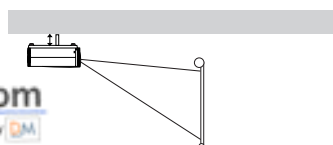
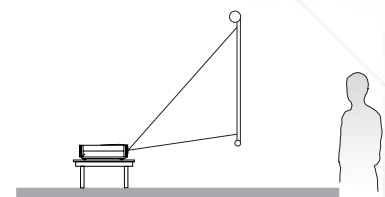

- **CEILING REAR:** Select this setting when the projector is suspended from the ceiling and placed behind the screen. A special rear projection screen is required.



**Discount-Merchant.com (800) 281-8860**  
THE TRUSTED SOURCE FOR PROJECTOR LAMPS AND ACCESSORIES

3. **KEYSTONE:** Corrects for trapezoidal distortion resulting from the angle of projection. It can provide correction of up to  $\pm 12$  degrees.
4. **BACKGROUND COLOR:** Allows the user to choose the color of the background screen that will be displayed when there is no input signal. Choose LIGHT SEA GREEN, BLACK and WHITE.

- OSD POSITION:** The position of the On Screen Display can be adjusted in both vertical and horizontal directions.

 **The available adjustment range of the vertical position depends on the type of the input signal that is being displayed. The vertical position cannot be changed with some types of signal.**

- PATTERN:** It will be displayed with the aspect ratio setting made using the ASPECT function of the DISPLAY menu. Use this pattern when installing the projector, even if there is no input signal. Use it to adjust the image size and the focus.

 **Only some of the items above can be adjusted, when there is no input signal.**

## PRO-PICTURE Menu

Except for SET USER COLOR TEMP, the settings can be stored in three separate video memories. Each can have different parameters for different types of video signal.

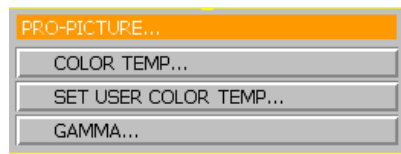

- COLOR TEMP:** Adjusts the white color. 5 options are available for COLOR TEMPERATURE: HI BRIGHT, STANDARD, LOW, USER1 and USER 2.
  - **HI BRIGHT:** High color temperature. Makes white bluish. It is best suited to PCs and other computers.
  - **STANDARD:** Middle color temperature (6500°K). Maintains normal colorings for white. It is best suited for viewing TV.
  - **LOW:** Low color temperature (5700°K). Makes white appear reddish. It is best suited for viewing movies.
  - **USER 1 and USER 2 :** Two different color temperatures can be customized and stored. See below for details

- SET USER COLOR TEMP:** Adjusts and stores users' preferable color temperature.

- To store the settings:

i.) Open the **PRO-PICTURE** menu and select **SET USER COLOR TEMPERATURE**, press **ENTER**. A menu like the one pictured to the right will be displayed.

ii.) Choose a basic color temperature among LAMP, WARM, NORMAL and COOL by pressing the **▲** or **▼** button and press **ENTER**.

iii.) Press **▲** or **▼** to select the item to be changed. And adjust the value with **◀** or **▶** button.

iv.) Store the settings as **USER 1** or **USER 2** by pressing the **▲** or **▼** button.

v.) Press **Enter** to save the changes.

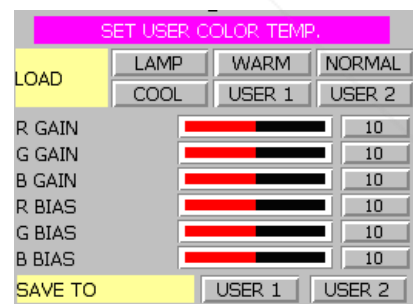

### About color temperatures:

There are many different shades that are considered to be "white" for various purposes. One of the common methods of representing white color is known as the "color temperature". A white color with a low color temperature appears to be reddish white. A white color with a high color temperature appears to have more blue in it. The SET USER COLOR TEMP menu allows you to alter the color temperature and the overall color balance of the image by adjusting the red, green and blue gains and biases.

### To make the color temperature higher

Set the value of B GAIN (or B BIAS) greater, and the value of R GAIN (or R BIAS) smaller.

### To make the color temperature lower

Set the value of R GAIN (or R BIAS) greater, and the value of B GAIN ( or B BIAS) smaller.

3. **GAMMA:** Adjusts the color saturation of mid color tones within the image. Can be used to displayed fine detail more clearly under some conditions.
  - CINEMA: Suitable for viewing movies in a dark room.
  - PC: Suitable for viewing images from a PC or other computer in a bright room.
  - VIDEO: Suitable for viewing video programs in a dark room.



**Discount-Merchant.com (800) 281-8860**  
**THE TRUSTED SOURCE FOR PROJECTOR LAMPS AND ACCESSORIES**

# 7 Additional Information

## Warning Message

- It is normal for illumination from the lamp to dim somewhat when the projector has been used for a period of time.
- The message "Lamp life is expired ! Please install new lamp. And reset the lamp timer." will be displayed for 30 seconds on the screen when the lamp has been in use for 1950 hours.
- The message " Please replace the lamp! Lamp will exceed its lifetime after (hours):" will be displayed on the screen for 30 seconds each time the projector is turned on after the lamp has been in use for 1980 hours. The number of hours will be updated.
- The message "Please replace the lamp !" will be displayed on the screen continuously and the POWER LED will flash orange and green sequentially if the lamp has been in use for more than 2,000 hours.
- The projector will turn off automatically after 10 minutes.

Lamp life is expired!  
Please install new lamp  
And reset the lamp timer

Please replace the lamp!  
Lamp will exceed its  
lifetime after (hours):

Please replace the lamp!

# Replacing the Lamp (Contact your BenQ dealer for assistance)

**CAUTION:** The lamp may be very hot. Allow the projector to cool down for 45 minutes before replacing the lamp.

1. Loosen the screws on the front lamp cover.

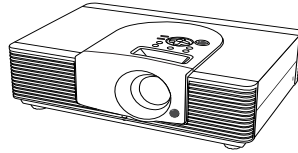

2. Remove the front lamp cover.

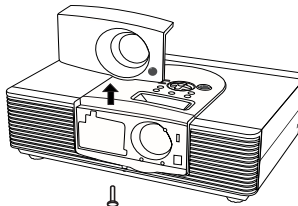

3. Loosen the three screws on the lamp shield.

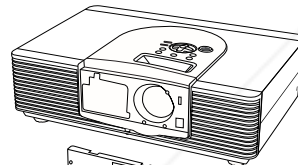

4. Take off the lamp shield.

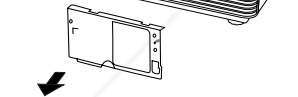

5. Loosen the three screws on the lamp module.

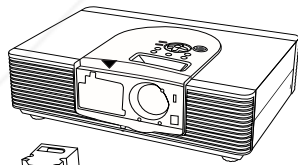

6. Pull out the lamp module horizontally.



**⚠ Pulling it too quickly may cause broken glass to scatter about if the bulb has broken.**

**⚠ Do not place the lamp in locations where water might splash on it, children can reach it, or near flammable materials.**

**⚠ Do not insert your hands into the box after the lamp is removed. If you touch the optical component inside, it could cause color unevenness and distortion of the projected images.**

7. Insert the new lamp module into the projector horizontally until it is securely in place.

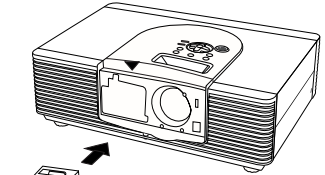

8. Tighten the two screws on the lamp module.

9. Put on the lamp shield.

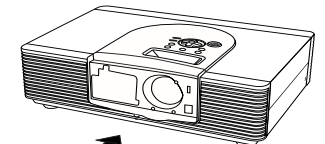

10. Tighten the three screws on the lamp shield.

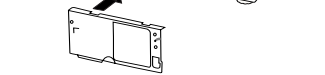

11. Put on the front lamp cover.

12. Tighten the screws on front lamp cover.

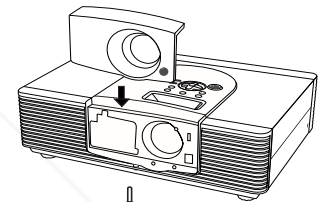

**⚠ Loose screws may cause a bad connection, which could result in malfunction.**

**⚠ Do not over tighten the screws.**

13. Turn the power on and go into Environment menu to reset the "Lamp Timer" item.

- Power will not turn on while the lamp cover is off.



Sponsored by DLP

## Resetting the lamp counter

14. On the control panel, simultaneously press and hold the ▲, ▼, and ⏻ POWER buttons for at least 3 seconds.

- Once the lamp life exceeds 1,500 hours, the lamp will not light, even after you replace it. The lamp counter must be reset as soon as a new lamp is installed.
- Do not reset the lamp life without replacing the lamp.

Discount-Merchant.com (800) 281-8860  
THE TRUSTED SOURCE FOR PROJECTOR LAMPS AND ACCESSORIES



# Indicators

There are three indicators which show the status of the projector. Check the following for information about the indicator lights. If there is anything wrong, turn the projector off and contact your dealer.

## When the projector is in a normal state, ...

| POWER (Green)  | POWER (Orange)  | LAMP | STATE                  | REMARK                         |
|----------------|-----------------|------|------------------------|--------------------------------|
| Green          | Orange          | Red  | Initial the projector. | Cannot accept any commands.    |
| Off            | Orange          | Off  | Standby mode.          |                                |
| Off            | Flashing Orange |      | Lamp is warming up.    | Cannot turn the projector off. |
| Green          | Off             |      | Power on.              |                                |
| Flashing Green | Off             |      | Lamp is cooling down.  | Cannot turn the projector on.  |

## When the projector is in an abnormal state, ...

| POWER (Green)  | POWER (Orange)  | LAMP (Red)                        | STATE                                                                                                                                                                                                                                                                         | REMARK                                                                                                                                                                                                                                                                                                                     |
|----------------|-----------------|-----------------------------------|-------------------------------------------------------------------------------------------------------------------------------------------------------------------------------------------------------------------------------------------------------------------------------|----------------------------------------------------------------------------------------------------------------------------------------------------------------------------------------------------------------------------------------------------------------------------------------------------------------------------|
| Green          | Off             | Flashing red three times in a row | <p>The internal temperature is too high.</p> <ul style="list-style-type: none"> <li>The intake ventilation or the exhaust ventilation is blocked.</li> <li>The projector may be in a poorly ventilated location.</li> <li>The ambient temperature may be too high.</li> </ul> | <p>Solution:</p> <ul style="list-style-type: none"> <li>Make sure that the ventilation holes are not blocked.</li> <li>Relocate the projector.</li> <li>Stop using the projector until the ambient temperature falls within the specified range. The maximum operating temperature is specified as 35°C / 95°F.</li> </ul> |
|                | Off             | Flashing red two times in a row   | The fans are not working.                                                                                                                                                                                                                                                     | <p>Solution:</p> <ul style="list-style-type: none"> <li>Check if the power supply is stable.</li> <li>Check if there is object stuck in the fans.</li> <li>Contact your dealer.</li> </ul>                                                                                                                                 |
|                | Off             | Red                               | The projection is damaged.                                                                                                                                                                                                                                                    | Contact your dealer.                                                                                                                                                                                                                                                                                                       |
| Flashing Green | Flashing Orange | Off                               | Almost time to to replace the lamp. The lamp has been used for 2000 hours. (The power is on.)                                                                                                                                                                                 | <p>Solution:</p> <ul style="list-style-type: none"> <li>Install a new lamp.</li> </ul>                                                                                                                                                                                                                                     |
| Green          | Orange          | Flashing Red                      | The lamp is too hot to turn the projector on.                                                                                                                                                                                                                                 | <p>Solution:</p> <ul style="list-style-type: none"> <li>Wait for 3 minutes to cool down the projector. You can restart the projector when it is back to standby mode.</li> </ul>                                                                                                                                           |

# Troubleshooting

| Problem                                                             | Cause                                                                                            | Remedy                                                                                                                                                                                    |
|---------------------------------------------------------------------|--------------------------------------------------------------------------------------------------|-------------------------------------------------------------------------------------------------------------------------------------------------------------------------------------------|
| <b>The projector does not turn on.</b>                              | There is no power from the power cable.                                                          | Plug the power cord into the AC inlet on the rear of the projector, and plug the power cord into to the power outlet. If the power outlet has a switch, make sure that it is switched on. |
|                                                                     | The power switch is not in the on position.                                                      | Put the power switch in the on position.                                                                                                                                                  |
|                                                                     | Attempting to turn the projector on again during the cooling process.                            | Wait until the cooling down process has completed.                                                                                                                                        |
|                                                                     | The front lamp cover is not securely attached.                                                   | Correctly attach the front lamp cover.                                                                                                                                                    |
| <b>No picture.</b>                                                  | The video source is not turned on or connected correctly.                                        | Turn the video source on and check that the signal cable is connected correctly.                                                                                                          |
|                                                                     | The projector is not correctly connected to the input source device.                             | Check the connection.                                                                                                                                                                     |
|                                                                     | The input signal has not been correctly selected.                                                | Select the correct input signal with the INPUT keys: Component 1, Component 2, DVI-D, DVI-A, Video and S-Video on the remote control.                                                     |
|                                                                     | The input signal has not been correctly selected in the "INPUT SOURCE" item in the DISPLAY menu. | Select the correct input signal.                                                                                                                                                          |
|                                                                     | POWER light or LAMP indicator light flashing.                                                    | Please contact your BenQ dealer for assistance.                                                                                                                                           |
| <b>Image is unstable.</b>                                           | The connection cables are not securely connected to the projector or the signal source.          | Correctly connect the cables to the appropriate terminals.                                                                                                                                |
| <b>Picture is blurred.</b>                                          | The projection lens is not correctly focused.                                                    | Adjust the focus of the lens using the focus ring.                                                                                                                                        |
|                                                                     | The projector and the screen are not aligned properly.                                           | Adjust the projection angle and direction as well as the height of this unit if necessary.                                                                                                |
|                                                                     | The lens cap is still attached to the lens                                                       | Remove the lens cap.                                                                                                                                                                      |
| <b>Remote control does not work correctly</b>                       | The batteries are out of power.                                                                  | Replace both of the batteries with new ones.                                                                                                                                              |
| <b>LAMP light flashes red.</b>                                      | The front lamp cover is not correctly attached.                                                  | Correctly attach the front lamp cover.                                                                                                                                                    |
|                                                                     | The cooling fan is not working properly.                                                         | Please contact your BenQ dealer for assistance.                                                                                                                                           |
|                                                                     | The temperature inside the projector is extremely high.                                          | Check that the ventilation holes are not blocked.                                                                                                                                         |
|                                                                     | The ambient temperature is too high (above 35°C / 95°F).                                         | Wait until the room cools down or move the projector to a cooler location.                                                                                                                |
| <b>POWER indicator light flashes orange and green sequentially.</b> | The lamp has exceeded its specified usage time.                                                  | Replace the lamp with a new one.                                                                                                                                                          |
|                                                                     | The lamp has burned out.                                                                         | Replace the lamp with a new one.                                                                                                                                                          |

# Specifications

 All specifications are subject to change without notice.

## Optical Characteristics

|                   |                                                        |
|-------------------|--------------------------------------------------------|
| Projection system | Single-chip DLP™ system.                               |
| DMD chip          | 0.64" DMD W_Pal (1024 x 576)                           |
| Contrast ratio    | 2000 : 1                                               |
| Lens              | 1.2-times zoom ratio, F/# 2.67 ~ 3.24, efl 23.4 ~ 28.3 |
| Focus distance    | 1.5m to 8m / 5.2ft to 26.2ft                           |
| Projection size   | 1.27m to 5.1m / 50 to 200 inches                       |
| Lamp              | 210W NSH                                               |

## Electrical Characteristics

|                               |                                              |
|-------------------------------|----------------------------------------------|
| Color system                  | NTSC3.58 — NTSC 4.43 — SECAM / PAL-M / PAL-N |
| Resolution                    | XGA, SVGA, VGA, 480p, 720p, 1080i            |
| Max. number of display colors | 16,770,000 colors (full color display)       |

## Input/Output

Video, S-Video, Component (Y/ CB/ CR)  
RS-232C (phone jack), DTV (Y/ PB/ PR), RGBHV, DVI, Trigger (mini-jack)

## General Characteristics

|                       |                                                            |
|-----------------------|------------------------------------------------------------|
| Dimensions            | 400mm x 347mm x 116mm (L x W x H)                          |
| Weight                | 16.7 lbs / 7.6 kg                                          |
| Power                 | VAC 100 - 240 Full-range switch (50/60Hz), 3 Wire Grounded |
| Power consumption     | Max 300 W                                                  |
| Operating temperature | 5°C to 35°C / 41°F to 95°F                                 |
| Operating humidity    | 10% - 90%                                                  |
| Storage temperature   | -10°C- 60°C / 14°F to 140°F                                |
| Storage humidity      | 10% - 90%                                                  |
| Keystone              | + 12° - -12°                                               |

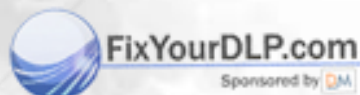

**Discount-Merchant.com (800) 281-8860**  
**THE TRUSTED SOURCE FOR PROJECTOR LAMPS AND ACCESSORIES**

# Dimensions

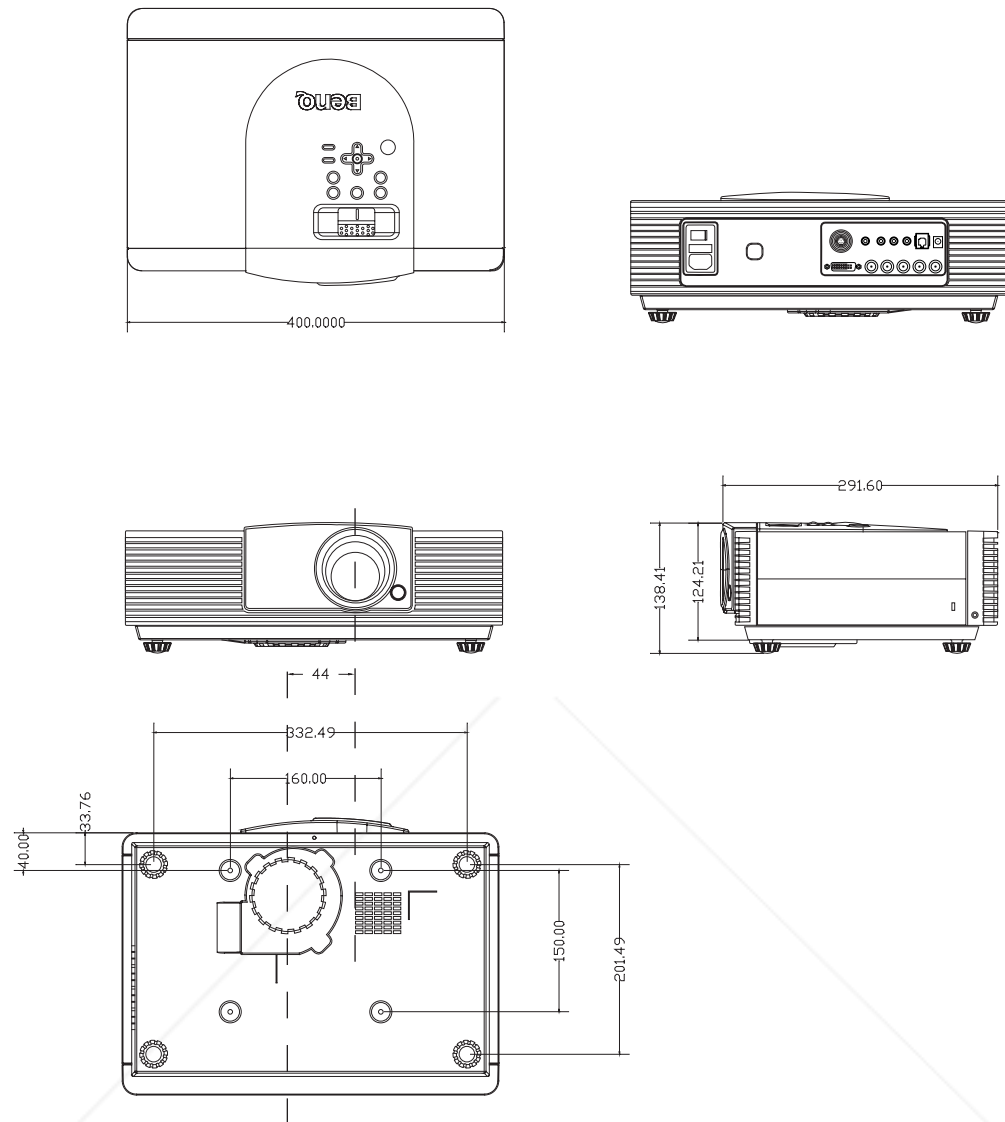

Unit: mm



# Disclaimer

This user manual is provided as a free service by FixYourDLP.com. FixYourDLP is in no way responsible for the content of this manual, nor do we guarantee its accuracy. FixYourDLP does not make any claim of copyright and all copyrights remain the property of their respective owners.

About FixYourDLP.com

FixYourDLP.com (<http://www.fixyourdlp.com>) is the World's #1 resource for media product news, reviews, do-it-yourself guides, and manuals.

Informational Blog: <http://www.fixyourdlp.com>

Video Guides: <http://www.fixyourdlp.com/guides>

User Forums: <http://www.fixyourdlp.com/forum>

FixYourDLP's Fight Against Counterfeit Lamps:

<http://www.fixyourdlp.com/counterfeits>

## Sponsors:

RecycleYourLamp.org – Free lamp recycling services for used lamps:

<http://www.recycleyourlamp.org>

Lamp Research - The trusted 3rd party lamp research company:

<http://www.lampresearch.com>

Discount-Merchant.com – The worlds largest lamp distributor:

<http://www.discount-merchant.com>



**FixYourDLP.com**

Sponsored by 