



Disclaimer

This user manual is provided as a free service by FixYourDLP.com. FixYourDLP is in no way responsible for the content of this manual, nor do we guarantee its accuracy. FixYourDLP does not make any claim of copyright and all copyrights remain the property of their respective owners.

About FixYourDLP.com

FixYourDLP.com (<http://www.fixyourdpl.com>) is the World's #1 resource for media product news, reviews, do-it-yourself guides, and manuals.

Informational Blog: <http://www.fixyourdpl.com>

Video Guides: <http://www.fixyourdpl.com/guides>

User Forums: <http://www.fixyourdpl.com/forum>

FixYourDLP's Fight Against Counterfeit Lamps:

<http://www.fixyourdpl.com/counterfeits>

Sponsors:

RecycleYourLamp.org – Free lamp recycling services for used lamps:

<http://www.recycleyourlamp.org>

Lamp Research - The trusted 3rd party lamp research company:

<http://www.lampresearch.com>

Discount-Merchant.com – The worlds largest lamp distributor:

<http://www.discount-merchant.com>



FixYourDLP.com

Sponsored by 

3M™ Super Close Projection System SCP712

Operator's Guide

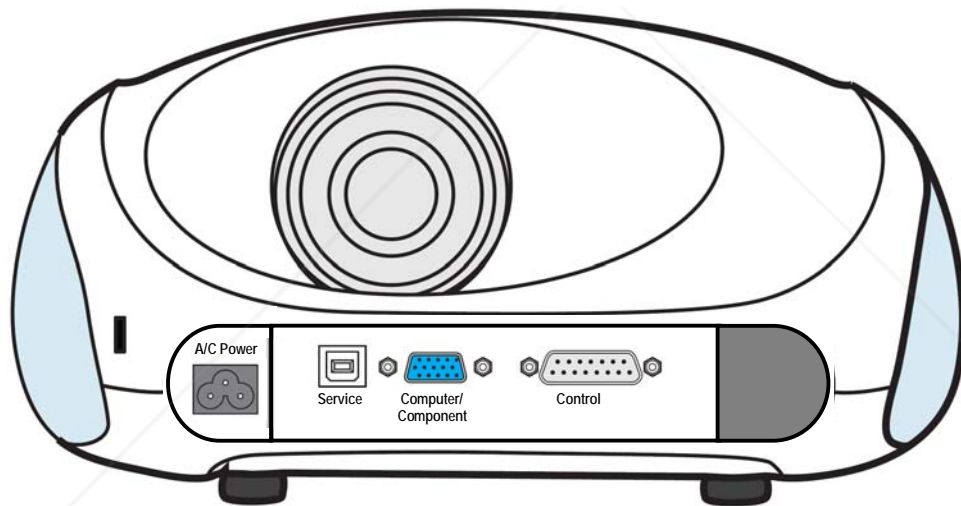

Discount-Merchant.com (800) 281-8860
THE TRUSTED SOURCE FOR PROJECTOR LAMPS AND ACCESSORIES

Table of Contents

INTRODUCTION	3
Thank you for choosing 3M equipment.....	3
Important Notice.....	3
Warranty; Limited Remedy; Limited Liability.....	3
Product Patents.....	3
Regulatory Notices.....	3
Safety Information	4
Contents of Shipping Box	6
Optional Accessories (not shown).....	6
Keep Your Packing Materials.....	6
What's Next?.....	6
Product Description	7
Machine Characteristics.....	7
Parts Identification.....	8
Terminal Connections.....	8
Terminal Connections.....	9
I/O Module Terminal Connections (optional accessory).....	9
Setup and System Configuration.....	10
Machine Specifications.....	11
Operating Instructions	12
Projector Start Up.....	12
Stand By Mode.....	12
Start Up.....	12
Menu Navigation.....	13
Main Menu.....	13
Input Menu.....	14
Picture Menu.....	15
Picture Menu – Advanced.....	16
Audio Menu (Displays only if I/O Module is connected).....	17
Setup Menu.....	18
Information Menu.....	19
Remote Control Functions.....	20
Maintenance	21
Installing or Replacing Batteries.....	21
Lamp Replacement.....	22
Troubleshooting	23
Common Problems and Solutions.....	23



Discount-Merchant.com (800) 281-8860
THE TRUSTED SOURCE FOR PROJECTOR LAMPS AND ACCESSORIES

INTRODUCTION

Thank you for choosing 3M equipment.

This product has been produced in accordance with 3M's quality and safety standards to provide smooth and trouble free use in the years to come. For optimum performance, please follow the operating instructions carefully. We hope you will enjoy using this high performance product in your classroom, meetings, presentations, and training sessions. This product is Class A and can not be sold into the home market.

The 3M logo and 3M are registered trademarks of 3M Company. Vikuiti is a trademark of 3M Company. Digital Light Processing is a trademark or registered trademark of Texas Instruments. All other trademarks or registered trademarks are property of their respective companies.

Important Notice

All statements, technical information, and recommendations related to 3M's products are based on information believed to be reliable, but the accuracy or completeness is not guaranteed. Before using this product, you must evaluate it and determine if it is suitable for your intended application. You assume all risks and liability associated with such use. Any statements related to the product which are not contained in 3M's current publications, or any contrary statements contained on your purchase order shall have no force or effect unless expressly set forth in a written agreement signed by an authorized officer of 3M.

Product Patents

This product is covered by one or more of the following patents:

U.S. Patent Number D555,184

U.S. Patent Number 7,123,426

U.S. Patent Number 7,126,767

U.S. Patent Number 7,271,964

Regulatory Notices

EEC STATEMENT: This machine was tested against the 89/336/EEC (European Economic Community) for EMC (Electro Magnetic Compatibility) and fulfills these requirements.

Video signal cables: Only use cables delivered by the manufacturer.



Discount-Merchant.com (800) 281-8860
THE TRUSTED SOURCE FOR PROJECTOR LAMPS AND ACCESSORIES

Safety Information

Please read, understand, and follow all safety information contained in these instructions prior to the use of this projector. Retain these instructions for future reference.

Intended Use

Before operating the machine, please read the entire manual thoroughly. This product was designed, built and tested for use indoors, using 3M lamps and hardware. The use of other replacement lamps, outdoor operation or different voltages has not been tested and could damage the projector or peripheral equipment and/or create a potentially unsafe operating condition.

This projector is designed to operate in a normal office/classroom environment.

- 5° to 35°C (41° to 95°F)
- 30-70% RH (without condensation)
- 0-2134m (0-7000 feet) above sea level

The ambient operating environment should be free of airborne smoke, grease, oil and other contaminants that can affect the operation or performance of the projector.

Use of this product in adverse conditions will void the product warranty.

Explanation of Signal Words and Symbols in Safety Labels and Instructions

WARNING: Indicates a potentially hazardous situation, which if not avoided, could result in death or serious injury and/or property damage.

CAUTION: Indicates a potentially hazardous situation, which if not avoided, may result in minor or moderate injury and/or property damage.



Warning: Hazardous Voltage



Warning: Hot Surface High Temperature Lamp



Attention: Read Accompanying Documentation



Discount-Merchant.com (800) 281-8860
THE TRUSTED SOURCE FOR PROJECTOR LAMPS AND ACCESSORIES

! WARNING

English

- **To reduce the risk associated with exposure to hazardous voltage:**
 - Do not remove any screws other than those specified in the lamp replacement instructions.
- **To reduce the risk associated with hazardous voltage:**
 - Do not operate this projector in wet environments or outdoors.
 - Do not modify this projector or power cord.
 - Do not attempt to service the projector; other than the lamp cartridge there are no user serviceable parts inside the projector.
 - Contact a 3M authorized service provider for service.
 - Disconnect power cord when the projector is not in use, during lamp replacement, and while cleaning.
 - Do not allow water or other liquids to enter the projector.
- **To reduce the risk associated with hazardous voltage and/or fire:**
 - Replace power cord if damaged.
 - Contact a 3M authorized service provider if the projector becomes damaged.
 - Use a grounded extension cord with a rating at least equal to that of the projector.
 - Connect this projector to a grounded outlet.
- **To reduce the risk associated with hot surface of lamp cartridge:**
 - Unplug the projector from the electrical outlet and allow the lamp to cool for 60 minutes before replacing the lamp.
- **To reduce the risk associated with choking:**
 - Keep the battery and battery cover away from children and pets.
- **To reduce the risk associated with environmental contamination due to mercury:**
 - Hg: Lamp contains mercury. Don't throw in trash. Dispose according to local, state, or federal laws. See www.lamprecycle.org or call 1-800-328-1371.
- **To reduce the risk associated with lamp rupture related hazards:**
 - In event of lamp rupture, call 3M authorized service provider for repair. Ruptured lamp repair is not user serviceable.
 - Wash your hands thoroughly if contact with ruptured lamp debris has taken place.
 - Ventilate the area where the lamp rupture occurs. The lamp operates at high temperature.
- **To reduce the risk associated with hazard voltage, and/or impact, and/or tripping, and/or intense visible light:**
 - Do not use this projector around unsupervised children.
- **To reduce the risk associated with sharps, premature lamp failure, exposure to mercury:**
 - Always handle the fragile lamp module with care.
 - Replace the lamp module when the lamp replacement message appears.
 - Never replace the lamp module with a previously used lamp module.

! CAUTION

- **To reduce the risk associated with intense visible light:**
 - Avoid looking directly into the projector lens while the lamp is on.
- **To reduce the risk associated with impact of a falling projector:**
 - Use only the 3M brand wall/ceiling mounting hardware kit if wall or ceiling mounting is desired.
 - Installation of the 3M brand wall/ceiling kit must only be performed by qualified personnel.
 - Adhere strictly to the proper installation procedure as outlined in the installation instructions when installing the 3M wall/ceiling kit.
 - Always operate the unit on a flat, sturdy, and horizontal surface.
- **To reduce the risk associated with explosion, and/or chemicals from leaking battery:**
 - Use only with battery type AAA.
 - Orient the battery's plus (+) and minus (-) terminals according to the markings found on the remote control.
 - Do not leave the battery in the remote for an extended period of time.
 - Do not heat, disassemble, short, recharge, or expose the batteries to fire or high temperature.
 - Do not carry batteries loose in your pocket or purse.
 - Avoid eye and skin contact in the event that battery would leak.
 - Do not mix used and new batteries.
- **To reduce the risk associated with tripping, and/or impact:**
 - Position the power cord and data cable so that they can not be tripped over.
- **To reduce the risk associated with environmental contamination due to battery chemicals:**
 - Dispose of exhausted batteries in accordance with applicable federal, state and local regulations.

SAVE THESE INSTRUCTIONS

Contents of Shipping Box

This projector is shipped with the necessary cables required for standard VCR, PC or laptop computer connections. Carefully unpack and verify that you have all of the items shown below. If any of these items are missing, please contact your place of purchase.

The shipping carton contains the following items illustrated below. If any of these items are missing, please contact your place of purchase.

1. SCP712 projector
2. Remote Control Transmitter (AAA batteries included)
3. VGA-cable 1.8M 15-Male
4. Power cord
5. Operator's Guide
6. USB 1.8m cable (not shown)

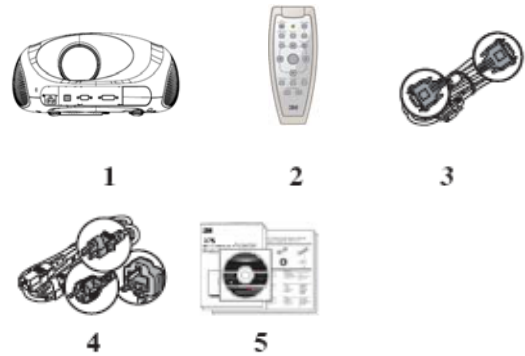

Optional Accessories (not shown)

1. Fixed Wall Mount
2. Folding Wall Mount
3. Folding Wall Mount with speakers
4. I/O Module
5. Annotation Pod
6. RS232 Adapter

Keep Your Packing Materials

Save the shipping box and packing materials in the event this product should require shipping to a 3M Service Center for repair. Use packing material to protect projector.

What's Next?

Take a few minutes to review the machine characteristics before you setup and operate the projector. We hope you will enjoy using this high performance product in your meetings, presentations and training sessions. This product has been produced in accordance with 3M's highest quality and safety standards to provide smooth and trouble-free use in the years to come.



Discount-Merchant.com (800) 281-8860
THE TRUSTED SOURCE FOR PROJECTOR LAMPS AND ACCESSORIES

Product Description

The 3M SCP712 integrates metal halide lamp and Digital Light Processing™ (DLP) technology. It accepts input from computer and/or video sources and projects a bright image.

Machine Characteristics

The 3M SCP712 offers the following features:

- Native Resolution 1024 x 768
- On-screen menu with 9 languages (English, French, Deutsch, Spanish, Italian, Japanese, Chinese Traditional, Chinese Simplified, Korean)
- Digital keystone correction
- Lamp Life of 2000 hours at 230W (Normal mode)
- Lamp Life of 3000 hours at 200W (ECO mode)



Discount-Merchant.com (800) 281-8860
THE TRUSTED SOURCE FOR PROJECTOR LAMPS AND ACCESSORIES

Parts Identification

1. Lens
2. Remote Control IR Sensor
3. Height Adjustment Feet
4. Power Cord Connection
5. Input Terminals
6. Slot for Kensington™ Lock
7. USB Port
8. Focus Adjustment
9. On/Off Standby

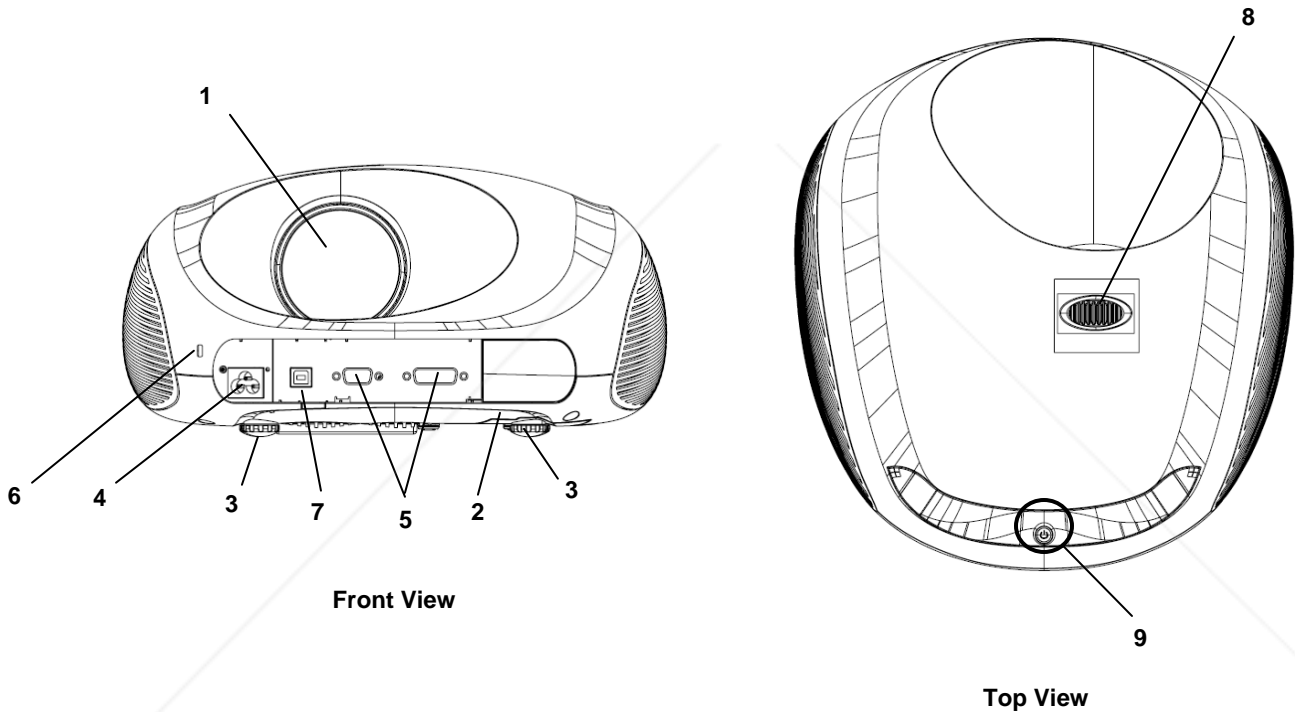

Terminal Connections

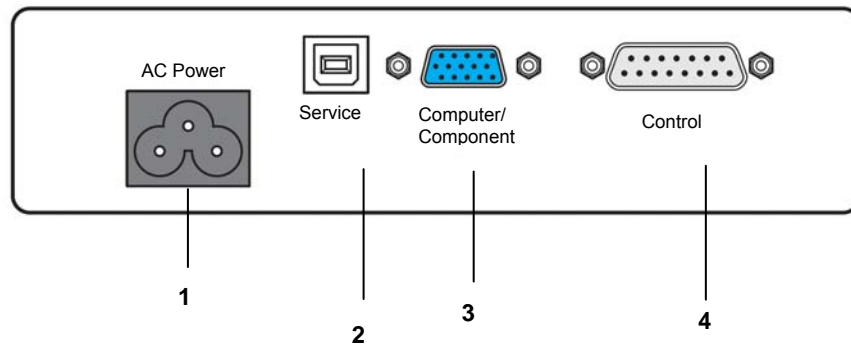

#	SCP712	Function
1	A/C Power	Connect AC power cord to projector.
2	USB Service	Connect projector USB (B-type) to computer USB port.
3	COMPUTER/COMPONENT	Input RGB signal from a computer.
4	CONTROL	Connect projector RS-232 control port to computer serial port.

I/O Module Terminal Connections (optional accessory)

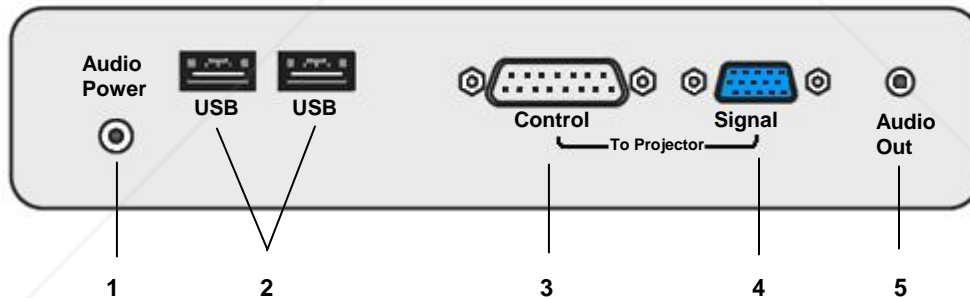

#	I/O Module	Function
1	Audio Power (Input)	Connect audio power cord to Audio Power terminal.
2	USB (2 ports)	Connect projector USB to computer USB port.
3	CONTROL	Connect IO/Module to projector CONTROL terminal.
4	Signal	Connect I/O Module to projector COMPUTER/COMPONENT port.
5	Audio Out	Connect IO/Module to external speakers.

FixYourDL.com
 Discount-Merchant.com (800) 281-8860
 THE TRUSTED SOURCE FOR PROJECTOR LAMPS AND ACCESSORIES

Setup and System Configuration

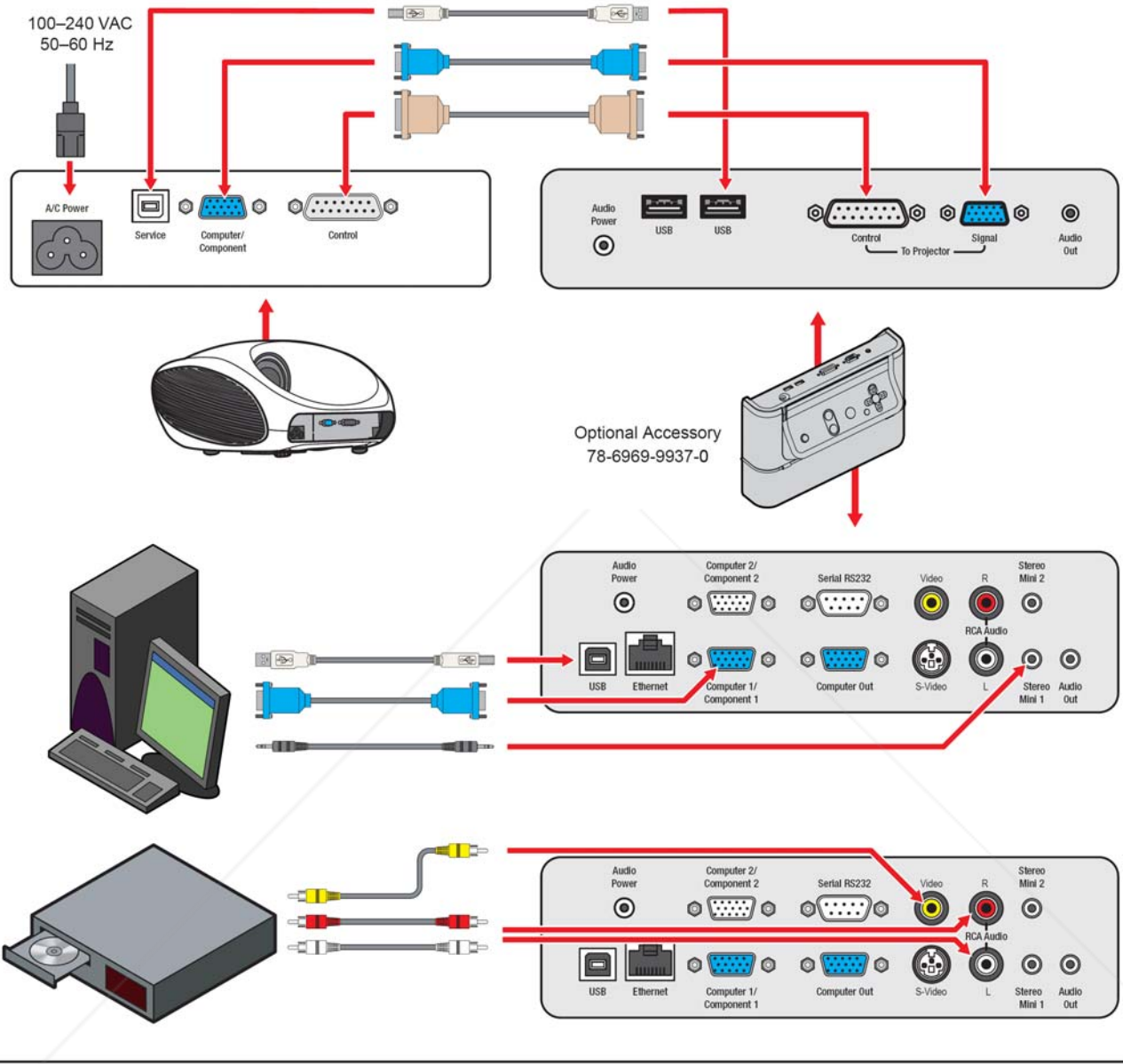

FixYourDLP.com
Sponsored by DM

Discount-Merchants.com (800) 281-8860
THE TRUSTED SOURCE FOR PROJECTOR LAMPS AND ACCESSORIES

Machine Specifications

Item	Specification
Acoustic Noise Level	Normal Mode: Typical 38 dB(A) ECO Mode: Typical 35 dB(A)
Auto Detect & Install	Automatically recognizes the connection of I/O module Automatically saves user adjustments
Computer Compatibility	Horizontal Sync: 15 – 82 kHz Vertical Sync: 50 – 85 Hz
Conditions for usage environment	Rel Humidity: 30% to 70%
	Altitude/Temperature 0-5000 ft. (with Fan Normal Mode) 5°C to 35°C 5000-7000 ft. (with Fan High Mode) 5°C to 35°C 7000-10000 ft. (with Fan High Mode) 5°C to 25°C
Dimensions	343.5 x 321.6 x 155.3 mm (13.5x 12.7 x 6.1 inches)
DMD Native Resolution	1024H x 768V (XGA)
Focus	Manual Adjustment
Input / Output Terminals	VGA (mini D-sub 15-pin) connector Control connector USB AC power outlet
Input rating	100-240V AC, 50-60 Hz, 4.0A
Lamp Life	2000 hrs at 230W Normal mode 3000 hrs at 200W ECO mode
Languages	English, French, Spanish, Deutsch, Italian, Japanese, Chinese Traditional, Chinese Simplified, Korean
Lens	Focal Length = 8.9mm
Power Consumption	310W normal operation, 5W standby mode
Video Compatibility	<u>NTSC</u> : M, N, 3.58Mz, 4.43 MHz <u>PAL</u> : B, D, G, H, I, M, N <u>SECAM</u>
Wall/Ceiling Mount capability	Three screw holes
Weight	4.14kg (9.2lbs)

Note: Designs and specifications are subject to change without notice.



Discount-Merchant.com (800) 281-8860
THE TRUSTED SOURCE FOR PROJECTOR LAMPS AND ACCESSORIES

Operating Instructions

Projector Start Up

Read the Important Safeguards before operating the SCP712. After all cable connections have been completed, the projector can be powered up.

For best results, please observe the following start up sequence.

1. Turn all of the connected equipment on.
2. Plug the supplied power cord into the AC inlet of the projector.
3. Press the **On/Standby** button on the projector or remote control. The lamp will turn on and an image will appear and grow brighter on the screen.
4. Check all ventilation slots and clear away any obstructions.
5. Raise/lower projector body to extend or retract feet to obtain best image height.
Note: *Rotate feet for fine adjustment.*
6. Turn the focus adjustment (top of projector) to obtain the best image sharpness.

Stand By Mode

When an image is not being projected, place the unit into standby mode.

1. Press the **On/Standby** button on the Remote Control. When the message "Press the power button to turn the unit off" displays, press the **On/Standby** button again.
2. The lamp will switch off and the power button will first turn red indicating the unit is in lockout and then after 90 seconds the button turns amber to indicate the unit is in standby mode.
Note: *In standby mode, the cooling fans will continue to run for 5 minutes and then turn off.*

Start Up

1. Press the **On/Standby** button on Remote Control again to illuminate the lamp and project an image on the screen.



Discount-Merchant.com (800) 281-8860
THE TRUSTED SOURCE FOR PROJECTOR LAMPS AND ACCESSORIES

Menu Navigation

To display the on screen menus, press the MENU button on the remote control. Use the remote control Up/Down ARROW buttons to select the desired menu (see table below), then pull the TRIGGER button (bottom of remote control) to display it.

Use the remote control ARROW buttons within a submenu to select the various options displayed on the screen, then pull the TRIGGER button to initiate that option or setting.

To exit an on-screen submenu, press the MENU button.

Main Menu

The main menu is the first system menu to display when the MENU button is pressed. Click on the menu icons to display the desired submenu.



Menu Icon	Menu Description
	Input Menu – Select the desired computer or video input source.
	Picture Menu – Adjust the following picture features: mode, brightness, contrast, color intensity, tint, sharpness, video noise reduction, aspect ratio, and menu reset. Note: <i>Displays only when input source is connected.</i>
 Advanced	Advanced Picture Menu – Adjust the following settings for the detected signal source: over scan, brightness/color, horizontal position, vertical position, frequency, phase, & menu reset.
	Audio Menu – Adjust the following audio settings: volume, mute, audio input (stereo mini-1, stereo mini-2, RCA), menu reset.
	Setup Menu – Select or adjust the following settings: menu languages, auto shutoff timer, keystone, lamp hours, lamp mode, fan mode, projection mode, factory reset, or menu reset.
	Information Menu – Display the current system information: input resolution, H/V frequency, lamp hours, system hours, IP address/net mask/gateway for I/O module Ethernet interface, user revision.

Input Menu

The Input Menu, shown below, is used to select the desired computer or video input source to be displayed on the projector.

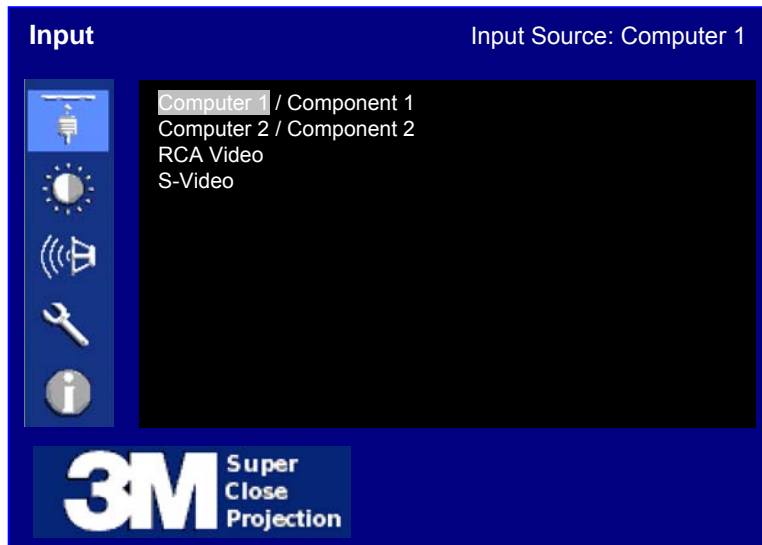

Feature	Description
Select input source	1. Computer 1 / Component 2
	2. Computer 2 / Component 2 [Displays only when I/O module is connected]
	3. RCA Video-Composite video [Displays only when I/O module is connected]
	4. S-Video [Displays only when I/O module is connected]



Discount-Merchant.com (800) 281-8860
THE TRUSTED SOURCE FOR PROJECTOR LAMPS AND ACCESSORIES

Picture Menu

The Picture Menu, shown below, is used to adjust the picture settings to display the best possible image.

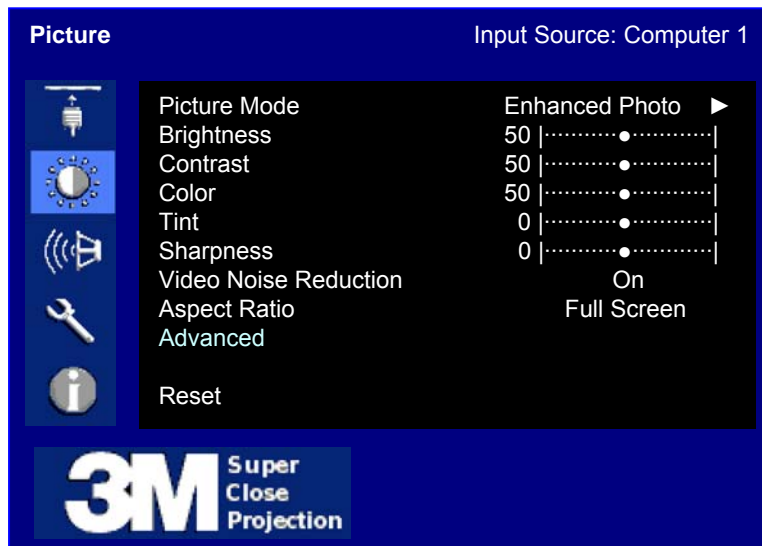

Feature	Description	Range	Default
Picture Mode	Select the best mode to optimize the projector image. 1. Max Brightness 2. Enhanced Photo 3. Photo 4. Enhanced	N/A	VGA-Max Brightness Video-Enhanced Photo
Brightness	Adjust brightness of displayed image	0–100	50
Contrast	Adjust the contrast (dark to light) in the displayed image	0–100	50
Color <i>(see Note)</i>	Adjust the intensity of color in the displayed image	0–100	50
Tint <i>(see Note)</i>	Adjust the balance of red to green for video signals.	-15–+15	0
Sharpness	Adjust the displayed image to look sharper or softer	-15–+15	0
Video Noise Reduction	Turn noise reduction ON or OFF	N/A	Off
Aspect Ratio	Set aspect ratio to: [Full Screen or 16:9 or Native]	N/A	Full Screen
Advanced	This option only displays for Computer2/Component2 input and when I/O Module is connected. See next page.	N/A	N/A
Reset	Reset values in Picture menu only	N/A	N/A

Note: Tint/Hue can only be adjusted for S-Video and RCA video input signals

FixYourDLP.com
Sponsored by 3M

Discount-Merchant.com (800) 281-8860
THE TRUSTED SOURCE FOR PROJECTOR LAMPS AND ACCESSORIES

Picture Menu – Advanced

The Picture Menu with the Advanced option selected, shown below, is used to adjust the projected image for Computer and Component inputs only.

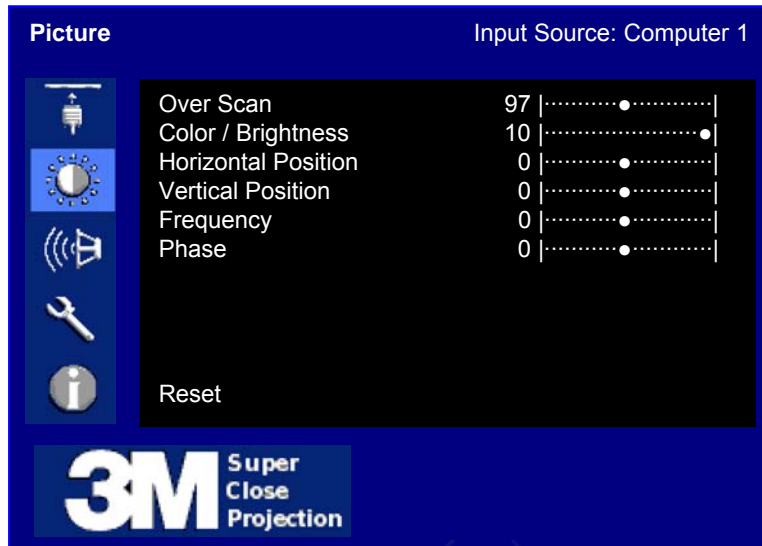

Feature	Description	Range	Default
Over Scan	Adjust cropping of image boundaries from 90 th to 100 th percentile (increments of 1 percent)	90–100	Video = 97 VGA = 100
Brightness / Color	Adjust the white peaking value of the DMD. (0 = lowest white peaking value, 10 = highest value)	0–10	Computer = 10 Video = 3
Horizontal Position	Adjust horizontal position of projected image (Only for Computer 1 or Computer 2 input source)	N/A	0
Vertical Position	Adjust vertical position of projected image (Only for Computer 1 or Computer 2 input source)	N/A	0
Frequency	Adjust the horizontal width of the projected image (Only for Computer 1 or Computer 2 input source)	-50–+50	0
Phase	Adjust clock phase to reduce image distortion (Only for Computer 1 or Computer 2 input source)	-15–+15	0
Reset	Reset values in Advanced Picture menu only	N/A	N/A



Discount-Merchant.com (800) 281-8860
THE TRUSTED SOURCE FOR PROJECTOR LAMPS AND ACCESSORIES

Audio Menu (Displays only if I/O Module is connected)

The Audio Menu, shown below, is used to adjust the audio settings and select the audio input source to play through the projector.

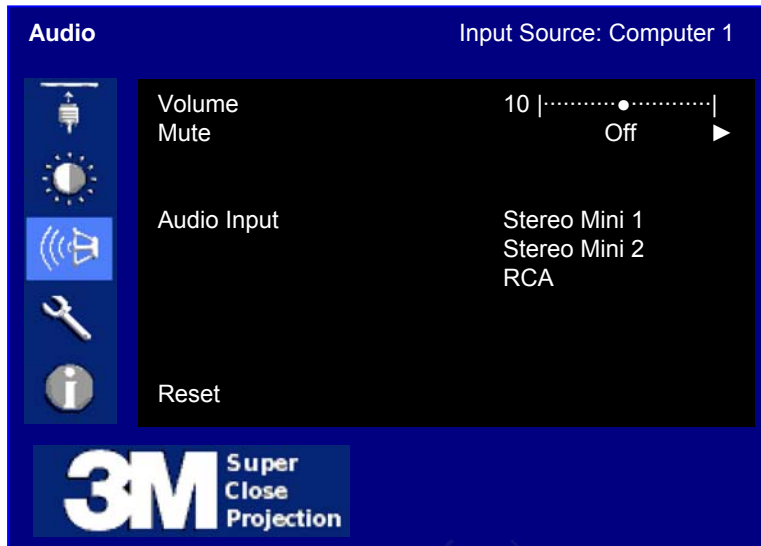

Feature	Description	Range	Default
Volume	Adjust volume level (0 = muted, 20 = full volume)	0–20	10
Mute	Turn mute mode ON and OFF	N/A	OFF
Audio Input	Select the audio input source to process. Stereo Mini 1 – VGA/Component Stereo Mini 2 – VGA2/Component RCA – S-Video/Component		PC
Reset	Reset values in Advanced Picture menu only	N/A	N/A



Discount-Merchant.com (800) 281-8860
THE TRUSTED SOURCE FOR PROJECTOR LAMPS AND ACCESSORIES

Setup Menu

The Setup Menu, shown below, is used to configure the basic projector operating parameters.

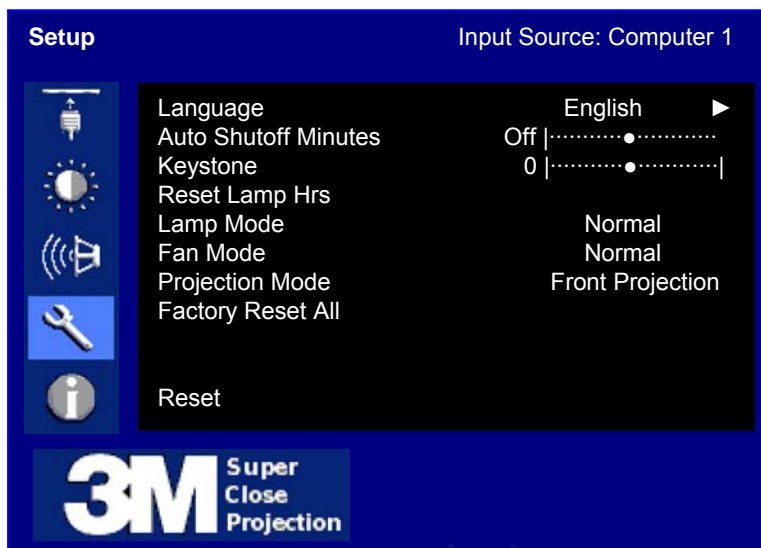

Feature	Description	Range	Default
Language	Select the language for menu displays [English, French, Spanish, Deutsch, Italian, Japanese, Mandarin Traditional, Mandarin Simplified, Korean]	N/A	English
Auto Shutoff	Set the number of idle minutes (no input source detected and no commands issued) before the projector will automatically shut off.	0–60	10
Keystone	Vertical keystone adjustment. Stereo Mini 1 – VGA/Component Stereo Mini 2 – VGA2/Component RCA – S-Video/Component	-15--+15	0
Reset Lamp Hours	Reset lamp hours status indicator. See Information Menu.	N/A	N/A
Lamp Mode	Normal, ECO	N/A	Normal
Fan Mode	Normal, High	N/A	Normal
Projection Mode	Front, Rear, Front Ceiling, Rear Ceiling	N/A	Front
Factory Reset	Reset all menu items to FACTORY DEFAULT settings	N/A	N/A
Reset	Reset values in Setup menu only	N/A	N/A



Discount-Merchant.com (800) 281-8860
THE TRUSTED SOURCE FOR PROJECTOR LAMPS AND ACCESSORIES

Information Menu

The Information Menu, shown below, is used to display current projector configuration settings.

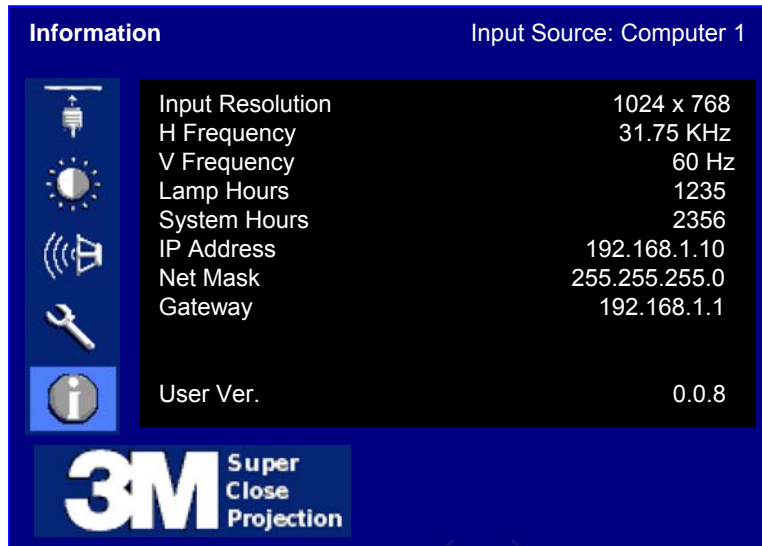

Feature	Description
Input Resolution	Displays the current input Resolution
H Frequency	Displays the current input H-Frequency
V Frequency	Displays the current input V-Frequency
Lamp Hours	Displays the current lamp operating hours for the installed lamp
System Hours	Displays the current total system time accumulated
IP Address <i>(see note)</i>	Displays the current IP Address for the I/O module Ethernet interface
Net Mask <i>(see note)</i>	Displays the current Net Mask for the I/O module Ethernet interface
Gateway <i>(see note)</i>	Displays the current gateway for the I/O module Ethernet interface
User Revision	Displays the current User Version

Note: This field displays only when the I/O Module is connected.



Discount-Merchant.com (800) 281-8860
THE TRUSTED SOURCE FOR PROJECTOR LAMPS AND ACCESSORIES

Remote Control Functions

Aim the remote control toward the projection screen or at the sensor. Press desired remote control button to send a signal to the projector.

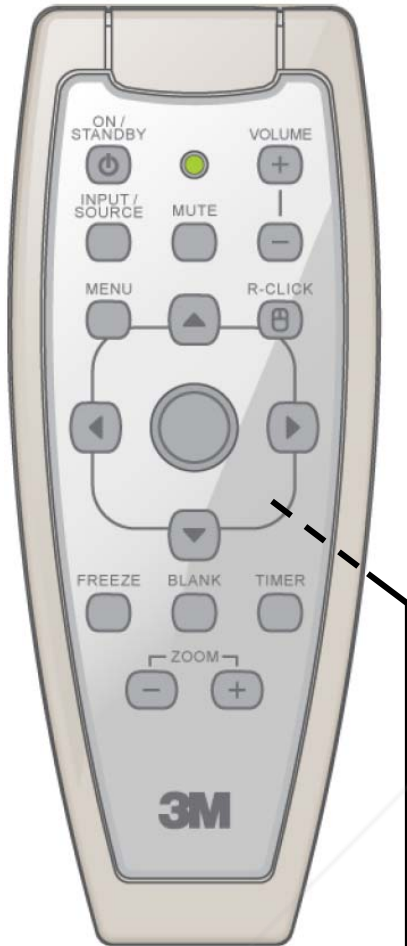

ON/ STANDBY	Press to enter Standby mode. Note: A confirmation message will display to ensure unit does not get turned off accidentally.
INPUT/ SOURCE	Press and press again to select different computer and video inputs. [Computer 1/Componet 1 → Computer 2/Componet 2 → RCA Composite Video → S-Video]
Volume +:	Press to increase speaker volume.
Volume -:	Press to decrease speaker volume.
Mute:	Press to switch the audio sound ON or OFF.
Menu:	Press to display the Main Menu. When a menu is open, press to exit menu.
R/Click	Performs remote Right Mouse click function.
Up Arrow	Moves cursor upward through menu items.
Down Arrow	Moves cursor downward through menu items.
Left Arrow	Moves cursor left through menu items. Moves .ppt slides backwards.
Right Arrow	Moves cursor to right through menu items. Moves .ppt slides forward.
Mouse Pad	Allows remote mouse functions. Pan function when in Magnify mode.
Blank:	Press to replace projected image with black image. Press again to return projection image.
Freeze:	Press to freeze current image. Press again to return to active image.
Timer:	Press to initiate a 10 minute digital timer. Change timer by pressing up/down arrows to alter amount in 1 minute intervals.
Zoom +:	Press and hold to increase the size of the displayed image up to 200 percent.
Zoom -:	Press and hold to decrease size of the displayed image down to 100 percent
Bottom Trigger	Pull trigger for remote LEFT mouse button functions. In menu mode, use for remote Enter / Select functions.

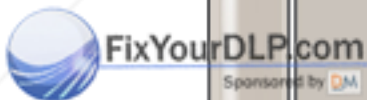

Discount-Merchant.com (800) 281-8860
THE TRUSTED SOURCE FOR PROJECTOR LAMPS AND ACCESSORIES

Maintenance

Installing or Replacing Batteries

1. Push on the cover and slide it upward to unlatch it.
2. Remove the cover.
3. Install two AAA batteries with the correct polarities and then replace the cover. Slide it downward until it locks into place.

Note: Verify the battery cover is fully latched before using the remote control.

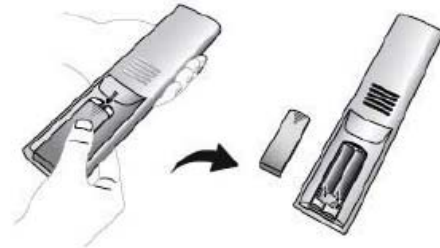

Installing Batteries



Discount-Merchant.com (800) 281-8860
THE TRUSTED SOURCE FOR PROJECTOR LAMPS AND ACCESSORIES

Lamp Replacement

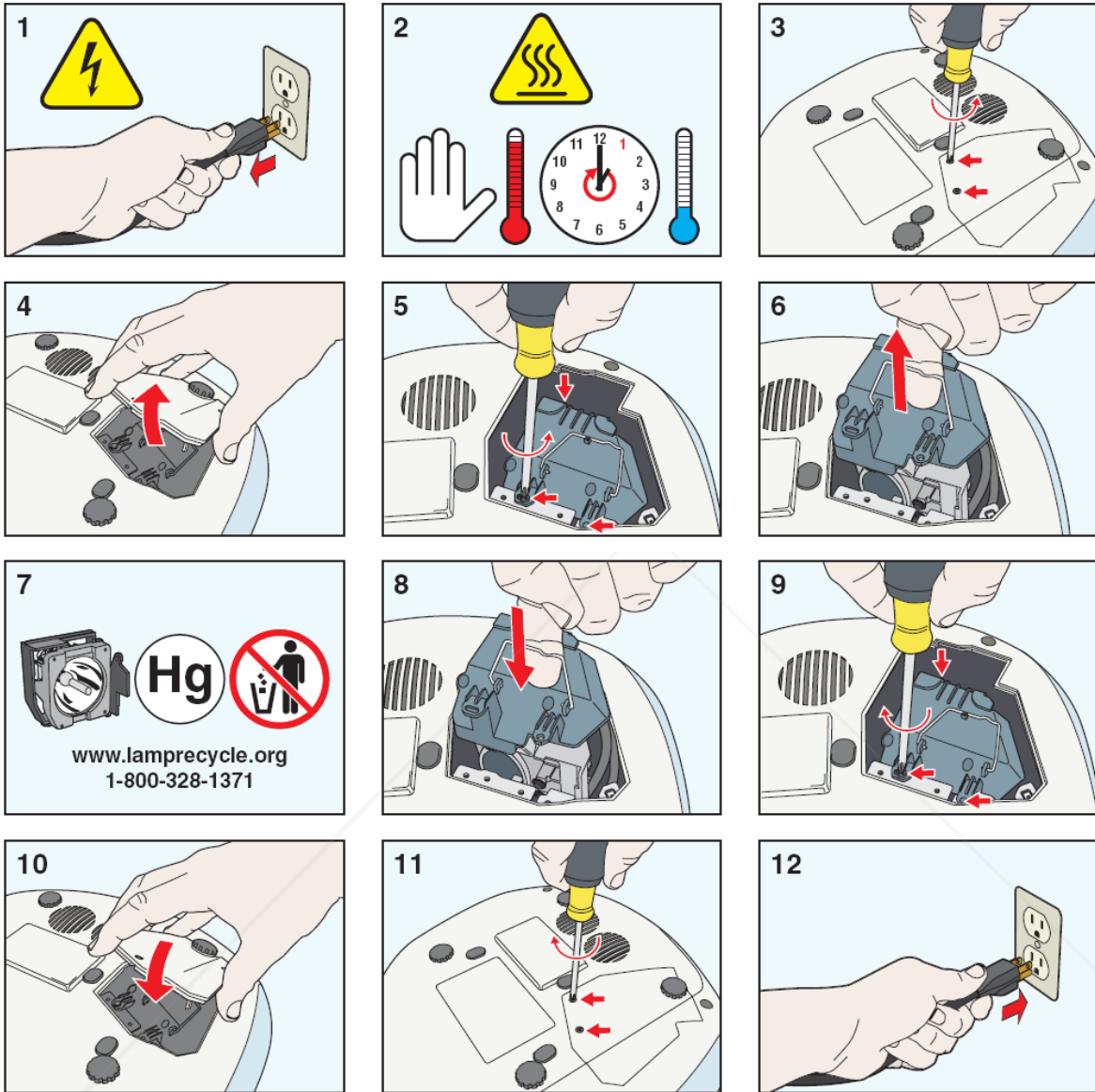

 FixYourDLP.com
Sponsored by 

Discount-Merchant.com (800) 281-8860
THE TRUSTED SOURCE FOR PROJECTOR LAMPS AND ACCESSORIES

Troubleshooting

Common Problems and Solutions		
Symptom	Cause	Solution
No power.	The power cord is disconnected.	Insert the power cord into AC socket.
No picture or sound.	The desired input source is not selected.	Press the remote control Input button to select a desired input source.
	The cables from the input source are not connected.	Connect the cable to correct input source.
	The input source is not turned on or not displaying an image. (e.g. If a notebook computer, the external monitor port is not turned on).	Turn on input source.
The lamp will not ignite or has turned off.	The internal temperature is too high.	Check exhaust for obstructions.
	The lamp has reached maximum life or has prematurely failed.	Replace lamp.
Sound is heard with no picture.	The VGA/Video cables are not connected.	Connect the cables to the correct input source.
	The VGA/Video/Audio cables are connected to the wrong input.	Change Input Menu to correct video input setting.
Picture is displayed with no sound	The audio cables are connected to the wrong input.	Connect the cables to the correct input source.
	Check the audio/video configuration.	Set proper configuration through the menu.
	The volume is set to Minimum.	Turn up Volume.
	The Mute is on.	Turn off Mute.
Picture is dark or dim.	The brightness setting is too low.	Adjust the brightness
	The lamp needs to be replaced.	Replace lamp.
Desired input source cannot be detected.	The input source is not active. A signal must be present for the input to be selected.	Connect an active input source to unit.
	The input device (e.g. computer, DVD player, etc.) is not turned on.	Turn on input source.
The remote control does not work.	The remote control is not facing the remote control sensor.	Face the remote control toward the remote control sensor.
	The remote control is too far from the sensor.	Operate the remote control within 5 meters.
	An obstruction is between the remote control and the sensor.	Remove obstacle.
	The remote control's batteries are exhausted or inserted wrong.	Correctly insert batteries.



Discount-Merchant.com (800) 281-8860
THE TRUSTED SOURCE FOR PROJECTOR LAMPS AND ACCESSORIES

Technical Support Contact:

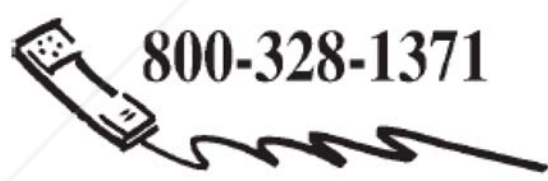

800-328-1371



**<http://www.3m.com/meetings>
e-mail: meetings@mmm.com**



Discount-Merchant.com (800) 281-8860
THE TRUSTED SOURCE FOR PROJECTOR LAMPS AND ACCESSORIES

3M Austin Center
Building A147-5N-01
6801 River Place Blvd.
Austin, TX 78726-9000

3M Canada
P.O. box 5757
London, Ontario
N6A 4T1

3M Mexico, S.a. de C.V
Apartado Postal 14-139
Mexico, D.F. 07000
Mexico

3M Europe
Boulevard de l'Oise
95006 Cerge Pontoise Cedex
France

Please recycle.
Litho in USA
©3M 2008. All Rights Reserved.
78-6971-1389-8 (6/2008)



Disclaimer

This user manual is provided as a free service by FixYourDLP.com. FixYourDLP is in no way responsible for the content of this manual, nor do we guarantee its accuracy. FixYourDLP does not make any claim of copyright and all copyrights remain the property of their respective owners.

About FixYourDLP.com

FixYourDLP.com (<http://www.fixyourdpl.com>) is the World's #1 resource for media product news, reviews, do-it-yourself guides, and manuals.

Informational Blog: <http://www.fixyourdpl.com>

Video Guides: <http://www.fixyourdpl.com/guides>

User Forums: <http://www.fixyourdpl.com/forum>

FixYourDLP's Fight Against Counterfeit Lamps:

<http://www.fixyourdpl.com/counterfeits>

Sponsors:

RecycleYourLamp.org – Free lamp recycling services for used lamps:

<http://www.recycleyourlamp.org>

Lamp Research - The trusted 3rd party lamp research company:

<http://www.lampresearch.com>

Discount-Merchant.com – The worlds largest lamp distributor:

<http://www.discount-merchant.com>



FixYourDLP.com

Sponsored by 