



Disclaimer

This user manual is provided as a free service by FixYourDLP.com. FixYourDLP is in no way responsible for the content of this manual, nor do we guarantee its accuracy. FixYourDLP does not make any claim of copyright and all copyrights remain the property of their respective owners.

About FixYourDLP.com

FixYourDLP.com (<http://www.fixyourdpl.com>) is the World's #1 resource for media product news, reviews, do-it-yourself guides, and manuals.

Informational Blog: <http://www.fixyourdpl.com>

Video Guides: <http://www.fixyourdpl.com/guides>

User Forums: <http://www.fixyourdpl.com/forum>

FixYourDLP's Fight Against Counterfeit Lamps:

<http://www.fixyourdpl.com/counterfeits>

Sponsors:

RecycleYourLamp.org – Free lamp recycling services for used lamps:

<http://www.recycleyourlamp.org>

Lamp Research - The trusted 3rd party lamp research company:

<http://www.lampresearch.com>

Discount-Merchant.com – The worlds largest lamp distributor:

<http://www.discount-merchant.com>



FixYourDLP.com

Sponsored by 

3M

MP8620 Multimedia Projector Operator's Guide

Projecteur multimédia MP8620 Guide d'utilisation

MP8620 Multimedia-Projektor Bedienerhandbuch

Proyector de medios múltiples (multimedia) MP8620 Guía del operador

Guida dell'operatore del proiettore multimediale MP8620

Bruksanvisning för MP8620 Multimediaprojektor

3M MP8620 Multimediaprojector Gebruiksaanwijzing

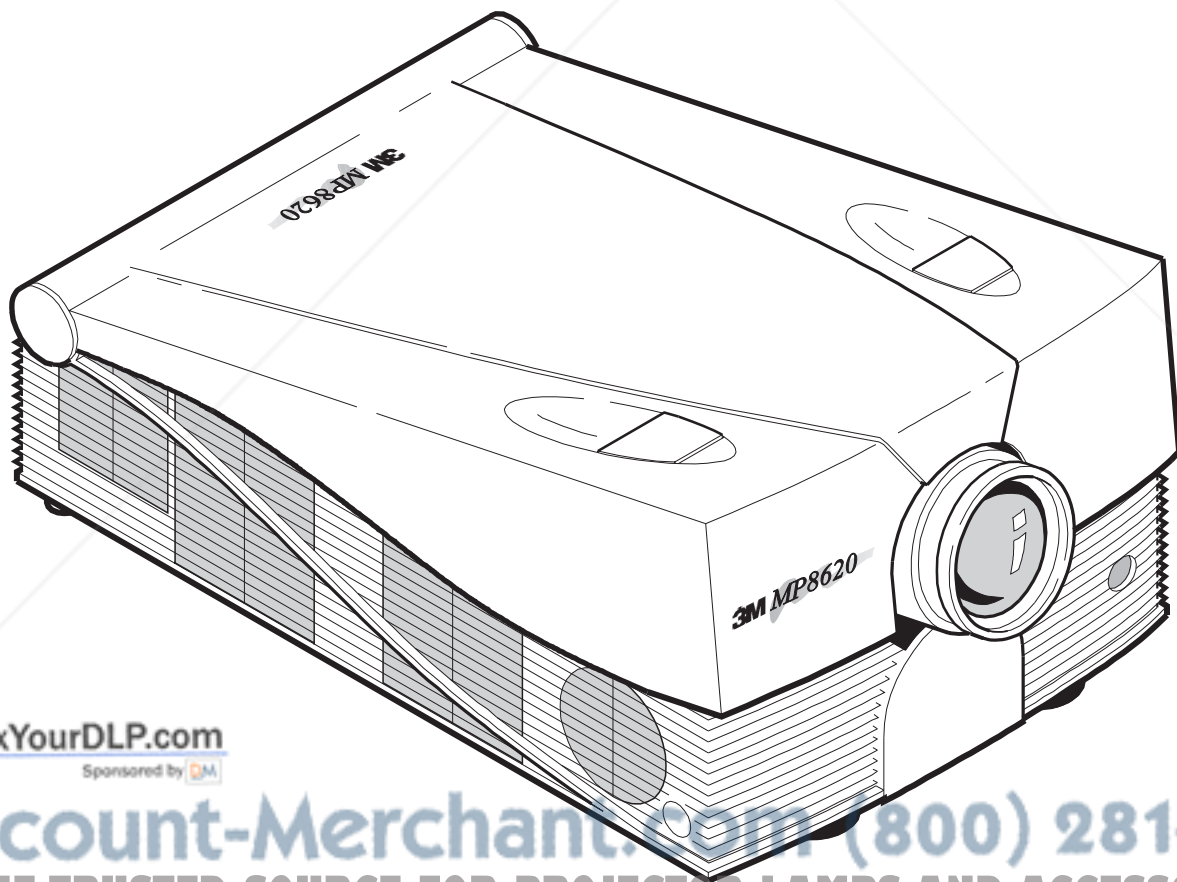

 FixYourDLP.com
Sponsored by 

Discount-Merchant.com (800) 281-8860

THE TRUSTED SOURCE FOR PROJECTOR LAMPS AND ACCESSORIES





INTENDED USE



Before operating the machine, please read the entire manual thoroughly. The 3M™ Multimedia Projector MP8620 was designed, built and tested for use indoors, using 3M™ brand lamps and nominal local voltages. The use of other replacement lamps, outdoor operation or different voltages has not been tested and could damage the projector or peripheral equipment and/or create a potentially unsafe operating condition.

IMPORTANT SAFEGUARDS

1. Read and understand all instructions before using. Pay particular attention to areas where this symbol  is shown.

 **WARNING** - Indicates a potentially hazardous situation which, if not avoided, could result in death or serious injury.

 **Caution** - Indicates a potentially hazardous situation which, if not avoided, could result in minor or moderate injury. It may also be used to alert against unsafe practices.

2. Close supervision is necessary when any appliance is used by or near children. Do not leave appliance unattended while in use.
3. Never look directly into the projector lens when the lamp is on. The metal halide lamp produces a strong light which could damage your eyesight.
-  4. Care must be taken as burns can occur from touching hot parts.
5. Do not operate appliance with a damaged cord or if the appliance has been dropped or damaged — until it has been examined by a qualified service technician.
-  6. Position the cord so that it will not be tripped over, pulled or contact hot surfaces.
7. If an extension cord is necessary, a cord with an earth/ground and a current rating at least equal to that of the appliance should be used. Cords rated for less amperage than the appliance may overheat.
8. Always unplug appliance from electrical outlet before cleaning and servicing and when not in use. Grasp plug and pull to disconnect.
9. To reduce the risk of electric shock, do not immerse this appliance in water or other liquids.
10. To reduce the risk of electric shock, do not disassemble this appliance, but take it to a qualified technician when service or repair work is required. Incorrect reassembly can cause electric shock when the appliance is subsequently used.
11. The use of an accessory attachment not recommended by the manufacturer may cause a risk of fire, electric shock, or injury to persons.
12. Connect this appliance to a grounded outlet.
-  13. This unit is equipped with optical lenses and should not be exposed to direct sunlight.
14. Keep ventilation openings free of any obstructions.
15. Use caution not to pinch fingers when folding projector into closed position.

SAVE THESE INSTRUCTIONS

The information contained in this manual will help you operate and maintain your 3M MP8620 Multimedia Projector.



Warranty

Thank you for choosing 3M multimedia projection equipment. This product has been produced in accordance with 3M's highest quality and safety standards to ensure smooth and trouble-free use in the years to come.

For optimum performance, please follow the operating instructions carefully. We hope you will enjoy using this high performance product in your meetings, presentations and training sessions.

LIMITED WARRANTY

3M warrants this product against any defects in material and workmanship, under normal use and storage, for a period of one year from date of purchase. Proof of purchase date will be required with any warranty claim. In the event this product is found to be defective within the warranty period, 3M's only obligation and your exclusive remedy shall be replacement of any defective parts (labor included).

To obtain warranty service, immediately notify the dealer from which you purchased the product of any defects. In the USA call 1-800-328-1371 for warranty or repair service.

LIMITATION OF LIABILITY

THE FOREGOING WARRANTY IS MADE IN LIEU OF ALL OTHER WARRANTIES, EXPRESSED OR IMPLIED, AND 3M SPECIFICALLY DISCLAIMS ANY IMPLIED WARRANTY OF MERCHANTABILITY AND FITNESS FOR A PARTICULAR PURPOSE. 3M SHALL NOT BE LIABLE FOR ANY DAMAGES, DIRECT, CONSEQUENTIAL, OR INCIDENTAL, ARISING OUT OF THE USE OR INABILITY TO USE THIS PRODUCT.

Important: The above warranty shall be void if the customer fails to operate product in accordance with 3M's written instructions. This warranty gives you specific legal rights and you may have other rights which vary from state to state.

FCC STATEMENT - CLASS A: This equipment generates, uses and can radiate radio frequency energy, and if not installed and used in accordance with the instruction manual may cause interference to radio communications. It has been tested and found to comply with the limits for a Class "A" computing device pursuant to Subpart B of Part 15 of the FCC Rules, which are designed to provide reasonable protection against such interference when operated in a commercial environment. Operation of this equipment in a residential area is likely to cause interference in which case the user at his/her own expense will be required to take whatever measures may be required to correct the interference.

EEC STATEMENT: This machine was tested against the 89/336/EEC (European Economic Community) for EMC (Electro Magnetic Compatibility) and fulfills these requirements.

Video signal cables: Only use cables delivered by the manufacturer.

Video inputs: The input signal amplitude must not exceed the specified level. See Appendix A-1.

IBM and PS/2 are registered trademarks of **International Business Machines Corporation**. **Apple Macintosh** and **ADB** are registered trademarks of **Apple Computer, Inc.** **Microsoft Windows** is a trademark of the Microsoft Corporation. All other products are trademarks or registered trademarks of their respective companies.

THE TRUSTED SOURCE FOR PROJECTOR LAMPS AND ACCESSORIES



Section 1: Unpack

1-1. Contents of Shipping Box

The 3M™ Multimedia Projector MP8620 is shipped with the necessary cables required for standard VCR, PC or laptop computer connections. Carefully unpack and verify that you have all of the items shown below.

✓ Note

A set of cables for connection to Apple Macintosh is available as an option. See Appendix D-1.

1-2. Inventory List

The shipping carton contains the following items illustrated in Figure 1–1. If any of these items are missing, please contact your place of purchase.

- | | |
|--|----------------------------------|
| 1. MP8620 Multimedia Projector | 6. PS/2 mouse adapter |
| 2. Remote control transmitter
(AAA batteries included) | 7. Audio cable (RCA–mini jack) |
| 3. VGA cable 15-15 pin male to male | 8. S-video cable |
| 4. Mouse cable (9–9 pin female to female) | 9. RCA video cable |
| 5. Power cord set (U.S., UK, European)
For special power cords see Appendix D-3 | 10. Soft case |
| | 11. Operator's Guide (not shown) |

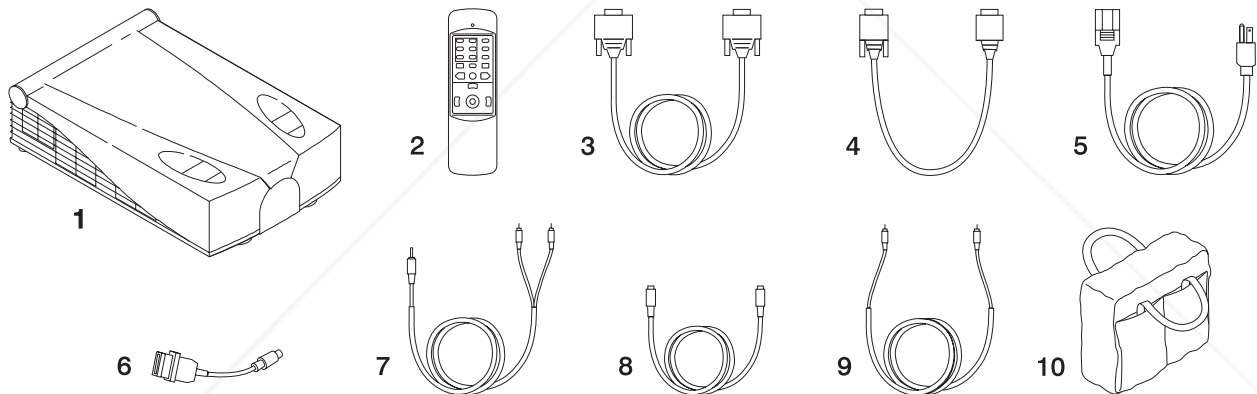

Figure 1-1. Inventory of Shipping Box

1-3. Keep Your Packing Materials

Save the shipping box and packing materials in the event the MP8620 should require shipping to a 3M Service Center for repair. *Close and lock projector in travel position and use packing material to protect projector. Do not ship in soft case alone.*

1-4. What's Next?

After you have unpacked the MP8620 system and identified all the parts, you are ready to set up the projector.

Take a few minutes to review Section 2 to familiarize yourself with the MP8620 machine characteristics and then turn to Section 3 to set up the projector.



Section 2: Product Description

2-1. Machine Characteristics

The 3M™ Multimedia Projector MP8620 integrates metal halide lamp and single amorphous silicon TFT LCD technology into an ultra portable unit that fits into a briefcase. It accepts input from a computer source and two video/audio sources and projects a bright super crisp image with perfect color convergence.

The MP8620 Multimedia Projector offers the following features:

- Easy to set up and use
- Extremely portable (folds and fits inside a briefcase)
- Metal halide projection lamp 400W
- High brightness lamp output (*see note*)
- SVGA (800 x 600) resolution
- XGA (1024 x 768) compression
- VGA (640 x 480) expansion
- NTSC, PAL, SECAM S-VHS video
- Ability to display 16.7 million colors
- One computer input connection
- Built-in MS, PS/2 and ADB mouse emulation
- Two video/audio input connections
- Variable focus
- Full function remote control
- Built-in stereo speakers
- Horizontal and vertical image inverting function allows rear projection
- On-screen menu for easy projector set up
- Menus display in English, French, Spanish, Italian, Dutch, Swedish, German
- Fixed keystone correction

✓ Note

The MP8620 is one of the brightest, portable projectors in its class. The brightness of your machine will vary depending on the ambient room conditions and contrast/brightness settings

2-2. Parts Identification List

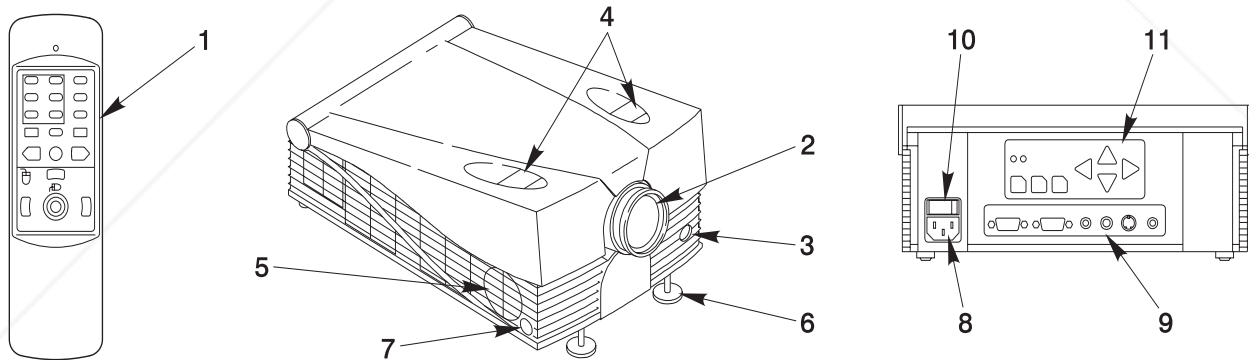

Figure 2-1. Identifying MP8620 Parts

- | | |
|---|---------------------------|
| 1. Remote Control Transmitter | 6. Height Adjustment Feet |
| 2. Lens | 7. Foot Release Button |
| 3. Remote Control Sensor | 8. Power Cord Connection |
| 4. Cover Lock (secures top cover in open/closed position) | 9. Input Terminals |
| 5. Built-In Speakers (stereo) | 10. Main Power Switch |
| | 11. Control Panel Keypad |



Section 3: Quick Set Up

3-1. Projector Set Up

The Quick Set Up instructions are intended to get you going in a hurry. If you have any difficulty, refer to Appendix C-1.

⚠ Caution

To prevent **damage to equipment**, all power to MP8620 and input sources must be turned OFF during cable hook up.

1. Place the projector on a rigid, non-slip surface.
2. Move the projector nearer or further away from the screen to obtain the best image size (Section 3-6).
3. Lift cover lock levers and raise top cover into open position.
4. Connect the power cord. (Section 3-2).
5. Connect the audio and video input cables to the projector input terminals. (Section 3-2).
6. For mouse emulation, connect the mouse cable. (Section 3-5). (*An additional adapter is necessary for Apple Macintosh computers. See Appendix D-1.*)
7. Power up the projector then the computer and the video sources. (Section 4-1).

3-2. Cable Connections

It only takes a few minutes to connect the 3M™ Multimedia Projector MP8620 to your computer, VCR or other video device (Figure 3-1).

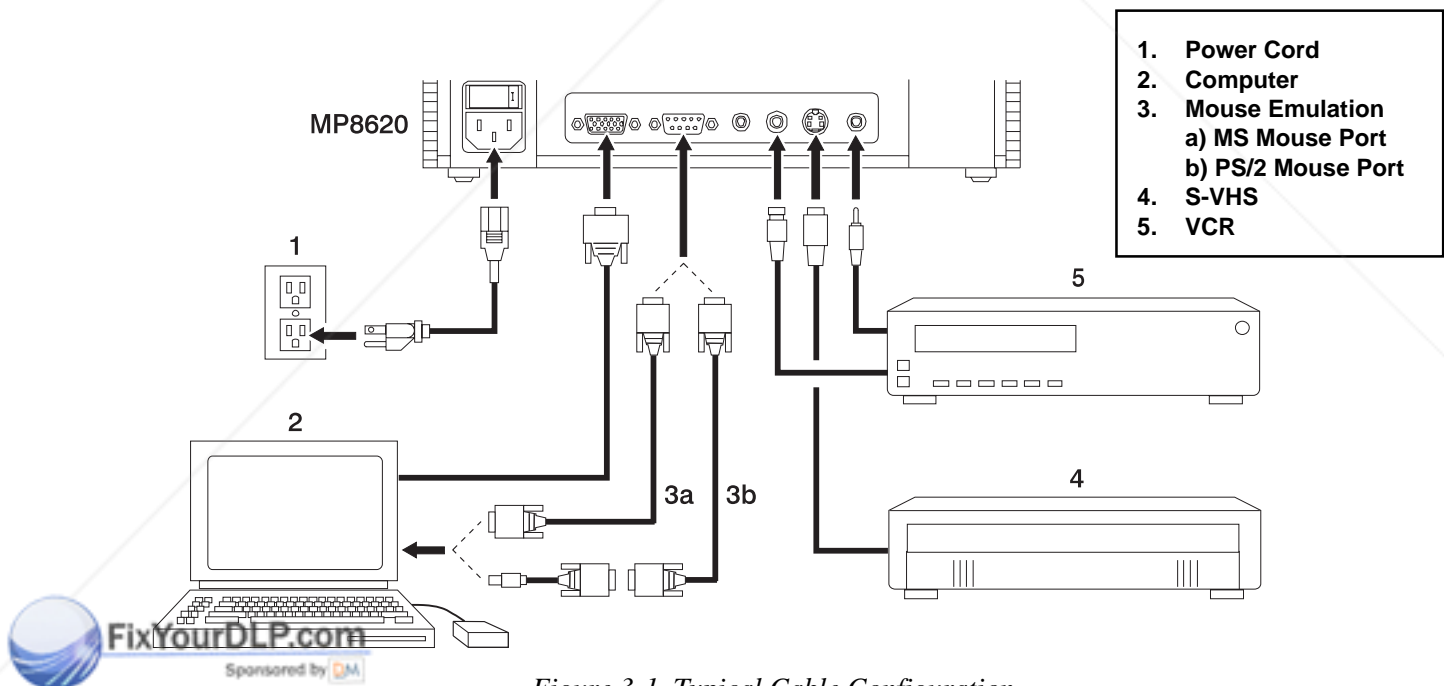

Figure 3-1. Typical Cable Configuration

1. Turn off all power to the projector and input sources during cable hook up.
2. Connect cables being careful not to bend any pins in the cable connector plug or on the computer/input terminals.
3. Start up projector then start up input sources. Section 4-1.

3-3. Projector Terminal Connections

Take a moment to look over the input terminals (Figure 3–2) on the back of the projector. Terminal connectors for the computer source are: RGB, Mouse, Audio 1/Audio 2. Terminal connectors for the video sources are: Video, S–Video, Audio 1/Audio 2.

1. ON/OFF power switch.
2. Power cord terminal
3. RGB Computer terminal
4. Mouse terminal
5. Audio 1- 3.5 mm stereo mini jack (Data)
6. Video jack
7. S-VHS jack
8. Audio 2- 3.5 mm stereo mini jack (VCR)

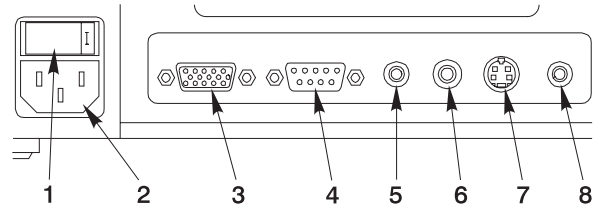

Figure 3-2. Input Connection Terminals

3-4. Control Panel Keypad

The control panel keypad (Figure 3-3) is located on the back of the projector. It has the following buttons:

1. Red indicator lamp
2. Green indicator lamp
3. Standby button
4. Menu button.
5. Enter button.
6. Arrow Keys (up/down, left/right)

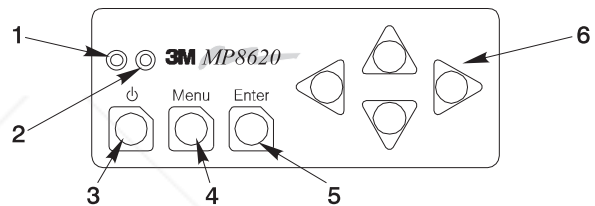

Figure 3-3. Control Panel Keypad

3-5. Mouse Connection

The projector has a built-in mouse emulation capability. Use the mouse cable (shipped with the projector) to connect your computer to the projector. Then control your computer mouse functions via the remote control.

1. Power down the computer and projector.
2. Remove the mouse cable connection from your computer mouse port.
3. Connect the mouse port of the projector to the mouse port of the computer. Use the mouse cable and PS/2 adapter (if required) supplied with this projector. *(An additional adapter is necessary for Apple Macintosh computers See Appendix D-1.)*
4. First, power on the projector, then power on the computer.

✓ **Note**

Mouse emulation only works, when all cable connections are established and then the proper start up sequence is followed. See section 4–1.

3-6. Image Size (Projector-to-Screen Distance)

Adjust the size of the projected image on the screen by moving the projector closer to the screen for a smaller image size or further away from the screen for a larger image size. See Appendix A-3.



Section 4: Operating Instructions

4-1. Projector Start Up

Read the Important Safeguards before operating the MP8620 projector. After all cable connections have been completed, the projector can be powered up. For best results, please observe the following start up sequence. Refer to Figure 4-1

⚠ Caution

Allow a projector that has been stored in a cold place to warm up to room temperature before applying power.

1. Lift cover locks (1) and raise top to open position.

✓ Note

When cover is closed, power to projector is shut off.

2. Press the power switch (2) to ON to apply power to the projector. (| = ON, ○ = OFF). The red LED (4) will illuminate.
3. Press the Standby button (3). The green LED (4) will illuminate and an image will appear and grow brighter on the screen.
4. Check all ventilation slots and clear away any obstructions.
5. Turn the lens (5) to focus the image.
6. Press the foot lock button (6) to release the height adjustment feet.
7. Raise/lower projector body to extend or retract feet (7) to obtain best image height. Rotate feet (8) for fine adjustment.
8. Power up your computer source and video source(s).

✓ Note

In most cases, the projector will automatically adjust to the graphic mode of your computer by selecting a pre-programmed setting. See Appendix C-2.

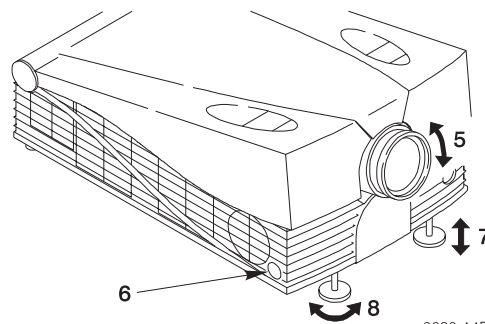
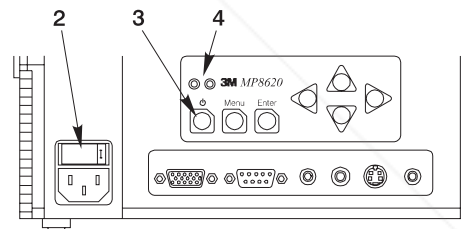
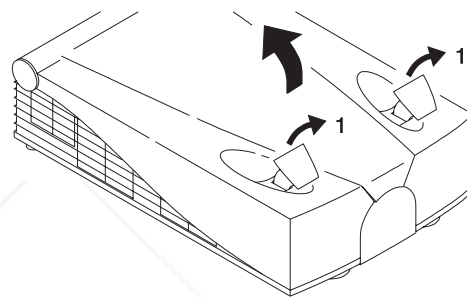

8620-14R Figure

4-1. Projector Setup

4-2. Standby Mode

When the projector is not being used, place it into standby mode.

1. Press the Standby button.
2. The lamp will switch off and the red LED will illuminate.
3. Press the standby button again to illuminate the lamp and project an image on the screen.

✓ Note

In standby mode, the fan motor will continue to run for a few minutes until the projector cools down.

4-3. Projector Power Down

Press the Standby button to place the projector in the standby mode. The cooling fan motor will continue to run.

✓ Note

Switching the power off before the fan has cycled off, will decrease the life of the projection lamp.

1. Wait until the cooling fan motor cycles off then press the main power switch to Off.
2. Turn off the power to your input devices.
3. Lift cover locks and press down on the top of the projector to lower the cover and lock it in the closed position.
4. To transport the projector, disconnect the power cord, computer cable, mouse cable and audio/video cables and place into carrying case.

4-4. Using System Menus

You can use the control panel buttons (Figure 3-3) or the remote control (Figure 5-1) to access menus, exit menus and set menu options. At the top of each menu is a *help window* which displays messages that pertain to the menu item that is highlighted.

Press the up/down or left/right ARROW KEYS on the control panel or move the STICK CONTROL on the remote to navigate through the *submenus* and select menu items.

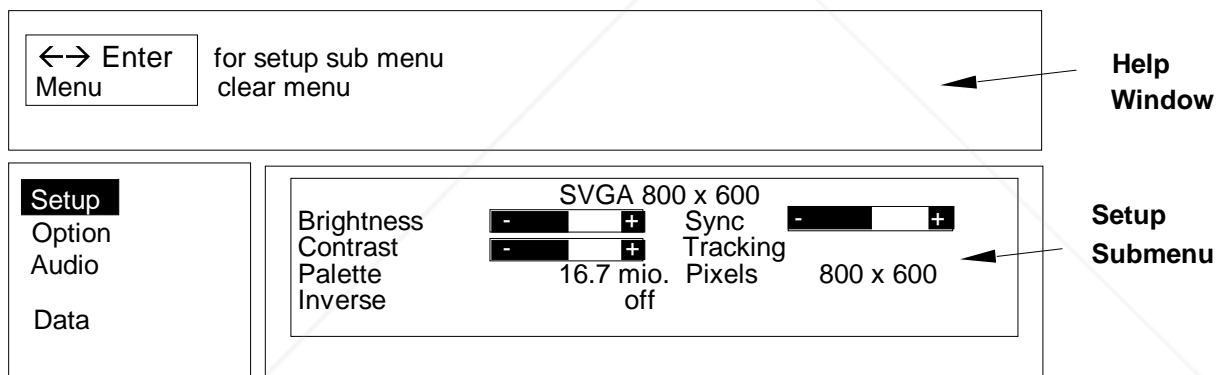

1. Press the MENU button to display the main menu.
2. Press the up/down ARROW KEYS or move the REMOTE STICK up/down to choose a sub-menu.
3. Press the ENTER button to select the sub-menu.
4. Press the up/down ARROW KEYS or move the remote stick to select a menu item in the sub-menu.
5. Press the left/right ARROW KEYS or move the remote stick left/right to change the value of a menu item.
6. Press the ENTER button, if required, to confirm the change to the menu item.

✓ Note

When the background of the displayed item turns red, you must press the **ENTER** button to confirm the change..

7. Press the MENU button to exit the sub-menu and return to the main menu.
8. In some cases, a message will display in the help window asking you to confirm the changes made in the sub-menu. Press ENTER to confirm.
9. Press the MENU button to exit the main menu display and return to the projected image.

4-5. Menu Adjustments/Settings

Depending on the current video source selection, the menu items for either the Video Menu or the Data Menu will display. The table below lists all the menu items that can be adjusted.

An asterisk (*) indicates the item appears on the Data menu only, two asterisks (**) indicate the item appears on the Video/S-VHS menu only and no marking () indicates the item is common to both menus.

Submenu	Menu Item	Explanation of Adjustment/Setting
Setup*/Picture**	<Mode>*	Selection of graphic mode (e.g. VGA 640 x 480, VESA 800 x 600 72 Hz, etc.). Ten user modes. See Appendix C-2.
	Brightness	Image brightness.
	Contrast	Image contrast.
	Palette*	Number of displayed colors. (Default=16.7 million)
	Color**	Color saturation.
	Inverse*	Inverse image displayed. (Default=off)
	Sync*	Manual synchronization (phase) or automatic adjustment using Enter.
	Tracking*	Manual screen width (total pixel number/line) or automatic adjustment using Enter.
	Pixels*	Image format. (For unscaled image use 800 x 600)
Option	Projection	Change image direction for back projection. (Default=std.)
	Lamp Mode	Select lamp power: eco. (low): std. (Default = eco.)
	Remote	Turn remote control feature On/Off. (Default=On)
	Auto Mode*	Turn automatic mode detection On/Off. (Default=On)
	Language	Select menu display language. (Default=English)
	Help	Turn menu help text messages On/Off. (Default = On)
	Lamp*	Lamp life indicator. Green bar - lamp is good. Red bar - lamp needs replacement
	Sog*	Sync-On-Green level. Only for Sync-On-Green mode.
	<Sync Mode>*	Change synchronization mode (separate, composite, Sog).
	Hue**	Color level for NTSC video.
	NTSC**	Default setting of NTSC image (scaled or unscaled)
	Audio	Volume
Treble		Treble setting.
Bass		Bass setting.
Balance		Left/right balance of speakers.
Audio		Speakers On/Off. (Default = On)
Stereo		Stereo sound On/Off. (Default = On)
<Audio assignment>		Select audio-in channels (Audio-1/Audio-2) to speakers according to video selection. Audio-In 1: Data S-VHS S-VHS Audio-In 2: Video Data Video (Default=Data/Video)
<Video Mode>	Select video source: Data, Video or S-VHS	



5-1. How to Operate the Remote Control

The remote control keypad (Figure 5-3) controls basic projector functions. To use the remote control, aim the remote toward the projection screen and press the desired button. The remote signal (Figure 5-1) will bounce off of the projection screen and back to the sensor on the front of the projector.

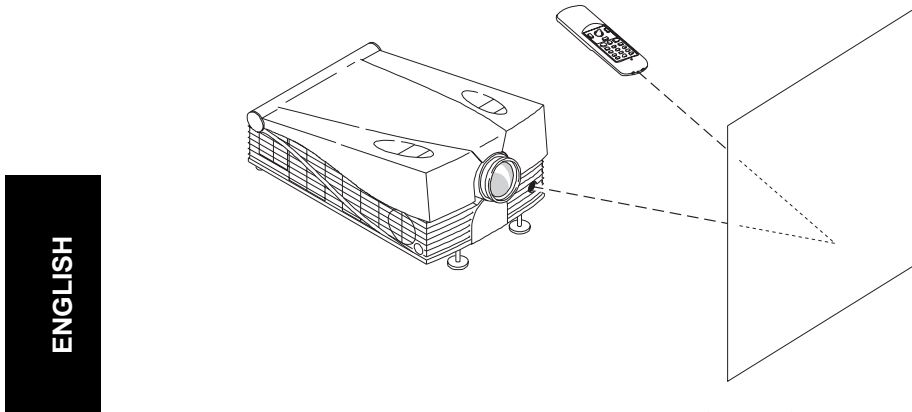

Figure 5-1. Remote Control Signal

5-2. Replacing the Batteries

The remote control uses three AAA batteries. The battery cover is located on the back of the remote control (Figure 5-3).

1. Press the locking tab (1) to release the battery compartment door.
2. Lift up on the door (2) to remove it and set it to the side.
3. Remove old batteries.
4. Install new batteries (3) making sure the polarity (+/-) on each battery matches the decal in the battery compartment.
5. Replace battery compartment door.

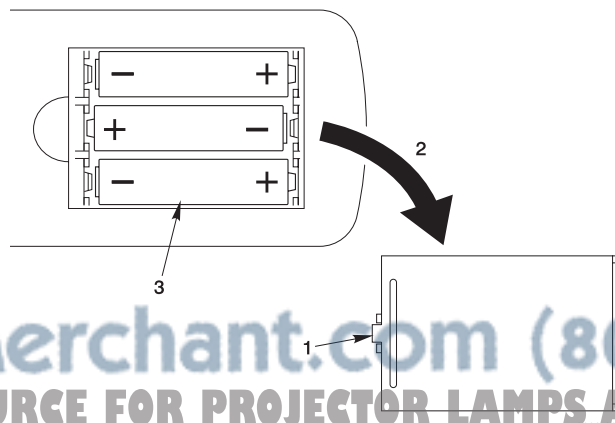

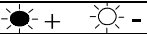

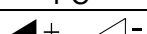



Figure 5-2. Replacing Batteries

5-3. Remote Control Button Functions

Remote Button	Description of Button Function
	Press to switch the projector between Standby mode (lamp off, fan off) and operation mode (lamp on, fan on).
REVEAL	Press REVEAL to cover the image on the screen with a gray mask. Use the control stick to reveal the image or press REVEAL again to return full screen projection of image.
FREEZE	Stores (freezes) the projected image. Press FREEZE again to return the projection of the current image.
MAGNIFY	Press MAGNIFY to double the image size in horizontal and vertical direction. The details of the middle of the picture can be seen. Move the control stick to displace the magnified area within the image. Press the MAGNIFY key again to switch back to normal presentation. <i>In Video mode, press MAGNIFY to switch between scaled and unscaled representation. This is only for NTSC video.</i>
BLANK	Removes projected image, white background. Press again to return projection image.
TIMER	When the key is operated the timer-window appears in the lower part of the display. Repeated operation of the key switches over to full image display of the timer and back to data projection. The timer starts with the last used adjustment. A new start value is entered by operating the key ENTER and adjusting the value with the control stick. Operating the ENTER key again starts the timer. When the timer has run down, the timer window blinks repeatedly.
POINTER	Places a pointing device on the screen. Move pointer by operating the control stick.
	Brightness adjustment.
VIDEO	Switches to video mode. When in video mode the video source can be selected (Video or S-Video) by pressing the key repeatedly.
	Mute.
PC	Switches to PC mode.
	Volume adjustment.
MENU	Start the On Screen Menu System for projector adjustment.
 ON/OFF	Press ON/OFF to activate/deactivate mouse emulation capability. ON: The L and R buttons operate the left and right mouse key functions. Drag-and-drop functions are possible by simultaneous operation of the L/R mouse key and control stick. OFF: L button is the Enter confirmation key. R button not used. Control stick centers image.
L / ENTER	<i>Mouse emulation ON</i> , left mouse button. <i>Mouse emulation OFF</i> , Enter button for confirmation of a selection.
R	Right mouse button, when mouse-emulation active.
	<i>Mouse emulation ON</i> , stick controls the movement of the pointing device. <i>Emulation OFF</i> , stick centers image on screen.

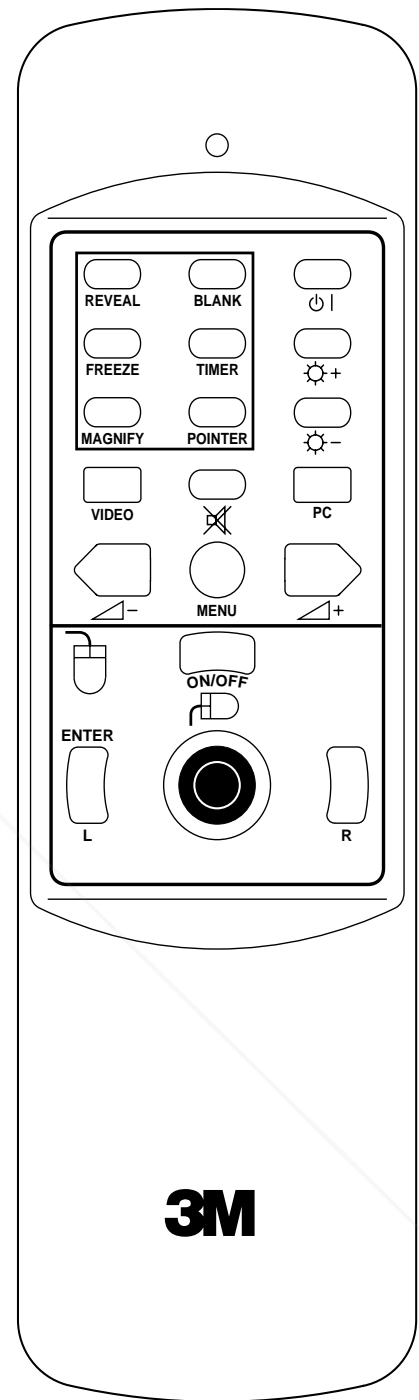

Figure 5-3. Remote Control



6-1. Metal Halide Projection Lamp

The metal halide lamp of the projector has a limited life time (approximately 1000 hours). If the projected image appears dark or a *red* lamp life indicator bar displays during projector startup, you should change the lamp and air filter.

✓ Important Note

This lamp contains mercury. Consult your local hazardous waste regulations and **dispose of this lamp in a proper manner.**

6-2. Lamp Life Indicator

The elapsed operating time of the lamp can be checked in the **Option** menu. As long as the bar of the menu item **Lamp** is green, the lamp is good. When the bar changes to red, the lamp should be changed.

After changing the projection lamp, the lamp life indicator must be reset to zero.

To reset the lamp life indicator:

1. Select the menu item **Lamp** in the **Option** menu and press **ENTER**.
2. Follow the instructions in the help window
3. Press **ENTER** and the **↑** arrow of the projector control panel for confirmation.



Discount-Merchant.com (800) 281-8860
THE TRUSTED SOURCE FOR PROJECTOR LAMPS AND ACCESSORIES

6-3. Replacing the Lamp

⚠ Caution

Always unplug the projector when changing the lamp. There are high voltage parts inside the cabinet that may **cause electric shock**.

⚠ Caution

Allow the projector to cool down. Lamp and adjacent metal parts become extremely hot and can cause **burns to your fingers**.

1. Press the Standby button  on the projector control panel or remote control and wait for the fan motor to cycle off.
2. Turn off the power switch and unplug the projector power cord.
3. Stand the projector upright on the left side with the bottom facing you (see figure 6-1).
4. Locate the lamp access door (1) on the bottom of the projector.
5. Remove the two screws (2).
6. Push down on the lock tab (3) to release the door.
7. Slide the door open (4) and remove it.

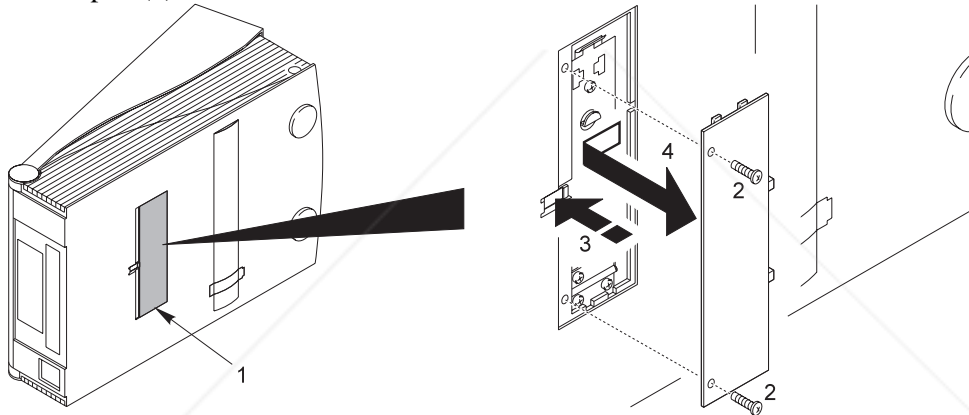

Figure 6-1. Removing Lamp Door

8. Press the tab (5) to release the lamp assembly (see figure 6-2).
9. Carefully lower the lamp assembly (6) to access the metal halide lamp.
10. The lamp is double ended with sockets on both sides. Carefully pull upward on both ends of the lamp (7) to remove it.

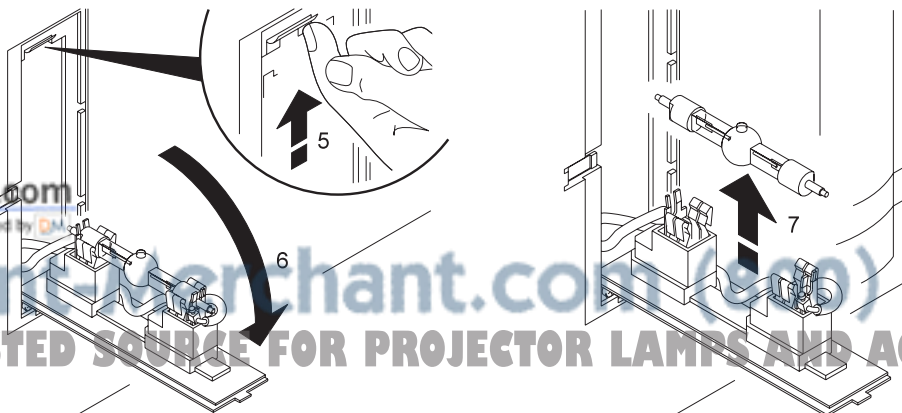

Figure 6-2. Lower Lamp Assembly

11. Install the new lamp (**3M Part Number 78-6969-8424-0**) by pushing down on the ends of the lamp (**8**) with equal pressure. Take care to correctly align the lamp with the bubble (**8a**) facing upward (see figure 6-3).

✓ Important Note

Do not touch lamp glass with fingers. Hold lamp by the metal ends only.

12. Fold the lamp housing (**6**) into the closed position until the lock tab (**5**) secures it.
13. Insert the lamp access door (**1**) and slide it closed to engage the lock tab (**3**).
14. Insert the two screws (**2**).

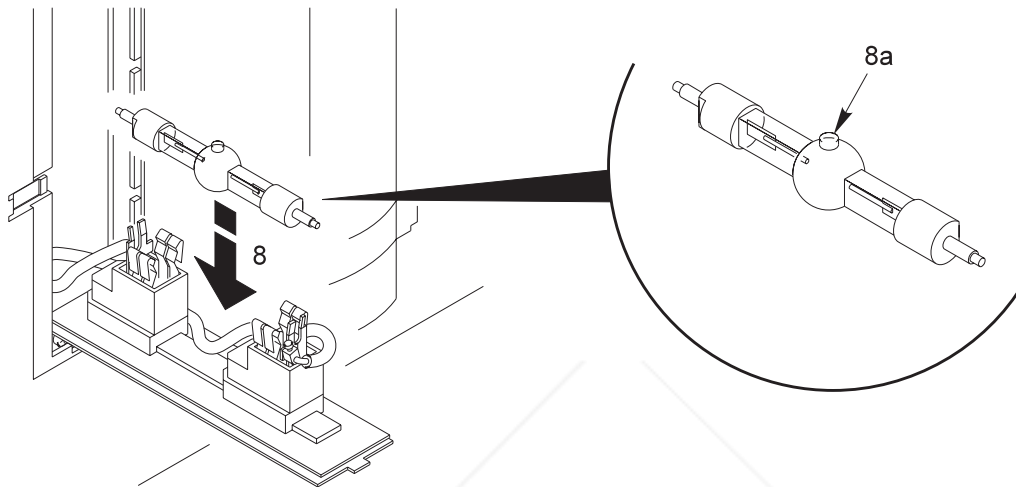

Figure 6-3. Replacing the Lamp

15. Replace the air filter (included in the lamp kit). See Section 7-1.

✓ Important Note

Always change the air filter when the lamp is replaced. When you order a metal halide lamp, it comes in a kit which includes an air filter.



Section 7: Maintenance

7-1. Replacing the Air Filter

For best performance, replace the air filter each time the projection lamp is changed. One air filter is included in each lamp kit (3M Part Number 78-6969-8424-0) or air filters are available individually as (3M Part Number DY-0205-1368-1). See Appendix D-1.

✓ Note

The air filter can only be changed when the top section of the projector is in the open position. Lift the lock levers on the top of the projector to raise the top section.

1. Unplug the power cord of the projector.
2. Stand the projector upright on the left side with the bottom facing you.
3. Locate the air filter door (1) on the bottom of the projector.
4. Push the lock tab (2) to release the door.

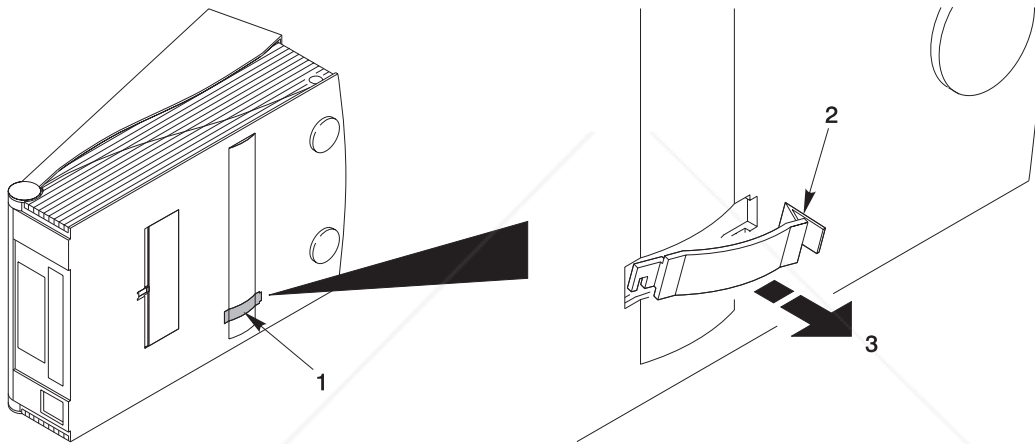

Figure 7-1. Removing Air Filter Door

5. The air filter door has a plastic hook (4) on one end. Use this hook to reach inside the projector and hook the corresponding tab on the air filter frame.
6. Remove the air filter (5) by pulling straight outward.
7. Insert the new air filter by sliding it into position.
8. Insert the air filter door and press the lock tab to secure it in place.

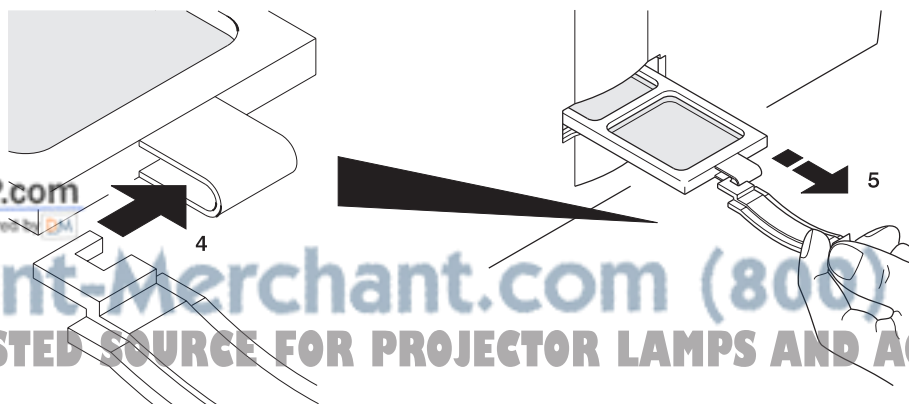



Figure 7-2. Replacing Air Filter

7-2. Cleaning the Projector

For best performance, keep your projector free of excess dust and surface dirt.

Use a soft cloth to remove dust from the projector housing. Use 3M™ Overhead Cleaner 676 to remove surface dirt and smudges from the projection lens (Figure 7-2).

 Caution
Always unplug the projector when cleaning. Take care that no liquids get inside the projector. There are high voltage parts inside the cabinet that may cause electric shock .

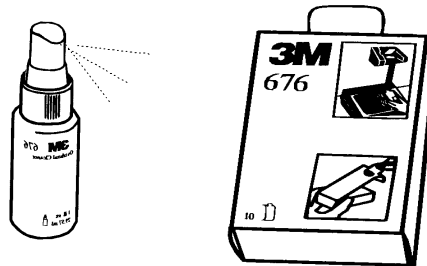

Figure 7-3. Overhead Cleaner



Section 8: Troubleshooting

8-1. Troubleshooting Problems

The MP8620 has been designed to be as simple and as trouble free to use as possible. If you run into problems when using the MP8620, consult the following chart.

Problem	Probable Cause	Possible Solution
Image is disturbed or unstable.	<ul style="list-style-type: none"> Wrong Sync setting. Wrong Tracking value. 	<ul style="list-style-type: none"> Set to factory default setting (refer to Appendix C-2). Change Sync setting in the Setup menu for optimum performance (refer to Appendix C-1). For vertical interference stripes, change the Tracking in the Setup menu for optimum performance (refer to Appendix C-1).
No computer image projected. Message No input detected is shown.	<ul style="list-style-type: none"> Loose cable. No power to computer. Wrong synchronization mode. 	<ul style="list-style-type: none"> Check and secure cable connections. Turn on computer. Adjust synchronization mode of the projector to the synchronization mode of the computer via Option menu.
No video image projected.	<ul style="list-style-type: none"> Loose cable. No signal from video source. 	<ul style="list-style-type: none"> Check and secure cable connections. Check video picture on TV.
Mouse does not work.	<ul style="list-style-type: none"> Loose cable. Wrong connection. Wrong power up sequence. 	<ul style="list-style-type: none"> Check and secure cable connections. For PS/2 and ADB (Apple) mouse a special adapter is necessary. Only use adapters from the original manufacturer (refer to section 3-5.). The mouse emulation operates correctly only if the correct power up sequence has been used (refer to section 3-5.)
Image off-center.	<ul style="list-style-type: none"> Image position. 	<ul style="list-style-type: none"> Center image with the arrow keys of the control panel or the stick of the remote control.
Cannot get entire image on the screen.	<ul style="list-style-type: none"> Wrong Tracking value. Compatibility problem. Wrong Pixel setting. 	<ul style="list-style-type: none"> If vertical interference stripes occur, change the Tracking value in the Setup menu for optimum performance. Refer to the documentation of your graphic card. The projector supports the resolutions that can be found under Pixel in the Setup menu (refer to Appendix C-2). Adjust the Pixel setting in the Setup menu to the resolution of the video mode output from the computer graphic card.
Washed out image.	<ul style="list-style-type: none"> Wrong Contrast setting. Wrong Brightness setting. 	<ul style="list-style-type: none"> Change Contrast setting in the Setup menu. The bar should be in the middle position. Lower Brightness setting in the Setup menu. An automatic adjustment can be performed by choosing Brightness and pressing Enter.
Humming noise. Slowly passing horizontal bars.	<ul style="list-style-type: none"> Signal sources are connected to different power sources. VCR connected to aerial system and to projector.. Bad signal. 	<ul style="list-style-type: none"> Locate the source of disturbance. Disconnect the sources one after another from the projector. Connect all sources to a common power source. Remove antenna connection from VCR. If the disturbance disappears, use a by-pass filter (isolating transformer) to connect the antenna to the VCR. Try different input source.
No power Power shuts off during presentation	<ul style="list-style-type: none"> Power switch off Projector overheated 	<ul style="list-style-type: none"> Turn on power switch to projector. Remove any objects blocking ventilation and allow projector to cool down. Power will return and projector will be in Standby mode.

8-2. Service Information

For product information, product assistance, service information, or to order accessories, please call:

In U.S. or Canada: **1-800-328-1371**

In other locations, contact your local 3M Sales office.



Discount-Merchant.com (800) 281-8860
THE TRUSTED SOURCE FOR PROJECTOR LAMPS AND ACCESSORIES



A-1. Technical Specifications

Power supply	3-wire grounded, AC 90-130V, 50/60 Hz AC 198-250V, 50/60 Hz
Power consumption	500W (typical)
Width	280 mm (11 in.)
Height (closed position)	105 mm (4 in.)
Height (open position)	183 mm (7.2 in.)
Depth	409.5 mm (16 in.)
Weight	5.0 kg (11.0 lb.)
Panel	aSi 6.4 in. TFT, 800 x 600 x 3 pixel
Number of pixels per panel	480,000 pixels (H800 x V600 x RGB = 1.44 million pixels)
Storage temperature range	-20°C to 60°C (-4°F to 140°F)
Operating temperature range	0°C to 35°C (32°F to 95°F)
Optical structure	Fresnel - wide angle, F5.6 lens
Lens	165 mm f/5 fixed focus lens, manual focus
Keystone correction	16° fixed
Brightness	450 lumens
Input terminals	RGB (w/ separate sync, composite sync or sync on green): DSub 15 pin Serial (RS232) out to computer: (DSub 9 pin) Video: (RCA jack) S-Video: (Mini DIN 4-pin) 2 x Audio In: Stereo, 3.5 mm headphone jack
Input signals	RGB 0.7V peak-to-peak, 75Ω termination, w/ TTL or analog Sync Video: 1.0V peak-to-peak, 75Ω termination S-Video: Luminance 1.0V peak-to-peak, 75Ω termination Chroma 0.286V peak-to-peak (burst signal) 75Ω termination Audio: 0.7 Vrms, across 30 κΩ Max pixel rate: 75 MHz (typical)
Color	16.7 million.
Contrast	1:150
Internal Speakers	Two speakers, 1W, stereo
Batteries for remote control	Three AAA, 1.5 Volt

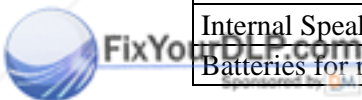

Discount-Merchant.com (800) 281-8860
THE TRUSTED SOURCE FOR PROJECTOR LAMPS AND ACCESSORIES

A-2. Physical Dimensions

The MP8620 projector has the following physical dimensions:

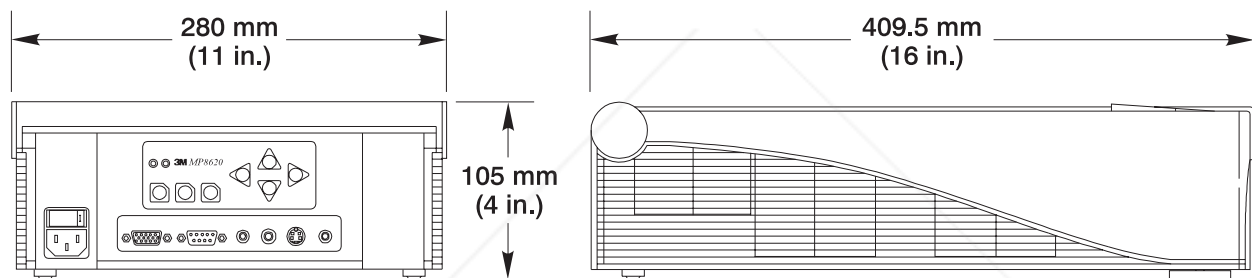
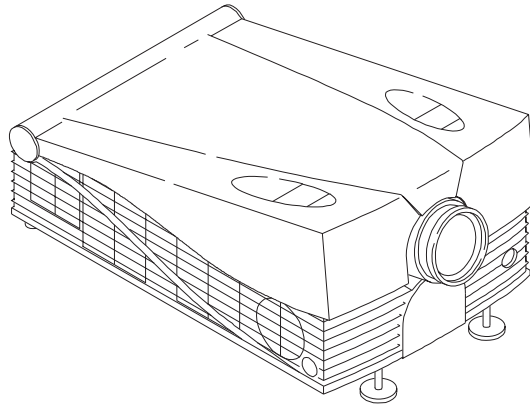

A-3. Projector-to-Screen Distance

The following table shows the image size relative to the distance of the projector from the screen. This distance is measured from the front of the projector lens to the screen.

DISTANCE TO SCREEN (feet)	IMAGE SIZE (inches)		
	Diagonal	Width	Height
4.5 ft.	54 in.	43 in.	32 in.
5.0 ft.	60 in.	48 in.	36 in.
5.5 ft.	64 in.	51 in.	38 in.
6.0 ft.	75 in.	60 in.	45 in.
6.5 ft.	79 in.	63 in.	47 in.
7.0 ft.	87 in.	70 in.	52 in.
7.5 ft.	94 in.	75 in.	56 in.
8.0 ft.	100 in.	80 in.	60 in.
8.5 ft.	108 in.	86 in.	65 in.
9.0 ft.	114 in.	91 in.	68 in.
10.0 ft.	128 in.	102 in.	77 in.
11.0 ft.	140 in.	112 in.	84 in.
12.0 ft.	154 in.	123 in.	92 in.

A-3. Projector-to-Screen Distance, continued

The following table shows the image size, relative to the distance of the projector from the screen. This distance is measured from the front of the projector lens to the screen.

DISTANCE TO SCREEN (cm)	IMAGE SIZE (cm)		
	Diagonal	Width	Height
125 cm	126 cm	100 cm	76 cm
150 cm	150 cm	119 cm	90 cm
175 cm	175 cm	139 cm	105 cm
200 cm	205 cm	164 cm	123 cm
225 cm	229 cm	183 cm	137 cm
250 cm	263 cm	210 cm	158 cm
275 cm	290 cm	232 cm	174 cm
300 cm	321 cm	257 cm	193 cm
325 cm	340 cm	272 cm	204 cm
350 cm	375 cm	300 cm	225 cm
375 cm	400 cm	320 cm	240 cm
400 cm	429 cm	343 cm	257 cm



Discount-Merchant.com (800) 281-8860
THE TRUSTED SOURCE FOR PROJECTOR LAMPS AND ACCESSORIES



B-1. S-Video Input Signal Terminal

The following illustration (Figure B-1) identifies the terminal connections for the Mini DIN 4-pin.

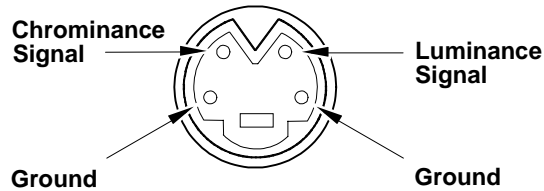

Figure B-1. S-Video Input (Mini DIN 4-pin)

Video input is in the following order of priority:

- S-video input terminal
- RCA jack input terminal



Discount-Merchant.com (800) 281-8860
THE TRUSTED SOURCE FOR PROJECTOR LAMPS AND ACCESSORIES



C-1. Setting Representation, Resolution, Colors

Most computers do not just support one single screen mode but rather a series of different modes which differ in type of representation (text or full graphic), resolution (number of pixels) and number of colors.

Pre-stored standard mode settings for a variety of IBM compatible and Apple Macintosh computers help the projector to recognize the current mode and adjust for optimum performance automatically.

Apart from this you can enter and save additional modes with any parameters by means of the menu system. An upper limit is given by the maximum admissible pixel rate (Appendix A-1).

Adjust the projector to optimum display quality, as described below, by using the menu control (see section 4-4). All steps described can be carried out via the keyboard or the remote control:

1. Adjust the background as necessary to obtain a display with the highest possible contrast. For use under Microsoft Windows it is recommended that you close all applications first, and by using the system control, adjust the desktop background to an even black-and-white raster.
2. Call up the main menu of the projector by pressing the **MENU** key.
3. Select the **Setup** menu.
4. Open the **Setup** menu by pressing the **ENTER** key.
The current mode is displayed in the title block of the **Setup** menu. Change the mode field if desired. Confirm your selection by pressing the **ENTER** key
5. Move to menu item **Palette** and select the desired chromatic resolution.
If desired, select an image format with a converted coding of pixel and line numbers to adapt to the current screen mode. Therefore move to the menu item **Pixel** and select the image resolution. Use **800x600** for unscaled representation.
6. Select the menu item **Brightness** and correct the setting so that white areas are projected with maximum intensity. Press the **ENTER** key for automatic adjustment.
Look at a finely structured area with grid lines. This area may have vertical interference lines superimposed on it.



7. Select the menu item **Tracking** (image width) and adjust for minimum interference. The direction of adjustment is correct when the number of lines decreases. The setting is optimal when no more interference lines can be seen. An automatic setting of tracking and synchronization can be called up by operating the **ENTER** key. This may not work, if a uniform pattern is displayed on the projector.

8. Synchronize the phase position of the pixel frequency and scanning frequency. Choose the menu item **Sync**. Image interference's and flickers can be observed with some settings as shown in the following figure:



9. In a range of several settings an image is projected that is free of interference. If the sync-setting is correct, the image will improve as shown in following figure:



10. An automatic setting of the synchronization can be called up by using the **ENTER** key.
11. Minor interference, where one color meets another, can be corrected by manually adjusting the **Brightness** and **Contrast**. Normally, the contrast should be set to approximately the medium value. Lower values cause an increase in background intensity.
12. To leave the Setup menu, press the **MENU** key.
13. If parameter settings have been changed, a warning is displayed. Confirm the changed settings by using the **ENTER** key.
14. Center the projected image, if necessary, with the cursor keys or the stick of the remote control.

C-2. Factory Default Settings

The following table shows the possible settings of the projector. These settings can be restored by pressing **ENTER** and the **↓** button on the control panel (backside of projector) when switching on the main power of the projector.

The projector will start immediately and a message **Parameter factory settings restored** in the starting picture will indicate the default settings are reset. The default settings of the projector are underlined.

Menu	Submenu	Possible Settings
Setup*/Picture**	<Mode>*	Ten user Modes: User mode 1, User mode 2, ..., User mode 10 VGA Text 720x400 VGA 640x350 VGA 640x400 VGA 640x480 Mac LC 640x480 Mac 640x480 VESA 640x480 72 Hz VESA 640x480 75 Hz VESA 640x400 85 Hz VESA 640x350 85 Hz VESA 800x600 56 Hz VESA 800x600 60 Hz VESA 800x600 72 Hz VESA 800x600 75 Hz Quadra 832x624
	Brightness	bar
	Contrast	bar
	Palette*	64, 512, 4096, 262.144, <u>16.7 m</u>
	Color **	bar
	Inverse*	bar
	Sync*	bar
	Tracking*	<u>automatic adjustment</u> , manual entry of pixel number/line
	Pixels*	640x350, 640x400, 720x400, 640x480, 800x600, 832x624, 1024x768
Option	Projection	<u>std.</u> , ← →, ↑ ↓, ← → ↑ ↓
	Lamp Mode	std., eco.
	Remote	<u>on</u> , off
	Auto Mode*	<u>on</u> , off
	Language	<u>English</u> , Français, Español, Italiana, Nederlands, Svenska, Deutsch
	Help	<u>on</u> , off
	Lamp*	bar
	Sog*	bar
	<Sync Mode>*	<u>Sep. TTL Sync</u> , Sep. Ana. Sync, Comp. TTL Sync, Comp. Ana. Sync, Sync on Green
	Hue**	bar
	NTSC**	<u>full</u> , centered
Audio	Volume	bar
	Treble	bar
	Bass	bar
	Balance	bar
	Audio	<u>on</u> , off
	Stereo	<u>on</u> , off
	<Audio assignment>	<u>Data/Video</u> , S-VHS/Data, S-VHS/Video
<Video Mode>	Data, Video, S-VHS	



D-1. Accessory Parts List

<u>Part Description</u>	<u>UL Reference</u>	<u>Part Number</u>
Projection Lamp Kit - Metal Halide Lamp (400W) - Air Filter	3M, E187401	78-6969-8424-0
Air Filter (included in lamp kit 78-6969-8424-0)	3M, E187401	DY-0205-1360-1
Power Cords (U.S., UK, Europe) For special power cords. See Appendix D-3	3M, E187401 3M, E187401 3M, E187401	DY-0205-1356-9 (U.S.) DY-0205-1355-1 (UK) DY-0205-1354-4 (Europe)
VGA Cable (15-15 pin M/M)	3M, E187401	DY-0205-1271-0
Video Cable (S-Video mini DIN-4pin)	3M, E187401	DY-0205-1010-2
Composite Video Cable (RCA to RCA)	3M, E187401	DY-0205-1008-6
Audio Cable (RCA to 3.5 mm stereo)	3M, E187401	DY-0205-1359-3
PC Serial Cable (PC mouse connection)	3M, E187401	DY-0205-1007-8
Remote Control	3M, E187401	DY-0205-1353-6
Mac Cable Set (optional)	3M, E187401	DY-0205-1361-9
Soft Carry Case	3M, E187401	DY-0205-1352-8
MP8620 Notebook Deluxe Carry Case	3M, E187401	78-6969-8323-2
Monitor Splitter Box Kit (optional)	3M, E187401	XX-0034-1736-5
Mouse Y-Cable (optional)	3M, E187401	DY-0205-1507-7
Stereo mini-jack (optional)	3M, E187401	26-1012-0683-2

Mac Cable Set (optional), Part number DY-0205-1361-9: This kit contains a Mac mouse adapter and a Mac video cable.

Monitor Splitter Box Kit (optional), Part number XX-0034-1736-5: The Monitor Splitter Box Kit provides the user with the option to independently operate a PC monitor from the MP8620 projector. (Maximum picture frequency: 80 MHz)

Mouse Y-Cable (optional), Part number DY-0205-1507-7: This cable provides user with the option to simultaneously operate the MP8620 remote mouse and a PC mouse (only works with Microsoft serial mouse).

D-2. How to Order

Please order these parts through your dealer, or contact 3M Customer Service at the following number:

- In U.S. or Canada: 1-800-328-1371
- In other locations, contact your local 3M Sales office.



Discount-Merchant.com (800) 281-8860
THE TRUSTED SOURCE FOR PROJECTOR LAMPS AND ACCESSORIES

D-3. Power Cord Sets

A standard power cord set (U.S., UK, or European) will be included with each MP8620. If you need a special power cord set, contact your local 3M authorized dealer. The power cords must be in accordance with the regional and corresponding national safety regulations and be properly approved. Examples of these power cords are shown in Figure D-1.

North America
UL Listed CSA Certified
15A 125VAC

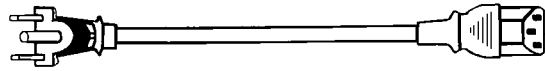

Germany, Netherlands,
Spain, France, Greece
VDE Certified
10A 250VAC

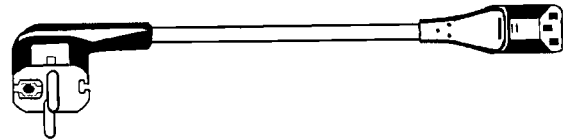

Great Britain
AUSTA Certified
13A 250VAC

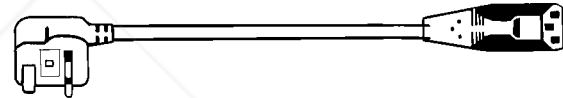

Italy
IMQ or BASEC Certified
10A 250VAC

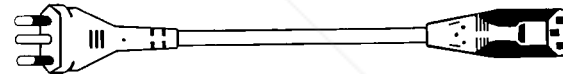

Switzerland
SEV Certified
10A 250VAC

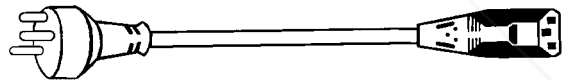

Australian
SAA Certified
10A 250VAC

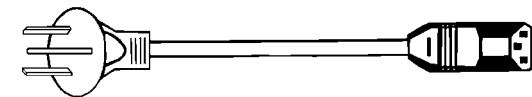

Denmark
Complies with Danish Standard
6/10A 250VAC

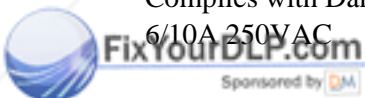
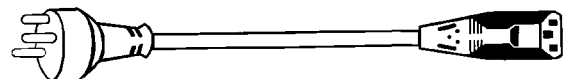

Discount-Merchant.com (800) 281-8860

THE TRUSTED SOURCE FOR PROJECTOR LAMPS AND ACCESSORIES



Glossary of Terms

Amorphous Silicon

See Thin-Film Transistor.

Composite video

A video signal that combines all color and timing components of the picture in a single input line. The U.S. standard is NTSC. European standards are PAL and SECAM.

Hz, KHz, MHz (Hertz, Kilohertz, Megahertz)

Hertz is a unit of measurement used to express the frequency, in cycles per second, of an electrical signal or event. (Kilohertz = 1000, Megahertz = 1 million cycles per second).

Keystone correction

Keystoning (distorted image) is caused when the path of the projector light beam is not perpendicular to the screen. Projectors normally project the image with an angle (e.g. 16°) on the screen. The optical system can be designed for distortion free projection at this angle (keystone correction).

Lumens

A measure of light output on a screen or other surface. One lumen is the light of one candle power on each square foot of a surface of a sphere at a radius of one foot from the light source.

Metal halide lamp

A metal halide lamp is a modified mercury arc lamp that is extremely bright. It is filled with a gas with elements known as “halogens”. The properties of this fill gas allows the lamp to burn longer and brighter than ordinary incandescent lamps.

NTSC (National Television Systems Committee)

Standard for television signals and other video equipment signals. Uses interlaced scans and 525 horizontal lines per frame at a rate of 30 frames per second.

PAL (Phase Alternate Line)

The format for color television signals used in England, Germany, the Netherlands, and several other countries. PAL is an interlaced format with 25 frames per second and 625 lines per screen.

Pixel

Short for “picture element.” Unique position on a display that consists of a single dot or group of three dots (red, green & blue). Total pixels are usually expressed in horizontal x vertical dimensions (e.g. 640

x 480)

Power ON/OFF switch

The power ON/OFF switch is used to turn the machine on and off. The power switch is located on the back of the projector in the lower left-hand corner.

Refresh rate

The number of times the screen image is “painted” or refreshed per second, expressed in Hz.

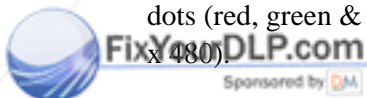

Discount-Merchant.com (800) 281-8860
THE TRUSTED SOURCE FOR PROJECTOR LAMPS AND ACCESSORIES

Remote control sensor

The remote control sensor is located on the front of the projector. It receives signals from the remote control transmitter (direct line-of-site or bounced off of the projection screen) which control the different operating functions of the projector. See remote control transmitter.

Remote control transmitter

Allows remote operation of the projector functions by aiming the transmitter directly at the sensor (maximum range) on the front of the projector or aiming the transmitter at the projection screen so the signal will bounce off the screen and back to the sensor. The remote also has mouse emulation capability that will also control the mouse functions of the computer input source.

Resolution

The number of pixels available in a display device for creating images. Expressed as a number of columns by number of rows (e.g. VGA resolution, 640 x 480 or 720 x 400).

S-Video

A video signal that separates luminance (Y) and chrominance (C) signals. Also known as Y/C video.

SECAM (Séquentiel Couleur à Mémoire)

The color television standard developed in France and used in certain other countries.

SYNC

The timing of the computer's video signal. Usually a PC uses two separate lines for horizontal synchronization (beginning of the line) and vertical synchronization (beginning of the frame). This scheme is called *separate sync*.

If the two synchronization signals are transmitted on a single extra line, this is called *composite sync*. If the composite sync signal is transmitted together with a video signal (usually the green video signal), this is called *sync on green*. The projector can be set to handle all three kinds of synchronization schemes.

Thin-Film Transistor (TFT)

A tiny (less than fifty microns across) nearly-transparent wafer of semiconduction silicon. These act as extremely precise electronic switching mechanisms.

VGA (Video Graphics Array)

This is a standard analog interface for PC computers. The resolution for text mode is 720 x 400 and for graphics mode 640 x 480.

Video

The capability to project images from a VCR, Laser Disc, or PC with CD-ROM Drive is a standard analog interface for PC computers. The resolution for text mode is 720 x 400 and for graphics mode 640 x 480.

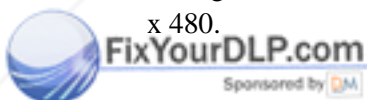

Discount-Merchant.com (800) 281-8860
THE TRUSTED SOURCE FOR PROJECTOR LAMPS AND ACCESSORIES



Index

A

Air Filter 15
 Amorphous Silicon 27

B

Batteries 10, 19

C

Composite video 27

F

Factory Default Settings 25

I

Important Safeguards 1, 7
 Intended Use 1
 Inventory List 3

K

Keystone 19, 27

L

Lumens 27

M

Machine Characteristics 4
 metal halide lamp 1, 4, 12, 13, 27
 mouse adapter 3

mouse emulation 4, 5, 6, 11, 17, 28

N

NTSC 4, 9, 11, 25, 27

P

PAL 4, 27
 Pixel 17, 23, 27
 Projector-to-Screen Distance 6, 20

R

Refresh rate 27
 Remote control transmitter 3, 28
 Resolution 23, 28

S

SECAM 4, 27, 28
 Standby Mode 7
 S-Video 11, 28
 SYNC 28

T

Troubleshooting 17

V

VGA 3, 9, 25, 28
 Video 2, 6, 9, 11, 19, 22, 25, 26, 28



Discount-Merchant.com (800) 281-8860

THE TRUSTED SOURCE FOR PROJECTOR LAMPS AND ACCESSORIES

The contents of this manual are subject to revision without prior notice.

3M assumes no responsibility for the infringement of special rights of a third party or other rights that may arise out of the use of the information contained in this manual.

Reproduction of this manual in any form without prior permission is strictly prohibited.

Let us help you make the most of your next presentation. We offer every thing from presentation supplies to tips for better meetings. And we're the only transparency manufacturer that offers a recycling program for your used transparencies. For late-breaking news, handy references and free product samples, visit our Internet Website.

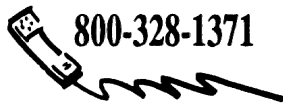

<http://www.mmm.com/presentations>
e-mail: presentations@mmm.com

Discount-Merchant.com (800) 281-8860

3M Austin Center
Building AI45-5N-01
6801 River Place Blvd.
Austin, TX 78726-9000

3M Canada
P.O. Box 5757
London, Ontario, Canada
N6A 4T1

3M Mexico, S.A. de C.V.
Apartado Postal 14-139
Mexico, D.F. 07070
Mexico

3M Europe
Boulevard de l'Oise
9500 Cergy Pontoise Cedex
France

*Printed on 50% recycled wastepaper,
including 10% post-consumer wastepaper*
©3M 1997 DY-0205-1351-0 Rev. B

THE UNIFIED SOURCE FOR PROJECTOR SLIDES, SLIDERS, SLIDERS AND ACCESSORIES



Disclaimer

This user manual is provided as a free service by FixYourDLP.com. FixYourDLP is in no way responsible for the content of this manual, nor do we guarantee its accuracy. FixYourDLP does not make any claim of copyright and all copyrights remain the property of their respective owners.

About FixYourDLP.com

FixYourDLP.com (<http://www.fixyourdpl.com>) is the World's #1 resource for media product news, reviews, do-it-yourself guides, and manuals.

Informational Blog: <http://www.fixyourdpl.com>

Video Guides: <http://www.fixyourdpl.com/guides>

User Forums: <http://www.fixyourdpl.com/forum>

FixYourDLP's Fight Against Counterfeit Lamps:

<http://www.fixyourdpl.com/counterfeits>

Sponsors:

RecycleYourLamp.org – Free lamp recycling services for used lamps:

<http://www.recycleyourlamp.org>

Lamp Research - The trusted 3rd party lamp research company:

<http://www.lampresearch.com>

Discount-Merchant.com – The worlds largest lamp distributor:

<http://www.discount-merchant.com>



FixYourDLP.com

Sponsored by 