



Disclaimer

This user manual is provided as a free service by FixYourDLP.com. FixYourDLP is in no way responsible for the content of this manual, nor do we guarantee its accuracy. FixYourDLP does not make any claim of copyright and all copyrights remain the property of their respective owners.

About FixYourDLP.com

FixYourDLP.com (<http://www.fixyourdpl.com>) is the World's #1 resource for media product news, reviews, do-it-yourself guides, and manuals.

Informational Blog: <http://www.fixyourdpl.com>

Video Guides: <http://www.fixyourdpl.com/guides>

User Forums: <http://www.fixyourdpl.com/forum>

FixYourDLP's Fight Against Counterfeit Lamps:

<http://www.fixyourdpl.com/counterfeits>

Sponsors:

RecycleYourLamp.org – Free lamp recycling services for used lamps:

<http://www.recycleyourlamp.org>

Lamp Research - The trusted 3rd party lamp research company:

<http://www.lampresearch.com>

Discount-Merchant.com – The worlds largest lamp distributor:

<http://www.discount-merchant.com>



FixYourDLP.com

Sponsored by 

USER GUIDE

C300



English
Deutsch
Français
Español
Italiano
Português
Norsk



FixYourDLP.com

Sponsored by



Discount-Merchant.com (800) 281-8860

THE TRUSTED SOURCE FOR PROJECTOR LAMPS AND ACCESSORIES

LIMITED WARRANTY

ASK, InFocus, Proxima-Branded Products

InFocus Corporation ("InFocus") warrants that the ASK, InFocus, and Proxima branded product ("Product") purchased from InFocus or an InFocus reseller will conform to the manufacturers specifications and be free from defects in material or workmanship for the Warranty period provided below. InFocus does not warrant that the Product will meet the specific requirements of the end-user customer. The Limited Warranty period commences on the date of purchase by the end-user customer. Said Limited Warranty shall apply only to the end-user purchaser (first person or entity that purchases a new Product for personal or business use and not for the purpose of distribution or resale). Any person exercising a claim under this Limited Warranty must establish to the satisfaction of InFocus both the date of purchase and that the Product was purchased new. The sales receipt or invoice, showing the date of purchase of the Product is the proof of the date of purchase. From the date of such purchase, said Limited Warranty shall continue for a period of two (2) years (parts and labor) for Projector Products; for one (1) year (parts only) for customer replaceable and Accessory Products; and for ninety (90) days or 500 hours (parts only), whichever comes first, for Lamp Products (whether purchased in projectors or separately as replacements).

During the Warranty period for the Product, Replacement lamps, which are purchased at the time of projector purchase, will have a 90-day or 500 hour Warranty, whichever comes first, from the date the spare lamp is put into use. At the sole option of InFocus, the Product will either be repaired or replaced. All exchanged parts and Products replaced under this Warranty will become property of InFocus. InFocus' sole obligation is to supply (or pay for) all labor necessary to repair the Product found to be defective within the Warranty period and to repair or replace defective parts with new parts or, at the option of InFocus, serviceable used parts that are equivalent or superior to new parts performance.

During the Warranty period, to exercise this Limited Warranty, the purchaser must first contact either InFocus, a service facility authorized by InFocus or the place of original purchase. For Warranty service, the purchaser will be advised to return or deliver the defective Product freight and all fees prepaid, to an InFocus Service Center or to a service facility authorized by InFocus. When returning Product to InFocus, a Return Material Authorization Number (RMA #) is required and must be clearly displayed on the outside of the shipping carton containing the Product. The Product is to be fully insured and packed in either its original carton or a similar package affording an equal degree of protection. InFocus or the service facility authorized by InFocus will return the repaired/replaced Product freight prepaid to the purchaser. Products returned for Warranty service must be accompanied by a written letter that: i.) explains the problem; ii) provides proof of date of purchase; iii) provides the dealer's name; and iv.) provides the model and serial number of the Product. Upon request of InFocus Corporation or an authorized repair center for InFocus, proof of legal importation must accompany the warranty repair Product, otherwise the Product must be returned to the place of original purchase, to the manufacturer (Purchaser must bear all tax, duty and freight), or the Purchaser must bear charges for the warranty repair. No repair or replacement of Product or part thereof shall extend the Warranty period as to the entire Product. Warranty on the repaired part and workmanship shall only be effective for a period of ninety (90) days following the repair or replacement of that part or the remaining period of the Product Warranty whichever is greater.

WARRANTY LIMITATION AND EXCLUSION

This Limited Warranty extends only to Products purchased from InFocus or an InFocus authorized reseller. InFocus shall have no further obligation under the foregoing Limited Warranty if the Product has been damaged due to abuse, misuse, neglect, accident, unusual physical or electrical stress, unauthorized modifications, tampering, alterations, or service other than by InFocus or its authorized agents, causes other than from ordinary use or failure to properly use the Product in the application for which said Product is intended. Limited Warranty excludes Product or accessory cleaning, repair, or replacement of plastics due to cosmetic damage and damage as a result of normal wear. Product repair outside of the terms of the Limited Warranty will be on a time and materials basis. Prolonged Product "demonstration" causes unusual Product wear and is not considered normal use under the terms of this Limited Warranty.

Accessory Warranty covers the accessory item only and excludes normal wear. Lamp Product Warranty excludes expected lamp degradation. Remanufactured Products and Software Products are exempt from the foregoing Limited Warranty. Please refer to the appropriate Remanufactured Product Limited Warranty or Software Product Limited Warranty for applicable Warranty information.

DISCLAIMER OF UNSTATED WARRANTIES

THE WARRANTY PRINTED ABOVE IS THE ONLY WARRANTY APPLICABLE TO THIS PURCHASE. ALL OTHER WARRANTIES, EXPRESS OR IMPLIED, INCLUDING, BUT NOT LIMITED TO, THE IMPLIED WARRANTIES OF MERCHANTABILITY AND FITNESS FOR A PARTICULAR PURPOSE ARE DISCLAIMED. THERE ARE NO WARRANTIES THAT EXTEND BEYOND THE FACE HEREOF AND THE FOREGOING WARRANTY SHALL NOT BE EXTENDED, ALTERED OR VARIED EXCEPT BY WRITTEN INSTRUMENT SIGNED BY INFOCUS. SOME JURISDICTIONS DO NOT ALLOW LIMITATIONS ON HOW LONG AN IMPLIED WARRANTY MAY LAST, SO SUCH LIMITATIONS MAY NOT APPLY TO YOU.

LIMITATION OF LIABILITY

IT IS UNDERSTOOD AND AGREED THAT INFOCUS' LIABILITY WHETHER IN CONTRACT, IN TORT, UNDER ANY WARRANTY, IN NEGLIGENCE OR OTHERWISE SHALL NOT EXCEED THE RETURN OF THE AMOUNT OF THE PURCHASE PRICE PAID BY PURCHASER AND UNDER NO CIRCUMSTANCES SHALL INFOCUS BE LIABLE FOR SPECIAL, INDIRECT, INCIDENTAL OR CONSEQUENTIAL DAMAGES OR LOST PROFITS, LOST REVENUES OR LOST SAVINGS. THE PRICE STATED FOR THE PRODUCT IS A CONSIDERATION IN LIMITING INFOCUS' LIABILITY. NO ACTION, REGARDLESS OF FORM, ARISING OUT OF THE AGREEMENT TO PURCHASE THE PRODUCT MAY BE BROUGHT BY PURCHASER MORE THAN ONE YEAR AFTER THE CAUSE OF ACTION HAS ACCRUED. SOME JURISDICTIONS DO NOT ALLOW THE EXCLUSION OR LIMITATION OF INCIDENTAL OR CONSEQUENTIAL DAMAGES SO THE ABOVE LIMITATION OR EXCLUSION MAY NOT APPLY TO YOU. THIS LIMITED WARRANTY GIVES YOU SPECIFIC LEGAL RIGHTS, AND YOU MAY ALSO HAVE OTHER RIGHTS, DEPENDING ON JURISDICTION.

For Americas:

InFocus Corporation
27700B SW Parkway Avenue
Wilsonville, Oregon, USA 97070-921
Phone: +1-800-294-6400/
503-685-8888
Fax: 503-685-8887
<http://www.infocus.com>
Tech Support Phone:
+1-800-799-9911

For Europe/Middle East/Africa:

InFocus Asa
Olympia 1
NL-1213 NS Hilversum
The Netherlands
Tel: +31 (0) 35 6 474 000
Fax: +31 (0) 35 6 423 999
<http://www.infocus.com>
Tech Support Phone:
+31 (0) 35 6474 010

For Asia:

InFocus Systems Asia Pte Ltd
Novena Square
238A Thomson Road
#18-01/04 Novena Square
Singapore 307684
Tel: +65 334-9005
Fax: +65 333 4525
<http://www.infocus.com>
Tech Support Phone:
+65 353 9449

 **FixYourDLP.com**
Discount-Merchant.com (800) 281-8860
THE TRUSTED SOURCE FOR PROJECTOR LAMPS AND ACCESSORIES

TABLE OF CONTENTS

INHALTSVERZEICHNIS TABLE DES MATIÈRES INDICE INDICE ÍNDICE INNHOLDSFORTEGNELSE

A. SUPPLIED MATERIAL, LIEFERUMFANG, EQUIPEMENT FOURNI, MATERIAL SUMINISTRADO, MATERIALE FORNITO, MATERIAL FORNECIDO, VEDLAGT MATERIELL	4
B. OVERVIEW, ÜBERSICHT, PRESENTATION, VISTA GENERAL, PROSPETTO, VISTA GERAL, OVERSIKT	5
C. SETTING UP PROCEDURE, ANSCHLUSS, INSTALLATION, PROCEDIMIENTO DE CONEXIÓN, PROCEDIMENTO DI IMPOSTAZIONE, INSTALAÇÃO, OPPSETT	6
D. CEILING MOUNT, DECKENMONTAGE, MONTAGE AU PLAFOND, MONTAJE EN EL TECHO, MONTAGGIO A SOFFITTO, MONTAGE DE TETO, TAKMONTERING	8
E. START - STOP, START - STOP, ALLUMER/ ÉTEINDRE, INICIO - PARADA, AVVIO - ARRESTO, LIGAR - DESLIGAR, START - STOPP	9
F. IMAGE ADJUSTMENTS, BILDEINSTELLUNGEN, MISE AU POINT DE L'IMAGE, AJUSTE DE LA IMAGEN, REGOLAZIONE DELL'IMMAGINE, AJUSTES DA IMAGEM, BILDEJUSTERINGER	10
G. REMOTE CONTROL & KEYPAD, FERNBEDIENUNG UND BEDIENFELD, TELECOMMANDE ET CLAVIER, CONTROL REMOTO Y TECLADO, TELECOMANDO E TASTIERA, CONTROLE REMOTO E TECLADO, FJERNKONTROLL OG TASTATUR	11
H. MENU ADJUSTMENTS, MENÜ EINSTELLUNGEN, OPTIONS DE MENU, MENÚ DE AJUSTES, IMPOSTAZIONI DAL MENU, AJUSTES DO MENU, MENYINNSTILLINGER	14
I. USER 'S LOGO, LOGO DES BENUTZERS, LOGO DE L'UTILISATEUR, LOGOTIPO DEL USUARIO, LOGO DELL'UTENTE, LOGOTIPO DO USUÁRIO, BRUKERDEFINERT LOGO	23
J. LIGHT MESSAGES, LEUCHTANZEIGEN, INDICATEURS LUMINEUX, INDICADORES LUMINOSOS, MESSAGGI LUMINOSI, INDICADORES LUMINOSOS, LYSSIGNALER	24
K. POWER MANAGEMENT (DPMS), POWER MANAGEMENT (DPMS), GESTION DE L'ALIMENTATION (DPMS), FUENTES DE ENERGÍA (DPMS), CONTROLLO DELL'OPERATIVITÀ (DPMS), CONTROLE DA POTÊNCIA (DPMS), STRØMSPARING (DPMS)	26
L. TROUBLESHOOTING, FEHLERBEHEBUNG, SOLUTION AUX PROBLÈMES LES PLUS FRÉQUENTS, SOLUCIÓN DE PROBLEMAS, SOLUZIONE DEI PROBLEMI, LOCALIZAÇÃO DE DEFEITOS, FEILSØKING	27
M. TECHNICAL DATA, TECHNISCHE DATEN, CARACTERISTIQUES TECHNIQUES, DATOS TÉCNICOS, DATI TECNICI, DADOS TÉCNICOS, TEKNISKE DATA	29
N. SERVICE INFORMATION, SERVICEHINWEIS, RÉPARATIONS, INFORMACIÓN SOBRE ASISTENCIA TÉCNICA, ASSISTENZA TECNICA, INFORMAÇÃO DE SERVIÇOS, SERVICEINFORMASJON	32
O. LAMP REPLACEMENT, LAMPENAUSTAUSCH, REMPLACEMENT DE LA LAMPE, SUSTITUCIÓN DE LA BOMBILLA, SOSTITUZIONE LAMPADINA, SUBSTITUIÇÃO DA LÂMPADA, LAMPESKIFT	33
P. MAINTENANCE, WARTUNG, ENTRETIEN, MANTENIMIENTO, MANUTENZIONE, MANUTENÇÃO, VEDLIKEHOLD	35
Q. FCC WARNING	36

A

SUPPLIED MATERIAL

LIEFERUMFANG EQUIPEMENT FOURNI MATERIAL SUMINISTRADO MATERIALE FORNITO MATERIAL FORNECIDO VEDLAGT MATERIELL

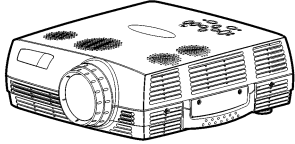

LCD Projector with lenscap
 LCD Projektor mit Schutzkappe
 Projecteur LCD avec protection lentille
 Projector LCD con tapa del lente
 Proiettore LCD con coperchietto
 Projektor LCD com protetor de lente
 LCD-projektor med linsedeksel

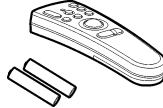

Remote control with batteries
 Fernbedienung mit Batterien
 Télécommande avec batteries
 Control remoto con pilas
 Telecomando con batterie
 Controle remoto com pilhas
 Fjernkontroll med batterier

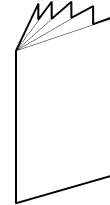

Product documentation
 Produktunterlagen
 Description du produit
 Documentación del producto
 Documentazione del Prodotto
 Documentação do produto
 Produktdokumentasjon

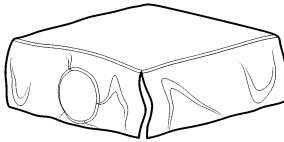

Dust cover
 Schutzabdeckung
 Couvercle cache-poussière
 Tapa
 Protezione dalla polvere
 Capa de protecção
 Støvdæksel

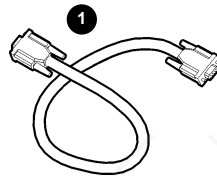

Computer Cable (VGA)
 Computerkabel (VGA)
 Câble d'ordinateur (VGA)
 Cable informático (VGA)
 Cavo per il computer (VGA)
 Cabo do Computador (VGA)
 Datamaskinkabel (VGA)

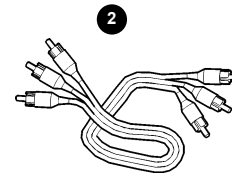

Audio/Video Cable
 Audio/Videokabel
 Câble audio/vidéo
 Conexión de audio/vidéo
 Cavo audio/vidéo
 Cabo de Áudio/Vídeo
 Audio/Videokabel

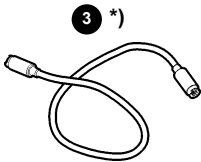

S-Video Cable
 S-Videokabel
 Câble S-Video
 Cable de Video-S
 Cavo S-Video
 Cabo de S-Video
 S-Videokabel

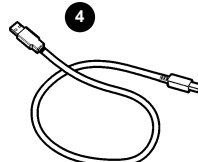

USB Mouse Cable
 USB Maus kabel
 Câble souris USB
 Cable raton USB
 Cavo mouse USB
 Cabo de Mouse USB
 USB-musekabel

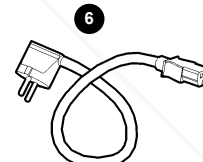

Power cord
 Netzkabel
 Cordon d'alimentation
 Cable de alimentación
 Cavo alimentazione
 Cabo de alimentação
 Strømlledning

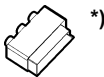

SCART adapter
 SCART-Anschluß
 Adaptateur SCART
 Adaptador de SCART
 Pice SCART
 Adaptador SCART
 SCART-adapter



Discount-Merchant.com (800) 281-8860

THE TRUSTED SOURCE FOR PROJECTOR LAMPS AND ACCESSORIES

*) Country dependent Lander abhangig Dependant du pays Dependente del pais Dipendentemente al paese di destinazione Dependendo do pais Omradeafhengig

B

OVERVIEW

BESTANDTEILE PRESENTATION VISTA GENERAL PROSPETTO VISTA GERAL OVERSIKT

- 1 IR Sensor
IR-Sensor
Senseur IR
Sensor de IR
Sensore IR
Sensor IR
IR-Sensor
- 2 Focus
Fokus
Poignée
Foco
Messa a fuoco
Foco
Fokus
- 3 Zoom

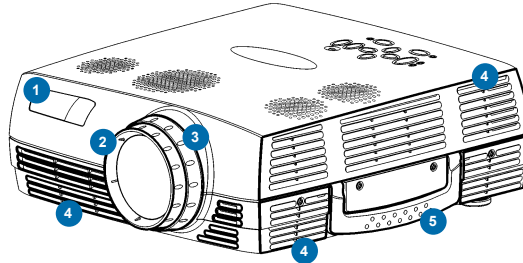

- 4 Ventilation in
Lufteintritt
Entrée ventilation
Entrada de ventilación
Griglia di ventilazione di entrata
Entrada de ventilação
Ventilasjon inn
- 5 Handle
Tragegriff
Mise au point
Asa
Manico
Punho
Håndtak

- 6 Speakers
Lautsprecher
Haut-parleurs
Altavoces
Altoparlanti
Alto-falantes
Høytalere
- 7 Keypad
Bedienfeld
Clavier
Teclado
Tastiera
Teclado
Tastatur
- 8 Kensington lock
Kensington-Verschluss
Verrou Kensington
Cerradura Kensington
Bloccaggio Kensington
Trava Kensington
Kensington-lås

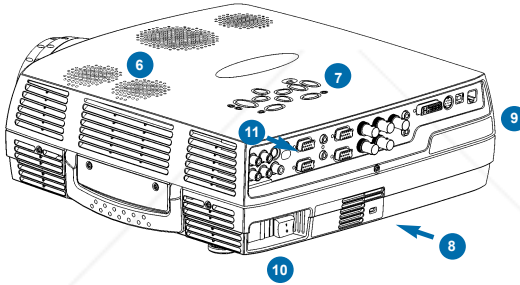

- 9 Connectors
Anschlüsse
Connecteurs
Conectores
Connettori
Conectores
Kontaktter
- 10 Power in and power switch
Leistung und Hauptschalter
Allumage et interrupteur de contact
Entrada de alimentación e interruptor de alimentación.
Power - in ed interruttore di corrente
Interrupor de força e interruptor principal
Strøm inn og strømbryter
- 11 IR Sensor
IR-Sensor
Senseur IR
Sensor de IR
Sensore IR
Sensor IR
IR-Sensor

- 12 Ventilation out
Luftaustritt
Sortie ventilation
Salida de ventilación
Griglia di ventilazione di uscita
Saída de ventilação
Ventilasjon ut
- 13 Adjustable foot
Höhenverstellbarer Fuß
Pieds réglables
Pata ajustable
Piede regolabile
Pé ajustável
Justerbar fot
- 14 Ventilation in
Lufteintritt
Entrée ventilation
Entrada de ventilación
Griglia di ventilazione di entrata
Entrada de ventilação
Ventilasjon inn

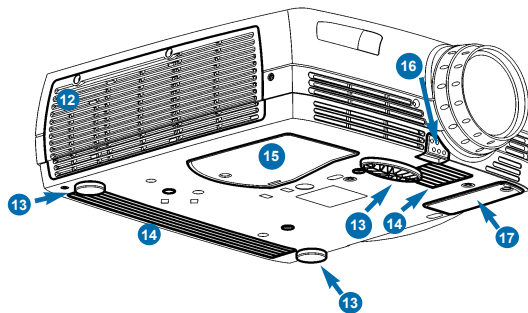

- 15 Lamp housing
Lampenfach
Support de lampe
Lugar para la lámpara
Scomparto lampadina
Compartmento da lâmpada
Lampehus
- 16 Foot release
Fußauflöser
Releaser de pied
Liberación del pie
Sblocco il piede
Soltura dos pés
Fotuløser
- 17 Dust filter
Staubfilter
Filtre de la poussière
Filtre del polvo
Filtro della polvere
Filtro da poeira
Støvfilter



Sponsored by

Discount-Merchant.com (800) 281-8860

THE TRUSTED SOURCE FOR PROJECTOR LAMPS AND ACCESSORIES

C

SETTING UP PROCEDURE

ANSCHLUSS INSTALLATION PROCEDIMIENTO DE CONEXIÓN PROCEDIMENTO DI IMPOSTAZIONE INSTALAÇÃO OPPSETT

1. Connect the projector to:
 - the Data source with the Computer Cable (VGA) (1).
 - the Video source with the Audio/Video Cable (2).
 - the S-Video source with the S-Video cable* (3).
2. For mouse control, connect:
 - the USB Mouse Cable (4) to USB.
3. For computer sound connection, use the Audio Cable* (5) to Audio in.
4. Connect "Power Cord"* (6) to the projector.
5. Turn the projector on. Ref.chap.E

1. Anschließen des Projektors:
 - mit dem Computerkabel (VGA) (1) an die Datenquelle.
 - mit dem Audio- / Videokabel (2) an die Videoquelle.
 - mit dem S-Videokabel* (3) an die S-Videoquelle.
2. Für die Steuerung der Maus:
 - Anschluss des USB Mauskabels (5) an USB.
3. Für den Soundanschluss an den Computer verwenden Sie das Audiokabel* (5) in Audio in.
4. Anschließen des "Stromkabels"* (6) an den Projektor.
5. Schließen Sie der Projektor an. Siehe Kap.E

1. Brancher le projecteur à:
 - la source de données avec le câble de l'ordinateur (VGA) (1).
 - la source vidéo avec le câble audio/vidéo (2).
 - la source S-Vidéo avec le câble S vidéo* (3).
2. Contrôle de la souris, brancher:
 - le câble de la souris USB (4) au port USB.
3. Pour brancher le son sur l'ordinateur, brancher le câble audio* (5) sur Audio in.
4. Brancher le projecteur avec le "cordon d'alimentation"* (6).
5. Allumez le projecteur. Voir chap. E

1. Conectar el proyector a:
 - la fuente de datos con el cable informático (VGA) (1).
 - la fuente de vídeo con el cable de audio/vidéo (2).
 - la fuente S-Vidéo con el cable S-Vidéo* (3).
2. Para controlar el ratón, conecte:
 - el cable de ratón USB (4) al puerto USB.
3. Para la conexión del sonido en el ordenador, conecte el cable de audio* (5) en Audio in.
4. Conecte el cable de corriente* (6) en el proyector.
5. Encienda el proyector. Ref. cap. E

1. Collegare il proiettore a:
 - la fonte Dati con il Cavo Computer (VGA) (1).
 - la fonte Video con il cavo Audio/Video (2).
 - la fonte Video - S con il cavo* S-Video (3).
2. Per il controllo del mouse, collegare:
 - il cavo* USB del Mouse (4) all' USB.
3. Per la collegamento audio con il computer, impiegare il Cavo Audio* (5) collegato a Audio in.
4. Collegare il "Cavo di Alimentazione"* (6) al proiettore.
5. Accendere il proiettore. Rif. cap. E

1. Ligue o projector:
 - à fonte de dados com o cabo do computador (VGA) (1).
 - à fonte de vídeo com o cabo de áudio/vidéo (2).
 - à fonte de S-Vidéo com o cabo de S-Vidéo* (3).
2. Para controlo com o rato, ligue:
 - o cabo USB do rato (4) à porta USB.
3. Para conexão de áudio no computador, utilize o cabo de áudio* (5) em Audio in (Entrada De Áudio).
4. Conecte o cabo de alimentação* (6) ao projector.
5. Gire sobre o projetor. Ref.Cap.E

1. Koble projektoren til:
 - datakilden med Datamaskinkabelen (VGA) (1).
 - videokilden med Audio/Video-kabelen (2).
 - S-Videokilden med S-Videokabelen* (3).
2. For muskontroll kobler du:
 - USB-musekabelen (4) til USB.
3. Hvis du vil koble til lyd fra datamaskinens, kobles Audio-kabelen* (5) til Audio in.
4. Koble strømledningen* (6) til projektoren.
5. Slå på projektoren. Se kap. E



Discount-Merchant.com (800) 281-8860

THE TRUSTED SOURCE FOR PROJECTOR LAMPS AND ACCESSORIES

*) Country dependent Länder abhängig Dépendant du pays Dependé del país Dipendentemente al paese di destinazione Dependendo do país Områdeafhængig

SETTING UP PROCEDURE

ANSCHLUSS INSTALLATION PROCEDIMIENTO DE CONEXIÓN PROCEDIMENTO DI IMPOSTAZIONE INSTALAÇÃO OPPSETT

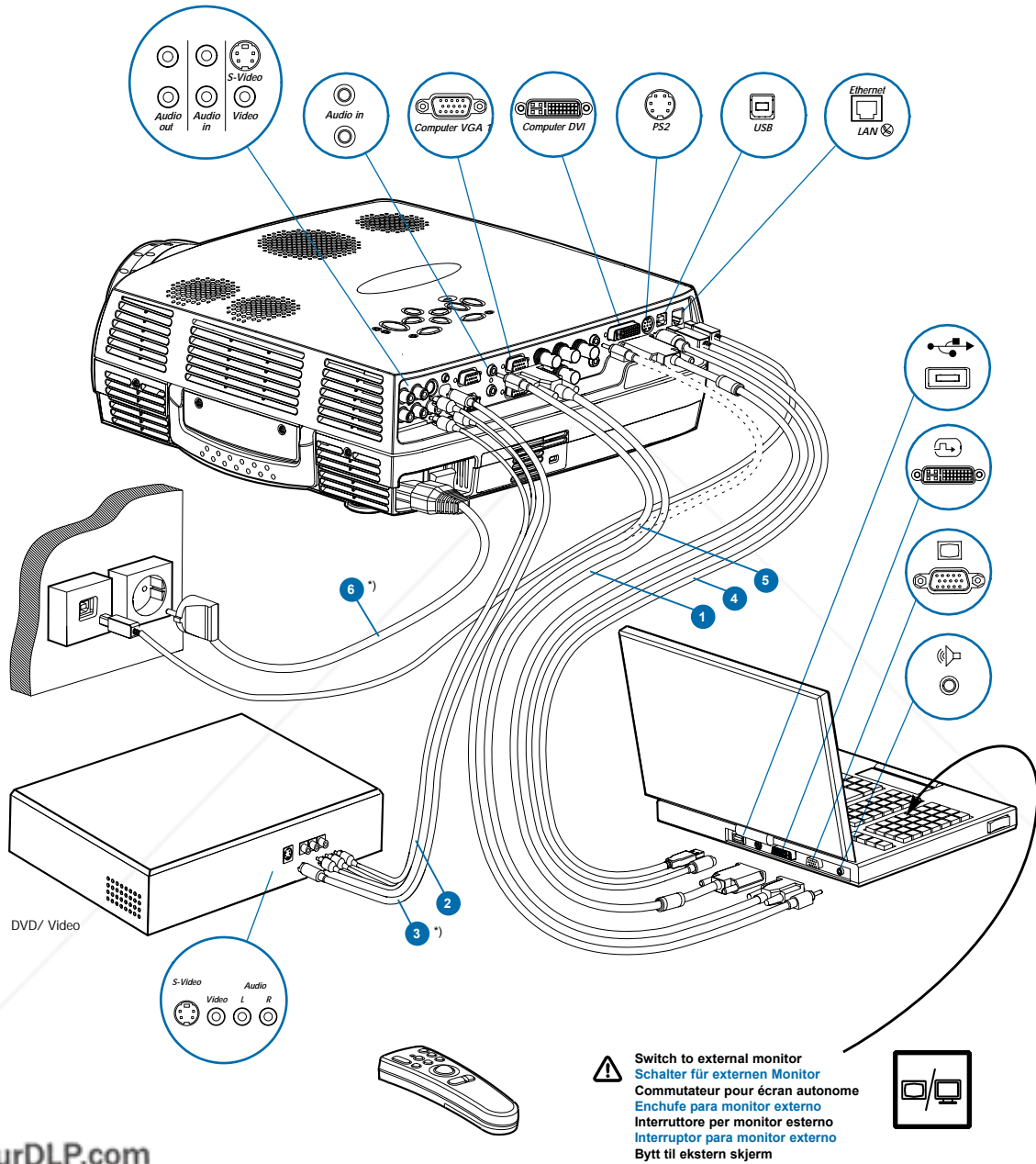

FixYourDLP.com
Sponsored by DM

Discount-Merchant.com (800) 281-8860

THE TRUSTED SOURCE FOR PROJECTOR LAMPS AND ACCESSORIES

D

CEILING MOUNT

DECKENMONTAGE MONTAGE AU PLAFOND MONTAJE EN EL TECHO MONTAGGIO A SOFFITTO MONTAGE DE TETO TAKMONTERING



Ceiling mount (use M4 screw). Min. distance from ceiling/rear wall: 30/50 cm, 12/20 inch for proper ventilation.
Deckenmontage (M4-Schrauben verwenden). Mindestabstand von der Decke/rückwand 30/50 cm, damit eine korrekte Belüftung gewährleistet ist.
Montage au plafond (utilisez un tournevis M4). Distance minimum au plafond/mur arrière: 30/50 cm, pour garantir une ventilation adéquate.
Soporte de techo (utilice un tornillo de M4). Distancia mínima desde el techo/pared posterior: 30/50 cm, para que exista una ventilación correcta.
Montaggio a soffitto (utilizzare viti da M4). Distanza minima dal soffitto/muro posteriore 30/50 cm, per una ventilazione adeguata.
Montagem de teto (use parafuso de M4). Distância min. teto/parede traseira: 30/50 cm, para uma ventilação adequada.
Takbeslag (bruk M4 skrue). Min. distanse fra tak/bakvegg: 30/50 cm, 12/20 tommer, for å få tilstrekkelig ventilasjon.



To avoid personal injury, use only approved ceiling mount. Ref. chap. M
Um Verletzungen zu vermeiden, nur autorisierte Deckenaufhängungen verwenden. Siehe Kap. M
Utiliser exclusivement une fixation plafonnière agréée afin de prévenir tout risque de dommage corporel. Voir chap. M
Para evitar daños personales, utilice únicamente el dispositivo de montaje en techo homologado. Ref. cap. M
Per evitare lesioni personali, utilizzare esclusivamente supporti per il montaggio al soffitto approvati. Rif. cap. M
Para evitar lesões pessoais, no tecto use apenas suporte autorizado. Ref. cap. M
For å unngå personskader, bruk kun godkjent takbeslag. Se kap. M

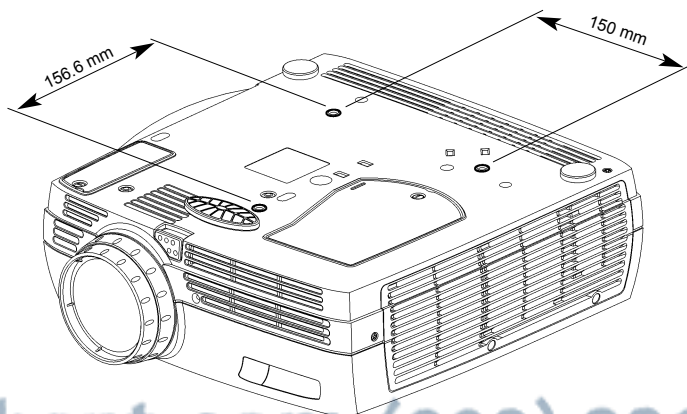
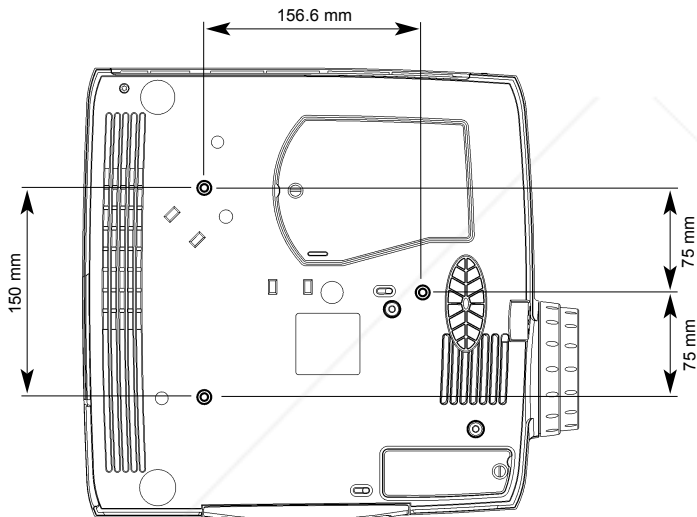



START - STOP

START - STOP ALLUMER/ÉTEINDRE INICIO - PARADA AVVIO - ARRESTO LIGAR - DESLIGAR START - STOP

Install batteries.
Batterien einlegen.
Mettre des piles en place.
Colocar las baterías.
Inserimento pile.
Colocar as pilhas.
Sett inn batteriene.

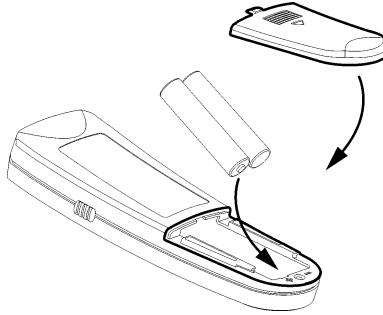

Switch ON to operate remote control.
Auf ON stellen, um die Fernbedienung einzuschalten.
Mettez sur position ON pour utiliser la télécommande.
Poner el conmutador en ON para activar el control remoto.
Posizionare su ON per attivare il telecomando.
Coloque em on para ligar o controle remoto.
Trykk på ON for å slå på fjernkontrollen.

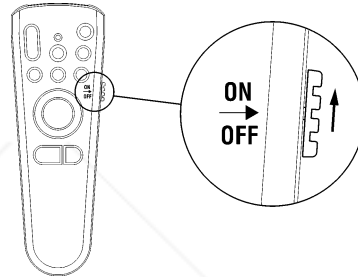

Press the power switch to turn on projector.
Drücken Sie den Hauptschalter, um den Projektor einzuschalten.
Appuyez sur l'interrupteur de contact pour allumer le projecteur.
Pulse el interruptor de alimentación para encender el proyector.
Premere l'interruttore di alimentazione per accendere il proiettore.
Azione o interruptor principal para girar sobre o projetor.
Trykk på strømbryteren for å koble til projektoren.

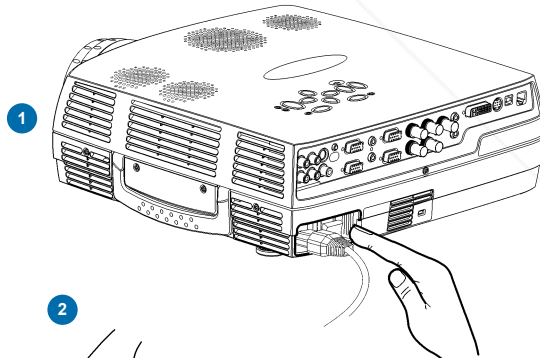

Press the power button to start the projector.
Drücken Sie die Energie Taste, um den Projektor zu starten.
Appuyez sur la touche de marche pour faire démarrer le projecteur.
Encienda el botón de la potencia para poner en marcha el proyector.
Premere il tasto di potenza per accendere il proiettore.
Aperte a tecla da potência para acionar o projetor.
Trykk på POWER for å starte projektoren.

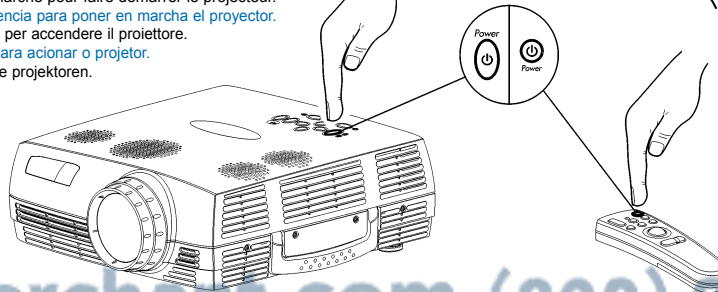

F

IMAGE ADJUSTMENT

BILDEINSTELLUNG MISE AU POINT DE L'IMAGE ADJUSTE DE LA IMAGEN REGOLAZIONE ELL'IMMAGINE ADJUSTES DA IMAGEM JUSTERER BILDDET

- 1** Zoom: adjusts picture size.
Zoom: Einstellen der Bildgröße.
Zoom: règle les dimensions de l'image.
Zoom: ajusta el tamaño de la imagen.
Zoom: regola le dimensioni dell'immagine.
Zoom: ajusta o tamanho da imagem.
Zoom: justerer bildets størrelse.

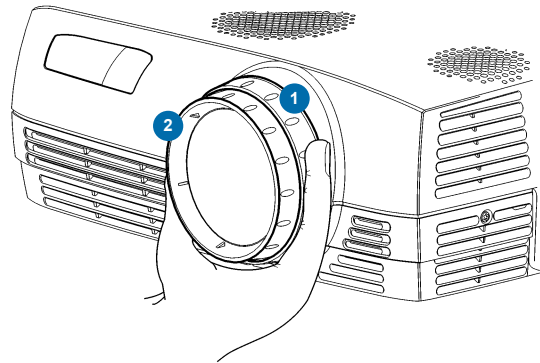

- 2** Focus: adjusts picture sharpness.
Focus: Einstellen der Bildschärfe.
Focus: règle la netteté de l'image.
Foco: ajusta la claridad de la imagen.
Focus: regola la messa a fuoco dell'immagine.
Foco: ajusta a nitidez da imagem.
Fokus: justerer bildets skarphet.

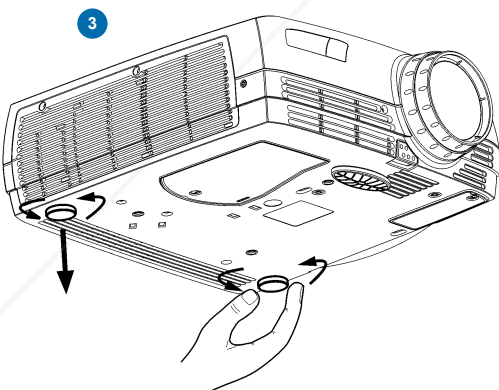
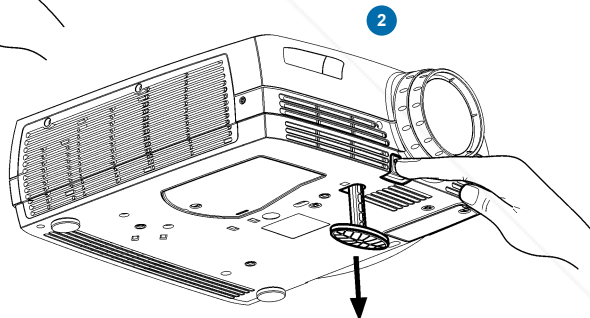
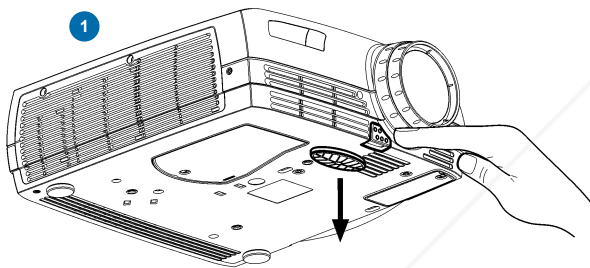

- Release the projection-foot to adjust display angle (1+2) and manually adjust rear-feet (3).
Lösen Sie den Projektionsfuß, um den Anzeigewinkel einzustellen (1+2), und stellen sie manuell die hinteren Füße (3) ein.
Dévissez le pied de projection pour régler l'angle d'affichage (1+2) et réglez manuellement les pieds arrière (3).
Suelte el pie de proyección para ajustar el ángulo de visualización (1+2) y ajuste manualmente los pies traseros (3).
Allentare il piedino di proiezione per regolare l'angolazione del monitor (1+2) ed regolare manualmente il piedino posteriore (3).
Solte o pedal de projeção para ajustar o ângulo de visualização (1+2) e ajuste manualmente o pedal posterior (3).
Løs ut projektorfoten slik at du kan tilpasse visningsvinkelen (1+2), og juster føttene bak på projektoren manuelt (3).



REMOTE CONTROL & KEYPAD

FERNBEDIENUNG UND BEDIENFELD TELECOMANDE ET CLAVIER

CONTROL REMOTO Y TECLADO TELECOMANDO E TASTIERA CONTROLE REMOTO E TECLADO FJERNKONTROLL OG TASTATUR

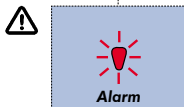
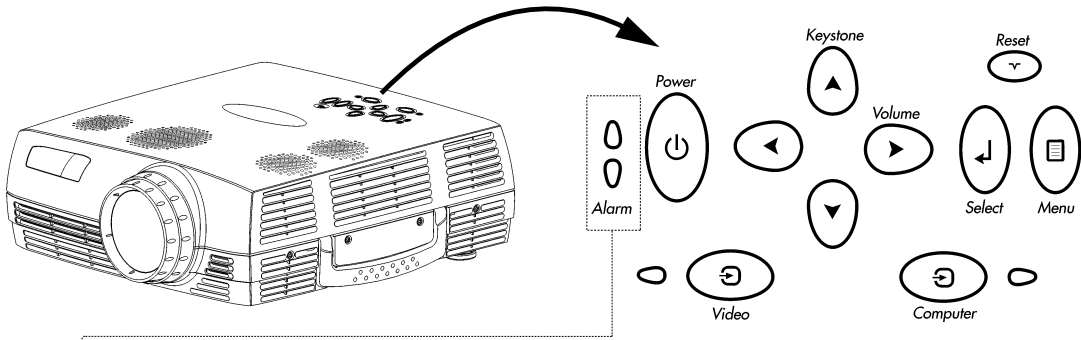

RED light indicates lamp replacement required. Ref. chap.O and chap. J
Das ROTE Licht zeigt an, daß die Lampe ausgewechselt werden muß. Siehe Kap. O, und Kap. J
La lumière ROUGE indique que la lampe doit être remplacée. Voir. chap. O et cap. J
La luz ROJA indica que se debe de reemplazar la bombilla. Ref. cap. O y cap. J
La luce ROSA indica che bisogna sostituire la lampadina. Rif. cap. O ed cap. J
A luz VERMELHA indica que a lâmpada deve ser substituída. Ref. cap. O e cap. J
RØDT lys angir at lampen må byttes ut. Se kap. O og kap. J

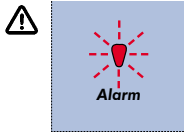

RED FLASHING when the projector is overheated. Power off and let cool down.
ROTES BLINKLICHT zeigt Überhitzung des Projektors an. Ausschalten und abkühlen lassen.
Un CLIGNOTEMENT ROUGE signale la surchauffe du projecteur. Débrancher l'alimentation et laisser refroidir.
LUZ ROJA PARPADEANTE cuando el proyector está sobrecalentado. Desconectar la alimentación y dejar enfriar.
La luce ROSSA INTERMITTENTE indica che il proiettore si è surriscaldato. Scollegare l'alimentazione e lasciare raffreddare.
A luz VERMELHA INTERMITENTE indica superaquecimento do projector. Desligar e deixar esfriar.
RØDT BLINKENDE når projektoren er overopphetet. Slå av og la projektoren avkjøle seg.

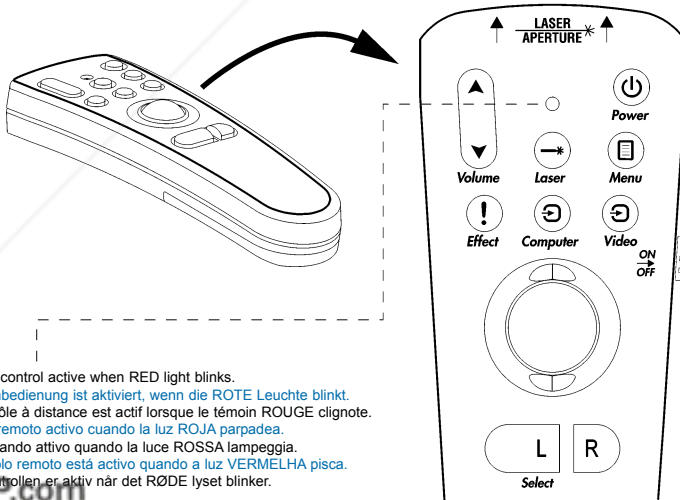

Remote control active when RED light blinks.
Die Fernbedienung ist aktiviert, wenn die ROTE Leuchte blinkt.
Le contrôle à distance est actif lorsque le témoin ROUGE clignote.
Control remoto activo cuando la luz ROJA parpadea.
Telecomando attivo quando la luce ROSSA lampeggia.
O control remoto está activo quando a luz VERMELHA pisca.
Fjernkontrollen er aktiv når det RØDE lyset blinker.

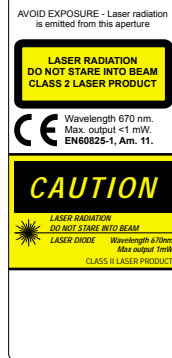

REMOTE CONTROL & KEYPAD

FERNBEDIENUNG UND BEDIENFELD TELECOMMANDE ET CLAVIER

CONTROL REMOTO Y TECLADO TELECOMANDO E TASTIERA CONTROLE REMOTO E TECLADO FJERNKONTROLL OG TASTATUR

Activate by pressing actual key(s).
 Zum Aktivieren jeweilige Taste(n) drücken.
 Aktiver en pressant la (les) touches correspondante(s).
 Activar pulsando la(s) tecla(s) indicativa(s).
 Attivare premendo il / i tasto / i attivi.
 Ativar pressionando a(s) tecla(s) correspondante(s).
 Aktiver ved å trykke på aktuell(e) tast(er).

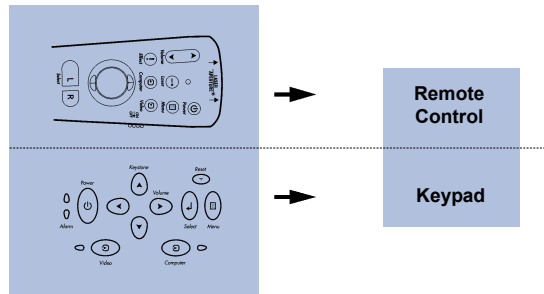

<p>Turns the projector ON/OFF. Projektor ein-/ausschalten. Allume (ON)/Eteint (OFF) le projecteur. Encender (ON)/Apagar (OFF) el proyector. Accensione del proiettore ON/OFF. Liga e Desliga o projetor. Slår projektoren PÅ/AV.</p>	<p>Adjust volume. Lautstärke einstellen. Réglage du volumen. Ajustar el volumen. Regolazione del volume. Ajusta o volume. Juster lydstyrken.</p>	<p>Switch between connected sources. Zwischen angeschlossenen Geräten hin- und herschalten. Passage d'une source connectée à une autre source connectée. Conmutar entre las fuentes conectadas. Commutazione fra le sorgenti collegate. Alterna entre as fontes conectadas. Bytt mellom de tilkoblede kildene.</p>
--	--	--

<p>Adjust keystone angle. Winkel Trapezverzerrung einstellen. Réglage de l'angle de la clef de voûte. Ajustar el ángulo de distorsión de imagen. Regolazione dell'angolo di distorsione. Ajusta o ângulo trapezoidal. Juster keystone-vinkelen.</p>	<p>Synchronizes the projector settings to the active source. Synchronisiert die Projektoreinstellungen für die aktive Quelle. Synchronise les paramètres du projecteur avec la source active. Sincroniza las configuraciones del proyector con la fuente activa. Sincronizzazione delle impostazioni del proiettore sulla sorgente attiva. Sincroniza a configuração do projetor com a fonte ativa. Synkroniserer projektorens innstillinger med den aktive kilden.</p>
---	---

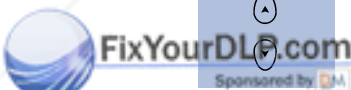

REMOTE CONTROL & KEYPAD

FERNBEDIENUNG UND BEDIENFELD TELECOMMANDE ET CLAVIER

CONTROL REMOTO Y TECLADO TELECOMANDO E TASTIERA CONTROLE REMOTO E TECLADO FJERNKONTROLL OG TASTATUR

Activates/deactivates on screen menu (OSD).
Bildschirmenü aktivieren/deaktivieren (OSD).
Active/Désactive le menu sur l'écran (OSD).
Activa/desactiva el menú en pantalla.
Attivazione/disattivazione del menù sullo schermo.
Ativa/desativa o menu da tela.
Aktiverer/deaktiverer menyvisning på skjermen (OSD).

Scroll menu.
Menüpunkte ansteuern.
Menu déroulant.
Desplegar menú.
Scorrimento del menù.
Desloque-se no menu.
Gå gjennom menyen.

Select on-screen menu function.
Funktion des Bildschirmenüs aktivieren.
Sélectionnez une fonction du menu sur l'écran.
Seleccionar función de menú en pantalla.
Selezione della funzione sul menù dello schermo.
Selecione uma função no menu da tela.
Velg aktuell funksjon i menyen på skjermen.

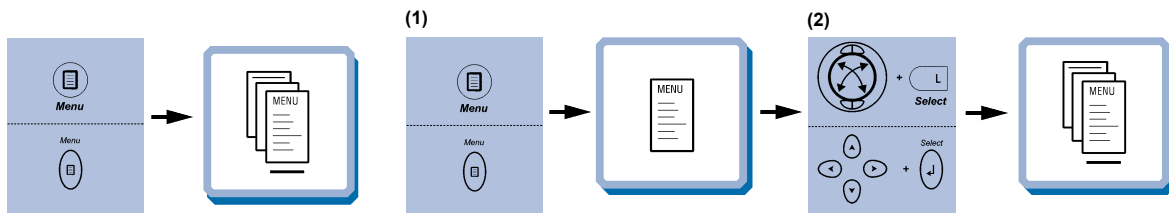

Mouse control
Steuerung der Maus
Contrôle de la souris
Control del ratón
Controllo del mouse
Controlo por rato
Musekontroll

Press to instantly invoke the presentation effect assigned through the "Effects" menu. Ref. chap. H
Drücken Sie, um unmittelbar den Präsentationseffekt aufzurufen, der über das Menü "Effects" eingestellt wurde. Siehe Kap. H
Appuyer pour faire apparaître les effets spéciaux disponibles assignés dans le menu "Effets". Voir chap. H
Pulse para obtener, de forma inmediata, el efecto de presentación asignado mediante el menú "Efectos". Ref. cap. H
Premere per richiamare immediatamente l'effetto presentazione assegnato tramite il menu "Effeiti". Rif. cap. H
Aperte para obter instantaneamente o efeito da apresentação determinado através do menu "Efeitos". Ref. cap. H
Trykkes når du vil ta i bruk presentasjonseffekten som er tilordnet ved hjelp av "Effekt" menyen. Se kap. H

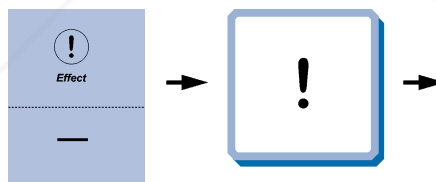
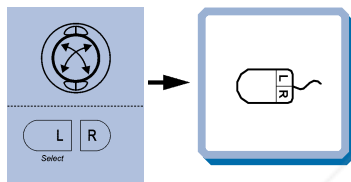

Press to zoom into picture (default setting).
Drücken, um Bild zu vergrößern (standardeinstellung).
Cliquez dans l'image pour faire un zoom (Paramètres par défaut).
Pulse para acercar la imagen (Configuración por defecto).
Premere per ingrandire l'immagine (impostazione di default).
Pressione para efetuar o "zoom" da imagem (Configuração predefinida).
Press for å forstørre bildet (standardinnstilling).

Press to pan.
Drücken, um den Bildausschnitt zu wählen
Cliquez pour faire un panoramique.
Pulse para panorámica.
Premere per una panoramica.
Pressione para "pan".
Press for å bevege bildet.

Reset picture to full size.
Zurück zur Originalgröße.
Retour de l'image à ses dimensions.
Restablecer la imagen a tamaño completo.
Ripristino dell'immagine all dimensioni maxime.
Reajuste a imagem a seu tamanho máximo.
Tilbakestill bildet til full størrelse.

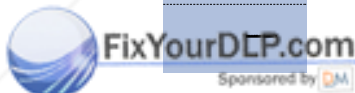
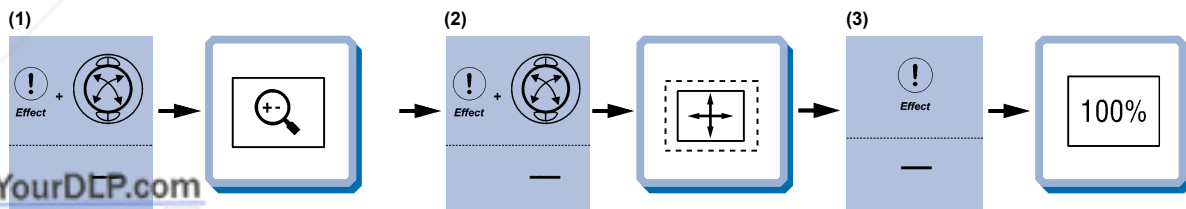

Discount-Merchant.com (800) 281-8860

THE TRUSTED SOURCE FOR PROJECTOR LAMPS AND ACCESSORIES

H MENU ADJUSTMENTS

MENÜEINSTELLUNGEN OPTIONS DE MENU MENÚ DE AJUSTES IMPOSTAZIONI DAL MENU AJUSTES DO MENU MENYINNSTILLINGER

Activate/deactivate by:
 Aktivieren/Deaktivieren mit:
 Activer et désactiver à l'aide:
 Activar/desactivar pulsando:
 Attivare/disattivare premendo:
 Ativa/Desativa com:
 Aktiver/deaktiver med:

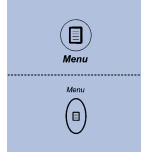

Navigate by:
 Steuern mit:
 Pour naviguer:
 Navegar pulsando:
 Spostasi premendo:
 Navegar com:
 Naviger med:

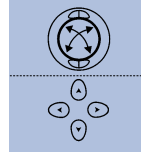

Choose function with:
 Funktion wählen mit:
 Choisissez la fonction avec:
 Seleccionar función con:
 Scegliere la funzione:
 Escolha a função:
 Velg funksjon med:

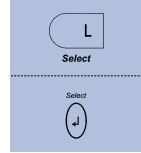

1.0

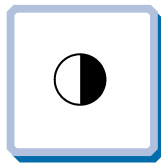

Adjusts contrast range from 0-100.
 Kontrast von 0-100 einstellen.
 Règle le contraste entre 0 et 100.
 Ajusta el contraste entre 0-100.
 Regolazione del contrasto da 0 a 100.
 Ajusta o contraste de 0 a 100.
 Justerer kontrasten innenfor området 0-100.

2.0

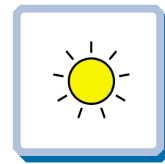
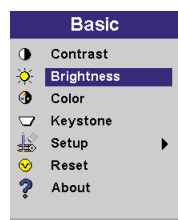

Adjusts brightness range from 0-100.
 Helligkeit von 0-100 einstellen.
 Règle la luminosité entre 0 et 100.
 Ajusta el brillo entre 0-100.
 Regolazione della luminosità da 0 a 100.
 Ajusta o brilho de 0 a 100.
 Justerer lysstyrken innenfor området 0-100.

3.0



Adjusts colour intensity in video images from 0-100.
 Farbintensität von Videobildern von 0-100 einstellen.
 Règle l'intensité de la couleur des images vidéo entre 0 et 100.
 Ajusta la intensidad del color de la imagen video entre 0-100.
 Regolazione dell'intensità del colore da 0 a 100 nelle immagini video.
 Ajusta a intensidade da cor em imagens de video de 0 a 100.
 Justerer fargeintensiteten til videobilder fra 0-100.

4.0

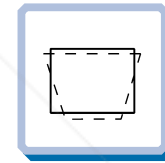
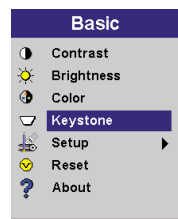

Adjust keystone from -63 to +64.
 Trapezentzerrung von -63 bis +64 einstellen.
 Règle la clé de voûte -63 et +64.
 Ajusta la distorsión de imagen desde -63 a +64.
 Regolazione della distorsione da -63 a +64.
 Ajusta o ângulo trapezoidal de -63 a +64.
 Justerer keystone-funksjonen fra -63 til +64.

5.0



5.1

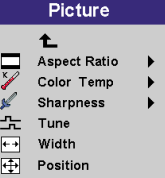
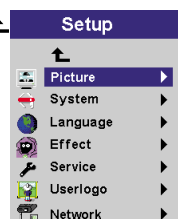

Discount-Merchant.com (800) 281-8860
 THE TRUSTED SOURCE FOR PROJECTOR LAMPS AND ACCESSORIES

MENU ADJUSTMENTS

MENÜEINSTELLUNGEN OPTIONS DE MENU MENÚ DE AJUSTES IMPOSTAZIONI DAL MENU AJUSTES DO MENU MENYINNSTILLINGER

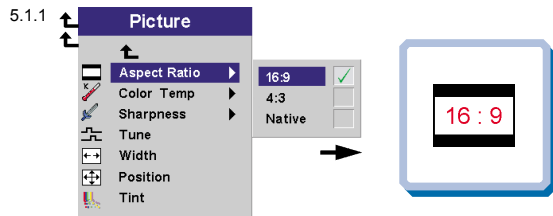

Select image format.
Bildformat auswählen.
Sélectionner le format d'image.
Selezione el formato de la imagen.
Selezioni il formato di immagine.
Selezione o formato da imagem.
Velg formatet for bildet.

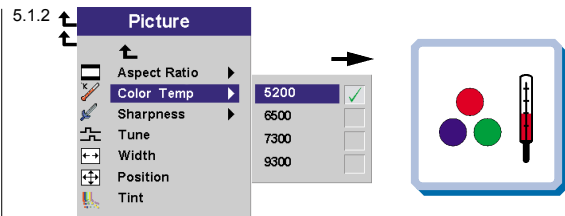

Modifies color temperature balance.
Veränderung des Farbtemperaturwertes.
Modifie l'équilibre de la température couleur.
Modifica el equilibrio de temperatura del color.
Modifica dell'equilibrio della temperatura di colore.
Modifica o equilibrio da temperatura da cor.
Endrer balansen for fargetemperatur.

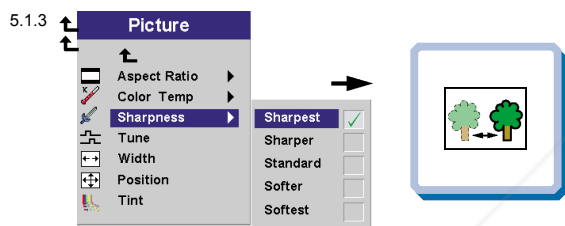

Adjusts sharpness in video images.
Einstellung der Schärfe von Videobildern.
Règle la netteté des images vidéo.
Ajusta la nitidez de la imagen de vídeo.
Regolazione della nitidezza dell'immagine video.
Ajusta a nitidez nas imagens de vídeo.
Justerer skarpheten i videobilder.

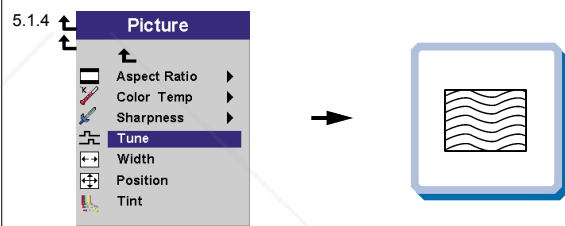

Adjusts horizontal phase/fine tunes computer analog image.
Einstellung der Horizontalfrequenz/Feinabgleich für analoge Computerbilder.
Règle la phase horizontale/met au point l'image analogique de l'ordinateur.
Ajusta la fase horizontal/sintoniza la imagen del ordenador analógico.
Regolazione della fase orizzontale/sintonizzazione fine dell'immagine analogica del computer.
Ajusta as sintonias fase/fina horizontais da imagem analógica de computador.
Justerer den horisontale faser/finstiller datamaskinens analoge bilde.

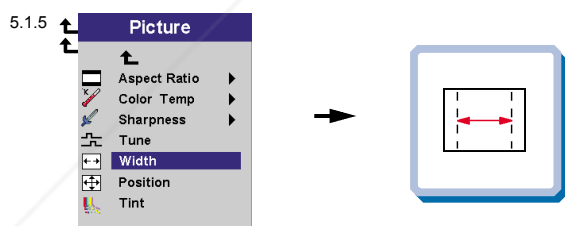

Adjusts width to computer analog image size.
Anpassung der Breite auf Größe des analogen Computerbildes.
Règle la largeur à la dimension de l'image analogique de l'ordinateur.
Ajusta el ancho al tamaño de la imagen del ordenador analógico.
Regolazione della larghezza alla dimensione dell'immagine analogica del computer.
Ajusta a largura da imagem analógica de computador.
Justerer bredden på datamaskinens analoge bilde.

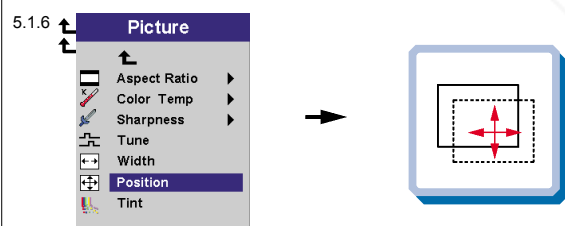

Adjusts position to computer analog and video image.
Stellt die Position des analogen und des Videobildes des Computers ein.
Règlez la position pour les images analogiques et vidéo.
Ajusta la posición a imágenes analógicas de ordenador y de vídeo.
Regola la posizione in base all'immagine analogica e video del computer.
Ajusta a posição para imagem de computador analógica e de vídeo.
Justerer plasseringen av analogt datamaskinbilde og videobilde.

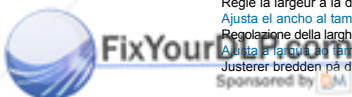

Discount-Merchant.com (800) 281-8860

THE TRUSTED SOURCE FOR PROJECTOR LAMPS AND ACCESSORIES

MENU ADJUSTMENTS

MENÜEINSTELLUNGEN OPTIONS DE MENU MENÚ DE AJUSTES IMPOSTAZIONI DAL MENU AJUSTES DO MENU MENYINNSTILLINGER

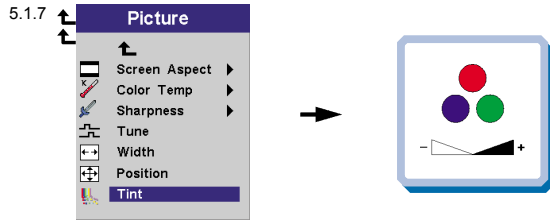

Varies the hue in video NTSC images from 0-100.
 Veränderung der Farbe von NTSC Videobildern von 0-100.
 Modifie le ton des images NTSC vidéo de 0 à 100.
 Varia la tonalidad de la imagen de video NTSC entre 0-100.
 Variazione della tonalità cromaticada 0 a 100 nelle immagini video NTSC.
 Varia a tonalidade em imagens de video NTSC de 0 a 100.
 Endrer fargenyansen til NTSC-videobilder innenfor området 0-100.

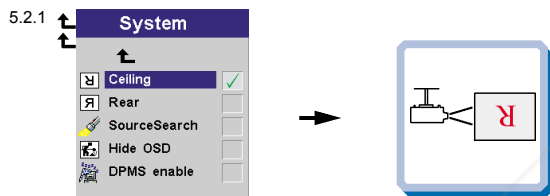
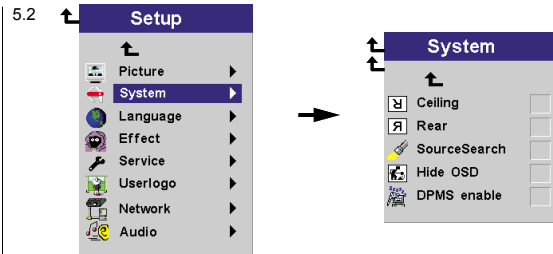

Select for ceiling mounted projection.
 Markieren für Projektion bei Deckenmontage.
 Sélectionner pour la projection appareil au plafond.
 Seleccionar para proyección montada en el techo.
 Selezione per la proiezione con montaggio al soffitto.
 Seleção para projeção com montagem no tecto.
 Velges hvis du vil bruke takmontert projeksjon.

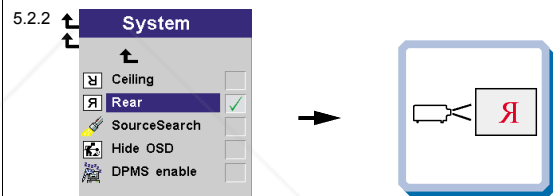

Select for rear projection.
 Markieren für Projektion von hinten.
 Sélectionner pour afficher l'information réparations.
 Seleccionar para proyección de transparencias.
 Selezione per la retroproiezione.
 Seleção para projeção de serviço autorizado.
 Velges hvis du vil bruke bakprojeksjon.

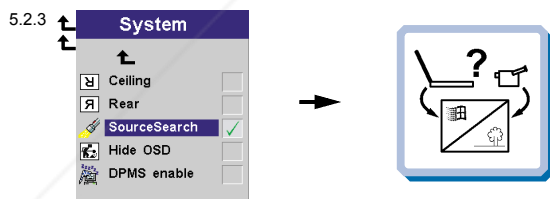

Select to activate / deactivate automatic source search.
 Entsprechend wählen, um automatische Quellensuche zu aktivieren.
 Sélectionnez 'activer/désactiver' la recherche automatique de source.
 Seleccionar para activar/desactivar la búsqueda automática del origen.
 Selezionare per attivare/disattivare la ricerca della sorgente automatica.
 Seleção para ativar/desativar a busca automática.
 Velges om automatisk kildesøking skal være aktiv/inaktiv.

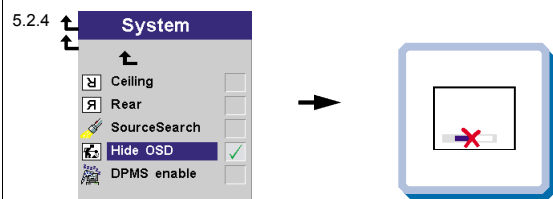

Select to hide On Screen Display (OSD).
 Markieren, um Bildschirmmenü zu verbergen.
 Sélectionner pour effacer l'affichage sur l'écran.
 Seleccionar para ocultar la presentación en pantalla.
 Selezionare per nascondere OSD.
 Seleção para ocultar a exibição na tela (OSD).
 Velges hvis du vil slå av menyvisningen (OSD).

MENU ADJUSTMENTS

MENÜEINSTELLUNGEN OPTIONS DE MENU MENÚ DE AJUSTES IMPOSTAZIONI DAL MENU AJUSTES DO MENU MENYINNSTILLINGER

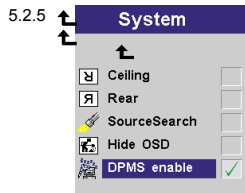

Select DPMS active/inactive. Ref. chap. K
 DPMS aktivieren/deaktivieren. Siehe Kap. K
 Sélection DPMS actif/inactif. Voir chap. K
 Selecciona activar/desactivar DPMS. Consultar cap. K
 Selezione del DPMS attivo/inattivo. Vedere il cap. K
 Selezione DPMS attivo/inattivo. Ref. cap. K
 Velg om DPMS-funksjonen skal være aktiv/inaktiv. Se kap. K

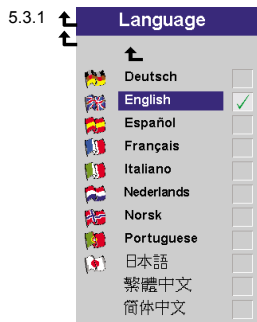
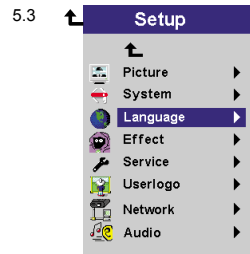

Select language.
 Sprache auswählen.
 Sélectionne la langue.
 Seleccionar lenguaje.
 Selezione della lingua.
 Selecciona o idioma.
 Velg språk.

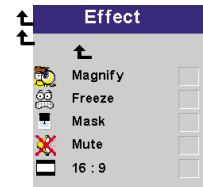
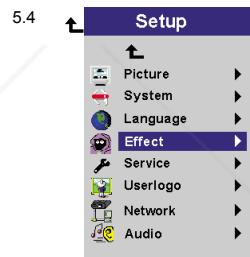

Tagged effect is assigned to the remote control's "Effect" key.
 Der eingestellte Effekt wird der "Effekt"-Taste an der Fernbedienung zugewiesen.
 L'effet annoté est assigné à la clé "Effet" contrôle à distance.
 El efecto de rótulos se asigna a la tecla "Efecto" del control remoto.
 L'effetto a tendina viene assegnato al tasto "Effetto" sul telecomando.
 O efeito Tagged é designado à tecla "Efeito" do controle remoto.
 Den avmerkede effekten tilordnes "Effect"-tasten på fjernkontrollen.

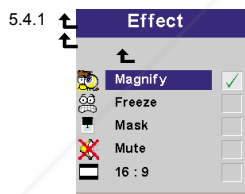

Assigns the "Effect" key's function to "magnify" (default setting).
 Der "Effekt"-Taste wird als Funktion "Vergrößern" zugewiesen (Standardeinstellung).
 Assigne la fonction de la clé "Effet" à "agrandir" (paramètres par défaut).
 Asigna la función "amplificar" en la tecla "Efecto" (configuración por defecto).
 Assegna la funzione del tasto "Effetto" a "ingrandire" (impostazione di default).
 Designa a função da tecla "Efeito" para "ampliar" (configuração predefinida).
 Setter "Effect"-tastens virkemåte til "zoom" (standardinnstilling).

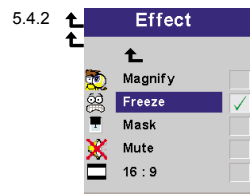

Assigns the "Effect" key's function to "freeze the projected image".
 Der "Effekt"-Taste wird als Funktion "Projiziertes Bild einfrieren" zugewiesen.
 Assigne la fonction de la clé "Effet" à "arrêt sur image projetée".
 Configure la función "congelar la imagen proyectada" en la tecla "Efecto".
 Assegna la funzione del tasto "Effetto" a "fermo immagine".
 Designa a função da tecla "Efeito" para "congelar a imagem projetada".
 Setter "Effect"-tastens virkemåte til "frys det projiserte bildet".



FixYourDIP.com

Discount-Merchant.com (800) 281-8860

THE TRUSTED SOURCE FOR PROJECTOR LAMPS AND ACCESSORIES

MENU ADJUSTMENTS

MENÜEINSTELLUNGEN OPTIONS DE MENU MENÚ DE AJUSTES IMPOSTAZIONI DAL MENU AJUSTES DO MENU MENYINNSTALLINGER

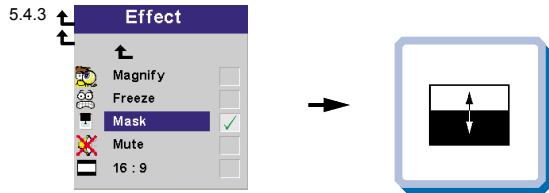

Assigns the "Effect" key's function to "Mask the projected image".
 Der "Effekt"-Taste wird als Funktion "Projiziertes Bild verbergen" zugewiesen.
 Assigne la fonction de la clé "Effet" à "masquer l'image projetée".
 Configure la función "ocultar la imagen proyectada" en la tecla "Efecto".
 Assegna la funzione del tasto "Effetto" a "maschera dell'immagine proiettata".
 Designa a função da tecla "Efeito" para "mascarar a imagem projetada".
 Setter "Effect"-tastens virkemåte til "legg maske på det projiserte bildet".

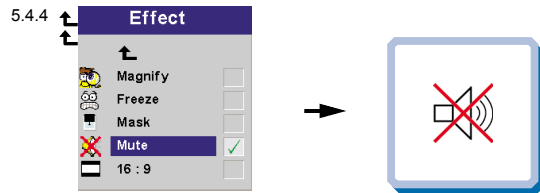

Assigns the "Effect" key's function to "mute the sound".
 Der "Effekt"-Taste wird als Funktion "Ton abstellen" zugewiesen.
 Assigne la fonction de la clé "Effet" à "mettre la sourdine".
 Configure la función "silenciar el sonido" en la tecla "Efecto".
 Assegna la funzione del tasto "Effetto" a "disattivazione audio".
 Designa a função da tecla "Efeito" para "colocar o som em mudo".
 Setter "Effect"-tastens virkemåte til "mute" (dvs. at lyden slås av).

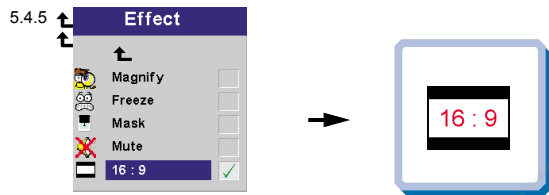

Assigns the "Effect" key's function to "16:9 wide screen image format".
 Der "Effekt"-Taste wird als Funktion "Breitbildformat 16:9" zugewiesen.
 Assigne la touche de fonction "Effets" à la "grande image sur écran 16:9".
 Establezca la función de la tecla "Efecto" en el "formato de pantalla ancha 16:9".
 Assegnare la funzione della tastiera "Effetto" al "formato panoramico 16:9".
 Atribui a função da tecla de efeito ao "formato de imagem de tela ampla 16:9".
 Setter "Effect"-tastens virkemåte til "vidvinkelformatet 16:9 for bildet".

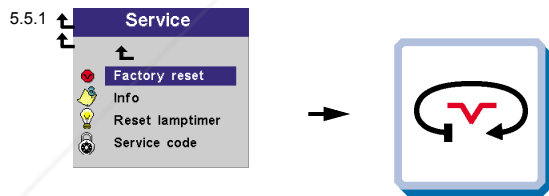
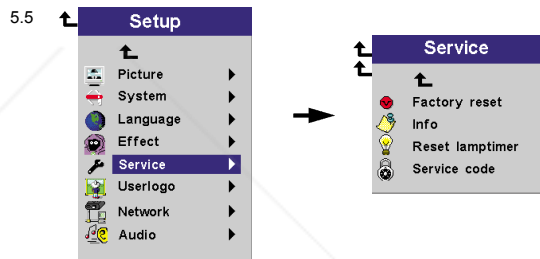

Select to reset all options to factory settings.
 Does not include: rear, the ceiling, language, the IP address, and the lamp timer.
 Aktivieren, um alle Optionen auf Werkseinstellung zu setzen. Nicht umfasst: Rückseite, die Decke, die Sprache, die IP-Adresse und die Lampenstundenzähler.
 Sélectionner pour remettre toutes les options sur paramètres usine.
 N'inclut pas: Arrière, le Plafond, la langue, l'adresse IP et l'horloge de la lampe.
 Seleccionar para restablecer todas las opciones a la configuración original. No incluye: Parte posterior, el techo, lenguaje, la dirección IP y el temporizador de la bombilla.
 Selezione per ripristino di tutte le opzioni sulle impostazioni di fabbrica. Non include: Parte posteriore, il soffitto, linguaggio, l'indirizzo IP e il temporizzatore della lampadina.
 Seleção para obter as opções retornem à programação inicial de fábrica.
 Não inclui: Parte Traseira, o teto, idioma, o endereço IP e o cronômetro da lâmpada.
 Velges hvis du vil tilbakesetle alle innstillinger til fabrikkinnstillingene.
 Inkluderer ikke: Bakprojeksjon, tak, språk, IP-adresse og tellerverk for lampen.

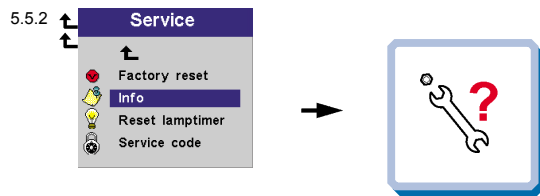

Select to display service information.
 Aktivieren, um Serviceinformationen anzuzeigen.
 Sélectionner pour afficher l'information réparations.
 Sólo para personal técnico.
 Selezione per visualizzare le informazioni sull'assistenza.
 Seleção para obter informação sobre a fonte selecionada.
 Velges hvis du vil vise serviceinformasjon.



FixYourScreen.com

Discount-Merchant.com (800) 281-8860

THE TRUSTED SOURCE FOR PROJECTOR LAMPS AND ACCESSORIES

MENU ADJUSTMENTS

MENÜEINSTELLUNGEN OPTIONS DE MENU MENÚ DE AJUSTES IMPOSTAZIONI DAL MENU AJUSTES DO MENU MENYINNSTILLINGER

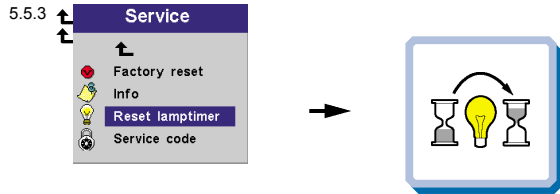

Select to reset lamp timer after lamp replacement.
 Aktivieren, um Lampenstundenzähler nach dem Austausch auf Null zu setzen.
 Sélectionner pour remettre l'horloge de la lampe à zéro après changement de lampe.
 Seleccionar para restablecer el temporizador de la bombilla tras la sustitución de la misma.
 Selezione per ripristinare il temporizzatore della lampadina dopo la sua sostituzione.
 Seleccione para zerar o cronómetro da lâmpada após substituição da mesma.
 Velges for å tilbakestille teltelverket for lampen etter lampeskift.

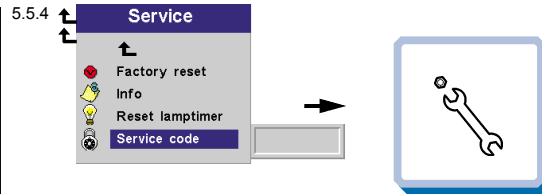

Only for service personnel.
 Nur für Kundendienstpersonal.
 Pour le personnel technique uniquement.
 Sólo para personal técnico.
 Ad uso esclusivo dei tecnici di assistenza.
 Somente para serviço autorizado.
 Bare for servicepersonell.

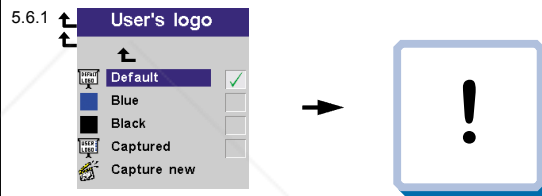
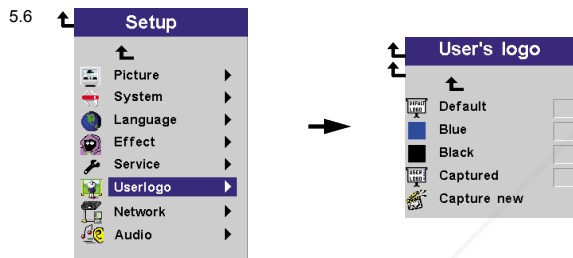

Projects the default projector logo screen when no source is connected. Ref. chap. I
 Es wird die standardgemäß eingestellte Logo-Anzeige des Projektors gezeigt, wenn keine Quelle angeschlossen ist. Siehe Kap. I
 Projette par défaut l'écran logo lorsque aucune source n'est branchée. Voir chap. I
 Cuando no hay ninguna fuente conectada, se proyecta la pantalla por defecto con el logotipo del proyector. Ref. cap. I
 Proietta lo schermo con il logo predefinito del proiettore quando non ci sono sorgenti collegate. Rif. cap. I
 Projeta tela predefinida do logotipo do projetor quando nenhuma fonte está sconectada. Ref. cap. I
 Projiserer standard logoskjernbilde for projektoren når ingen kilde er tilkoblet. Se kap. I

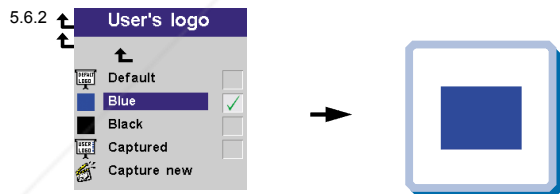

Projects a blue screen when no source is connected.
 Wenn keine Quelle angeschlossen ist, wird eine blaue Anzeige projiziert.
 Projette un écran bleu lorsque aucune source n'est branchée.
 Cuando no hay ninguna fuente conectada, se proyecta una pantalla azul.
 Proietta uno schermo blu quando non ci sono sorgenti collegate.
 Projeta uma tela azul quando nenhuma fonte está conectada.
 Projiserer et blått skjernbilde når det ikke er tilkoblet noen kilde.
 Sponsored by

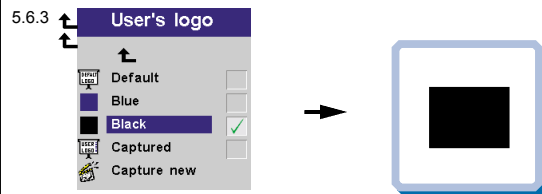

Projects a black screen when no source is connected. Ref. chap. I
 Wenn keine Quelle angeschlossen ist, wird eine schwarze Anzeige projiziert. Siehe kap. I
 Projette un écran noir lorsque aucune source n'est branchée. Voir chap. I
 Cuando no hay ninguna fuente conecta, se proyecta una pantalla negra. Ref. cap. I
 Proietta uno schermo nero quando non ci sono sorgenti collegate. Rif. cap. I
 Projeta uma tela preta quando nenhuma fonte está conectada. Ref. cap. I
 Projiserer et svart skjernbilde når det ikke er tilkoblet noen kilde. Se kap. I

MENU ADJUSTMENTS

MENÜEINSTELLUNGEN OPTIONS DE MENU MENÚ DE AJUSTES IMPOSTAZIONI DAL MENU AJUSTES DO MENU MENYINNSTILLINGER

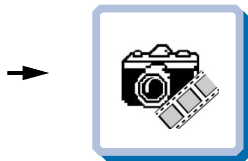
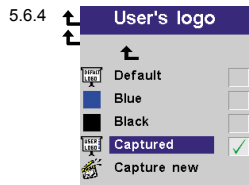

Projects the user defined logo screen when no source is connected. Ref chap. I
 Es wird die vom Benutzer definierte Logo-Anzeige des Projektors gezeigt, wenn keine Quelle angeschlossen ist. Siehe Kap. I
 Projette l'écran logo choisi par l'utilisateur lorsque aucune source n'est branchée. Voir chap. I
 Cuando no hay ninguna fuente conectada, se proyecta la pantalla con el logotipo definido por el usuario. Ref. cap. I
 Proietta lo schermo con il logo definito dall'utente quando non ci sono sorgenti collegate. Rif. cap. I
 Projeta a tela do logotipo definido pelo usuário quando nenhuma fonte está conectada. Ref. cap I
 Projiserer det brukerdefinerte logoskjermbildet når det ikke er tilkoblet noen kilde. Se kap. I

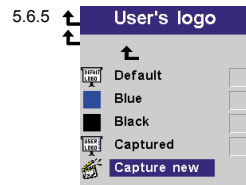

Enables the capture of a new user defined logo screen. Ref chap. I
 Ermöglicht die Aufnahme einer neuen, vom Benutzer definierten Logo-Anzeige. Siehe Kap. I
 Permet la saisie d'un nouvel écran logo défini par l'utilisateur. Voir chap. I
 Activa la captura de una nueva pantalla con el logotipo definido por el usuario. Ref. cap. I
 Consente di acquisire un nuovo schermo con un logo definito dall'utente. Rif. cap. I
 Permite a captura de uma tela de logotipo definida por um novo usuário. Ref. cap. I
 Aktiverer skjermkopiering av et nytt brukerdefinert logoskjermbilde. Se kap. I

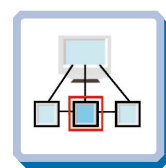
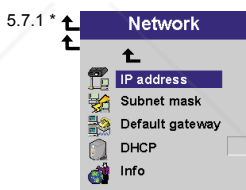
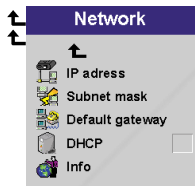
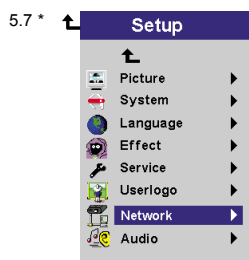

Identifies your projector on the network.
 Identifiziert Ihren Projektor im Netzwerk.
 Identifie votre projecteur sur le réseau.
 Identifica su projector en la red.
 Identifica il proprio proiettore sulla rete.
 Identifica o seu projector na rede.
 Identifiserer projektoren i nettverket.

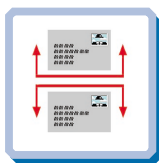
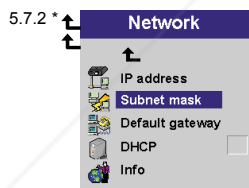

Separates the network address part of the IP Address.
 Trennt den Teil der Netzwerkadresse von der IP - Adresse.
 Sépare la partie d'adresse du réseau de l'adresse IP.
 Separa a parte de la dirección de red de la dirección IP.
 Separa la parte relativa all'indirizzo di rete dell'Indirizzo IP.
 Separa a Parte do Endereço de Rede do Endereço IP.
 Skiller ut den delen av IP-adressen som angir nettkretsadressen.

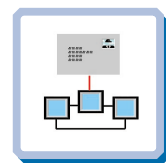
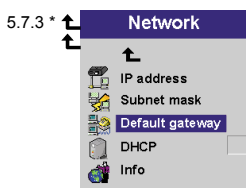

The IP address of the local router.
 Die IP - Adresse für den lokalen Router.
 l'adresse IP du routeur local.
 La dirección IP del encaminador local.
 L'Indirizzo IP del router locale.
 O endereço IP do roteador local.
 IP-adressen til den lokale ruter.



Discount-Merchant.com (800) 281-8860

THE TRUSTED SOURCE FOR PROJECTOR LAMPS AND ACCESSORIES

MENU ADJUSTMENTS

MENÜEINSTELLUNGEN OPTIONS DE MENU MENÚ DE AJUSTES IMPOSTAZIONI DAL MENU AJUSTES DO MENU MENYINNSTILLINGER

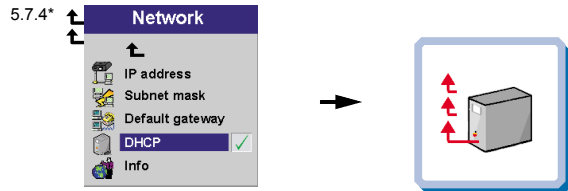

Obtain an IP address, Subnet mask and Default gateway automatically.
 Sie erhalten automatisch eine IP - Adresse, Subnet Mask und vorgegebene Gateway.
 Obtient automatiquement une adresse IP, un masque Subnet et une passerelle par défaut.
 Obtención automática de una dirección IP, una máscara de subred y una pasarela predeterminada.
 Ottiene un Indirizzo IP, una Maschera Subnet e un Gateway Predefinito in modo automatico.
 Obtém um endereço IP, uma máscara Sub-rede e uma porta por Defeito automaticamente.
 Få tak i en IP-adresse, netværksmaske og standard gateway automatisk.

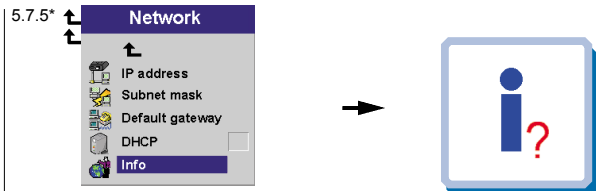

Gives information on the network configuration including (incl.) the projectors MAC address.
 Liefert Ihnen Informationen über die Konfiguration des Netzwerkes, einschließlich der MAC - Adresse des Projektors.
 Fournit des informations sur la configuration du réseau y compris (incl.) l'adresse des projecteurs MAC.
 Ofrece información acerca de la red, incluida (incl.) la dirección de los proyectores MAC.
 Fornisce informazioni sulla configurazione della rete tra cui (incl.) gli indirizzi MAC dei proiettori.
 Fornece informações acerca da configuração da rede, incluindo (incl.) o endereço MAC dos projetores.
 Gir informasjon om netværkskonfigurasjonen, inkludert projektorens MAC-adresse.

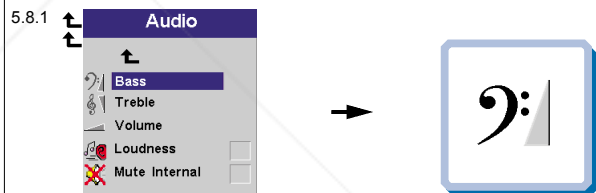
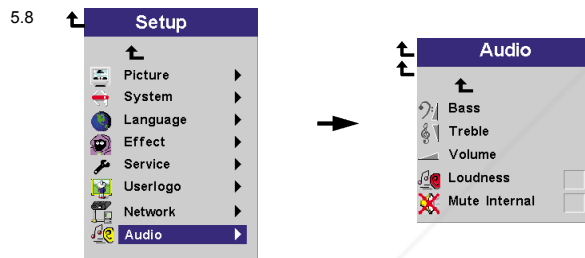

Adjust the bass level for the projector sound.
 Stellen Sie die Bassstufe für den Projektorklang ein.
 Réglez le niveau de graves du son du projecteur.
 Ajusta el nivel de bajos para el sonido del proyector.
 Regola il livello del basso per l'audio del proiettore.
 Ajusta o nível de baixos para o som do projector.
 Juster bassnivået for lyden fra projektoren.

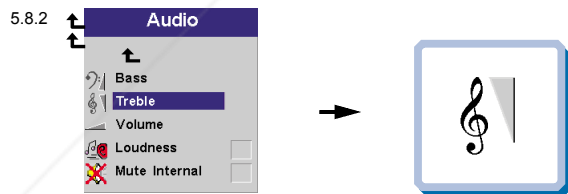

Adjust the treble level for the projector sound.
 Stellen Sie die Höhenstufe für den Projektorklang ein.
 Réglez le niveau d'aigus du son du projecteur.
 Ajusta el nivel de agudos para el sonido del proyector.
 Regola il livello degli acuti per l'audio del proiettore.
 Ajusta o nível de "treble" para o som do projector.
 Juster diskantnivået for lyden fra projektoren.

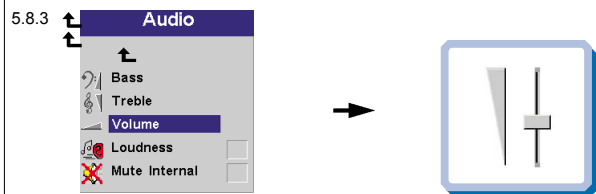

Adjust the volume level for the projector sound.
 Stellen Sie die Lautstärke für den Projektorklang ein.
 Réglez le volume du son du projecteur.
 Ajusta el nivel del volumen para el sonido del proyector.
 Regola il livello del volume per l'audio del proiettore.
 Ajusta o nível de volume para o som do projector.
 Juster volumnivået for lyden fra projektoren.



Discount-Merchant.com (800) 281-8860

THE TRUSTED SOURCE FOR PROJECTOR LAMPS AND ACCESSORIES

MENU ADJUSTMENTS

MENÜEINSTELLUNGEN OPTIONS DE MENU MENÚ DE AJUSTES IMPOSTAZIONI DAL MENU AJUSTES DO MENU MENYINNSTILLINGER

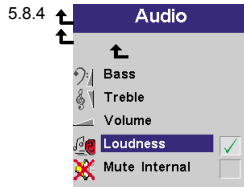

Enhanced bass and treble for low sound levels.
 Verstärken von Bass und Höhen für niedrige Lautstärken.
 Graves et aigus élargis pour les niveaux sonores faibles.
 Bajos y agudos mejorados para niveles bajos del sonido.
 Bassi e acuti migliorati per livelli sonori ridotti.
 Baixo melhorado e "treble" para níveis de som baixo.
 Forsterket bass og diskant for lave lydnivåer.

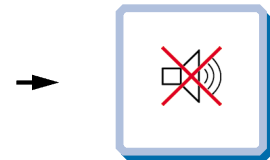
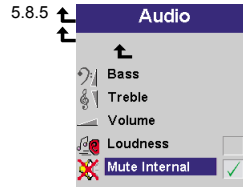

Mutes the internal speakers.
 Dämpft die internen Lautsprecher.
 Éteint les haut-parleurs internes.
 Silencia los altavoces internos.
 Applica il 'mute' agli altoparlanti interni.
 Corta o som das colunas internas.
 Slår av de innebygde høytalerne.

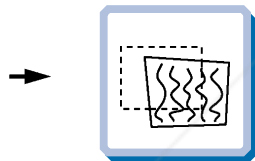
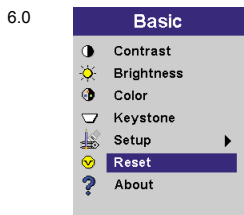

Synchronizes the projector settings to the active source.
 Synchronisiert die Projektoreinstellungen für die aktive Quelle.
 Synchronise les paramètres du projecteur avec la source active.
 Sincroniza las configuraciones del proyector con la fuente activa.
 Sincronizzazione delle impostazioni del proiettore sulla sorgente attiva.
 Sincroniza a configuração do projetor com a fonte ativa.
 Synkroniserer projektorens innstillinger med den aktive kilden.

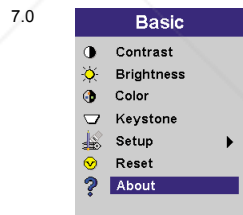

Indicates information about selected source.
 Zeigt Information über die aktive Quelle an.
 Renseigne sur la source sélectionnée.
 Proporciona información sobre fuentes seleccionadas.
 Informazioni sulla sorgente selezionata.
 Fornece informação sobre a fonte selecionada.
 Viser informasjon om den valgte kilden.

*) 5.7 If you are connected to a local network, contact your network administrator to get a valid IP address, Subnet mask and a default gateway address.
 Wenn Sie an einem lokalen Netzwerk angeschlossen sind, kontaktieren Sie Ihren Netzwerkverwalter, um eine gültige IP - Adresse, Subnet Mask und eine vorgegebene Gateway - Adresse zu erhalten.
 Si vous êtes connecté à un réseau local, contactez votre administrateur de réseau pour obtenir une adresse IP correcte, un masque Subnet et une adresse de passerelle par défaut.
 Si está conectado a una red local, póngase en contacto con su administrador de red para obtener una dirección IP válida, una máscara de subred y una dirección de la pasarela predeterminada.
 Se si è collegati a una rete locale, contattare il proprio amministratore di rete per ottenere un Indirizzo IP valido, Maschera Subnet e un indirizzo Gateway Predefinito.
 Se estiver ligado a uma rede local, contacte o administrador da rede local para obter um endereço IP válido, uma Máscara sub-rede e um endereço de porta por defeito.
 Hvis du er koblet til et lokalt nettverk, kontaktér du nettverksansvarlig for å få tak i en gyldig IP-adresse, nettverksmaske og standard gateway-adresse.

USER'S LOGO

LOGO DES BENUTZERS LOGO DE L'UTILISATEUR

LOGOTIPO DEL USUARIO LOGO DELL'UTENTE LOGOTIPO DO USUÁRIO BRUKERDEFINERT LOGO

User's logo enables the user to define his/her own logo screen that will show during start up, or when no source is connected. Alternatively a blue, black or the default projector logo screen can be set.

Das Benutzer-Logo ermöglicht es dem Anwender, seine eigene Logo-Anzeige zu definieren, die während dem Hochfahren oder wenn keine Quelle angeschlossen ist angezeigt wird. Als Alternative kann eine blaue, schwarze oder die standardgemäße Logo-Anzeige des Projektors eingestellt werden. Le logo de l'utilisateur permet à l'utilisateur de définir son propre écran logo qui s'affichera lors du lancement ou lorsque aucune source n'est branchée. Sinon peut sélectionner un écran de projection bleu, noir ou un logo par défaut.

El logotipo del usuario le permitirá definir su propio logotipo en la pantalla, que se mostrará al comenzar la proyección, o bien cuando no haya ninguna fuente conectada. También se puede establecer que aparezca por defecto una pantalla azul, negra o con el logotipo del proyector.

Il logo dell'utente consente all'utente di definire il proprio schermo di logo che sarà proiettato in fase di avvio oppure quando non ci sono sorgenti collegate. Altrimenti è possibile impostare uno schermo con il logo di default del proiettore o uno schermo nero o blu.

O logotipo do usuário permite ao mesmo definir a sua própria tela de logotipo que se apresentará ao iniciar ou quando nenhuma fonte estiver conectada. Alternativamente, uma tela azul, preta ou predefinida do logotipo do projetor poderá ser configurada.

Ved hjelp av brukerdefinert logo kan brukeren definere sitt eget logoskjermbilde som vil vises under oppstart, eller når det ikke er tilkoblet noen kilde. Det kan eventuelt angis at det skal vises et blått eller svart skjermbilde, eller standard logoskjermbilde for projektoren.

To enable the capture of a new user defined logo do the following:

Um die Aufnahme eines neuen, vom Benutzer definierten Logos zu ermöglichen, verfahren Sie wie folgt:

Pour permettre la saisie d'un nouveau logo défini par l'utilisateur, suivre les instructions

Para activar la captura de un nuevo logotipo definido por el usuario, deberá realizar lo siguiente:

Per abilitare l'acquisizione di un nuovo logo definito dall'utente, fare quanto segue:

Para permitir a captura de um logotipo definido de usuário novo, faça o seguinte:

Slik aktiverer du skjermkopiering av en ny brukerdefinert logo:

1. Select "Capture New" in the "Set Up/User's Logo" menu.
Wählen Sie im Menü "Einstellungen/Benutzer-Logo" "Neue Aufnahme".
Sélectionner "Nouvelle saisie" dans le menu "Mise au point/Logo de l'utilisateur".
Seleccione "Nueva Captura" en el menú "Configuración/Logotipo del Usuario".
Selezionare "Nuova acquisizione" nel menu "Impostazioni/Logo dell'utente".
Selecione "Captura Novo" no menu "Configurar/Logotipo de usuário".
Velg "Lagre ny" på menyen "Oppsett/Brukerdefinert logo".
2. Press "L" on the remote (an information window will appear), and follow the onscreen information
Drücken Sie auf der Fernbedienung auf "L" (es öffnet sich ein Hinweisfenster) und befolgen Sie die Anleitungen auf dem Bildschirm.
Appuyez sur la touche "L" de la commande à distance (vous verrez s'afficher un écran d'information) et suivez les instructions de l'écran.
Pulse "L" en el mando a distancia (aparecerá una ventana con información), siga las instrucciones que aparecen en pantalla.
Premere "L" sul telecomando (compare una finestra con informazione), seguite le istruzioni che compaiono sullo schermo.
Pressione a tecla "L" no controle remoto e siga as instruções que aparecerão na tela, na janela de informações.
Trykk på "L" på fjernkontrollen (et informasjonsvindu kommer frem), og følg instruksjonene på skjermen.
3. To begin "Capture New", press "L" on the remote again, the projector will confirm if the capture was a success/failure when finished.
Um eine "Neue Aufnahme" zu starten, drücken Sie auf der Fernbedienung erneut auf "L". Der Projektor teilt Ihnen nach Abschluss mit, ob die Aufnahme erfolgreich bzw. fehlgeschlagen hat.
Pour lancer "Nouvelle Saisie", appuyez à nouveau sur "L" sur la commande à distance, et le projecteur confirmera si la capture a été un succès/échec à la fin de l'opération.
Para comenzar "Nueva Captura", pulse de nuevo "L" en el mando a distancia, al finalizar el proyector confirmará si la captura tuvo éxito positivo / negativo.
Per iniziare "Nuova Acquisizione", premere di nuovo "L" nel telecomando, il proiettore confermerà alla fine, se l'acquisizione è stata un esito positivo / negativo.
Para iniciar a função "Captura Novo", pressione "L" novamente no controle remoto. O projetor confirmará se a captura foi realizada com êxito ou não assim que o procedimento estiver finalizado.
For å starte "Lagre ny" trykker du på "L" på fjernkontrollen igjen. Projektoren vil angi om lagringen var vellykket/mislykket når oppgaven er ferdig.

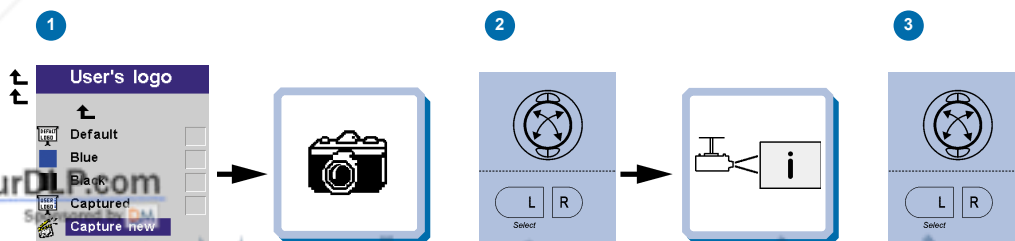





J

LIGHT MESSAGES

LEUCHTANZEIGEN INDICATEURS LUMINEUX

INDICADORES LUMINOSOS MESSAGGI LUMINOSI INDICADORES LUMINOSOS LYSSIGNALER

CONDITION LEUCHTANZEIGE ETAT INDICACIÓN CONDIZIONE CONDIÇÃO TILSTAND	STATUS ZUSTAND STATUT ESTADO STATO STATUS STATUS	EXPLANATION ERLÄUTERUNG EXPLICATION EXPLICACIÓN SPIEGAZIONE EXPLICAÇÃO FORKLARING
<p>Green Grün Vert Luz verde Verde Verde Grønt</p> 	<p>Power ON (picture on the screen) EIN (Bild auf Leinwand) Position ON (image sur l'écran) Encendido (ON) (imagen en pantalla) Acceso (immagine sullo schermo) Ligado (imagem na tela) Strøm på (bilde på skjermen)</p>	<p>Normal mode Betriebsmodus Mode normal Modo normal Modalità normale Modo normal Normal modus</p>
<p>Slow orange blinking. Orange (langsam blinkend). Orange pâle clignotant. Luz naranjá parpadeando lentamente. Lampeggio arancione lento. Laranja piscando lentamente. Oransje, langsomt blinkende.</p> 	<p>Power OFF has been selected, and OSD logo screen is displayed. Der Projektor wurde auf AUS gestellt, das OSD-Logo wird angezeigt. La position OFF a été sélectionnée et l'écran logo OSD est affiché. Se ha seleccionado APAGADO y la (OFF) pantalla muestra el logotipo de OSD. È stato selezionato lo spegnimento OFF e viene proiettato sullo schermo il logo OSD. A opção DESLIGAR foi selecionada e a tela do logotipo OSD é exibida. Strøm AV er valgt, og logoskjermbildet for OSD vises.</p>	<p>The projector is going to standby. Projektor geht in Standby-Modus über. Le projecteur passe en standby (attente). El proyector se coloca en standby. Il proiettore sta entrando in stand-by. O projetor está entrando em standby. Projektoren går til ventemodus.</p>
<p>Orange Orange Orange Luz naranjá Arancione Laranja Oransje</p> 	<p>Standby mode Standby-Modus Mode standby (attente) Modo standby Modalità stand-by Modo standby Ventemodus</p>	<p>The projector is in standby (sleep) mode. Der Projektor befindet sich in Standby-Modus. Le projecteur est en mode standby (attente). El proyector está en modo standby (sleep). Il proiettore è in modalità stand-by (sleep). O projetor está em modo standby (descanso). Projektoren er i ventemodus (dvailemodus).</p>
<p>Red Rot Rouge Luz roja Rosso Vermelho Rødt</p> 	<p>Lamp life has expired, OSD message is displayed. Lampenwechsel ist fällig, OSD-Meldung erscheint. La durée de vie de la lampe est dépassée, un message OSD est affiché. Aparece un mensaje de OSD indicando que la bombilla se ha agotado. La vita utile della lampadina è giunta a termine, viene proiettato il messaggio OSD. A vida útil da lâmpada expirou, uma mensagem OSD é exibida. Lampens levetid er overskredet, OSD-melding vises.</p>	<p>The lamp lifetime is overdue. Ref. chapt. O Die Lebensdauer der Lampe ist abgelaufen. Siehe Kap. O La durée de vie de la lampe est dépassée. Voir chap. O La vida útil de la bombilla se ha agotado. Ref. cap. O È stata superata la durata della lampadina. Rif. cap. O A vida útil da lâmpada está ultrapassada. Rif. cap. O Lampens levetid er overskredet. Se kap. O</p>

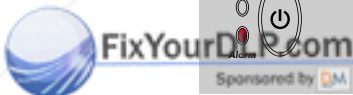



Discount-Merchant.com (800) 281-8860

THE TRUSTED SOURCE FOR PROJECTOR LAMPS AND ACCESSORIES

LIGHT MESSAGES

LEUCHTANZEIGEN INDICATEURS LUMINEUX

INDICADORES LUMINOSOS MESSAGGI LUMINOSI INDICADORES LUMINOSOS LYSSIGNALER



CONDITION LEUCHTANZEIGE ETAT INDICACIÓN CONDIZIONE CONDIÇÃO TILSTAND	STATUS ZUSTAND STATUT ESTADO STATO STATUS STATUS	EXPLANATION ERLÄUTERUNG EXPLICACION EXPLICACIÓN SPIEGAZIONE EXPLICAÇÃO FORKLARING
<p>Fast red blinking. Rot (schnell blinkend). Rouge à clignotement rapide. Luz roja parpadeando rápidamente. Lampeggio rosso rapido. Vermelho piscando rapidamente. Rødt, raskt blinkende.</p> 	<p>High temperature, OSD message is displayed. Überhitzung, OSD-Meldung wird angezeigt. Température élevée, Un message OSD est affiché. Aparece un mensaje de OSD que indica temperatura elevada. Temperatura elevata, viene proiettato il messaggio OSD. Temperatura alta. Uma mensagem OSD é exibida. OSD-melding om høy temperatur vises.</p>	<p>The projector temperature is above the critical limit. Please allow the projector to cool down by turning off the projector. Die Temperatur des Projektors befindet sich im kritischen Bereich. Schalten Sie den Projektor aus und lassen ihn abkühlen. La température du projecteur est trop élevée. Eteignez le projecteur et laissez-le refroidir. La temperatura del proyector ha alcanzado el punto crítico. Apague el proyector y deje que se enfríe. La temperatura del proiettore ha superato il limite critico. Spegner il proiettore e lasciarlo raffreddare. A temperatura do projetor está acima do limite crítico. Por favor permita que o projetor esfrie desligando-o. Projektorens temperatur er over den kritiske grensen. Slå projektoren av slik at den kan kjøle seg ned.</p>
<p>Red blinking (** - ** - **) Rot blinkend (** - ** - **) Rouge à clignome (** - ** - **) Luz roja parpadeando (** - ** - **) Lampeggio rosso (** - ** - **) Vermelho piscando (** - ** - **) Rødt blinkende (** - ** - **)</p> 	<p>Projector will shut down. Der Projektor wird heruntergefahren. Le projecteur s'éteindra. El proyector se apagará. Il proiettore si spegne. O projetor apagará. Prosjektoren vil slå seg av.</p>	<p>The fans are not connected / operating. Die Ventilatoren sind nicht angeschlossen/in Betrieb. Le ventilateur n'est pas branché/ne fonctionne pas. Los ventiladores no están conectados o funcionando. Le ventole non sono collegate/operative. Os ventiladores não estão conectados/funcionando. Viftene er ikke tilkoblet/i gang.</p>
<p>Fast green blinking. Schnelles grünes Blinken. Lampe verte à clignotement rapide. Intermitencia rápida en verde. Lampeggiamento veloce luce verde. Luz verde firme intermitente. Grønt, raskt blinkende.</p> 	<p>Lamp did not ignite. Lampe ging nicht an. La lampe ne s'est pas allumée. La lámpara no se ha encendido. La lampada non si è accesa. A lâmpada não acende. Lampen ble ikke tent.</p>	<p>The fans will cool down the lamp and new ignition will be performed automatically every 20 seconds. Die Ventilatoren kühlen die Lampe, und eine neue Zündung wird alle 20 Sekunden automatisch durchgeführt. Les ventilateurs vont refroidir la lampe et un nouvel allumage aura lieu automatiquement toutes les 20 secondes. Los ventiladores enfriarán la lámpara y se realizará un nuevo encendido automáticamente cada 20 segundos. Le ventole raffredderanno la lampada ed automaticamente una nuova accensione si attuerà ogni 20 secondi. Os ventiladores refrigerarão a lâmpada e, automaticamente, cada 20 segundos, uma nova ignição terá lugar. Viftene vil kjøle ned lampen, og ny tenning utføres automatisk hvert 20. sekund.</p>



POWER MANAGEMENT (DPMS)

POWER MANAGEMENT (DPMS) GESTION DE L'ALIMENTATION (DPMS)

FUENTES DE ENERGÍA CONTROLLO DELL'OPERATIVITA (DPMS) CONTROLE DA POTENCIÁ STRØMSPARING (DPMS)

CONDITION LEUCHTANZEIGE ETAT INDICACIÓN CONDIZIONE CONDIÇÃO TILSTAND	STATUS ZUSTAND STATUT ESTADO STATO STATUS STATUS	EXPLANATION ERLÄUTERUNG EXPLICATION EXPLICACIÓN SPIEGAZIONE EXPLICAÇÃO FORKLARING
<p>Slow green blinking. Grün (langsam blinkend). Vert à clignotement lent. Luz verde parpadeando lentamente. Lampeggio verde lento. Verde piscando lentamente. Grønt, langsomt blinkende.</p> 	<p>DPMS Mode (black screen) DPMS-Modus (schwarze Leinwand) Mode DPMS (écran noir) Modo DPMS (pantalla en negro) Modalità DPMS (schermo nero) Modo DPMS (Tela preta) DPMS-modus (svart skjerm)</p>	<p>No valid source detected. Keine zulässige Quelle gefunden. Aucune source adéquate détectée. No se ha detectado ninguna fuente válida. Non viene rilevata nessuna sorgente. Nenhuma fonte válida foi detectada. Ingen gyldig kilde funnet.</p>
<p>Slow green blinking. Grün (langsam blinkend). Vert à clignotement lent. Luz verde parpadeando lentamente. Lampeggio verde lento. Verde piscando lentamente. Grønt, langsomt blinkende.</p> 	<p>DPMS Mode (Lamp is off) DPMS-Modus (Lampe ist aus) Mode DPMS (La lampe est éteinte) Modo DPMS (la bombilla está apagada) Modalità DPMS (la lampadina è spenta) Modo DPMS (a lâmpada está desligada) DPMS-modus (lampen er av)</p>	<p>No valid source detected in the last 3 minutes. The projector will stay in this mode for 5 minutes. If you get a valid source within 5 minutes, the projector will turn on again. Nach Ablauf von 3 Minuten keine zulässige Quelle gefunden. Der Projektor bleibt 5 Minuten lang in diesem Zustand. Wenn Sie in dieser Zeit eine zulässige Quelle anschließen, schaltet sich der Projektor wieder ein. Aucune source adéquate détectée au cours des 3 dernières minutes. Le projecteur restera sur ce mode pendant 5 minutes. Si vous lui fournissez une source adéquate dans les 5 minutes, il s'allumera de nouveau. Han transcurrido 3 minutos sin detectar ninguna fuente válida. El proyector permanecerá en este modo durante 5 minutos. Si dentro de ese plazo se le proporciona una fuente válida, volverá a ponerse en marcha. Non è stata rilevata nessuna sorgente valida negli ultimi tre minuti. Il proiettore rimarrà in questa modalità per 5 minuti. Se si trova una sorgente valida entro 5 minuti, il proiettore tornerà ad accendersi. Nenhuma fonte válida foi detectada nos últimos 3 minutos. O projetor permanecerá neste modo por 5 minutos. O projetor ligará novamente se obtiver uma fonte válida dentro de 5 minutos. Ingen gyldig kilde funnet i løpet av de siste 3 minuttene. Projektoren holder seg i denne modusen i 5 minutter. Hvis det blir funnet en gyldig kilde i løpet av 5 minutter, slår projektoren seg på igjen.</p>
<p>Slow green blinking. Grün (langsam blinkend). Vert à clignotement lent. Luz verde parpadeando lentamente. Lampeggio verde lento. Verde piscando lentamente. Grønt, langsomt blinkende.</p> 	<p>OSD logo screen is displayed. OSD-Logo wird angezeigt. L'écran logo OSD est affiché. La pantalla muestra el logotipo de OSD. Viene proiettato il logo OSD. A tela do logotipo OSD é exibida. Logoskjermbildet for OSD vises.</p>	<p>The projector will search until a valid source is detected. Der projektor versucht eine zulässige Quelle zu finden. Le projecteur cherchera jusqu'à détecter une source adéquate. El proyector buscará hasta detectar una fuente válida. Il proiettore cercherà fino a trovare una sorgente valida. O projetor procurará até detectar uma fonte válida. Projektoren vil søke til en gyldig kilde blir funnet.</p>

**TROUBLESHOOTING**

FEHLERBEHEBUNG SOLUTION AUX PROBLEMES LES PLUS FREQUENTS

SOLUCIÓN DE PROBLEMAS SOLUZIONE DEI PROBLEMI LOCALIZAÇÃO DE DEFEITOS FEILSØKING



No image on the screen
Kein Bild auf der Leinwand
Pas d'image sur l'écran
Sin imagen en pantalla
Assenza di immagine sullo schermo
Não há imagem na tela
Skjermen viser ikke bilde

1. Verify the power connections to the projector (check that the power light is on).
 Stromanschluss des Projektors überprüfen (Power-Leuchtanzeige muss leuchten).
 Vérifiez les connexions de l'alimentation au projecteur (vérifiez que l'indicateur d'alimentation est allumé).
 Verifique las conexiones del proyector (compruebe que la luz de energía está encendida).
 Verificare la connessione dell'alimentazione del proiettore (controllare che la spia dell'alimentazione sia accesa).
 Verifique as conexões de alimentação elétrica do projetor (veja se a luz que indica o estado de ligado está acesa).
 Kontroller strømkoblingen for projektoren (sjekk at lyset for strøm er på).
2. Verify the settings on your laptop / computer.
 Überprüfen Sie die Einstellungen in Ihrem Laptop / Computer.
 Vérifiez les paramètres de votre ordinateur / portable.
 Compruebe la configuración en su ordenador / ordenador portátil.
 Controllare le impostazioni del proprio laptop / computer.
 Verifique as definições do seu portátil / computador.
 Kontroller innstillingene på datamaskinen/ den bærbare maskinen.
3. Verify that the black-button is not activated on the remote.
 Prüfen, dass "Black" (Verdunkeln) an der Fernbedienung nicht aktiviert ist.
 Vérifiez que le bouton noir n'est pas activé sur la télécommande.
 Verifique que el botón negro no esté activado para control remoto.
 Verificare che il pulsante nero sul telecomando non sia attivato.
 Assegure-se de que botão preto não esteja ativado no controle remoto.
 Kontroller at Black-knappen på fjernkontrollen ikke er aktivert.
4. Check if lens cap is mounted.
 Sicherstellen, dass die Linseabdeckung abgenommen ist.
 Assurez-vous que la protection de la lentille n'est pas posée.
 Compruebe que la tapa de la lente está montada.
 Controllare che non sia montato il coperchio della lente.
 Verifique se o protetor de lente está colocado.
 Kontroller om linsedekselet er på.

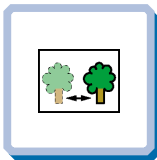

The projected image is not focused.
Das projizierte Bild ist nicht scharf.
L'image projetée n'est pas au point.
La imagen proyectada no está enfocada.
L'immagine proiettata non è a fuoco.
A imagem projetada está fora de foco.
Bildet som projiseres er ikke i fokus.

1. Ensure that the distance from the projector to the screen is at least at the minimum specified.
 Überprüfen, ob der Abstand zwischen Projektor und Leinwand groß genug ist.
 Vérifiez que la distance minimum indiquée entre le projecteur et l'écran est respectée.
 Asegúrese de que la distancia desde el proyector a la pantalla.
 Assicurarsi che la distanza dal proiettore allo schermo non sia inferiore al minimo di specifica.
 Certifique-se de que a distância entre o projetor e a tela esteja pelo menos no mínimo especificado.
 Kontroller at avstanden fra projektoren til skjermen er minst angitt minimum.
2. Adjust the focus ring on the projection lens.
 Fokusing an der Linse einstellen.
 Réglez la bague de mise au point sur la lentille de projection.
 Ajuste el aro de enfoque de la lente de proyección.
 Regolare l'anello di messa a fuoco sulla lente di proiezione.
 Ajuste o anel de foco à lente de projeção.
 Vri på fokuseringsringen på projeksjonslinsen.
3. Ensure that the projection lens is clean.
 Prüfen, ob Linse sauber ist.
 Vérifiez que la lentille de projection est propre.
 Asegúrese de que la lente de proyección está limpia.
 Assicurarsi che la lente di proiezione sia pulita.
 Assegure-se de que a lente de projeção.
 Kontroller at projeksjonslinsen er ren.
4. Use special lense cleaning paper.
 Benutzen Sie spezielles lensereinigung Papier.
 Utilisez le papier spécial de nettoyage de lentille.
 Utilice el papel especial de la limpieza del lente.
 Usare la carta speciale da pulizia del lente.
 Use o papel especial da limpeza do lente.
 Bruk egnet klut for linse.
5. In Video: Check the sharpness setting in the "Set up/Picture" menu and adjust if necessary.
 Bei Video: Schärfereinstellung im Menü "Set up/Picture" prüfen und bei Bedarf ändern.
 Source Vidéo: Vérifiez le réglage de netteté de l'image dans le menu "Set up/Picture" et réglez si besoin est.
 En video: compruebe la configuración de la nitidez en el menú "Set up/Picture" ajústelo si fuera necesario.
 In Video: Controllare la regolazione della nitidezza nel menu "Set up/Picture" e regolarla se necessario.
 No video: verifique a configuração da nitidez no menu "Set up/Picture" ajuste a se necessário.
 I video-modus: Kontroller innstillingen for skarphet på menyen "Set up/Picture", og tilpass den om nødvendig.
6. Verify that the projector is correctly aligned with the projected screen.
 Prüfen, ob der Projektor richtig zur Leinwand ausgerichtet ist.
 Vérifiez que le projecteur est correctement aligné avec l'écran.
 Verifique que el proyector está correctamente alineado con la pantalla proyectada.
 Verificare che il proiettore sia allineato correttamente con lo schermo.
 Verifique se o projetor está corretamente alinhado com a tela de projeção.
 Kontroller at projektoren er korrekt plassert i forhold til skjermen det projiseres.



No sound
Kein Ton
Pas de son
Sin sonido
Nessun suono
Não há som
Ingen lyd

1. Check the audio input connections.
 Audiodatenanschluss überprüfen.
 Vérifiez les connexions entrée audio.
 Compruebe las conexiones de entrada de audio.
 Controllare i collegamenti di ingresso audio.
 Verifique as conexões de entrada de áudio.
 Kontroller tilkoblingene for lydinnangene.
2. Adjust the volume.
 Lautstärke einstellen.
 Réglez le volume.
 Ajuste el volumen.
 Regolare il volume.
 Ajuste o volume.
 Juster lydstyrken.
3. Verify that internal speaker off setting is not active.
 Überprüfen Sie, dass die Deaktivierung der internen Lautsprecher nicht aktiviert ist.
 Vérifiez que le haut-parleur interne non paramétré est bien désactivé.
 Compruebe que la configuración de apagado del altavoz interno no esté activa.
 Controllare che l'impostazione off dell'altoparlante interno non sia attiva.
 Certifique-se de que a definição "desligada" da coluna interna não está activa.
 Kontroller at innstillingen som slår av den innebygde høyttaleren, ikke er aktivert.

TROUBLESHOOTING

FEHLERBEHEBUNG SOLUTION AUX PROBLEMES LES PLUS FREQUENTS

SOLUCIÓN DE PROBLEMAS SOLUZIONE DEI PROBLEMI LOCALIZAÇÃO DE DEFEITOS FEILSØKING

4. Verify that the audio cable is OK.
Prüfen, ob Audiokabel in Ordnung ist.
Vérifiez que le câble audio n'est pas endommagé.
Verifique que el cable de audio está bien.
Verificare che il cavo audio sia a posto.
Verifique se o cabo de áudio está conforme.
Kontrollieren, ob die Audiokabeln in Ordnung sind.
5. Adjust the audio source.
Einstellungen an der Audioquelle vornehmen.
Réglez la source audio.
Ajuste la fuente de audio.
Regolare la sorgente audio.
Ajuste a fonte de áudio.
Juster lyd-kilden.

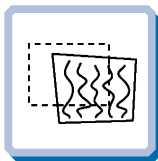

The projected image is distorted.
Das projizierte Bild ist verzerrt.
L'image projetée est déformée.
La imagen proyectada está distorsionada.
L'immagine proiettata è distorta.
A imagem projetada está distorcida.
Bildet som vises er forvrengt.

1. Press the Power button and go to Reset.
Auf Power drücken und Reset durchführen.
Appuyez sur le bouton "Power" et Remettez à zéro.
Pulse el botón Power y vaya a Reset (restablecer).
Premere il tasto Power e iniziare il Ripristino (reset).
Desligue e ligue novamente o projetor pressionando o botão LIG/DESLIG.
Trykk på Power-knappen og gå til Reset.
2. Select Menu on remote or on projector.
Menü über Fernbedienung oder Bedienfeld wählen.
Sélectionnez Menu sur la télécommande ou sur le projecteur.
Selecione el Menú por control remoto o en el proyector.
Selezionare Menù sul telecomando o sul proiettore.
Selecione o Menu no controle remoto ou no projetor.
Trykk på Menu på fjernkontrollen eller projektoren.
- 2.1 Go to "Set up".
Zu "Set up" gehen.
Choisissez "Set up".
Vaya a "Set up".
Portarsi su "Set up".
Vá ao menu "Set up".
Gå til "Set up".
- 2.2 Select "Picture".
"Picture" wählen.
Sélectionnez "Picture".
Selecione "Picture".
Selezionare "Picture".
Selecione "Picture".
Velg "Picture".
- 2.3 Select Frequency or Tuning for image manual adjustments.
Frequenz oder Tuning für manuelle Bildeinstellung wählen.
Sélectionnez Frequency ou Tuning pour le réglage manuel de l'image.
Selecione Frequency o Tuning para ajustar manualmente la imagen.
Selezionare Frequency o Tuning per la regolazione manuale dell'immagine.
Selecione Frequência ou Sintonia para ajustes manuais da imagem.
Velg Frequency eller Tuning for å justere bildet manuelt.
3. Verify that the projector is not tilted/elevated and that it is parallel with the projected screen.
Sicherstellen, dass der Projektor nicht schief oder zu hoch steht und dass er parallel zur Leinwand ausgerichtet ist.
Vérifiez que le projecteur n'est pas incliné/surlevé et qu'il est parallèle à l'écran de projection.
Verifique que el proyector no está inclinado/elevado y que está en paralelo con la imagen proyectada.
Verificare che il proiettore non sia inclinato/elevato e che sia parallelo allo schermo di proiezione.
Verifique se o projetor não está inclinado/elevado e se está paralelo à tela projetada.
Kontroller at projektoren ikke er vippt opp- eller nedover eller hevet, og at den er parallell med skjermen det projiseres.
4. Check if the digital keystone function is active. Adjust if necessary.
Prüfen, ob Trapezverzerrung aktiv ist. Falls nötig, einstellen.
Regardez si la fonction keystone digitale est active. Réglez si besoin est.
Compruebe si la función de distorsión digital está activada. Ajustela si fuera necesario.
Controllare che sia attiva la funzione di distorsione digitale. Regolarla se necessario.
Veja se a função digital do ângulo trapezoidal está ativa. Ajuste se necessário.
Kontroller om den digitale keystone-funksjonen er aktiv. Juster den om nødvendig.

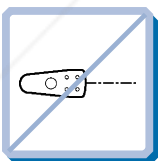

Projector does not respond to remote control.
Die Fernbedienung funktioniert nicht.
La télécommande ne marche pas.
El proyector no responde al control remoto.
Il proiettore non risponde al telecomando.
O projetor não responde ao controle remoto.
Fjernkontrollen virker ikke.

1. Verify that working batteries are inserted in the remote
Prüfen, ob Batterien fehlen bzw. leer sind und ob die Fernbedienung eingeschaltet ist
Vérifier que des piles sont installées dans la télécommande et qu'elles sont chargées
Compruebe que las pilas del mando están correctamente colocadas
Verificare che le batterie del telecomando siano cariche
Verifique se as baterias de trabalho foram instaladas no controle remoto
Kontroller om det er satt inn batterier som virker i fjernkontrollen
2. Check for other interfering IR sources in the room i.e. fluorescent light tubes, sunlight, active IR COM ports from laptops etc.
Nach anderen störenden Infrarotquellen im Raum suchen, z.B. Leuchtstoffröhren, Sonnenlicht, aktive Infrarot-Anschlüsse von Laptops, etc.
Recherchez dans la pièce d'autres sources IR pouvant interférer: tubes néons, lumière du soleil, ports COM IR actifs de portables, etc.
Compruebe otras posibles fuentes de interferencias de infrarrojos en la habitación, p.e. tubos fluorescentes, luz solar, puerto COM infrarrojo del ordenador activo, etc.
Controllare che nella stanza non vi siano altre sorgenti IR che possano interferire quali tubi luminosi fluorescenti, luce solare, PC portatili con porte COM attive ad IR, ecc.
Veja se há outras fontes de irradiação eletromagnética interferindo no local, ou seja, tubos de luz fluorescente, luz do sol, portos de comunicação a infraverme ho de laptops etc.
Kontroller om det finnes andre forstyrrende infrarøde kilder i rommet, f.eks. lysstoffrør, sollys, aktive IR COM-porter på bærbare datamaskiner osv.

M

TECHNICAL DATA

TECNISCHE DATEN CARACTERISTIQUES TECHNIQUES DATOS TÉCNICOS DATI TECNICI DADOS TÉCNICOS TEKNISCHE DATA

GENERAL CONDITIONS	ALLGEMEINE DATEN	ENVIRONNEMENT	CONDICIONES GENERALES	CONDIZIONI GENERALI	CONDÇÕES GERAIS	GENERELLE KRAV	
Storage temperature, sealevel	Lagertemperatur, Meeresspiegel	Température de stockage au niveau de la mer	Temperatura de almacenamiento a nivel del mar	Temperatura di conservazione, a livello del mare	Temperatura de armazenamento, a nível do mar	Temperatur ved lagring, havflaten	-20 - 60 °C -4 - 140 F
Storage humidity, non-condensing	Lagerfeuchtigkeit, nicht kondensierend	Humidité de stockage, sanscondensation	Humedad relativa de almacenamiento sin condensación	Umidità di conservazione, senza condensa	Umidade de armazenamento, sem condensação	Fuktighet ved lagring, ikke-kondenserende	10 - 90 % RH
Operating temperature ambient	Raumtemperatur für Betrieb	Température ambiante de fonctionnement	Temperatura ambiente de funcionamiento	Temperatura di funzionamento ambiente	Temperatura de funcionamento	Romtemperatur ved bruk	5 - 40 °C at sea level 5 - 35 °C 3000m 41 - 104 F at sea level 41 - 98 F 10000 ft.
Operating humidity	Betriebsfeuchtigkeit	Humidité de fonctionnement	Humedad relativa de funcionamiento	Umidità di funzionamento	Umidade de funcionamento	Fuktighet ved bruk	20 - 80 % RH Allow for slow acclimatization at high humidity

PROJECTION DISTANCES	PROJEKTIONS-ABSTÄNDE	DISTANCES DE PROJECTION	DISTANCIAS DE PROYECCIÓN	DISTANZE DI PROIEZIONE	DISTÂNCIAS DE PROJEÇÃO	PROJEKSJONS-AVSTANDER	
WIDE	WEITWINKEL	GRAND ANGLEAIRE	GRAN ANGULAR	GRANDANGOLO	GRÂ ANGULAR	VIDVINKEL	
120 cm	120 cm	120 cm	120 cm	120 cm	120 cm	120 cm	34" (Diagonal)
141 cm	141 cm	141 cm	141 cm	141 cm	141 cm	141 cm	40" (Diagonal)
251 cm	251 cm	251 cm	251 cm	251 cm	251 cm	251 cm	70" (Diagonal)
360 cm	360 cm	360 cm	360 cm	360 cm	360 cm	360 cm	100" (Diagonal)
726 cm	726 cm	726cm	726 cm	726cm	726 cm	726 cm	200" (Diagonal)
1100 cm	1100 cm	1100 cm	1100 cm	1100 cm	1100 cm	1100 cm	302" (Diagonal)
TELE	TELEOBJEKTIV	TELEOBJECTIF	TELEOBJETIVO	TELEBIETTIVO	TELEOBJETIVA	TELE	
120 cm	120 cm	120 cm	120 cm	120 cm	120 cm	120 cm	27" (Diagonal)
141 cm	141 cm	141 cm	141 cm	141 cm	141 cm	141 cm	31" (Diagonal)
251 cm	251 cm	251 cm	251 cm	251 cm	251 cm	251 cm	55" (Diagonal)
360 cm	360 cm	360 cm	360 cm	360 cm	360 cm	360 cm	78" (Diagonal)
726 cm	726 cm	726 cm	726 cm	726 cm	726 cm	726 cm	156" (Diagonal)
1100 cm	1100 cm	1100 cm	1100 cm	1100 cm	1100 cm	1100 cm	236" (Diagonal)
Projection lense	Linse	Objectif	Lente de proyección	Lente di proiezione	Lente de projeção	Projeksjonslinse	1.3 Zoom Ratio f = 47 - 61 mm F / 1.8 . 2.1
Distance : Width	Abstand : Breite	Distance : Largeur	Distancia : Anchura	Distanza : Larghezza	Distância : Largura	Avstand : bredde	1.47 - 1.92 : 1
Projection distance	Projektionsabstand	Distance de projection	Distancia de proyección	Distanza di proiezione	Distância de projeção	Projeksjonsavstand	1.2 - 11 m 3.6 - 26.2.ft.

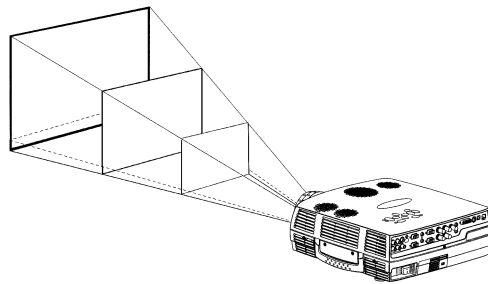

FixYourDLP.com
Sponsored by DM

Specifications are subject to change without prior notice. Die technischen Daten können ohne Vorankündigung geändert werden. Les spécifications peuvent être modifiées sans préavis. Las especificaciones podrán ser modificadas sin aviso previo. Le specifiche sono passibili di modifica senza preavviso. As especificações são sujeitas a mudanças sem aviso prévio. Spesifikasjonene kan endres uten varsel.

Discount-Merchant.com (800) 281-8860

THE TRUSTED SOURCE FOR PROJECTOR LAMPS AND ACCESSORIES

TECHNICAL DATA

TECNISCHE DATEN CARACTERISTIQUES TECHNIQUES DATOS TÉCNICOS DATI TECNICI DADOS TÉCNICOS TEKNISCHE DATA

PROJECTOR UNIT	PROJEKTOR/ GERÄT	PROJETEUR	PROYECTOR	UNITÀ DEL PROIETTORE	PROJETOR	PROJEKTOR- ENHETEN	
Video frequency	Videofrequenz	Video fréquence	Frecuencia de video	Frequenza video	Frequência de vídeo	Videofrekvens	12-162 MHz
Horizontal sync.	Horizontalfrequenz	Sync. horizontale	Sinc. horizontal	Sinc. orizz	HorizontalSinc.	Horisontal synk.	15-110 KHz
Vertical sync.	Verticalfrequenz	Sync. verticale	Sinc. vertical	Sinc. vert.	VerticalSinc.	Vertikal synk.	43.5-130 Hz
Computer input	Computereingang	Entrée ordinateur	Entrada de señal del ordenador	Ingresso computer	Entrada Computador	Datamaskin-inngang	0.5 - 1 Vpp
Audio input	Audioeingang	Entrée audio	Entrada de audio	Ingresso audio	Entrada de áudio	Lydingang	1 VRMS
Speakers	Lautsprecher	Haut-parleurs	Altavoces*	Altoparlanti	Alto-falantes	Hayttalere	2 x 2 W + 1 x 5 W
Conformance	Prüfzeichen	Conformité	Homologación	Conformità	Conformidade	Oppfyller kravene til	CE. UL. GOST R. CUL. FCC Class A Subpart J. Part 15
Power supply	Stromversorgung	Alimentation électrique	Suministro de corriente	Alimentazione elettrica	Fonte de alimentação	Strømforsyning	4 - 1.5 A 100 - 240V~ +/- 10% 50 - 60 Hz
Computer compatibility resized to native pixel resolution	Computer-kompatibilität. Resizing auf Originalauflösung (Pixel)	Compatibilité ordinateur au redimensionnement de la résolution d'origine (pixels)	Compatibilidad del ordenador ajustada a la resolución pixels. Resolución en pixels	Compatibilità computer (riclassificata in base alla risoluzione pixel originaria)	Compatibilidade do computador ajustada à resolução de origem (pixels)	Datamaskin-kompatibilitet, størrelse endret til naturlig pikseloppløsning	800x600 832x624 1024x768 1152x864 1152x870 1280x1024 1400x1050 HDTV: 720i, 720p, 1080i RGB video Component video
Supported color system	Unterstütztes Farbsystem	Système de télévision en couleurs supporté	Sistema de color soportado	Sistema di colore supportato	Sistema de cores suportado	Fargesystem som støttes	NTSC M, 4.43, Japan, SECAM, MESECAM PAL BHGI, N, combination N, M
Dimensions (HxWxL)	Maße (HxBxL)	Encombrement (HxPxL)	Dimensiones (Alto x Ancho x Largo)	Dimensioni (Alt. x Largh. x Lunghe.)	Dimensões (Alt. x Larg. x Comp.)	Størrelse (HxBxL)	130 x 322 x 352 mm 5.11 x 12.67 x 13.85 inch
Weight	Gewicht	Poids	Peso	Peso	Peso	Vekt	5.9 kg / 13 lbs
Ceiling mount	Deckenmontage	Montage au plafond	Soporte de techo	Montaggio a soffitto	Montagem de teto	Takbeslag	UL tested / listed ceiling mount with capacity of min. 23.6 kg / 52 lbs
Keystone correction	Trapezentzerrung	Compensation destorsion trapézoïdale	Corrección de la clave	Correzione della deformazione	Correção da distorção trapezoidal	Keystone-korreksjon	11.5 - 15.5 °Optical
Up / down ratio	Auf/ ab Verhältnis	À travers le taux	Arriba/ abajo de la relación de transformación	Su e giù il rapporto	Acima de e para baixo relação	Opp / ned forhold	9 : 1 up / down
Projection lamp	Projektionslampe	Lampe de projection	Lámpara para proyección	Lampadina di proiezione	Lâmpada de projeção	Projeksjonslampe	270 W SHP / 2000 hours
Noise level	Geräuschpegel	Niveau sonore	Nivel de ruidos	Livello di rumore	Nível de barulho	Støynivå	<34 dB (A) (typ)
Display	Anzeige	Affichage	Presentación en pantalla	Display	Tela de exibição	Bildeprosessor	1.3" PolySilicon LCD x 3 with MLA (Micro Lens Array)
Pixels	Auflösung	Résolution	Pixels	Pixel	Resolução	Piksler	XGA: 1024 x 768 x 3
Colors	Farben	Couleurs	Colores	Colori	Cores	Farger	16.7 Million

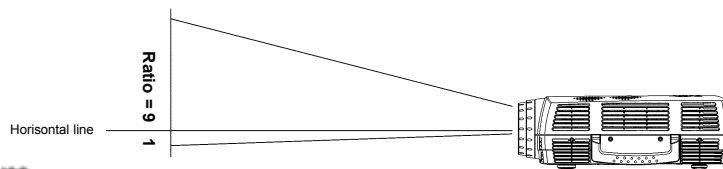

FixYourDLP.com
Sponsored by DM

Specifications are subject to change without prior notice. Die technischen Daten können ohne Vorankündigung geändert werden. Les spécifications peuvent être modifiées sans préavis. Las especificaciones podrán ser modificadas sin aviso previo. Le specifiche sono passibili di modifica senza preavviso. As especificações são sujeitas a mudanças sem aviso prévio. Spesifikasjonene kan endres uten varsel.

Discount-Merchant.com (800) 281-8860

THE TRUSTED SOURCE FOR PROJECTOR LAMPS AND ACCESSORIES

TECHNICAL DATA

TECNISCHE DATEN CARACTERISTIQUES TECHNIQUES DATOS TÉCNICOS DATI TECNICI DADOS TÉCNICOS TEKNISCHE DATA

1 CONNECTORS ANSCHLÜSSE CONNECTEURS CONECTORES CONNETTORI CONECTORES KONTAKTER

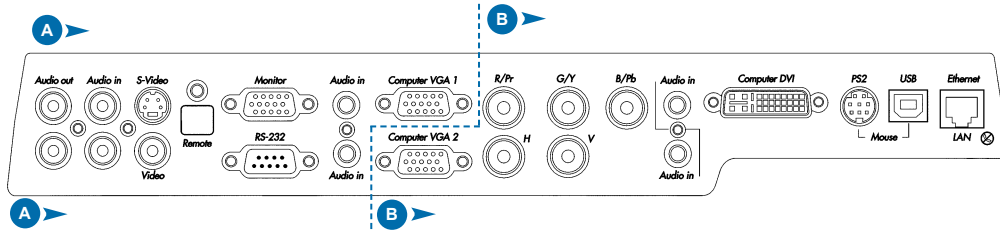

A		Audio out	Audio in	S-video	Remote	Monitor	RS-232	Audio in	Computer VGA 1
		red phono	red phono	4 PIN MINIDIN FEMALE	2.5 mm JACK TIP: right RING: left STEM: common	15 HIGH DENSITY DSUB FEMALE	9 PINS DSUB MALE	3.5 mm JACK TIP: right RING: left STEM: common	15 HIGH DENSITY DSUB FEMALE
				Video		1 Analog R in 2 Analog G in 3 Analog B in 4 NC (not connected) 5 AGND 6 Analog R GND in 7 Analog G GND in 8 Analog B GND in 9 Reserved 10 Sync GND in 11 NC 12 NC 13 HSync in 14 VSync in 15 NC	1 NC 2 RXD 3 TXD 4 NC 5 Gnd 6 NC 7 RTS (fixed - 5V) 8 Not used	1 Analog R in 2 Analog G in 3 Analog B in 4 AGND 5 AGND 6 Analog R GND in 7 Analog G GND in 8 Analog B GND in 9 Reserved 10 Sync GND in 11 AGND 12 DDC/SDA 13 HSync in 14 VSync in 15 DDC/SCL	
		white phono	white phono	PHONO/RCA FEMALE STEM: composite SHIELD:GND				3.5 mm JACK TIP: right RING: left STEM: common	

B		Computer VGA 2	R/Pr	G/Y	B/Pb	Audio In	Computer DVI	PS2	USB	Ethernet
		15 HIGH DENSITY DSUB FEMALE				3.5 mm JACK	1 TMDS Data 2- 2 TMDS Data 2+ 3 TMDS Data 2/4 Shield 4 Not used 5 Not used 6 DDC Clock 7 DDC Data 8 NC 9 TMDS Data 1- 10 TMDS Data 1+ 11 TMDS Data 1/3 Shield 12 Not used 13 Not used 14 +5V Power 15 Ground (+5, Analog HV Sync.) 16 Hot Plug Detect 17 TMDS Data 0- 18 TMDS Data 0+ 19 TMDS Data 0/5 Shield 20 Not used 21 Not used 22 TMDS Clock Shield 23 TMDS Clock+ 24 TMDS Clock-ss	6 PIN MINIDIN FEMALE	DIGITAL USB	1 TX+ 2 TX- 3 RX+ 4 Not used 5 Not used 6 RX- 7 Not used 8 Not used
		1 Analog R in 2 Analog G in 3 Analog B in 4 AGND 5 AGND 6 Analog R GND in 7 Analog G GND in 8 Analog B GND in 9 Reserved 10 Sync GND in 11 AGND 12 DDC/SDA 13 HSync in 14 VSync in 15 DDC/SCL	STEM RED: R/Pr SHIELD: GND	STEM GREEN: G/Y SHIELD: GND	STEM BLUE: B/Pb SHIELD: GND	TIP: right RING: left STEM: common		1 Data 2 Noy used 3 GND 4 Power, +5 VDC 5 Clock 6 Not used	1 VCC 2 -Data 3 +Data 4 GND	
			H	V		Audio in				
			STEM: H SYNC SHIELD: GND	STEM: V SYNC SHIELD: GND		3.5 mm JACK TIP: right RING: left STEM: common			Mouse	Lan

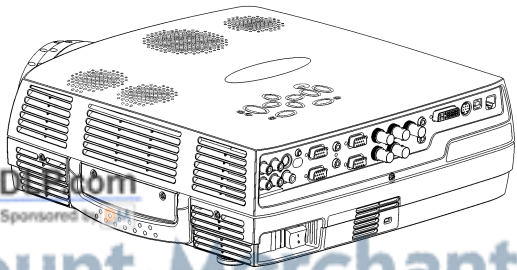

FixYourDiscount.com
Sponsored by

Discount-Merchant.com (800) 281-8860

THE TRUSTED SOURCE FOR PROJECTOR LAMPS AND ACCESSORIES

N

SERVICE INFORMATION

SERVICE-INFO REPARATIONS

INFORMACIÓN SOBRE ASISTENCIA TÉCNICA ASSISTENZA TECNICA INFORMAÇÃO DE SERVIÇO SERVICE INFORMATION



This product contains no user serviceable parts except lamphousing and dustfilter. Attempts to modify mechanics or electronics inside the housing will violate any warranties, and may be hazardous.

If for any reason the product fails to work properly, please contact your dealer for technical support. Prepare a list of the symptoms you observe to make diagnosing easier for your dealer.

Please also include the following:

- Serial number of the unit (SN)
- Part number of the unit (PN)
- Software revision (under main menu selection "SET UP/SERVICE/INFO")
- Connected source information (under main menu selection "BASIC/ABOUT")



Dieses Gerät enthält keine Verschleißteile ausgenommen das Lampengehäuse und der Staubfilter. Der Versuch, elektronische oder mechanische Komponenten im Gehäuse zu manipulieren führt zum Verlust der Garantie und kann eine Gefahr für den Benutzer darstellen.

Sollte das Gerät aus welchem Grund auch immer nicht korrekt funktionieren, wenden Sie sich bitte an Ihren Händler. Bitte halten Sie die auftretenden Probleme schriftlich fest. Damit erleichtern Sie Ihrem Händler die Fehlerdiagnose.

Bitte halten Sie auch folgende Daten bereit:

- Seriennummer des Geräts (SN)
- Teilnummer des Geräts (PN)
- Versionsnummer der Software (im Hauptmenü unter "EINSTELLUNGEN/SERVICE/INFO")
- Information über angeschlossene Quelle (im Hauptmenü unter "GRUNDLEGENDES/ÜBER")



Aucun des pièces de ce produit n'est réparable par l'utilisateur excepté le logement de la lampe et le filtre à poussière. Les tentatives de modification des parties mécaniques ou électroniques de l'appareil annuleront toute garantie et peuvent être dangereuses.

Si le produit ne fonctionnait pas correctement, prenez contact avec votre concessionnaire. Préparez au préalable une liste des symptômes que vous avez observés pour que votre concessionnaire établisse plus aisément le diagnostic.

Veuillez inclure les renseignements suivants:

- Numéro de série de l'unité (SN)
- Numéro de la pièce de l'unité (PN)
- Révision du logiciel (Sélectionnez "RÉGLAGE/SERVICE/INFO" dans le menu principal)
- Les renseignements concernant la source connectée (sélectionnez ESSENTIEL/À PROPOS dans le menu principal)



Este producto no contiene ninguna pieza útil para el usuario excepto el alojamiento de la lámpara y el filtro del polvo. Cualquier intento de modificar la mecánica o electrónica incluida en la carcasa anulará la garantía, y puede resultar peligroso.

Si por cualquier motivo el producto no funciona correctamente, póngase en contacto con su distribuidor para obtener asistencia técnica. Prepare una lista de los problemas que haya observado para facilitar su diagnóstico

Incluya además los siguientes datos:

- Número de serie de la unidad (SN)
- Número de pieza de la unidad (PN)
- Revisión de software (consultar seleccionando "CONFIGURACIÓN/SERVICIO/INFORMACIÓN" en el menú principal)
- Información sobre fuentes conectadas (en BÁSICO/ACERCA del menú principal)



Questo prodotto non contiene parti sostituibili dall'utente tranne la sede della lampada e il filtro della polvere. Qualsiasi tentativo di modificare parti meccaniche o elettroniche interne alla scatola renderà nulla la garanzia e può risultare pericoloso.

Se per qualsiasi motivo il prodotto non funziona adeguatamente, si prega di contattare il rivenditore per l'assistenza tecnica. Preparare una lista dei sintomi osservati per rendere più facile la diagnosi al rivenditore.

Si prega anche di includere le seguenti informazione:

- Numero di serie dell'apparecchiatura (SN)
- Numero del pezzo dell'apparecchiatura (PN)
- Revisione del software (vedere nel menù principale alla selezione "IMPOSTAZIONI/SERVIZIO/INFORMAZIONI")
- Informazioni sulla sorgente collegata (vedere nel menù principale alla selezione INFORMAZIONI DI BASE/INFORMAZIONI SU)



Este produto não contém peças úteis ao usuário exceto o alojamento da lâmpada e o filtro de pó. Tentativas de modificação da mecânica ou eletrônica interna violará qualquer garantia e pode ser perigoso.

Se por qualquer razão o produto não funcionar corretamente, por favor contate o distribuidor para suporte técnico. Prepare uma lista dos sintomas observados a fim de facilitar o diagnóstico para o distribuidor.

Por favor também inclua o seguinte:

- Número de série da unidade (SN)
- Número da peça da unidade (PN)
- Revisão do software (no menu principal - seleção "CONFIGURAÇÃO/SERVIÇO/INFORMAÇÃO")
- Informação da fonte conectada (no menu principal - seleção BÁSICO/SOBRE)



Dette produktet inneholder ingen deler som brukerne kan utføre service på unntatt lampeholder og støvfilter. Forsøk på å endre mekaniske eller elektroniske komponenter innenfor dekslet vil gjøre alle garantier ugyldige, og kan også være farlig.

Hvis produktet av en eller annen grunn ikke virker som det skal, må du kontakte forhandleren for å få teknisk brukerstøtte. Lag en liste over symptomene du ser, slik at det blir lettere for forhandleren å finne ut hva problemet skyldes.

Te også med følgende:

- Enhetens serienummer (SN)
- Enhetens delenummer (PN)
- Programversjon (under hovedmenyvalget "OPPSETT/SERVICE/INFO")
- Informasjon om tilkoblede kilder (under hovedmenyvalget "BASIC/OM")



FixYourDLP.com

Sponsored by

Discount-Merchant.com (800) 281-8860

THE TRUSTED SOURCE FOR PROJECTOR LAMPS AND ACCESSORIES



LAMP REPLACEMENT

LAMPENAUSTAUSCH REMPLACEMENT DE LA LAMPE

SUSTITUCIÓN DE LA BOMBILLA SOSTITUZIONE LAMPADINA SUBSTITUIÇÃO DA LÂMPADA LAMPESKIFT



Change lamp when lifetime expired. Replace expired lamp only with same type and rating.

Lampe nach Ablauf der Lebensdauer austauschen. Nur Lampen gleicher Art und Stärke verwenden.

Changez la lampe lorsque sa durée de vie arrive à expiration. Ne remplacez la lampe que par une lampe ayant les mêmes caractéristiques.

Cambie la lámpara al término de su vida útil. Sustituya siempre la lámpara gastada por otra del mismo tipo y capacidad.

Sostituire la lampada quando termina la sua vita utile. Sostituire la lampada utilizzandone unicamente una della stesso tipo e caratteristiche.

Troque a lâmpada quando o tempo útil de vida expirar. Substitua a lâmpada gasta somente por outra do mesmo tipo e valor nominal.

Skift lampe når levetiden er overskredet. Bruk kun lampe av samme type og med samme effekt.



Disconnect power. Wait 60 minutes before opening lamp housing.

Netzstecker ziehen. Warten Sie 60 Minuten, bevor Sie die Lampentüre öffnen.

Débrancher. Attendez 60 minutes avant d'ouvrir la porte du logement de la lampe.

Desconecte la corriente. Espere 60 minutos antes de abrir la cubierta de la bombilla.

Scolligare la corrente. Attendere 60 minuti prima di aprire la porta della lampadina.

Desligue da força. Aguarde 60 minutos antes de abrir a porta da lâmpada.

Trekk ut strømledningen. Vent 60 minutter før lampeholderen åpnes.



1. Open screw on lampcover.
Lösen Sie die Schraube an der Lampenabdeckung.
Dévissez la vis sur le couvercle de la lampe.
Abra el tornillo de la tapa de la lámpara.
Aprire la vite sulla copertura della lampada.
Desaperte o parafuso da tampa da lâmpada.
Skru ut skruen på lampedekselet.
2. With screwdriver flip open the lampcover.
Öffnen Sie mit einem Schraubenzieher die Lampenabdeckung.
Ouvrez le couvercle de la lampe à l'aide d'un tournevis.
Con un destornillador, abra la tapa de la lámpara.
Con il cacciavite aprire la copertura della lampada.
Com a chave de parafusos abra a tampa da lâmpada.
Vipp opp lampedekselet med skrutrekkeren.
3. Lift up and remove lampcover.
Heben Sie die Lampenabdeckung an, und entfernen Sie sie.
Soulevez le couvercle de la lampe et enlevez-le.
Levante y retire la tapa de la lámpara.
Sollevare e togliere il coperchio della lampada.
Levante e retire a tampa da lâmpada.
Løft opp og fjern lampedekselet.
4. Open screws on lamp housing.
Schrauben des Lampengehäuses öffnen.
Dévissez les vis du logement de la lampe.
Abra los tornillos del alojamiento de la lámpara.
Svitare le viti della lampada.
Desaperte os parafusos do alojamento da lâmpada.
Løsne skruene til lampeholderen.

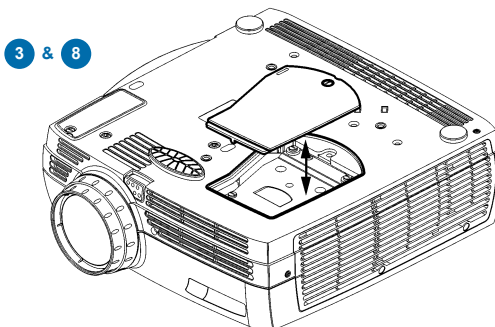
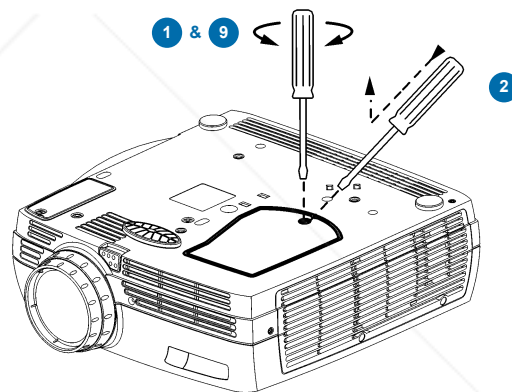

LAMP REPLACEMENT

LAMPENAUSTAUSCH REMPLACEMENT DE LA LAMPE

SUSTITUCIÓN DE LA BOMBILLA SOSTITUZIONE LAMPADINA SUBSTITUIÇÃO DA LÂMPADA LAMPESKIFT

5. Carefully pull out and remove lamp housing.
Lampengehäuse vorsichtig herausnehmen.
 Tirez avec précautions sur le logement de la lampe pour l'enlever.
Extraiga concuidado el alojamiento de la lámpara.
 Tirare attentamente verso fuori e togliere la sede della lampada.
Puxe cuidadosamente para fora e remova o alojamento da lâmpada.
 Forsiktig fjern lampeholderen.
6. Insert new lamp housing.
Neues Lampengehäuse einsetzen.
 Posez le nouveau logement de la lampe.
Introduzca el nuevo alojamiento de la lámpara.
 Inserire la nuova sede della lampada.
Insira um novo alojamento da lâmpada.
 Sett tilbake ny lampeholder.
7. Tighten screws on lamphousing.
Ziehen Sie die Schrauben an dem Lampengehäuse an.
 Serrez les vis sur le logement de la lampe.
Apriete los tornillos en el alojamiento de la lámpara.
 Stringere le viti nella sede della lampada.
Aperte os parafusos do alojamento da lâmpada.
 Stram skruene på lampehuset.
8. Replace lampcover.
Die Lampenabdeckung wieder einlegen.
 Remettez le couvercle de la lampe.
Coloque la tapa de la lámpara.
 Sostituire il coperchio della lampada.
Coloque a tampa da lâmpada.
 Sett tilbake lampedekselet.
9. Tighten screw.
Schrauben festziehen.
 Serrez les vis.
Apriete los tornillos.
 Avvitare le viti.
Aperte os parafusos.
 Stram skruene.

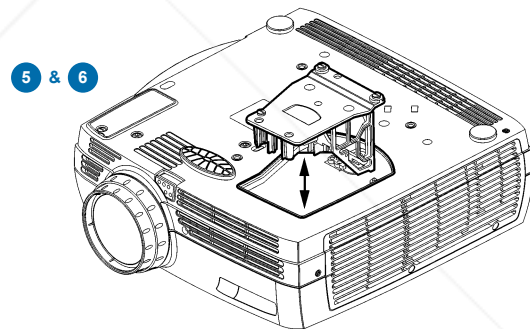
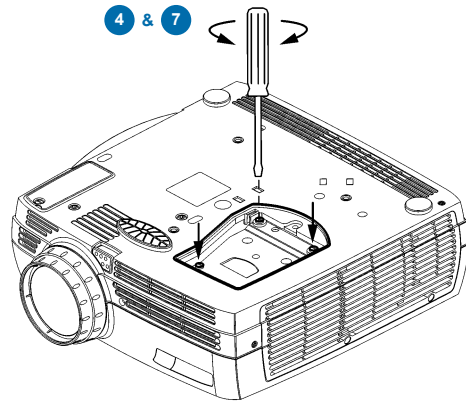

Reset lamp timer. Ref. chap. H
Betriebsstundenzähler auf Null setzen. Siehe Kap. H
 Remettez le compteur de la lampe à zéro. Voir chap. H
Reinicie el temporizador de la lámpara. Ref. cap. H
 Azzerare il temporizzatore della lampada. Rif. cap. H
Efetue o reinicio do temporizador da lâmpada. Ref. cap. H
 Tilbakestill telleverket for lampen. Se kap. H



P

MAINTENANCE (FOR LONG TERM RUNNING)

WARTUNG ENTRETIEN MANTENIMIENTO MANUTENZIONE MANUTENÇÃO VEDLIKEHOLD



Disconnect power.
Netzstecker ziehen.
Débranchez l'appareil.
Desconecte la corriente.
Scollegare l'alimentazione.
Desligue a alimentação.
Trekk ut strømledningen.



1. Open screw on dust filter.
Lösen Sie die Schraube an dem Staubfilter.
Ouvrez la vis sur le filtre à poussière.
Abra el tornillo del filtro de polvo.
Aprire la vite sul filtro della polvere.
Desaperte o parafuso do filtro do pó.
Skrú ut skruen på støvfilteret.
2. With screwdriver flip open the dustfilter.
Öffnen Sie mit einem Schraubenzieher den Staubfilter.
Ouvrez le filtre à poussière à l'aide d'un tournevis.
Con un destornillador, abra el filtro de polvo.
Con il cacciavite aprire il filtro della polvere.
Com a chave de parafusos abra o filtro do pó.
Vipp opp støvfilteret med skrutrekkeren.
3. Carefully remove the dustfilter.
Staubfilter vorsichtig entfernen.
Enlevez le filtre à poussière avec précautions.
Retire con cuidado el filtro del polvo.
Togliere attentamente il filtro della polvere.
Remova cuidadosamente o filtro do pó.
Forsiktig fjern støvfilteret.
4. Clean dustfilter.
Staubfilter reinigen.
Nettoyez le filtre à poussière.
Limpe el filtro del polvo.
Pulire il filtro della polvere.
Limpe o filtro do pó.
Rens støvfilteret.
5. Replace clean dustfilter.
Gereinigten Staubfilter wieder einlegen.
Remettez le filtre à poussière en place.
Coloque de nuevo el filtro del polvo limpio.
Sostituire il filtro della polvere pulito, e avvitare le viti.
Coloque o filtro do pó limpo.
Sett tilbake rent støvfilter.
6. Tighten screws.
Die Schrauben festziehen.
Serrez les vis.
Apriete los tornillo.
Avvitare le viti.
Aperte os parafusos.
Stram festeskruene.
7. Clean all air intakes. ref. chap. B
Alle Lufteinlässe reinigen. Siehe Kap. B
Nettoyez toutes les entrées d'air. Voir chap. B
Limpe todas las tomas de aire. Ref. cap. B
Pulire tutte le prese d'aria. Rif. cap. B
Limpe todas as entradas de admissão do ar. Ref. cap. B
Rens alle luft innsug. Se kap. B
8. Damp cloth only.
Nur feuchte Tücher verwenden.
Uniquement avec un chiffon humide.
Solamente con un paño húmedo.
Solo con un panno umido.
Somente pano úmido.
Klut fuktig kun!

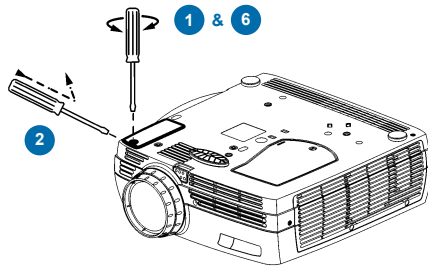

2

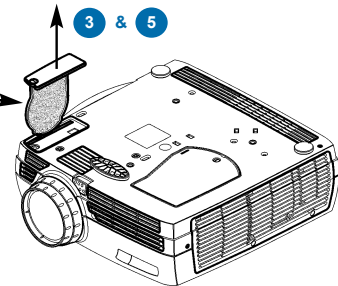

4

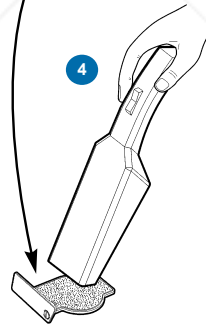

7

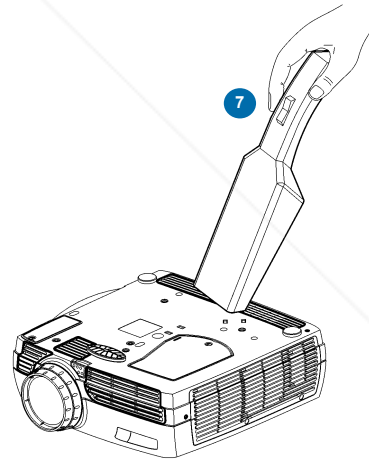

8

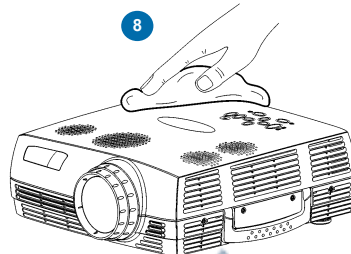

MAINTENANCE (FOR LONG TERM RUNNING)

WARTUNG ENTRETIEN MANTENIMIENTO MANUTENZIONE MANUTENÇÃO VEDLIKEHOLD



Clean the air intakes regularly for sufficient air flow.

Reinigen Sie die Eingangschlitze für die Belüftung regelmäßig, um einen ausreichenden Luftstrom zu gewährleisten.

Nettoyer la prise d'air régulièrement pour maintenir une aération suffisante. Limpez périodiquement les entradas de aire, para que haya suficiente caudal.

Pulire le prese d'aria regolarmente per consentire un flusso di aria adeguato.

Limpar regularmente as entradas de ar para obter vazão de ar suficiente.

Rengjør luftinntakene jevnlig for å sikre tilstrekkelig luftgjennomstrømming.



Refer service to qualified personnel only.

Reparaturen sind von Fachpersonal durchzuführen.

Confier toute intervention à un professionnel qualifié.

La asistencia técnica debe realizarse por personal cualificado.

Eventuali riparazioni devono essere effettuate esclusivamente da personale qualificato.

Remeta a assistência somente a pessoal qualificado.

All service må overlates til kvalifisert personell.



Q FCC WARNING

FCC WARNING

This equipment has been tested and found to comply with the limits for a Class A digital device, pursuant to part 15 of the FCC Rules. These limits are designed to provide reasonable protection against harmful interference when the equipment is operated in a commercial environment. This equipment generates, uses, and can radiate radio frequency energy and, if not installed and used in accordance with the instruction manual, may cause harmful interference to radio communications. Operation of this equipment in a residential area is likely to cause harmful interference in which case the user will be required to correct the interference at his own expense.

EN 55022 WARNING

This is a Class A product. In a domestic environment it may cause radio interference, in which case the user may be required to take adequate measures. The typical use is in a conference room, meeting room or auditorium.



Disclaimer

This user manual is provided as a free service by FixYourDLP.com. FixYourDLP is in no way responsible for the content of this manual, nor do we guarantee its accuracy. FixYourDLP does not make any claim of copyright and all copyrights remain the property of their respective owners.

About FixYourDLP.com

FixYourDLP.com (<http://www.fixyourdlp.com>) is the World's #1 resource for media product news, reviews, do-it-yourself guides, and manuals.

Informational Blog: <http://www.fixyourdlp.com>

Video Guides: <http://www.fixyourdlp.com/guides>

User Forums: <http://www.fixyourdlp.com/forum>

FixYourDLP's Fight Against Counterfeit Lamps:

<http://www.fixyourdlp.com/counterfeits>

Sponsors:

RecycleYourLamp.org – Free lamp recycling services for used lamps:

<http://www.recycleyourlamp.org>

Lamp Research - The trusted 3rd party lamp research company:

<http://www.lampresearch.com>

Discount-Merchant.com – The worlds largest lamp distributor:

<http://www.discount-merchant.com>



FixYourDLP.com

Sponsored by 