



# Disclaimer

This user manual is provided as a free service by FixYourDLP.com. FixYourDLP is in no way responsible for the content of this manual, nor do we guarantee its accuracy. FixYourDLP does not make any claim of copyright and all copyrights remain the property of their respective owners.

About FixYourDLP.com

FixYourDLP.com (<http://www.fixyourdpl.com>) is the World's #1 resource for media product news, reviews, do-it-yourself guides, and manuals.

Informational Blog: <http://www.fixyourdpl.com>

Video Guides: <http://www.fixyourdpl.com/guides>

User Forums: <http://www.fixyourdpl.com/forum>

FixYourDLP's Fight Against Counterfeit Lamps:

<http://www.fixyourdpl.com/counterfeits>

## Sponsors:

RecycleYourLamp.org – Free lamp recycling services for used lamps:

<http://www.recycleyourlamp.org>

Lamp Research - The trusted 3rd party lamp research company:

<http://www.lampresearch.com>

Discount-Merchant.com – The worlds largest lamp distributor:

<http://www.discount-merchant.com>



**FixYourDLP.com**

Sponsored by 

# USER GUIDE

## IMPRESSION 960

*Not the actual front page*



**Discount-Merchant.com (800) 281-8860**  
**THE TRUSTED SOURCE FOR PROJECTOR LAMPS AND ACCESSORIES**

801.230  
USG/960/AE-C  
18.09.96

# USER GUIDE



**Discount-Merchant.com (800) 281-8860**  
**THE TRUSTED SOURCE FOR PROJECTOR LAMPS AND ACCESSORIES**

## **IMPRESSION 960**



**Discount-Merchant.com (800) 281-8860**  
**THE TRUSTED SOURCE FOR PROJECTOR LAMPS AND ACCESSORIES**

## TABLE OF CONTENTS

1 SYMBOL DESCRIPTIONS .....	5
2 SAFETY INSTRUCTIONS .....	5
3 INTRODUCTION.....	9
4 MAIN FEATURES .....	10
5 SUPPLIED MATERIAL.....	11
6 OPTIONAL MATERIAL .....	11
7 SETTING UP THE LCD PROJECTOR .....	12
7.1 COMPUTER.....	13
7.2 MOUSE.....	15
8 USING THE LCD PROJECTOR .....	17
8.1 OPTICS.....	17
8.2 ILLUMINATION SYSTEM .....	17
8.3 REMOTE CONTROL .....	18
8.4 CONTROL PANEL.....	20
8.5 CONNECTORS .....	21
9 FEATURES.....	22
10 TROUBLE-SHOOTING .....	26
11 MAINTENANCE .....	28
11.1 FUSE REPLACEMENT .....	28
12 SERVICE .....	29
12.1 LAMP REPLACEMENT.....	29
12.2 LAMP REPLACEMENT MESSAGES.....	29
13 TECHNICAL DATA.....	32
14 CONNECTORS.....	35
15 FCC STATEMENT .....	36
16 ENVIRONMENTAL STATEMENT.....	37
17 SERVICE INFORMATION.....	38
18 CONNECTION LAYOUT .....	39
(Foldout Page)	



This publication is printed on recycled paper

The information contained in this User Guide is preliminary, and the products described herein are subjected to change without prior notice.



**Discount-Merchant.com (800) 281-8860**  
**THE TRUSTED SOURCE FOR PROJECTOR LAMPS AND ACCESSORIES**

## 1 SYMBOL DESCRIPTIONS



### DANGEROUS VOLTAGE

This symbol is intended to alert the user to the presence of uninsulated “dangerous voltages” within the product housing that may be of sufficient magnitude to constitute a risk of electric shock to persons.



### WARNING

This symbol is used on the product to alert the user of important operating and maintenance (servicing) instructions, and also used in the product literature to indicate important safety-related information.



### HOT

This symbol is used on the product to make the user aware of hot surfaces, i.e. fan ventilation grill.



### NOTE

This symbol is used in this publication to highlight information for the user.

## 2 SAFETY INSTRUCTIONS



*Read instructions - All the safety and operating instructions should be read before the projector is operated.*



*Retain instructions - The safety and operating instructions should be retained for future reference*



*Heed warnings - All warnings on the projector and in the User Guide should be adhered to. If ignored, use of this projector may cause death, injury or material damage.*



*The normal operating life for the lamp is 750 hours.  
High-pressure lamp may explode if improperly used.  
Refer all servicing to authorized personnel only.*

1. **Water and Moisture** - The projector is designed for indoor use only and should not be used near water and moisture.
2. **Carts and Stands** - Place the projector on a stable, hard surface in a manner that does not obstruct ventilation ports and openings in the cabinet. Unstable carts, stands, tables, etc. may cause the projector to fall, which may cause serious injury to people and/or the projector.
3. **Ventilation** - Slots and openings in the cabinet are provided for ventilation. To ensure reliable operation of the projector and protection from overheating, do not block or cover slots and openings in any way. Do not place the projector on any soft surface or close to a heating source, radiator, etc. Never install the projector in an enclosed unit.
4. **Heat** - The projector should be situated away from heat sources such as direct sunlight, radiators, stoves or other strong heat sources.
5. **Power Sources** - The projector must only be connected to proper electrical voltage as marked on the projector body. The projector should be connected to electrical outlet using a power cord compatible with the local electrical voltage. If you are not sure about the type of electrical service at your location, consult your projector dealer or local power company.
6. **Power Cord Protection** - Power cords should be routed so that they are not likely to be walked on, pinched or unduly bent by items placed upon or against them. Pay particular attention to cords and cables at the point where they exit from the projector.



7. **Cleaning** - The projector should be cleaned only as recommended, see the Maintenance section. Disconnect the power cord from the power outlet before cleaning. Do not use liquid cleaners or aerosol cleaners.
8. **Non-use Periods** - The power cord of the projector should be unplugged from the outlet when left unused for a long period of time.
9. **Damage Requiring Service** - The projector should be serviced only by authorized service personnel when;
  - the power supply cord or the plug has been damaged,
  - objects have fallen, or liquid spilled, into the projector,
  - the projector has been exposed to water or condense,
  - the projector does not appear to operate normally (fan not working, noise, smell, smoke, heat etc.)
  - the projector has been dropped or damaged.
10. **Object or Liquid Entry** - Care should be taken so that objects do not fall into the projector casing. Be careful not to spill liquids into the inside of the projector. Do not insert metal or flammable objects into the projector.
11. **Servicing** - The user should not attempt to perform unusual or technical service to the projector. Do not open the unit. Refer all servicing to authorized service personnel.
12. **Grounding or Polarization** - Precautions should be taken so that grounding or polarization of a projector is maintained. Do not use a three prong to a two prong adapter.



*To prevent electric shock, do not use the polarized ac plug with an extension cord, receptacle or other outlet unless the blades can be fully inserted to prevent blade exposure.*



FixYourDLP.com

Sponsored by 

14. **Lamp Replacement** - Do not attempt to replace lamp. Contact an authorized service centre for lamp replacement.

**THE TRUSTED SOURCE FOR PROJECTOR LAMPS AND ACCESSORIES**

15. **Abnormality** - If you detect an abnormal smell or smoke, immediately turn off the power switch. Disconnect the power plug from the power switch to prevent fire or electric shock.

16. **Lifting/moving** - When the projector is to be moved, let the unit cool down completely, cover the lens, disconnect the power plug from the power outlet and disconnect all external cords and cables to prevent damage that may cause a fire, electric shock, etc. Be careful when lifting and carrying the unit as it is heavy.
17. **Lamp Beam** - Do not look directly into the projector or lens when operating the projector. The lamp emits rays which may cause eye injury and/or sunburns.
18. **Electrical Shock** - To reduce risk of electrical shock do not open the unit. Refer all servicing to authorized personnel only.



**Discount-Merchant.com (800) 281-8860**  
**THE TRUSTED SOURCE FOR PROJECTOR LAMPS AND ACCESSORIES**

### 3 INTRODUCTION

Congratulations on purchasing this state-of-the-art, high-resolution LCD projector. This projector can be connected to both computer and video sources for the best projection results and maximum compatibility.

The ability to display a multitude of colors simultaneously as well as high resolution, makes it the ideal choice for presenting computer generated text and graphics. Direct support for RGB-Video makes it compatible with professional video and multimedia equipment.

Applications include presentations, software training, educational use, advertising, information boards and other situations where a small or large audience shares information.

Please spend some time reading this manual to get familiar with the product, so that you can get the most out of your new LCD projector.



**Discount-Merchant.com (800) 281-8860**  
**THE TRUSTED SOURCE FOR PROJECTOR LAMPS AND ACCESSORIES**

## 4 MAIN FEATURES

The unit employs the following important features that in total provide you with a highly functional and powerful projector :

- **High brightness illumination system**
- **640x480 to 1280x1024 image resolution**
- **Built in RGB video interface**
- **3 x RGB input/output connectors**
- **16.7 million colors**
- **BatMouse™, remote control mouse**
- **On Screen Display (OSD)**
- **User settings memorized**
- **Low noise cooling system**
- **False-light blocking**
- **4m (13 ft.) cable with monitor V-split redrive**

## 5 SUPPLIED MATERIAL

A complete set includes the following components :

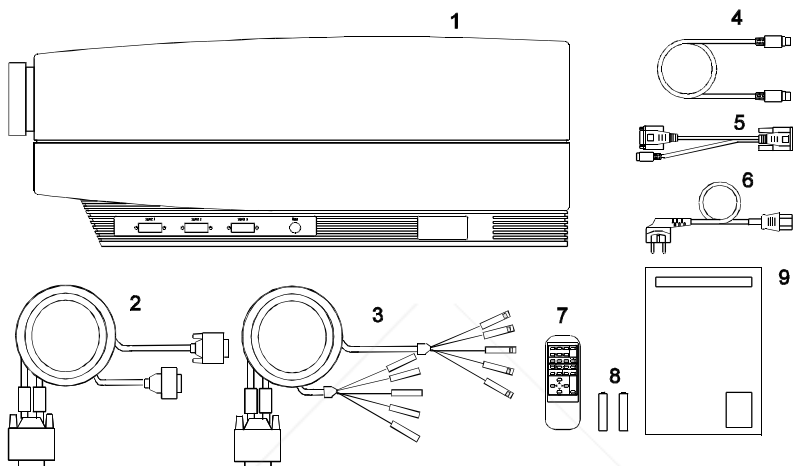

- |                               |                             |
|-------------------------------|-----------------------------|
| 1. LCD Projector              | 6. Power Cord               |
| 2. VGA/XGA V-Split Cable      | 7. BatMouse, Remote Control |
| 3. BNC V-Split Cable          | 8. Batteries                |
| 4. Mouse Cable                | 9. User Guide               |
| 5. Mouse Adapter PC (Y-Split) |                             |

## 6 OPTIONAL MATERIAL

Optional cables and adapters are available for special computer sources such as PS/2, 13W3, MAC etc. Consult your dealer for further information.

FixYourTech.com  
Sponsored by

**Discount-Merchant.com (800) 281-8860**  
THE TRUSTED SOURCE FOR PROJECTOR LAMPS AND ACCESSORIES

## 7 SETTING UP THE LCD PROJECTOR

Switch off all equipment before connecting the projector. Be aware of static electricity that may build up, especially in the dry season and when operating on synthetic carpets. Discharge any static electricity by touching a metallic surface before you start.



*Do not cover the air inlet in front or the air outlet on top of the projector housing, as this will block the cooling. Also make sure to place the projector on a flat, hard surface to avoid blocking the bottom air inlet. A thermal safety switch will cut off the illumination system if the ventilation is reduced.*

Place the LCD projector on a table at a suitable distance from the projection screen in order to get the desired size of the projected image on the wall (see illustration below). Adjust the projection lens for a sharp image by turning the focusing wheel on the lens barrel. Project on a flat surface screen with high reflectivity to get a bright and undistorted, rectangular image. Best results are obtained in a dimmed room with no direct sunlight shining in.

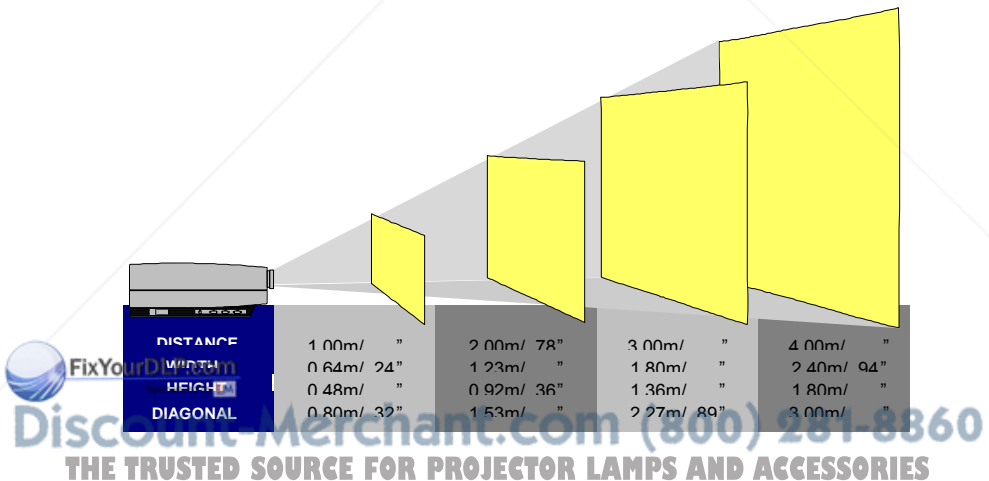

## 7.1 COMPUTER



*Switch off all equipment before you connect the LCD projector to the computer, mouse and video source as outlined in the following chapters. Then apply power first to the LCD projector, then to the computer and video source for correct operation.*

Connect the LCD projector, computer and monitor as shown in the rear foldout page (see *Connection Layout*).

The projector has three source input connectors. At power up, it will default to project the signal from source 1. The other two source-inputs are activated by using the remote control. You may connect three different sources simultaneously and select among them.

There are two V-split cables included (1,2). One uses 15-pin D-SUB connectors and is directly compatible with most PC's. It can also be used with certain workstations equipped with this type of connector. Adapters are available for this cable to use it with MAC, SUN and other workstations.

The other cable is intended for workstations using a monitor with BNC type connectors.

If you prefer not to use a monitor, there is no need to terminate the end of the cable.

### 7.1.1 PC

Connect the VGA/XGA V-Split cable (2) to the LCD projector, preferably using source 1. Disconnect the monitor cable from the back of your PC and reconnect it with the short lead of the V-split (2A). Connect the long lead of the V-split (2B) to the computer.

### 7.1.2 MAC

The projector is directly compatible with Macintosh computers that use the APPLE 15-pin D-SUB standard connector (variants with other connectors requires adapters from Apple). A set of two MAC adapters must be ordered separately and attached to the end of the PC compatible cable (See Adapters below).

### 7.1.3 WORKSTATIONS

Connect the BNC V-Split cable (1) to the LCD projector, preferably using source 1. Disconnect the monitor cable from the BNC inputs at the back of

your monitor and re-connect with the shortest lead of the V-split (1B). Connect the longest lead of the V-split (1A) to the monitor BNC inputs.

#### 7.1.4 ADAPTERS

If you have a computer that requires adapters to physically connect, insert applicable adapter(s) onto the V-split of the PC compatible cable (2A,2B) as described in the table on page 10.

#### APPLICABLE CABLES/ADAPTERS :

<b>COMPUTER</b>	<b>CABLE ADAPTER</b>
VGA	None
MACII and PowerMac	MAC (option)
SUN	13W3 (option)
HP	None <sup>(1)</sup>
IBM RS6000	None <sup>(1)</sup>
Power PC	13W3 (option)
Silicon Graphics	13W3 (option)
DEC	None
NCR	13W3 (option)

1) Use either the PC cable or the BNC cable (varies with different models).

#### TO SET UP FROM THE REMOTE CONTROL :

To assist you in setting up and fine tuning the projector, fill a large portion of your screen with a 50% grey pattern (alternating black and white pixels). Then make sure that the projector is set to direct (1:1) default mode before adjusting the frequency setting. This can be done by pressing the SCALE button on the remote control.

<b>STEP</b>	<b>OPERATION</b>
1	Press RESET for default settings
2	Adjust FREQUENCY until all vertical bands disappear
3	Adjust TUNE for a stable image
4	Press POSITION, then use cursor keys to position the image
5	Adjust CONTRAST and BRIGHTNESS as desired
6	Press SCALE to compress/expand the image if desired



## 7.2 MOUSE

See the rear foldout when setting up.

Connect the mouse-cable to the LCD projector (3). Connect the appropriate adapter (4) to the end of the mouse-cable, labelled "MA". Then connect the adapter to the appropriate computer mouse port.



*For the computer to recognise the mouse, connect all cables and power on the projector before the computer is booted.*

A Y-split is provided with the PC and optional MAC adapters that enables parallel use of the local computer mouse and the remote mouse. The local and remote mice should however not be operated simultaneously, as this may lead to unpredictable positioning of the mouse pointer.

The optional PS/2 adapter does not have a Y-split.

### APPLICABLE ADAPTERS:

<b>MOUSE</b>	<b>ADAPTER</b>	<b>DRIVER</b>
Microsoft 2 key compatible (9 pin serial port)	PC *)	Microsoft
PS/2 compatible mouse	PS/2	IBM PS/2
Macintosh ADB-bus mouse	MAC	Self detecting

\*) Please note that some computers using the Microsoft 2 key mouse may not allow the Y-split mouse adapter to work. A special straight PC adapter is available for this purpose.

**USING THE BATMOUSE:**

<b>STEP</b>	<b>OPERATION</b>
1	Control mouse pointer directly with the cursor keys
2	Press LEFT to activate (emulates the left mouse key)
3	Press DRAG to tag an object, move it using the cursor keys, then press DRAG again (or wait 5 seconds) to release the object (Drag-and-Drop).
4	Press RIGHT if your application requires emulation of the right mouse key.

The centre key of a three-key mouse is not supported.

If double-click does not work properly, try to adjust the double-click rate within the computer application in use. Do not double-click too fast. To activate the pull-down menus on a Macintosh computer, use the DRAG key instead of the left mouse key.

## 8 USING THE LCD PROJECTOR

The LCD projector has a set of connectors and controls that you need to know in order to operate the device correctly.

### 8.1 OPTICS

The projection lens is mounted in the front of the projector. The optical system is designed with a 8 degree keystone correction so that the projected image is shifted upwards on the wall. This in effect enables the placement of the projector on a flat table, still getting a rectangularly projected image above the projector on the wall.



*Avoid scratching and bumping the lens, as this will reduce the quality of the projected image. Always re-cap the lens when not in use!*

### 8.2 ILLUMINATION SYSTEM

The LCD projector uses a long life 575W metal halide lamp for illumination. When approaching the end of the expected life time for the lamp, a lamp timer will prompt for lamp change (see the *Lamp Replacement Messages* section). Each time the lamp is activated a message stating software revision and used lamp life hours will appear in the lower left hand corner of the screen.



*The lamp is under high pressure when in operation. NEVER attempt to open the unit for lamp change. Refer all servicing to authorized personnel only. See the Lamp Replacement section.*

### 8.3 REMOTE CONTROL

The infrared BatMouse™ remote control (RC) is the main user interface to the projector. The RC is used to set the LCD projector correctly (to get the best possible viewing conditions) and to control the presentation.

The figure shows the different keys on the remote control.

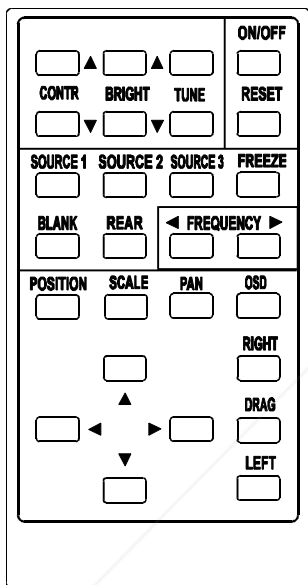

Set-up should be performed once with the application(s) and computer you are running most frequently. Allow some minutes for the equipment to warm up before adjusting. Most settings will automatically be memorized individually for each source for future use.

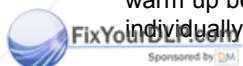

**Discount-Merchant.com (800) 281-8860**  
**THE TRUSTED SOURCE FOR PROJECTOR LAMPS AND ACCESSORIES**

The 'MEM' column in the tables below indicates whether the setting is memorized for each source. For a detailed overview, see the *Features* section.

#### BATMOUSE KEYS :

<b>CONTROL</b>	<b>FUNCTION</b>	<b>"MEM"</b>
CONTR	Contrast (ratio between light and dark colors)	YES
BRIGHT	Brightness (whiteness)	YES
TUNE	Adjusts the stability of the image	YES
ON/OFF	Turns the projected image on/off	-
RESET	Defaults to standard settings	-
SOURCE 1	Selects RGB input source 1 as active	NO
SOURCE 2	Selects RGB input source 2 as active	NO
SOURCE 3	Selects RGB input source 3 as active	NO
FREEZE	Holds the image displayed	NO
BLANK	Blanks the screen	NO
REAR	Mirrors the image for rear projection	YES
FREQ	Adjusts the video frequency	YES
POSITION	Controls the image positioning with cursor keys	YES
SCALE	Selects direct mapping (1:1) or scaling of image	NO
PAN	Allows panning within oversized images using cursor keys.	-
OSD	Toggles the OSD on and off	NO
CURSORS	The four cursor keys control the computer mouse	-
RIGHT	This key emulates the right mouse key	-
DRAG	This key emulates the drag function	-
LEFT	This key emulates the left mouse key and is also used to execute menu commands	-

## 8.4 CONTROL PANEL

The control panel keyboard consists of a subset of the remote control keys. For a detailed overview, please see the *Features* section.

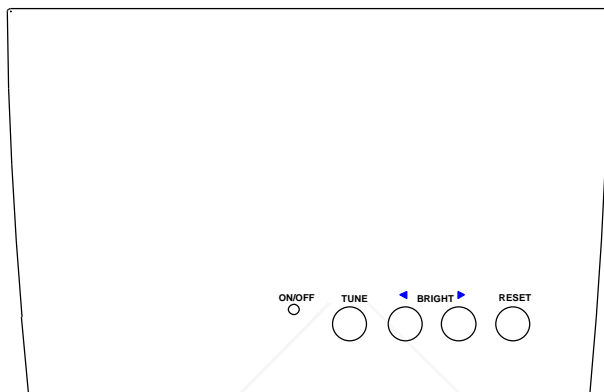

<b>CONTROL</b>	<b>FUNCTION</b>
TUNE	Adjusts the stability of the image
BRIGHT	Adjusts the brightness (whiteness) of the image
RESET	Defaults to factory settings
ON/OFF	Activity indicator
MASTER RESET	Press all 4-key simultaneously to activate the master reset

## 8.5 CONNECTORS

All connectors are positioned on the left hand side of the LCD projector (seen from the rear). See the technical data section for pinouts of the various connectors.

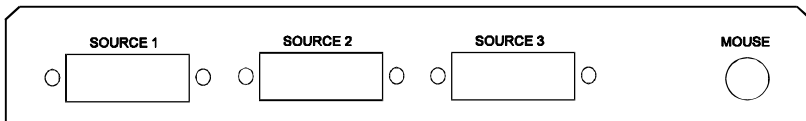

Do not connect any other devices with similar plugs to the connectors of the LCD projector, as this voids any warranty and may cause permanent damage to the device.

<b>CONNECTOR</b>	<b>FUNCTION</b>
SOURCE 1	Analog RGB input/output source 1
SOURCE 2	Analog RGB input/output source 2
SOURCE 3	Analog RGB input/output source 3
MOUSE	Universal mouse connector

## 9 FEATURES

The LCD projector has a variety of different features implemented. This chapter explains each feature in detail.

### 9.1.1 INTELLIGENT SAFECOOL SYSTEM

The fan operates as long as the LCD projector is switched on. Provided that the power cord is connected, the fan continues to run for 2 minutes even after the unit has been switched off. This ensures a continuous protection against high temperature inside the projector. The cooling system is designed to minimize stray light and noise. If the air flow is blocked, a temperature safety fuse will automatically shut off the projector to protect it from overheating.

### 9.1.2 SET-UP MEMORY

The user controlled set-up, that usually is done when the projector is connected to a new computer, is automatically memorized for future use. The set-up information is stored in a non-volatile memory approximately 15 seconds after the last key is pressed.

The memory can store 40 different sources/modes. Some sources are predefined, while the remaining are available for customer set-up. See the *Technical Data* section for compatibility.

Custom sources are added to the memory only if their sync pattern differs from any of the previous selections. The projector automatically selects a new memory location.

Most settings are stored individually for each mode, including contrast, brightness, tune etc. See the remote control table in the *Remote Control* section.

### OSD SYSTEM

The OSD (On Screen Display) system echoes on screen your keypad or remote control actions. The OSD may be switched off and on by pressing the OSD key on the remote control.



**Discount-Merchant.com (800) 281-8860**  
**THE TRUSTED SOURCE FOR PROJECTOR LAMPS AND ACCESSORIES**



### 9.1.3 CONTRAST

The contrast of an image is defined as the relation between dark and light colors. An image of high contrast is often regarded as 'hard', as compared to the 'soft' feeling of a low contrast image. Low contrast is recommended for long term viewing, while high contrast is used to enhance details. Use the CONTR keys on the remote control (RC) to adjust the contrast. Also see *Brightness*. The contrast setting is stored individually for each mode.

### 9.1.4 BRIGHTNESS

The brightness is the amount of white in an image. The brightness is adjusted to the ambient lighting conditions. Usually, a bright, low contrast image is preferred. Use the BRIGHT keys to adjust brightness. See also *Contrast*. The brightness setting is stored individually for each source.

### 9.1.5 TUNE

This feature enables a stable image. An unstable image can be seen as sideways instability or "swimming". Press TUNE until a stable image is achieved. The setting is stored individually for each source. Observe that TUNE only works provided the FREQUENCY setting is correct.

### 9.1.6 ON/OFF

This switch controls the operation of the projector. When switched on, all functions are active. When switched off, the fan is still operating, but the image is turned off. If the unit is left off for more than 5 minutes, the lamp is also turned off and after another 2 minutes the fan terminates. The ON/OFF switch is a toggle key.



*After the lamp is turned off, the unit can only be turned on again after a safety delay of 60 seconds. If the projector is turned on during the safety delay period, the On/Off indicator will blink slowly until the 60 seconds have passed and the lamp is turned on.*

### 9.1.7 RESET

This feature enables standard settings of most controls. RESET will only reset the active mode.



*A fundamental master reset may be performed by pressing all four top panel keys simultaneously. All settings will return to factory defaults, so do not perform a master reset unless it is really required. This operation will also erase all custom sources and modes that have been memorized.*

### 9.1.8 SOURCE 1/2/3

These keys select between the 3 analog RGB inputs. Only one input can be active at a time. All three inputs have the same properties and can be used for either computer/workstation or RGB video sources.

The Projector defaults to input source 1 at power on. If no signal is connected, the message NO SOURCE appears on the screen.

### 9.1.9 FREEZE

Press the FREEZE button on the RC to lock the image displayed. This feature is useful if you want to make changes locally on your computer that should not be presented to the audience. Press FREEZE once more to resume on-line operation. Any other key pressed will also release FREEZE.

### 9.1.10 BLANK

Use the BLANK key on the RC, if you temporarily want to suspend the display of images. The BLANK key is a toggle function, and the screen goes blank when activated. Any key pressed will release BLANK.

### 9.1.11 REAR

The projector can be set to project a mirrored image for rear projection. Rear projection is used when only the actual image is displayed, without showing the projection equipment. A special transmissive screen is needed. A typical application is in exhibitions. REAR is a toggle function on the RC.

### 9.1.12 FREQUENCY

This setting is provided for adaptation to Workstations and special graphics adapters that are not recognized automatically by the projector. An incorrect frequency setting can be seen as an image too wide or too narrow, combined with vertical, unstable bands. To better see this effect, fill a large portion of your screen with a 50% grey pattern (alternating black and white pixels). Make sure that Expansion/Compression is deactivated i.e. your image is viewed in default 1:1 mode. This is done by pressing the SCALE key on the remote control. Press the FREQUENCY keys left or right to adjust the setting until all vertical banding disappears. The final setting is stored individually for each source.

### 9.1.13 POSITION

Due to minor variations in graphics adapters, the horizontal and vertical position may need adjustment. Press POSITION, then use the cursor keys to position the image. The position is stored individually for each mode.

### 9.1.14 SCALE

Scaling is applicable to images that have a lower or higher resolution than the 1024x768 active LCD area. Pressing SCALE toggles between direct mapping (1:1) and compression of oversized images (1280x1024 or 1152x900), or expansion of undersized images (640x480 or 800x600). Default power on setting for oversized images is to view the image in 1:1, undersized images are expanded.

### 9.1.15 PAN

Panning is only applicable with oversized images (1280x1024 and 1152x900) when displayed in 1:1 (not compressed, see SCALE). Press PAN, then use the cursor keys on the remote control to perform the actual panning.



*Observe that the mouse cannot be controlled from the remote while PAN is activated.*

The PAN function is automatically deselected after 5 seconds of no key activity.

### OSD

The OSD (On Screen Display) is switched on or off with this toggle key.

### 9.1.16 MOUSE

The BatMouse remote control (RC) employs a unique mouse functionality that enables full mouse control of your PC, PS/2 or Macintosh computer. By default, the cursor keys of the remote control emulate the mouse movement.

The LEFT and RIGHT keys emulate the left and right keys on a standard two-key mouse (for Macintosh, only the DRAG key is used).

The DRAG key is used to emulate the click-and-hold action. To move an object, position the mouse cursor, press DRAG to tag the object, position the object as desired using the cursor keys, then press DRAG again to release the object. DRAG is automatically released after 5 seconds of no key activity.



*The mouse control can only be used with computers that fully support PC, PS/2 or MAC ADB mouse - electrically and functionally.*

## 10 TROUBLE-SHOOTING

This is a check-list to help you pinpoint any problem. Check the symptoms carefully if you experience any problem. The cure may be at hand.



*Before you start toggle the OSD-button. If response on the screen this indicates that the LCD projector receives signals from the remote control.*

### **The projected image is completely white**

- Check the **BLANK** key on the remote control

### **The LCD projector does not work**

- Check if the fuse is broken
- Check if the mains cable is attached
- Check if the LED on the projector is blinking slowly. If so, the lamp will ignite after a 30 second warm-up period

### **The projected image is completely black**

- Check the **ON/OFF** switch
- Check if the lamp is igniting. It will take a few minutes for the lamp to reach full light output. The lamp might have to be replaced, refer all servicing to authorized personnel only. See **SERVICE**.
- The unit may be overheated due to blocked ventilation system. Wait until the unit has cooled down before resuming operation

### **The LCD image is too dark or too light**

- Check the **CONTRAST** and **BRIGHTNESS** settings
- Try the **RESET** key

### **Some colors are unstable or flickering**

- Try to adjust the **CONTRAST**, **BRIGHTNESS** or possibly **TUNE**

### **The whole LCD image appears unstable or misplaced**

- Try pressing **SCALE** to return to default mode
- Try to adjust the **FREQUENCY**, **TUNE** or **POSITION**
- Check that you run a resolution/refresh rate within specifications
- Alternatively, you are most probably connected to a non-standard computer or video card. See the **Features** section for frequency adjustment and positioning

**The cooling fan is not working**

- *Is the unit switched on?*
- *If the fan is defective, turn off the unit immediately. A return for repair is then necessary*

**The remote control is not working**

- *Check if the batteries need replacement*
- *Be sure to point at the projection screen or directly at the IR eye in the front of the LCD projector*
- *You may be too far away from the projector (max. distance 7 m/23 feet)*

**The mouse is not working**

- *Remember to connect the mouse cables before the computer is switched on*
- *Check if the mouse cable and adapter are properly connected*
- *Please check the mouse driver settings on the computer (see Mouse section)*

## 11 MAINTENANCE

From time to time, the housing and lens may be cleaned with a dampened, non-abrasive cloth, using a mild detergent (dish washing soap, etc.) to remove spots.

Always be careful with the lens surface and use the lens cap for added protection when the projector is not in use.

### 11.1 FUSE REPLACEMENT

The electrical fuse is located at the mains input, as an integral part of the connector and switch assembly. See the figure below.



*A defective fuse may indicate a permanent electrical failure. If a new fuse breaks immediately, please return the unit to your dealer for control.*

Release the fuse holder and replace the broken fuse with a new one. Make sure to use a fuse of correct rating, see *Technical Data* section. There is room for a spare fuse in the holder.

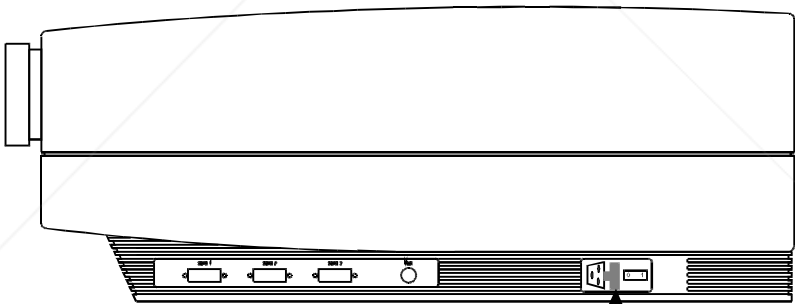

Fuse Holder

## 12 SERVICE



*This product contains no user serviceable parts, other than the projection lamp and the fuse. Attempts to modify other mechanics or electronics inside the housing will violate any warranties, and may be hazardous.*

If for any reason the product fails to work properly, first check the previous chapter on hints and tips. If things still do not work, please contact your dealer for technical support. Prepare a list of the symptoms you observe to make the diagnosing easier for your dealer. Remember to include all cables when returning the goods.

If a problem cannot be solved by the dealer, please see the *Service Information* section.

### 12.1 LAMP REPLACEMENT

The projector is using a 575W metal halide lamp for illumination. Recommended lamp type is Osram HMI 575 W/GS Dual Ended, which may be ordered from your local dealer or an Osram supplier. This lamp is HIGH PRESSURE when operating. Refer lamp change to qualified personnel only.



*The normal operating life for the lamp is 750 hours. High-pressure lamp may explode if improperly used. Refer all servicing to authorized personnel only.*

### 12.2 LAMP REPLACEMENT MESSAGES

When the time is due to replace the lamp, the projector will give you one of the two following messages on the screen.



WARNING!

Lamp has less than 50 hours left of recommended burning time

Please Change Lamp.

Press any key to clear this message...

The lamp has only 50 hours burning time left, and should be changed. Remember that you can check accumulated lamp usage each time the lamp is activated. A message appears in the lower left hand corner of the screen stating software revision and lamp hours used.

If you do not respond to the first message, a second message will appear when the lamp has exceeded recommended burning time. Please read Warnings and Notes in *Lamp Replacement* section carefully before proceeding with lamp change.

WARNING!

Lamp has exceeded its lamp life of 750 hours  
Continued use leads to a high risk of lamp explosion  
PLEASE CHANGE LAMP IMMEDIATELY ! ! !

If you replace the lamp and reset the lamp timer, the message below confirms that the operation has been successful.

INFO!

The lamp timer has been reset to 0  
Press any key to clear this message...

If the lamp timer is accidentally reset while operating a lamp which has not reached expected lifetime, or you change lamp before it is required and reset the timer, the warning below appears. This leaves you with two alternatives which are both described in the next paragraphs.

WARNING!

The lamp change indicator has been activated,  
though the lamp has not reached expected lifetime.

Press RESET to confirm lamp change,  
or press any other key to continue...

If you have changed the lamp on purpose before required, this message appears when you confirm by pressing RESET.

INFO!

The lamp timer has been reset to 0



If you did not intend to reset the lamp timer, this message confirms that you have corrected your mistake by pressing any other key to continue.

INFO!

The lamp timer has not been changed



**Discount-Merchant.com (800) 281-8860**  
**THE TRUSTED SOURCE FOR PROJECTOR LAMPS AND ACCESSORIES**

## 13 TECHNICAL DATA

The technical data may change without prior notice in order to improve the product performance.

The LCD projector is designed for indoor use and should not be operated outside the general environmental limits, as this may lead to permanent damage and violation of any warranties.

### GENERAL ENVIRONMENTAL LIMITS:

STORAGE TEMPERATURE	-20 ~ 60° C (-4° ~ 140° F)
STORAGE HUMIDITY	10 ~ 90 percent relative humidity, non condensing
OPERATING TEMPERATURE	10° ~ 30° C (50° to 86° F)
OPERATING HUMIDITY	20 ~ 80 percent relative humidity



*Allow for a slow acclimatization, after storing at extreme temperatures and humidities, to avoid condensation. Should condensation appear, leave the unit in a controlled environment within operating conditions, until the condensation has evaporated, before operating the unit.*

### 13.1.1 POWER SUPPLY

DUAL VOLTAGE	115 VAC 50 - 60 Hz 230 VAC 50 - 60 Hz
FUSE	115 VAC - 10A/250VAC 230 VAC - 10A/250VAC
CURRENT	115VAC - 9 A 230VAC - 5 A

**13.1.2 DISPLAY UNIT**

SIZE	322 x 245 x 638 12.7 x 9.6 x 25.1 inch
WEIGHT	12,5 kg 27,5 pounds
PROJECTION LENS	303 - 335 mm VARIOFOCUS
ANTI KEYSTONE	8 degrees
PROJECTION LAMP	575 W Dual Ended Metal Halide OSRAM 575W/GS
LCD CELL	Active matrix TFT stripe configuration
COLOR RESOLUTION	16.7 million
RESPONSE TIME	30 ms
CONTRAST RATIO	100:1
PIXEL RESOLUTION	1024 x 768 x 3 (RGB)
LCD DIAGONAL	10 "
MOUSE COMPATIBILITY	Microsoft two key compatible serial (9 pin) PS/2 compatible two key Macintosh ADB compatible one key
VIDEO FREQUENCY	14 ~ 140 MHz
HORIZONTAL SYNC	15 ~ 100 kHz
VERTICAL SYNC	56 ~ 100 Hz (VGA, S-VGA, XGA, S-XGA, Workstations) 50 ~ 60 Hz (VIDEO) 66 Hz/75 Hz (MACII)
RGB INPUT	0 ~ 1 Vpp
DEFECTIVE PIXELS	Maximum 25 (black, red, green or blue)

**13.1.3 REMOTE CONTROL**

Infrared wireless remote control.

BATTERIES	2 pcs LR03/AAA 1.5V penlight
RANGE	7 m 23 feet

### 13.1.4 COMPATIBILITY

The unit is compatible with the following interfaces. Some sources are predefined, but as different varieties of these exist (especially in workstations), a frequency adjustment may be needed.

<b>MODE</b>	<b>RESOLUTION</b>	<b>MAX VERTICAL FREQUENCY</b>
GENERIC	640x350	85 Hz
	640x400	85 Hz
	640x480	85 Hz
	720x480	85 Hz
	800x600	100 Hz
	1024x768	100 Hz
	1152x900	90 Hz
	1280x1024	80 Hz
VGA, MCGA	640 x 350	85 Hz
	640 x 400	85 Hz
	640 x 480	85 Hz
	720 x 400	85 Hz
SVGA	800 x 600	100 Hz
XGA	1024 x 768	100 Hz
MAC	640 x 480	85 Hz
	832 x 624	100 Hz
	1024 x 768	100 Hz
	1152 x 870	90 Hz
SUN	1024 x 768	100 Hz
	1152 x 900	90 Hz
HP	1024 x 768	100 Hz
	1280 x 1024	80 Hz
IBM RS6000	1024 x 768	100 Hz
	1280 x 1024	80 Hz
Silicon Graphics	1024 x 768	100 Hz
	1280 x 1024	80 Hz
DEC	1024 x 768	100 Hz
NCR	1024 x 768	100 Hz

## 14 CONNECTORS

The pinouts of all external connectors are described.

### 14.1.1 MOUSE

This connector is used for mouse control.

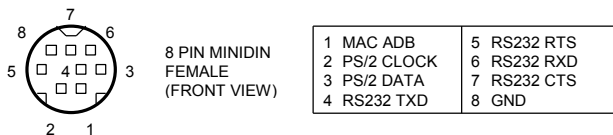

### 14.1.2 SOURCE 1/2/3

These connectors relay all sync and video signals from the computer to the projector and back again to the optional local CRT monitor.



1 ANALOG R IN	10 ANALOG R GND IN	19 HSYNC IN
2 ANALOG G IN	11 ANALOG G GND IN	20 C/VSYNC IN
3 ANALOG B IN	12 ANALOG B GND IN	21 DIGITAL GND
4 NOT USED	13 NOT USED	22 PCID0
5 NOT USED	14 NOT USED	23 PCID1
6 NOT USED	15 NOT USED	24 DIGITAL GND
7 ANALOG R OUT	16 ANALOG R GND OUT	25 HSYNC OUT
8 ANALOG G OUT	17 ANALOG G GND OUT	26 VSYNC OUT
9 ANALOG B OUT	18 ANALOG B GND OUT	

## 15 FCC STATEMENT

This equipment has been certified to comply with the limits for a Class A computing device, pursuant to Subpart J of Part 15 of FCC rules. Only peripherals (computer input/output devices, terminals, printers, etc.) certified to comply with the Class A limits may be attached to a computer that complies with Class A limits. When connecting to a peripheral device, a shielded input/output cable is required to ensure compliance with FCC rules. The shielded cable that must be used is supplied with the equipment. Operation with non-certified peripherals or non-shielded cables is likely to result in interference to radio and TV reception.

### 15.1.1 INSTRUCTIONS TO USER

This equipment generates and uses radio-frequency energy and, if not installed and used in accordance with the instruction manual, may cause interference to radio and television reception. It has been tested and found to comply with the limits for a Class A computing device in accordance with the specifications in Subpart J of Part 15 of the FCC rules, which are designed to provide reasonable protection against such interference when operated in a commercial environment. However, there is no guarantee that interference will not occur in a particular installation. If this equipment does cause interference to radio or television reception, which can be determined by turning the equipment off and on, the user is encouraged to try to correct the interference by one or more of the following measures :

***Reorient the receiving antenna.***

***Relocate the projector with respect to the receiver.***

***Plug the equipment to a different outlet so that equipment and receiver are on different branch circuits.***

***Fasten cables using mounting screws to ensure adequate EMI control.***

You may require the following booklet from the Federal Communications Commission (FCC) : "How to identify and resolve radio and TV interference problems", available from the U.S. Government Printing Office, Washington, DC 20402, Stock No. 004-000-00345-4.

## 16 ENVIRONMENTAL STATEMENT

This product is manufactured to minimize the stress and pollution of the surroundings. Where possible, recyclable materials are used.

<b>ITEM</b>	<b>RECYCLING / HANDLING</b>
PACKAGING	Only recyclable materials are used
MECHANICS	Only recyclable plastics and metal are used. Metal parts are painted aluminium and steel.
ELECTRONICS	No CFC is used during manufacture. No components that require special handling are used.
LCD MODULE	The liquid does not contain toxic or cancer causing materials. No special ventilation is needed when handling a broken cell. Use gloves and wash your hands afterwards to avoid any irritation to skin. The module is largely made up of glass, so handle broken units carefully to avoid wounds.

## 17 SERVICE INFORMATION

In cases where a problem cannot be solved by your dealer, please call the number below to get assistance. Please have the part number, serial number and the name of the dealer where you purchased the unit, ready when you call.

Never return products directly to the manufacturer without first calling the Service Department to obtain an RMA number (Return Material Authorisation) as well as shipping instructions.

### ASK AS, Headquarter :

+ 47 69340155 (Norway)  
Fax : +47 69340632

### ASK LCD Inc. North and South American Office :

1-201-896-8888 (USA)  
Fax: 1-201-896-0012



*Do not return products without an RMA number. Units without this number will be returned to sender without processing.*



## 18 CONNECTION LAYOUT

The foldout shows how to connect the LCD projector to the different computer sources.

1. BNC V-Split Cable
  - 1A. BNC Cable - Monitor End
  - 1B. BNC Cable - Computer End
2. VGA/XGA V-Split Cable
  - 2A. VGA/XGA Cable - Monitor End
  - 2B. VGA/XGA Cable - Computer End
3. Mouse Cable
4. Mouse Adapter
5. Mouse



**Discount-Merchant.com (800) 281-8860**  
**THE TRUSTED SOURCE FOR PROJECTOR LAMPS AND ACCESSORIES**



# Disclaimer

This user manual is provided as a free service by FixYourDLP.com. FixYourDLP is in no way responsible for the content of this manual, nor do we guarantee its accuracy. FixYourDLP does not make any claim of copyright and all copyrights remain the property of their respective owners.

About FixYourDLP.com

FixYourDLP.com (<http://www.fixyourdlp.com>) is the World's #1 resource for media product news, reviews, do-it-yourself guides, and manuals.

Informational Blog: <http://www.fixyourdlp.com>

Video Guides: <http://www.fixyourdlp.com/guides>

User Forums: <http://www.fixyourdlp.com/forum>

FixYourDLP's Fight Against Counterfeit Lamps:

<http://www.fixyourdlp.com/counterfeits>

## Sponsors:

RecycleYourLamp.org – Free lamp recycling services for used lamps:

<http://www.recycleyourlamp.org>

Lamp Research - The trusted 3rd party lamp research company:

<http://www.lampresearch.com>

Discount-Merchant.com – The worlds largest lamp distributor:

<http://www.discount-merchant.com>



**FixYourDLP.com**

Sponsored by 