



# Disclaimer

This user manual is provided as a free service by FixYourDLP.com. FixYourDLP is in no way responsible for the content of this manual, nor do we guarantee its accuracy. FixYourDLP does not make any claim of copyright and all copyrights remain the property of their respective owners.

About FixYourDLP.com

FixYourDLP.com (<http://www.fixyourdlp.com>) is the World's #1 resource for media product news, reviews, do-it-yourself guides, and manuals.

Informational Blog: <http://www.fixyourdlp.com>

Video Guides: <http://www.fixyourdlp.com/guides>

User Forums: <http://www.fixyourdlp.com/forum>

FixYourDLP's Fight Against Counterfeit Lamps:

<http://www.fixyourdlp.com/counterfeits>

## Sponsors:

RecycleYourLamp.org – Free lamp recycling services for used lamps:

<http://www.recycleyourlamp.org>

Lamp Research - The trusted 3rd party lamp research company:

<http://www.lampresearch.com>

Discount-Merchant.com – The worlds largest lamp distributor:

<http://www.discount-merchant.com>



**FixYourDLP.com**

Sponsored by 

# CD-455m/555m



## USER'S GUIDE

**BOXLIGHT®**  
Presenting a Better Way

 **FixYourDLP.com**  
Sponsored by 

**Discount-Merchant.com** (800) 251-8860

**THE TRUSTED SOURCE FOR PROJECTOR LAMPS AND ACCESSORIES**

BOXLIGHT  
19332 Powder Hill Place  
Poulsbo WA 98370-7407 USA  
[www.boxlight.com](http://www.boxlight.com)  
U.S. and Canada: 800-762-5757  
International: 360-779-7901



**Discount-Merchant.com (800) 281-8860**

**THE TRUSTED SOURCE FOR PROJECTOR LAMPS AND ACCESSORIES**

Copyright © 2000 by Boxlight  
Poulsbo, Washington. All rights reserved.

---

### **FCC Warning**

This equipment has been tested and found to comply with the limits for a Class A digital device, pursuant to part 15 of the FCC Rules. These limits are designed to provide reasonable protection against harmful interference when the equipment is operated in a commercial environment. This equipment generates, uses, and can radiate radio frequency energy and, if not installed and used in accordance with the instruction manual, may cause harmful interference to radio communications. Operation of this equipment in a residential area is likely to cause harmful interference in which case the user will be required to correct the interference at his own expense.

### **Canada**

This Class A digital apparatus complies with Canadian ICES-003.  
Cet appareil numérique de la classe A est conforme à la norme NMB-003 du Canada.

### **Safety Certifications**

UL, CUL, TÜV, NOM

### **EN 55022 Warning**

This is a Class A product. In a domestic environment it may cause radio interference, in which case the user may be required to take adequate measures. The typical use is in a conference room, meeting room or auditorium.



**Discount-Merchant.com (800) 281-8860**  
**THE TRUSTED SOURCE FOR PROJECTOR LAMPS AND ACCESSORIES**

---

## **Declaration of Conformity**

Manufacturer: Boxlight

19332 Powder Hill Place, Poulsbo, Washington, USA

We declare under our sole responsibility that the CD-455m and CD-555m projectors conform to the following directives and norms:

Directive 89/336/EEC, Amended by 93/68/EEC

EMC: EN 55022 (1992) Class A

EN 55024 (1998)

Directive 73/23/EEC, Amended by 93/68/EEC

Safety: EN 60950: 1992 + A1 + A2 + A3 + A4: 1997

July, 2000

## **Trademarks**

Apple, Macintosh, and PowerBook are trademarks or registered trademarks of Apple Computer, Inc. IBM and PS/2 are trademarks or registered trademarks of International Business Machines, Inc. Microsoft, PowerPoint, and Windows are trademarks or registered trademarks of Microsoft Corporation. Digital Light Processing is a trademark or registered trademark of Texas Instruments.



**Discount-Merchant.com (800) 281-8860**  
**THE TRUSTED SOURCE FOR PROJECTOR LAMPS AND ACCESSORIES**



**Discount-Merchant.com (800) 281-8860**  
**THE TRUSTED SOURCE FOR PROJECTOR LAMPS AND ACCESSORIES**

---

## TABLE OF CONTENTS

<b>Safety Instructions</b>	<b>iii</b>
<b>Introduction</b>	<b>I</b>
Image Resolution	1
Compatibility	2
Unpacking the Projector	2
Usage Guidelines	4
If You Need Assistance	5
Warranty	5
<b>Setting up the Projector</b>	<b>7</b>
Connecting a Computer	9
Connecting a Video Player	11
Powering up the Projector and Adjusting the Image	13
Turning Off the Projector	14
<b>Using the Projector</b>	<b>15</b>
Basic Image Adjustment	15
Using the Remote Control	15
Adjusting the Projector	17
Using the Keypad and Remote Buttons	18
Using the On-Screen Menus	20
Display Menu	21
Audio Menu	23
Image Menu	24
Controls Menu	27
Language Menu	29
Status Menu	30
<b>Maintenance &amp; Troubleshooting</b>	<b>33</b>
Cleaning the Lens	33
Replacing the Projection Lamp	33
Replacing the Batteries in the Remote Control	36
Using the Security Lock	36
Troubleshooting	37



**Discount-Merchant.com (800) 281-8860**  
**THE TRUSTED SOURCE FOR PROJECTOR LAMPS AND ACCESSORIES**

<b>Appendix</b>	<b>41</b>
Specifications	41
Accessories	42
Portable and Laptop Activation Chart	44
Using Video Mirroring with a PowerBook Computer	49
Projected Image Size	50
<b>Index</b>	<b>51</b>



**Discount-Merchant.com (800) 281-8860**  
**THE TRUSTED SOURCE FOR PROJECTOR LAMPS AND ACCESSORIES**



---

## SAFETY INSTRUCTIONS

Please read and follow all safety instructions provided BEFORE using your new projector. Failure to comply with safety instructions may result in fire, electrical shock, or personal injury and may damage or impair protection provided by equipment. Please save all safety instructions.

### Safety Definitions:

- **Warning:** Statements identify conditions or practices that could result in personal injury.
- **Caution:** Statements identify conditions or practices that could result in damage to your equipment.

### Safety Symbols:



**Attention:** For information about usage of a feature, please refer to the User's Guide.



**Warning:** Hot surface. Do not touch.



An arrow pointing to the lamp door on the projector.

### Safety Terms:

- **Warning:** Don't look directly into the lens when the lamp is turned on.
  - **Warning:** To replace the lamp, turn the projector off by unplugging the power cord. To avoid burns, wait 30 minutes before opening the lamp door. Follow all instructions provided in this User's Guide.
  - **Warning:** Please use the power cord provided. Connect the power cord to a receptacle with a protective safety (earth) ground terminal.
- **Warning:** Refer all service to qualified service personnel. Servicing your own projector will void the warranty. See the following page for the customer service contact information.
- **Caution:** Don't block ventilation openings.



FixYourDLP.com  
Sponsored by DLP

Discount-Merchant.com (800) 281-8860  
THE TRUSTED SOURCE FOR PROJECTOR LAMPS AND ACCESSORIES

- **Caution:** Don't set liquids on the projector. Spilled liquids may damage your projector.
- **Caution:** Don't place the projector on a hot surface or in direct sunlight.
- **Caution:** Do not drop the projector. Transport the projector in a Boxlight-approved case; see page 43 for a list of cases.

**Important Operating Considerations**

Do not place the projector on a tablecloth or other soft covering that may block the vents. In the unlikely event of the bulb rupturing, thoroughly clean the area behind the projector and discard any edible items placed in that area.

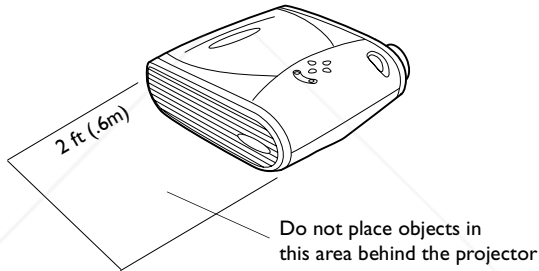

**Customer Service**

If you need assistance, call Boxlight at **1-800-762-5757** or **360-779-7901**.



**Discount-Merchant.com (800) 281-8860**  
**THE TRUSTED SOURCE FOR PROJECTOR LAMPS AND ACCESSORIES**

---

## INTRODUCTION

The Boxlight® CD-455m™ and CD-555m™ multimedia projectors are specifically designed for multipurpose use. They generate crisp, clear images using Digital Light Processing™ (DLP) technology, and feature an M1-DA connector for easy, built-in digital/analog and USB connectivity. They are easy to connect, easy to use, easy to transport, and easy to maintain. The CD-455m has native SVGA 800x600 resolution, the CD-555m has XGA 1024x768 resolution. The user interfaces of the two products are identical; information in this user's guide applies to both products.

### Image Resolution

#### CD-455m

The SVGA resolution of the CD-455m's projected image is 800x600. The projector cannot compress screen resolutions above 1024x768. If your computer's screen resolution is higher than 1024x768, reset it to a lower resolution before you connect the projector.

#### CD-555m

The XGA resolution of the CD-555m's projected image is 1024x768. The projector cannot compress screen resolutions above 1024x768. If your computer's screen resolution is higher than 1024x768, reset it to a lower resolution before you connect the projector.



**NOTE:** The CD-455m automatically expands 640x480 images to 800x600. You can display these images at their native resolutions by turning off the Auto Resize feature. See "Resize" on page 24 for more information.



**NOTE:** The CD-555m automatically expands 640x480 and 800x600 images to 1024x768. You can display these images at their native resolutions by turning off the Auto Resize feature. See "Resize" on page 24 for more information.



Discount-Merchant.com (800) 981-8860  
THE TRUSTED SOURCE FOR PROJECTOR LAMPS AND ACCESSORIES



**NOTE:** The projector is compatible with 1080i and 720p HDTV formats.

### Compatibility

The projector is compatible with a wide variety of computers and video devices, including:

- IBM-compatible computers, including laptops, up to 1024x768 resolution.
- Apple® Macintosh® and PowerBook® computers up to 1024x768 resolution.
- Most standard VCRs, DVD players, HDTV sources, camcorders and laser disc players.

### Unpacking the Projector

The projector comes with the items shown in Figure 1. Check to make sure all are included. **Contact Boxlight immediately if anything is missing.**

If you are experienced in setting up presentation systems, use the *Quick Start* card that was included in the shipping box. For complete details on connecting and operating the projector, refer to this User's Guide.



**Discount-Merchant.com (800) 281-8860**  
**THE TRUSTED SOURCE FOR PROJECTOR LAMPS AND ACCESSORIES**

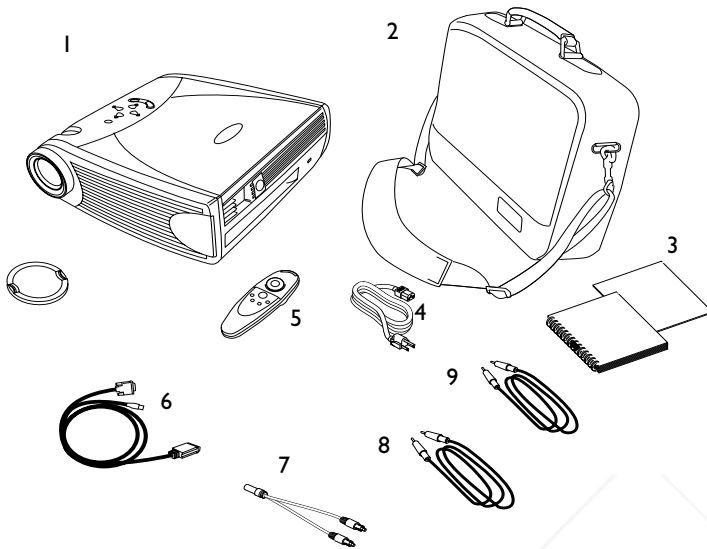

**FIGURE I**

*Shipping box contents*

- |  |                                |
|--|--------------------------------|
| 1. CD-455m or CD-555m projector + lens cap | 6. MI-DA analog computer cable |
| 2. Soft carry case                         | 7. Audio cable adapter         |
| 3. User's Guide and Quick Start card       | 8. Audio cable                 |
| 4. Power cord                              | 9. Composite video cable       |
| 5. Remote control                          |                                |

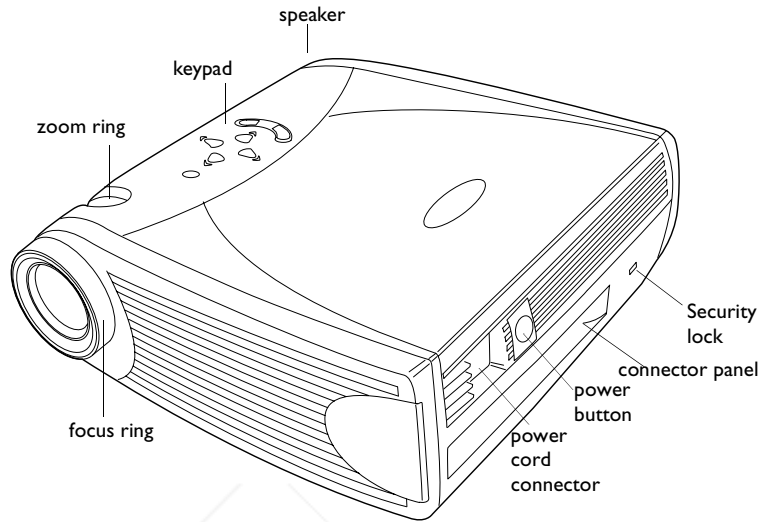

**FIGURE 2**

*Side view of projector*

**Usage Guidelines**

- Do not look directly into the projection lens when the lamp is turned on. The bright light may harm your eyes.
- Do not block the grills on the projector. Restricting the air flow can cause it to overheat and turn off. If this happens, you must wait a minute before attempting to turn it back on.
- Handle the projector as you would any product with glass components. Be especially careful not to drop it.
- Avoid leaving the projector in direct sunlight or extreme cold for extended periods of time. If this happens, allow it to reach room temperature before use.
- Transport the projector in a vendor-approved hard or soft case.



**Discount-Merchant.com (800) 281-8860**  
**THE TRUSTED SOURCE FOR PROJECTOR LAMPS AND ACCESSORIES**

---

### **If You Need Assistance**

The first place to look for help is in this manual. Be sure to check the guidelines in “Troubleshooting” on page 37.

If this manual doesn’t answer your question, call Boxlight at **1-800-762-5757** or **360-779-7901**.

### **Warranty**

This product is backed by a limited two-year warranty. The details of the warranty are printed at the back of this manual.



**Discount-Merchant.com (800) 281-8860**  
**THE TRUSTED SOURCE FOR PROJECTOR LAMPS AND ACCESSORIES**



**Discount-Merchant.com (800) 281-8860**  
**THE TRUSTED SOURCE FOR PROJECTOR LAMPS AND ACCESSORIES**



## SETTING UP THE PROJECTOR

- 1 Place the projector on a flat surface.
  - The projector must be within 10 feet (3 m) of your power source and within 6 feet (1.8 m) of your computer.
  - If you want to project from behind a translucent screen, set up the projector behind your screen. See “Rear Projection” on page 28 to reverse the image.
  - If you are installing the projector on the ceiling, refer to the installation guide that comes with the Ceiling Mount Kit for more information. To turn the image upside down, see “Ceiling Projection” on page 27. The Ceiling Mount Kit is sold separately, see “Optional Accessories” on page 43.
- 2 Position the projector the desired distance from the screen.
  - The distance from the lens of the projector to the screen and the zoom setting determine the size of the projected image. Figure 3 shows three projected image sizes. For more information about image size, see “Projected Image Size” on page 50.

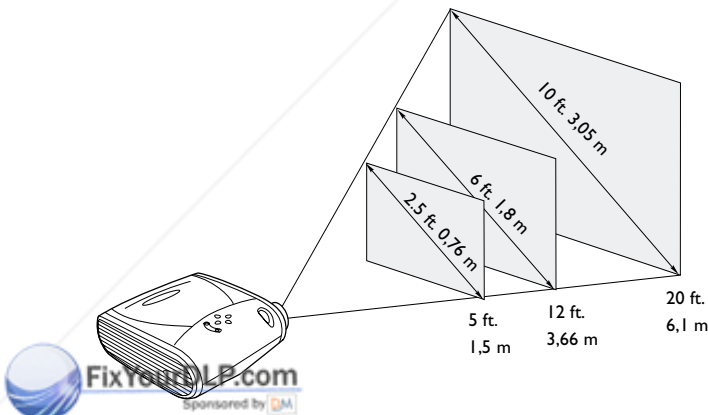

FIGURE 3

Projected image size at minimum zoom

Discount-Merchant.com (800) 281-8860  
THE TRUSTED SOURCE FOR PROJECTOR LAMPS AND ACCESSORIES

- 3 Make sure the projector and the computer are turned off.



**NOTE:** Before you continue, make sure the projector and all other equipment is turned off. If you're connecting a computer, make sure the distance between it and the projector is 6 feet or less.

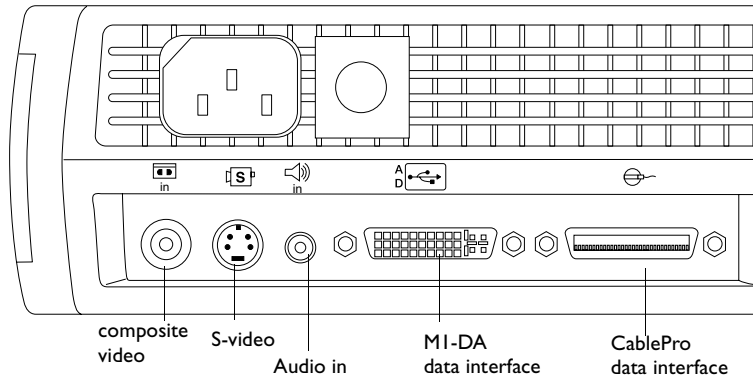
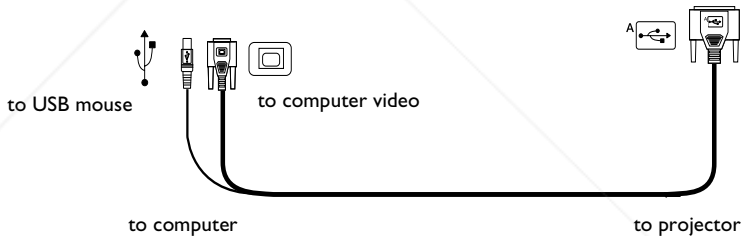

**FIGURE 4**

Connector panel



**NOTE:** The CablePro connector is used with the optional CablePro III, a connection hub containing mouse, audio, monitor and computer connectors. It is optimized for ceiling-mounted installations. See “Optional Accessories” on page 43.





**FIGURE 5**

MI-DA analog computer cable

## Connecting a Computer

The projector ships with an M1-DA analog computer cable. If your computer has a digital output, you can order the optional M1-DA digital computer cable. See “Optional Accessories” on page 43.

- 1 Plug the  end of the M1-DA analog computer cable into the  connector on the projector.
- 2 Plug the blue  end of the M1-DA analog computer cable into the video connector on your computer.

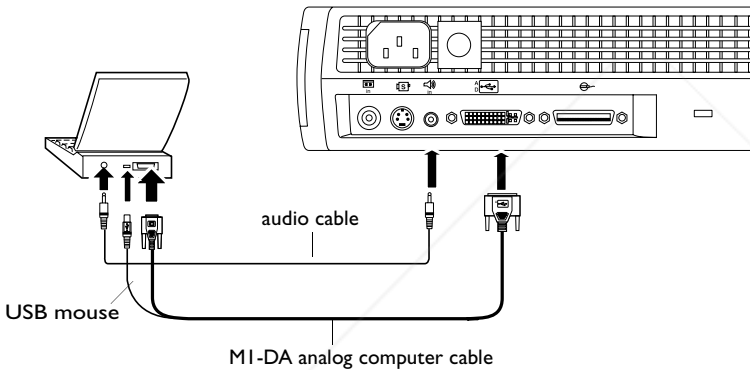

**FIGURE 6**

*Connecting the projector to a computer*



**NOTE:** Many laptop computers do not automatically turn on their external video port when a secondary display device such as a projector is connected. Refer to your computer manual for the command that activates the external video port. Activation commands for some laptop computers are listed in the Appendix of this manual on page 44 and in the Technical Support section of our website.



**NOTE:** If you are connecting an older Macintosh computer that does not have a 15-pin connector, you must use a Mac adaptor between the computer and the projector. See “Optional Accessories” on page 43.



**NOTE:** *The USB mouse is supported for use with Windows 98, Windows 2000, and Apple OS 8.5 and higher only.*



**NOTE:** *You do not need to restart your computer after connecting a USB mouse to use it (it is hot-pluggable).*

**Do you want to control the computer's mouse from the projector's remote or keypad?**



- 1 Plug the  end of the M1-DA analog computer cable into the USB mouse connector on your computer. If your computer has a PS/2 mouse connector and not a USB mouse connector, you can purchase the optional CablePro III which has a PS/2 mouse connector or the Executive Remote IR Receiver. See "Optional Accessories" on page 43.

**Do you want to play your computer's audio on the projector?**

- 1 Plug either end of the audio cable into the audio connector on your computer.
- 2 Plug the other end of the audio cable into the  connector on the projector.

Now you're ready to power up the projector and your laptop. Skip to "Powering up the Projector and Adjusting the Image" on page 13.

## Connecting a Video Player

- 1 If your video player uses a round, one-prong composite video connector, you'll need only the audio cable, audio adapter, and composite video cable that shipped with the projector.
  - If your video player uses a round, four-prong S-video connector, you'll need an S-video cable in addition to the audio cable and audio adapter. The S-video cable is sold separately. (See "Optional Accessories" on page 43.)
- 2 Plug the composite video cable's yellow connector into the "video-out" connector on your video player (Figure 7). This connector may be labeled "To Monitor."
- If you're using an S-video cable, connect it to the "S-video out" connector on the video player (Figure 8).
- 3 Plug the other yellow connector into the composite video connector  on the projector.
  - If you're using S-video, plug the other end of the cable into the "S-video" connector  on the projector (Figure 8).

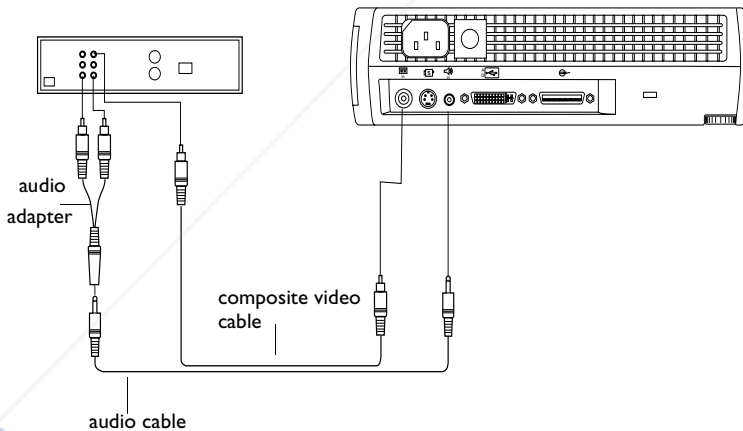

**NOTE:** HDTV sources must be connected to the projector using the MI-DA computer cable (not a composite or S-video cable). See the previous pages for details on connecting this cable.

FIGURE 7

Connecting the projector to a video player using the standard video cable (with composite video connector) and the audio cable and adapter

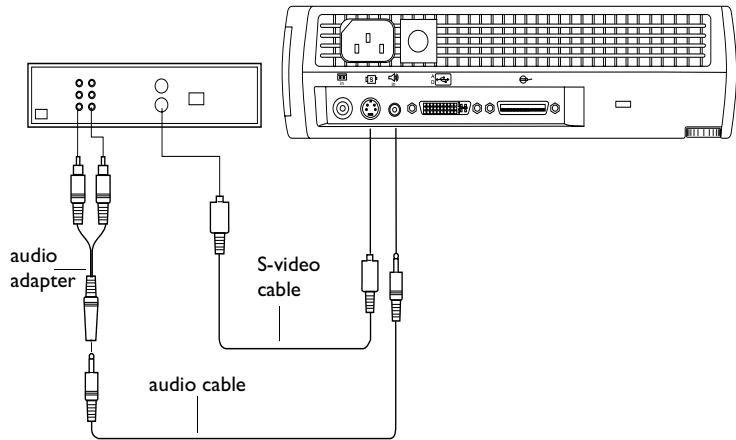

**FIGURE 8**

Connecting the projector to a video player using an S-video cable and the audio cable and adapter

- 4 Plug the audio adapter's white connector into the left "audio out" connector on your video player. Plug the adapter's red connector into the right "audio out" connector on the video player (Figure 7 and Figure 8).
- 5 Plug the audio adapter's other end into the audio cable.
- 6 Plug the audio cable into the "audio in"  connector on the projector.

The projector is compatible with these major broadcast video standards: NTSC, NTSC 4.43, PAL, PAL-M, PAL-N, PAL-60, and SECAM. It automatically adjusts to optimize its performance for the incoming video.



**NOTE:** The audio adapter is provided so that the same audio cable used to connect a computer can be used with the adapter to connect a VCR.



**CAUTION:** Your video player may also have a "Video Out" connector for a coaxial cable connection. DO NOT use this to connect to the projector.



FixYourDevice.com  
Sponsored by DM

**Discount-Merchant.com (800) 281-8860**  
**THE TRUSTED SOURCE FOR PROJECTOR LAMPS AND ACCESSORIES**

---

## Powering up the Projector and Adjusting the Image

- 1 Remove the lens cap.
- 2 Plug the power cord into the side of the projector, then plug it into your electrical outlet. A surge-protected power strip is recommended.
- 3 Press the Power button on the side of the projector.
  - The fans start to run, the LED on the top of the projector (Figure 12 on page 18) lights green, and the startup screen appears. It takes about one minute for the image to achieve full brightness.
- 4 If you connected a video player, turn it on.
  - The video image should display on the projection screen. If a computer source is active, press the **source** button on the keypad (page 18) or the **video** button on the remote to display your video image. You can select a default source to determine which source the projector examines first during power-up for active video; see “Default Source” on page 28.
  - Use the **volume** buttons to adjust the volume.
- 5 Turn on your computer.
  - The computer image should display on the projection screen. If a video source is active, press the **source** button on the keypad or the **computer** button on the remote to display your computer’s image. Make sure your laptop’s external video port is activated; see “Portable and Laptop Activation Chart” on page 44 for details.
  - If necessary, make adjustments to the image using the projector’s on-screen menus. To open the menus, press the **menu** button on the keypad or remote, then select the Display or Image menu. For more information about the menus, see page 20.



**NOTE:** Always use the power cord that shipped with the projector.



**NOTE:** The first time you connect your computer to the projector, the computer may display a message stating that new hardware was found. The Add New Hardware Wizard may appear. Use the Wizard to load the correct driver (the computer considers the projector a Plug and Play Monitor).



**NOTE:** With some computers, the order in which you power up the equipment is very important. Most computers should be turned on last, after all other peripherals have been turned on. Refer to your computer’s documentation to determine the correct order.

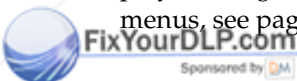

**Discount-Merchant.com (800) 281-8860**  
**THE TRUSTED SOURCE FOR PROJECTOR LAMPS AND ACCESSORIES**

### Turning Off the Projector

If you want to turn off the projector for a short period of time, press the **standby** button on the keypad or remote. This blanks the screen for fifteen minutes, but keeps the projector running. (You can change the amount of time the projector stays in standby mode; see “Standby Time” on page 27 for details.) After 15 minutes, the lamp goes out (the projector keeps running). To exit standby mode, press the **standby** button again. (It may take several seconds for the projection lamp to reach full power and project the image again.)

To completely power off the projector, press the Power button. If you want to turn the lamp back on immediately, you must allow about a minute for the lamp to cool. The lamp won't light if it's too hot.



**Discount-Merchant.com (800) 281-8860**  
**THE TRUSTED SOURCE FOR PROJECTOR LAMPS AND ACCESSORIES**



---

## USING THE PROJECTOR

This section describes how to use and make adjustments to the projector. It also provides a reference to the keypad and remote buttons and the options available from the on-screen menus.

### Basic Image Adjustment

- 1 Make sure you have powered up your equipment in the right order (page 13).
- 2 If the image doesn't display completely, zoom the image (page 17), adjust the height of the projector (page 17) or center the image by adjusting its horizontal or vertical position (page 26). Be sure the projector is at a 90 degree angle to the screen.
- 3 If the image is out of focus, rotate the focus lens (page 17).
- 4 If the image appears to shimmer or if it has blurry vertical bars after you have adjusted the focus, turn Auto Image (page 24) off and then back on to reset the automatic sync and tracking. If that doesn't clear up the image, turn Auto Image off and adjust the sync (page 25) and/or the tracking (page 25) manually.
- 5 If the colors don't look right, adjust the brightness (page 21).

### Using the Remote Control

To control the computer's mouse from the projector's remote or keypad, you must connect the USB mouse connector on the computer cable to the computer. See page 10 for details.

The projector ships with a remote that has four function buttons, a disk mouse and two mouse buttons, one on the top of the remote and one on the bottom.

Point the remote control at the projection screen or at the front of the projector (not at the computer). The range for optimum operation is about 25 feet. If you point the remote at the projection screen, the distance to the screen and back to the projector must be less than or equal to 25 feet. For best results, point the remote directly at the projector.

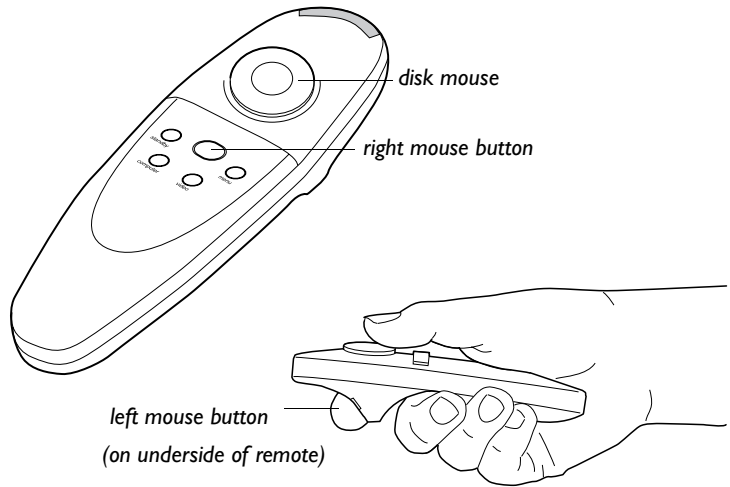

**FIGURE 9**

*Remote control*



**NOTE:** If the remote is inactive for several minutes, it “sleeps” to conserve battery life. Press any button except the disk mouse to re-activate the remote.

Press anywhere on the edge of the disk mouse to move the cursor on the screen. You can move the cursor at any angle by pressing the corresponding edge of the disk. The mouse button on the top of the remote simulates your computer’s right mouse button; the button on the bottom simulates your computer’s left mouse button. See “Using the Keypad and Remote Buttons” starting on page 18 for a description of the four function buttons.

If you are creating presentations in Microsoft® PowerPoint®, you can use the remote’s mouse buttons to navigate through your presentation while in Slide Show mode. To configure PowerPoint for this, choose Options from the Tools menu, click the View Tab, de-select the “Popup Menu on Right Mouse Click” option in the Slide Show section, then click OK. Then, when you’re in PowerPoint’s Slide Show mode, a left click advances to the next slide and a right click returns to the previous slide (other PowerPoint modes are not affected).



**Discount-Merchant.com (800) 281-8860**  
**THE TRUSTED SOURCE FOR PROJECTOR LAMPS AND ACCESSORIES**

## Adjusting the Projector

To focus the image, rotate the focus ring (Figure 10) until the image is clear. To zoom the image, rotate the zoom ring. This adjusts the image size without affecting focus.

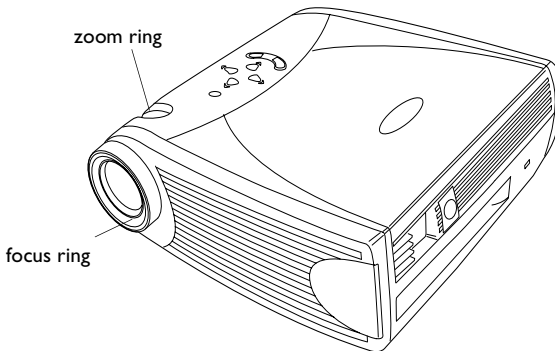

**FIGURE 10**

*Focus ring and zoom ring*

The projector is equipped with a self-locking, quick-release elevator foot and button and a leveling knob (Figure 11).

To raise the projector:

- 1 Press and hold the elevator button (Figure 11).
- 2 Raise the projector to the height you want, then release the button to lock the elevator foot into position. If necessary, turn the leveling knob at the rear of the projector to adjust the angle of the projected image.

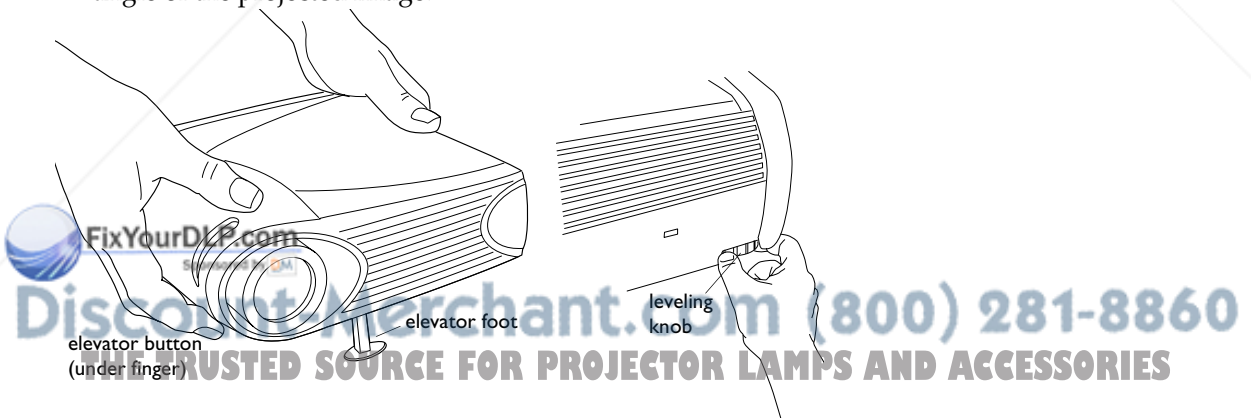
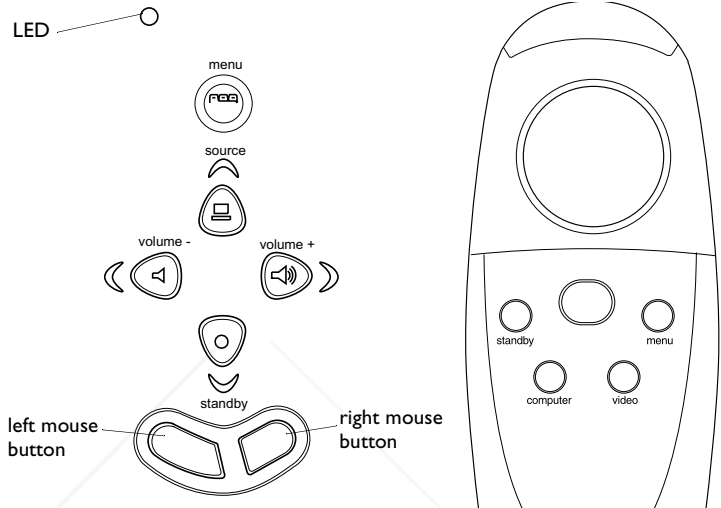

**FIGURE 11**

*Adjusting the height of the projector*

### Using the Keypad and Remote Buttons

While the menus are displayed, the volume, source, and standby buttons on the keypad act as menu navigation buttons. See “Using the On-Screen Menus” on page 20 for details.



**FIGURE 12**

*Keypad and remote buttons*

#### Menu

Press the **menu** button to open the on-screen menus. Press **menu** again to close the menus. When you close the menus, the projector saves any changes you made. For more information about the on-screen menus, see page 20.

#### Mouse buttons

Use the mouse buttons to adjust settings in the menus. See “Using the On-Screen Menus” on page 20.

#### Source (keypad only) or Computer and Video (remote only)

When you have more than one source (computer and video) connected to the projector, select between them by pressing the **source** button on the keypad or the **computer** or **video** button on the remote.



---

## Standby

When you press **standby**, the display and audio turn off and a blank screen is displayed for 15 minutes. You can change the amount of time the projector stays in standby mode; see “Standby Time” on page 27 for details. The LED lights orange while the projector is in standby.

- If you press **standby** again within 15 minutes, the projector returns to normal operations immediately. The LED changes from orange to green.
- If you press **standby** again after 15 minutes, there is about a 60 second delay before the lamp turns back on. The LED flashes green while the lamp is re-lighting.
- If you don't press **standby** again, the lamp turns off after 15 minutes. The LED lights orange while the projector is in standby.

## Volume (keypad only)

To increase the volume, press **volume +** . To decrease the volume, press **volume -** .

Volume adjustments are saved for each source you have connected.



**Discount-Merchant.com (800) 281-8860**  
**THE TRUSTED SOURCE FOR PROJECTOR LAMPS AND ACCESSORIES**



**NOTE:** Some menu items may be grayed out (dimmed) at certain times. This indicates the item is not applicable to your setup (for example, video standards do not apply to computer sources) or the item is not enabled until another selection is made (for example, Manual Tracking is not available until Auto Image is turned off).

### Using the On-Screen Menus

The projector has six drop-down menus that allow you to make image adjustments and change a variety of settings. Most of these adjustments aren't available directly from the keypad.

To open the on-screen menu, press the **menu** button on the keypad or remote. This changes the volume, source, and standby buttons on the keypad to menu navigation buttons. Press the corresponding buttons to move the cursor up, down, left, or right, or use the disk mouse on the remote. To select a menu, move the cursor left or right to highlight the menu you want. The drop-down menu appears.

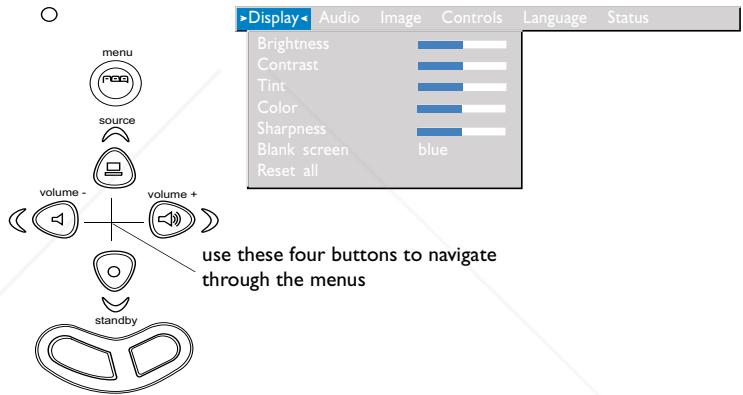

**FIGURE 13**

*Keypad navigation buttons and drop-down menu*

To change a menu setting, use the up and down navigation buttons on the keypad or the disk mouse on the remote to move the cursor up and down to the item you want to change (the selected item is highlighted), then use the left and right mouse buttons to adjust a setting. Some submenus, such as Brightness, consist of a slider bar you use to increase or decrease a value; some submenus, such as Standby Time, consist of options you scroll through to select the desired one. All changes are saved when you close the menu.

To access another menu, use the left and right navigation buttons to move to the desired menu.

---

## Display Menu

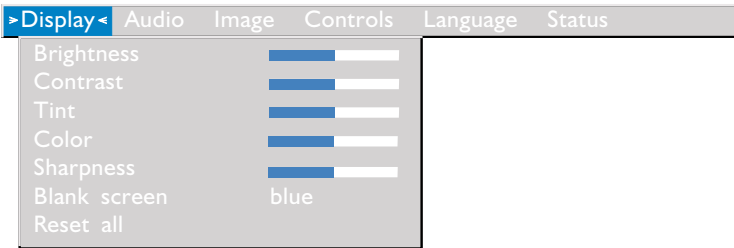

**FIGURE 14**

*Display menu*

### **Brightness**

Adjusting the brightness changes the intensity of the image.

- Press the left mouse button to darken the image.
- Press the right mouse button to lighten the image.

### **Contrast**

The contrast controls the degree of difference between the lightest and darkest parts of the picture. Adjusting the contrast changes the amount of black and white in the image.

- Press the left mouse button to decrease the contrast.
- Press the right mouse button to increase the contrast, making the blacks appear blacker and the whites appear whiter.

### **Tint**

The tint adjusts the red-green color balance in the projected image.

- Press the left mouse button to increase the amount of green in the image.

Press the right mouse button to increase the amount of red in the image.



FixYourDLP.com  
Sponsored by DM

**Discount-Merchant.com (800) 281-8860**  
**THE TRUSTED SOURCE FOR PROJECTOR LAMPS AND ACCESSORIES**

### **Color**

The color setting adjusts a video image from black and white to fully saturated color.

- Press the left mouse button to decrease the amount of color in the image.
- Press the right mouse button to increase the amount of color in the image.

### **Sharpness**

This setting adjusts the sharpness of a video image.

- Press the left mouse button to decrease the sharpness.
- Press the right mouse button to increase the sharpness.

### **Blank Screen**

Blank Screen determines what color is displayed when there is no active source and when the projector is in standby. Click the left or right mouse button to toggle between blue and black.

### **Reset All**

Click the left or right mouse button to reset all the options (except Language, Video Standard, Rear and Ceiling Projection, Plug and Play, and Standby Time) in all the menus to their original settings.



## Audio Menu

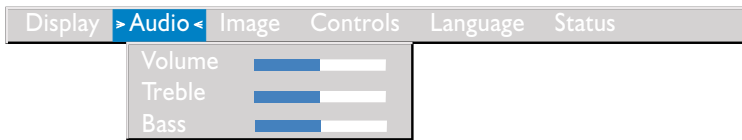

**FIGURE 15**

*Audio menu*

### Volume

- Press the left mouse button to decrease the volume.
- Press the right mouse button to increase the volume.

Volume adjustments you make are saved for each source.

### Treble

The treble setting controls the high frequencies of your audio source.

- Press the left mouse button to decrease the treble.
- Press the right mouse button to increase the treble.

Treble adjustments you make are saved for each source.

### Bass

The bass setting controls the low frequencies of your audio source.

- Press the left mouse button to decrease the bass.
- Press the right mouse button to increase the bass.

Bass adjustments you make are saved for each source.



**NOTE:** Changing the volume using the menu is the same as changing it using the keypad.

### Image Menu

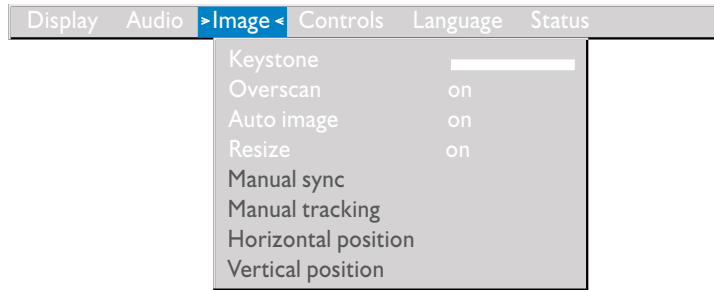

**FIGURE 16**

*Image menu*



**NOTE:** Some screen savers interfere with the operation of *Auto Image*. If you're experiencing problems, try turning your screen saver off, then turning *Auto Image* off and back on.



#### Keystone

This option helps to keep the image square as the angle of projection is changed. To adjust the keystone, highlight **Keystone**, then click the left or right mouse button. This option is available for computer sources displaying their native resolutions only, SVGA 800x600 for the CD-455m and XGA 1024x768 for the CD-555m.

#### Overscan

This option crops all the edges of the image to remove noise generated on the edges by your source. This option is available for video sources only.

#### Auto Image

The projector automatically adjusts tracking, signal synchronization and vertical and horizontal position for most analog computers (**Auto Image** does not apply to video sources or digital computer sources). If you want to adjust these features manually, you must turn off **Auto Image** first by highlighting **Auto Image** in the **Image** menu and clicking the left or right mouse button to select "off".

#### Resize

This option works differently for computer and video sources. For computer sources, **Resize** automatically resizes the image by scaling it up or down. It only affects computer images that are not the projector's native resolution. When **Resize** is on, the projector makes the best fit of the image to the computer screen. If you turn **Resize** off (by highlighting it in the **Image** menu and clicking the left or right mouse button to select "off"), the image may be either cropped or too small for the screen.



**NOTE:** When you connect an HDTV source, the projector automatically displays the image in 16x9 format.

---

For video sources, **Resize** allows you to select from among four different re-sizing options. The default is **Standard**, which resizes the image from its original version to fit a standard 4x3 aspect ratio screen. **Widescreen Letterbox** preserves the 16x9 aspect ratio of the original theater version, but the image is placed in a 4x3 space, so black bars appear at the top and bottom of the image. **Enhanced Widescreen** also preserves the aspect ratio of the original theater version and is designed to be used with content that is Enhanced for Widescreen TVs. This option yields more detail than Widescreen Letterbox. **Native** reduces the Standard size to match the height of Enhanced Widescreen.

### Manual Sync

The projector adjusts signal synchronization automatically for most computers. But if the projected computer image looks fuzzy or streaked, try turning **Auto Image** off then back on again. If the image still looks bad, try adjusting the signal synchronization manually:

- 1 Turn Auto Image off.
- 2 Highlight Manual sync, then press the left or right mouse button repeatedly until the image is sharp and free of streaks.

### Manual Tracking

The projector adjusts tracking automatically to match the video signal from your computer. However, if the display shows evenly spaced, fuzzy, vertical lines or if the projected image is too wide or too narrow for the screen, try turning **Auto Image** off then back on again. If the image is still bad, try adjusting the tracking manually:

- 1 Turn Auto Image off.
- 2 Highlight Manual tracking, then press the left or right mouse button repeatedly until the fuzzy vertical bars are gone.



**NOTE:** The **Manual Sync**, **Manual Tracking**, **Horiz. Position** and **Vert. Position** options are available only for analog computer sources. The projector sets these options automatically for digital computer and video sources.



Discount-Merchant.com (800) 281-8860  
THE TRUSTED SOURCE FOR PROJECTOR LAMPS AND ACCESSORIES

### **Horizontal position**

Follow these steps to manually adjust the horizontal position:

- 1 Turn Auto Image off.
- 2 Highlight Horizontal position, then press the left mouse button to move the image right or press the right mouse button to move the image left.

Positioning adjustments are saved when you power off the projector.

### **Vertical position**

Follow these steps to manually adjust the vertical position.

- 1 Turn Auto Image off.
- 2 Highlight Vertical position, then press the left mouse button to move the image down or press the right mouse button to move the image up.

Positioning adjustments are saved when you power off the projector.



**Discount-Merchant.com (800) 281-8860**  
**THE TRUSTED SOURCE FOR PROJECTOR LAMPS AND ACCESSORIES**

## Controls Menu

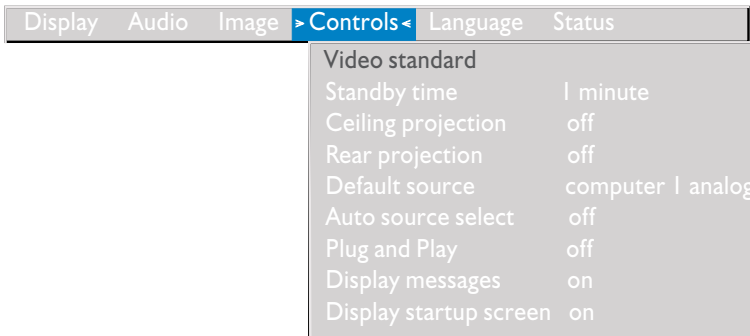

**FIGURE 17**

*Controls menu*

### Video Standard

When Video standard is set to Auto, the projector attempts to pick the video standard (NTSC, NTSC 4.43, PAL, PAL-M, PAL-N, PAL-60, or SECAM) automatically based on the input signal it receives. (The video standard options may vary depending on your region of the world.) If the projector is unable to detect the correct standard, the colors might not look right or the image might appear “torn.” If this happens, manually select a standard by clicking the left or right mouse button and cycling through the standards.

### Standby Time

This option lets you select how long the lamp stays on and the blank screen is displayed when the projector enters standby mode before the projector turns off. Select among instant, 1, 5, 10, 15 and 30 minutes and 1 and 2 hours by clicking the left or right mouse button and cycling through the options.

### Ceiling Projection

When you turn **Ceiling Projection** on, the projector turns the image upside down for ceiling-mounted projection. Highlight Ceiling Projection, then click the left or right mouse button to turn this feature on and off.



**NOTE:** If you already know the video standard used in your geographical area, it's often best to manually select it.

### **Rear Projection**

When you turn **Rear Projection** on, the projector reverses the image so you can project from behind a translucent screen. Highlight **Rear Projection**, then click the left or right mouse button to turn this feature on and off.

### **Default Source**

Default Source toggles among Computer 1 analog, Computer 1 digital, Computer 2, and Video. This determines which source the projector checks first for active video during power-up. Highlight **Default Source** and click the left or right mouse button to toggle among the options.

### **Auto Source Select**

This setting toggles between On and Off. When this feature is Off, the projector defaults to the source selected in **Default Source**. To display another source, you must manually select one by pressing the **source** button on the keypad or the **computer** or **video** button on the remote. When this feature is On, the projector automatically finds the active source, checking the default source first. Highlight **Auto Source Select** and click the left or right mouse button to turn this feature on and off.

### **Plug and Play**

This setting toggles between On and Off. When it is On, most new computers will automatically recognize the projector, then set the monitor resolution and refresh rate accordingly. You need to set the **Plug and Play** setting to Off for the projector to display properly on some older computers. The **Plug and Play** setting does not affect video images.

If the projector's display constantly changes between the computer image and the message, "Perfecting the image", you may need to turn **Plug and Play** Off.

### **Display Messages**

This setting toggles between On and Off. When this feature is On, status messages such as "No signal detected" or "Standby Active" appear in the lower-right corner of the screen. Click the left or right mouse button to turn this feature off and not see status messages.

---

### Display Startup Screen

This setting toggles between On and Off. When this feature is On, the startup screen appears when the projector starts up and remains until an active source is detected. The startup screen contains information on contacting Boxlight. Click the left or right mouse button to turn this feature off and display a plain black or blue screen instead of the startup screen.

### Language Menu

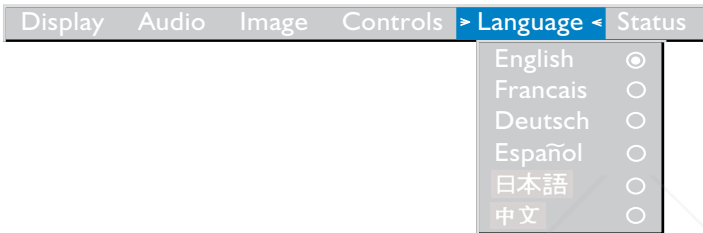

**FIGURE 18**

*Language menu*

You can display the on-screen menus in English, French, German, Spanish, Chinese or Japanese.

- Move the cursor to the language you want, then click the left or right mouse button. The menus redraw immediately.

### Status Menu

This is a read-only window for informational purposes. To display the status window, select Show status from the menu, then click the left or right mouse button. To remove the window, click the left or right mouse button.

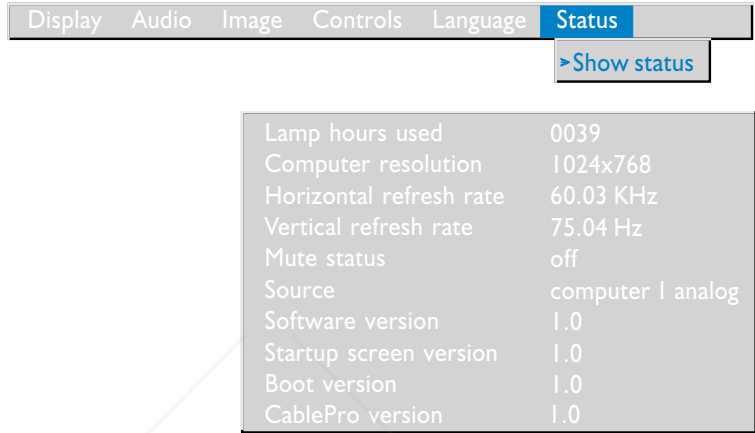

**FIGURE 19**

*Status menu*

### Lamp hours used

Indicates how many hours the current lamp has been in use. The counter starts at zero hours and counts each hour the lamp is in use. After 2,000 hours of use, the message “Change Lamp” temporarily appears on the screen when the projector is turned on. Change the lamp within the next 50 hours. After 2,050 hours, the LED flashes orange and the lamp will not light. See “Replacing the Projection Lamp” on page 33 for details.

### Computer resolution

Shows your computer’s resolution setting. To change this, go to your computer’s Control Panel and adjust the resolution in the Display tab. See your computer’s user’s guide for details.

### Horizontal refresh rate

The time period that one horizontal line is displayed.



---

**Vertical refresh rate**

The time period that one video frame is displayed.

**Mute status**

Indicates if the audio is muted.

**Source**

Indicates the active source, Computer 1 analog, Computer 1 digital, Computer 2, and Video.

**Software version**

Indicates the projector's software version. This information is useful when contacting Technical Support.

**Startup screen version**

Indicates the projector's startup screen version. This information is useful when contacting Technical Support.

**Boot version**

Indicates the projector's boot software version. This information is useful when contacting Technical Support.

**CablePro version**

Indicates the CablePro's software version. This information is useful when contacting Technical Support.



**Discount-Merchant.com (800) 281-8860**  
**THE TRUSTED SOURCE FOR PROJECTOR LAMPS AND ACCESSORIES**



**Discount-Merchant.com (800) 281-8860**  
**THE TRUSTED SOURCE FOR PROJECTOR LAMPS AND ACCESSORIES**

---

## MAINTENANCE & TROUBLESHOOTING

This section describes how to:

- clean the lens
- replace the projection lamp
- replace the batteries in the remote
- use the security lock feature
- troubleshoot the projector

### Cleaning the Lens

Follow these steps to clean the projection lens:

- 1 Apply a non-abrasive camera lens cleaner to a soft, dry cloth.
  - Avoid using an excessive amount of cleaner, and don't apply the cleaner directly to the lens.
  - Abrasive cleaners, solvents or other harsh chemicals might scratch the lens.
- 2 Lightly wipe the cleaning cloth over the lens in a circular motion.
- 3 If you don't intend to use the projector immediately, replace the lens cap.

### Replacing the Projection Lamp

The lamp hour counter in the Status menu counts the number of hours the lamp has been in use. After 2,000 hours of use, the message "Change Lamp" temporarily appears on the screen when the projector is turned on. Change the lamp within the next 50 hours. After 2,050 hours, the LED flashes orange and the lamp will not light. You can order new lamp modules from Boxlight. See "Accessories" on page 42 for information.

Follow these steps to replace the projection lamp:

- 1 Turn off the projector and unplug the power cord.
- 2 Wait 30 minutes to allow the projector to cool thoroughly.



**WARNING:** To avoid burns, allow the projector to cool for at least 30 minutes before you open the lamp module door. Never extract the lamp module while the projector is operating.



**WARNING:** Be extremely careful when removing the lamp module. In the unlikely event that the bulb ruptures, small glass fragments may be generated. The lamp module is designed to contain these fragments, but use caution when removing the lamp module.

- 3 Invert the projector on a soft flat surface, then insert a small screwdriver or other flat object into the tabs on the lamp module door (Figure 20) and gently pry the door up.

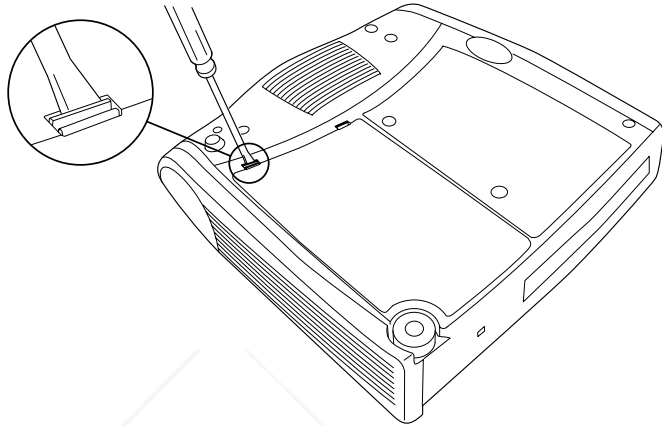
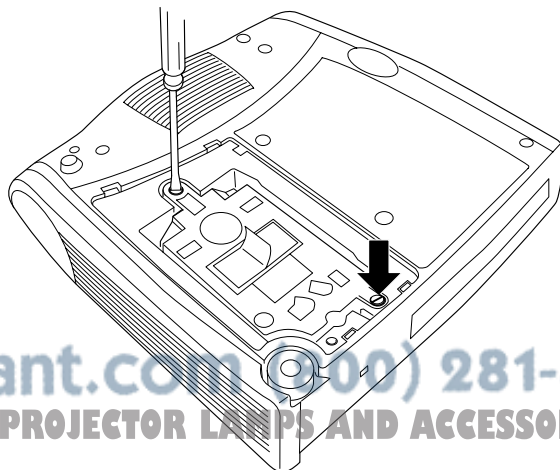

**FIGURE 20**  
Removing the lamp door



**CAUTION:** Never operate the projector with the lamp door open or removed. This disrupts the air flow and causes the projector to overheat.

- 4 Pull the lamp door up and remove it.
- 5 Loosen the two non-removable screws on the outside of the module (Figure 21).



**FIGURE 21**  
Loosening the screws on the lamp module

- 6 Lift and grasp the pull tab and lift the module out (Figure 22). Dispose of the lamp module in an environmentally proper manner.

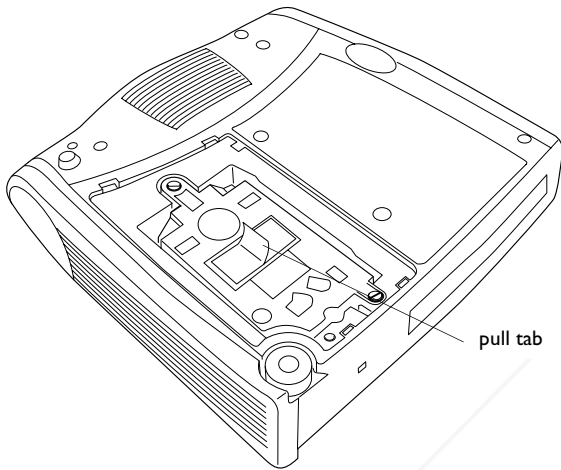

**FIGURE 22**

*Removing the lamp module*

- 7 Install the new lamp module, being sure to align the connectors properly.
- 8 Push the module in until it is flush with the bottom case of the projector.
- 9 Tighten the screws on the outside of the module.
- 10 Replace the lamp door by inserting the hooks on the lamp door into the slots on the projector and pressing the lamp door into place. If the lamp door does not fit properly or bulges out, remove the door and re-seat the lamp module.
- 11 Plug in the power cord and press the Power button to turn the projector back on.
- 12 To reset the lamp hour counter in the Status window, press and hold the **volume** - button, then press the **menu** button (while still holding down the **volume** - button) for 5 seconds. Verify that the counter was reset by pressing the **menu** button and viewing the counter in the Status window.



**WARNING:** Do not drop the lamp module or touch the glass bulb! The glass may shatter and cause injury.



Projector-Back.com

Sponsored by DM

Discount-Merchant.com (800) 281-8860  
THE TRUSTED SOURCE FOR PROJECTOR LAMPS AND ACCESSORIES

### Replacing the Batteries in the Remote Control

The life of the batteries depends on how often and how long you use the remote. Symptoms of low battery charge include erratic responses when using the remote and a reduced range of operation.

Follow these steps to replace the batteries:

- 1 Turn the remote face down in your hand.
- 2 Slide the battery cover off the end of the remote.
- 3 Remove the old batteries and dispose of them in an environmentally proper manner.
- 4 Install two new AAA alkaline batteries. Make sure you install each in the correct direction.
- 5 Slide the battery cover back on the remote.

### Using the Security Lock

The projector has a security connector for use with a PC Guardian Cable Lock System (Figure 23). See “Optional Accessories” on page 43 for ordering information. Refer to the information that came with the lock for instructions on how to use it to secure the projector.

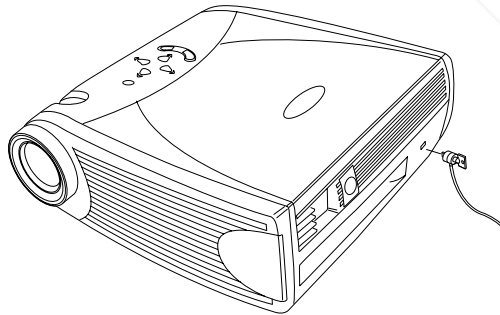

**FIGURE 23**

*Installing the security lock*

---

## Troubleshooting

### **Problem: The projector is not running**

- Make sure that the power cord is properly connected to a fully functional AC electrical outlet. Make sure that the power cord is also properly connected to the projector.
- If the projector is plugged into a power strip, make sure the power strip is turned on.
- Make sure the projector is turned on.

### **Problem: Projector is running, but nothing appears on projection screen**

- Make sure you have removed the lens cap on the projection lens at the front of the projector.
- Make sure the lamp has not been in use for over 2,050 hours. The lamp automatically shuts off at 2,050 hours and the LED blinks orange. See “Replacing the Projection Lamp” on page 33.
- Check the projector’s lamp to ensure that it is securely connected in the lamp module. See “Replacing the Projection Lamp” on page 33.

### **Problem: Only the start-up screen displays**

- Verify that the cables are connected correctly. See page 9 through page 10 for connection procedures.
- Make sure that the cables do not have any bent pins.
- Verify that the proper input source is connected. See “Source (keypad only) or Computer and Video (remote only)” on page 18.
- You might need to turn everything off and power up the equipment again in the proper order. Refer to your computer’s documentation to determine the correct order.
- Make sure your laptop’s external video port is turned on. See the “Portable and Laptop Activation Chart” on page 44 or your computer’s manual for details.

- Make sure your computer's video board is installed and configured correctly.
- Make sure your computer has a compatible video board. The projector isn't CGA, EGA or SXGA compatible.

If you're using Windows 98:

- 1 Open "My Computer" icon, the Control Panel folder and then the Display icon.
- 2 Click the Settings tab.
- 3 Verify that the Desktop area is set to 1024x768 or less.

**Problem: Color or text not being projected**

- You might need to adjust the brightness up or down until the text is visible. Refer to "Brightness" on page 21 for more information.

**Problem: The screen resolution is not right**

- Make sure the computer's video card is set for a resolution of no greater than 1024x768.

**Problem: Image isn't centered on the screen**

- Move the projector to reposition the image.
- Reposition the image using the menu. Refer to "Horizontal position" on page 26 and "Vertical position" on page 26.
- Be sure the projector is at a 90 degree angle to the screen.

**Problem: Image is too wide or narrow for screen**

- Adjust the zoom or projector placement.
- Adjust the resolution of your video card if it's greater than 1024x768.

**Problem: Image is out of focus**

- Turn the projection lens to focus the image.
- Make sure the projection screen is at least 5 feet (1.5 m) from the projector.
- Check the projection lens to see if it needs cleaning.



---

**Problem: Image and menus are reversed left to right**

- Rear projection mode is probably turned on. Turn Rear Projection off in the Controls menu. The image should immediately return to forward projection. See “Rear Projection” on page 28.

**Problem: the projector displays vertical lines, “bleeding” or spots**

- Adjust the brightness. See “Brightness” on page 21.
- Check the projection lens to see if it needs cleaning.

**Problem: no sound**

- Adjust volume.
- Verify audio/input connections.
- Adjust audio source.

**Problem: Image is “noisy” or streaked**

Try these steps in this order.

- 1 Deactivate the screen saver on your computer.
  - 2 Turn **Auto Image** off and then back on again. See “Auto Image” on page 24.
  - 3 Turn **Auto Image** off and adjust the synchronization and tracking manually to find an optimal setting. See “Manual Sync” on page 25 and “Manual Tracking” on page 25.
- The problem could be with your computer’s video card. If possible, connect a different computer.

**Problem: Projected colors don’t match the computer or video player’s colors**

- Just as there are differences in the displays of different monitors, there are often differences between the computer image and the projected image. Adjust the brightness, tint and/or contrast from the Display menu. See “Brightness” on page 21, “Tint” on page 21 and “Contrast” on page 21.

**Problem: Lamp seems to be getting dimmer**

- The lamp begins to lose brightness when it has been in use for a long time. Replace the lamp as described in “Replacing the Projection Lamp” on page 33.

**Problem: Lamp shuts off**

- A minor power surge may cause the lamp to shut off. Unplug the projector, wait at least a minute, then plug it back in.
- Make sure the vents are not blocked.
- Make sure the lamp has not been in use for over 2,050 hours. The lamp automatically shuts off at 2,050 hours. See “Replacing the Projection Lamp” on page 33.

Before calling Boxlight for assistance, please have the following information available:

- the projector’s serial number (located on the bottom label)
- the resolution of your computer.

Call Boxlight at **1-800-762-5757** or **360-779-7901**.



**Discount-Merchant.com (800) 281-8860**  
**THE TRUSTED SOURCE FOR PROJECTOR LAMPS AND ACCESSORIES**

---

## APPENDIX

### Specifications

The projector must be operated and stored within the temperature and humidity ranges specified.

#### Temperature

---

Operating	50 to 104° F (10 to 40° C)
Non-operating	-4 to 158° F (-20 to 70° C)

#### Humidity

---

Operating and non-oper.	10% to 95% relative humidity, non-condensing
-------------------------	--

#### Dimensions

---

3.9 x 10.9 x 11.2 inches (9.9 x 27.7 x 28.6 cm)

#### Weight

---

6.7 lbs. (3 kg) unpacked

#### Altitude

---

Operating	0 to 10,000 feet (3,048 meters)
Non-operating	0 to 20,000 feet (6,096 meters)

#### Optics

---

Focus Range	4.9 - 16 feet (1.5-5 m)
-------------	-------------------------

#### Lamp

---

Type	270-watt SHP lamp
------	-------------------

#### Input Power Requirements

---

100-120VAC 5A; 50/60Hz  
200-240VAC 3A; 50Hz



#### Audio Input

---

Input Impedance	10K ohm nominal, AC coupled
Maximum Input Voltage	$(L_{IN} + R_{IN})_{PEAK} < 4.5 V$ for THD $\leq 0.3\%$ $L_{IN}$ or $R_{IN} < 2.0 V_{rms}$ for THD $\leq 0.3\%$
Sensitivity	100 mV at 1 KHz for 88 dB SPL at 1 meter
Connector Type	3.5 mm (1/8 inch) stereo phone mini

## Accessories

### Standard Accessories (ship with the projector)

---

Quick Start card  
User's Guide  
Soft Case  
Shipping Box  
MI-DA Analog Computer Cable 6 ft (1.8 m)  
Composite Video Cable 6 ft (1.8 m)  
Computer Audio Cable 6 ft (1.8 m)  
Audio Adapter (RCA to 3.5mm)  
Executive Plus Remote  
Projection Lamp Module  
Lens Cap



**NOTE:** Use only Boxlight-approved accessories. Other products have not been tested with the projector.

### Power Cords (one ships with projector, type depends on country)

---

North American Power Cord  
Australian Power Cord  
UK Power Cord  
European Power Cord  
Danish Power Cord  
Swiss Power Cord



**Discount-Merchant.com (800) 281-8860**  
**THE TRUSTED SOURCE FOR PROJECTOR LAMPS AND ACCESSORIES**

---

## Optional Accessories



---

Deluxe Carry Case  
Shipping Case (ATA approved)  
Deluxe Travel Case  
MI-DA Digital Computer Cable  
Digital/Analog Interface Card  
Ceiling Mount Kit  
Ceiling Mount Plate  
CablePro II  
CablePro III  
CablePro Lite, 6.5 ft  
CablePro Extension Cable, non-plenum rated,  
60.7 ft  
CablePro Extension Cable, plenum-rated, 60.7 ft  
Macintosh Adaptor  
Full-Feature LaserPro Remote Control  
Wired LaserPro Cable  
GyroMouse RF Remote  
Two-button Executive Remote Control  
Executive Remote IR Receiver  
Remote Point RF Remote with LaserPointer  
PC Guardian Projector Cable Lock  
S-Video Cable  
40" Portable Projection Screen  
50" Portable Projection Screen  
60" Deluxe Insta-Theatre Screen  
80" Deluxe Insta-Theatre Screen  
Programming Cable



**Discount-Merchant.com (800) 281-8860**  
**THE TRUSTED SOURCE FOR PROJECTOR LAMPS AND ACCESSORIES**

### Portable and Laptop Activation Chart

Many laptop computers do not automatically turn on their external video port when a projector is connected. Activation commands for some laptop computers are listed in the following table. (If your computer is not listed or the given command does not work, refer to the computer's documentation for the appropriate command.) On many laptops, the activation function key is labeled with an icon, for example / or the text CRT/LCD.



**NOTE:** Usually, pressing the key commands once activates the external video port, pressing it again activates both the external and internal ports, and pressing it a third time activates the internal port. Refer to your computer's documentation for details on your specific model.

Computer	Key command to activate port	Key command to de-activate port
Acer	Ctrl-Alt-Esc (for setup)	Ctrl-Alt-Esc (for setup)
AST* **	FN-D or Ctrl-D Ctrl-FN-D FN-F5 type from A:/VGA/CRT FN-F12	FN-D or Ctrl-D Ctrl-FN-D FN-F5 type from A:/VGA/CRT FN-F12
AMS	FN-F2	FN-F2
AMT	setup screen	setup screen
AT&T	FN-F3 FN-F6	FN-F3 FN-F6
Advanced Logic Research	Ctrl-Alt-V	Ctrl-Alt-V
Altima	Shift-Ctrl-Alt-C setup VGA/ Conf.Simulscan	Shift-Ctrl-Alt-L setup VGA/ Conf.Simulscan
Ambra**	FN-F12 FN-F5 F2/Choose Option/F5	FN-F12 FN-F5 F2/Choose Option/F5
Amrel* **	setup menu Shift-Ctrl-D	setup menu Shift-Ctrl-D
Apple	see Mac Portable and Mac PowerBook	
Aspen	automatic	automatic
Award	FN-F6	FN-F6
BCC*	automatic	reboot computer

<b>Computer</b>	<b>Key command to activate port</b>	<b>Key command to de-activate port</b>
Bondwell	LCD or CRT options after bootup	reboot for LCD or CRT options to appear
Chaplet**	setup screen FN-F6 FN-F4	setup screen FN-F6 FN-F4
Chembook	FN-F6	FN-F6
Commax	Ctrl-Alt-#6	Ctrl-Alt-#5
Compaq* **	Ctrl-Alt-< FN-F4 automatic mode/? (for setup option)	Ctrl-Alt-> FN-F4 automatic mode/? (for setup option)
Compuadd* **	automatic Alt-F for screen setup option	automatic Alt-F for screen setup option
Data General	Ctrl-Alt-Command	Ctrl-Alt-Command
Data General Walkabout	2 CRT/X at DOS prompt	reboot
Datavue	Ctrl-Shift-M	Ctrl-Shift-M
DEC**	FN-F5 FN-F4	FN-F5 FN-F4
Dell**	Ctrl-Alt-< Ctrl-Alt-F10 FN-F8 (CRT/LCD) FN-D FN-F12	Ctrl-Alt-> Ctrl-Alt-F10 FN-F8 FN-D FN-F12
Digital*	automatic FN-F2	reboot FN-F2
Dolch	dip switch to CRT	dip switch to LCD
Epson	dip switch to CRT	dip switch to LCD
Everex*	setup screen option	setup screen option
For-A	Ctrl-Alt-Shift-C	Ctrl-Shift-Alt-L
Fujitsu	FN-F10	

Computer	Key command to activate port	Key command to de-activate port
Gateway	FN-F3 FN-F1/FN-F1 again simultaneous	FN-F3 FN-F1
Grid* **	FN-F2, choose auto or simultaneous Ctrl-Alt-Tab	FN-F2 Ctrl-Alt-Tab
Hitachi	FN-F7	FN-F7
Honeywell	FN-F10	FN-F10
Hyundai	setup screen option	setup screen option
IBM 970*	automatic	warm reboot
IBM ThinkPad**	reboot, enter setup menu FN-F7, select choice from setup menu FN-F1, select choice FN-F5, select choice PS/2 SC select choice (CRT, LCD, etc.)	FN-F2
Infotel	FN-F12	FN-F12
Kaypro	boot up, monitor plugged in	unplug monitor
Kris Tech	FN-F8	FN-F8
Leading Edge	FN-T	FN-T
Mac Portable 100	no video port: not compatible	
Mac PowerBook		
140, 145, 150, 170	no video port: requires a 3rd-party interface	
160, 165, 180, 520, 540, 5300	Control Panel folder; PowerBook Display folder; Activate Video Mirroring	warm reboot
210, 230, 250, 270, 280, 2300	requires Apple Docking Station or Mini Dock	
Magitronic	FN-F4	FN-F4
Mastersport	FN-F2	FN-F1



Discount-Merchant.com (800) 281-8860  
 THE TRUSTED SOURCE FOR PROJECTOR LAMPS AND ACCESSORIES



<b>Computer</b>	<b>Key command to activate port</b>	<b>Key command to de-activate port</b>
Micro Express*	automatic	warm reboot
Micron	FN-F2	FN-F2
Microslate*	automatic	warm reboot
Mitsubishi	SW2 On-Off-Off-Off	SW2 Off-On-On-On
NCR	setup screen option	setup screen option
NEC* **	setup screen option CRT at the DOS prompt FN-F3	setup screen option LCD at the DOS prompt FN-F3
Olivetti*	automatic FN-O/*	automatic FN-O/*
Packard Bell* **	FN-F0 Ctrl-Alt-<	FN-F0 Ctrl-Alt->
Panasonic	FN-F2	FN-F2
Prostar	Ctrl-Alt-S at bootup	Ctrl-Alt-S at bootup
Samsung*	setup screen option	setup screen option
Sanyo	setup screen option	setup screen option
Sharp	dip switch to CRT	dip switch to LCD
Sun SPARC-Dataview	Ctrl-Shift-M	Ctrl-Shift-M
Tandy**	Ctrl-Alt-Insert setup screen option	Ctrl-Alt-Insert setup screen option
Tangent	FN-F5	FN-F5
Texas Instruments*	setup screen option	setup screen option
Top-Link* **	setup screen option FN-F6	setup screen option FN-F6
Toshiba* **	Ctrl-Alt-End FN-End FN-F5	Ctrl-Alt-Home FN-Home FN-F5
Twinhead*	FN-F7 FN-F5 Automatic	FN-F7 FN-F5 Automatic
WinBook	Ctrl-Alt-F10	Ctrl-Alt-F10



FixYourDLP.com

Sponsored by DM

DiscountMerchant.com (800) 281-8860

THE TRUSTED SOURCE FOR PROJECTOR LAMPS AND ACCESSORIES

<b>Computer</b>	<b>Key command to activate port</b>	<b>Key command to de-activate port</b>
Wyse	software driven	software driven
Zenith**	FN-F10 FN-F2 FN-F1	FN-F10 FN-F2 FN-F1
Zeos**	Ctrl-Shift-D FN-F1	Ctrl-Shift-D FN-F1

\* These manufacturers have models that automatically send video to the external CRT port when some type of display device is attached.

\*\* These manufacturers offer more than one key command depending on the computer model.



**Discount-Merchant.com (800) 281-8860**  
**THE TRUSTED SOURCE FOR PROJECTOR LAMPS AND ACCESSORIES**

---

## Using Video Mirroring with a PowerBook Computer

When you turn video mirroring (called SimulScan in newer PowerBooks—see below) on, the projector displays the same information that appears on your PowerBook's built-in screen. When video mirroring is off, the projector acts like a separate display.

To turn on video mirroring for the first time:

- 1 Open the Monitors control panel; click on Monitor 2.
- 2 Set the number of colors you want.
- 3 Open the Control Strip, then click on the monitor icon.
- 4 Select "Turn Video Mirroring On."

Now you can turn video mirroring on and off from the Control Strip without having to open the Monitors control panel again.

When using video mirroring and high color graphics such as slide shows, the projected image occasionally might turn black and white. If this happens, perform the following steps:

- 1 Turn off video mirroring.
- 2 Open the Monitors control panel.
- 3 Move the white menu bar to Monitor 2 to set the projector as the primary monitor.
- 4 Restart the PowerBook.

## Using SimulScan

Some newer PowerBooks display images on an external monitor or projector differently than previous ones. When using SimulScan, the projector displays the same information that appears on your PowerBook

To select SimulScan:

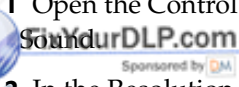
- 1 Open the Control Panel, then double-click Monitors and  Sponsored by DM
- 2 In the Resolution list, choose the SimulScan mode, then click OK.
- 3 If this changes your display settings, a dialog box appears. Click OK to confirm the change.

**Discount-Merchant.com (800) 281-8860**  
THE TRUSTED SOURCE FOR PROJECTOR LAMPS AND ACCESSORIES



### Projected Image Size

**NOTE:** Use the graph and tables to help you determine projected image sizes.

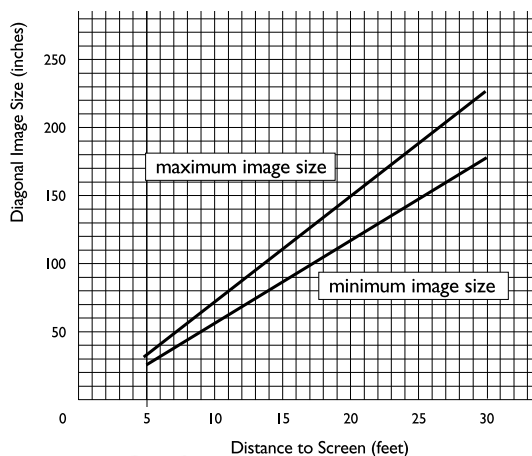

**FIGURE 24**

Projected image size

**Table 1:**  
Image Size, Width and Height-maximum image size

Distance to Screen (ft/m)	Diagonal (ft/m)	Width (ft/m)	Height (ft/m)
4.9/1.5	3.0/0.9	2.4/0.7	1.8/0.6
8.0/2.4	5.0/1.5	4.0/1.2	3.0/0.9
12.0/3.7	7.4/2.3	6.0/1.8	4.5/1.4
16.0/4.9	9.9/3.0	7.9/2.4	6.0/1.8
20.0/6.1	12.4/3.8	9.9/3.0	7.4/2.3
30/9.1	18.6/5.7	14.9/4.5	11.2/3.4

**Table 2:**  
Image Size, Width and Height-minimum image size

Distance to Screen (ft/m)	Diagonal (ft/m)	Width (ft/m)	Height (ft/m)
4.9/1.5	2.5/0.8	2.0/0.6	1.5/0.5
8.0/2.4	4.0/1.2	3.2/1.0	2.4/0.7
12.0/3.7	6.0/1.8	4.8/1.5	3.6/1.1
16.0/4.9	8.0/2.4	6.4/2.0	4.8/1.5
20.0/6.1	10.0/3.0	8.0/2.4	6.0/1.8
30/9.1	15.0/4.6	12.0/3.7	9.0/2.7



Discount-Merchants.com (800) 251-8860  
THE TRUSTED SOURCE FOR PROJECTOR LAMPS AND ACCESSORIES

## INDEX

### A

- accessories, ordering 42, 43
- activation commands for laptop computers 44
- adjusting
  - brightness 21
  - color 21
  - contrast 21
  - height of the projector 17
  - tint 21
  - volume 19, 23
- altitude limits 41
- assistance. See Technical Support
- audio adapter, connecting 12
- audio cable, connecting 10
- Audio menu 23
- Audio menu options
  - Bass 23
  - Treble 23
  - Volume 23
- Auto Source Select 28

### B

- bass 23
- Blank Screen 22
- brightness, adjusting 21
- buttons on keypad
  - Menu 18
  - Source 18
  - Standby 19
  - Volume 19

### C

- CD-455m/555m
  - cases 42
  - project from behind the screen
    - 27, 28
  - setting up 7
  - specifications 41
  - turning off 14
  - turning on 13
- CablePro 8
- CablePro Lite, ordering 43
- cables
  - audio 10
  - audio adapter 12
  - CablePro extension 43
  - composite video 11
  - extension 43
  - M1-DA analog computer cable 3,
    - 8, 9
  - ordering 42
  - power 42
  - S-video 11, 43
- CableWizard
  - extension cable 43
- cases, ordering 42
- ceiling-mounted projection 27, 43
- centering the image 17, 26
- cleaning the projection lens 33
- color, adjusting 21
- colors
  - don't match monitor colors 39
  - not displayed 38
- compatibility
  - IBM-compatible 2
  - Macintosh 2
- composite video cable
  - connecting 11
- computers
  - connecting 9
  - computers, compatible 2



**Discount-Merchant.com (800) 281-8860**  
**THE TRUSTED SOURCE FOR PROJECTOR LAMPS AND ACCESSORIES**

- connecting
  - audio adapter 12
  - audio cable 10
  - computers 9
  - power cord 13
  - remote 10
  - USB mouse 10
  - video player 11–12
- contrast, adjusting 21
- Controls menu 27
- Controls menu options
  - Auto Source Select 28
  - Ceiling Projection 27
  - Default Source 28
  - Display Messages 28
  - Display Startup Screen 29
  - Plug and Play 28
  - Rear Projection 28
  - Standby Time 27
  - Video Standard 27

**D**

- Default Source 28
- Display menu 21
- Display menu options
  - Blank Screen 22
  - Brightness 21
  - Color 21
  - Contrast 21
  - Reset All 22
  - Sharpness 22
  - Tint 21
- Display Messages 28
- Display Startup Screen 29
- displaying
  - on-screen menus 18
  - startup screen 29
  - status messages 28

**E**

- elevator button/foot 17
- extension cable 43

**F**

- focusing the image 17
- fuzzy lines 25

**H**

- HDTV 2, 11, 24
- height adjustment 17

**I**

- IBM-compatible computers
  - compatibility 2
- image
  - adjusting 13, 15
  - centering 26
  - colors don't match computer's 39
  - focusing 17
  - fuzzy lines 25
  - has lines or spots 39
  - not centered 38
  - not displayed 37
  - out of focus 38
  - quality 38–39
  - resolution 1
  - reversed 28, 39
  - size 7, 50
  - streaked 39
  - too wide or too narrow 38
  - zooming 17

- Image menu 24
- Image menu options
  - Auto Image 24
  - Horiz. Position 26
  - Keystone 24
  - Manual Sync 25
  - Manual Tracking 25
  - Overscan 24
  - Resize 24
  - Vert. Position 26

**K**

- keypad 18
- keystone correction 24



## L

- lamp
  - ordering 42
  - replacing 33
  - turns off unexpectedly 40
- lamp hour counter 30, 33, 35
- Language menu 29
- language, selecting for menus 29
- laptop computers
  - activation sequence to allow secondary display 44
  - compatibility 9
  - connecting 9
- LED 13, 18, 19, 30, 33
- lens
  - cap 42
  - cleaning 33
- leveling knob 17
- leveling the projector 17

## M

- M1-DA analog computer cable 3, 8, 9
- Macintosh computers
  - compatibility 2
  - connecting 9
- Menu button 20
- menus. See on-screen menus
- monitor, projected colors don't match 39
- mouse
  - buttons on keypad 18, 20
  - buttons on remote 15, 20
  - connecting USB 10

## N

- NTSC video 27

## O

- on-screen menus
  - Audio menu 23
  - changing language of 29
  - Controls menu 27
  - Display menu 21
  - displaying 20
  - Image menu 24
  - Language menu 29
  - making changes to menu functions 20
  - Status menu 30
- overscan 24

## P

- PAL video 27
- Plug and Play 28
- power cord
  - connecting 13
  - ordering 42
- power up sequence 13, 37
- PowerPoint slides, advancing with the remote 10, 16
- project from behind the screen 28

## R

- rear projection 28
- remote control
  - advancing PowerPoint slides with 10, 16
  - connecting 10
  - controlling the computer with 10, 15
  - replacing the batteries 36
  - using 15, 18
- replacing projection lamp module 33
- re-positioning the image on the screen 26
- resetting adjustments 22
- resetting the lamp hour counter 35
- resizing video 24
- resolution 1



## S

- safety guidelines iii
- SECAM video 27
- security lock 36, 43
- sharpness 22
- SimulScan, using with PowerBooks 49
- Source button 18
- specifications 41
- Standby button 19
- Standby Time 27
- startup screen 29
- Status menu 30
- S-video
  - connecting 11
  - ordering cable 43

## T

- Technical Support
  - information to have on hand before you call 40
- temperature limits 41
- test pattern 37
- text not visible 38
- tint, adjusting 21
- treble 23
- troubleshooting 37
- turning off the projector 14
- turning on the projector 13

## U

- USB mouse 10

## V

- vertical lines displayed 25, 39
- video mirroring on a PowerBook 49
- video resizing 24
- video standards 27
- Volume buttons 19
- volume, adjusting 19, 23

## W

- widescreen video 25

## Z

- zooming the image 17



---

## LIMITED WARRANTY

Boxlight ("Boxlight") warrants that each CD-455m and CD-555m ("the Product") sold hereunder will conform to and function in accordance with the written specifications of Boxlight. Said limited warranty shall apply only to the first person or entity that purchases the Product for personal or business use and not for the purpose of distribution or resale. Said warranty shall continue for a period of two (2) years from the date of such purchase. The standard limited warranty excludes the lamps in projectors after 120 days and the accessories after one year. Boxlight does not warrant that the Product will meet the specific requirements of the first person or entity that purchases the Product for personal or business use. Boxlight's liability for the breach of the foregoing limited warranty is limited to the repair or replacement of the Product or refund of the purchase price of the Product, at Boxlight's sole option. Replacement Product may be re-furbished in "like-new" condition, at Boxlight's sole discretion. To exercise the Purchaser's rights under the foregoing warranty, the Product must be returned at the Purchaser's sole cost and expense, to Boxlight or to any authorized Boxlight service center provided, and the Product must be accompanied by a written letter explaining the problem and which includes (i) proof of date of purchase; (ii) the dealer's name; and (iii) the model and serial number of the Product. When sending your unit in for repair, please ship your unit in its original packing material or a Boxlight approved ATA Shipping Case, or have a professional packaging company pack the unit. Please insure your shipment for its full value. A return authorization number, issued by the Boxlight customer service department, must also be clearly displayed on the outside of the shipping carton containing the Product.

## WARRANTY LIMITATION AND EXCLUSION

Boxlight shall have no further obligation under the foregoing limited warranty if the Product has been damaged due to abuse, misuse, neglect, accident, unusual physical or electrical stress, unauthorized modifications, tampering, alterations, or service other than by Boxlight or its authorized agents, causes other than from ordinary use or failure to properly use the Product in the application for which said Product is intended.

## DISCLAIMER OF UNSTATED WARRANTIES

THE WARRANTY PRINTED ABOVE IS THE ONLY WARRANTY APPLICABLE TO THIS PURCHASE. ALL OTHER WARRANTIES, EXPRESS OR IMPLIED, INCLUDING, BUT NOT LIMITED TO, THE IMPLIED WARRANTIES OF MERCHANTABILITY AND FITNESS FOR A PARTICULAR PURPOSE ARE DISCLAIMED. THERE ARE NO WARRANTIES THAT EXTEND BEYOND THE FACE HEREOF AND THE FOREGOING WARRANTY SHALL NOT BE EXTENDED, EITHER OR VARIED EXCEPT BY WRITTEN INSTRUMENT SIGNED BY BOXLIGHT. SOME STATES DO NOT ALLOW LIMITATIONS ON HOW LONG AN IMPLIED WARRANTY MAY LAST, SO SUCH LIMITATIONS MAY NOT APPLY TO YOU.

---

## LIMITATION OF LIABILITY

IT IS UNDERSTOOD AND AGREED THAT BOXLIGHT'S LIABILITY WHETHER IN CONTRACT, IN TORT, UNDER ANY WARRANTY, IN NEGLIGENCE OR OTHERWISE SHALL NOT EXCEED THE RETURN OF THE AMOUNT OF THE PURCHASE PRICE PAID BY PURCHASER AND UNDER NO CIRCUMSTANCES SHALL BOXLIGHT BE LIABLE FOR SPECIAL, INDIRECT, INCIDENTAL OR CONSEQUENTIAL DAMAGES OR LOST PROFITS, LOST REVENUES OR LOST SAVINGS. THE PRICE STATED FOR THE PRODUCT IS A CONSIDERATION IN LIMITING BOXLIGHT'S LIABILITY. NO ACTION, REGARDLESS OF FORM, ARISING OUT OF THE AGREEMENT TO PURCHASE THE PRODUCT MAY BE BROUGHT BY PURCHASER MORE THAN ONE YEAR AFTER THE CAUSE OF ACTION HAS ACCRUED. SOME STATES DO NOT ALLOW THE EXCLUSION OR LIMITATION OF INCIDENTAL OR CONSEQUENTIAL DAMAGES SO THE ABOVE LIMITATION OR EXCLUSION MAY NOT APPLY TO YOU. THIS LIMITED WARRANTY GIVES YOU SPECIFIC LEGAL RIGHTS, AND YOU MAY ALSO HAVE OTHER RIGHTS WHICH VARY FROM STATE TO STATE.



**Discount-Merchant.com (800) 281-8860**  
**THE TRUSTED SOURCE FOR PROJECTOR LAMPS AND ACCESSORIES**

Part Number 010-0246-00



# Disclaimer

This user manual is provided as a free service by FixYourDLP.com. FixYourDLP is in no way responsible for the content of this manual, nor do we guarantee its accuracy. FixYourDLP does not make any claim of copyright and all copyrights remain the property of their respective owners.

About FixYourDLP.com

FixYourDLP.com (<http://www.fixyourdpl.com>) is the World's #1 resource for media product news, reviews, do-it-yourself guides, and manuals.

Informational Blog: <http://www.fixyourdpl.com>

Video Guides: <http://www.fixyourdpl.com/guides>

User Forums: <http://www.fixyourdpl.com/forum>

FixYourDLP's Fight Against Counterfeit Lamps:

<http://www.fixyourdpl.com/counterfeits>

## Sponsors:

RecycleYourLamp.org – Free lamp recycling services for used lamps:

<http://www.recycleyourlamp.org>

Lamp Research - The trusted 3rd party lamp research company:

<http://www.lampresearch.com>

Discount-Merchant.com – The worlds largest lamp distributor:

<http://www.discount-merchant.com>



**FixYourDLP.com**

Sponsored by 