



# Disclaimer

This user manual is provided as a free service by FixYourDLP.com. FixYourDLP is in no way responsible for the content of this manual, nor do we guarantee its accuracy. FixYourDLP does not make any claim of copyright and all copyrights remain the property of their respective owners.

About FixYourDLP.com

FixYourDLP.com (<http://www.fixyourdpl.com>) is the World's #1 resource for media product news, reviews, do-it-yourself guides, and manuals.

Informational Blog: <http://www.fixyourdpl.com>

Video Guides: <http://www.fixyourdpl.com/guides>

User Forums: <http://www.fixyourdpl.com/forum>

FixYourDLP's Fight Against Counterfeit Lamps:

<http://www.fixyourdpl.com/counterfeits>

## Sponsors:

RecycleYourLamp.org – Free lamp recycling services for used lamps:

<http://www.recycleyourlamp.org>

Lamp Research - The trusted 3rd party lamp research company:

<http://www.lampresearch.com>

Discount-Merchant.com – The worlds largest lamp distributor:

<http://www.discount-merchant.com>



**FixYourDLP.com**

Sponsored by 

# DATA PROJECTOR XJ-360

## User's Guide

- Make sure you read all of the precautions in the printed "User's Guide (Basic Operations)" first. Also see the "User's Guide (Basic Operations)" for information about setting up the projector and replacing its lamp.
- Keep this manual in a safe place for future reference.

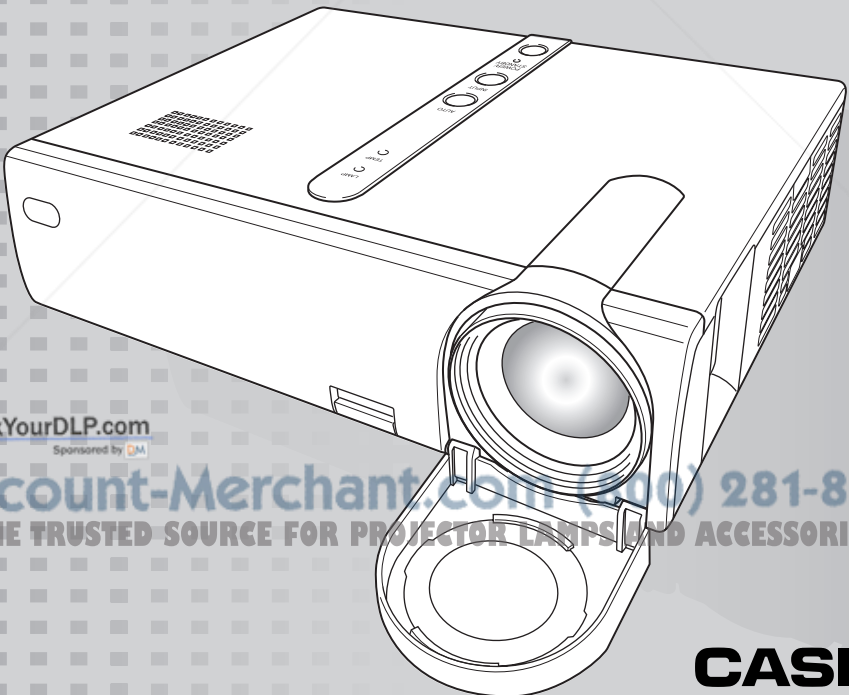

 FixYourDLP.com  
Sponsored by 

Discount-Merchant.com (800) 281-8860  
THE TRUSTED SOURCE FOR PROJECTOR LAMPS AND ACCESSORIES

**CASIO®**

- Digital Light Processing™, DLP™, Digital Micromirror Device™, and DMD™ are trademarks of Texas Instruments Incorporated of the United States.
- Microsoft, Windows, Windows NT, Windows XP, and the Windows logo are registered trademarks or trademarks of Microsoft Corporation of the United States in the United States and other countries.
- Apple and Macintosh are registered trademarks of Apple Computer, Inc. of the United States.
- Other company and product names may be registered trademarks or trademarks of their respective owners.

- The contents of this User's Guide are subject to change without notice.
- Copying of this manual, either in part or its entirety, is forbidden. You are allowed to use this manual for your own personal use. Any other use is forbidden without the permission of CASIO COMPUTER CO., LTD.
- CASIO COMPUTER CO., LTD. shall not be held liable for any lost profits or claims from third parties arising out of the use of this product or this manual.
- CASIO COMPUTER CO., LTD. shall not be held liable for any loss or lost profits due to loss of data caused by malfunction or maintenance of this product, or any other reason.
- The sample screens shown in this manual are for illustrative purposes only, and appear differently from the screens actually produced by the product.



**Discount-Merchant.com (800) 281-8860**  
**THE TRUSTED SOURCE FOR PROJECTOR LAMPS AND ACCESSORIES**

# Contents

<b>Projection Operations .....</b>	<b>4</b>
Projecting onto a Screen.....	4
Keystone Correction (KEYSTONE).....	8
Using Color Mode (COLOR MODE) .....	11
Adjusting the Volume Level (VOL +/-).....	12
Muting the Image and Audio (MUTE).....	12
Enlarging the Projected Image (D-ZOOM +/-).....	13
Freezing the Projected Image (FREEZE) .....	14
Displaying the Pointer .....	14
<b>Using the Setup Menu .....</b>	<b>16</b>
Setup Menu Overview.....	16
Setup Menu Screen Operations.....	19
Setup Menu Reference .....	27
Image Adjustment .....	27
Signal Settings .....	30
Screen Settings.....	31
Detailed Settings.....	35
Operational Info .....	46
<b>Appendix.....</b>	<b>48</b>
Remote Controller Signal Range .....	48
Projection Distance and Screen Size .....	49
Connecting to a Component Video Output Device .....	50
Full-screen Display of an RGB Image.....	51
Password Feature .....	52
Cleaning the Projector.....	53
Reattaching the Lens Cover.....	54
Projector Troubleshooting .....	56
Supported Signals.....	58



**Discount-Merchant.com (800) 281-8860**  
**THE TRUSTED SOURCE FOR PROJECTOR LAMPS AND ACCESSORIES**

# Projection Operations

## Projecting onto a Screen

This section explains the basic steps for projecting an image.

### Basic Flow

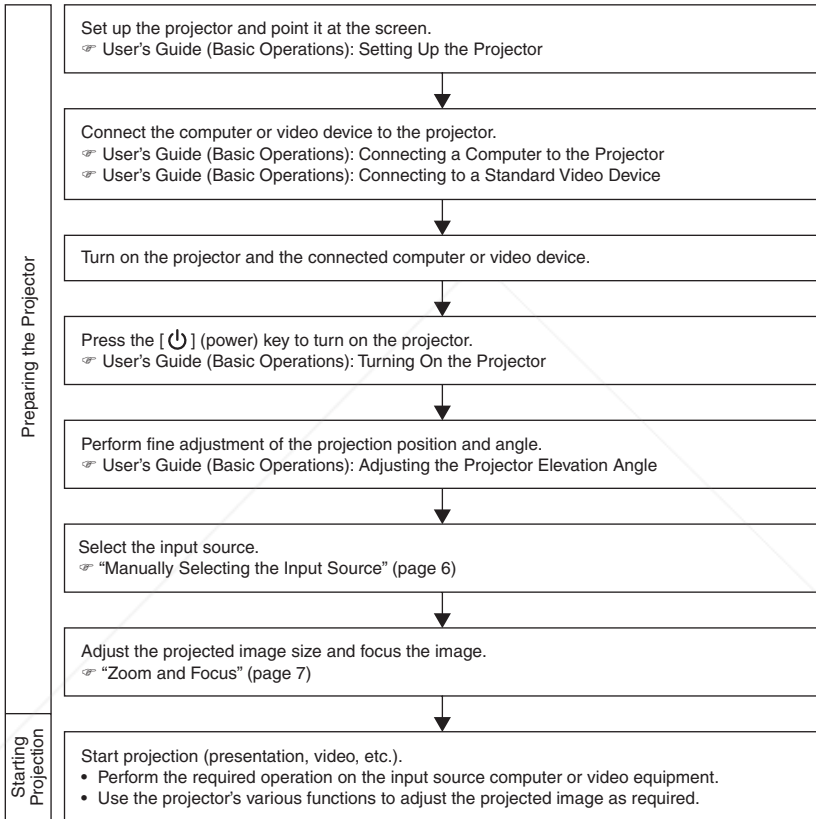

## Projection Operations

---

### Auto Input Source Selection

When you turn on the projector, it checks the status of each input source (whether or not the input source is sending a signal) in the sequence shown below. It automatically selects the first input source it finds that is sending an input signal, and projects the applicable image.

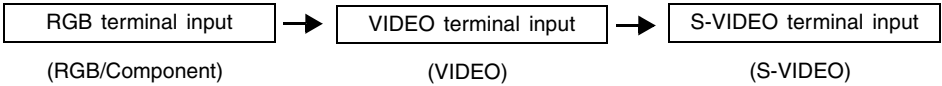

If the RGB input terminal is connected to a computer and the S-VIDEO input terminal is connected to a video deck and signals are being supplied by both, for example, the projector automatically selects RGB input when it is turned on. The currently selected input source name is shown in the upper right corner of the projection screen.

#### NOTE

- If the projector does not find any input signal, the message “No signal input” appears in place of the input source name.
- The input source that corresponds to input to the RGB input terminal is displayed in accordance with the “Detailed Settings → Advanced Settings 2 → RGB Input” (page 44) as shown below.

**When the setting is “Auto”:**

“RGB” is displayed when the input signal to the RGB input terminal is RGB, “Component” is displayed in the case of a component signal.

**When the setting is “RGB”:**

“RGB” is displayed.

**When the setting is “Component”:** “Component” is displayed.

- Note that the projector does not select the input source automatically when “Off” is selected for the “Detailed Settings → Advanced Settings 1 → Auto Input Detect” (page 40) on the setup menu.

## Projection Operations

### Manually Selecting the Input Source

The procedure you should use to select the input source depends on whether you are using projector keys or remote controller keys.

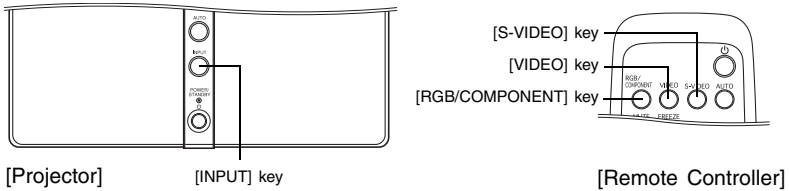

- To select the input source using projector keys, press the [INPUT] key on the projector to cycle through input sources in the sequence shown below.



- To select the input source using remote controller keys, press the [RGB/COMPONENT], [VIDEO], or [S-VIDEO] key on the remote controller to select the input source you want. The currently selected input source name is shown in the upper right corner of the projection screen.

#### NOTE

- If the currently selected input source is not sending an input signal, the message “No signal input” appears in place of the input source name.
- The input source name when RGB/Component is selected as the input source is displayed as “RGB” or “Component” in accordance with the “Detailed Settings → Advanced Settings 2 → RGB Input” on the setup menu (page 44). For more information, see the note under “Auto Input Source Selection” (page 5).

## Projection Operations

---

### Zoom and Focus

Use the zoom ring to adjust the image size, and the focus ring to focus the image.

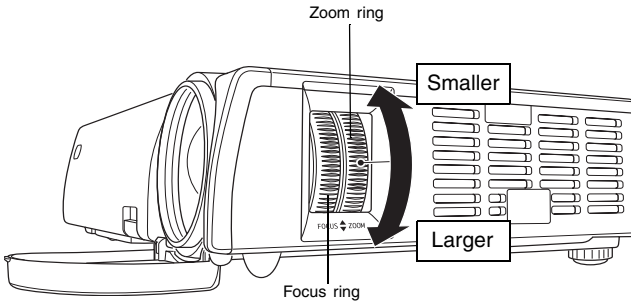

#### NOTE

- It is best to have a still image on the screen when you focus the image.
- Performing zoom after focusing can cause the image to go out of focus. If this happens, focus again.

### Auto Adjustment of an RGB Image

When the input source is RGB (computer), the projector automatically adjusts vertical and horizontal positioning, frequency, and phase whenever it detects an RGB signal (following input source selection, power up, etc.). You can also execute an automatic adjustment operation by pressing the [AUTO] key.

#### NOTE

- You can turn off auto adjustment (page 41) when you want to disable auto adjustment and maintain manual settings.
- The projected image may become distorted while an auto adjustment operation is in progress.
- If an image is unclear following the auto adjustment operation, you can use the menu to adjust items manually. For details, see “Signal Settings” on page 30.



### Keystone Correction (KEYSTONE)

When the projector is at an angle to the screen it is projecting on, the projected image may have different length top and bottom edges. This phenomenon is called, “keystoning”. This projector comes with functions for automatic as well as manual keystone correction, which provides a regularly shaped projected image. The following shows the allowable angle that the projector can be positioned relative to the screen.

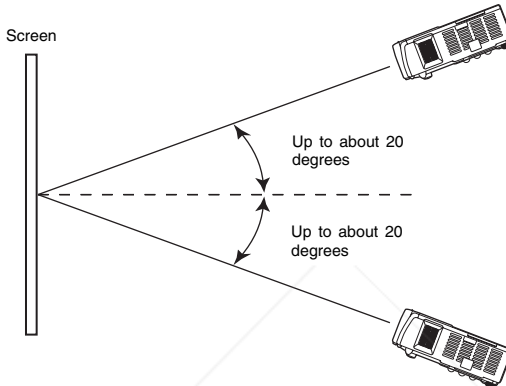

#### Important!

- The angles shown in the above illustration are subject to the following conditions.
  - Projection of an image from a computer (Resolution: 1024 × 768; Vertical Frequency: 60Hz)
  - Resize Image To Fit: On
- Actual correction ranges are affected by the type of signal being projected, zoom, the “Resize Image To Fit” setting, the aspect ratio setting, and other factors.
- Keystone correction can cause the corrected image to be smaller than the original (uncorrected) image, or it can cause distortion of the image. If the projected image becomes difficult to view, try moving the screen and/or projector so they are oriented close to the configuration shown under “Setting Up the Projector” in the “User’s Guide (Basic Operations)”.
- The projector does not support horizontal keystone correction. The center of the projector’s lens should be aligned with the horizontal center of the screen (see “Setting Up the Projector” in the “User’s Guide (Basic Operations)”).



FixYourDLP.com

Sponsored by 

**Discount-Merchant.com (800) 281-8860**  
**THE TRUSTED SOURCE FOR PROJECTOR LAMPS AND ACCESSORIES**

## Projection Operations

---

### Automatic Keystone Correction

Automatic keystone correction corrects the image to counteract the effects of vertical keystone. Performing auto keystone correction causes the message “Auto Keystone Corrected.” to appear in the bottom center of the projected image.

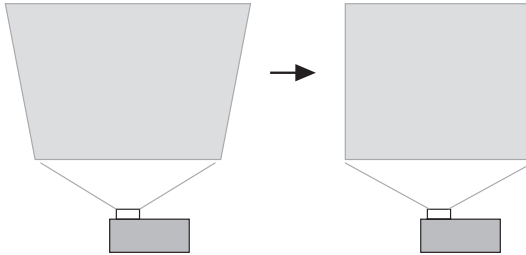

---

#### NOTE

- Auto keystone correction is performed by detecting the elevation angle of the projector. This means that the surface you are projecting onto needs to be standing straight up. If the surface you are projecting onto is not straight, use manual keystone correction to correct the image.
  - You can turn auto keystone correction on or off as required. For details, see “Detailed Settings → Advanced Settings 1 → Auto Keystone Correction” on page 40.
-

## Projection Operations

---

### Manual Keystone Correction

Manual keystone correction can be used to correct for vertical keystoneing.

#### To use manual keystone correction

1. Press the [KEYSTONE] key.
  - This causes the keystone correction screen to appear on the projected image.



2. Use the [◀] and [▶] keys to correct for keystoneing.
  - Each press of [◀] or [▶] shifts the indicator on the currently selected bar left or right.
  - Keystone correction is possible within the range that the indicator is able to move within the selected bar. Depending on conditions, the indicator may not move all the way to either end of the bar.



3. To close the setup screen, move the cursor to "Close", and then press the [ENTER] key.
  - You can also close the setup screen by pressing the [ESC] or [KEYSTONE] key.

### Using Color Mode (COLOR MODE)

The color mode setting lets you specify the type of image you will be projecting, so the projector can optimize image color.

#### To change the color mode setting

**1.** Press the [COLOR MODE] key.

- This causes the color mode screen to appear on the projection image. The ● mark indicates the current color mode setting.



- For details about each of the settings, see “Image Adjustment → Color Mode” on page 28.
- 2.** Use the [▲] and [▼] keys to move the cursor to the setting you want, and then press the [ENTER] key.
- This moves the ● to item that is selected by the cursor, and applies the setting to the image.
- 3.** To close the setup screen, move the cursor to “Close”, and then press the [ENTER] key.
- You can also close the setup screen by pressing the [ESC] or [COLOR MODE] key.

### Adjusting the Volume Level (VOL +/-)

You can use the remote controller keys to adjust the volume level of the audio that is output from the projector's speaker.

#### To adjust the volume level

1. On the remote controller, press the [VOL +] or [VOL -] key.
  - This causes the [Volume] screen to appear on the projected image.
2. Press the [VOL +] key or the [▶] key to increase the volume, or the [VOL -] or [◀] key to lower the volume.
3. To close the setup screen, move the cursor to "Close", and then press the [ENTER] key.
  - You can also close the setup screen by pressing the [ESC] key.

### Muting the Image and Audio (MUTE)

The mute function causes the projected image to go to black screen, and stop output of the audio from the speaker.

#### To mute the image and audio

1. On the remote controller, press the [MUTE] key.
  - This causes the projected image to go to a black screen, and stops output from the speaker.
2. To restore the image and audio, press the [MUTE] key again or press the [ESC] key.

### Enlarging the Projected Image (D-ZOOM +/-)

You can use the remote controller's zoom keys to enlarge a specific part of the projected image.

#### To enlarge part of the projected image

1. On the remote controller, press the [D-ZOOM +] or [D-ZOOM -] key.
  - This causes a cross cursor ( $\oplus$ ) to appear on the projected image.
2. Use the remote controller's cursor keys to move the cross cursor to the part of the image that you want in the center of the enlarged image.

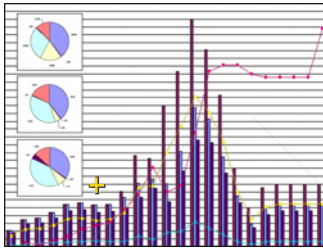

3. On the remote controller, press the [D-ZOOM +] key to enlarge the image.

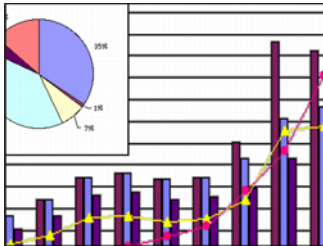

- Each press of the [D-ZOOM +] key enlarges the image one step. Pressing the [D-ZOOM +] key will not affect the image if it is already its maximum size.
- You can back step through the image enlargements by pressing the [D-ZOOM -] key.
- You can shift the zoomed image up, down, left, or right by pressing the applicable remote controller cursor key.

4. To exit image enlargement and return the image to its original size, press the remote controller's [ESC] key.

#### NOTE

- The [D-ZOOM] key can be used to zoom the projected image only when projecting an RGB signal.

## Projection Operations

---

### Freezing the Projected Image (FREEZE)

The freeze function stores the current projected image in projector memory, and projects it as a still image.

#### To freeze the projected image

1. On the remote controller, press the [FREEZE] key.
  - This freezes the image that was being projected when you pressed the [FREEZE] key.
2. To unfreeze the image, press the [FREEZE] key again or press the [ESC] key.

### Displaying the Pointer

Use the procedures in this section to display the pointer and to select its shape (arrow, bar). You can use the pointer to point to a specific location of the projected image during a presentation.

#### To display the pointer

Press the [POINTER/SELECT] key to display the pointer in the projected image.

The following operations can be performed while the pointer is displayed.

- Pressing the [STYLE] key (the [ENTER] key functions as the [STYLE] key while the pointer is displayed) rotates the pointer, causes it to blink, etc. If you are using an arrow pointer, for example, each press of the [STYLE] key cycles through four different pointer orientations.

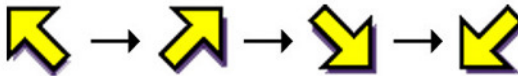

- The cursor keys can be used to move pointer around the image. Holding down a cursor key moves the pointer at high speed.

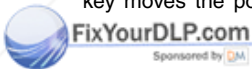

**Discount-Merchant.com (800) 281-8860**  
**THE TRUSTED SOURCE FOR PROJECTOR LAMPS AND ACCESSORIES**

## Projection Operations

---

### Selecting the Pointer Shape

Each press of the [POINTER/SELECT] key while the pointer is displayed cycles through the pointer shapes in the sequence shown below.

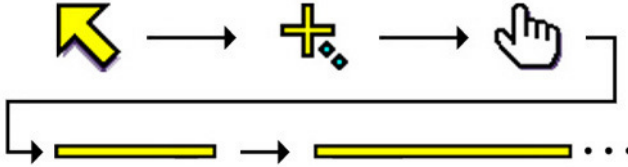

### To clear the pointer from the image

Press the [ESC] key.



# Using the Setup Menu

## Setup Menu Overview

Pressing the [MENU] key while an image is being projected displays the setup menu on the projected image. The setup menu can be used to configure a variety of different projector settings. The following table shows the menu items that are available in the Setup Menu.

Main menu	Sub-menu	Sub-menu Item Type *1	Input source *2					See page
			R	C	S	V	-	
Image Adjustment	Brightness	Value Setting	○	○	○	○	×	27
	Contrast	Value Setting	○	○	○	○	×	27
	Sharpness	Value Setting	○	○	○	○	×	27
	Saturation	Value Setting	×	○	○	○	×	27
	Tint	Value Setting	×	○	*3	*3	×	27
	Color Mode	Setting Screen	○	○	○	○	×	28
	Color Balance	Setting Screen	○	○	○	○	×	28
Signal Settings	Restore Menu Defaults	Execution	○	○	○	○	×	29
	Vertical Position	Value Setting	*5	×	×	×	×	30
	Horizontal Position	Value Setting	*5	×	×	×	×	30
	Frequency	Value Setting	*5	×	×	×	×	30
	Phase	Value Setting	*5	×	×	×	×	30
	Noise Filter	Selection	*5	×	×	×	×	31
	Restore Menu Defaults	Execution	*5	×	×	×	×	31
Screen Settings	Keystone Correction	Value Setting	○	○	○	○	○	31
	Aspect Ratio	Selection	×	*4	○	○	×	32
	Resize Image To Fit	Selection	○	×	×	×	×	33
	Projection Mode	Selection	○	○	○	○	○	34
	Ceiling Mount *11	Selection	○	○	○	○	○	34
Restore Menu Defaults	Execution	○	○	○	○	○	35	

\*1 This is the sub-menu item type. Refer to the pages noted below for more information.

**Value Setting:** Specifies a numeric value (☞ page 22).

**Selection:** Allows selection from multiple options (☞ page 22).

**Setting Screen:** Numeric value specification or option selection on a separate setting screen (☞ page 23).

**Execution:** Initializes a setting (☞ page 24).

**Information:** Displays information only (☞ page 24).

\*2 These columns indicate whether each item appears (○) or not (×) for each input source (R = RGB, C = Component, S = S-VIDEO, V = Video, - = No input signal).

\*3 This setting can be configured only for an NTSC or NTSC4.43 signal.

\*4 This setting can be selected only when the aspect ratio of the input signal is 4:3.

\*5 This setting or operation is available only when digital zoom is not being used.

## Using the Setup Menu

Main menu	Sub-menu	Sub-menu Item Type	Input source					See page
			R	C	S	V	–	
Detailed Settings	Volume	Value Setting	○	○	○	○	*6	35
	Pointer	Setting Screen	○	○	○	○	○	36
	Low-noise Mode	Selection	*12	*12	*12	*12	*12	36
	Power On Password	Special*11	○	○	○	○	○	37
	Change Password	Special*11	○	○	○	○	○	37
	Advanced Settings 1							
	Auto Input Detect	Selection	○	○	○	○	○	40
	Auto Keystone Correction	Selection	*13	*13	*13	*13	*13	40
	Auto Adjust	Selection	○	×	×	×	*7	41
	Show Screen Text	Selection	○	○	○	○	○	41
	Startup Screen	Selection	○	○	○	○	○	42
	No Signal Screen	Selection	○	○	○	○	○	42
	Advanced Settings 2							
	Auto Power Off	Selection	○	○	○	○	○	43
	RGB Input	Setting Screen	○	○	×	×	*8	44
	Video Signal	Setting Screen	×	×	×	○	*9	45
	S-Video Signal	Setting Screen	×	×	○	×	*10	45
	Image Enhancement 1	Selection	○	○	○	○	×	45
	Image Enhancement 2	Selection	○	○	○	○	×	45
	Language	Setting Screen	○	○	○	○	○	46
Restore Menu Defaults	Execution	○	○	○	○	○	46	
Operational Info	Lamp Time	Information	○	○	○	○	○	46
	Input Signal	Information	○	○	○	○	○	46
	Signal Name	Information	○	○	○	○	×	47
	Resolution	Information	○	×	×	×	×	47
	Horizontal Frequency	Information	○	○	○	○	×	47
	Vertical Frequency	Information	○	○	○	○	×	47
	Scan System	Information	○	○	×	×	×	47
	Restore All Defaults	Execution	○	○	○	○	○	47
	Reset Lamp Time	Execution	○	○	○	○	○	47

\*6 This setting is for the currently selected input source.

\*7 This setting can be configured only when the input source is RGB.

\*8 This setting can be configured only when the input source is RGB/Component.

\*9 This setting can be configured only when the input source is VIDEO.

\*10 This setting can be configured only when the input source is S-VIDEO.

\*11 This is a special sub-menu item that is different from other types.

\*12 The Low-noise Mode is available only when "Ceiling Mount" is turned off.

\*13 "On" is disabled when "Ceiling Mount" is turned on.

**THE TRUSTED SOURCE FOR PROJECTOR LAMPS AND ACCESSORIES**

## Using the Setup Menu

---

### Before Configuring Menu Settings

Always remember that the settings you configure on the setup menu are applied for the input source (RGB, Component, S-VIDEO, VIDEO) that was selected when you displayed the setup menu. Note the following important points.

- The items that appear on the setup menu depend on the currently selected input source and other factors.  
Some items apply to a certain specific input source, while some apply to multiple input sources.
- Even for menu items that are common to multiple input sources, the setting range or selectable options may differ according to the input source.
- With certain exceptions, there are basically two types of settings that can be configured for multiple input sources. One type lets you configure different settings for each individual input source. The other type applies a single setting to all input sources. The volume level setting, for example, lets you configure a different setting for each input source, while the keystone correction setting lets you configure a single common setting for all input sources.
- In the case of settings that can be configured for each input source, you can configure and save settings for the following signal types when the input source is a component signal.

(1) 480i60 and 576i50

(2) 480p60 and 576p50

(3) 1080i60 and 720p60

When the input source is a 480i60 component signal, for example, changing the setting for “Image Adjustment → Brightness” will cause the change to be reflected when the input source is a 567i50 component signal as well. The change is not, however, reflected for the 480p60 or 1080i60 signal.

#### NOTE

- For details about how settings are saved, and other details, see “Setup Menu Reference” on page 27.
- 



**Discount-Merchant.com (800) 281-8860**  
**THE TRUSTED SOURCE FOR PROJECTOR LAMPS AND ACCESSORIES**

## Using the Setup Menu

### Setup Menu Screen Operations

This section explains projector operations you need to perform while configuring setup menu settings. It also provides details about each sub-menu item type.

#### Basic Setup Menu Operations

The following is the general flow of the steps you need to perform when configuring setup menu operations.

1. Select the input source whose settings you want to configure.
2. Press the [MENU] key.
  - This causes the setup menu screen to appear in the upper left corner of the projected image. At this time, only the main menu will be visible.

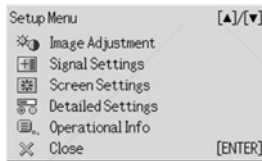

3. Press the [▼] key.
  - This will highlight the “Image Adjustment” on the main menu, indicating that it is selected. Also, the “Image Adjustment” sub-menu will appear to the right.

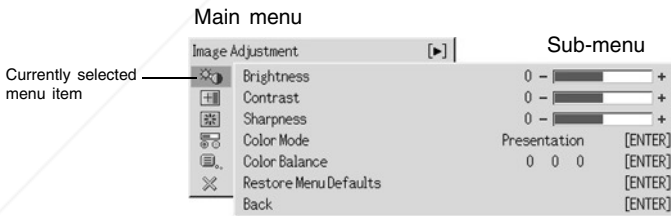

- The items that appear in the sub-menu depend on the input source you selected in step 1, and whether or not a signal is being input from the input source. For details, see “Setup Menu Overview” on page 16.

## Using the Setup Menu

4. Use the [▲] and [▼] keys to move the highlighting to the main menu item you want.

- The sub-menu for the currently selected main menu item will appear to the right.



5. Press the [▶] key or the [ENTER] key.

- This will cause the item at the top of the currently displayed sub-menu to become highlighted, indicating that it is selected.

6. Select the sub-menu item whose setting you want to change.

- Use the [▲] and [▼] keys to move the highlighting to the sub-menu item you want.

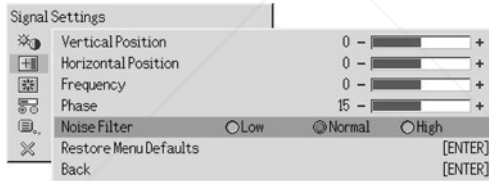

## Configuring Advanced Settings 1 and Advanced Settings 2

The “Advanced Settings 1” and “Advanced Settings 2” sub-menus on the “Detailed Settings” main menu provide access to further sub-menus for configuring various advanced settings.

Use the following steps to select items on the advanced settings sub-menus.

- (1) Use the [▲] and [▼] keys to move the highlighting to “Advanced Settings 1” or “Advanced Settings 2”.
- (2) Press the [ENTER] key.
  - This closes the main menu and switches to one of the special sub-menus shown below.

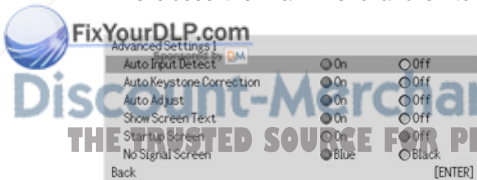

Advanced Settings 1 Sub-menu



Advanced Settings 2 Sub-menu

- (3) Use the [▲] and [▼] keys to move the highlighting to the sub-menu item you want.

## Using the Setup Menu

---

- 7.** Use the currently selected sub-menu to change settings or select options.
- The operations you need to perform depend on the sub-menu item type. For information about item types, see “Setup Menu Overview” on page 16.
  - For information about operations required for each item type, see “Sub-menu Operations” on page 22.
  - After configuring all of the settings you want for a particular sub-menu, you can use the [▲] and [▼] keys to select another sub-menu and then configure its settings.
  - To select a different main menu, move the cursor to “Back” and then press the [ENTER] key, or press the [ESC] key. Next, perform steps 4 through 7 again.
- 8.** To close the setup menu, move the cursor to “Close”, and then press the [ENTER] key.

---

 **NOTE**

- Pressing the [MENU] key while the setup menu is displayed closes the setup menu, regardless of the menu level that is currently displayed.
-

## Using the Setup Menu

### Sub-menu Operations

This section explains steps you need to perform in order to configure settings for each sub-menu item type (value, selection, setting screen, execution, information).

#### Value Setting Type Sub-menu Item

This type of sub-menu item consists of a value and a bar graph.

Examples: Image Adjustment → Brightness; Screen Settings → Keystone Correction

Operation: Press the [◀] key to make the value smaller, or the [▶] key to make it larger.

A value can be selected within the range that the indicator is able to move within the selected bar. Depending on conditions, the indicator may not move all the way to either end of the bar.



#### Selection Type Sub-menu Item

This type of sub-menu item provides a number of options from which you can choose.

Examples: Screen Settings → Aspect Ratio; Detailed Settings → Advanced Settings 1 → Auto Keystone Correction

Operation: The currently selected option is indicated by a black button next to it. Use the [◀] and [▶] keys to move between the selections, which causes the buttons next to them to become either black (selected) or white (deselected).



#### NOTE

- For details about the options that are available for each selection type sub-menu item, see "Setup Menu Reference" on page 27.

## Using the Setup Menu

### Setting Screen Type Sub-menu Item

This type of sub-menu item displays a separate screen that you use to configure its settings.

Examples: Image Adjustment → Color Mode; Detailed Settings → Advanced Settings 2 → Language, etc.

Operation: The following example shows how to configure settings for Image Adjustment → Color Mode.

1. Perform steps 1 through 6 under “Basic Setup Menu Operations” on page 19. Select the “Image Adjustment” main menu, and then select the “Color Mode” sub-menu item.

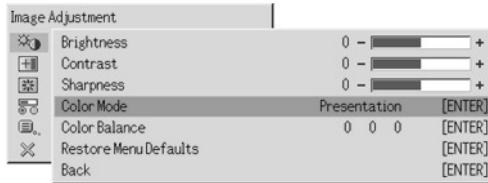

2. Press the [ENTER] key.

- This displays the Color Mode selection screen shown below.



3. Use the [▲] and [▼] keys to highlight the item you want to select, and then press the [ENTER] key.

4. After you are finished configuring settings, move the cursor to “Back” and then press the [ENTER] key, or press the [ESC] key to return to the previous sub-menu.

- After you are finished, press the [MENU] key to exit the setup menu.

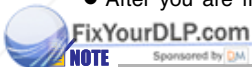

- Note that the available settings and configuration procedures depend on the setting screen. See “Setup Menu Reference” on page 27 for details about each sub-menu item.

**THE TRUSTED SOURCE FOR PROJECTOR LAMPS AND ACCESSORIES**



## Using the Setup Menu

---

### Execution Type Sub-menu Item

This type of sub-menu item returns a setting to its initial default value.

Examples: Image Adjustment → Restore Menu Defaults; Operational Info → Reset Lamp Time

- ☞ Initializing Settings (page 25)
- ☞ Resetting the Lamp Time (User's Guide (Basic Operation))

### Information Type Sub-menu Item

This type of sub-menu item provides status and setup information.

Examples: Operational Info → Lamp Time; Operational Info → Input Signal

Refer to the following for details about the type of information that is available using the information type sub-menu items.

- ☞ Operational Info → Lamp Time (page 46)
- ☞ Operational Info → Input Signal (page 46)
- ☞ Operational Info → Signal Name (page 47)
- ☞ Operational Info → Resolution (page 47)
- ☞ Operational Info → Horizontal Frequency (page 47)
- ☞ Operational Info → Vertical Frequency (page 47)
- ☞ Operational Info → Scan System (page 47)



**Discount-Merchant.com (800) 281-8860**  
**THE TRUSTED SOURCE FOR PROJECTOR LAMPS AND ACCESSORIES**

## Using the Setup Menu

---

### Initializing Settings

The setup menu lets you initialize the settings of a particular main menu item, or for all setup menu items.

#### To initialize the settings of a particular main menu item

Example: To initialize the settings of the “Image Adjustment” main menu item.

#### **Important!**

- Performing the following procedure returns all of the sub-menu items under the currently selected main menu item to their initial default settings.

1. Perform steps 1 through 6 under “Basic Setup Menu Operations” on page 19. Select the “Image Adjustment” main menu, and then select the “Restore Menu Defaults” sub-menu item.
2. Press the [ENTER] key.
  - This displays a confirmation message asking if you want to initialize settings.



3. Use the [▲] and [▼] keys to select [Yes].
4. Press the [ENTER] key to initialize the menu’s settings, or the [ESC] key to exit the initialize operation without doing anything.
  - Pressing the [ENTER] key returns all of the sub-menu items on the currently selected main menu to their initial default settings.

## Using the Setup Menu

---

### To initialize all menu settings

#### **Important!**

- Performing the procedure below will initialize all settings, except for the following setup menu sub-menu items.
    - Power on password on/off setting (Detailed Settings → Power On Password) and the current password
    - Language Setting (Detailed Settings → Advanced Settings 2 → Language)
    - Lamp Time (Operational Info → Lamp Time)
- 

1. Perform steps 1 through 6 under “Basic Setup Menu Operations” on page 19. Select the “Operational Info” main menu, and then select the “Restore All Defaults” sub-menu item.

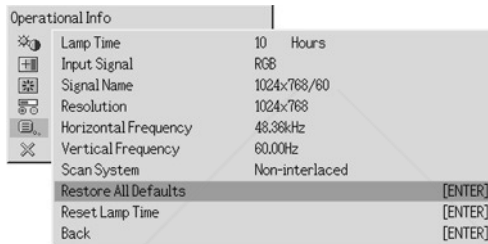

2. Press the [ENTER] key.

- This displays a confirmation message asking if you want to initialize all settings.

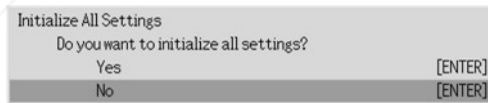

3. Use the [▲] and [▼] keys to select [Yes].

4. Press the [ENTER] key to initialize all menu settings, or the [ESC] key to exit the initialize operation without doing anything.

- Pressing the [ENTER] key will initialize all settings and information, except for the items described under “Important!” above.

### Setup Menu Reference

This section provides detailed explanations about the contents for all of the setup menu items.

#### NOTE

- The titles in this section use the format: Main Menu Item → Sub-menu Item.
- 

## Image Adjustment

### ■ Image Adjustment → Brightness

This sub-menu adjusts the brightness of the projected image. A larger value produces a brighter image.

- This setting is not possible when there is no input signal.
- A different setting can be configured and is stored for each input source.

### ■ Image Adjustment → Contrast

This sub-menu adjusts the contrast of the projected image. A larger value produces a stronger contrast.

- This setting is not possible when there is no input signal.
- A different setting can be configured and is stored for each input source.

### ■ Image Adjustment → Sharpness

This sub-menu adjusts the sharpness of the projected image. A larger value makes the image sharper, while a smaller value makes it softer.

- This setting is not possible when there is no input signal.
- A different setting can be configured and is stored for each input source.

### ■ Image Adjustment → Saturation

This sub-menu adjusts the color saturation of the projected image. A larger value increase color saturation.

- This setting is not possible when the input source is RGB and when there is no input signal.
- A different setting can be configured and is stored for each input source.

### ■ Image Adjustment → Tint

This sub-menu adjusts the tint of the projected image. A larger value makes the overall image more bluish, while a smaller value makes the overall image more reddish.

- This setting is not possible when the input source is RGB and when there is no input signal.
- A different setting can be configured and is stored for each input source.

## Using the Setup Menu

---

### ■ Image Adjustment → Color Mode

This sub-menu lets you select from among five different color settings to optimize projection in accordance with image contents and projection conditions.

#### Input Source Specific Menu Items

Input Source	Available Items (Parentheses indicate defaults.)
RGB	(Presentation), Standard, Graphics, Theater, Blackboard
Component	Presentation, Standard, Graphics, (Theater), Blackboard
S-VIDEO	
VIDEO	
No Signal	None

#### Setting Explanations

- Presentation: Select this setting for standard presentations in a well-lit area.
- Standard: Select this setting when you want to highlight the colors during your presentation.
- Graphics: Select this setting when you want photographs and graphics to appear natural.
- Theater: Select this setting to bring out the dark portions of your images.
- Blackboard: Select this setting for easy viewing when projecting onto a blackboard.

#### Setting Storage

A different setting is stored for each input source.

### ■ Image Adjustment → Color Balance

This sub-menu lets you independently adjust the red, green, and blue components of the projection image.

- Color balance cannot be adjusted when there is no signal.
- A different setting can be configured and is stored for each input source.



**Discount-Merchant.com (800) 281-8860**  
THE TRUSTED SOURCE FOR PROJECTOR LAMPS AND ACCESSORIES

## Using the Setup Menu

---

### To adjust color balance

1. On the “Image Adjustment” main menu, select the “Color Balance” sub-menu item, and then press the [ENTER] key.
  - This causes the “Color Balance” sub-menu to appear, which shows the current settings for each of the color components.

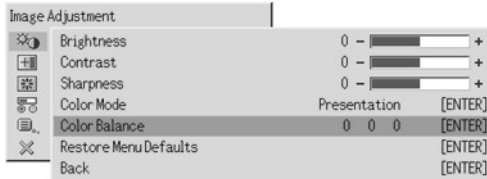

2. Press the [ENTER] key.
  - This displays the color balance setting screen.



3. Use the [▲] and [▼] keys to select the color you want to adjust (red, green, blue), and then use the [◀] and [▶] keys to adjust it.
4. After you are finished configuring settings, move the cursor to “Back” and then press the [ENTER] key, or press the [ESC] key to return to the previous sub-menu.
  - To exit the setup menu, press the [MENU] key.

### ■ Image Adjustment → Restore Menu Defaults

This sub-menu returns all of the sub-menu items on the Image Adjustment main menu to their initial default settings.

- For details about the initialization procedure, see “To initialize the settings of a particular main menu item” on page 25.

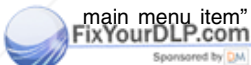

**Discount-Merchant.com (800) 281-8860**  
THE TRUSTED SOURCE FOR PROJECTOR LAMPS AND ACCESSORIES

### Signal Settings

#### ■ Signal Settings → Vertical Position

This sub-menu lets you adjust the vertical position of the input source image within the projection area.

- This setting is possible only when RGB is selected as the input source and digital zoom is not being used.
- "Image Adjustment" main menu item settings are saved for the current signal type only (XGA/60Hz, SXGA/60Hz, etc.), and not for the input signal source. Note, however, that the number of signal type settings that can be saved is limited. Exceeding the limit causes the oldest setting to be deleted automatically.

#### ■ Signal Settings → Horizontal Position

This sub-menu lets you adjust the horizontal position of the input source image within the projection area.

- This setting is possible only when RGB is selected as the input source and digital zoom is not being used.
- See "Signal Settings → Vertical Position" for details about how settings are saved.

#### ■ Signal Settings → Frequency

This sub-menu lets you manually control the frequency of the image.

Normally, the projector is able to adjust the frequency automatically. If there are vertical bands in the projected image, however, it means that automatic adjustment is not possible for some reason. When this happens use this setting to adjust the image frequency.

- This setting is possible only when RGB is selected as the input source and digital zoom is not being used.
- Settings are saved for each signal type (XGA/60Hz, SXGA/60Hz, etc.). Note, however, that the number of signal type settings that can be saved is limited. Exceeding the limit causes the oldest setting to be deleted automatically.

#### **Important!**

---

- If, for some reason, your manual frequency settings cause the image input from the computer to disappear from the projection, you can press the [AUTO] key to perform an auto adjust operation (page 7), which should cause the image to reappear.
- 

#### ■ Signal Settings → Phase

This sub-menu lets you manually control the phase of the image.

Normally, the projector is able to adjust the phase automatically. If there are color errors or flickering in the projected image, however, it means that automatic adjustment is not possible for some reason. When this happens use this setting to adjust the image phase.

- This setting is possible only when RGB is selected as the input source and digital zoom is not being used.
- See "Signal Settings → Frequency" for details about how settings are saved.

## Using the Setup Menu

### ■ Signal Settings → Noise Filter

This sub-menu provides a choice of noise filter levels to remove digital noise from the projected image when RGB is selected as the input source. Note that the noise filter may not be able to remove certain types of digital noise.

- This setting is possible only when RGB is selected as the input source and digital zoom is not being used. The setting is saved for the RGB input source only.
- Turning off the projector automatically returns this sub-menu to its initial default setting (Normal).

### Input Source Specific Menu Items

Input Source	Available Items (Parentheses indicate defaults.)
RGB	Low, (Normal), High
Component	None
S-VIDEO	
VIDEO	
No Signal	

### ■ Signal Settings → Restore Menu Defaults

This sub-menu returns all of the sub-menu items on the Signal Settings main menu to their initial default settings, except for the phase setting.

- This operation is possible only when RGB is selected as the input source and digital zoom is not being used.
- “Signal Settings” main menu “Vertical Position”, “Horizontal Position”, and “Frequency” settings are initialized for the current signal type (XGA/60Hz, SXGA/60Hz, etc.) only.
- For details about the initialization procedure, see “To initialize the settings of a particular main menu item” on page 25.

## Screen Settings

### ■ Screen Settings → Keystone Correction

This sub-menu lets you correct for vertical keystone of the projected image.

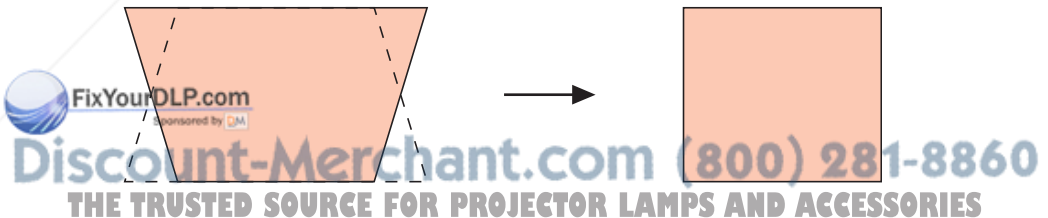

- Vertical keystone correction can be performed regardless of the currently selected input source.
- A single setting is stored, which is applied to all input sources.



## Using the Setup Menu

---

### ■ Screen Settings → Aspect Ratio

This sub-menu lets you select the aspect ratio (ratio between the vertical and horizontal dimensions) of the projected image.

#### Input Source Specific Menu Items

Input Source	Available Items (Parentheses indicate defaults.)
RGB	None
Component	(4:3), 16:9
S-VIDEO	
VIDEO	
No Signal	None

#### Setting Explanations

4:3: Sets the aspect ratio of the projected image to 4:3 (same as a standard TV screen). This setting is normally used when S-VIDEO or VIDEO is selected as the input source.

16:9: Sets the aspect ratio of the projected image to 16:9 (same as a movie screen or high-definition TV screen). Using this setting when the input source image is a 16:9 image that has been squeezed to a 4:3 image causes the image to be projected with its normal 16:9 aspect ratio.

#### Setting Storage

A different setting is stored for each input source.

#### NOTE

- When a component signal with an aspect ratio of 16:9 is sent from the input source, the aspect ratio of the projected image is automatically switched to 16:9. In this case, this setting cannot be changed.

#### Important!

- Using this projector to reduce, enlarge, or otherwise alter an image for business purposes or public display may infringe upon the rights of the individual who holds the copyright of the image.



**Discount-Merchant.com (800) 281-8860**  
THE TRUSTED SOURCE FOR PROJECTOR LAMPS AND ACCESSORIES

## Using the Setup Menu

---

### ■ Screen Settings → Resize Image to Fit

When RGB is selected as the input source and the video resolution of the connected computer is anything other than XGA (1024 × 768 pixels), “Resize Image To Fit” automatically enlarges or reduces the input image so it matches the video resolution of the projector and fills the entire screen.

#### Input Source Specific Menu Items

Input Source	Available Items (Parentheses indicate defaults.)
RGB	(On), Off
Component	None
S-VIDEO	
VIDEO	
No Signal	

#### Setting Explanations

**On:** When the input signal from the computer connected to the projector is not an XGA signal, the image is automatically enlarged or reduced so it matches the projector’s video resolution and fills the entire screen.

**Off:** Turns off resizing of the image input from the computer. If the image input from the computer is smaller than XGA, the size of the projected image will also be smaller. When the image input from the computer is larger than XGA, only the center part of the image that corresponds to XGA size is projected.

#### NOTE

- Resizing of an input image by “Resize Image To Fit” can call coarsening of the image or can cause part of the image to be cut off. If this happens, try turning off “Resize Image To Fit”. Note, however, that turning off “Resize Image To Fit” can cause the projected image to become smaller.
- The “Off” setting is disabled in the case of resolution greater than XGA.

#### Setting Storage

This setting is possible only when RGB is selected as the input source. The setting is saved for the RGB input source only.



**Discount-Merchant.com (800) 281-8860**  
**THE TRUSTED SOURCE FOR PROJECTOR LAMPS AND ACCESSORIES**

## Using the Setup Menu

---

### ■ Screen Settings → Projection Mode

Use this sub-menu to specify whether projection will be from the front of the screen or the back of the screen.

#### Input Source Specific Menu Items

Input Source	Available Items (Parentheses indicate defaults.)
RGB	(Front), Rear
Component	
S-VIDEO	
VIDEO	
No Signal	

#### Setting Explanations

Front: For projection from the front of the screen.

Rear: For projection from the back of the screen. This setting flips the front projected image horizontally.

#### Setting Storage

A single setting is stored, which is applied to all input sources.

### ■ Screen Settings → Ceiling Mount

Use this sub-menu to configure the projector for use in an installation in which it is positioned upside down.

#### Input Source Specific Menu Items

Input Source	Available Items (Parentheses indicate defaults.)
RGB	On, (Off)
Component	
S-VIDEO	
VIDEO	
No Signal	

#### Setting Explanations

On: Flips the projected image horizontally and vertically.

Off: Projects a normal image.

#### Setting Storage

A single setting is stored, which is applied to all input sources.

## Using the Setup Menu

---

### Important!

- Turning on “Ceiling Mount” automatically turns off “Detailed Settings → Low-noise Mode” (page 36). Note that the setting for “Low-noise Mode” remains “Off” even if you turn “Ceiling Mount” back off again.
  - The “Low-noise Mode” setting cannot be changed while “Ceiling Mount” is turned on.
  - Turning on “Ceiling Mount” causes the “Detailed Settings → Advanced Settings 1 → Auto Keystone Correction” setting to turn off automatically. “Auto Keystone Correction” will not turn back on again automatically if you turn off “Ceiling Mount” again.
  - The “Auto Keystone Correction” setting cannot be changed while “Ceiling Mount” is turned on.
  - Unplug the AC power cord from the power outlet if you do not plan to use it for a long time.
  - If you do not unplug the AC power cord when “Ceiling Mount” is turned on, the cooling fan will continue to operate after you turn off the projector. This is normal and does not indicate malfunction.
- 

### ■ Screen Settings → Restore Menu Defaults

This sub-menu returns all of the sub-menu items on the Screen settings main menu to their initial default settings.

- You can perform initialization even when there is no input signal. In this case, the initialization is performed for the currently selected input source.
- Basically, initialization initializes the settings of the current input source. Note, however, that the following settings are always initialized, regardless of the currently selected input source.

Keystone Correction  
Projection Mode  
Ceiling Mount

- For details about the initialization procedure, see “To initialize the settings of a particular main menu item” on page 25.

### NOTE

- Initializing these settings when “Detailed Settings → Advanced Settings 1 → Auto Keystone Correction” is turned on causes automatic keystone correction to be performed after initialization is complete, which causes “Keystone Correction” setting to show a corrected value.
- 



### Detailed Settings

#### ■ Detailed Settings → Volume

This sub-menu can be used to adjust the volume level of the projector's speaker. This setting is also linked to volume settings made with the remote controller's [VOL +] and [VOL -] keys.

- Changing this setting when there is no input signal changes the volume setting of the currently selected signal source.
- A different setting is stored for each input source.

## Using the Setup Menu

---

### ■ Detailed Settings → Pointer

This sub-menu lets you specify the type of pointer that appears first when you press the [POINTER/SELECT] key.

#### Input Source Specific Menu Items

Input Source	Available Items (Parentheses indicate defaults.)
RGB	Arrow 1, Arrow 2, Arrow 3, Bar 1, Bar 2, Bar 3
Component	
S-VIDEO	
VIDEO	
No Signal	

#### Setting Storage

A single setting is stored, which is applied to all input sources.

### ■ Detailed Settings → Low-noise Mode

The low-noise mode reduces the luminosity of the projection lamp and the speed of the cooling fan, allowing quieter projector operation.

#### Input Source Specific Menu Items

Input Source	Available Items (Parentheses indicate defaults.)
RGB	(Off), On
Component	
S-VIDEO	
VIDEO	
No Signal	

#### Setting Explanations

Off (normal mode): This mode projects at normal luminosity.

On (low-noise mode): This mode reduces luminosity and fan motor speed for quieter operation than the normal mode.

#### Setting Storage

A single setting is stored, which is applied to all input sources.



● Turning on “Screen Settings → Ceiling Mount” (page 34) automatically turns off “Low-noise Mode”. Note that the setting for “Low-noise Mode” remains “Off” even if you turn “Ceiling Mount” back off again.

● The “Low-noise Mode” setting cannot be changed while “Ceiling Mount” is turned on.

## Using the Setup Menu

---

### ■ Detailed Settings → Power On Password, Change Password

This sub-menu lets you turn the power on password on and off.

While the password is turned on, projector operation is impossible unless the correct password is entered.

For more information about the power on password, see “Password Feature” on page 52.

### Input Source Specific Menu Items

Input Source	Available Items (Parentheses indicate defaults.)
RGB	On, (Off)
Component	
S-VIDEO	
VIDEO	
No Signal	

### Setting Explanation

On: Turns on the power on password, which requires input of a password to turn on the projector.

Off: Turns off the password, which allows the projector to be operated without inputting a password.

### Setting Storage

A single setting is stored, which is applied to all input sources.

### Initial Factory Default Password

The following is the 8-key operation you should perform to input the initial factory default password.

[▲][▶][▼][◀][▲][▼][◀][▶]

### Important!

- Note that the projector's password is not really a “word”, but rather a series of remote controller key operations.
- If you need to keep projector operation secure, be sure to change the initial factory default password to a different one as soon as possible.
- The password can be input using the remote controller only. Optimum security is ensured by turning on the password and keeping the remote controller with you.
- For information about what you should do if you forget your password, see “If you forget your password...” on page 52.



FixYourDLP.com

Sponsored by

**Discount-Merchant.com (800) 281-8860**  
**THE TRUSTED SOURCE FOR PROJECTOR LAMPS AND ACCESSORIES**

## Using the Setup Menu

---

### Using the Password Input Dialog Box

The password input dialog box will appear when any one of the following occurs.

- When you turn on the projector while the password is turned on.
- When you turn the password on or off.
- When you change the password.

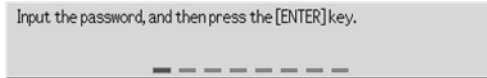

When this dialog box is shown, perform a remote controller key operation for each of the password input positions. The following explains how to input numbers.

- The cursor is flashing at the first (leftmost) input position.
- The cursor is used to select an input position for input.
- Use the remote controller cursor keys to input the password.
- Each time you perform a remote controller key operation, “■” appears at the current input position, and the cursor moves to the next input position to the right.
- A password can be from one to eight key operations long.
- After performing all of the key operations you want, press the [ENTER] key.
- To clear your input, press the [ESC] key.

### To turn the power on password on and off

**1.** Perform steps 1 through 6 under “Basic Setup Menu Operations” on page 19. Select the “Detailed Settings” main menu, and then select the “Power On Password” sub-menu item.

**2.** Press the [ENTER] key.

- This displays a password input dialog box.

**3.** Input the current password.

- The initial factory default password is: [▲][▶][▼][◀][▲][▼][◀][▶].
- For information about how to input the password, see “Using the Password Input Dialog Box” on page 38.

**4.** Press the [ENTER] key.

- If the password you input does not match the currently registered password, the message “The password you input is wrong”. appears. Press the [ENTER] key to return to step 3.
- If the password you input matches the registered password, pressing [ENTER] above will display the message “The password you input is correct!”. Press the [ENTER] key to advance to the next step.

## Using the Setup Menu

---

5. Use the [▲] and [▼] keys to turn the power on password on or off.
6. Press the [ENTER] key.

### To change the power on password

1. Perform steps 1 through 6 under “Basic Setup Menu Operations” on page 19. Select the “Detailed Settings” main menu, and then select the “Change Password” sub-menu item.
2. Press the [ENTER] key.
  - This displays a password input dialog box.
3. Input the current password.
  - The initial factory default password is: [▲][▶][▼][◀][▲][▼][◀][▶].
  - For information about how to input the password, see “Using the Password Input Dialog Box” on page 38.
4. Press the [ENTER] key.
  - If the password you input does not match the currently registered password, the message “The password you input is wrong.” appears. Press the [ENTER] key to return to step 3.
  - If the password you input matches the registered password, pressing [ENTER] above will display the message “The password you input is correct!”. Press the [ENTER] key to advance to the next step.
5. Input the new password, and then press the [ENTER] key.
  - This displays a dialog box for re-inputting the password for confirmation.
6. Re-input the same password you input in step 5, and then press [ENTER].
  - If the two passwords you input were identical, the message “Your new password has been registered.” appears. Press the [ENTER] key.
  - If the password you input here is different from the one you input in step 5, the message “The password you input is wrong! Go back and input the correct password.” appears. Pressing the [ENTER] key will display the new password input dialog box. Repeat the above procedure from step 5.



## Using the Setup Menu

---

### ■ Detailed Settings → Advanced Settings 1 → Auto Input Detect

This sub-menu lets you specify whether auto detect of the input source should be performed whenever the projector is turned on (page 5).

#### Input Source Specific Menu Items

Input Source	Available Items (Parentheses indicate defaults.)
RGB	(On), Off
Component	
S-VIDEO	
VIDEO	
No Signal	

#### Setting Explanations

On: Turns on auto detection of the input source whenever the projector is turned on.

Off: Turns off auto detection of the input source whenever the projector is turned on.

#### Setting Storage

A single setting is stored, which is applied to all input sources.

### ■ Detailed Settings → Advanced Settings 1 → Auto Keystone Correction

This sub-menu lets you specify whether auto keystone correction should be performed whenever the elevation angle of the projector is changed (page 9).

#### Input Source Specific Menu Items

Input Source	Available Items (Parentheses indicate defaults.)
RGB	(On), Off
Component	
S-VIDEO	
VIDEO	
No Signal	

#### Setting Explanations

On: Turns on auto keystone correction.

Off: Turns off auto keystone correction.

#### Setting Storage

A single setting is stored, which is applied to all input sources.

#### Important!

- Turning on "Screen Settings → Ceiling Mount" (page 34) will cause "Auto Keystone Correction" to turn off automatically. "Auto Keystone Correction" will not turn back on again automatically if you turn off "Ceiling Mount" again.
- The "Auto Keystone Correction" setting cannot be changed while "Ceiling Mount" is turned on.

## Using the Setup Menu

---

### ■ Detailed Settings → Advanced Settings 1 → Auto Adjust

This sub-menu lets you specify whether or not auto adjustment should be performed (page 7) when RGB is selected as the input source.

#### Input Source Specific Menu Items

Input Source	Available Items (Parentheses indicate defaults.)
RGB	(On), Off
Component	None
S-VIDEO	
VIDEO	
No Signal	(On), Off * Only when the currently selected input source is RGB.

#### Setting Explanations

On: Turns on auto adjustment, which is performed when RGB is selected as the input source.

Off: Turns off auto adjustment.

#### Setting Storage

This setting is saved for the RGB input terminal only.

### ■ Detailed Settings → Advanced Settings 1 → Show Screen Text

This sub-menu lets you specify whether the following information should be displayed.

- Input signal name
- Message display during input signal search
- Message when auto keystone correction is performed

#### Input Source Specific Menu Items

Input Source	Available Items (Parentheses indicate defaults.)
RGB	(On), Off
Component	
S-VIDEO	
VIDEO	
No Signal	

#### Setting Explanations

On: Selecting this option turns on information display.

Off: Selecting this option turns off information display.

#### Setting Storage

A single setting is stored, which is applied to all input sources.

## Using the Setup Menu

---

### ■ Detailed Settings → Advanced Settings 1 → Startup Screen

Use this sub-menu to specify whether or not a startup screen should be projected whenever the projector is turned on.

#### Input Source Specific Menu Items

Input Source	Available Items (Parentheses indicate defaults.)
RGB	On, (Off)
Component	
S-VIDEO	
VIDEO	
No Signal	

#### Setting Explanations

On: Projects a startup screen.

Off: No startup screen is projected.

#### Setting Storage

A single setting is stored, which is applied to all input sources.

### ■ Detailed Settings → Advanced Settings 1 → No Signal Screen

This sub-menu lets you specify what should be projected when there is no input signal to the projector.

#### Input Source Specific Menu Items

Input Source	Available Items (Parentheses indicate defaults.)
RGB	Blue, (Black)
Component	
S-VIDEO	
VIDEO	
No Signal	

#### Setting Explanations

Blue: Displays a blue screen when there is no input signal.

Black: Displays a black screen when there is no input signal.

#### Setting Storage

A single setting is stored, which is applied to all input sources.

## Using the Setup Menu

---

### ■ Detailed Settings → Advanced Settings 2 → Auto Power Off

This sub-menu lets you turn Auto Power Off (see “Turning Off the Projector” in the separate “User’s Guide (Basic Operations)”) on or off.

#### Input Source Specific Menu Items

Input Source	Available Items (Parentheses indicate defaults.)
RGB	(On), Off
Component	
S-VIDEO	
VIDEO	
No Signal	

#### Setting Explanations

On: Turns on Auto Power Off.

Off: Turns off Auto Power Off.

#### Setting Storage

A single setting is stored, which is applied to all input sources.



**Discount-Merchant.com (800) 281-8860**  
**THE TRUSTED SOURCE FOR PROJECTOR LAMPS AND ACCESSORIES**

## Using the Setup Menu

---

### ■ Detailed Settings → Advanced Settings 2 → RGB Input

This sub-menu lets you specify the type of input signal in accordance with the device connected to the projector's RGB terminal.

#### Input Source Specific Menu Items

Input Source	Available Items (Parentheses indicate defaults.)
RGB	(Auto), RGB, Component
Component	
S-VIDEO	None
VIDEO	
No Signal	(Auto), RGB, Component * Only when the currently selected input source is RGB or Component.

#### Setting Explanations

- Auto:** Select this setting for automatic switching between RGB and component in accordance with the signal input to the RGB input terminal.
- RGB:** Select this setting when a computer is connected to the projector's RGB input terminal. For details about connection, see "Connecting a Computer to the Projector" in the separate "User's Guide (Basic Operations)".
- Component:** Select this setting when the projector's RGB input terminal is connected the component video output terminal of a video device using an optionally available YK-3 component video cable. For details about connection, see "Connecting to a Component Video Output Device" on page 50.

#### Setting Storage

This setting is saved for the RGB input and the component terminals. It is ignored for all other input terminals.



**Discount-Merchant.com (800) 281-8860**  
**THE TRUSTED SOURCE FOR PROJECTOR LAMPS AND ACCESSORIES**

## Using the Setup Menu

---

### ■ Detailed Settings → Advanced Settings 2 → Video Signal, S-Video Signal

This sub-menu specifies the input signal for the projector's VIDEO and S-VIDEO input terminals.

#### Input Source Specific Menu Items

Input Source	Available Items (Parentheses indicate defaults.)
RGB	None
Component	
S-VIDEO	(Auto), NTSC, NTSC4.43, PAL, PAL-M, PAL-N, PAL60, SECAM
VIDEO	(Auto), NTSC, NTSC4.43, PAL, PAL-M, PAL-N, PAL60, SECAM * Only when the currently selected input source is VIDEO or S-VIDEO.
No Signal	

#### Setting Explanations

**Auto:** Select this setting to have the projector switch the video signal system automatically in accordance with the input signal from the video device that is connected to the VIDEO or S-VIDEO input terminal. This is the setting you should normally use.

**Other settings:** Each setting selects the applicable video system. Use these settings when you want to specify only one specific video signal for the VIDEO and S-VIDEO input terminals.

#### Setting Storage

This setting is saved for the VIDEO and S-VIDEO input terminals only.

### ■ Detailed Settings → Advanced Settings 2 → Image Enhancement 1 / Image Enhancement 2

Image Enhancement 1/Image Enhancement 2 may improve the readability of an image following keystone correction. You should select the Image Enhancement setting (1 or 2) based on which one produces the desired results, the type of image you are projecting, projection conditions, etc.

#### Input Source Specific Menu Items

Input Source	Available Items (Parentheses indicate defaults.)
RGB	On, (Off)
Component	
S-VIDEO	(Auto), NTSC, NTSC4.43, PAL, PAL-M, PAL-N, PAL60, SECAM
VIDEO	
No Signal	None

## Using the Setup Menu

---

### ■ Detailed Settings → Advanced Settings 2 → Language

This sub-menu lets you specify the language to use for messages, setup menus, etc.

#### Input Source Specific Menu Items

Input Source	Available Items
RGB	English, French, German, Italian, Spanish, Swedish, Chinese (Simplified), Chinese (Traditional), Korean, Japanese
Component	
S-VIDEO	
VIDEO	
No Signal	

#### Setting Storage

A single setting is stored, which is applied to all input sources.



- This setting is required the first time you turn on the projector. For more information, see “Turning On the Projector” in the separate “User’s Guide (Basic Operations)”.

### ■ Detailed Settings → Restore Menu Defaults

This sub-menu returns all of the sub-menu items on the Detailed Settings main menu to their initial defaults, except for the power on password on/off setting (Detailed Settings → Power On Password), the password, and the language (Detailed Settings → Advanced Settings 2 → Language).

- You can perform initialization even when there is no input signal. In this case, the initialization is performed for the currently selected input source.
- The Auto Adjust item is initialized only when RGB is selected as the input source. All other items are always initialized, regardless of the currently selected input source.
- For details about the initialization procedure, see “To initialize the settings of a particular main menu item” on page 25.

## Operational Info

### ■ Operational Info → Lamp Time

This sub-menu item shows the cumulative number of hours the current lamp has been used to date.

Use this value as a reference when deciding whether or not the current lamp needs to be replaced. For details about replacing the lamp, see “Replacing the Lamp” in the separate “User’s Guide (Basic Operations)”.

### ■ Operational Info → Input Signal

This sub-menu item shows the currently selected input signal (RGB, Component, S-VIDEO, or VIDEO). “----” is indicated here when there is no input signal.

## Using the Setup Menu

---

### ■ Operational Info → Signal Name

This sub-menu item shows the signal name of the signal input to the projector. The “Signal Name” column of the table under “Supported Signals” on page 58 shows the signal names that are displayed by this sub-menu item.

### ■ Operational Info → Resolution

This sub-menu item appears only when RGB is the input signal, and shows the resolution of the RGB input signal in terms of vertical and horizontal pixels.

### ■ Operational Info → Horizontal Frequency

This sub-menu item appears only when RGB, Component, S-VIDEO, or VIDEO is the input signal. It shows the horizontal frequency of the input signal.

### ■ Operational Info → Vertical Frequency

This sub-menu item appears only when RGB, Component, S-VIDEO, or VIDEO is the input signal. It shows the vertical frequency of the input signal.

### ■ Operational Info → Scan System

This sub-menu item appears only when RGB or Component is the input signal, and shows the scanning frequency of the input signal. The input signal is interlace or non-interlace for RGB signal input, and interlace or progressive for Component signal input.

### ■ Operational Info → Restore All Defaults

This sub-menu returns all of sub-menu items on the setup menu to their initial default settings, except for the power on password on/off setting (Detailed Settings → Power On Password), the password, the language (Detailed Settings → Advanced Settings 2 → Language), and the lamp time (Operational Info → Lamp Time). This operation can be performed regardless of the currently selected input source and regardless of whether or not a signal is currently being input.

For details about this initialization procedure, see “To initialize all menu settings” on page 26.

### ■ Operational Info → Reset Lamp Time

Use this sub-menu item to reset the lamp time to 0 hours. For details about replacing the lamp and the initialization procedure, see “Replacing the Lamp” in the separate “User’s Guide (Basic Operations)”.



**Discount-Merchant.com (800) 281-8860**  
**THE TRUSTED SOURCE FOR PROJECTOR LAMPS AND ACCESSORIES**



# Appendix

## Remote Controller Signal Range

When performing an operation on the remote controller, point it at the remote control signal port on the back or front of the projector. The following illustration shows the range of the remote controller signal.

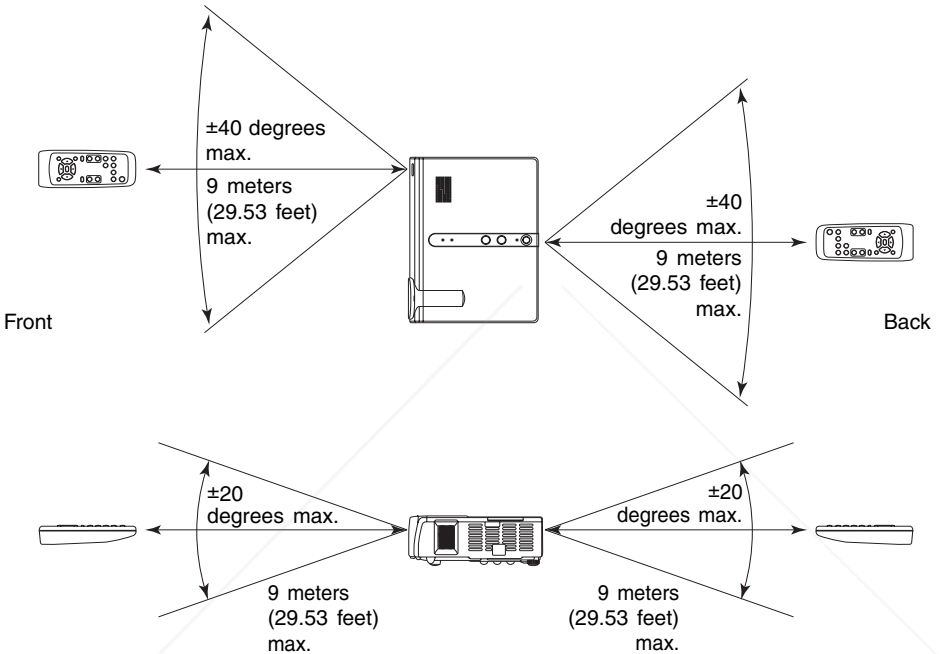

**Discount-Merchant.com (800) 281-8860**  
THE TRUSTED SOURCE FOR PROJECTOR LAMPS AND ACCESSORIES

## Projection Distance and Screen Size

- The allowable projection range is from 0.8 meter (2.62 feet) to 16.1 meters (52.82 feet), which is the distance from the surface of the lens to the screen.

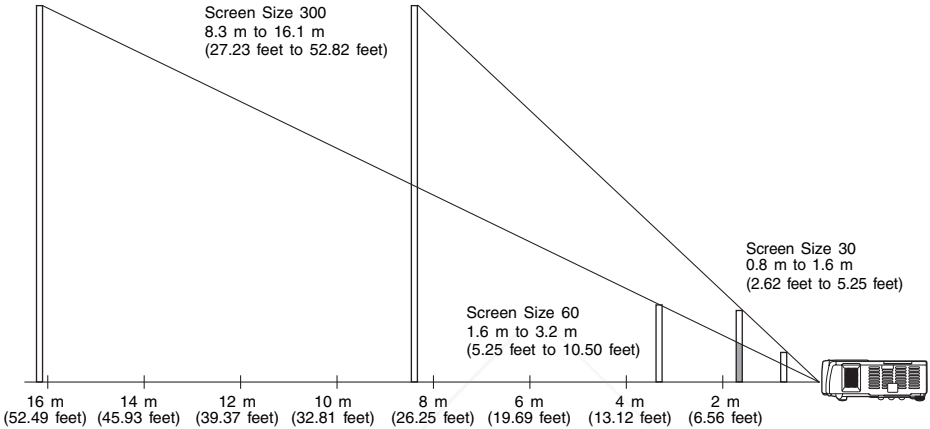

The following table shows the relationship between the distance and projected image size.

Projection Size		Approximate Projection Distance			
Screen Size	Diagonal (cm)	Minimum Distance (m)	Maximum Distance (m)	Minimum Distance (feet)	Maximum Distance (feet)
30	76	0.8	1.6	2.62	5.25
40	102	1.1	2.1	3.61	6.89
60	152	1.6	3.2	5.25	10.50
80	203	2.2	4.3	7.22	14.11
100	254	2.7	5.3	8.86	17.39
120	305	3.3	6.4	10.83	21.00
150	381	4.1	8.0	13.45	26.25
200	508	5.5	10.6	18.04	34.78
250	635	6.9	13.4	22.64	43.96
300	762	8.3	16.1	27.23	52.82

- Note that the distances provided above are for reference only.

# Connecting to a Component Video Output Device

Some video devices are equipped with a component video output terminal. You can use an optionally available component video cable (YK-3) to connect the RGB input terminal of the projector to the component video output terminal of a video device.

### Important!

- Always turn off the projector and the video device before connecting them.

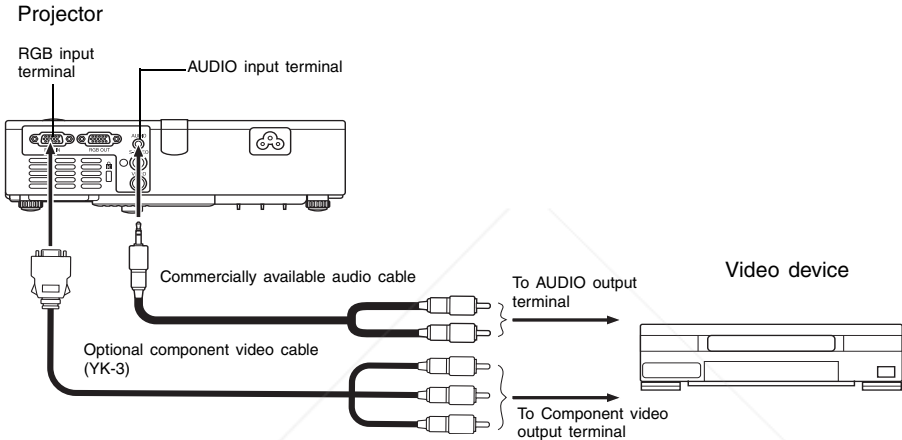

- Component video output terminals come in 3-terminal sets: Y-Cb-Cr or Y-Pb-Pr. Be sure to match the colors of the plugs on the optional YK-3 component video cable with the colors of the terminals (Green: Y; Blue: Cb/Pb; Red: Cr/Pr).
- You can use the optional YK-3 component video cable to connect to pin jack (RCA) type component video output terminals. The projector does not support connection to any other type of terminal.
- Note that connection only to an analog component video output terminal is supported. Connection to a digital output terminal is not supported.

## Full-screen Display of an RGB Image

The projector outputs images using XGA (1024 pixels × 768 pixels) video resolution. When the input signal from the computer connected to the projector is not an XGA signal, “Resize Image To Fit” automatically enlarges or reduces the image so it matches the projector’s video resolution and fills the entire screen. The following shows how different input signals from a computer are adjusted during projection.

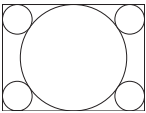
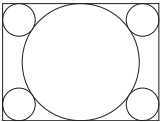
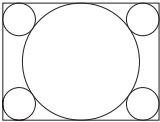
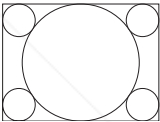
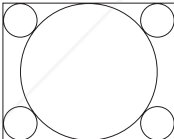
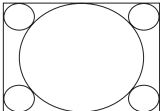
Input Signal Example	Projected Image
<p style="text-align: center;">800 × 600</p> 	
<p style="text-align: center;">1024 × 768</p> 	
<p style="text-align: center;">1280 × 1024</p> 	 <p>When the input signal has a resolution of 1280 × 1024 (aspect ratio: 5:4), the original image is compressed so it conforms to the projection resolution of 1024 × 768 (aspect ratio: 4:3). Because of this, the projected image may appear slightly wider horizontally than the original image.</p>



Discount-Merchant.com (800) 281-8860

- NOTE Resizing of an input image by “Resize Image To Fit” can call coarsening of the image or can cause part of the image to be cut off. If this happens, try turning off “Resize Image To Fit”. See “Screen Settings → Resize Image to Fit” on page 33 for more information.

# Password Feature

## Using the Password Feature

The password feature lets you limit use of the projector to specific individuals. Note that the password feature is not an anti-theft measure.

The projector is preset with an 8-key operation sequence at the factory as an initial default password. To use the password feature for the first time, use the procedure explained in the “Detailed Settings → Power On Password” on page 37 to input the initial default password. Be sure to replace the initial default password with a unique password created by you as soon as possible.

Remember that password operations are always performed using the remote controller, so you should take care not to lose or misplace the remote controller.

Also note that you will not be able to input the password if the remote controller batteries are dead. You should replace remote controller batteries as soon as possible after you notice they are starting to run down.

## If you forget your password...

You will not be able to use the projector if you forget the password for some reason. If you forget the password, you will need to bring the following two items to your CASIO distributor to have the password cleared. Note that you will be charged to have the password cleared.

1. Personal identification (original or copy of your driver's license, employee I.D., etc.)
2. Projector unit

Note that your CASIO distributor will not be able to clear the password of your projector unless you bring both of the items listed above.

Also, keep the projector's warranty in a safe place.

### Important!

- Clearing the password will return all other projector settings (except for the lamp use time) to their initial factory defaults.

## Keep a written record of your password!

You will not be able to use the projector if you forget its password. We strongly suggest that you keep a written or other type of record of the password so you can look it up when necessary.

# Cleaning the Projector

### Important!

- Always make sure that the projector has cooled sufficiently before cleaning it. If the projector is turned on, perform the following steps before cleaning it.

1. Turn off the projector.
  2. Check to make sure that the POWER/STANDBY indicator has changed to amber.
  3. Unplug the power cord from the power outlet, and allow the projector to cool down for about 60 minutes.
- 

## Cleaning the Projector Exterior

Wipe the exterior of the projector with a soft cloth that has been moistened in a weak solution of water and a mild neutral detergent. Be sure to wring all excess moisture from the cloth before wiping.

Never use benzene, alcohol, thinner, or any other volatile agent for cleaning.

## Cleaning the Lens

Carefully wipe the lens with a lens cloth or lens cleaning paper, which you should be able to purchase from a nearby eye wear or camera shop. When cleaning the lens, be very careful to avoid scratching it.

## Cleaning Intake and Exhaust Vents

Dust and dirt tend to collect around the intake vents located on the bottom of the projector. Because of this, you should use a vacuum cleaner to clean away accumulated dust and dirt periodically as shown below. When cleaning vents, you should set the vacuum clear to its lowest power setting.

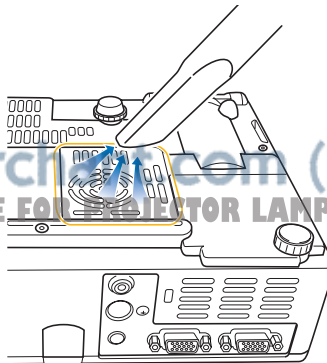

### Important!

- Continued use of the projector after dust has accumulated around the intake vents can cause overheating of internal components and lead to malfunction.
  - Certain operating conditions also can cause dirt and dust to accumulate around the projector's other intake and exhaust vents (on the sides, etc.). If this happens, use the same procedure as that described above to clean the side vents.
- 

## Reattaching the Lens Cover

Use the following procedure to reattach the lens cover if it should accidentally become detached from the projector.

1. Positioning the lens cover so it is at an angle that is more than 90 degrees relative to the lens, insert left hinge ③ of the lens cover into the slot on the left ①.

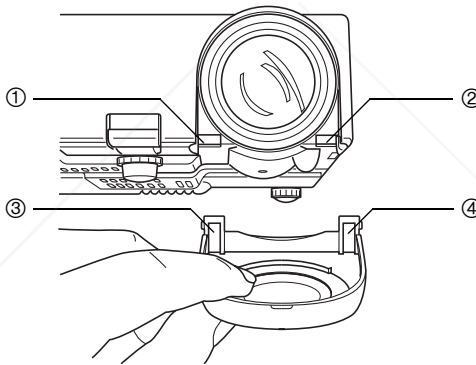

2. Without changing the angle of the lens cover relative to the lens, use the end (not the tip) of a pen or some similar instrument to gently press the right hinge of the cover ④ inwards as you insert the hinge into the slot on the right ②.

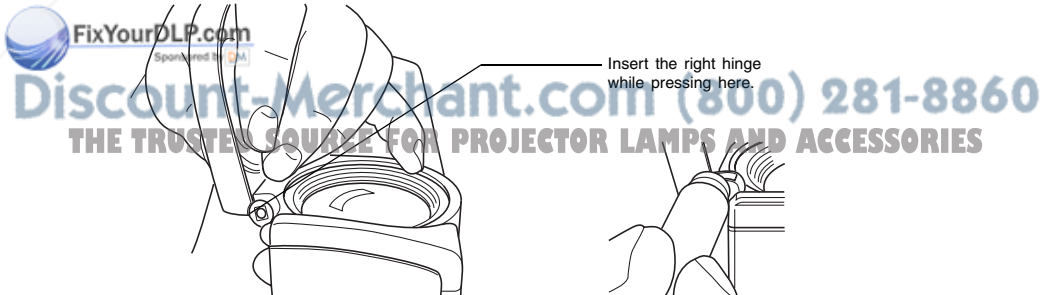

## Appendix

---

### Important!

- When reattaching the lens cover, make sure it is at an angle that is more than 90 degrees relative to the lens as shown in the illustration on the left. If you reattach the lens cover while it is at an angle less than 90 degrees as shown in the illustration on the right, the lens cover will not open and close correctly, and may become damaged.





## Projector Troubleshooting

Check the following items whenever you experience any problem with the projector.

Problem	Cause and Recommended Action	See
The projector does not turn on when I press the [⏻] (power) key.	If the POWER/STANDBY indicator is not lit, the AC power cord may not be connected correctly. → Make sure the AC power cord is connected correctly to the projector and the power outlet (see “Turning On the Projector”).	“User’s Guide (Basic Operations)”
	If the TEMP or LAMP indicator remains flashing or lit, it means some type of error has occurred. → See “Error Indicators” under “Indicators and Alert Tones”.	“User’s Guide (Basic Operations)”
The projector does not project any image from the connected device.	The connected computer or video device may not be turned on, or it may not be outputting a video signal. → Make sure the connected computer or video device is turned on, and perform the required operation on it to output a video signal.	—
	The correct output source is not selected on the projector. → On the projector, select the input source that corresponds to the device whose image you are trying to project.	page 6
The projector does not project the image correctly from a connected component device.	Images may not project correctly when you have the component output of a video device connected to the RGB input terminal of the projector. → Try using the projector’s VIDEO input terminal or S-VIDEO input terminal (see “Connecting to a Standard Video Device”).	“User’s Guide (Basic Operations)”
When RGB/Component is selected as the input source, the color of the projected image or the image itself is abnormal.	The settings configured on the setup menu’s “Detailed Settings → Advanced Settings 2 → RGB Input” menu may not be compatible with the device connected to the RGB input terminal. → Use the setup menu to configure the “Detailed Settings → Advanced Settings 2 → RGB Input” menu settings to correct the problem.	page 44
The projected image is distorted	Try pressing the applicable input source key ([RGB/COMPONENT], [VIDEO], [S-VIDEO]) on the remote controller, or the [AUTO] key.	page 7
The projected image becomes distorted when it is zoomed with the [D-ZOOM] key.	When certain projection signal types or zoom factors are in use, pressing the [D-ZOOM] key to zoom the projected image can cause the image to become distorted. → Try using a different zoom factor.	page 12

## Appendix

Problem	Cause and Recommended Action	See
The aspect ratio of the screen has changed considerably.	Using the [AUTO] key to perform automatic adjustment in the case of RGB input can cause the aspect ratio of the screen to change, and the projected image to become larger. Whether this happens depends on the slideshow, movie, or other scene being projected. → To return to the image to its original state, turn off “Detailed Settings → Advanced Settings 1 → Auto Adjust”, and then press the [RGB/COMPONENT] key.	page 41
A blue screen is displayed.	Certain operating conditions can cause the blue screen to be displayed when the computer’s resolution setting is high. → Use a setting of 1024 × 768 / 60Hz.	—
The remote controller does not work.	The remote controller batteries may be dead. → Replace the batteries (see “Loading Remote Controller Batteries”).	“User’s Guide (Basic Operations)”
	The remote controller may be too far from the projector. → Make sure the remote controller is within the allowable range when you operate it.	page 48
The TEMP or LAMP indicator is flashing or lit.	→ See “Error Indicators” under “Indicators and Alert Tones”.	“User’s Guide (Basic Operations)”
The message “It is time to replace the lamp.” is being projected.	It is time to replace the lamp. → Replace the lamp (see “Replacing the Lamp”).	“User’s Guide (Basic Operations)”
The message “The lamp has exceeded its service life!” is being projected.	The allowable life for the lamp has been exceeded, and the projector will not turn on. → Replace the lamp (see “Replacing the Lamp”).	“User’s Guide (Basic Operations)”

### Important!

- Try performing the following steps, which can return the projector to normal operation.
  1. Press the [⏻] (power) key to turn off the projector.
  2. After the projector’s cool down is finished and the fan is completely stopped, unplug the AC power cord.
  3. Plug the power cord back in and turn the projector back on again.

\* If the power off confirmation message does not appear when you press the [⏻] (power) key, unplug the AC power cord and wait for at least 10 minutes. Then plug the power cord back in and the projector back on again.

If normal operation does not resume after you perform the above steps, take the projector to your retailer or authorized CASIO Service Center.

## Supported Signals

RGB Signal

	Signal Name	Resolution	Horizontal Frequency (kHz)	Vertical Frequency (Hz)
VESA	640 × 350/85	640 × 350	37.9	85
	640 × 400/85	640 × 400	37.9	85
	720 × 400/85	720 × 400	37.9	85
	640 × 480/60	640 × 480	31.5	60
	640 × 480/72	640 × 480	37.9	73
	640 × 480/75	640 × 480	37.5	75
	640 × 480/85	640 × 480	43.3	85
	800 × 600/56	800 × 600	35.2	56
	800 × 600/60	800 × 600	37.9	60
	800 × 600/72	800 × 600	48.1	72
	800 × 600/75	800 × 600	46.9	75
	800 × 600/85	800 × 600	53.7	85
	1024 × 768/60	1024 × 768	48.4	60
	1024 × 768/70	1024 × 768	56.5	70
	1024 × 768/75	1024 × 768	60.0	75
	1024 × 768/85	1024 × 768	68.7	85
	1152 × 864/75	1152 × 864	67.5	75
	1280 × 960/60	1280 × 960	60.0	60
1280 × 1024/60	1280 × 1024	64.0	60	
APPLE	640 × 480/67M13	640 × 480	35.0	67
	832 × 624/75M16	832 × 624	49.7	75
	1024 × 768/75M19	1024 × 768	60.2	75
NEC	640 × 400/56	640 × 400	24.8	56



**Discount-Merchant.com (800) 281-8860**  
 THE TRUSTED SOURCE FOR PROJECTOR LAMPS AND ACCESSORIES

## Appendix

---

### Component Signal

	Signal Name	Horizontal Frequency (kHz)	Vertical Frequency (Hz)
HDTV	1080i60	33.7	60
	720p60	45.0	60
SDTV	576p50	31.3	50
	576i50	16.6	50
	480p60	31.5	60
	480i60	15.7	60

### Video/S-Video Signal

Signal Name	Horizontal Frequency (kHz)	Vertical Frequency (Hz)
NTSC	15.7	60
NTSC4.43	15.7	60
PAL	15.6	50
PAL-M	15.7	60
PAL-N	15.6	50
PAL60	15.7	60
SECAM	15.6	50

- \* Listing of a device in the above table does not guarantee that you will be able to display its images correctly.
- \* When "640 × 350/85" is the input signal, the "Operational Info" sub-menu items show 640 × 400/85 information.



**Discount-Merchant.com (800) 281-8860**  
**THE TRUSTED SOURCE FOR PROJECTOR LAMPS AND ACCESSORIES**

# CASIO®



**CASIO COMPUTER CO.,LTD.**

6-2, Hon-machi 1-chome  
Shibuya-ku, Tokyo 151-8543, Japan

**Discount-Merchant.com (800) 281-8860**

**THE TRUSTED SOURCE FOR PROJECTOR LAMPS AND ACCESSORIES**



# Disclaimer

This user manual is provided as a free service by FixYourDLP.com. FixYourDLP is in no way responsible for the content of this manual, nor do we guarantee its accuracy. FixYourDLP does not make any claim of copyright and all copyrights remain the property of their respective owners.

About FixYourDLP.com

FixYourDLP.com (<http://www.fixyourdlp.com>) is the World's #1 resource for media product news, reviews, do-it-yourself guides, and manuals.

Informational Blog: <http://www.fixyourdlp.com>

Video Guides: <http://www.fixyourdlp.com/guides>

User Forums: <http://www.fixyourdlp.com/forum>

FixYourDLP's Fight Against Counterfeit Lamps:

<http://www.fixyourdlp.com/counterfeits>

## Sponsors:

RecycleYourLamp.org – Free lamp recycling services for used lamps:

<http://www.recycleyourlamp.org>

Lamp Research - The trusted 3rd party lamp research company:

<http://www.lampresearch.com>

Discount-Merchant.com – The worlds largest lamp distributor:

<http://www.discount-merchant.com>



**FixYourDLP.com**

Sponsored by 