



Disclaimer

This user manual is provided as a free service by FixYourDLP.com. FixYourDLP is in no way responsible for the content of this manual, nor do we guarantee its accuracy. FixYourDLP does not make any claim of copyright and all copyrights remain the property of their respective owners.

About FixYourDLP.com

FixYourDLP.com (<http://www.fixyourdpl.com>) is the World's #1 resource for media product news, reviews, do-it-yourself guides, and manuals.

Informational Blog: <http://www.fixyourdpl.com>

Video Guides: <http://www.fixyourdpl.com/guides>

User Forums: <http://www.fixyourdpl.com/forum>

FixYourDLP's Fight Against Counterfeit Lamps:

<http://www.fixyourdpl.com/counterfeits>

Sponsors:

RecycleYourLamp.org – Free lamp recycling services for used lamps:

<http://www.recycleyourlamp.org>

Lamp Research - The trusted 3rd party lamp research company:

<http://www.lampresearch.com>

Discount-Merchant.com – The worlds largest lamp distributor:

<http://www.discount-merchant.com>



FixYourDLP.com

Sponsored by 

Digital Multimedia Projector

Model name

DS2/DX2

OPERATING GUIDE

Thank you very much for purchasing this DLP™ Technology Projector.

Please read this operating guide to ensure correct use of the device. After reading this manual, keep it for future reference.

Outline

This DLP™ Technology Projector can display various computer signals and NTSC/PAL/SECAM video signals.

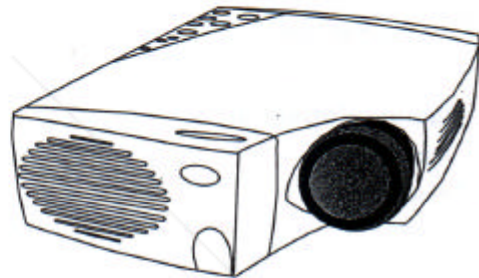

Features

- (1) ◀ High brightness
- (2) ◀ High resolution
- (3) ◀ Compact size, light weight for portability
- (4) ◀ RGB output terminal
- (5) ◀ RS232 Communication
- (6) ◀ Mouse emulation



FixYourDLP.com

Sponsored by DM

Discount-Merchant.com (800) 281-8860

THE TRUSTED SOURCE FOR PROJECTOR LAMPS AND ACCESSORIES

Copyright

Copyright © 2000 by this company. All rights reserved. No part of this publication may be reproduced, transmitted, transcribed, stored in a retrieval system or translated into any language or computer language, in any form or by any means, electronic, mechanical, magnetic, optical, chemical, manual or otherwise, without the prior written permission of this company.

Disclaimer

This company makes no representations or warranties, either expressed or implied, with respect to the contents hereof and specifically disclaims any warranties, merchantability or fitness for any particular purpose. Further, this company reserves the right to revise this publication and to make changes from time to time in the contents hereof without obligation of this company to notify any person of such revision or changes.

Fill this in!!

For the convenience of service, record the following information in the space below. The serial number is on the back of the product.

Monitor Information

Product Name:

Serial Number:

Date of Purchase:

Dealer Information

Dealer:

Telephone

Number:

Address:

Caution

TO PREVENT SHOCK, DO NOT OPEN THE CABINET. NO USER-SERVICEABLE PARTS INSIDE. REFER SERVICING TO QUALIFIED PLUS SERVICE PERSONNEL. AND PLEASE READ ALL OF THESE INSTRUCTIONS BEFORE YOU OPERATE YOUR PROJECTOR. SAVE THESE INSTRUCTIONS FOR FUTURE REFERENCE.

Safety Instructions

1. Read all of these instructions before you operate your projector and save for future reference.
2. The lamp becomes extremely hot during operation. Allow the projector to cool for approximately 45 minutes prior to removing the lamp assembly for replacement. Do not operate lamps beyond the rated lamp life. Excessive operation of lamps beyond rated life could cause them to explode in rare occasions.
3. Power is still available when the projector is in the standby mode. Never replace lamp assembly or any electronic components unless the projector is unplugged.
4. Do not attempt to service this product yourself, as opening or removing covers may damage the components inside and will void your warranty.
5. Do not place this product on an unstable cart, stand, or table. The product may fall, causing serious damage to the product.
6. The Standard Remote Control contains a low-power laser that acts as a pointing device during presentations. The light beam may cause injury if pointed directly into a person's eyes.
7. This product is capable of displaying inverted images for ceiling mount configurations. Please use suitable equipment for mounting the unit and make sure it is securely installed.
8. Openings in front or at two sides are for ventilation. They must not be blocked or covered.
9. For ventilation reasons, the fan continues to operate for about 2 minutes after the projector has been powered off. Please do not unplug the power cord until the fan stops.
10. Do not look straight at the projector lens during operation. The intense light beam may injure your eyes.



FixYourDLP.com

Sponsored by



This product is capable of displaying inverted images for ceiling mount configurations. Please use suitable equipment for mounting the unit and make sure it is securely installed.

Discount Merchants (800) 281-8860

THE TRUSTED SOURCE FOR PROJECTOR LAMPS AND ACCESSORIES

Table of Contents

| | |
|---|----|
| Introduction..... | 1 |
| Projector Features..... | 1 |
| Description..... | 2 |
| A FRONT (figure)..... | 2 |
| B REAR (figure)..... | 2 |
| C BOTTOM (figure)..... | 3 |
| Installation..... | 3 |
| A Positioning..... | 3 |
| B Adjustable Feet..... | 3 |
| Moving the Projector..... | 4 |
| Accessories..... | 5 |
| Connection..... | 6 |
| A Connecting the Projector to Computer/Notebook..... | 6 |
| B Connecting the Projector to Macintosh/Power Book..... | 7 |
| Operation..... | 8 |
| Turn On/Off Procedure..... | 8 |
| A Power on..... | 8 |
| B Standby..... | 8 |
| External Control..... | 8 |
| A Control Pad..... | 8 |
| B Remote Control..... | 9 |
| Usage and Replacement of Lamp..... | 11 |
| A Lamp/temperature Status LED Indicator..... | 11 |
| B Replacing the Lamp..... | 13 |
| OSD..... | 15 |
| Main OSD Menu..... | 15 |
| A Display Page..... | 16 |
| B Image Page..... | 17 |
| C Control Page..... | 18 |
| D Source Page..... | 18 |
| Other Correspondent Remote Functions and Messages..... | 19 |
| Maintenance and Troubleshooting..... | 21 |
| A Lamp Replacement..... | 21 |
| B Cleaning the Lens..... | 21 |
| C Troubleshooting..... | 21 |
| Specifications..... | 23 |
| A Optical..... | 23 |
| B Electrical..... | 23 |
| C Mechanical..... | 23 |
| D Preset Display Resolution Table..... | 24 |
| Appendix..... | 25 |
| Connection Port..... | 25 |
| Control Pad..... | 25 |
| A Connecting the Box..... | 26 |



FixYourDLP.com

Sponsored by



Control Pad

A Connecting the Box

Discount-Merchant.com (800) 281-8860

THE TRUSTED SOURCE FOR PROJECTOR LAMPS AND ACCESSORIES

Introduction



Projector Features

A Image Resolution

Fully compatible with true SVGA, and supports SXGA using advanced intelligent compression technology. The advanced intelligent compression technology enables it to present clear compression images without line omission.

B Brightness

Provides superior brightness using TI's Digital Micromirror Device (DMD) and our own optical design, with a geometric effect that increases light usage efficiency. By increasing the light usage efficiency we can better reproduce the three basic colors (RGB) required for color reproduction on a single DMD.

C Portability

This projector has a sophisticated shape, like that of an attaché case, that is extremely compact and lightweight. It helps you make powerful presentations wherever you go with its 5-pound weight and B5 size.

D Keystone

The projection position is already set to the height of the line of vision; there is no keystone effect. Even when projecting above or under the height of the line of vision, image distortion (if any) can be adjusted using the digital keystone correction function.

E Multilanguage

The OSD (On Screen Display: information screens and menus) in 7 languages (English, Deutsch, Français, Italiano, Español, Portuguese and Simplified Chinese) provides you with additional information to help you make corrections with OSD operation in your native languages.

F Auto Detect System

This projector can detect display signals from PCs with frequently used timing and do the optimization simultaneously. It does not require complicated adjustments in order to project picture images from PCs.

G Ceiling Mount and Rear Screen Projection

The projector is equipped with a full mirror scan conversion function (vertical/horizontal mirror), which allows the image to be reversed for ceiling mounting as well as for rear projection applications.

Video Module

An Video Module is optional, and users can attach one or two to the projector. Additionally, our Video Module video standard is compatible with



FixYourDLP.com

Sponsored by DM

Discount-Merchant.com (800) 281-8860

THE TRUSTED SOURCE FOR PROJECTOR LAMPS AND ACCESSORIES

Moving the Projector

Replace the lens cover and rotate the feet fully clockwise (to shorten the feet) when moving the projector to prevent damage to the projector.



Caution

The carry bag (supplied) is intended to protect the projector from dust and scratches on the surface of the cabinet. It is not designed to protect the projector from external shock.

Do not transport the projector in an unsuitable transport case by using a courier or transport service. This may cause damage to the projector.

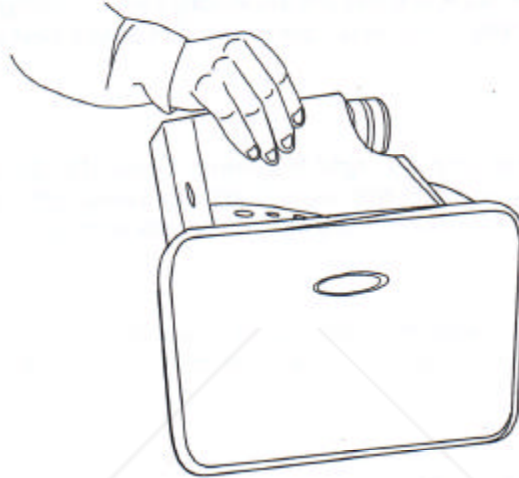

Figure 6 Moving the projector



FixYourDLP.com

Sponsored by 

Discount-Merchant.com (800) 281-8860

THE TRUSTED SOURCE FOR PROJECTOR LAMPS AND ACCESSORIES

Accessories

Please check and make sure your box contains everything listed below. If any pieces are missing, contact your dealer.

Please save the original box and packing materials in case you ever need to ship the unit.

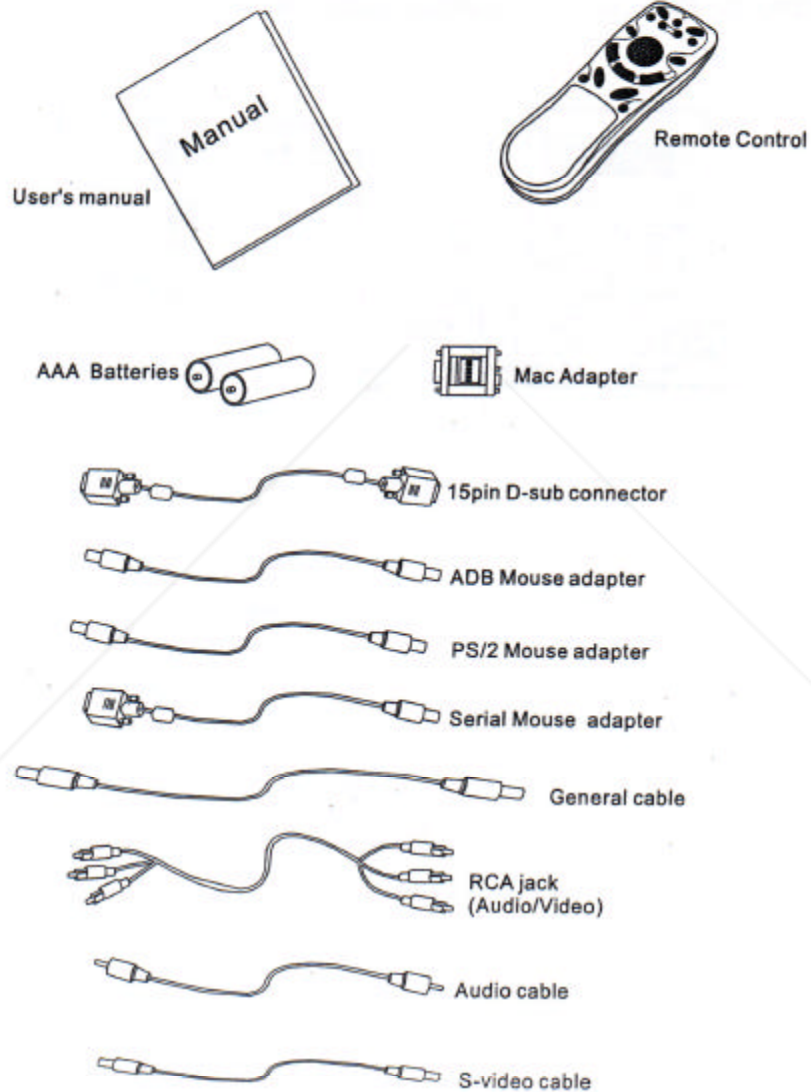

Figure 7 Accessories of DS2/DX2

A Connecting the Projector to Computer/Notebook

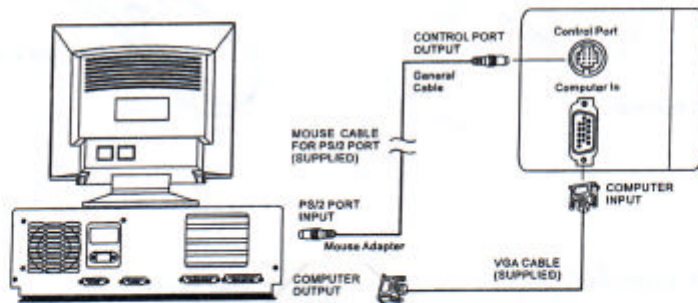

Figure 8 Connection to PC

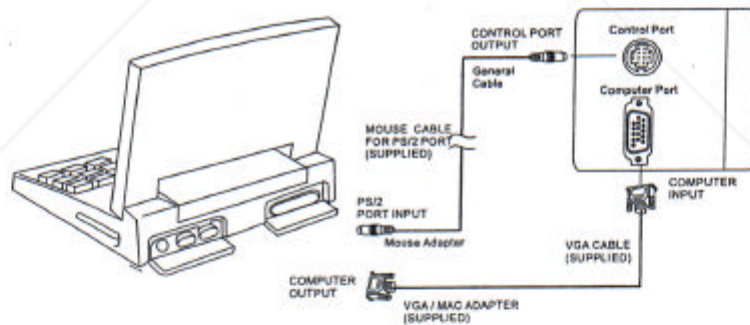

Figure 9 Connection to notebook

B Connecting the Projector to Macintosh/Power Book

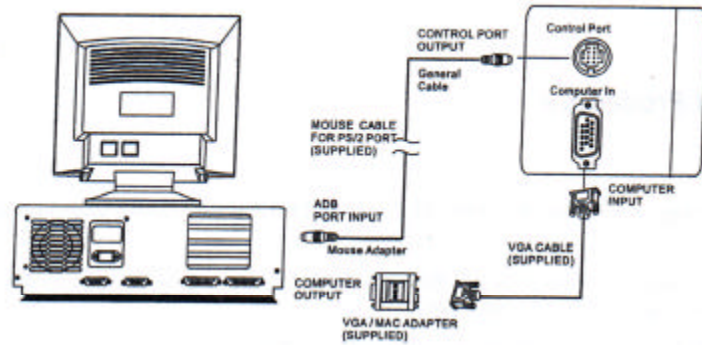

Figure 10 Connection to Macintosh

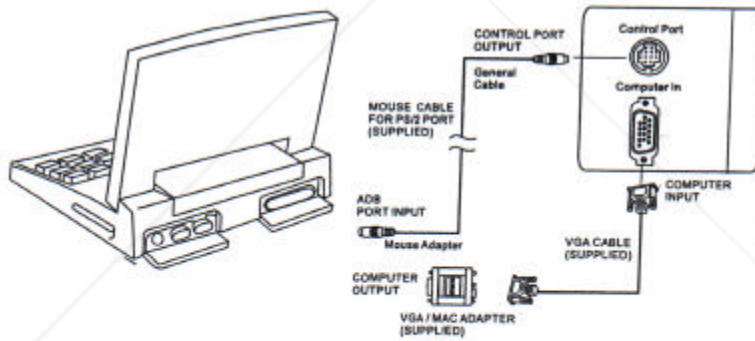

Figure 11 Connection to Power Book

Turn On/Off Procedure

A Power on

Press the Power key to turn on the lamp. The LED will blink green during warm up and then light solid green.

- "INPUT SIGNAL DETECTED, ACTIVATING AUTO IMAGE" will be displayed on the screen after the projector has identified the input signal;
- "SEARCHING" message will be displayed on the screen if there is no signal input;
- "SYNC IS OUT OF RANGE" message will be displayed on the screen if the horizontal frequency of the input signal exceeds the range of the projector.

B Standby

Press the Power key for more than one second to turn off the lamp. The LED will then blink orange and the lamp will shut down, but the fan will continue to run for about 1 minutes to cool the lamp. After the fan stops, the LED will turn to a light solid orange.

**Lamp Protection feature : If you try to turn on the lamp again while the LED is blinking, the projector will ignore the command until it has cooled down for two minutes.*

External Control

A Control Pad

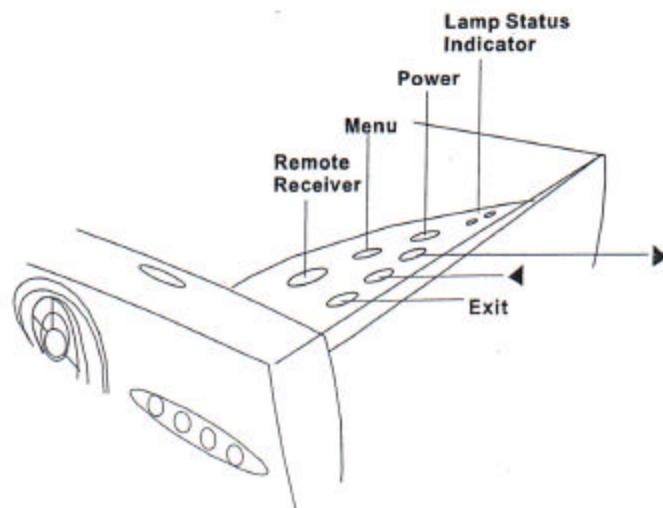
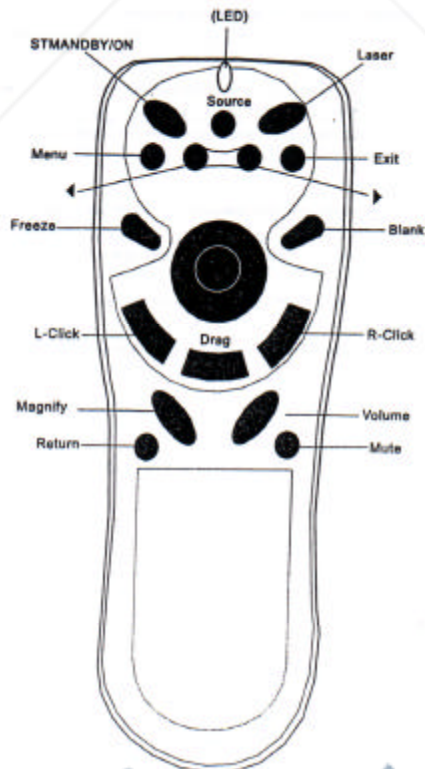

Figure 12 External control pad

| MAIN UNIT | FUNCTION |
|-----------------------|---|
| Menu | To call the OSD menu. To enter sub pages. To select items. |
| ▶ | To navigate through sub pages or to increase the scale bar number. |
| ◀ | To navigate through sub pages or to decrease the scale bar number. |
| Exit | To exit from the current page or OSD menu, and save setting changes. To show lamp hour message |
| Power | To turn the projection lamp on and off. |
| Power indicator | Functions as an indicator showing the standby status. |
| Lamp status indicator | Lights or blinks when the lamp does not light. |

B Remote Control



The remote control allows you to operate the function keys on the projector and to emulate mouse function when the projector is connected to a computer.

| Main Unit | Function |
|-------------------|--|
| Power | To turn the projection lamp on and off. |
| Freeze | Pressing this button displays a still (frozen) picture. |
| Magnify | Pressing this button partially magnifies a displayed picture. (Move the picture with the Disk Pad after pressing the Magnify button.) |
| Disk Pad | When the OSD menu is active, Disk Pad acts as ▲ ▼ selecting device. When the on-screen menus are not active, it works as mouse pad. When the magnify function is active, use disk pad to move through the picture. |
| Menu | Call the OSD Menu. To enter sub pages. To select items. |
| Blank | The blank screen is displayed by pressing Blank. And the blank screen will be revealed partially from top to bottom by pressing Blank again. |
| Source | Selects the input source. |
| Mute | Mutes the sound. |
| Volume | Adjusts volume. The sound gets louder or quieter by pressing the "+" or "-" button. |
| Laser | Laser pointer on button. Use as a stick (for indication). |
| Mouse Left-Click | When operating in mouse emulation mode, it registers a left mouse click. (bottom button) |
| Mouse Right-Click | When operating in mouse emulation mode, it registers a right mouse click. |
| Exit | To leave current OSD Pages. |
| ◀ ▶ Drag | To move Left/Right among OSD items. |

Inserting Batteries in the Remote Control

Be sure to follow instructions in placing batteries into the remote control units.

- Push and slide the lid in the direction of the arrow.
- Install two 'AAA' batteries as indicated inside the battery compartment.
- Replace the lid and snap into place.



Caution

- Avoid exposing the remote to excessive heat and humidity.
- Do not mix new and old or different types of batteries.



FixYourDLP.com

Sponsored by DM

Discount-Merchant.com (800) 281-8860

THE TRUSTED SOURCE FOR PROJECTOR LAMPS AND ACCESSORIES

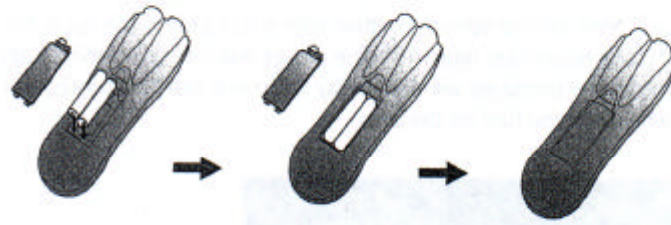

Figure 14 Battery replacement process

Remote Control Range

The remote sensors are located on the front and back of the unit. It can function in a range 50 degrees horizontal and 30 degrees vertical relative to a line that is a right angle to the remote sensor. The distance between the remote control and remote sensor must be shorter than four meters (13 feet).

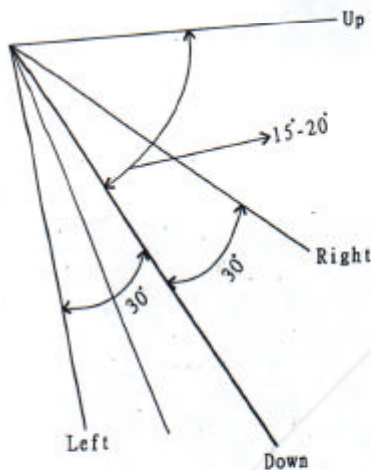

Figure 15 Range

Usage and Replacement of Lamp

The light source lamp has a limited service life.

The picture will become dark or the color will fade after the lamp has been used for a long time. In such cases, continued use of the lamp could cause a malfunction. Replace the lamp with a new one.

A Lamp/temperature Status LED Indicator

i. Lamp in excess of service hours

When the LED light is a continuous red, it means the lamp has exceeded (*1500) service hours. After this light appears, it is advisable to replace the projection lamp as soon as possible.

"CHANGE THE LAMP, AND RESET THE LAMP TIMER" will be displayed on the screen if the lamp has been operated for 1200 hours (see figure 16).

ii. "CHANGE THE LAMP, THE POWER WILL TURN OFF AFTER 20 HOURS" will be displayed on the screen if the lamp has been operated for 1479 hours. The "20" will count down (see figure 17).

- iii. "CHANGE THE LAMP!" will blink on the screen together with a red LED if the lamp has been operated for more than (*1500) hours (see figure 18). The power will turn off automatically after 10 minutes. All three of the above messages will not display for more than 3 minutes, but each message will be displayed whenever you turn on the lamp.

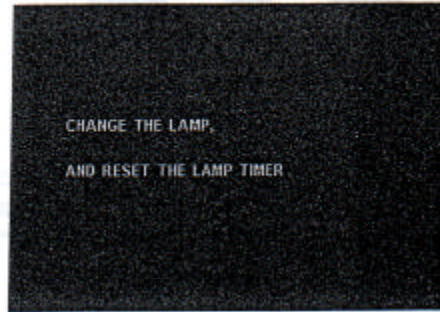

Figure 16 Lamp replacement warning signal

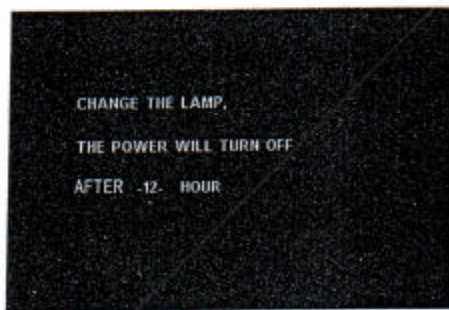

Figure 17 Lamp replacement warning signal II



Figure 18 Lamp replacement warning signal II

2. Normal status

If the LED light is off, it means the lamp and temperature inside the projector are normal.

3. Lamp is not well attached

If the LED blinks rapidly, it indicates that the lamp is not attached properly.

4. Temperature is too high

If the projector's internal temperature is too hot to operate safely, the LED will blink slowly for one minute and then the lamp will turn off automatically.

Caution:
The lamp indicator will light when the lamp becomes too hot. Turn off the power and let the projector cool for 45 minutes, then turn it on again. If the indicator is still shining, contact your dealer.

B Replacing the Lamp

Replacing the lamp

When replacing the lamp, turn off the projector and unplug the AC cord. Wait 45 minutes so that the lamp can cool. High-pressure lamp when hot, may explode if improperly handled.

 **Caution:**

- *Dispose of used lamps in accordance with local authorities.*
- *As the lamp is made of glass, do not apply shocks to it or scratch it.*
- *Also, do not use an old lamp, as this could cause the lamp to explode.*
- *If it seems that the lamp has exploded (for example, an explosive sound is heard), disconnect the power cord from the outlet and ask your dealer to replace the lamp. The lamp is covered by a front glass panel and an air-tight structure, but, in rare cases, the reflector and the inside of the projector may be damaged by scattered, broken pieces of glass, which could cause injury while being handled.*

- Turn the main power switch off and disconnect the power cord from the outlet.
- Remove the lamp cover.
 - If hot, the lamp could cause burns. Wait for about 45 minutes until lamp has cooled down.
 - Loosen lamp cover screw and remove the cover.
- Loosen the lamp retaining screw and pull the handle to remove the lamp.
 - If the screw is not loosened completely, you could hurt your fingers.
 - Do not insert your hand into the box after the lamp has been removed. (There are optical parts inside that, if touched, could result in color unevenness, etc.)
- Replace the lamp with a new one and secure it using the same screw.
 - Firmly tighten the lamp screw. Loose screws could result in a poor connection, which could cause the unit to malfunction.
- Install the lamp cover and secure it using a screw.
 - To prevent burns, install the lamp cover and secure it using the screw.
 - Do not turn on power with lamp cover removed.
 - Whenever the lamp is replaced, reset the total operation time of the lamp. Do not reset if the lamp has not been replaced.

Lamp Replacement Guide

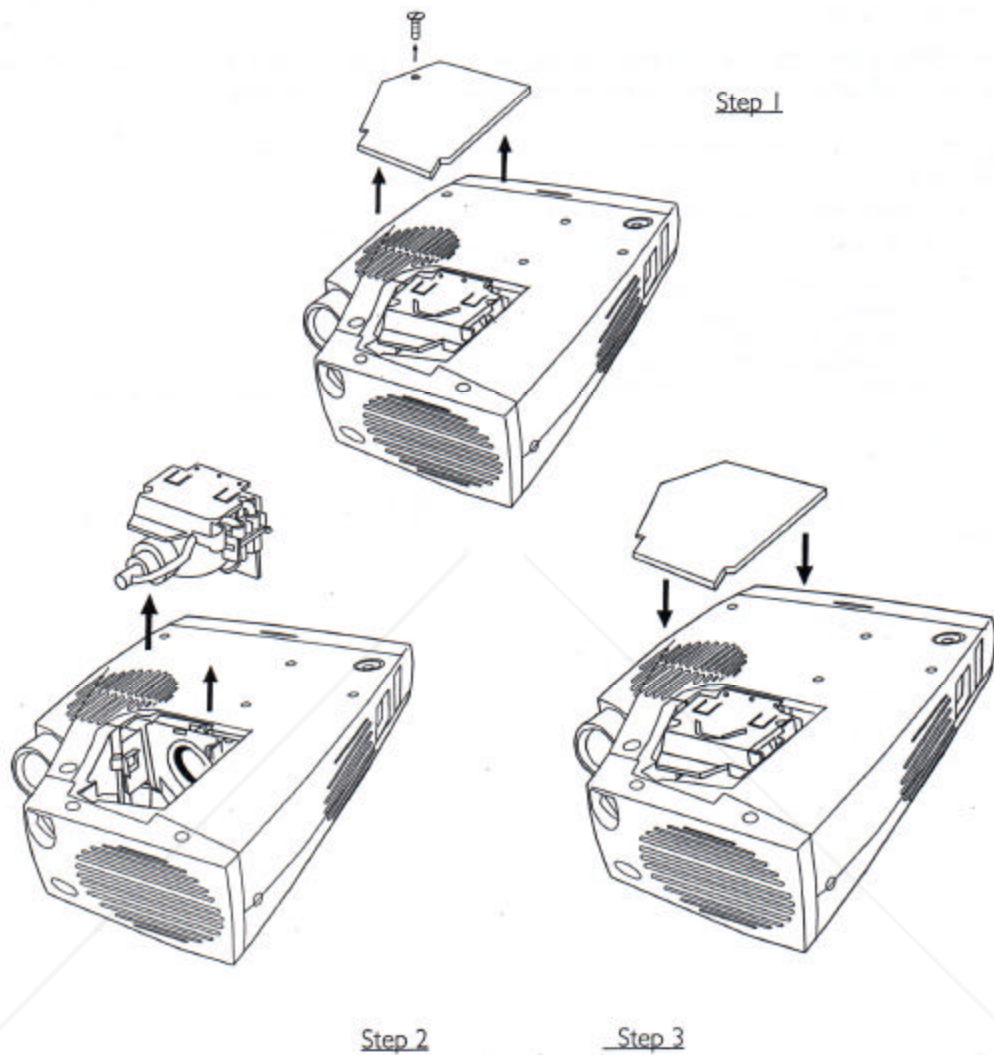





Figure 19 Lamp replacement: Step 1, Step 2, Step 3

Resetting Lamp Timer

If replacing the lamp after 1500 hours of operation, please carry out the following operation within 10 minutes of powering on.

| OSD | FUNCTION |
|---|--|
|  | <p>Press the Exit button on the projector for 3 seconds or the Exit button on the remote control for 3 seconds and display the total lamp usage time.</p> |
|  | <p>Press the Menu button on the projector or the remote control while the lamp usage time is being displayed, and the lamp hour display will be active and adjustable.</p> |
|  | <p>Select the "Reset" item on the screen using the ◀ ▶ buttons or on control pad or remote. Lamp Hours Used/Reset</p> |

OSD

Main OSD Menu

Press the "Menu" key and the main OSD menu structure will appear as shown at right (Fig. 23). Whenever Video Module is attached, 4 subpages appear in the menu: Display page, Image page, Control page, and Source page. However if input is from PC and no Video Module is attached, Source will disappear in the menu.

Press the "Menu" key again to enter Display page items, or press "◀" or "▶" to select sub-pages. (The main OSD menu will automatically disappear if a key is not pressed within 10 seconds).

Press the "Exit" button to leave the current sub-page, and press the button again to leave the main OSD menu (at the same time the settings are saved).

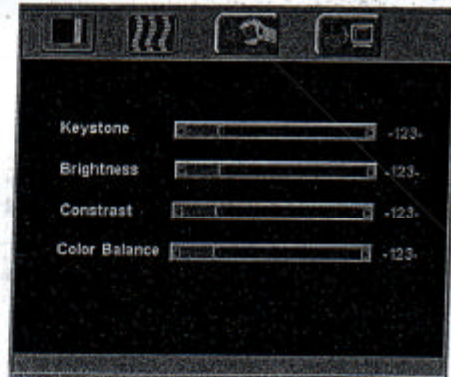

Input status PC input without Video Module PC input with Video Module Video input with Video Module

| | | | |
|---------|---------|---------|---------|
| Subpage | Display | Display | Display |
| | Image | Image | Image |
| | Control | Control | Control |
| | | Source | Source |

A Display Page

When a PC is the input source, there will be only four items on this page: Keystone, Brightness, Contrast, and Color Balance (Fig. 21). On the other hand, when the input source are video, S-video, TV or CATV, there will be other 4 items on this page: Keystone, Brightness, Contrast, and Sharpness (Fig.22).

Press the "Menu" button again to scroll through the items; press "◀" or "▶" to adjust the item scale, or press the "Exit" button to go back to the main OSD page.

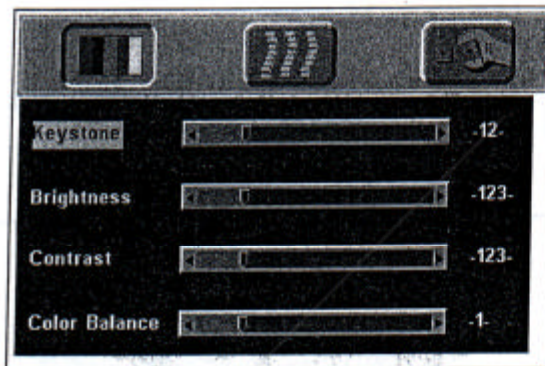

Fig.21 Display sub-page when the input source is PC(with/out Video Module)

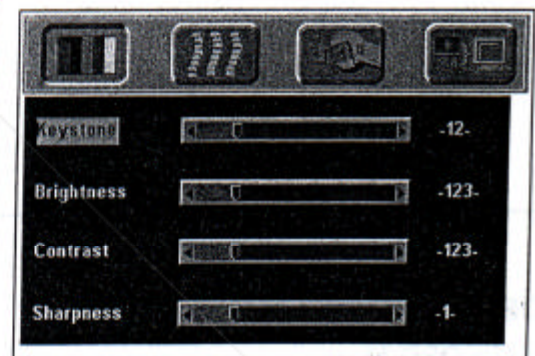
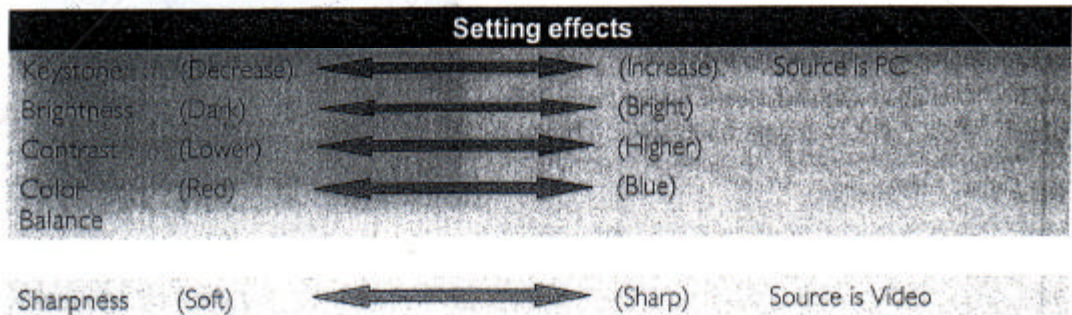

Figure 22 Display sub-page when the input source is video, s-video ,TV or CATV



B Image Page

Select the Image sub-page and the first item, "Auto Resize" will be highlighted. There are five items on this page: Auto Resize, H. Phase, H. Size, H. Position, and V. Position (Fig. 23).

If Video Module is attached and the input is from Video other instead of PC, another different IMAGE sub-page including Image Ratio, System, Color and Tint will come out as figure 24.



Figure 23 Image sub-page.... Only available when the input signal is PC



Figure 24 Image sub-page – Only available when the input signal is from video, S-video

Setting effects

Auto Resize When Auto Resize is on, the projector determines the best fit of the image to the screen.

H. Phase If flicker occurs on a projected image, users may try to adjust the H. Phase manually.

H. Size If the projected image is too wide or too narrow for the screen, users may turn Auto Image off and adjust the H. Size manually to fit the screen size.

H. Position (move the image left)  (move the image right)
The Auto Image should be turned off to activate the H. Position item. Position adjustments are saved when the projector is power off.

V. Position (move the image down)  (move the image up)
Position adjustments are saved when the projector is power off.



FixYourDLP.com

Sponsored by

Image Ratio 4:3 (Normal) 16:9 (Wide)

Discount-Merchant.com (800) 281-8860

THE TRUSTED SOURCE FOR PROJECTOR LAMPS AND ACCESSORIES

| | | | |
|--------|---|--------|---------|
| System | To select the input video system standard. When an Video Module or tuner box is attached, the projector will automatically detect the video system. Users also can select desired video systems. When selecting system, the projector will detect the selected system simultaneously, and the OSD will still exit on the screen. The default setting of System is "Auto" (See Figure 29). | | |
| Color | (Less) | ←————→ | (More) |
| Tint | (Red) | ←————→ | (Green) |

Source is Video or S-Video

*Tint may not be adjusted with PAL/SECAM video signal input.

C Control Page

When users go into the Control sub-page, the first item, "Language," will be highlighted. There are five items on this page: Language, Mirror, Blank, Auto Off, and Reset (Fig. 25).

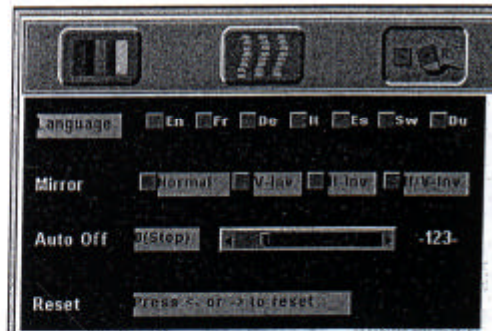

Figure 25 Control sub-page

| Setting effects | |
|-----------------|---|
| Language | To select the OSD menu language. Seven languages are supported: English, French, German, Italian, Spanish, Portuguese and Simplified Chinese (See Figure 25). |
| Mirror | To select Normal projection, H-Invert projection, V-Invert projection, or HV-Invert projection. |
| Blank | To select the background color when the image/sound is blanked. |
| Auto Off | To set the time to turn the power off after the start up screen is displayed and no signal is detected or sync is out of range. To select, use "←" or "→" to set the time. 0 means Auto Off function inactive. *Default setting is 0 (stop). |
| Reset | To reset display, image and control settings to factory settings. |

D Source Page

This Sub-page will only show up whenever Video Module is attached.

There are five items on this page: Source, Volume, Treble, Bass, and Mute.



FixYourDLP.com

Sponsored by DM

Discount-Merchant.com (800) 281-8860

THE TRUSTED SOURCE FOR PROJECTOR LAMPS AND ACCESSORIES

English 18

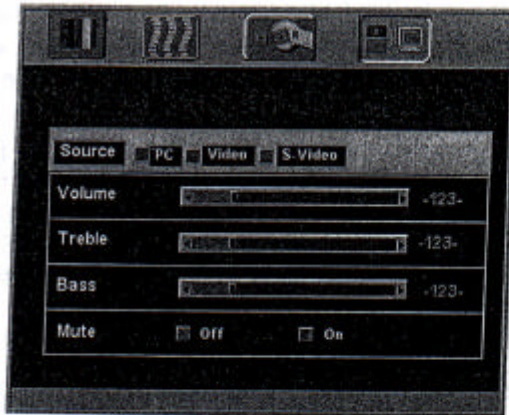





Figure 26 Source sub-page(Video Module attached)

| Items | Description |
|--------|--|
| Source | 3 input sources are available in the items when Video Module is connected to the projector: PC, Video, S-video |
| Volume | To set the volume level of speaker built in the Video Module. |
| Treble | To set the treble level of speaker built in the Video Module. |
| Bass | To set the bass level of speaker built in the Video Module. |
| Mute | To turn on/off the mute function. |

*The priority of input signal detection: a. PC b. S-Video c. Video

Other Correspondent Remote Functions and Messages

| OSD | FUNCTION |
|---|--|
|  <p>Source</p> | <p>The selected source will be displayed at the bottom right of the screen for 3 seconds after selecting the source. (PC, VIDEO, S-VIDEO).</p> |
|  <p>Freeze</p> | <p>The image will be frozen when the "Freeze" button is pressed. A " " mark appears at the lower right of the screen for 3 seconds during the freeze function. Furthermore, a "▶" mark appears at the lower right of the screen for 3 seconds when freeze is released. "Freeze" is released when the source button or the "Freeze" button is pressed again.</p> |
|  <p>Mute</p> | <p>Press the "Mute" button and the sound will be muted. There will be an OSD message as shown below: Press Mute again or the volume +/- buttons to turn off the mute.</p> |



Volume



Magnify

Laser

Disk Pad

Drag

Blank

Press volume + or - buttons to adjust the volume. The OSD message below will appear: (The message will disappear automatically 3 seconds after the volume is adjusted.)

By pressing the magnify "+" button, the center of the picture can be magnified. Press the button again, and the image will be further magnified (to a maximum of 4X). Press the magnify "-" button, and the size of the magnified image will be reduced by 50 percent. To return to the normal display mode, press the "Return" button.

Press this button to generate the laser beam.

If users connect the PS2 (ADB) mouse cable on the projector with the PC/Notebook (Macintosh/ Powerbook) mouse port, the disk pad will be able to function as a PC/Notebook (Macintosh/ Powerbook) mouse. When an image has been magnified, press the "Disk Pad" button to move around the display area (the mouse function is not available when magnify function is on).

This button is a toggle switch to turn on/off the drag function of the remote mouse.

Press this button to activate or release the blank function.

Maintenance and Troubleshooting

4

A Lamp Replacement

Refer to Page 11

B Cleaning the Lens

Follow these steps to clean the projection lens:

1. Apply a non-abrasive camera lens cleaner to a soft, dry cleaning cloth (abrasive cleaners, solvents or other harsh chemicals might scratch the lens).
2. Lightly wipe the clean cloth over the lens.
3. Affix the lens cover whenever the projector is not in use.

Note: Avoid using an excessive amount of cleaner.

C Troubleshooting

| PROBLEMS | TRY THESE SOLUTIONS |
|---|--|
| NO POWER | <ul style="list-style-type: none"> ✓ Plug the power cord into the AC Inlet. ✓ Plug the power cord into the power Inlet. ✓ Wait two minutes after the projector has been turned off before turning the projector back on. |
| NO PICTURE | <ul style="list-style-type: none"> ✓ Check that you have selected the proper input source. ✓ Ensure all cables are connected properly. ✓ Adjust the brightness and contrast. ✓ Remove the lens cap. ✓ Is the POWER indicator flashing? ✓ Is the STATUS indicator flashing? |
| IMAGE ISN'T SQUARE ON THE SCREEN | <ul style="list-style-type: none"> ✓ Reposition the unit to improve its angle on the screen. ✓ Is the vertical offset properly corrected using the keystone function? |
| POOR COLOR | <ul style="list-style-type: none"> ✓ Select the correct video system. ✓ Adjust brightness, contrast, or saturation. |
| IMAGE IS BLURRED | <ul style="list-style-type: none"> ✓ Adjust the focus. ✓ Reposition the unit to improve its screen angle. ✓ Ensure the distance between the unit and screen is within the adjustment range of the lens. |
| REMOTE CONTROL DOESN'T WORK | <ul style="list-style-type: none"> ✓ Replace the batteries with new ones. ✓ Make sure there is no obstacle between the remote control |



FixYourDLP.com

Sponsored

IMAGE IS BLURRED

Discount-Merch.com (800) 281-8860

THE TRUSTED SOURCE FOR PROJECTOR LAMPS AND ACCESSORIES

| | |
|-----------------|---|
| | and the unit. ✓ Stand within 4 meters (13 feet) of the unit. ✓ Make sure nothing is blocking the receiver on the control pad. |
| NO SOUND | ✓ Check audio cable connection from audio input source. ✓ Adjust audio source. ✓ Press "Volume" (+) button. ✓ Press "Mute" button. |

Specifications

5

A Optical

DMD™ 1-chip 0.7" DMD™ (Digital Micromirror Device)

Lens Manual zoom ,manual focus
(F=2.8 to 3.1 f=31 to 40)

Lamp mercury lamp 150W

Image size 32.4 to 140

Projection Distance 1.5 to 5 M

Contrast Ratio 200:1

B Electrical

Inputs RGB(H:31.47 to 68.70 kHz V:56.25 to 85.00 Hz)

Video (NTSC/PAL/SECAM/NTSC 4.43)

Color Reproduction Full color, 16.7 million colors simultaneously.

Power Requirement 100 to 240 VAC, 50 to 60 Hz

C Mechanical

Dimensions 24.5 cm (L) × 6.2 cm (H) × 19.8 cm (W)

Net Weight 2.27 kg/5.0 lb.

Operational Temperature projector: 10 to 40°C

Remote control

D Preset Display Resolution Table

| Resolution | H Sync (kHz) | V Sync (kHz) | Remark |
|------------|--------------|--------------|-----------|
| 640x350 | 31.5 | 70.1 | |
| 640x400 | 37.9 | 85.1 | VESA |
| 720x400 | 31.5 | 70.0 | |
| 720x400 | 37.9 | 85.1 | VESA |
| 640x480 | 31.5 | 60.0 | VESA |
| 640x480 | 37.9 | 72.8 | VESA |
| 640x480 | 35 | 66.7 | Macintosh |
| 640x480 | 43.3 | 85.0 | VESA |
| 800x600 | 35.2 | 56.3 | VESA |
| 800x600 | 37.9 | 60.3 | VESA |
| 800x600 | 46.9 | 75.0 | VESA |
| 800x600 | 48.1 | 72.2 | VESA |
| 800x600 | 53.7 | 85.1 | VESA |
| 832x624 | 49.7 | 74.5 | Macintosh |
| 1024x768 | 48.4 | 60.0 | VESA |
| 1024x768 | 56.5 | 70.1 | VESA |
| 1024x768 | 60.0 | 75.0 | VESA |
| 1024x768 | 68.7 | 85.0 | VESA |
| 1280x1024 | 64.0 | 60.0 | VESA |

Appendix

Guideline to DS2/DX2 Video Module

I. Features and Connection

AV Connection Port

This box is compatible with RCA input, S-Video input, audio output .

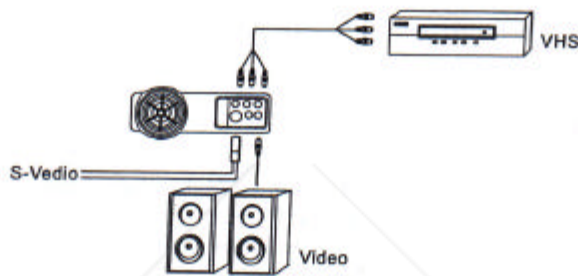

Figure 27 Connection of Video Module

| | |
|--------------|--|
| Speaker | |
| RCA Jack | For Video and Audio Input from VHS or V8 |
| S Video Port | For S-Video Input |
| Phone Jack | For Video input/Output |

*Video Module is sold separately and is not included in the standard configuration of accessories in the unit. Please contact the dealer nearest you need the box or visit the Peripherals, Inc. Web site for more information.

AV Control Pad

| | |
|-------------|--------------------------|
| Source | Select the source |
| Volume up | Turn the volume upward |
| Volume down | Turn the volume downward |

A Connecting the Box

Please follow the instruction here to place the Video Module:

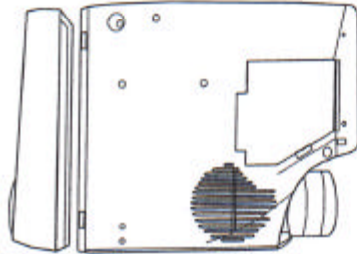

Figure 28 Bottom View of AV box

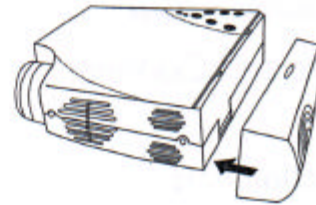
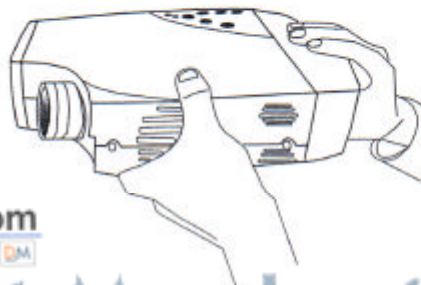
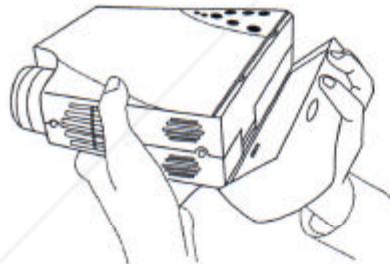

Figure 29 Side View of AV box

To attach the Video Module to the unit :



1. Precisely place the two chocks at the lower surface of the Video Module into the lower slots in the correspondent position in the projector.
2. Slowly push the box to fit the unit and, meanwhile, insert the box plug into the A/V connector closely.
3. Plug in the correct cord into the correspondent jack or port to perform A/V function.
4. Select inputs by pressing "Source" key, and select channel by the channel up or down keys.



Discount-Merchant.com (800) 281-8860
THE TRUSTED SOURCE FOR PROJECTOR LAMPS AND ACCESSORIES

proxima

Own your audience.

S A L E S B R I E F

ULTRALIGHT DX2

ultraportable XGA value



KEY FEATURES

- **ultraportable** - at just five pounds, it offers the ultimate in portability without sacrificing important features
- **detailed images** - XGA (1024 x 768) resolution, with scaling to SXGA provides clarity and support for PCs and Macs
- **flexible installation** - 1.3:1 zoom and focus make set up easy anywhere in the room
- **crisp, sharp images** - Digital Light Processing technology from Texas Instruments and 1000 ANSI lumens provide clear images
- **affordable DLP** - high resolution images, ultraportability, and features at a value price
- **free replacement** - two years of free ProXchange service for extra security

Reasons to Buy the DX2

| vs. Compaq MP1800 | vs. InFocus LP335 | vs. Epson 710c |
|---|--|--|
| <ul style="list-style-type: none"> • DX2 is brighter than the MP1800 • DX2 offers better video compatibility with a standard video module • DX2 includes an advanced remote with laser pointer for easy presentation control | <ul style="list-style-type: none"> • DX2 uses a more powerful 1.3:1 zoom lens for easy set up and positioning • DX2 lamp life is longer than the LP335 | <ul style="list-style-type: none"> • DX2 offers DLP technology for crisp, sharp images • DX2 uses a more powerful 1.3:1 zoom lens for easy set up and positioning • DX2 supports more input sources than the 710c • DX2 is smaller and lighter than the 710c |

| | Proxima DX2 | Compaq MP1800 | InFocus LP335 | Epson 710c |
|-------------------------------|--|--|---|---|
| TECHNOLOGY | Single-chip DLP | Single-chip DLP | Single-chip DLP | 0.9 Poly-Silicon TFT; Active-matrix |
| RESOLUTION | XGA (1024 x 768) | XGA (1024 x 768) | XGA (1024 x 768) | XGA (1024 x 768) |
| SUPPORTED RESOLUTIONS | VGA, SVGA, XGA, SXGA | VGA, SVGA, XGA, SXGA | VGA, SVGA, XGA, 1080i HDTV | VGA, SVGA, XGA, SXGA, UXGA |
| BRIGHTNESS | 1000 ANSI Lumens | 700 ANSI Lumens | 1000 ANSI Lumens | 1000 ANSI Lumens |
| LENS | 1.3:1 manual zoom and focus | 1.3:1 manual zoom and focus | 1.25:1 manual zoom lens | 1.2:1 manual zoom and focus |
| INPUT SOURCES | 1 composite, 1 S-video, 1 computer, 1 audio | 1 computer (analog), 1 computer (digital), 1 S-video, 1 composite, 1 audio | 1 composite, 1 S-video, 1 computer, 1 audio | 1 computer, 1 video |
| OUTPUT SOURCES | PS/2 | USB | PS/2, USB | 1 mouse |
| DIMENSIONS (H x W x L) | 3.2 x 8.25 x 10 in (8.0 x 20.9 x 25.4 cm) | 8.25 x 2.5 x 9 in (20.95 x 6.35 x 22.9 cm) | 2.5 x 8.75 x 9.75 in (6.35 x 22.23 x 24.77 cm) | 8.4 x 10.5 x 3.5 in (21.3 x 26.7 x 8.9 cm) |
| WEIGHT | 5.2 lb. (2.4 kg) | 4.6 lb. (2.1 kg) | 4.8 lb. (2.18kg) | 5.8 lb. (2.6 kg) |
| AUDIO | 2-watt mono | yes | 1-watt mono | 1-watt mono |
| VIDEO COMPATIBILITY | NTSC, NTSC 4.43, PAL, PAL-N, PAL-M, SECAM | N/A | Full NTSC, NTSC 4.43, PAL, SECAM | NTSC, NTSC 4.43, NTSC 5.0, PAL, PAL-M, PAL-N, PAL-60, SECAM |
| POWER CONSUMPTION | 150 watt (1,500 hours) | 120 watt | 120 watt (1,000 hours) | 120 watt (2,000 hours) |
| CONTRAST RATIO | 250:1 (full-on, full-off) | 400:1 (full-on, full-off) | 400:1 (full-on, full-off) | 350:1 (full-on, full-off) |
| REMOTE CONTROL | remote with mouse control and laser pointer | standard remote control | standard remote control | standard remote control |



FixYourDLP.com

Sponsored by

CONTRAST RATIO

DiscountMerchant.com (800) 281-8860

THE TRUSTED SOURCE FOR PROJECTOR LAMPS AND ACCESSORIES

Main Office: 1420 Carroll Park Drive, San Diego, CA 92108-2091
 (Tel) 619.457.5500, (Fax) 619.457.9647, 888.PROXIMA (U.S. and Canada)
 European Office: 1, rue de la Gare, 13010 Fos (France)
 N-602 Fredrikstad, Norway, (Tel) +47 69 54 01 55, (Fax) +47 69 54 06 52

www.proxima.com

7/00 730-0084-2
 DX2 sales brief.qxd



Q&A

What are the top five features and benefits of the Proxima UltraLight DX2?

- XGA (1024 x 768) resolution, with scaling to SXGA provides highly detailed images and supports all popular PCs and Macs.
- 1.3:1 zoom and focus ensure flexible positioning anywhere in the room.
- 1000 ANSI lumens make it perfect for meeting rooms and small conference rooms.
- Digital Light Processing™ technology from Texas Instruments for photo-realistic images and film-like video.
- Advanced remote with integrated laser pointer and mouse control allows easy presentation control.
- Includes two years of free ProXchange service and 90-day lamp warranty.

What advantages does the Proxima UltraLight DX2 have over the competition?

- Bright, at 1000 lumens and just five pounds, the DX2 is lightweight without sacrificing features.
- DLP™ technology offers exceptional image and video presentations.
- The DX2 comes standard with a modular video component that can be removed for data-only presentations, providing even more portability.

How do I sell the Proxima UltraLight DX2 against the Compaq MP1800, InFocus LP335, and Epson 710c?

Against the Compaq MP1800:

- At 1000 ANSI lumens, the DX2 is brighter than the Compaq MP1800.

Against the InFocus LP335:

- The DX2 is as bright as the InFocus LP335.
- The DX2 includes a more powerful 1.3:1 zoom lens, ensuring flexible positioning anywhere in the room.
- The DX2 also offers PS/2 output and a full-featured remote control with integrated laser pointer.
- The DX2's lamp life is longer than the InFocus LP335, providing a much lower cost of ownership.

Against the Epson 710c:

- The DX2 uses DLP technology from Texas Instruments, ensuring a higher quality image and film-like video.
- The DX2 offers a more powerful 1.3:1 zoom lens, ensuring flexible positioning anywhere in the room.
- The DX2 offers more inputs than the Epson 710c, making connections to multiple sources easier and more intuitive.
- The DX2 is smaller and almost a pound lighter than the Epson 710c, making it a better ultraportable solution.



proxima

Own your audience.



ULTRALIGHT DX2

the brightest of the lightest

ULTIMATE PORTABILITY

all the features you need
in a five-pound package

THE DLP™ DIFFERENCE

displays photo-realistic color
and smooth video

FREE REPLACEMENT

two years of free ProXchange
service for extra security



MODULAR VIDEO

lighten your load even more
when you don't need video

DAZZLING DETAIL

XGA resolution provides the
image detail and compatibility
you need

ZOOM IN

position the DX2 anywhere
and zoom in or out

PROXIMA ULTRALIGHT® DX2 FEATURES

Making high-impact presentations on the go just got easier and more affordable, with Proxima's UltraLight DX2. Now you can deliver high-resolution data and video images from a sleek projector that weighs just five pounds. The UltraLight DX2 has all the features you need for your portable presentations and small meetings, at a price that's very attractive.

- at just five pounds, it offers the utmost in portability without sacrificing important features
- bright enough for meeting rooms and small conference rooms at 1000 ANSI lumens
- zoom lens offers flexibility in set up, letting you position the projector where you want it and adjust the image size accordingly
- XGA (1024 x 768) resolution lets you display your most detailed images with clarity, and provides compatibility with a wide range of computers
- Digital Light Processing™ technology from Texas Instruments produces photo-realistic images and film-like video
- modular video component offers the flexibility to connect to a video source or to remove the component when displaying computer images only, for the lightest load possible
- includes easy to use remote control with laser pointer and soft carrying case
- comes with 90-day lamp warranty and two years of free ProXchange™ service, for overnight projector replacement in the unlikely event your DX2 is in need of repair
- an affordable and stylish solution for corporate presenters, meeting go-ers, consultants, and professionals who display detailed data or video images

WHAT'S INCLUDED

MODEL DX2 INCLUDES:

- Remote control with mouse control and laser pointer
- U.S. and international power cords
- Product documentation
- Computer VGA cable, computer mini-plug to mini-plug audio cable, Mac adapter, AV cable, S-video cable
- Soft carrying case
- Lens cap

[Presentation solutions]

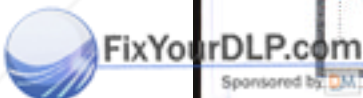

Sponsored by 

Discount-Merchant.com (800) 281-8860

THE TRUSTED SOURCE FOR PROJECTOR LAMPS AND ACCESSORIES

DX2 TECHNICAL SPECIFICATIONS

| | |
|---------------------------------------|--|
| Native Resolution | • XGA (1024 x 768) |
| Resolution Supported | • VGA (640 x 480), SVGA (800 x 600), XGA (1024 x 768), SXGA (1280 x 1024) |
| Brightness | • 1000 ANSI lumens |
| Brightness Uniformity | • > 75% |
| Contrast Ratio | • 250 to 1 |
| Computer Compatibility | • IBM PC or compatibles Apple Macintosh |
| Video Compatibility | • NTSC, NTSC 4.43, PAL, PAL-N, PAL-M, SECAM |
| Display Technology | • single chip DLP |
| Number of Colors | • 16.7 million colors |
| Input Sources | • 1 composite video, 1 S-video |
| I/O Interface | • PS/2 |
| H-Sync Range | • 31-85 kHz |
| V-Sync Range | • 55-90 Hz |
| Bandwidth | • up to 140 MHz |
| Keystone Correction (Digital) | • ± 7° |
| Projection Lens | • focal length: 31 to 40 mm, F 2.8 to 3.1 |
| Projection Distance | • 4.9 ft. to 16.4 ft. (1.5 m to 5 m) |
| Zoom | • 1.3:1 manual zoom |
| Aspect Ratio | • 4:3 |
| Image Size (diagonal) | • 1.2 ft. to 11.5 ft. (0.4 m to 3.5 m) |
| Throw Ratio (dist. to image diagonal) | • 1.75-2.27:1 |
| Projection Method | • front/rear, desktop/ceiling |
| Audio | • 2 watt mono |
| Remote Control | • Full function remote with mouse control and laser pointer |
| Lamp (Life) | • 150 watt (1,500 hours) |
| Dimensions | • 8.25 in. W x 10.0 in. L x 3.2 in. H 20.9 cm W x 25.4 cm L x 8.0 cm H (base unit only) |
| Weight | • 5.2 lbs. (2.4 kg) |
| Power Consumption | • 250 watts |
| Power Requirements | • 100 to 240V at 50/60 Hz |
| Operating Temperature | • 50° to 104° F (10° to 40° C) |
| On-Screen Menu Languages | • English, French, Spanish, Portuguese, German, Italian, Chinese |
| Audible Noise | • < 40 db |
| Approvals | • FCC Class B, UL, c-UL, CE, TUV |
| Warranty | • two years on parts and labor • 90 days limited on lamp • two years of ProXchange replacement service |

UltraLight DX2 Set Up

Position the UltraLight DX2 anywhere in the room.

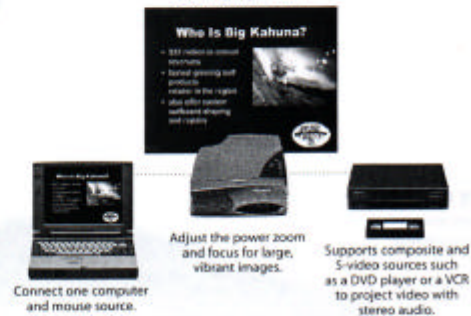

ORDERING INFORMATION

Model Number

DX2 For worldwide use

Optional Accessories

| | |
|----------|---------------------------------|
| CASE-002 | Carry-on rolling soft case |
| CASE-162 | Compact rolling hard case |
| CASE-163 | Deluxe rolling hard case |
| A650 | 50 in. portable tabletop screen |
| LAMP-022 | 150 watt lamp |

DX2 PROJECTION DISTANCES / IMAGE SIZES

| Projection Distance | Image Size (Diagonal) | | |
|---------------------|-----------------------|------------|-------------|
| | Minimum | Maximum | |
| 4.9' | 1.5 m | 2.7' 0.8 m | 3.5' 1.1 m |
| 6.6' | 2 m | 3.6' 1.1 m | 4.7' 1.4 m |
| 8.2' | 2.5 m | 4.5' 1.4 m | 5.9' 1.8 m |
| 9.8' | 3 m | 5.4' 1.7 m | 7.0' 2.1 m |
| 11.5' | 3.5 m | 6.3' 1.9 m | 8.2' 2.5 m |
| 13.1' | 4 m | 7.2' 2.2 m | 9.4' 2.9 m |
| 14.8' | 4.5 m | 8.1' 2.5 m | 10.5' 3.2 m |
| 16.4' | 5 m | 9.0' 2.8 m | 11.7' 3.6 m |

proxima

Own your audience

Main Office: 9440 Carroll Park Drive, San Diego, CA 92121
(858) 452-5900, FAX (858) 452-9847, (800) 447-7692 (U.S. and I)

European Office: K.G. Meldahlsvli 13, Postboks 1205
N-664 Fredrikstad, Norway, (Int) +47 69 34 01 55, (Ext) +47 69 34 06 37

www.proxima.com
www.presentersuniversity.com

Proxima and Proxima UltraLight are registered trademarks and ProXchange is a trademark of Proxima Corporation. Other trademarks are property of their respective owners. ©2000 Proxima Corporation. All rights reserved. Specifications are subject to change without notice. 8/02 100-0001-1 D02 04/02 01/02

FixYourDLP.com
Sponsored by DJM

Discount-Merchant.com (800) 281-8860
THE TRUSTED SOURCE FOR PROJECTOR LAMPS AND ACCESSORIES

MOBILE
ULTRALIGHT

proxima

www.proxima.com
1.888.PROXIMA

PRESENTATION SOLUTIONS

ULTRALIGHT DX2
UltraLight Projectors



Disclaimer

This user manual is provided as a free service by FixYourDLP.com. FixYourDLP is in no way responsible for the content of this manual, nor do we guarantee its accuracy. FixYourDLP does not make any claim of copyright and all copyrights remain the property of their respective owners.

About FixYourDLP.com

FixYourDLP.com (<http://www.fixyourdpl.com>) is the World's #1 resource for media product news, reviews, do-it-yourself guides, and manuals.

Informational Blog: <http://www.fixyourdpl.com>

Video Guides: <http://www.fixyourdpl.com/guides>

User Forums: <http://www.fixyourdpl.com/forum>

FixYourDLP's Fight Against Counterfeit Lamps:

<http://www.fixyourdpl.com/counterfeits>

Sponsors:

RecycleYourLamp.org – Free lamp recycling services for used lamps:

<http://www.recycleyourlamp.org>

Lamp Research - The trusted 3rd party lamp research company:

<http://www.lampresearch.com>

Discount-Merchant.com – The worlds largest lamp distributor:

<http://www.discount-merchant.com>



FixYourDLP.com

Sponsored by 