



Disclaimer

This user manual is provided as a free service by FixYourDLP.com. FixYourDLP is in no way responsible for the content of this manual, nor do we guarantee its accuracy. FixYourDLP does not make any claim of copyright and all copyrights remain the property of their respective owners.

About FixYourDLP.com

FixYourDLP.com (<http://www.fixyourdlp.com>) is the World's #1 resource for media product news, reviews, do-it-yourself guides, and manuals.

Informational Blog: <http://www.fixyourdlp.com>

Video Guides: <http://www.fixyourdlp.com/guides>

User Forums: <http://www.fixyourdlp.com/forum>

FixYourDLP's Fight Against Counterfeit Lamps:

<http://www.fixyourdlp.com/counterfeits>

Sponsors:

RecycleYourLamp.org – Free lamp recycling services for used lamps:

<http://www.recycleyourlamp.org>

Lamp Research - The trusted 3rd party lamp research company:

<http://www.lampresearch.com>

Discount-Merchant.com – The worlds largest lamp distributor:

<http://www.discount-merchant.com>



FixYourDLP.com

Sponsored by 

UltraLight™ LS1

powered to go places

LIGHT AND DURABLE
with its magnesium alloy housing

FREQUENT-FLYER PORTABILITY
at just 8.4 pounds

POWER ZOOM AND FOCUS
make it easy to position the LS1 anywhere in the room

BIG BRIGHT IMAGES
700 ANSI lumens for a clear and crisp display

LONG LAMP LIFE
(2,000 hours) means lower maintenance cost and fewer worries



actual size: 8.5 in (W) x 12.4 in (L) x 4.3 in (H)

LASER F/X™ REMOTE CONTROL
puts you in control of your projector and your computer

ULTRALIGHT LS1

To have the winning edge in your next presentation, look to the Proxima UltraLight LS1 multimedia projector. Selected by *PC World* editors as the Best Projection System of '99, the LS1 offers big-projector features in a small, affordable package. You can count on the image quality, set-up flexibility, and durability of the award-winning UltraLight LS1 to ensure an unbeatable presentation wherever you go.

- exceptional image quality with 700 ANSI lumens of brightness, for lights-on presentations in any room
- broad range of compatibility with PC desktops, portables, Apple Macs and PowerBooks
- supports full-screen images from any notebook with VGA (640 x 480), SVGA (800 x 600) or XGA (1024 x 768) resolution
- magnesium alloy enclosure is both lightweight and extra durable, so it stands up to the rigors of the road
- 1.6:1 power zoom lens allows you to set up the LS1 anywhere in the room and adjust the image size accordingly
- Proxima's Laser F/X™ remote control with built-in laser pointer and mouse control puts you in command of the projector and your computer

 **FixYourDLP.com**
Sponsored by 

Discount-Merchant.com (800) 281-8860

THE TRUSTED SOURCE FOR PROJECTOR LAMPS AND ACCESSORIES

PROXIMA®
MULTIMEDIA PROJECTORS

PC WORLD
WORLD CLASS
Best Projection System



UltraLight LS1

UltraLight LS1 Set Up

Position the UltraLight LS1 anywhere in the room.

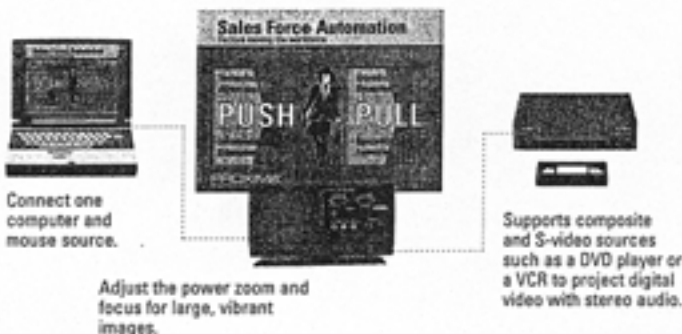

LS1 Projection Distances/Image Sizes

Projection Distance	Image Size (Diagonal)				
	Minimum		Maximum		
4.3'	1.3 m	1.7'	0.5 m	2.9'	0.9 m
8.2'	2.5 m	3.5'	1.1 m	5.4'	1.7 m
16.4'	5 m	6.8'	2.1 m	11.0'	3.3 m
24.6'	7.5 m	10.2'	3.1 m	16.4'	5.0 m
32.8'	10 m	13.7'	4.2 m	21.3'	6.7 m
3'	12 m	16.4'	5.0 m	26.3'	8.0 m

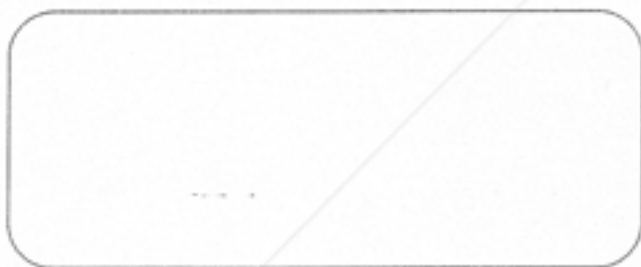

PROXIMA®
MULTIMEDIA PROJECTORS

Office: 3499 Central Expressway, San Diego, CA 92121-2298,
Tel: 619-444-1100, Fax: 619-444-1101, 1-800-441-1032 (U.S. and Canada)

Sponsored by **IBM**
European Office: K.G. Meldalshveit 3, Postboks 1403,
N-1602 Fredrikstad, Norway, +47 69 34 01 95, FAX +47 69 34 06 32

www.proxima.com

www.proxima.com

LS1 is a registered trademark of Proxima Corporation. UltraLight and Laser Fix are trademarks of Proxima Corporation. Other trademarks are the property of their respective owners. ©1999 Proxima Corporation. All rights reserved. Specifications are subject to change without notice. Lumen and lamp life may vary depending on lamp manufacturer.

08/99 709-00642-4 LS1 datasheet.qxd

WHAT'S INCLUDED

Model LS1 includes:

- Laser F/X remote control with laser pointer
- U.S. and international power cords
- Product documentation
- Computer VGA cable, computer mini-plug to mini-plug audio cable, Mac ada PC and Mac control cables, AV cable, S-video cable
- Soft carrying case for projector and portable PC
- Lens cap

ORDERING INFORMATION

Model Number

LS1

For worldwide use

Optional Accessories

CASE-001	Carry-on rolling soft case
CASE-032	Carry-on rolling hard case (checkable/shippable)
CASE-033	Carry-on deluxe rolling hard case (checkable/shippable)
A650	50" portable tabletop screen
L26	120-watt UHP lamp

TECHNICAL SPECIFICATIONS

Display Technology	• 0.9" polysilicon TFT LCD x 3
Resolution	• SVGA (800 x 600)
Resolution Supported	• VGA (640 x 480) • SVGA (800 x 600) • XGA (1024 x 768, with Fit-to-View® intelligent digital scaling)
Number of Colors	• 16.7 million colors
Brightness	• 700 ANSI lumens (peak)
Contrast Ratio	• 100:1 ANSI; 200:1 full-on, full-off
Computer Compatibility	• IBM PC, PS/2, Pentium and compatibles • Apple Macintosh, Power Mac, PowerBook
Video Compatibility	• NTSC, NTSC 4.43, PAL, SECAM
Input Sources	• 1 computer, 1 video, 1 S-video, 1 audio (stereo)
H-Sync Range	• 15-80 kHz
V-Sync Range	• 50-100 Hz
Dot Clock	• 130 MHz
Horizontal Resolution	• 750 TV lines
Aspect Ratio	• Std: 4:3 - Wide: 16:9
Image Size (Diagonal)	• 1.7 ft. to 26.3 ft. (0.5 m to 8.0 m)
Projection Lens	• Motorized zoom lens 1.6:1 ratio • Focal length: 36 mm to 57.6 mm, f/2.3-3.0
Projection Distance	• 4.3 ft. to 39.3 ft. (1.3 m to 12 m)
Keystone Correction	• 11°
Projection Method	• front/rear, desktop/ceiling
Lamp (Life)	• 120 watt UHP (2,000 hours)
Audio	• 1 watt mono
Remote Control	• Proxima Laser F/X remote with mouse control and laser pointer
Dimensions	• 8.5 in. W x 12.4 in. L x 4.3 in. H 21.5 cm W x 31.5 cm L x 10.9 cm H
Weight	• 8.4 lb. (3.8 kg)
Power Consumption	• 190 watts
Power Requirements	• 110V-240V at 50 Hz/60 Hz auto change
Operating Temperature (Sea Level)	• 41-95° F (5-35° C)
On-Screen Menu Languages	• English, Japanese, German, French, Italian, Spanish
Audible Noise	• <47db
Approvals	• FCC Class A (U.S.); UL, C-UL (Canada); CE (E.U.)
Warranty	• Two years on parts and labor (excluding lamp)

Discount-Merchant.com (800) 981-8860

THE TRUSTED SOURCE FOR PROJECTOR LAMPS AND ACCESSORIES



PROXIMA®
ULTRALIGHT LS1

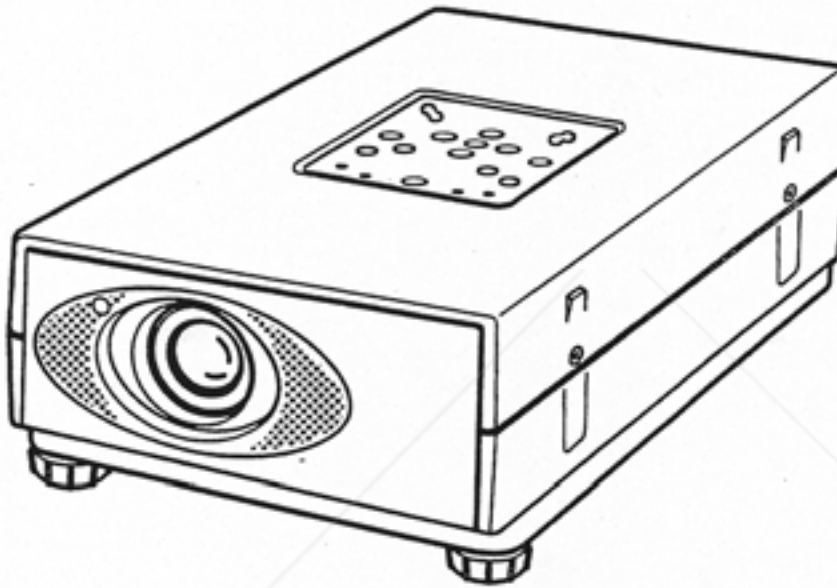

- PRESENTATIONS
- WORKING SESSIONS
- TRAINING
- MULTIMEDIA
- ANIMATION
- VIDEO

 **FixYourDLP.com**
Sponsored by 

Discount-Merchant.com (800) 281-8860

THE TRUSTED SOURCE FOR PROJECTOR LAMPS AND ACCESSORIES

INFORMATION TO THE USER

NOTE: This equipment has been tested and found to comply with the limits for a Class A digital device, pursuant to Part 15 of the FCC Rules. These limits are designed to provide reasonable protection against interference when the equipment is operated in a commercial environment. This equipment generates radio frequency energy, and can radiate radio frequency energy and, if not installed and used in accordance with the user's guide, may cause harmful interference to radio communications. Operation of this equipment in a residential area is likely to cause harmful interference in which case the user will be required to correct the interference at his own expense.

TO THE OWNER

As the owner of a ULTRALIGHT LS1, you are probably eager to try out your new projector. Before you do, we suggest that you spend a little time reading this guide to familiarize yourself with the operating procedures, so that you will receive maximum satisfaction from the many features included in your new projector. This user's guide will acquaint you with your projector's features. Reading it will help us too. Through the years we have found that many service requests were not caused by problems with our projectors. They were caused by problems that could have been prevented, if the owner had followed the instructions in the guide. You can often correct operating problems yourself. If your projector fails to work properly, see the "TROUBLESHOOTING" section on pages 47 - 48 and try the solutions marked for each problem.

SAFETY PRECAUTIONS

WARNING:

TO REDUCE THE RISK OF FIRE OR ELECTRIC SHOCK, DO NOT EXPOSE THIS APPLIANCE TO RAIN OR MOISTURE.

This Projector has a grounding-type AC line plug. This is a safety feature to be sure that the plug will fit into the power outlet. Do not try to defeat this safety feature.

Intense light source. Do not stare directly into the projection lens as possible eye damage could result. Be especially careful that children do not stare directly into the beam.

If the Projector will not be used for an extended time, unplug the Projector from the power outlet.

READ AND KEEP THIS USER'S GUIDE FOR LATER USE.



CAUTION

**RISK OF ELECTRIC SHOCK
DO NOT OPEN**



CAUTION: TO REDUCE THE RISK OF ELECTRIC SHOCK, DO NOT REMOVE COVER (OR BACK). NO USER-SERVICEABLE PARTS INSIDE. REFER SERVICING TO QUALIFIED SERVICE PERSONNEL.



THIS SYMBOL INDICATES THAT DANGEROUS VOLTAGE CONSTITUTING A RISK OF ELECTRIC SHOCK IS PRESENT WITHIN THIS UNIT.



THIS SYMBOL INDICATES THAT THERE ARE IMPORTANT OPERATING AND MAINTENANCE INSTRUCTIONS IN THE USER'S GUIDE WITH THIS UNIT.

IMPORTANT SAFETY INSTRUCTIONS

All the safety and operating instructions should be read before the product is operated.

Read all of the instructions given here and retain them for later use. Unplug this projector from AC power supply before cleaning. Do not use liquid or aerosol cleaners. Use a damp cloth for cleaning.

Do not use attachments not recommended by the manufacturer as they may cause hazards.

Do not place this projector on an unstable cart, stand, or table. The projector may fall, causing serious injury to a child or adult, and serious damage to the projector. Use only with a cart or stand recommended by the manufacturer, or sold with the projector. Wall or shelf mounting should follow the manufacturer's instructions, and should use a mounting kit approved by the manufacturer.

Do not expose this unit to rain or use near water... for example, in a wet basement, near a swimming pool, etc...

Slots and openings in the back and bottom of the cabinet are provided for ventilation, to insure reliable operation of the equipment and to protect it from overheating.

The openings should never be covered with cloth or other material, and the bottom opening should not be blocked by placing the projector on a bed, sofa, rug, or other similar surface. This projector should never be placed near or over a radiator or heat register.

This projector should not be placed in a built-in installation such as a bookcase unless proper ventilation is provided.

This projector should be operated only from the type of power source indicated on the marking label. If you are not sure of the type of power supplied, consult your authorized dealer or local power company.

Do not overload wall outlets and extension cords as this can result in fire or electric shock. Do not allow anything to rest on the power cord. Do not locate this projector where the cord will be abused by persons walking on it.

Never push objects of any kind into this projector through cabinet slots as they may touch dangerous voltage points or short out parts that could result in a fire or electric shock. Never spill liquid of any kind on the projector.

Do not attempt to service this projector yourself as opening or removing covers may expose you to dangerous voltage or other hazards. Refer all servicing to qualified service

- d. If the projector does not operate normally by following the operating instructions. Adjust only those controls that are covered by the operating instructions as improper adjustment of other controls may result in damage and will often require extensive work by a qualified technician to restore the projector to normal operation.
- e. If the projector has been dropped or the cabinet has been damaged.
- f. When the projector exhibits a distinct change in performance-this indicates a need for service.

When replacement parts are required, be sure the service technician has used replacement parts specified by the manufacturer that have the same characteristics as the original part. Unauthorized substitutions may result in fire, electric shock, or injury to persons.

Upon completion of any service or repairs to this projector, ask the service technician to perform routine safety checks to determine that the projector is in safe operating condition.



This projector is equipped with a grounding type AC line plug. Should you be unable to insert the plug into the outlet, contact your electrician. Do not defeat the safety purpose of this grounding type plug.

Follow all warnings and instructions marked on the projectors.

For added protection to the projector during a lightning storm, or when it is left unattended and unused for long periods of time, unplug it from the wall outlet. This will prevent damage due to lightning and powerline surges.



An appliance and cart combination should be moved with care. Quick stops, excessive force, and uneven surfaces may cause the appliance and cart combination to overturn.

If the projector is to be built into a compartment or similarly enclosed, the minimum distances must be maintained. Do not cover the ventilation slot on the projector. Heat build-up can reduce the service life of your projector, and can also be dangerous.



FixYourDLP.com

Sponsored by DJM

Unplug this projector from wall outlet and refer servicing to qualified service personnel under the following conditions:

- a. When the power cord or plug is damaged or frayed.
- b. If liquid has been spilled into the projector.
- c. If the projector has been exposed to rain or water.

TABLE OF CONTENTS

	PAGE		Page
FEATURES AND DESIGN	5	COLOR SYSTEM SELECT (Video)	29
ACCESSORIES	6	PICTURE IMAGE ADJUSTMENT (Video)	30
POWER REQUIREMENTS	6	PICTURE SCREEN ADJUSTMENT (Video)	31
DESCRIPTION	7	COMPUTER SYSTEM SELECT	32-3
SETTING-UP THE PROJECTOR	8-9	PICTURE IMAGE ADJUSTMENT (Computer)	34
POSITIONING	8	PICTURE POSITION ADJUSTMENT (Computer)	35
ROOM LIGHT	8	PC ADJUSTMENT	36-3
VENTILATION	8	AUTO IMAGE FUNCTION (Computer)	40
ADJUSTABLE FEET	9	PICTURE SCREEN ADJUSTMENT (Computer)	41
MOVING THE PROJECTOR	9	OTHER FUNCTION SETTING	42-4
CONNECTING THE PROJECTOR TO THE	10-15	Blue Back	42-4
CONNECTING THE COMPUTER	10-14	Display	42-4
IBM-compatible desktop computer connection	11	Ceiling	42-4
Macintosh desktop computer connection	12	Rear	42-4
IBM-compatible laptop computer connection	13	Lamp Age	42, 44
Macintosh PowerBook computer connection	14	AIR FILTER CARE AND CLEANING	45
CONNECTING THE VIDEO EQUIPMENT	15	TEMPERATURE WARNING INDICATOR	45
CONNECTING THE EXTERNAL AUDIO EQUIPMENT	15	LAMP REPLACEMENT	46
OPERATION OF CONTROLS	16-18	CLEANING THE LENS	47
TOP OF THE PROJECTOR	16-17	TROUBLESHOOTING	4
REAR OF THE PROJECTOR	18	TECHNICAL SPECIFICATIONS	
OPERATION OF REMOTE CONTROL	19-21		
REMOTE CONTROL BATTERY INSTALLATION	21		
USING REMOTE CONTROL	21		
CONTROL THE PROJECTOR	22-24		
DIRECT OPERATION	22		
MENU OPERATION	23-24		
BASIC OPERATION	25-44		
TURNING ON THE PROJECTOR	25		
TURNING OFF THE PROJECTOR	25		
DIRECT OPERATION	26		
MODE SELECT	26		
SOUND VOLUME ADJUSTMENT	26		
SOUND MUTE FUNCTION	26		
ZOOM ADJUSTMENT	26		
FOCUS ADJUSTMENT	26		
NORMAL PICTURE FUNCTION	26		
BLANK FUNCTION	26		
FREEZE PICTURE FUNCTION	26		
AUTO IMAGE FUNCTION	26		
MENU OPERATION	27-44		
MODE SELECT	27		
SOUND ADJUSTMENT	28		
LANGUAGE ADJUSTMENT	28		



FixYourDLP.com

Sponsored by BLANK FUNCTION

Discount-Merchant.com (800) 281-8860

THE TRUSTED SOURCE FOR PROJECTOR LAMPS AND ACCESSORIES

FEATURES AND DESIGN

This ULTRALIGHT LS1 is designed with the most advanced technology for portability, durability, and ease of use. The projector utilizes built-in multimedia features, a palette of 16.77 million colors, and active matrix liquid crystal display (LCD) technology.

Compatibility

This projector is compatible with many different types of personal computers and video devices, including:

SVGA (800 × 600), VGA (640 × 480, 720 × 400, 640 × 400)

MAC 12" (512 × 384), 13" (640 × 480), 16" (832 × 624)

XGA (1024 × 768)* / MAC 19"(1024 × 768)* -*projected with compress mode

Various video equipments using any of the world wide video standards, including; NTSC, NTSC4.43, PAL, and SECAM.

Image Resolution

Picture Image is projected in the resolution of 804 × 604. Screen resolutions between 800 × 600 and 1024 × 768 are compressed to 804 × 604.

This projector cannot display in the resolution more than 1024 × 768. If your computer's screen resolution is higher than 1024 × 768, reset the resolution to the lower before connecting the projector.

Portability

This projector is extremely compact in size and weight. Having a sophisticated shape like an attaché case with a retractable carrying handle, the projector will help you make powerful presentation wherever you go.

Screen Mode

Screen display can be selected among:

Computer mode	--- True, Digital zoom (Expand, Compress, Panning)
Video mode	--- Regular (4:3), Wide (16:9)

Multilanguage

MENU DISPLAY is displayed with:

English, Deutsch, Français, Italiano, Español, or Japanese

Automatic Multiscanning system

This projector can detect display signals from most personal computers currently distributed. It is free from complicated adjustments to project picture images from PC.

Motor Zoom / Focus Lens

Zoom and Focus of Lens can be controlled with Top Control and Remote Control.

Other Features

Reverse Display, Air Pad Remote Control

 FixYourDLP.com
Sponsored by 

Discount-Merchant.com (800) 281-8860

THE TRUSTED SOURCE FOR PROJECTOR LAMPS AND ACCESSORIES

ACCESSORIES

This projector contains following parts. When unpacking, make sure all of the parts listed below are included. If any part is missing, contact authorized dealer or service station.

- User's Guide.
- AC Power Cords (UL and European types).
- Remote Control Unit and batteries.
- Lens Cover.
- Carrying case.
- VGA Cable.
- VGA/MAC Adapter.
- Mouse Cable for PS/2 port.
- Mouse Cable for serial port.
- Mouse Cable for ADB port.
- S-video cable (Mini DIN-4 type).
- AV cable (RCA type × 3).
- PC audio cable (Stereo mini jack).

POWER REQUIREMENTS

Your projector uses nominal input voltages of 100-120 VAC or 200-240 VAC. The projector automatically selects the correct input voltage. It is designed to work with single-phase power systems having a grounded neutral conductor. To reduce the risk of electrical shock, do not plug into any other type of power system.

Consult your authorized dealer or service station if you are not sure of the type of power supply being in use.



CAUTION

For the safety, unplug the AC Power Cord when the appliance is not used.

When this projector is connected to the outlet with the AC Power Cord, the appliance is in Stand-by Mode and consumes a little electric power.

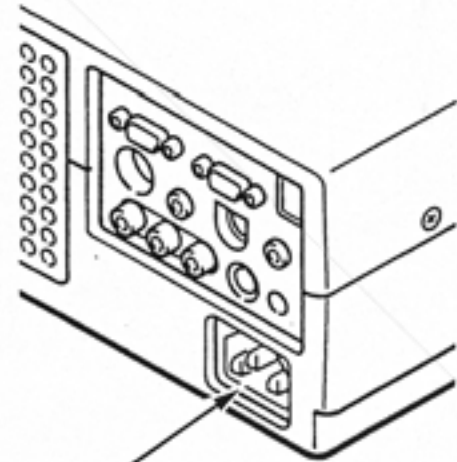

Projector side (Female)



AC outlet side (Male)



Connect the AC power supply cord (provided) to the projector.
The socket-outlet must be near this equipment and must be easily accessible.



FixYourDLP.com

TRADEMARKS

Discount-Merchant.com (800) 281-8860

- Apple, Macintosh, and PowerBook are trademarks or registered trademarks of Apple Computer, Inc.
- IBM and PS/2 are trademarks or registered trademarks of International Business Machines, Inc.
- Proxima is a registered trademark of Proxima Corporation.
- Other trademarks are the property of their respective owners.

THE TRUSTED SOURCE FOR PROJECTOR LAMPS AND ACCESSORIES

DESCRIPTION

FRONT

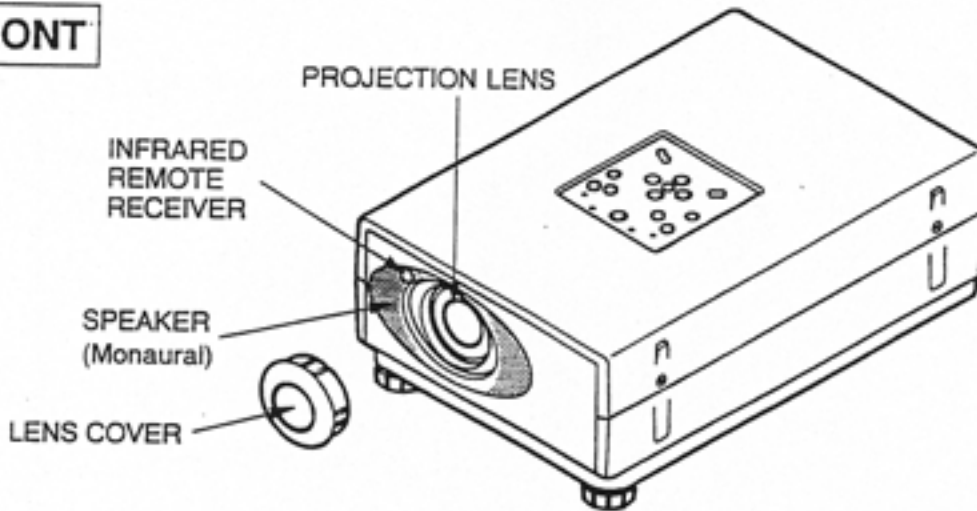

REAR

EXHAUST VENT



CAUTION

HOT AIR EXHAUSTED !

Air blown from the exhaust vent is hot. When using or installing the projector, following attention should be taken.

- Do not put a flammable object near this part. Keep heat-sensitive objects away from the exhaust part.
- Do not touch this part especially screws and metallic parts. This part will become hot while the projector is used.

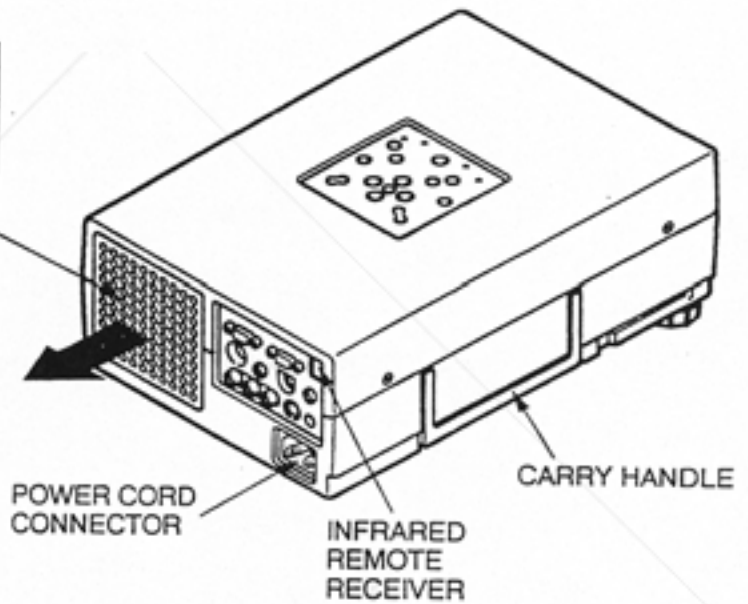

BOTTOM

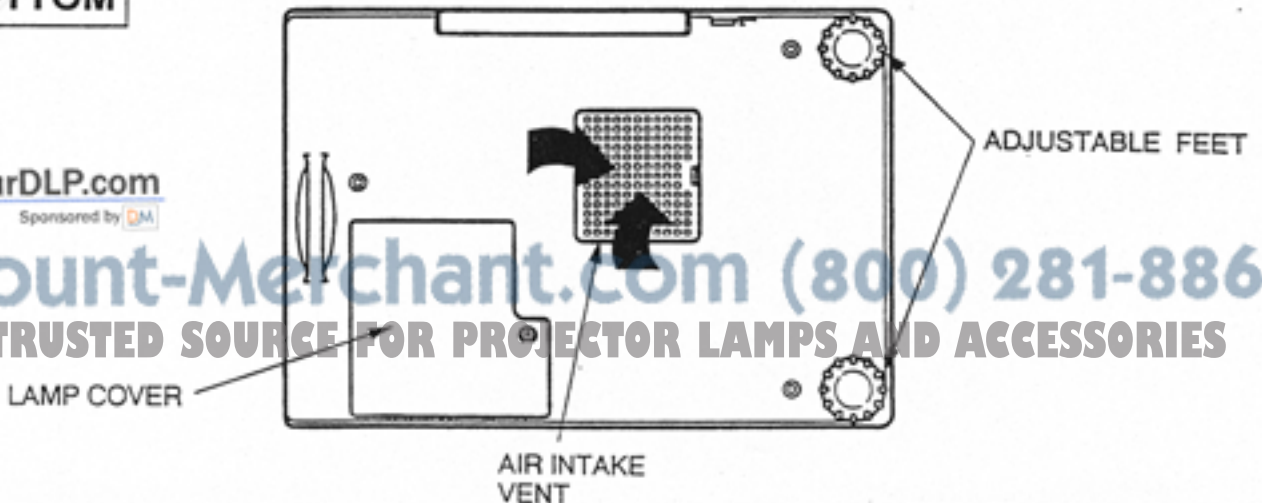

FixYourDLP.com
Sponsored by DM

Discount-Merchant.com (800) 281-8860

THE TRUSTED SOURCE FOR PROJECTOR LAMPS AND ACCESSORIES

SETTING-UP THE PROJECTOR

POSITIONING:

- This projector is basically designed to project on a flat projection surface.
- This projector can be focused from 3.6' (1.1m) - 37.7' (11.5m).
- Refer to the figure below to adjust the screen size.

ROOM LIGHT

The brightness of the room has a great influence on the quality of a picture. Dimming the lights can improve picture quality.

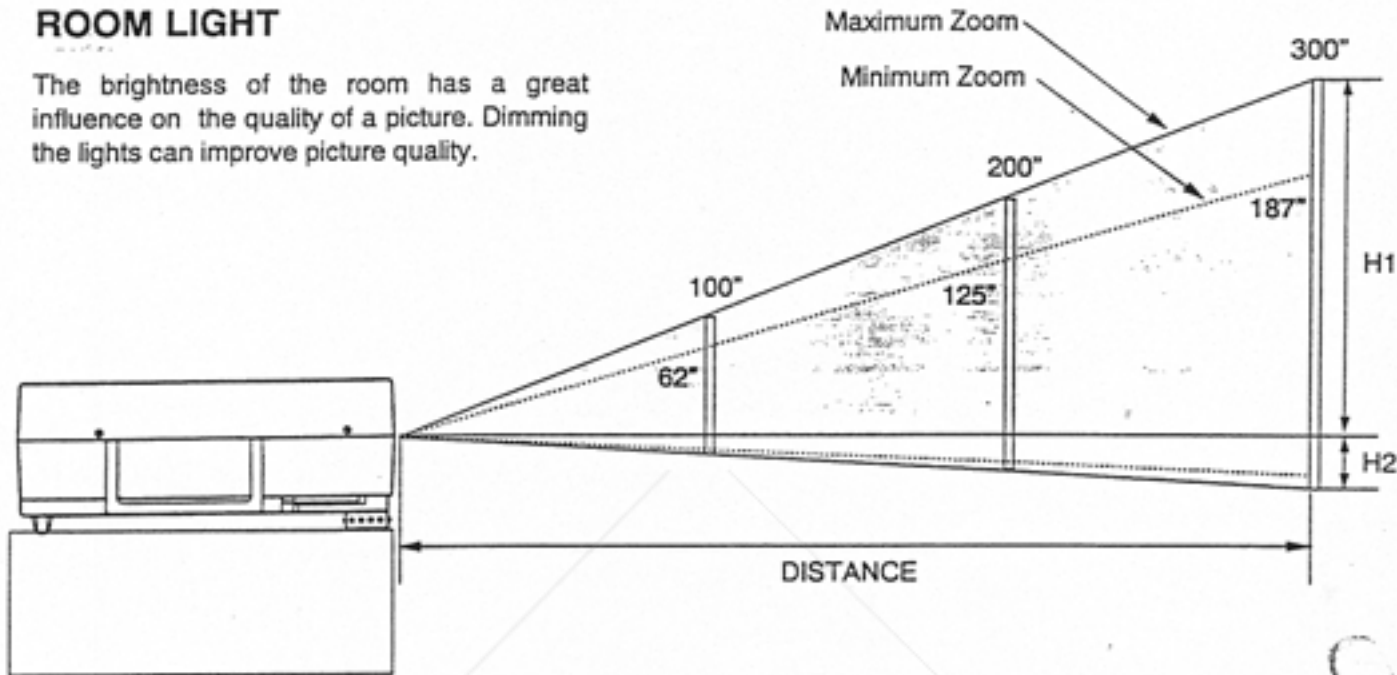

Screen Size	Max. Zoom	29°	60°	100°	150°	200°	300°
	Min. Zoom	18°	37°	62°	93°	125°	187°
Distance		3.6' (1.1 m)	7.5' (2.3 m)	12.5' (3.8 m)	18.7' (5.7 m)	24.9' (7.6 m)	37.7' (11.5 m)

Screen Size (W x H) inches	20°	60°	100°	150°	200°	300°
	16 x 12	49 x 36	80 x 60	120 x 90	160 x 120	240 x 180
Height (H1)	11.4" (290 mm)	34" (864 mm)	57" (1448 mm)	86" (2184 mm)	114" (2896 mm)	171" (4343 mm)
Height (H2)	0.6" (15 mm)	2" (50 mm)	3" (76 mm)	4" (102 mm)	6" (152 mm)	9" (229 mm)

VENTILATION

This projector is equipped with cooling fans to protect it from overheating. Pay attention to the following to ensure proper air flow and avoid possible risks of fire and malfunction.

- Do not cover the vent windows.
- Keep the rear grill at least one meter away from any object.
- Make sure that there are no object under the projector. An obstacle under the projector may prevent the projector from taking the cooling air through the bottom vent.



FixYourDLP.com

Sponsored by

DiscountMerchant.com 281-8860
THE TRUSTED SOURCE FOR PROJECTOR LAMP AND ACCESSORIES

ADJUSTABLE FEET

Picture tilt and projection angle can be adjusted by twisting ADJUSTABLE FEET. Projection angle can be adjusted 0 to 2° by rotating adjustable feet.

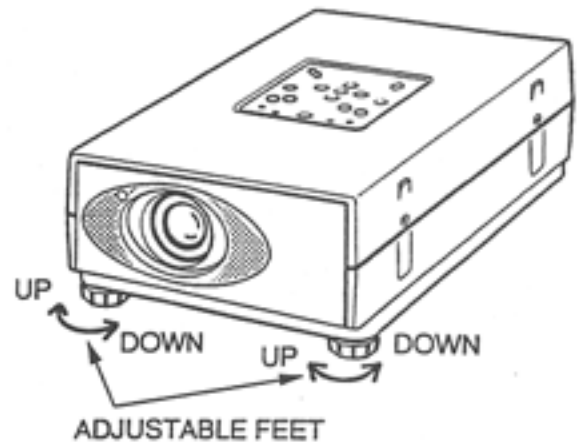
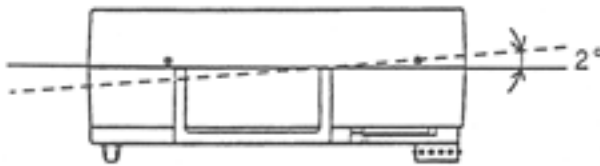

MOVING THE PROJECTOR

Use the carry handle when moving the projector.

- When moving the projector, replace the lens cover and rotate the feet fully clockwise (to shorten the feet) to prevent damage.

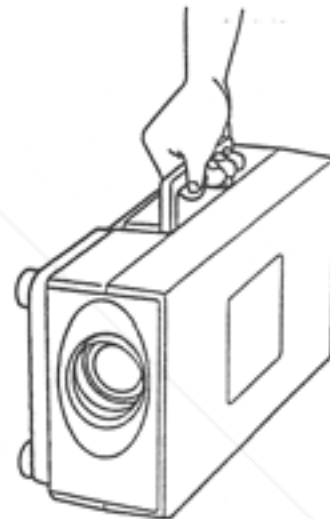

CAUTION IN CARRYING OR TRANSPORTING THE PROJECTOR

- Do not drop or give a shock to the projector, otherwise damages or malfunctions may result.
- When carrying the projector, use a Proxima recommended carrying case.
- Do not transport the projector by using a courier or transport service in an unsuitable transport case. This may cause damage to the projector. To transport the projector through a courier or transport service, use a Proxima recommended case.

For more information on transportation cases, contact a Proxima authorized dealer.

Sponsored by 

Discount-Merchant.com (800) 281-8860

THE TRUSTED SOURCE FOR PROJECTOR LAMPS AND ACCESSORIES

CONNECTING THE PROJECTOR

This projector has various kind of input/output terminals to connect with peripheral equipment. Connect the projector to the equipments before turning it on.

CONNECTING THE COMPUTER

CONNECTING TO THE COMPUTER INPUT HDB15-PIN (VGA) TERMINAL

A computer can be connected to the HDB15-pin terminal on the projector.

- Connect the computer to this terminal using the VGA cable and VGA/MAC adapter (supplied).

CONNECTING TO THE MONITOR OUTPUT HDB15-PIN (VGA) TERMINAL

This terminal outputs only computer input signal to the monitor.

A monitor can be connected to the HDB15-pin (VGA) terminal on the projector.

- Connect the monitor to this terminal using the monitor cable (not supplied).

CONNECTING TO THE COMPUTER AUDIO INPUT JACKS

- Connect audio outputs from your computer to the jacks using the audio cable.

CONNECTING TO THE MULTI-POLE 12-PIN (CONTROL PORT)

- If you wish to control the computer with projector's remote control unit, you must connect the control port (PS/2, Serial or ADB port) on your computer to the projector's control port with one of the supplied cables. (three type cables provided ; for PS/2 Port, Serial Port, and ADB Port)

CONTROL PORT CABLE REMOVAL HINT

Disconnect control port cable with following steps.

1. Hold the portion (A) of the connector with one hand.
2. Pull the portion (B) arrow direction and remove connector.

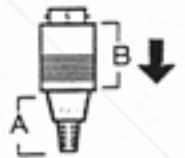

CONNECTING TO THE DIN 8 (SERIAL PORT) CONNECTOR

- If you control the projector by computer, you must connect a cable from your computer to this connector.

Serial Port
 FixYourDLP.com
 Sponsored by DM
 Discount-Merchant.com (800) 281-8860
 THE TRUSTED SOURCE FOR PROJECTOR LAMPS AND ACCESSORIES
 Pin 4, 5, 6, 7, 8
 Kodak Star

IBM-compatible desktop computer connection

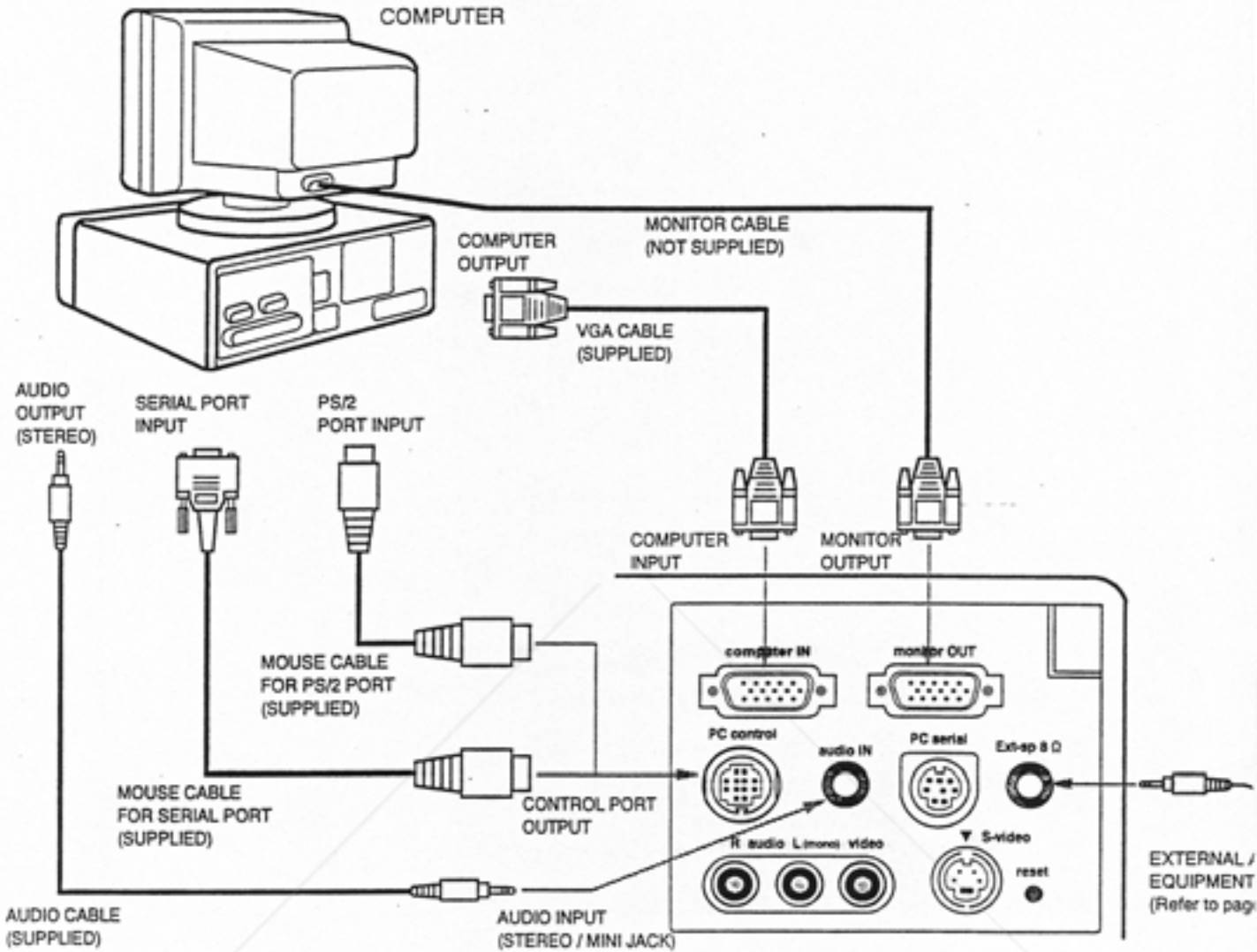

NOTE : When connecting the cable, the power cords of both the projector and the external equipments should be disconnected from AC outlet. Turn the projector and peripheral equipments on before the computer is switched on.

■ HDB 15-PIN TERMINAL (COMPUTER INPUT / MONITOR OUTPUT)

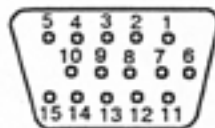

Pin No.	Signal
1	Red Input
2	Green Input
3	Blue Input
4	Sense 2
5	Ground (Horiz. sync)
6	Ground (Red)
7	Ground (Green)
8	Ground (Blue)
9	Non Connect
10	Ground (Vert. sync)
11	Sense 0
12	Sense 1
13	Ground (Horiz. sync)
14	Vert. sync.
15	Reserved

■ CONTROL PORT

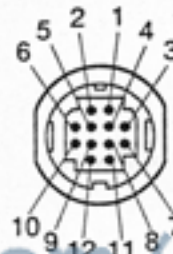

	PS/2 Port	Serial Port	ADB Port
1	---	---	---
2	---	---	---
3	---	---	---
4	GND	GND	GND
5	---	---	---
6	---	READY	---
7	---	---	---
8	---	RxD	---
9	---	---	---
10	DATA	---	---
11	CLK	---	ADB
12	---	TxD	---



FixYourDLP.com

Part No. / Signal
Sponsored by D.M.

Discount-Merchant.com (800) 281-8860
THE TRUSTED SOURCE FOR PROJECTOR LAMPS AND ACCESSORIES

Macintosh desktop computer connection

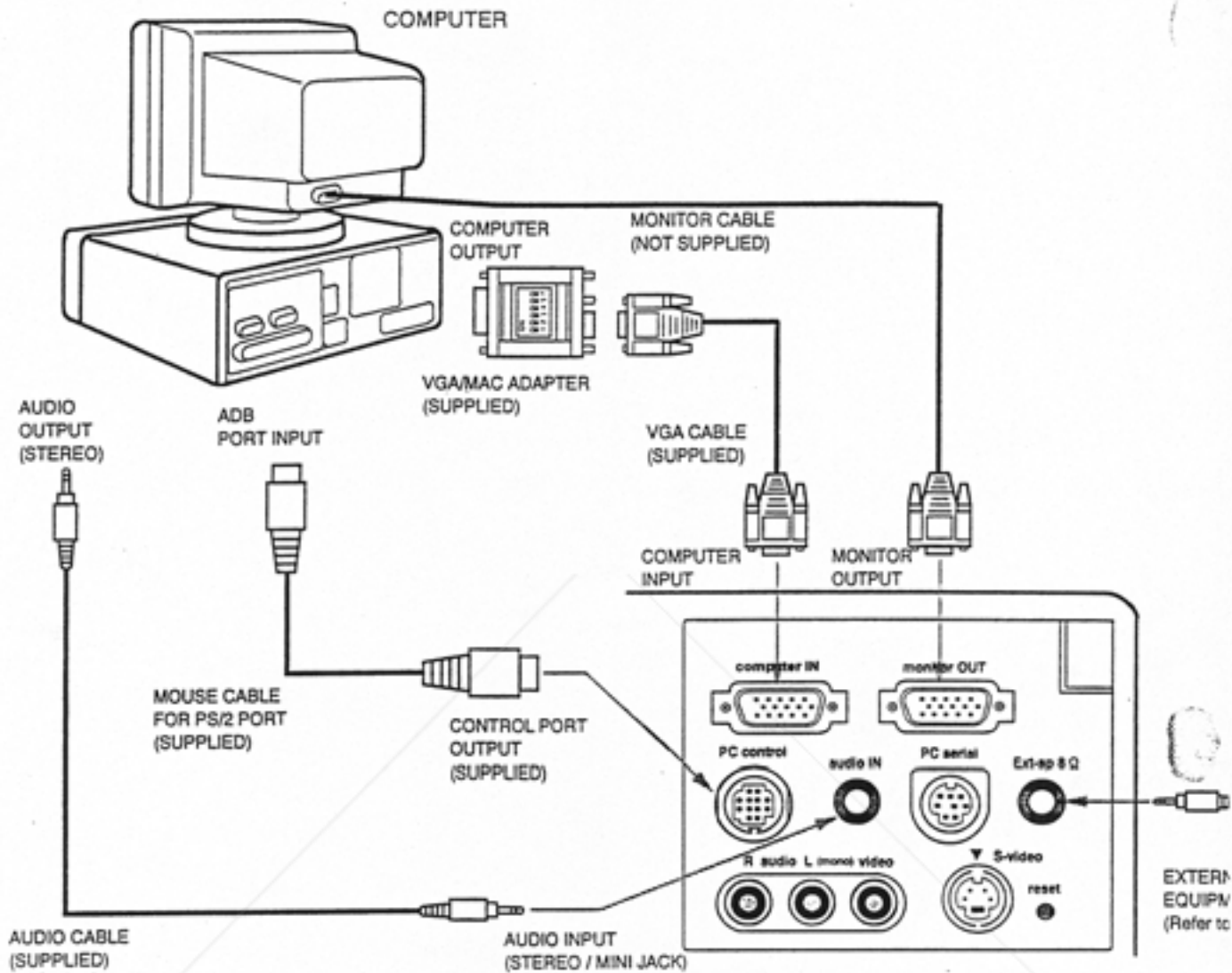

Set the slide switches as shown in the table below depending on the RESOLUTION MODE that you want to use before you turn on the projector and computer.

RESOLUTION MODE	SW1	SW2	SW3	SW4	SW5	SW6
13" MODE (640 × 480)	ON	ON	OFF	OFF	OFF	OFF
16" MODE (832 × 624)	OFF	ON	OFF	ON	OFF	OFF
Resolution MODE (1024 × 768)	OFF	ON	ON	OFF	OFF	OFF

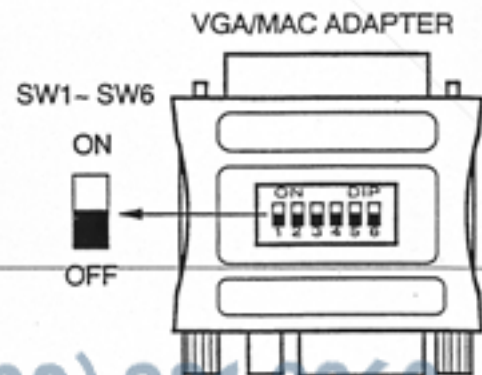

FixYourDL.com
 Discount-Merchant.com (800) 281-8860
 THE TRUSTED SOURCE FOR PROJECTOR LAMP AND ACCESSORIES

NOTE: When connecting the cable, the power cords of both the projector and the external equipments should be disconnected from AC. Turn the projector and peripheral equipments on before the computer is switched on.

IBM-compatible laptop computer connection

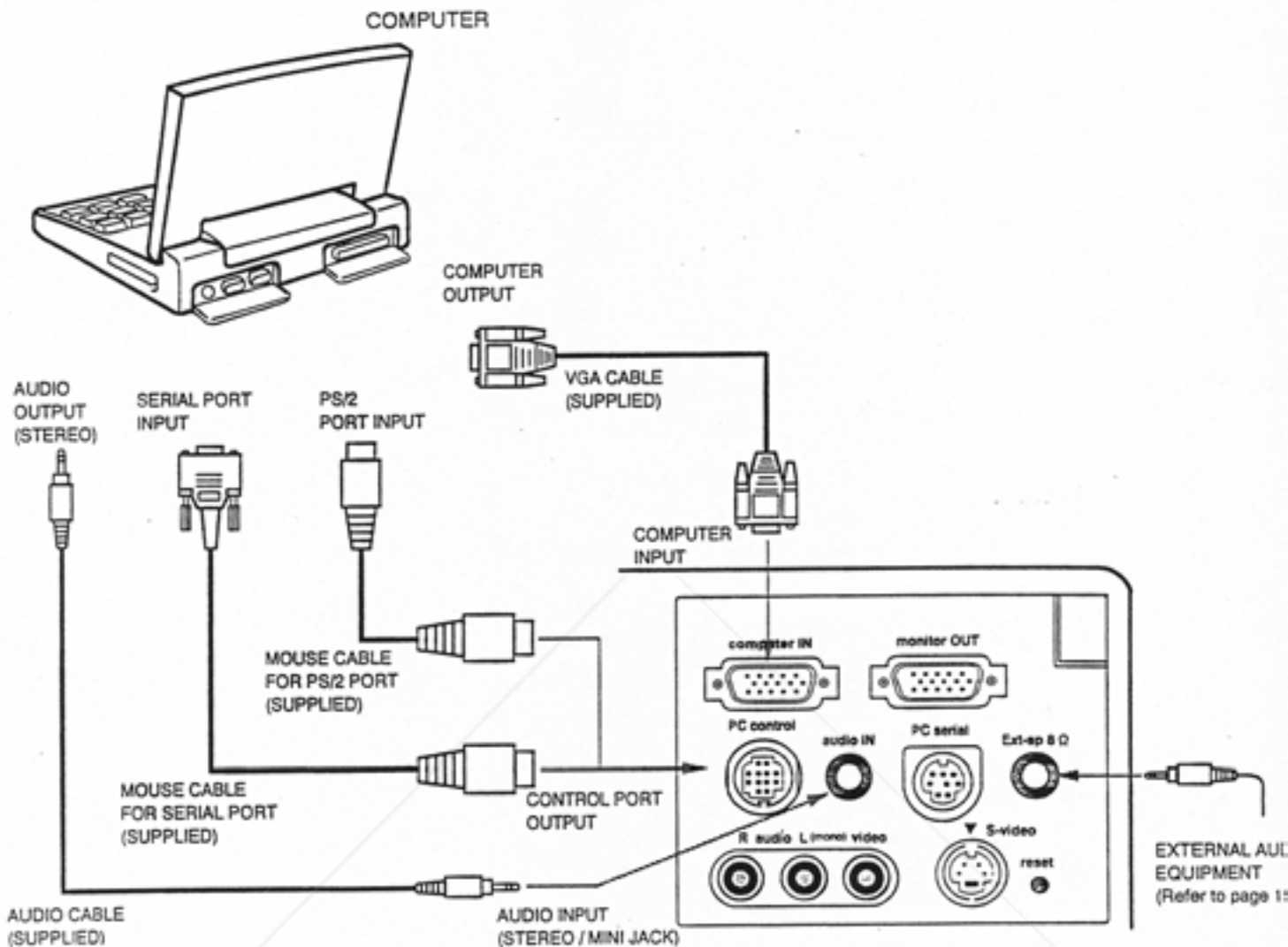

NOTE : When connecting the cable, the power cords of both the projector and the external equipments should be disconnected from AC outlet. Turn the projector and peripheral equipments on before the computer is switched on.

FixYourDLP.com
Sponsored by 

Discount-Merchant.com (800) 281-8860
THE TRUSTED SOURCE FOR PROJECTOR LAMPS AND ACCESSORIES

Macintosh PowerBook computer connection

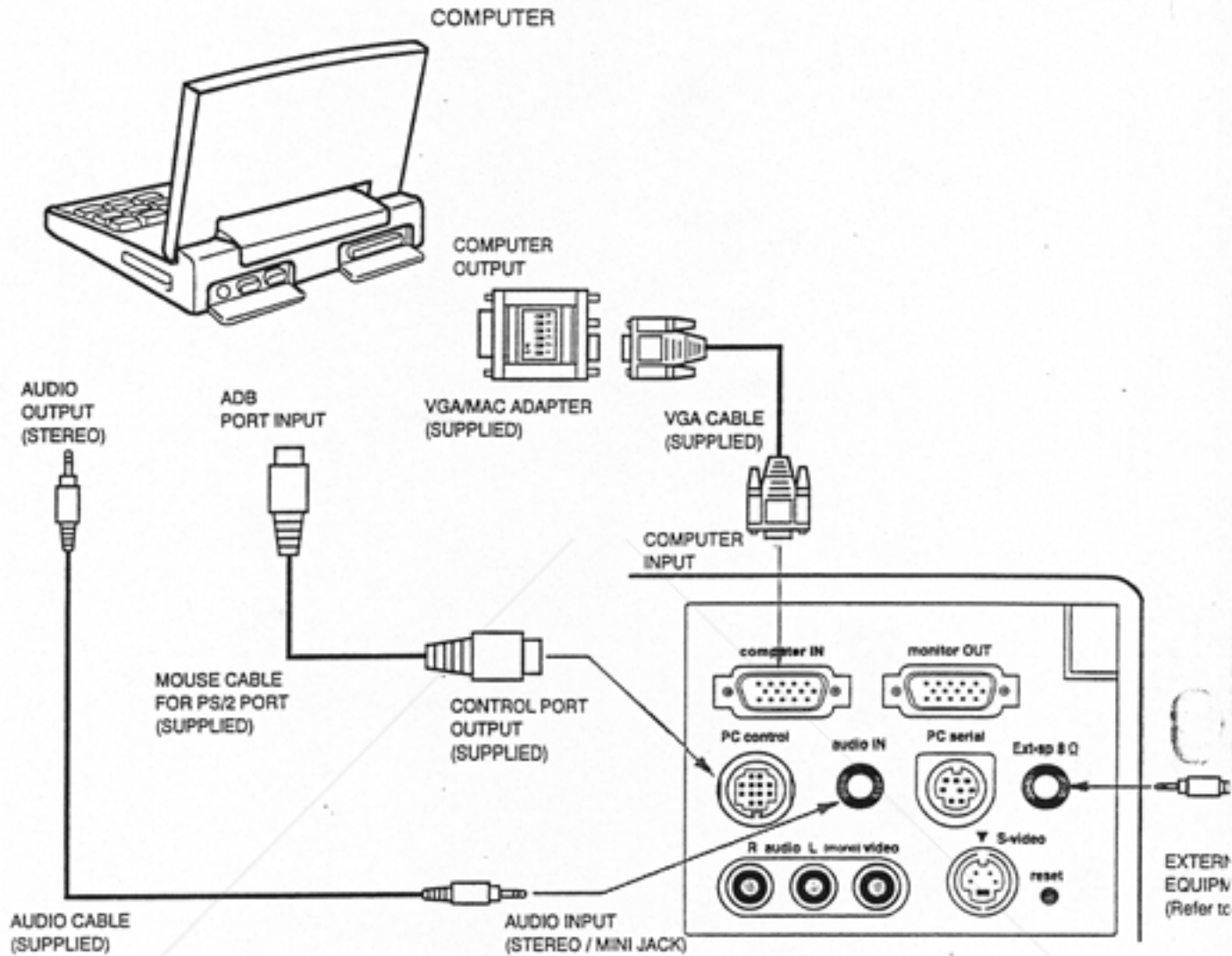

Set the slide switches as shown in the table below depending on the RESOLUTION MODE that you want to use before you turn on the projector and computer.

RESOLUTION MODE	SW1	SW2	SW3	SW4	SW5	SW6
15" MODE (640 × 480)	ON	ON	OFF	OFF	OFF	OFF
16" MODE (832 × 624)	OFF	ON	OFF	ON	OFF	OFF
19" MODE (1024 × 768)	OFF	ON	ON	OFF	OFF	OFF

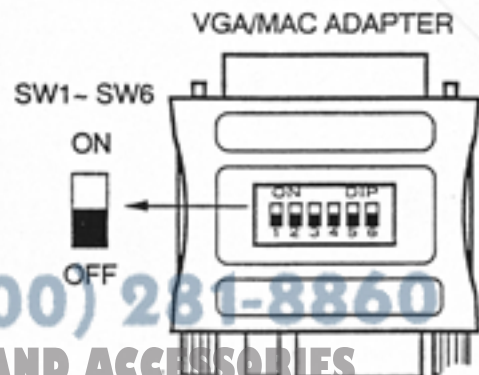

NOTE : When connecting the cable, the power cords of both the projector and the external equipments should be disconnected from AC outlet. Turn the projector and peripheral equipments on before the computer is switched on.

CONNECTING THE VIDEO EQUIPMENT

CONNECTING TO THE AUDIO/VIDEO INPUT JACKS

Connecting to the video and audio outputs of a VCR, video disc player, video camera, satellite TV tuner or other Video equipment.

- Connect audio/video outputs from external source to these input jacks using the audio/video cable.
- If the audio signal from the Video equipment is stereo, be sure to connect the right and left channels to the respective right and left audio input jacks.
- If the external audio signal is monaural, connect it to the L (MONO) .

S-VHS FORMAT VCR CONNECTION

The Video input includes an extra video input jack marked S-VIDEO to allow connection to an S-VHS format VCR that has separate Y/C video signals. The S-VIDEO jack has priority over the VIDEO jack.

CONNECTING THE EXTERNAL AUDIO EQUIPMENT

CONNECTING TO THE AUDIO OUT JACK (mini stereo type)

This jack outputs stereo sound from video or computer input when viewing on screen. If you use external audio equipment, connect an audio amplifier. Internal speaker sound is retained when AUDIO OUT jack is connected.

Video and External Audio Equipments connection

Connect equipments referring the figure below.

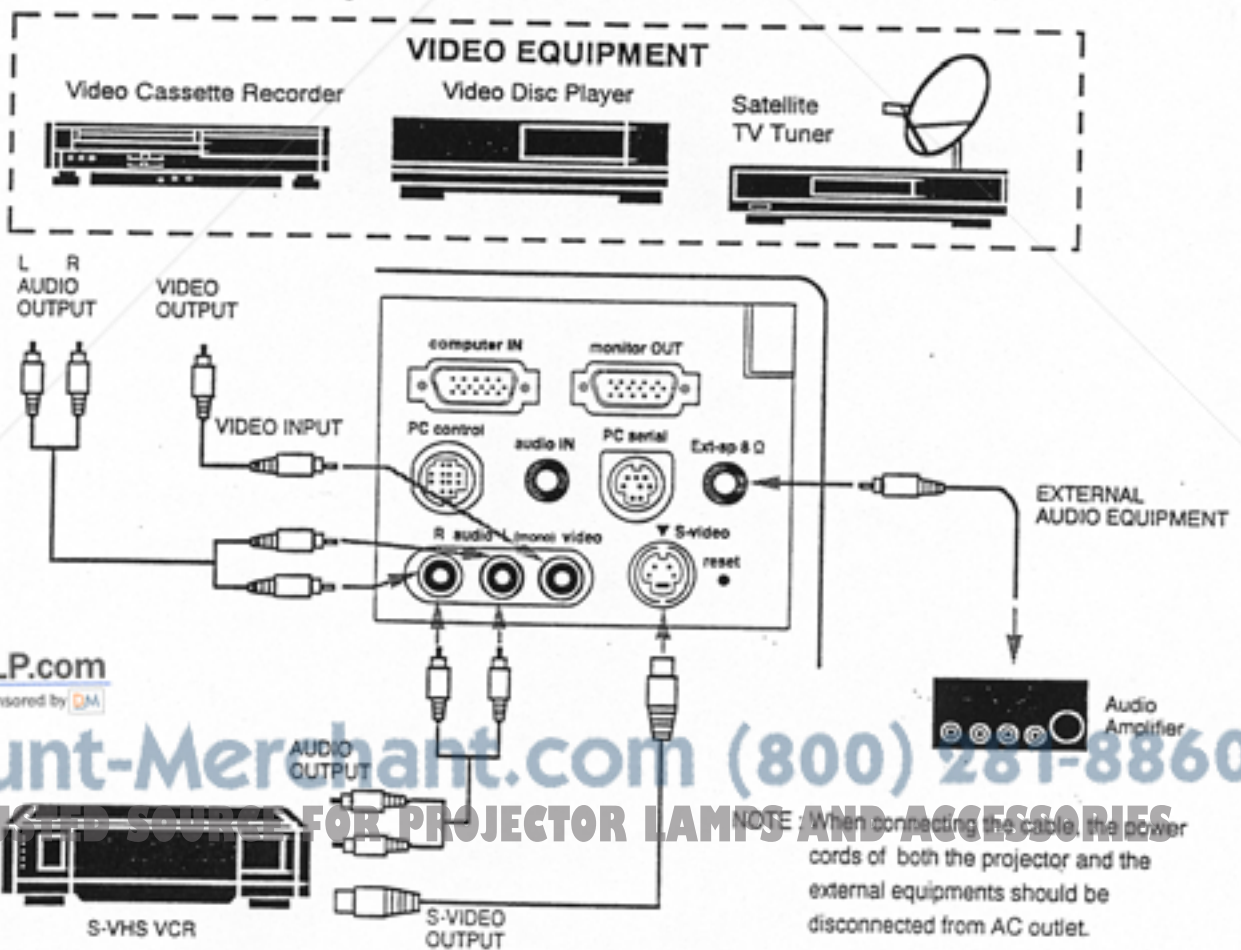

FixYourDLP.com
Sponsored by DM

Discount-Merchant.com (800) 281-8860

THE TRUTH ABOUT PROJECTOR LAMPS AND ACCESSORIES

OPERATION OF CONTROLS

TOP OF THE PROJECTOR

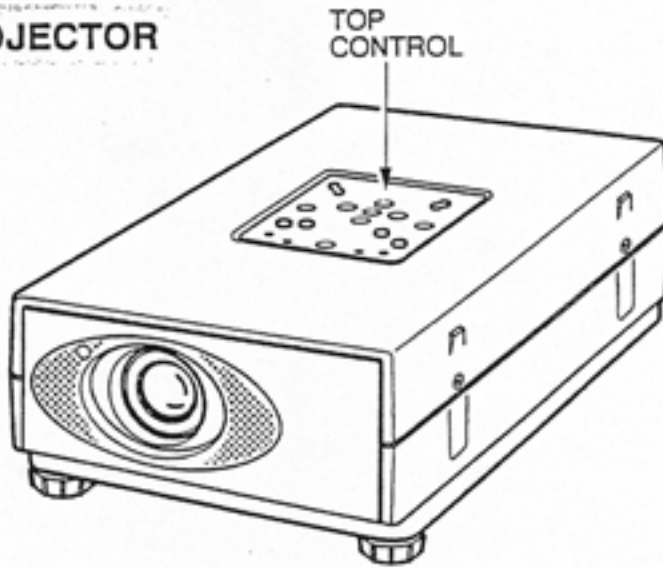

TOP CONTROL

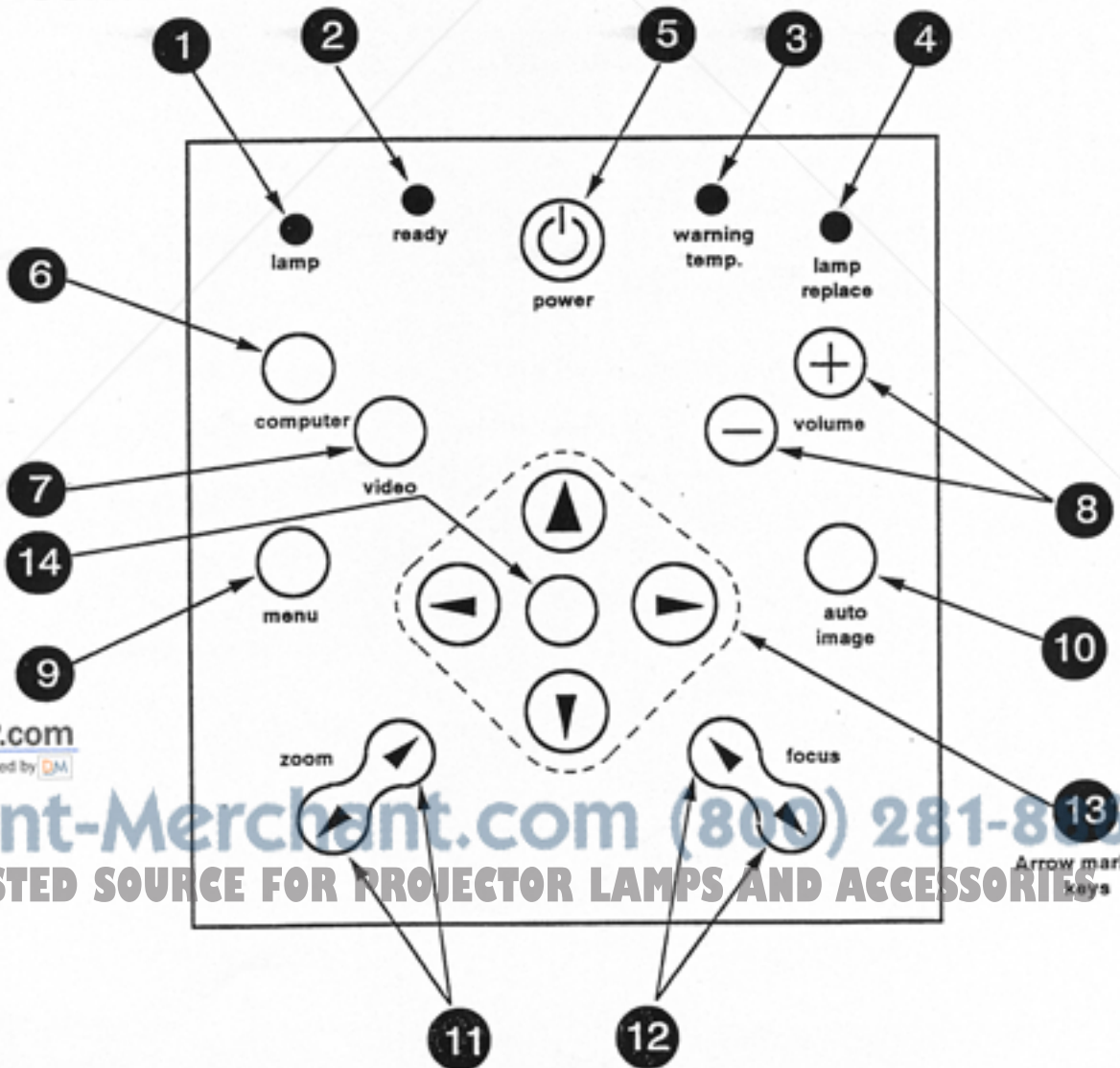

FixYourDLP.com
Sponsored by DM

Discount-Merchant.com (800) 281-8050

THE TRUSTED SOURCE FOR PROJECTOR LAMPS AND ACCESSORIES

Arrow marked keys

- 1 LAMP POWER INDICATOR**
Light is dim when the projector is on.
Light is brightened when the projector is in stand-by mode.
- 2 READY INDICATOR**
Light is green when projector lamp is ready to be turned on.
- 3 TEMPERATURE WARNING INDICATOR**
Flashes red when internal projector temperature is too high.
- 4 LAMP REPLACEMENT INDICATOR**
Light turns to yellow when the life of a projection lamp draws to an end.
- 5 POWER ON/OFF BUTTON**
Used to turn projector on or off.
- 6 COMPUTER SELECT BUTTON**
Used to select computer mode.
- 7 VIDEO SELECT BUTTON**
Used to select video mode.
- 8 VOLUME BUTTONS**
Used to adjust volume of sound.
- 9 MENU BUTTON ***
This button is used to call MENU operations. (MENU DISPLAY is displayed on the screen.)
- 10 AUTO IMAGE BUTTON**
Used to operate AUTO IMAGE function.
- 11 ZOOM BUTTONS**
Used to operate power zoom lens.
- 12 FOCUS BUTTONS**
Used to operate power focus system.
- 13 POINT UP/DOWN/LEFT/RIGHT BUTTONS ***
Used to select an item on MENU. To select an item, move through the menu by pressing these buttons (UP, DOWN, LEFT or RIGHT).
These buttons are used to operate panning mode in Picture Screen Adjustment of Menu Operation. (Refer to Page 41 for Picture Screen Adjustment.)
- 14 SELECT BUTTON ***
Used to activate the item you want to adjust or change value up or down. This button is used to expand the image in Picture Screen Adjustment of Menu Operation. (Refer to Page 41 for Picture Image Adjustment)

* MENU, POINT UP/DOWN/LEFT/RIGHT, and SELECT buttons are used to operate the projector on MENU DISPLAY. Refer to "MENU OPERATION" on Page 27 to operate MENU DISPLAY.



Discount-Merchant.com (800) 281-8860
THE TRUSTED SOURCE FOR PROJECTOR LAMPS AND ACCESSORIES

REAR OF THE PROJECTOR

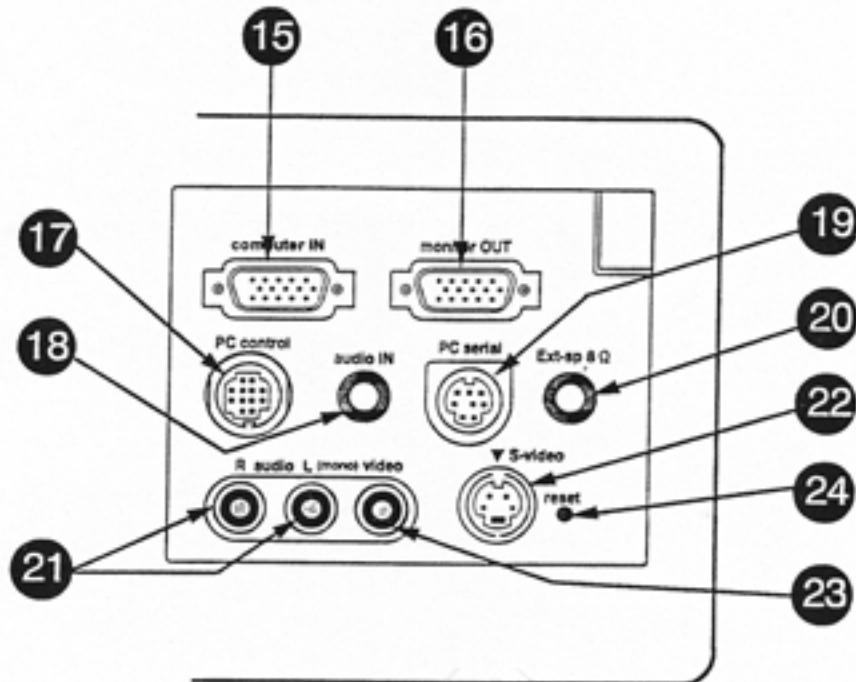

15 **COMPUTER INPUT TERMINAL**
Used to connect a computer to the projector.

16 **MONITOR OUTPUT TERMINAL**
Used to connect a monitor to the projector.

17 **CONTROL PORT CONNECTOR**
Used to connect a mouse port to the projector.

18 **COMPUTER AUDIO INPUT JACK**
(3.5mm mini stereo type)
Used to connect a computer audio input (stereo) to the projector.

19 **PC SERIAL PORT CONNECTOR**
Used to connect a computer to the projector.

20 **AUDIO OUTPUT JACK**
(3.5 mm mini stereo type)
Used to connect an audio amplifier.

21 **AUDIO INPUT JACKS**
Used to connect an audio input to the projector.

22 **S-VIDEO INPUT JACK**
Used to connect a S-VHS video source to the projector.

23 **VIDEO INPUT JACK**
Used to connect a video source to the projector.

24 **RESET BUTTON**
This projector uses Micro Computer control. In the unlikely event that the Micro Computer control fails to operate, press the RESET button with a small pointed object (like a pen) to shut down the projector.

 **FixYourDLP.com**
Sponsored by 

Discount-Merchant.com (800) 281-8860

THE TRUSTED SOURCE FOR PROJECTOR LAMPS AND ACCESSORIES

OPERATION OF REMOTE CONTROL

This remote control unit not only operates the projector but may also be used as a wireless mouse for a PC. One joystick and four buttons are used for wireless mouse operation. The wireless mouse is active when the PC cursor is displayed on the screen. When the projector menu is displayed on the screen instead of the cursor, the wireless mouse cannot be used.

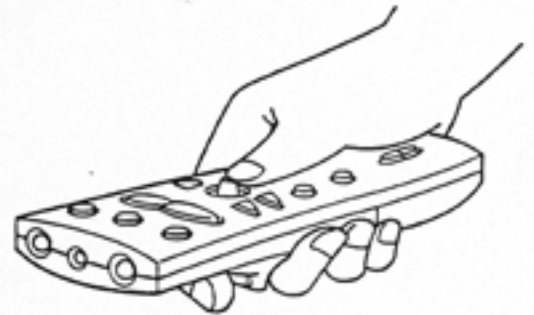

NOTE: To use the unit as a PC wireless mouse, connect the projector to the PC with the attached cable. Signals from the projector are transmitted to the PC, enabling the remote control unit to be used as a PC wireless mouse. (Refer to "CONNECTING THE PROJECTOR" in pages 10 to 14 for the connection.)

DANGER LASER RADIATION
DO NOT STARE INTO BEAM



Diode Laser Wavelength 630-680 nm
<5.0 milliwatt max. output Class IIIa Laser Product

See caution when operating the Laser remote control. Laser light can cause harm if projected at the human eye. Observe the cautions on the Laser Warning label located on the rear of the remote control. Do not point the laser directly into any person's eyes.

FRONT

REAR

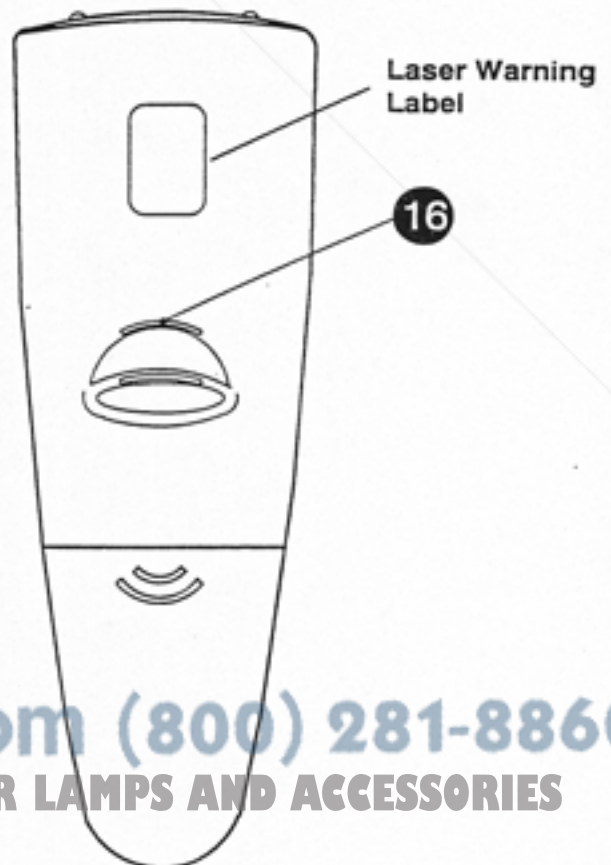
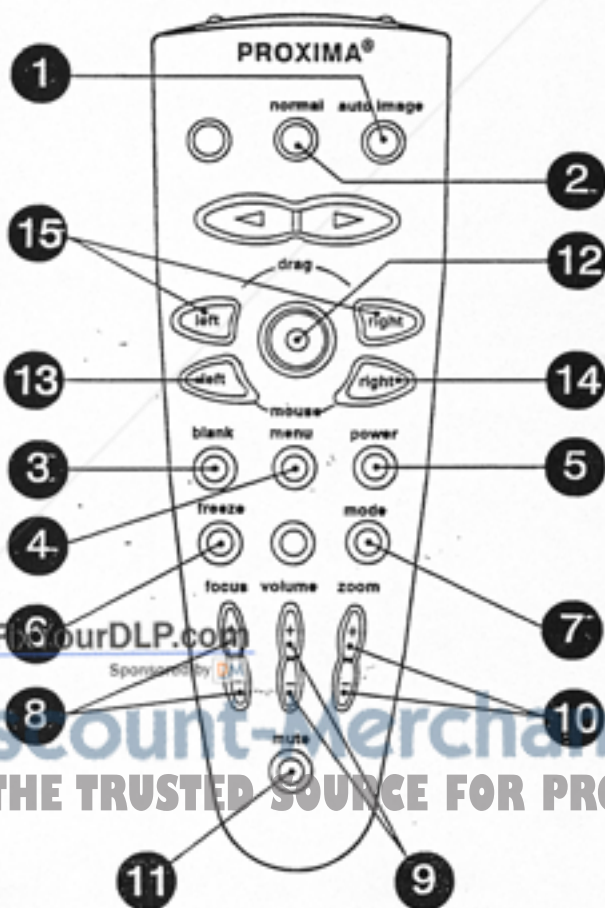

DiscountMerchant.com (800) 281-8860
THE TRUSTED SOURCE FOR PROJECTOR LAMPS AND ACCESSORIES

- 1 AUTO IMAGE BUTTON**
Used to operate AUTO IMAGE function.
- 2 NORMAL BUTTON**
Use to reset to normal picture adjustment preset by factory.
- 3 BLANK BUTTON**
Used to change the screen into black image.
- 4 MENU BUTTON**
This button will activate the MENU operation. Use this button, the POINT UP/DOWN/LEFT/RIGHT button and the SELECT button to make adjustments to the projector's setting in MENU operation.
- 5 LAMP POWER ON/OFF BUTTON**
Used to turn the projection lamp on or off.
- 6 FREEZE BUTTON**
Use this button to freeze on-screen image.
- 7 MODE BUTTON**
Used to select video source. (Computer or Video Input)
- 8 FOCUS BUTTONS**
Used to operate power focus system.
- 9 VOLUME BUTTONS**
Used to adjust volume.
- 10 ZOOM BUTTONS**
Used to operate power zoom lens.
- 11 SOUND MUTE BUTTON**
Used to mute sound.
- 12 JOYSTICK
(POINT UP/DOWN/LEFT/RIGHT BUTTON)**
When used as a remote for the projector control.
To select an item on the MENU that you want to adjust. To select an item, move the arrow by move the joystick forward, backward, left or right.

When used as a wireless mouse
Acts like a mouse. Move the joystick in the direction that you want to move the screen cursor. The further you move the joystick in any direction, the faster the cursor will move.
- 13 SELECT (LEFT CLICK) BUTTON**
When used as a remote for the projector control.
This button has different functions depending on when used. This button is used to select menu items.

When used as a wireless mouse
This button has the same function as the left button in a PC mouse.
- 14 RIGHT CLICK BUTTON**
This button has the same function as the right button in a PC mouse. Pressing this button does not affect any operation when in MENU mode.
- 15 DRAG LEFT/RIGHT BUTTONS**
Use this button and the joystick to drag a selected screen object. Press and release the Drag Left or Right button, the button glows and the remote control is in Drag mode. Move the joystick in the direction that you want to drag the screen object. Press and release a second time to drop the object at the new screen location.
- 16 LASER BUTTON**
Press and hold to activate the laser pointer.



FixYourDLP.com

Sponsored by

Discount-Merchant.com (800) 281-8860

THE TRUSTED SOURCE FOR PROJECTOR LAMPS AND ACCESSORIES

REMOTE CONTROL BATTERY INSTALLATION

1 Remove the battery compartment lid.



2 Slide the batteries into the compartment.

Note: For correct polarity (+ and - terminal), be sure the battery terminals are in contact with the pins in the compartment.

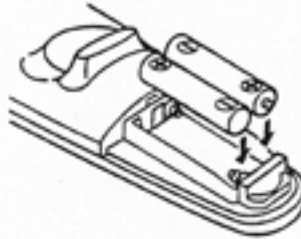

3 Replace the compartment lid.



USING REMOTE CONTROL

Point the remote control toward the projector's front or rear receiver windows whenever using the remote control. Maximum operating range for the remote control is about 16.4' (5m) and 60° front and rear of the projector.

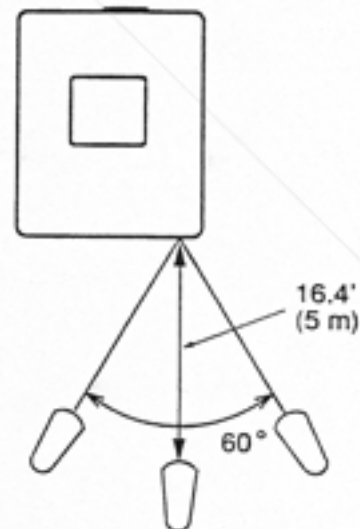
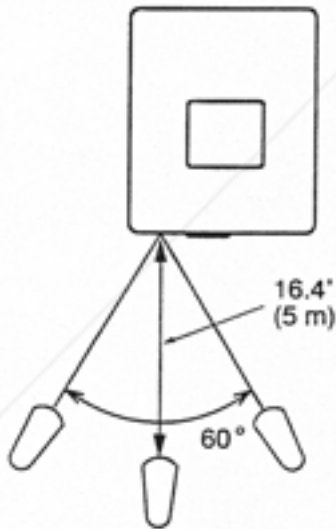

To insure safe operation, please observe the following precautions:

- Use (2) AAA type alkaline batteries.
- Change two batteries at the same time.
- Do not use a new battery with a used battery.
- Avoid contact with water.
- Do not drop the remote control unit.
- If batteries have leaked on the remote control, carefully wipe the case clean and load new batteries.



FixYourDLP.com

Sponsored by

Discount-Merchant.com (800) 281-8860

THE TRUSTED SOURCE FOR PROJECTOR LAMPS AND ACCESSORIES

CONTROLLING THE PROJECTOR

This projector is controlled through DIRECT OPERATION, or through MENU OPERATION.

DIRECT OPERATION : The projector is controlled directly with the buttons on the TOP CONTROL or REMOTE CONTROL (Refer to Page 26.).

MENU OPERATION : The projector is adjusted by operating the MENU DISPLAY. Press the MENU button and MENU DISPLAY is activated.

DIRECT OPERATION

ADJUST ITEM	TOP CONTROL OF THE PROJECTOR	REMOTE CONTROL UNIT
POWER ON/OFF	POWER ON-OFF BUTTON	POWER ON-OFF BUTTON
MODE SELECT	COMPUTER BUTTON VIDEO BUTTON	MODE BUTTON
SOUND VOLUME	VOLUME (+) and (-) BUTTONS	VOLUME (+) and (-) BUTTONS
SOUND MUTE	Not available	MUTE BUTTON
ZOOM	ZOOM (+) and (-) BUTTONS	ZOOM (+) and (-) BUTTONS
FOCUS	FOCUS (+) and (-) BUTTONS	FOCUS (+) and (-) BUTTONS
NORMAL PICTURE	Not available	NORMAL BUTTON
BLANK	Not available	BLANK BUTTON
FREEZE	Not available	FREEZE BUTTON
AUTO IMAGE	AUTO IMAGE BUTTON	AUTO IMAGE BUTTON

MENU OPERATION

ADJUST ITEM	TOP CONTROL OF THE PROJECTOR	REMOTE CONTROL UNIT
MODE SELECT	MENU BUTTON POINT LEFT/RIGHT BUTTONS SELECT BUTTON	MENU BUTTON POINT (LEFT/RIGHT) BUTTON SELECT BUTTON

1. COMPUTER / VIDEO MODE

ADJUST ITEM	TOP CONTROL OF THE PROJECTOR	REMOTE CONTROL UNIT
SOUND SOUND VOLUME SOUND MUTE	MENU BUTTON POINT LEFT/RIGHT BUTTONS SELECT BUTTON POINT UP/DOWN BUTTONS SELECT BUTTON	MENU BUTTON POINT (LEFT/RIGHT) BUTTON SELECT BUTTON POINT (UP/DOWN) BUTTON SELECT BUTTON
LANGUAGE		
SETTING BLUE BACK DISPLAY CEILING REAR LAMP AGE		

2. VIDEO MODE

ADJUST ITEM	TOP CONTROL OF THE PROJECTOR	REMOTE CONTROL UNIT
COLOR SYSTEM	MENU BUTTON POINT LEFT/RIGHT BUTTONS SELECT BUTTON POINT UP/DOWN BUTTONS SELECT BUTTON	MENU BUTTON POINT (LEFT/RIGHT) BUTTON SELECT BUTTON POINT (UP/DOWN) BUTTON SELECT BUTTON
PICTURE IMAGE COLOR TINT CONTRAST BRIGHTNESS SHARPNESS	MENU BUTTON POINT LEFT/RIGHT BUTTONS SELECT BUTTON POINT UP/DOWN BUTTONS SELECT BUTTON	MENU BUTTON POINT (LEFT/RIGHT) BUTTON SELECT BUTTON POINT (UP/DOWN) BUTTON SELECT BUTTON
PICTURE SCREEN REGULAR WIDE		

www.FixYourDrum.com

 THE MOST TRUSTED SOURCE FOR PROJECTOR LAMPS AND ACCESSORIES

3. COMPUTER MODE

ADJUST ITEM	TOP CONTROL OF THE PROJECTOR	REMOTE CONTROL U
COMPUTER SYSTEM	MENU BUTTON POINT LEFT/RIGHT BUTTONS SELECT BUTTON POINT UP/DOWN BUTTONS SELECT BUTTON	MENU BUTTON POINT (LEFT/RIGHT) BUTTON SELECT BUTTON POINT (UP/DOWN) BUTTON SELECT BUTTON
PICTURE IMAGE FINE SYNC TOTAL DOTS WHITE BALANCE CONTRAST BRIGHTNESS	MENU BUTTON POINT LEFT/RIGHT BUTTONS SELECT BUTTON POINT UP/DOWN BUTTONS SELECT BUTTON	MENU BUTTON POINT (LEFT/RIGHT) BUTTON SELECT BUTTON POINT (UP/DOWN) BUTTON SELECT BUTTON
PC ADJUSTMENT		
AUTO IMAGE FINE SYNC TOTAL DOTS POSITION		
PICTURE POSITION	MENU BUTTON POINT LEFT/RIGHT BUTTONS SELECT BUTTON POINT LEFT/RIGHT/UP/DOWN BUTTONS SELECT BUTTON	MENU BUTTON POINT (LEFT/RIGHT) BUTTON SELECT BUTTON POINT (LEFT/RIGHT/UP/DOWN) BUTTON SELECT BUTTON
PICTURE SCREEN TRUE DIGITAL ZOOM	MENU BUTTON POINT LEFT/RIGHT BUTTONS SELECT BUTTON POINT UP/DOWN BUTTONS SELECT BUTTON	MENU BUTTON POINT (LEFT/RIGHT) BUTTON SELECT BUTTON POINT (UP/DOWN) BUTTON SELECT BUTTON



Discount-Merchant.com (800) 281-8860

THE TRUSTED SOURCE FOR PROJECTOR LAMPS AND ACCESSORIES

BASIC OPERATION

TURNING ON THE PROJECTOR

1. Connect peripheral equipment (Computer, VCR, and etc.) before turning on the projector. (Refer to "CONNECTING THE PROJECTOR" on Pages 10-15 for connecting those equipments.)
2. Connect the AC power cord of the projector into a wall outlet. Make sure READY INDICATOR on TOP CONTROL turns to green, and LAMP INDICATOR turns to red.
3. Press ON-OFF BUTTON on TOP CONTROL or REMOTE CONTROL. LAMP INDICATOR turns dim.
4. A number appears on the screen, and NUMBER counts down until picture image is displayed. It takes about 30 seconds to project a image.

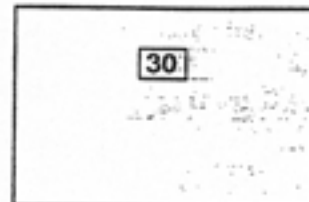

NOTE : Turn on the computer last when the computer is connected in system.



CAUTION

THIS PROJECTOR USES A UHP LAMP. TO MAINTAIN THE LIFE OF LAMP, ONCE YOU TURN IT ON, WAIT AT LEAST 5 MINUTES BEFORE TURNING IT OFF.

NOTE : When TEMPERATURE WARNING INDICATOR flashes red, the projector will automatically turn off. Wait at least 5 minutes to turn the projector on again.

If TEMPERATURE WARNING INDICATOR continues to flash, follow the procedures below:

1. Press POWER ON-OFF BUTTON to OFF.
2. Check if the air filter is contaminated with dust. The air filter must be maintained and cleaned. Refer to "AIR FILTER CARE AND CLEANING" on Page 45.
3. Press POWER ON-OFF button to ON.

If TEMPERATURE WARNING INDICATOR still continues to flash, call your authorized dealer or service station.

TURNING OFF THE PROJECTOR

1. Press the POWER ON-OFF button on TOP CONTROL or REMOTE CONTROL. The message "Power off?" appears on the screen.
2. Press again POWER ON-OFF button to turn the projector off. Make sure LAMP INDICATOR turns to bright. READY INDICATOR turns off and the cooling fans operate for 1 minute for cooling the projector after switched off. (NOTE : During the cooling sequence the projector, cannot be turned on.)
3. When cooling of the projector is finished, READY INDICATOR turns to green again. You can turn the projector on again.

Power off ?



Discount-Merchant.com (800) 281-8860

THE TRUSTED SOURCE FOR PROJECTOR LAMPS AND ACCESSORIES

DIRECT OPERATION

MODE SELECT (Top control)

Press the COMPUTER or VIDEO button to select Computer or Video mode.

MODE SELECT (Wireless remote control)

This function is operated with MODE button. MODE button is used to select the input mode either Computer or Video. Select the mode to suit your input source. The "Computer" or "Video" display will appear on the screen for a few seconds.

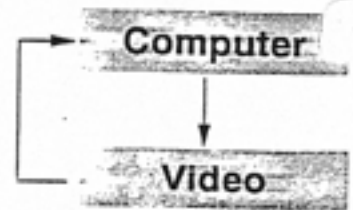

SOUND VOLUME ADJUSTMENT

Press VOLUME buttons (located on TOP CONTROL or REMOTE CONTROL) to adjust the volume. The volume display will be displayed on the screen for a few seconds.

Pressing volume (+) will increase volume and increase the number on the screen.

Pressing volume (-) will decrease volume and decrease the number on the screen.

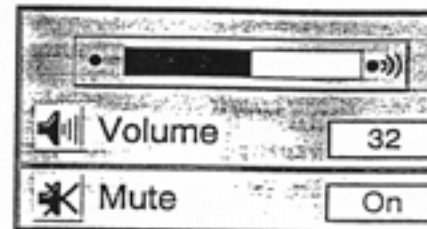

SOUND MUTE FUNCTION

Pressing MUTE button on REMOTE CONTROL to cut off the audio sound. Press the MUTE button again to restore audio to its previous level. The mute display will be displayed on the screen for a few seconds. External audio equipments produce the audio sound while MUTE is on.

ZOOM ADJUSTMENT

Press the ZOOM (+) or (-) buttons (located on TOP CONTROL or REMOTE CONTROL) to obtain your desired picture size. For a larger picture, press (+) and for a smaller picture, press (-).



FOCUS ADJUSTMENT

Press the FOCUS (+) or (-) buttons (located on TOP CONTROL or REMOTE CONTROL) for a sharper, crisper picture.

Focus

NORMAL PICTURE FUNCTION

The normal picture level is factory preset on the projector and can be restored anytime by pressing NORMAL button (located on REMOTE CONTROL). The "Normal" display will be displayed on the screen for a few seconds.

Normal

BLANK FUNCTION

Press BLANK button on REMOTE CONTROL. The screen will change into black image and "NO SHOW" is displayed on the screen for a few seconds. This function is cancelled when BLANK button is pressed again or any other function button is pressed.

No Show

FREEZE PICTURE FUNCTION

Press the FREEZE button on REMOTE CONTROL, and the picture will remain on-screen. This function cancelled when the FREEZE button is pressed again or any other function button is pressed.

NOTE: Your computer or video equipment is not affected by this function, and will continue to run.

AUTO IMAGE FUNCTION

Press AUTO IMAGE button on TOP CONTROL or REMOTE CONTROL. The item(s) indicated "ON" IMAGE FUNCTION are adjusted automatically.

If all the items in AUTO IMAGE FUNCTION are "OFF," AUTO IMAGE SETTING display appears. If you wish operate AUTO IMAGE FUNCTION, perform the steps 3-9 of "AUTO IMAGE FUNCTION" section on Page 40.



FixYourDLP.com

DiscountMerchant.com (800) 251-8860

THE TRUSTED SOURCE FOR PROJECTOR LAMPS AND ACCESSORIES

MENU OPERATION

Basically MENU operations as follow;

1. Press MENU BUTTON. MAIN MENU is displayed.
2. Select the item to adjust or change with POINT BUTTON (UP/DOWN/LEFT/RIGHT) and SELECT BUTTON.
3. Press MENU BUTTON while MAIN MENU is displayed, MENU is closed.

TOP CONTROL

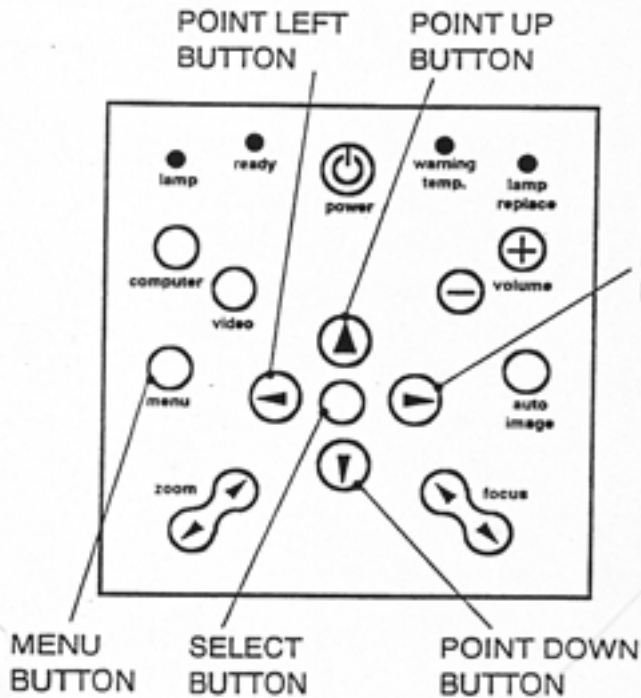

REMOTE CONTROL

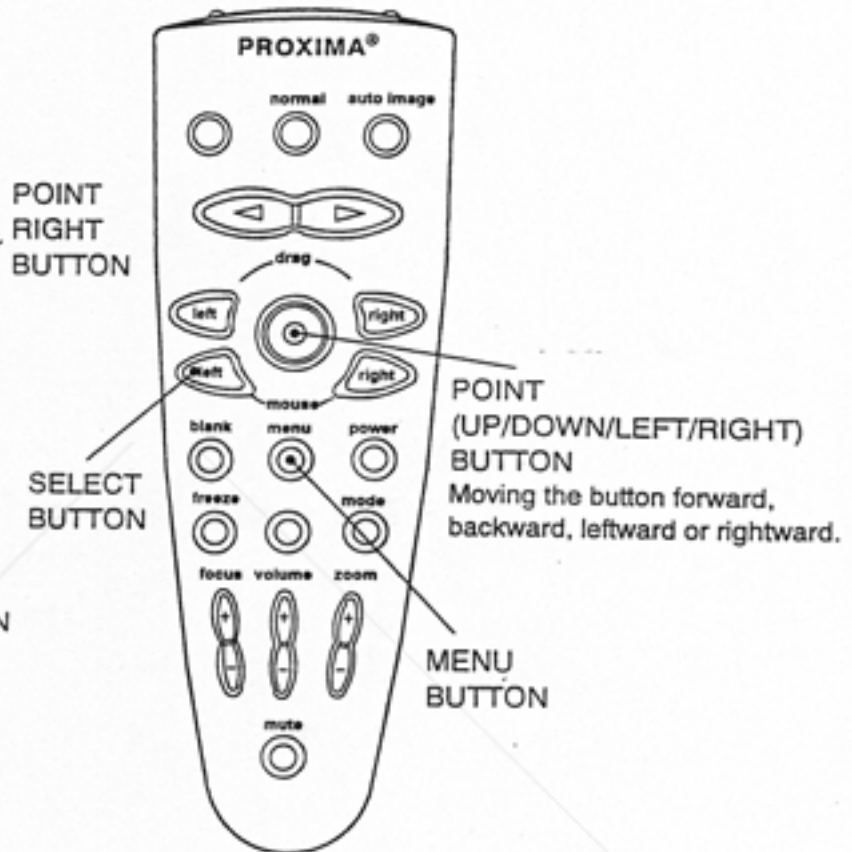

MODE SELECT

Select MODE among COMPUTER, VIDEO corresponding to the input source with MENU OPERATION.

1. Press MENU BUTTON and display MAIN MENU DISPLAY.
2. Press POINT LEFT/RIGHT BUTTONS to select the mode to suit your input source. (The mode with red box is selected.)
3. Press SELECT BUTTON to fix the mode.

COMPUTER MODE



SOUND ADJUSTMENT

You can adjust the volume of sound and sound mute on MENU DISPLAY.

1. Press MENU button and MAIN MENU DISPLAY dialog box will appear.
2. Press POINT LEFT/RIGHT button(s) to select SOUND and press SELECT button. Another dialog box ADJUST DISPLAY will appear.
3. Press POINT DOWN button and a red arrow will appear.
4. Move the arrow to an item that you want to adjust by pressing POINT UP/DOWN button(s).
5. To increase the volume, point the arrow to ▲ and then press SELECT button. To decrease the volume, the arrow to ▼ and then press SELECT button.
6. To cut off the audio sound, point the arrow to Mute and then press SELECT button. The mute display changed On from Off and the sound is cut off. External audio equipments produce the audio sound MUTE is on.
7. To quit Sound Adjustment Menu, point to Quit and then press SELECT button.

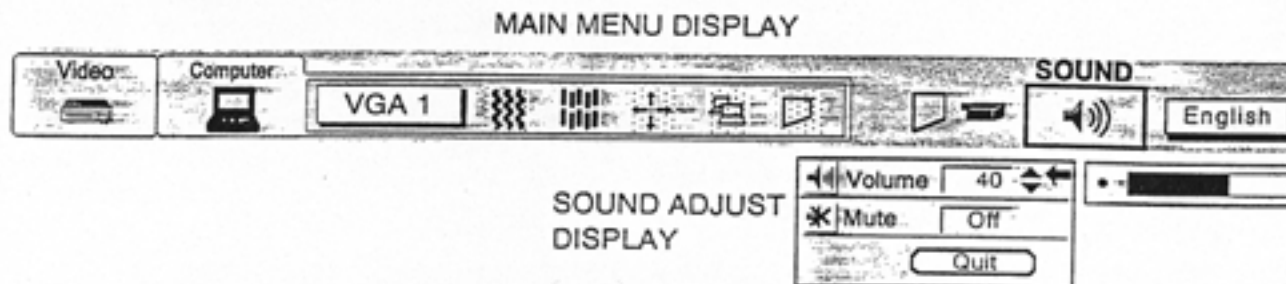

LANGUAGE ADJUSTMENT

MENU DISPLAY is displayed in the language selected among English, German, French, Italian, Spanish, and Japanese on MENU DISPLAY.

1. Press MENU button and MAIN MENU DISPLAY dialog box will appear.
2. Press POINT LEFT/RIGHT button(s) to select LANGUAGE and press SELECT button. Another dialog box LANGUAGE SETTING DISPLAY will appear.
3. Press POINT DOWN button and a red arrow will appear.
4. Move the arrow to the language you want to use by pressing POINT UP/DOWN button(s) and then press SELECT button.
5. The setting is permanently held even if POWER ON/OFF is switched off.

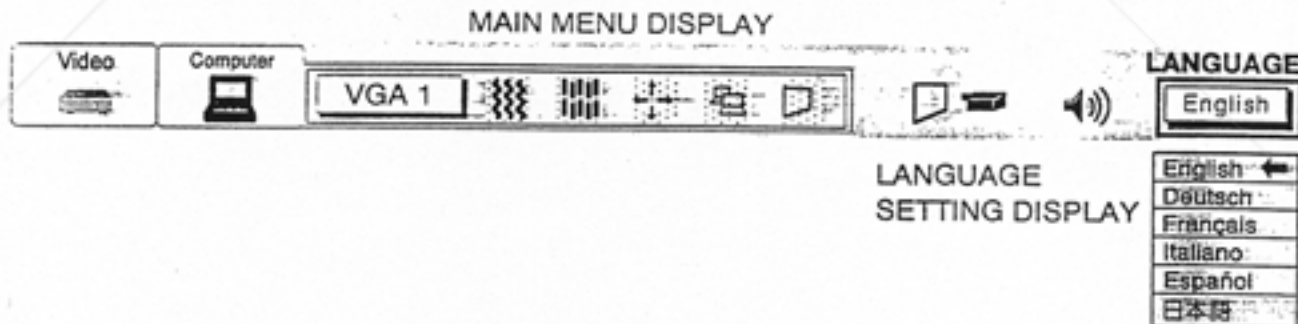

COLOR SYSTEM SELECT (VIDEO MODE)

This projector is compatible with the four major broadcast video standards: PAL, SECAM, NTSC or NTSC 4.43 (COLOR SYSTEMS). It automatically adjusts itself to optimize its performance for the incoming video. However, if the video signal is not strong enough to detect the video format, the projector may not reproduce the proper video image. In case this happens, this projector allows you to choose a specific broadcast signal format.

1. Connect the video equipment and the projector, and turn them on.
2. Set MODE SELECT to "VIDEO MODE".
3. Press MENU button and MAIN MENU DISPLAY dialog box will appear.
4. Press POINT LEFT/RIGHT button(s) to select SYSTEM and press SELECT button. Another dialog box COLOR SYSTEM DISPLAY will appear. The current COLOR SYSTEM is displayed in the system window.
5. Press POINT DOWN button and a red arrow will appear.
6. To change the current COLOR SYSTEM, press POINT UP/DOWN button(s) to move the arrow to a desirable system and then press SELECT button.
7. The new setting remained effective until POWER ON/OFF switch is turned off.

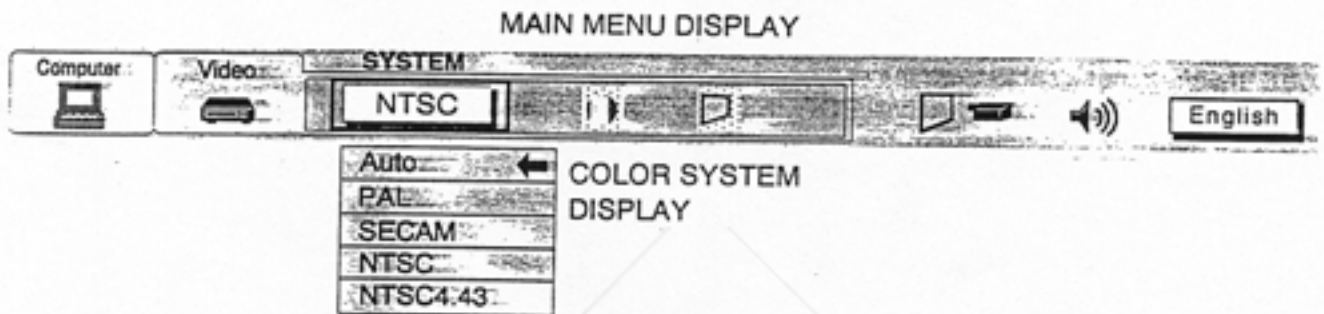

PICTURE IMAGE ADJUSTMENT (VIDEO MODE)

This projector is adjusted at the factory to produce suitable picture images. If you want to tune the picture more finely, it can be adjusted at IMAGE ADJUSTMENT.

1. Press MENU button and MAIN MENU DISPLAY dialog box will appear.
2. Press POINT LEFT/RIGHT button(s) to select IMAGE and press SELECT button. Another dialog box IMAGE ADJUST DISPLAY will appear. This shows the current picture settings.
3. In this dialog box, you can adjust the settings by increasing or decreasing the levels shown as number items and the range of the levels that you can adjust are summarized in the table as below.
4. Press POINT DOWN button and a red arrow will appear.
5. Move the arrow to an item that you want to adjust by pressing POINT UP/DOWN button(s).
6. To increase the level, point the arrow to ▲ and then press SELECT button. To decrease the level, point the arrow to ▼ and then press SELECT button.
7. You can store the settings in the memory to recall them later. To store the settings, move the arrow to "S" and then press SELECT button. When you have stored the settings, "OK ?" is displayed for confirmation.
8. Move the arrow to Yes and then press SELECT button. The stored settings are permanently held and POWER ON/OFF is switched off.
9. To quit Picture Image Adjustment Menu, move the arrow to Quit and then press SELECT button.
10. If you do not want to store the settings, move the arrow to Quit and then press SELECT button. The settings changed remains effective until POWER ON/OFF switch is turned off.
11. To recall the settings from the memory that you have stored, move the arrow to Reset and then press SELECT button. When you have reset the settings, "OK ?" is displayed for confirmation. Move the arrow to Yes and then press SELECT button. You can adjust the settings again if needed.

NOTE: "TINT" is skipped during in the PAL and SECAM mode.

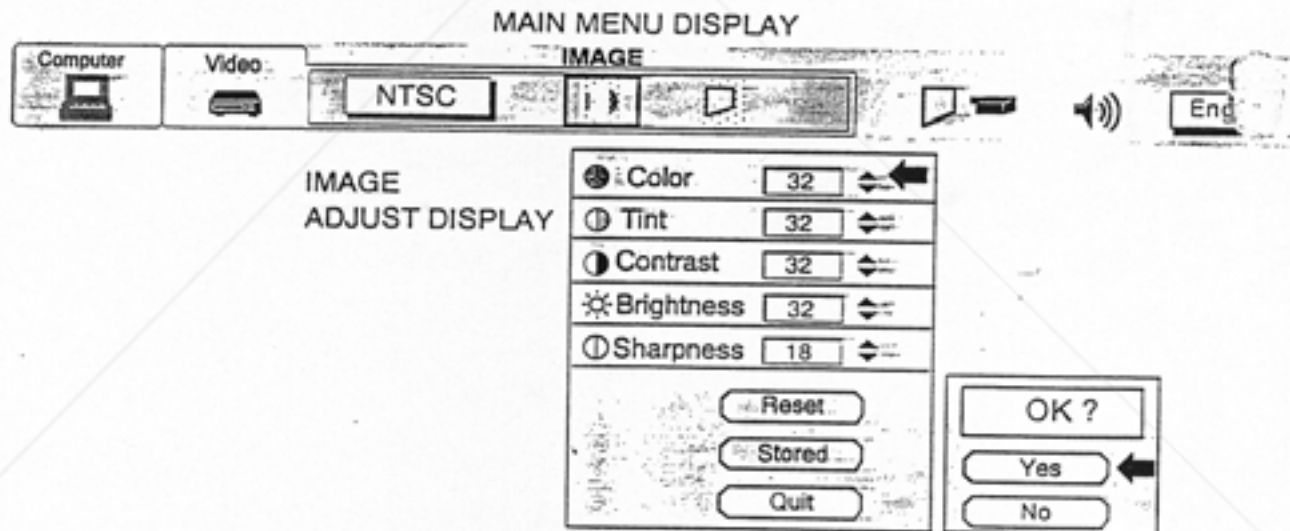

TABLE OF PICTURE IMAGE ADJUSTMENT

COLOR	DECREASES	0	← →	63	INCREASES
TINT	MORE PURPLE	0	← →	63	MORE GREEN
CONTRAST	LIGHTER	0	← →	63	DEEPER
BRIGHTNESS	DARKER	0	← →	63	BRIGHTER
SHARPNESS	SOFTER	0	← →	31	SHARPER

PICTURE SCREEN ADJUSTMENT (VIDEO MODE)

This projector has a WIDE function, which enables you to view 16:9 video image.

WIDE function

This projector is able to project not only a normal video image (with 4 × 3 aspect ratio), but also a wider video image by compressing 4 × 3 images. This feature may be used by those who want to enjoy watching a movie with cinema-like image. You can switch either to WIDE or to REGULAR screen mode.

1. Press the MENU button and the MAIN MENU DISPLAY dialog box will appear.
2. Press the POINT LEFT/RIGHT button(s) to select SCREEN and press the SELECT button. Another dialog box: SCREEN ADJUST DISPLAY will appear.
3. Press the POINT DOWN button and a red arrow will appear.
4. To switch to "Wide" mode, move the arrow to Wide by pressing the POINT UP/DOWN button(s) and then press the SELECT button.
5. To switch to "Regular" mode, move the arrow to Regular by pressing the POINT UP/DOWN button(s) and then press the SELECT button.
6. The "Wide" settings remains effective until the POWER ON/OFF switch is turned off.

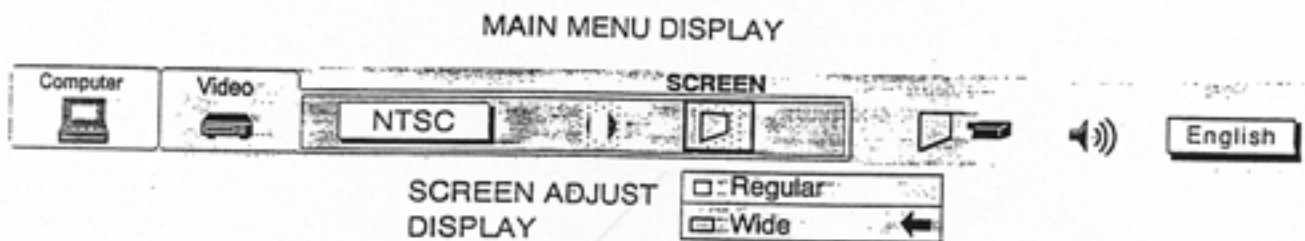

COMPUTER SYSTEM SELECT (COMPUTER MODE)

This projector is adjustable to different types of computer display signals based on VGA, SVGA or XGA (COMPATIBLE COMPUTER SPECIFICATIONS" on the next page). If you set MODE SELECT to "COMPUTER" the projector will automatically process the incoming signal and project the proper image without any special setting. Although this will work in most cases, you may be required to manually set the projector to a specific computer signal. If the computer image is not reproduced properly, try the following procedure and switch to the computer display mode that you want to use.

1. Connect the computer and the projector, and turn them on.
2. Set MODE SELECT to "COMPUTER MODE". This shows the current display mode initially detected by the projector in the system window. And "Current mode" display appears.

NOTE: 1. If the projector cannot discriminate or detect the input signal from the computer, the "Go F" display appears.

NOTE: 2. If no input signal from the computer, the "No signal" display appears on the screen.

3. Press MENU button and MAIN MENU DISPLAY dialog box will appear.
4. Press POINT LEFT/RIGHT button(s) to select SYSTEM and press SELECT button. Another dialog box COMPUTER SYSTEM DISPLAY will appear.
5. Press POINT DOWN button and a red arrow will appear.
6. If you want to change the current display mode, move the arrow by pressing POINT UP/DOWN button to the item of the mode that you want to change into.
7. Press the SELECT button to change the display mode.
8. To quit the Computer System Menu, move the arrow to Quit and then press SELECT button.

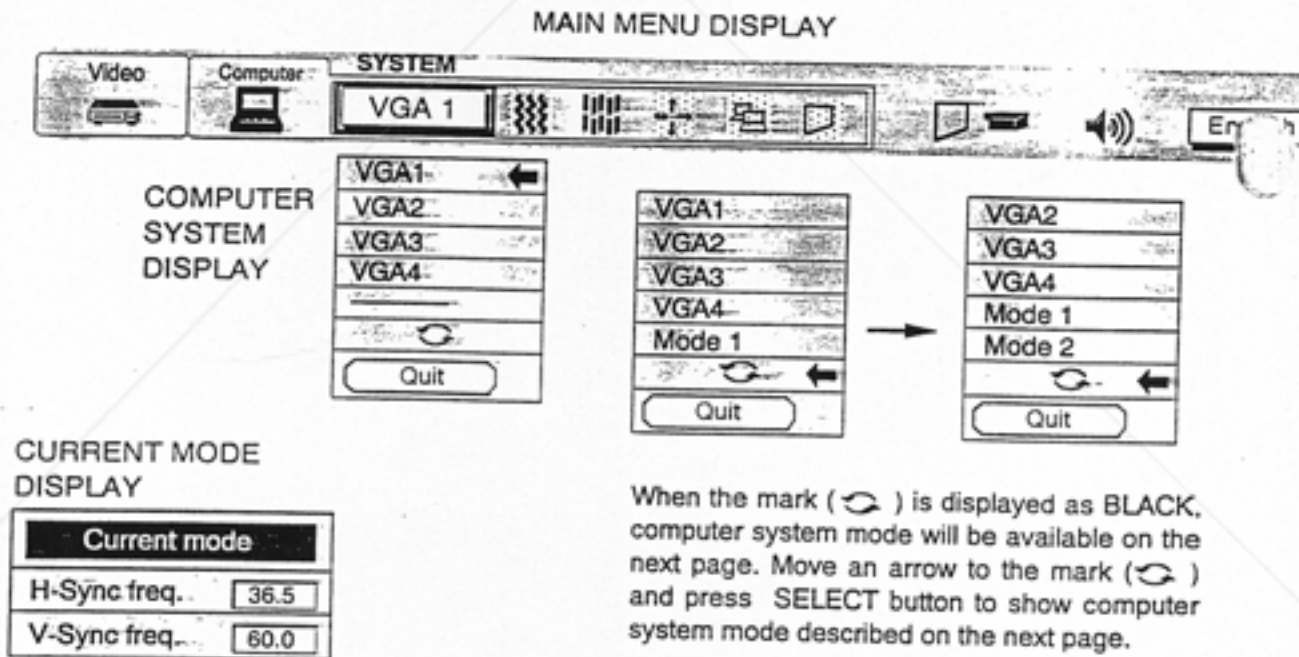

PC ADJUSTMENT

Sponsored by FixYourDef.com. This is a special function that may be used when a computer image is not reproduced properly. (See the manual pages 36-39 for more detail.)



Discount-Merchant.com (800) 281-8860

THE TRUSTED SOURCE FOR PROJECTOR LAMPS AND ACCESSORIES

COMPATIBLE PERSONAL COMPUTER SPECIFICATIONS

ON-SCREEN DISPLAY	RESOLUTION	Horizontal Frequency (kHz)	Vertical Frequency (Hz)
VGA1	640 × 480	31.47	59.88
VGA2	720 × 400	31.47	70.09
VGA3	640 × 400	31.47	70.09
VGA4	640 × 480	37.86	74.38
VGA5	640 × 480	37.86	72.81
VGA6	640 × 480	37.50	75.00
MAC LC13	640 × 480	34.97	66.60
MAC 13	640 × 480	35.00	66.67
PC98	640 × 400	24.83	56.42
FM TOWNS	640 × 400	24.38	55.40
SVGA1	800 × 600	35.156	56.25
SVGA2	800 × 600	37.88	60.32
SVGA3	800 × 600	46.875	75.00
SVGA4	800 × 600	53.674	85.06
SVGA5	800 × 600	48.08	72.19
SVGA6	800 × 600	37.90	61.03
SVGA7	800 × 600	34.50	55.38
SVGA8	800 × 600	38.00	60.51
SVGA9	800 × 600	38.60	60.31
SVGA10	800 × 600	47.90	71.92
SVGA11	800 × 600	32.70	51.09
SVGA12	800 × 600	38.00	60.51
MAC 16	832 × 624	49.72	74.55
XGA1	1024 × 768	48.36	60
XGA2	1024 × 768	68.677	84.997
XGA3	1024 × 768	60.023	75.03
XGA4	1024 × 768	56.476	70.07
XGA5	1024 × 768	60.31	74.92
XGA6	1024 × 768	48.50	60.02
XGA7	1024 × 768	44.00	54.58
XGA8	1024 × 768	63.48	79.35
XGA9	1024 × 768	36.00	87.17 (Interlace)
XGA10	1024 × 768	62.04	77.07
XGA11	1024 × 768	61.00	75.70
XGA12	1024 × 768	35.522	86.96 (Interlace)
XGA13	1024 × 768	46.90	58.20
XGA14	1024 × 768	47.00	58.30
MAC19	1024 × 768	60.24	75.08

Specifications are subject to change without notice.

FixYourDLP.com
 Sponsored by 

Discount Merchant.com (800) 281-8860
THE TRUSTED SOURCE FOR PROJECTOR LAMPS AND ACCESSORIES

PICTURE IMAGE ADJUSTMENT (COMPUTER MODE)

Picture adjustments have been preset at the factory. If you want to change the setting, follow the instructions below.

1. Press MENU button and MAIN MENU DISPLAY dialog box will appear.
2. Press POINT LEFT/RIGHT button(s) to select IMAGE and press SELECT button. Another dialog box ADJUST DISPLAY will appear. This shows the current picture settings.
3. In this dialog box, you can adjust the settings by increasing or decreasing the levels shown as numbers and the range of the levels that you can adjust are summarized in the table as below.
4. Press POINT DOWN button and a red arrow will appear.
5. Move the arrow to an item that you want to adjust by pressing POINT UP/DOWN button(s).
6. To increase the level, point the arrow to ▲ and then press SELECT button. To decrease the level, point the arrow to ▼ and then press SELECT button.
7. You may want to store the settings in the memory so that you can recall them later. To store the setting, point the arrow to Stored and then press SELECT button. When you have stored the settings, "OK ?" is displayed for confirmation.
8. Move the arrow to Yes and then press SELECT button. The stored settings are permanently held. POWER ON/OFF is switched off.
9. To quit Picture Image Adjustment Menu, move the arrow to Quit and then press SELECT button.
10. If you do not want to store the settings, move the arrow to Quit and then press SELECT button. The changed settings remain effective until POWER ON/OFF switch is turned off.
11. To recall the settings from the memory that you have stored, move the arrow to Reset and then press SELECT button. When you have reset the settings, "OK ?" is displayed for confirmation. Move the arrow to Yes then press SELECT button. You can adjust the settings again if needed.

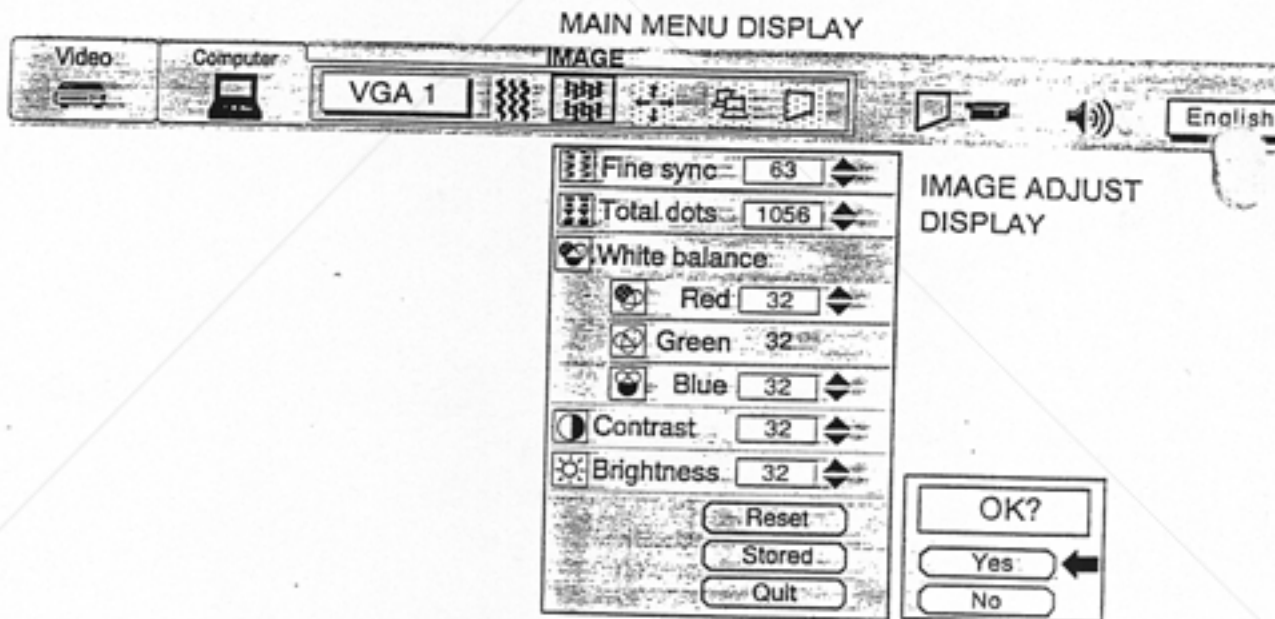
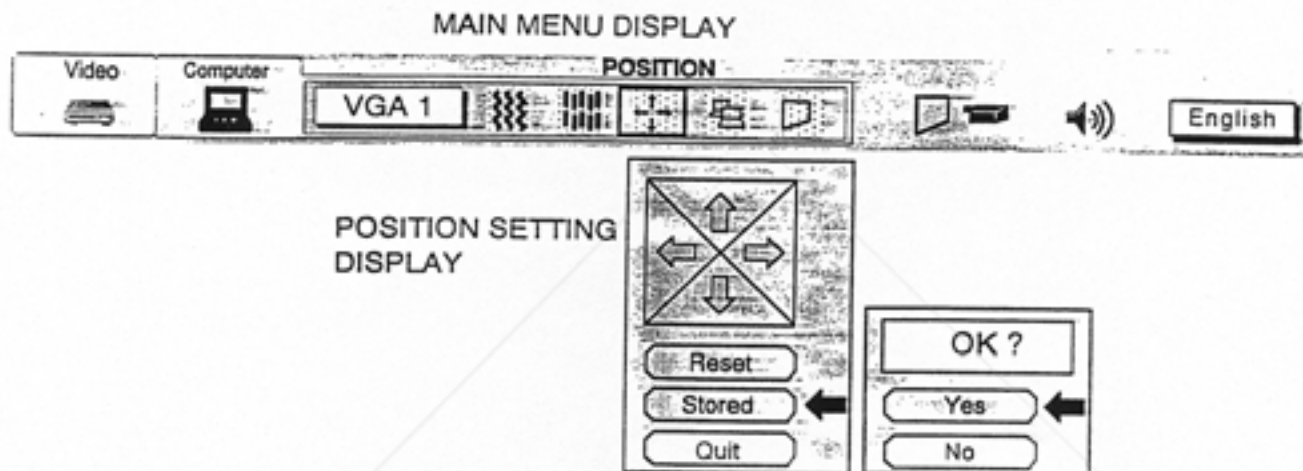

TABLE OF PICTURE IMAGE ADJUSTMENT

FINE SYNC	Adjust the picture as necessary to eliminate flicker from the display. 0 ← → 1;
TOTAL DOTS	The number of the total dots in one horizontal period. Adjust the number to match your PC image.
WHITE BALANCE (RED/BLUE)	DECREASE 0 ← → 63 INCREASE
CONTRAST	LIGHTER 0 ← → 63 DEEPER
BRIGHTNESS	DARKER 0 ← → 63 BRIGHTER

PICTURE POSITION ADJUSTMENT (COMPUTER MODE)

1. Press MENU button and MAIN MENU DISPLAY dialog box will appear.
2. Press POINT LEFT/RIGHT button(s) to select POSITION and press SELECT button. Another dialog box POSITION SETTING DISPLAY will appear.
3. Press POINT DOWN button and a red arrow will appear.
4. Move the arrow to a desirable direction (← , → , ↑ or ↓) by pressing POINT LEFT/RIGHT/UP/DOWN button(s) and press SELECT button to a desirable picture position.
5. You may want to store the settings to the memory so that you can recall them later. To store the settings, move the arrow to Stored and then press SELECT button. When you have stored the settings, "OK ?" is displayed for confirmation.
6. Move the arrow to Yes and then press SELECT button. The stored settings are permanently held even if POWER ON/OFF is switched off.
7. To quit Picture Position Adjustment Menu, move the arrow to Quit and then press SELECT button.
8. If you do not want to store the settings, move the arrow to Quit and then press SELECT button. The settings changed remains effective until POWER ON/OFF switch is turned off.
9. To recall the settings from the memory that you have stored, move the arrow to Reset and then press SELECT button. When you have reset the settings, "OK ?" is displayed for confirmation. Move the arrow to Yes and then press SELECT button. You can adjust the settings again if needed.



PC ADJUSTMENT

This projector can automatically detect display signals from most personal computers currently distributed. However, some computers employ special signal formats which are different from the standard ones and not be detected by this projector. If this happens, the projector cannot reproduce a proper image and is recognized as a flickering picture, a non-synchronized picture, a non-centered picture or a skewed picture.

This projector has PC ADJUSTMENT function, to enable you to precisely adjust several parameters to match with the input signal format. The projector has eight independent memory areas where you can store the parameter you have set. This enables you to recall the setting for a specific computer whenever you need it.

1. Press MENU button and MAIN MENU DISPLAY dialog box will appear.
2. Press POINT LEFT/RIGHT button(s) to select PC ADJUST and press SELECT button. Another dialog box "Where to reserve" will appear.
3. In this dialog box, you will select one of the memory areas from among "Mode 1" to "Mode 8". If parameters have been previously set and stored in the memory, the status "Stored" will appear on the corresponding mode. If not, "Free" will appear.
4. Press POINT DOWN button and a red arrow will appear.
5. Move the arrow to one of the "Modes" (Free position) where you want to store the parameters by pressing POINT UP/DOWN button(s). Press SELECT button to select it.

NOTE: If "Stored" appears in all Modes, no new PC parameter data can be stored. In this case, clear the parameter data using Mode free Function (refer to Page 39).

Continued to the next page.

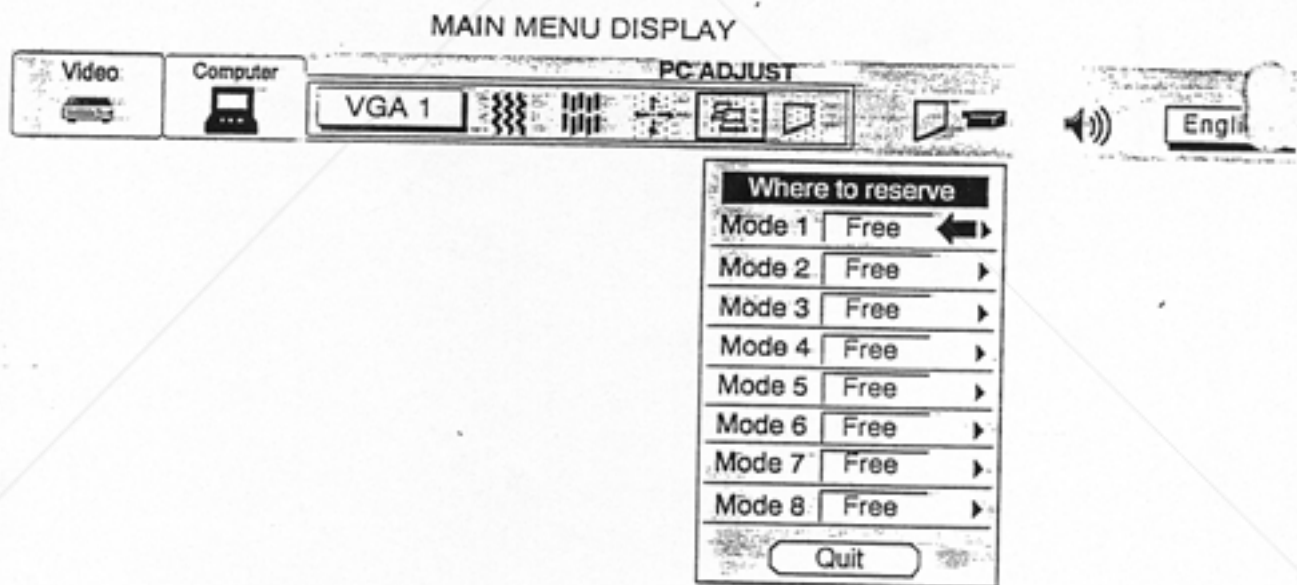

6. Another dialog box "PC ADJUSTMENT DISPLAY 1" will appear and the parameter data for the Mode you have selected is shown in this dialog box.
7. The parameters will be filled with the data determined by the projector according to the present signal input.
8. The function of the parameters and their values are summarized in the table as below.
9. Move the arrow to an item that you want to adjust by pressing POINT UP/DOWN button(s).
10. To increase the level, point the arrow to ▲ and then press SELECT button. To decrease the level, point the arrow to ▼ and then press SELECT button.
11. If you want to store the settings in the memory, move the arrow to Stored and press SELECT button. When you have stored the settings, "OK ?" is displayed for confirmation. Move the arrow to Yes and then press SELECT button.
12. To recall the parameter data before setting, move the arrow to Reset and then press SELECT button. When you have reset the settings, "OK ?" is displayed for confirmation. Move the arrow to Yes and then press SELECT button. You can adjust the settings again if needed.
13. To quit PC Adjustment Menu, move the arrow to Quit and then press SELECT button.
14. If you quit PC Adjustment Menu without storing the settings in the memory, the parameter data you changed will not be kept.
15. The stored settings are permanently held even if POWER ON/OFF is switched off.
16. Adjust the data such as a "Clamp", "Height" and "Width" if you needed, move the arrow by pressing POINT UP/DOWN button(s) to select ▼. Press SELECT button.

Continued to the next page.

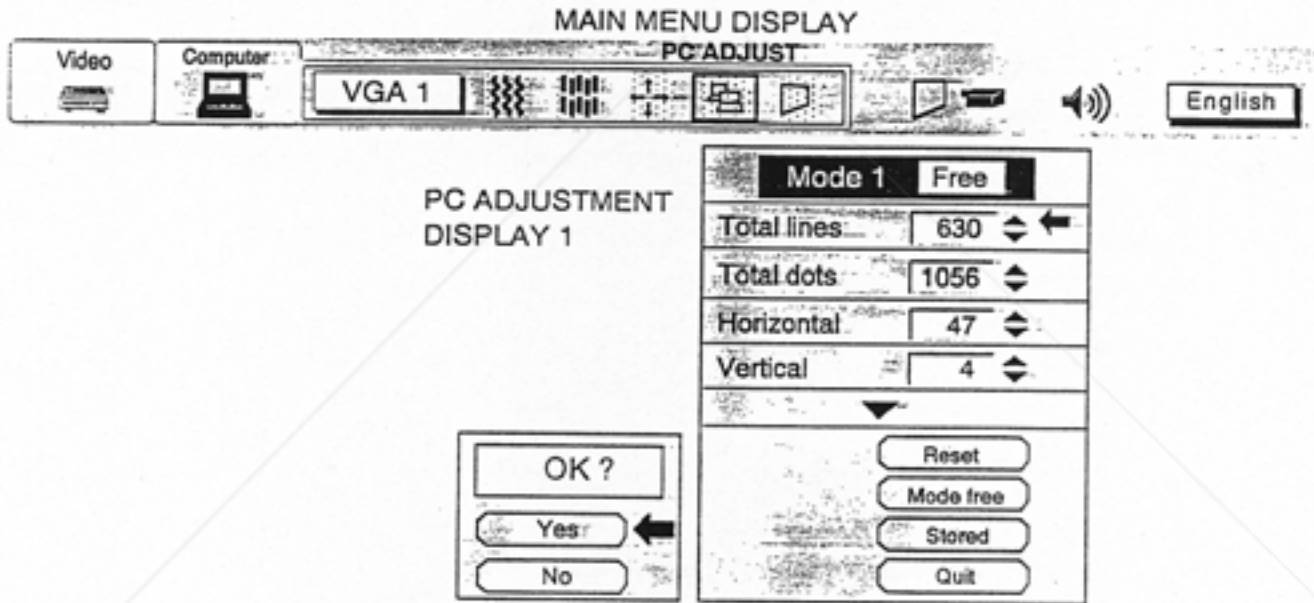

ITEM	FUNCTION
TOTAL LINES	The number of the total vertical lines. Adjust the number to match your PC image.
TOTAL DOTS	The number of the total dots in one horizontal period. Adjust the number to match your PC image.
HORIZONTAL	Adjustment of the horizontal picture position. When the image is not centered on the screen, adjust this.
VERTICAL	Adjustment of the vertical picture position. When the image is not centered on the screen, adjust this.

17. Another dialog box "PC ADJUSTMENT DISPLAY 2" will appear and the parameter data for the Mc have selected is shown in this dialog box.
18. Move the arrow to an item that you want to adjust by pressing POINT UP/DOWN button(s).
19. To increase the level, point the arrow to ▲ and then press SELECT button. To decrease the level, point the arrow to ▼ and then press SELECT button.
20. If you want to store the settings in the memory, move the arrow to Stored and press SELECT button. If you have stored the settings, "OK ?" is displayed for confirmation. Move the arrow to Yes and then press SELECT button.
21. To recall the parameter data before settings, move the arrow to Reset and then press SELECT button. If you have reset the settings, "OK ?" is displayed for confirmation. Move the arrow to Yes and then press SELECT button. You can adjust the settings again if needed.
22. To quit PC Adjustment Menu, move the arrow to Quit and then press SELECT button.
23. If you quit PC Adjustment Menu without storing the settings in the memory, the parameter data you change will not be kept.
24. The stored settings are permanently held even if POWER ON/OFF is switched off.

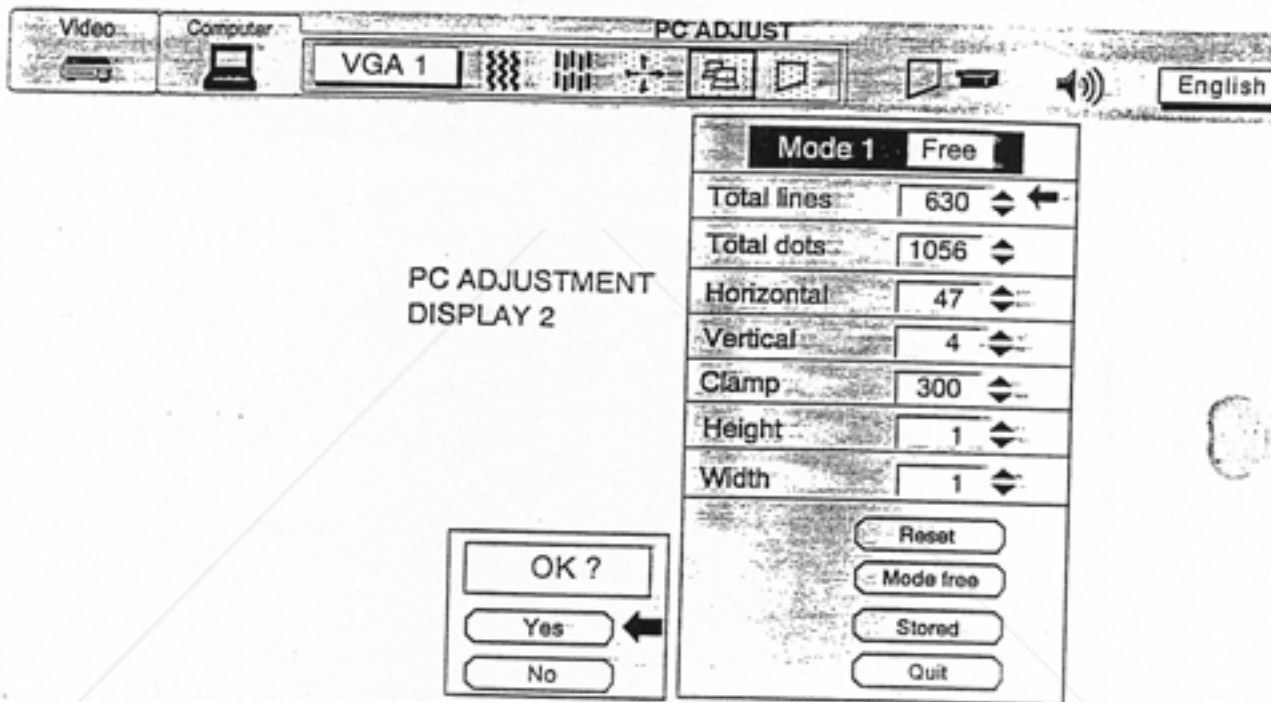

ITEM	FUNCTION
CLAMP	Adjustment of the clamp level. When the image has a dark bar, try this adjustment.
HEIGHT	Expanding or compressing level for the vertical direction.
WIDTH	Expanding or compressing level for the horizontal direction.

FixYourDLP.com
Sponsored by DM

Discount-Merchant.com (800) 281-8860
THE TRUSTED SOURCE FOR PROJECTOR LAMPS AND ACCESSORIES

MODE FREE

MODE FREE function is provided to confirm or clear the parameter data produced by PC ADJUST (Refer to Pages 36 - 38).

1. Press MENU button and MAIN MENU DISPLAY dialog box will appear.
2. Press POINT LEFT/RIGHT button(s) to select PC ADJUST and press SELECT button. Another dialog box "Where to reserve" will appear.
3. Press POINT DOWN button and a red arrow will appear.
4. Move the arrow to one of the "Modes" (Stored position) that you want to confirm by pressing POINT UP/DOWN button(s). Press SELECT button. Another dialog box "PC ADJUSTMENT DISPLAY" will appear.
5. To quit PC Adjustment Menu, point to Quit and then press SELECT button.
6. To modify the parameter data, perform the steps 9 - 24 of PC ADJUSTMENT SECTION on pages 37, 38.
7. To clear the parameter data, move the arrow by pressing POINT UP/DOWN button(s) to select Mode free. Press SELECT button. "OK?" is displayed for confirmation.
8. Move the arrow to Yes and then press SELECT button to clear the parameter data.
9. To quit PC Adjustment Menu, move the arrow to Quit and then press SELECT button.

MAIN MENU DISPLAY

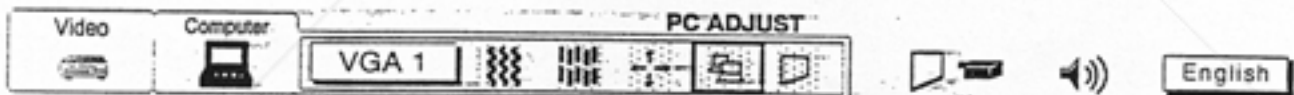
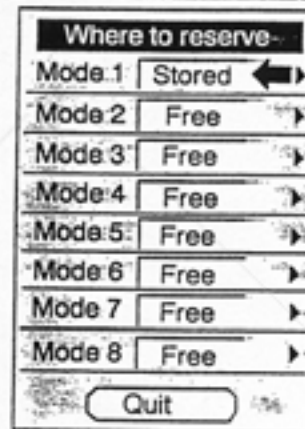
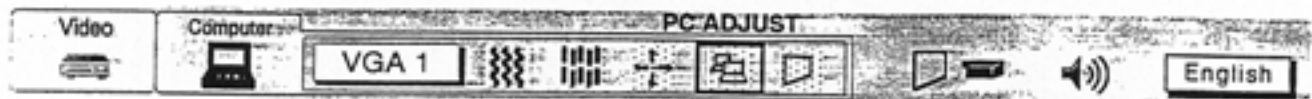

PC ADJUSTMENT DISPLAY

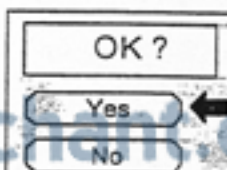
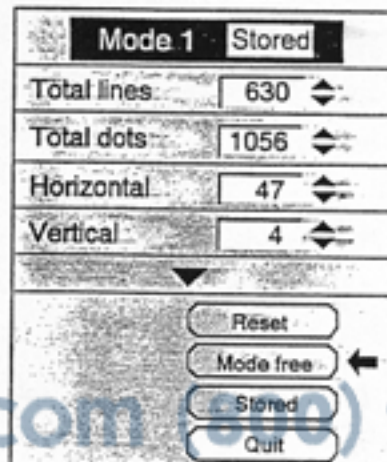

AUTO IMAGE FUNCTION (COMPUTER MODE)

The Auto image function is provided to automatically adjust Fine sync., Total dots and Screen position for computers.

1. Press MENU button and MAIN MENU DISPLAY dialog box will appear.
2. Press POINT LEFT/RIGHT button(s) to select AUTO IMAGE and press SELECT button. Another dialog AUTO IMAGE SETTING DISPLAY will appear.
3. Press POINT DOWN button and a red arrow will appear.
4. Move the arrow to an item(s) you want to adjust by pressing POINT UP/DOWN button(s).
5. Change the setting "On", press SELECT button.
6. Move the arrow by pressing POINT UP/DOWN button(s) to select "Go!" and then press SELECT button auto image function is started now. It will take at 10 - 60 seconds.
7. To store the settings, move the arrow to Stored and then press SELECT button. When you have store settings, "OK?" is displayed for confirmation.
8. Move the arrow to "Yes" and then press SELECT button. The stored settings are permanently held and POWER ON/OFF is switched off.
9. To quit Auto Image Menu, point to Quit and then press SELECT button.
10. This setting is temporarily effective until you turn off the projector or change the input signal.

NOTE: The fine sync., total dots and screen position of some computers may not be fully adjusted with the "Auto Image Function." In that case, use the "Picture Image" and/or "Picture Position" adjustments (see p 34-35) to make fine-adjust them after the "Auto Image function" is executed.

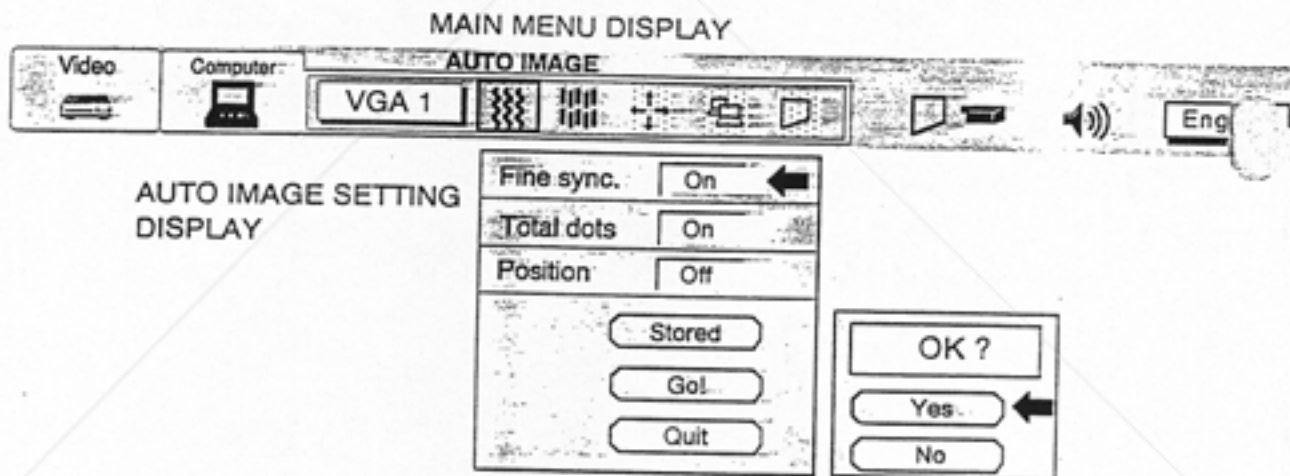

PICTURE SCREEN ADJUSTMENT (COMPUTER MODE)

This projector can adjust the image size and pan the image with PICTURE SCREEN ADJUSTMENT.

1. Press MENU button and MAIN MENU DISPLAY dialog box will appear.
2. Press POINT LEFT/RIGHT button(s) to select SCREEN and press SELECT button. Another dialog box SCREEN ADJUST DISPLAY will appear.
3. Press POINT DOWN button and a red arrow will appear.
4. To adjust the image size or pan the image, move the arrow to Digital zoom by pressing POINT UP/DOWN button(s) and then press SELECT button. MAIN MENU DISPLAY and SCREEN ADJUST DISPLAY will disappear and the message "Quit" is displayed to indicate Digital Zoom mode.
5. To expand the image size, press SELECT button. The image is magnified by degrees (Expand function).
6. To compress the image size, press RIGHT CLICK button on the remote control. The size of image is reduced by degrees (Compress function).
7. To pan the image, press POINT UP/DOWN/LEFT/RIGHT (JOYSTICK) button(s). The image move to the direction indicated (panning function).
8. To cancel Digital Zoom mode, press other buttons (except NO SHOW button).
9. To turn the image size to true size (800×600 in SVGA or XGA, and 640×480 in VGA), move the arrow to True by pressing POINT UP/DOWN button(s) and then press SELECT button. The image size is turned to the true size.

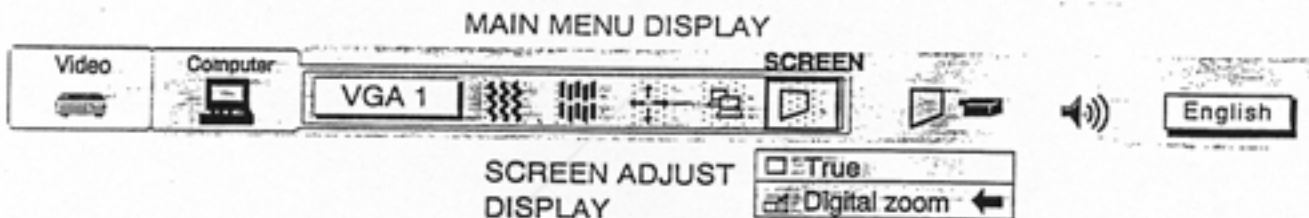

- This projector cannot display in the resolution more than 1024×768 . If your computer's screen resolution is higher than 1024×768 , reset the resolution to the lower before connecting the projector.
- The image data of VGA (640×480) or XGA (1024×768) is modified to fit the screen size in the initial mode.
- The maximum size in expand mode is 4 times as large as the screen size (804×604).
- The minimum size in compress mode is the screen size (804×604) in SVGA, XGA mode, or 640×480 in VGA mode.
- Panning function can work only when the image is expanded.

OTHER FUNCTION SETTING

This projector has other functions' settings; Blue Back, Display, Ceiling, Rear and Lamp Age (Refer to Page 44).

BLUE BACK

This function provide the blue image on the screen with no video noise when the input signal sou unplugged or turned off. Set this function "On" to make it available.

DISPLAY

When this function is in the "On" position, on-screen displays always appear when adjustments are r. Although these on-screen displays are very helpful, these may spoil the view if adjustments are made c presentations. To avoid this, you can keep back certain displays by switching this function "Off". followings are the displays that you can hide.

- Wait Display (Number counting down when turning on the projector)
- Mode Display
- Volume Display
- Mute Display
- Zoom/Focus Display
- No Show Display
- Normal Display

CEILING

This function provide top/bottom and left/right reversed picture for projecting from the ceiling-mounted projector. Set this function "On" to make it available.

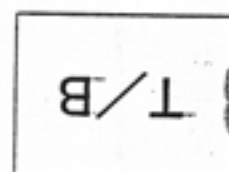
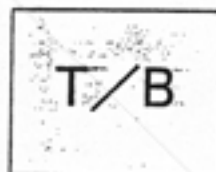

REAR

This function provide left/right reversed pictures for projecting onto a rear projection screen. Set this function "On" to make it available.

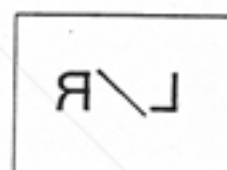
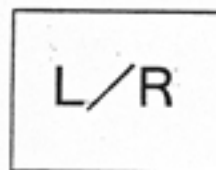

LAMP AGE

Lamp Age function is designed to reset the lamp replacement monitor timer. When replacing the lamp, r the lamp replacement monitor timer with this function.



Discount-Merchant.com (800) 281-8860
THE TRUSTED SOURCE FOR PROJECTOR LAMPS AND ACCESSORIES

AIR FILTER CARE AND CLEANING

The removable air filter prevents dust from accumulating on the surface of the projection lens and the projection mirror. Should the air filter become clogged with dust particles, it will reduce the cooling fan's effectiveness and may result in internal heat build up and shorten the life of the projector.

We recommend to clean the air filter following the procedures below:

1. Turn the POWER ON/OFF button OFF, and disconnect the AC power cord from the AC outlet.
2. Remove the air filter cover.
Press the cover latch sideways and lift the cover.
3. Remove the air filter from the filter cover.
4. Clean the air filter with a vacuum cleaner.
5. Replace the air filter. Make sure that air filter cover is fully inserted.



CAUTION

Do not operate the projector with air filter removed.

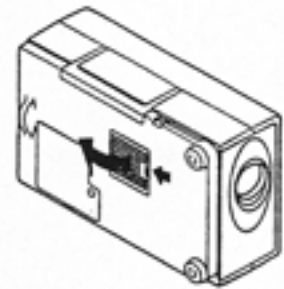

RECOMMENDATION

We recommend to avoid dusty/smoky place for operating the projector. Using in dusty place may cause the picture of poor quality.

When using under the dusty or smoky conditions, dust may accumulate on the liquid crystal panel and lens inside it, and may resultantly be projected on the screen together with the picture.

When the above symptoms are noticed contact your authorized dealer or service station for the cleaning.

AIR FILTER



TEMPERATURE WARNING INDICATOR

TEMPERATURE WARNING INDICATOR flashes red when the internal temperature of the projector exceeds the normal temperature.

Possible causes for the temperature warning may be:

1. Ventilation slots of the projector are blocked. In such an event, reposition the projector so that ventilation slots are not obstructed.

2. Air filter is clogged with dust particles. Remove dust from the air filter by following instructions in the Air Filter Care and Cleaning section above.

3. If temperature warning indicator remains on after performing the checks listed above, cooling fan/internal circuits may be malfunctioning. Request an authorized dealer or service station for maintenance.

TEMPERATURE
WARNING
INDICATOR

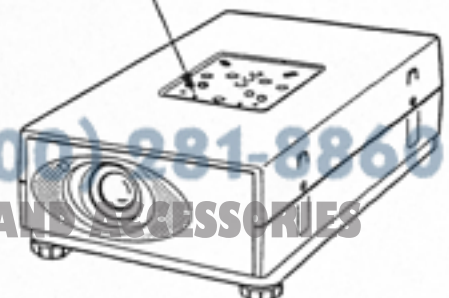

FixYourDLP.com

Discount-Merch.com (800) 881-8866
THE TRUSTED SOURCE FOR PROJECTOR LAMPS AND ACCESSORIES

LAMP REPLACEMENT

If the lamp fails to come on and LAMP REPLACEMENT INDICATOR on the projector is yellow, you must replace the lamp.



- For continued safety, replace with a lamp assembly of the same type.
- Allow the projector to cool for at least 45 minutes before you open the lamp cover. The inside of the projector can become very hot.
- Do not drop the lamp module or touch the glass bulb! The glass can shatter and cause injury.

Follow these steps to replace the lamp assembly.

1. Turn off the projector and allow the projector to cool thoroughly.
2. Disconnect the AC cord from the AC outlet.
3. Remove a screw with a screwdriver and remove the lamp cover.
4. Remove 2 screws with a screwdriver and pull out the lamp assembly by grasping the handle.
5. Replace the lamp assembly.
6. Tighten 3 screws to secure the lamp assembly and the lamp cover.
7. Connect the detachable AC cord to the projector.
8. Reset LAMP REPLACEMENT MONITOR TIMER. (See "LAMP AGE" section on page 44.)

LAMP REPLACEMENT INDICATOR

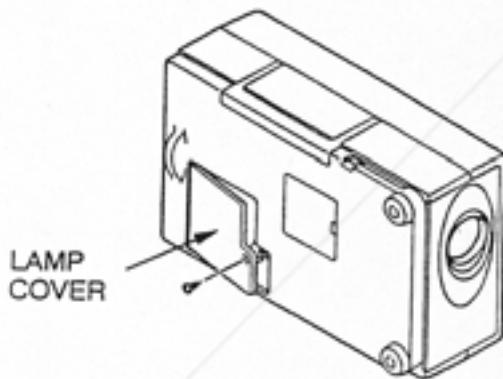
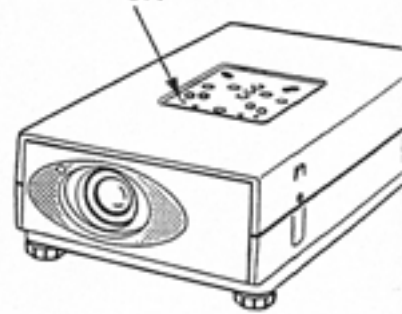

LAMP COVER

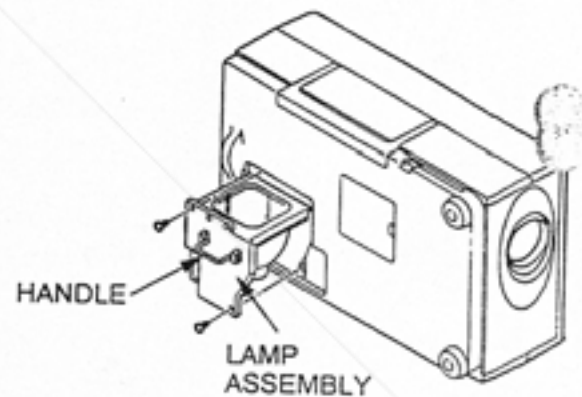

HANDLE

LAMP ASSEMBLY

NOTE: Do not reset the LAMP REPLACEMENT MONITOR TIMER, when the lamp is not replaced.

CLEANING THE LENS

Follow these steps to clean the projection lens:

1. Apply a non-abrasive camera lens cleaner to a soft, dry cleaning cloth.
Avoid using an excessive amount of cleaner.
Abrasive cleaners, solvents or other harsh chemicals might scratch the lens.
2. Lightly wipe the cleaning cloth over the lens.
3. When you don't use the projector, replace the lens cover.

TROUBLESHOOTING

Before calling your dealer or service station for assistance, follow these steps, in this order, to make sure everything is properly connected.

1. Make sure you have connected the projector to your equipment as described in section "CONNECTING THE PROJECTOR" on pages 10 - 15.
2. Check cable connections. Verify that all computer, video and power cord are properly connected.
3. Verify that all power is switched on.
4. If the projector still does not display an image, restart the computer.
5. If the image still does not display, unplug the projector from the computer and check the computer monitor's display. The problem may be with your graphics controller rather than with the projector. (When you reconnect the projector, remember to turn the computer and monitor off before you power up the projector. Power the equipment back up in order of: Projector, monitor, and computer)
6. If the problem still exists, check with following chart.

Problem:	Try these Solutions:
<p>No power</p>	<ul style="list-style-type: none"> ● Plug the projector into an AC outlet. ● Press POWER ON/OFF switch to ON. ● Be sure READY INDICATOR light is ON. ● Wait one minute after the projector is turned OFF before turning the projector back on. <p>NOTE: After pressing POWER ON/OFF button to OFF. The projector functions as follows.</p> <ol style="list-style-type: none"> 1. The LAMP indicator will light and the READY indicator will turn off. 2. After one minute, READY indicator will light green again and the projector may be turned on by pressing POWER ON/OFF button. <ul style="list-style-type: none"> ● Check TEMPERATURE WARNING indicator. If the indicator flashes red, the projector cannot be turned on. (See BASIC OPERATION on page 25). ● Check the projection lamp.
<p>Image is out of focus</p>	<ul style="list-style-type: none"> ● Adjust the focus. ● Make sure the projection screen is at least 1.1 m from the projector. ● Check the projection lens to see if it needs cleaning. <p>NOTE: Moving the projector from a cool temperature location to a warm temperature location may result in moisture condensation on the lens. In such an event, leave the projector OFF and wait until condensation disappears.</p>

FixYourDLP.com
 Sponsored by 

Discount-Merchants.com (800) 931-2350
THE TRUSTED SOURCE FOR PROJECTOR LAMPS AND ACCESSORIES

Problem:	Try these Solutions:
Picture is L/R Reversed.	Check Ceiling/Rear feature. (See "OTHER FUNCTION SETTING" section on pages 42 - 43).
Picture is T/B inverted.	Check Ceiling feature. (See "OTHER FUNCTION SETTING" section on pages 42 - 43).
Some displays are not seen during the operation.	Check Display feature. (See "OTHER FUNCTION SETTING" section on pages 42 - 43).
No sound.	<ul style="list-style-type: none"> ● Check audio cable connection from audio input source. ● Adjust audio source. ● Press VOLUME (+) button. ● Press MUTE button.
Remote control unit doesn't work.	<ul style="list-style-type: none"> ● Check the batteries. ● Make sure nothing is blocking between the remote control sensor and remote control unit. ● Make sure you are not too far from the projector when using the remote control unit. (Maximum operate range 16.4 feet (5 m)).
Wireless mouse function does not work.	<ul style="list-style-type: none"> ● Check the cable connection between the projector and the computer. ● Check the mouse setting on your computer. ● Turn on the projector before you turn on the computer.

Where to Get Help:

If you still need help after checking the table above, you should call your dealer's technical support line and explain your problem.

If your dealer cannot solve your problem, please call Proxima's customer service. The number is:

USA or Canada Phone (800) 447-7694

FAX (619) 457-8542

Rest of World Phone (619) 457-5500

Europe Phone +31-43-358-5200

Support FAX +31-43-358-5201

<http://www.proxima.com>



Discount-Merchant.com (800) 281-8860

THE TRUSTED SOURCE FOR PROJECTOR LAMPS AND ACCESSORIES

TECHNICAL SPECIFICATIONS

SPECIFICATIONS

Projector Type	ULTRALIGHT LS1
Dimensions (W x H x D)	8.5" (215 mm) × 4.3" (109 mm) × 12.4" (315 mm)
Net Weight	8.4 lbs (3.8 kg)
LCD Panel System	0.9" TFT Active Matrix type × 3
Panel Resolution	804 × 604 dots
Number of Pixels	1,456,848 (485,616 × 3)
Colour System	PAL, SECAM, NTSC and NTSC4.43
Scanning Frequency	H-sync. 15 – 80 KHz, V-sync. 50 – 100 Hz
Projection Image Size (Diagonal)	Adjustable from 20" to 300"
Contrast Ratio	250 :1
Horizontal Resolution	750 TV lines
Projection Lens	F2.3 – 3.0 lens with f36mm – 57.6mm Motor zoom and focus
Throw Distance	3.6' (1.1 m) – 37.7' (11.5 m)
Projection Lamp	UHP, 120 watt type
Projection Mirror	Diachronic mirror and X-prism system
Key Stone Correction	10 : 0.5
AV Input jacks	Phono Type × 1 (Video, Audio R and L) and DIN 4 pin (S-Video) × 1
Computer Input Jack	(VGA) HDB15 Terminal × 1, Multi-pole 12 pin (Control port) × 1
Control Port Jack	Multi-pole 12 pin (Control port) × 1
Serial Port Jack	Serial Port DIN 8 pin
Monitor Output Jack	(VGA) HDB15 Terminal × 1
Computer Audio Input Jack	Mini Jack (stereo)
Internal Audio Amp	1W RMS (MONO)
Audio Out Jacks	Mini Jack (stereo)
Built-in Speaker	4 × 3 cm × 1 (Monaural)
Feet Adjustment	0 to 2°
Voltage	100 – 120V, 200 – 240V AC, 50/60 Hz
Power Consumption	2.0/1.2A (Max. Ampere)
Operating Temperature	41°F to 95°F
Storage Temperature	14°F to 140°F
Remote Control Battery	(2) AAA Type
	AC power cord, remote control transmitter and batteries, VGA cable, VGA/MAC adapter, mouse cables (for PS/2 port × 1, for serial port × 1, for ADB port), lens cover, protective dust cover

FixYourDLR.com
Sponsored by DM

Discount-Merchant.com (800) 281-8860
THE TRUSTED SOURCE FOR PROJECTOR LAMPS AND ACCESSORIES



This symbol on the nameplate means the product is Listed by Underwriters Laboratories Inc. It is designed and manufactured to meet rigid U.L. safety standards against risk of fire, casualty and electrical hazards.



Disclaimer

This user manual is provided as a free service by FixYourDLP.com. FixYourDLP is in no way responsible for the content of this manual, nor do we guarantee its accuracy. FixYourDLP does not make any claim of copyright and all copyrights remain the property of their respective owners.

About FixYourDLP.com

FixYourDLP.com (<http://www.fixyourdlp.com>) is the World's #1 resource for media product news, reviews, do-it-yourself guides, and manuals.

Informational Blog: <http://www.fixyourdlp.com>

Video Guides: <http://www.fixyourdlp.com/guides>

User Forums: <http://www.fixyourdlp.com/forum>

FixYourDLP's Fight Against Counterfeit Lamps:

<http://www.fixyourdlp.com/counterfeits>

Sponsors:

RecycleYourLamp.org – Free lamp recycling services for used lamps:

<http://www.recycleyourlamp.org>

Lamp Research - The trusted 3rd party lamp research company:

<http://www.lampresearch.com>

Discount-Merchant.com – The worlds largest lamp distributor:

<http://www.discount-merchant.com>



FixYourDLP.com

Sponsored by 