



Disclaimer

This user manual is provided as a free service by FixYourDLP.com. FixYourDLP is in no way responsible for the content of this manual, nor do we guarantee its accuracy. FixYourDLP does not make any claim of copyright and all copyrights remain the property of their respective owners.

About FixYourDLP.com

FixYourDLP.com (<http://www.fixyourdpl.com>) is the World's #1 resource for media product news, reviews, do-it-yourself guides, and manuals.

Informational Blog: <http://www.fixyourdpl.com>

Video Guides: <http://www.fixyourdpl.com/guides>

User Forums: <http://www.fixyourdpl.com/forum>

FixYourDLP's Fight Against Counterfeit Lamps:

<http://www.fixyourdpl.com/counterfeits>

Sponsors:

RecycleYourLamp.org – Free lamp recycling services for used lamps:

<http://www.recycleyourlamp.org>

Lamp Research - The trusted 3rd party lamp research company:

<http://www.lampresearch.com>

Discount-Merchant.com – The worlds largest lamp distributor:

<http://www.discount-merchant.com>



FixYourDLP.com

Sponsored by 



DESKTOP PROJECTOR™ 6150/6100



English
Deutsch
Français
Español
Italiano
Português

 FixYourDLP.com
Sponsored by 

Discount-Merchant.com (800) 281-9860

THE TRUSTED SOURCE FOR PROJECTOR LAMPS AND ACCESSORIES

proxima®



WARRANTY (US, Latin America and Canada only)

Proxima Corporation warrants that the projector product manufactured by Proxima is free from defects in materials and workmanship under normal use during the Warranty Period. The Warranty Period commences on the day of purchase by the end user. The Warranty Period of the projector is two years. The lamp Warranty Period is 90 days or 500 hours which ever comes first. Each Proxima product is manufactured from new parts, or new and some used parts. In some cases, the product may have been delivered to another end-user and then returned. In all cases, the product has undergone testing and quality inspection, and Proxima's full warranty terms apply. The end-user's sales receipt or invoice showing the date of purchase of the product and the name of the Reseller is proof of date of purchase. The Warranty extends only to the original purchaser and is not transferable. During the Warranty Period, Proxima will, at no additional charge, repair or replace defective parts or at the option of Proxima, replace the entire unit.

This limited Warranty does not extend to any Proxima product that has been damaged or been rendered defective (a) as a result of accident, misuse or other abuse; (b) by the use of parts not manufactured or sold by Proxima; (c) by modification of the product; or (d) as a result of servicing by non-authorized personnel.

ProCare Service Programs (US and Canada only)

Proxima offers optional service programs available for purchase, in addition to the standard Factory Warranty. Extended Warranties are available in one- and two-year options, for up to four years of coverage and are available to purchase anytime while the projector is still in warranty.

ProXchange offers the original purchaser the option of having a replacement unit shipped (in most cases) the next business day to the location within the covered regions of their choice. By choosing ProXchange, the original purchaser will receive a new or "like new" unit which they will keep. The replacement projector will be covered by the remaining balance of the original Warranty Period or any Extended Warranties if applicable. Proxima will not return the non-working projector originally purchased.

Spare in the Air is a factory loaner program that provides the original purchaser with a projector the next business day (in most cases) and returns the original unit back to the customer once it is repaired.

ProXchange and Spare in the Air are available for purchase at the time of the projector purchase and are only valid while the projector is covered by either its Factory or Extended Warranty. To execute either the ProXchange or Spare in the Air process, proof of date of purchase and a valid credit card number for security are required. If the non-working unit returned to Proxima is damaged or the warranty has been voided, the original purchaser will be responsible for the costs to repair the out of warranty conditions. All other in-warranty repairs will be covered by Proxima.

Limitation of Warranties

The foregoing Warranty is expressly in lieu of any other expressed or implied warranties including, without limitations, warranties of merchantability or fitness for a particular purpose. To the extent not prohibited by law, all statutory warranties are hereby waived and excluded from this Warranty. Proxima expressly disclaims all warranties not stated in this Limited Warranty.

Trademarks

Proxima is a registered trademark of Proxima Corporation. Desktop Projector, Desktop Projection, ProXchange and Laser F/X are trademarks of Proxima Corporation. Other trademarks are the property of their respective owners.

© 2000 Proxima Corporation. All rights reserved. Specifications are subject to change without notice.



San Diego, CA 92121-2298
USA
Phone (800) 447-7692, option 2.
Fax (858) 457-9647
<http://www.proxima.com>

For Europe/Middle East/Africa:
Proxima Netherlands
Horsterweg 24

6191 RX Beek
The Netherlands
Tel: +31 (0)43 358 52 00
Fax: +31 (0)43 358 52 01
<http://www.proxima.com>

For Asia:
Proxima Singapore
29, Int Business Park
04-02 Acer Bldg, Tower B
609923 Singapore
Singapore
Tel: +65 566 8102
Fax: +65 565 1080
<http://www.proxima.com>

Discount-Merchant.com (800) 860-8600
THE TRUSTED SOURCE FOR PROJECTOR LAMPS AND ACCESSORIES

| | |
|-----------------------------------------------------------------------------------------------------------------------------------------------------------------------------------------------------------------------------------------------------------------------------------------------------------------------------------------------------------------------------------------------------------------------------------------------------------------------------------------------------------------------------------------------------------------------------------------------------------------------------------------------------------------------------------------------------------------------------------------------------------------------------------------------------------------------------------------------------------------------------------------------------------------------------------------------------------------------------------------------------------------------------------------------------------------------------------------------------------------------------------------------------------------------------------------------------------------------------------------------------------------------------------------------------------------------------------------------|----------------------------------------------------------------------------------------------------------------------------------------------------------------------------------------------------------------------------------------------------------------------------------------------------------------------------------------------------------------------------------------------------------------------------------------------------------------------------------------------------------------------------------------------------------------------------------------------------------------------------------------------------------------------------------------------------------------------------------------------------------------------------------------------------------------------------------------------------------------------------------------------------------------------------------------------------------------------------------------------------------------------------------------------------------------------------------------------------------------------------------------------------------------------------------------------------------------------------------------------------------------------------------------------------------------------------------------------------------------------------------------------------------------------------------------------------------------------------------------------|
| <p>A. SUPPLIED MATERIAL.....4 LIEFERUMFANG EQUIPEMENT FOURNI MATERIAL SUMINISTRADO MATERIALE FORNITO MATERIAL FORNECIDO VEDLAGT MATERIELL</p> <p>B. SETTING UP PROCEDURE.....6 ANSCHLUSS INSTALLATION PROCEDIMIENTO DE CONEXIÓN PROCEDIMENTO DI IMPOSTAZIONE INSTALAÇÃO OPPSETT</p> <p>C. START - STOP.....8 START - STOP MISE EN/HORS SERVICE ENCENDIDO - APAGADO AVVIO - ARRESTO LIGAR - DESLIGAR START - STOPP</p> <p>D. IMAGE ADJUSTMENTS.....9 BILDEINSTELLUNGEN MISE AU POINT DE L'IMAGE AJUSTE DE LA IMAGEN REGOLAZIONE DELL'IMMAGINE AJUSTES DA IMAGEM JUSTERE BILDET</p> <p>E. REMOTE CONTROL & KEYBOARD.....10 FERNBEDIENUNG UND BEDIENFELD TELECOMMANDE ET CLAVIER CONTROL REMOTO Y TECLADO TELECOMANDO E TASTIERA CONTROLE REMOTO E TECLADO FJERNKONTROLL OG TASTATUR</p> <p>F. MENU ADJUSTMENTS.....13 MENÜ EINSTELLUNGEN OPTIONS DE MENU MENÚ DE AJUSTES IMPOSTAZIONI DAL MENU AJUSTES DO MENU MENYINNSTALLINGER</p> <p>G. CONTROL RS 232.....18 STEUERN SIE RS 232 CONTROLLES RS 232 CONTROLE RS 232 GESTIRE RS 232 CONTROLE RS 232 KONTROLL RS 232</p> | <p>H. OVERVIEW / CEILING MOUNT.....19 ÜBERSICHT / DECKENMONTAGESATZ PRESENTATION / MONTAGE AU PLAFOND VISTA GENERAL / MONTAJE EN EL TECHO PROSPETTO / MONTATURA PER IL SOFFITTO VISTA GERAL / SUPORTE DE TETO OVERSIKT / TAKMONTASJE</p> <p>I. LIGHT MESSAGES.....20 LEUCHTANZEIGEN INDICATEURS LUMINEUX INDICADORES LUMINOSOS MESSAGGI LUMINOSI INDICADORES LUMINOSOS LYSSIGNALER</p> <p>J. POWER MANAGEMENT (DPMS).....22 POWER MANAGEMENT (DPMS) GESTION DE L'ALIMENTATION (DPMS) FUENTES DE ENERGIA (DPMS) CONTROLLO DELL'OPERATIVITÀ (DPMS) CONTROLE DA POTÊNCIA STRØMSPARING (DPMS)</p> <p>K. TROUBLESHOOTING.....23 FEHLERBEHEBUNG SOLUTION AUX PROBLÈMES LES PLUS FRÉQUENTS SOLUCIÓN DE PROBLEMAS SOLUZIONE DEI PROBLEMI LOCALIZAÇÃO DE DEFEITOS FEILSØKING</p> <p>L. TECHNICAL DATA.....25 TECHNISCHE DATEN CARACTERISTIQUES TECHNIQUES DATOS TÉCNICOS DATI TECNICI DADOS TÉCNICOS TEKNISKE DATA</p> <p>M. SERVICE INFORMATION.....28 SERVICEHINWEIS RÉPARATIONS INFORMACIÓN SOBRE ASISTENCIA TECNICA ASSISTENZA TECNICA INFORMAÇÃO DE SERVICOS SERVICEINFORMASJON</p> <p>N. MAINTENANCE.....29 WARTUNG ENTRIEN MANTENIMIENTO MANUTENZIONE MANUTENÇÃO VEDLIKEHOLD</p> <p>O. FCC STATEMENT.....31</p> |
|-----------------------------------------------------------------------------------------------------------------------------------------------------------------------------------------------------------------------------------------------------------------------------------------------------------------------------------------------------------------------------------------------------------------------------------------------------------------------------------------------------------------------------------------------------------------------------------------------------------------------------------------------------------------------------------------------------------------------------------------------------------------------------------------------------------------------------------------------------------------------------------------------------------------------------------------------------------------------------------------------------------------------------------------------------------------------------------------------------------------------------------------------------------------------------------------------------------------------------------------------------------------------------------------------------------------------------------------------|----------------------------------------------------------------------------------------------------------------------------------------------------------------------------------------------------------------------------------------------------------------------------------------------------------------------------------------------------------------------------------------------------------------------------------------------------------------------------------------------------------------------------------------------------------------------------------------------------------------------------------------------------------------------------------------------------------------------------------------------------------------------------------------------------------------------------------------------------------------------------------------------------------------------------------------------------------------------------------------------------------------------------------------------------------------------------------------------------------------------------------------------------------------------------------------------------------------------------------------------------------------------------------------------------------------------------------------------------------------------------------------------------------------------------------------------------------------------------------------------|

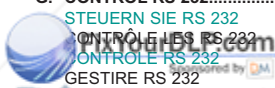

Discount-Merchant.com (800) 281-8860

THE TRUSTED SOURCE FOR PROJECTOR LAMPS AND ACCESSORIES

A SUPPLIED MATERIAL *)

LIEFERUMFANG EQUIPEMENT FOURNI MATERIAL SUMINISTRADO MATERIALE FORNITO MATERIAL FORNECIDO VEDLAGT MATERIELL

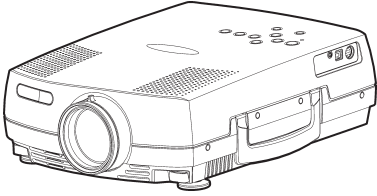

LCD Projector with lenscap
 LCD Projektor mit Schutzkappe
 Projecteur LCD avec protection lentille
 Projector LCD con tapa del lente
 Proiettore LCD con coperchietto
 Projektor LCD com protetor de lente
 LCD-projektor med linsedeksel

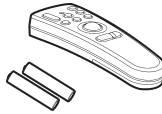

Remote control with batteries
 Fernbedienung mit Batterien
 Télécommande avec batteries
 Control remoto con pilas
 Telecomando con batterie
 Controle remoto com pilhas
 Fjernkontroll med batterier

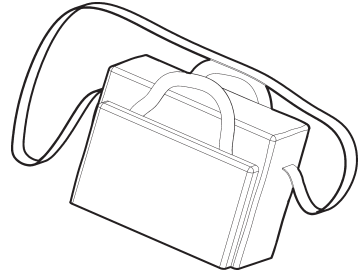

Soft Case
 Tragetasche
 Etui souple
 Funda
 Valigetta
 Maleta
 Myk veske

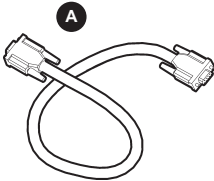

Analog Computer Cable (VGA)
 Analogkabel (VGA)
 Câble ordinateur analogique (VGA)
 Cable para ordenador analógico (VGA)
 Cavo analogico per il computer (VGA)
 Cabo de Computador Analógico (VGA)
 Analog Datamaskinkabel (VGA)

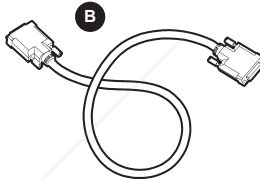

Digital Computer Cable (DVI)
 Digitalkabel (DVI)
 Câble ordinateur digital (DVI)
 Cable para ordenador digital (DVI)
 Cavo digitale per il computer (DVI)
 Cabo de Computador Digital (DVI)
 Digital Datamaskinkabel (DVI)

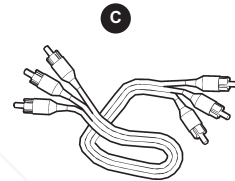

Audio/Video Cable
 Audio/Videoekabel
 Câble audio/vidéo
 Conexión de audio/vidéo
 Cavo audio/vidéo
 Cabo de Áudio/Video
 Audio/Videoekabel

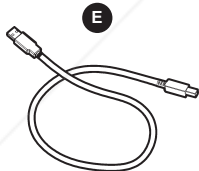

USB Mouse Cable by DM
 USB Maus kabel
 Câble souris USB
 Cable raton USB
 Cavo mouse USB
 Cabo de Mouse USB
 USB-musekabel

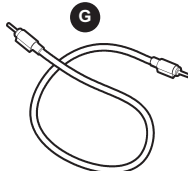

Audio Cable
 Audiokabel
 Câble audio
 Cable de audio
 Cavo audio
 Cabo de Audio
 Audiokabel

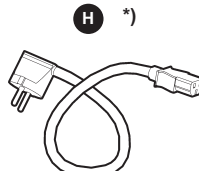

Power cord
 Netzkabel
 Cordon d'alimentation
 Cable de alimentación
 Cavo alimentazione
 Cabo de alimentação
 Strömledning

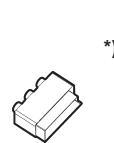

SCART adapter
 SCART-Anschluss
 Adaptateur audio
 Adaptador de Scanner
 Presa scart
 Adaptador SCART
 SCART-adapter



FixYourDLP.com

Discount-Merch.com (800) 441-8860
 THE TRUSTED SOURCE FOR PROJECTOR LAMP AND ACCESSORIES

*) Country dependent Länder abhängig Dépendant du pays Dependente del país Dipendentemente al paese di destinazione Dependendo do país Områdeavhengig

F



Mouse Cable
 Mauskabel
 Câble souris
 Cable raton
 Cavo mouse
 Cabo de Mouse
 Musekabel

F1



PS/2 mouse adapter
 PS/2 Adapter der Maus
 PS/2 Adaptateur de la souris
 PS/2 Adaptador del ratón
 PS/2 Adattotore del mouse
 PS/2 Adaptador do rato
 PS/2 Musadapter

F2

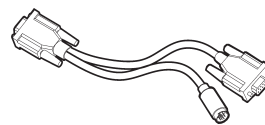

Serial PC mouse adapter
 Serien PC Mausadapter
 Adaptateur séquentiel de souris de PC
 Adaptador serial del ratón de la PC
 Adattatore seriale del mouse del PC
 Adaptador de série do rato do PC
 Serie PC Musadapter

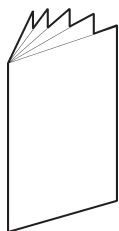

User guide
 Benutzer Handbuch
 Guide d'utilisateur
 Guía del usuario
 Manuale d'uso
 Guia do usuário
 Bruker veiledning



Discount-Merchant.com (800) 281-8860
THE TRUSTED SOURCE FOR PROJECTOR LAMPS AND ACCESSORIES

*) Country dependent Länder abhängig Dépendant du pays Dependente del país Dipendentemente al paese di destinazione Dependendo do país Områdeavhengig

1. Connect the projector to:
 - the data source with the Analog Computer Cable (A) to ANALOG COMPUTER VGA (2) or
 - the data source with the Digital Computer Cable (B) to DIGITAL COMPUTER DVI (1)
 - the video source with the Video Cable (C) to VIDEO/AUDIO IN
 - the video source with the S-Video Cable (optional) (D) to S-VIDEO
2. For the mouse control connect:
 - the USB Mouse Cable (E) to MOUSE 2 (USB), when using DIGITAL COMPUTER DVI (1) or ANALOG COMPUTER VGA (2)
 - the Mouse Cable (F) to MOUSE 1 with appropriate adapter (F1 or F2), when using ANALOG COMPUTER VGA (3)
3. For computer sound connection, use:
4. Connect power cord to projector (H)
5. Turn on the projector, then the source(s)

1. Projektör anschließen:
 - mit dem Analogkabel (A) an ANALOG COMPUTER VGA (2) (Datenquelle) oder
 - mit dem Digitalkabel (B) an DIGITAL COMPUTER DVI (1) (Datenquelle)
 - mit Videokabel (C) an VIDEO/AUDIO IN (Videoquelle)
 - mit S-Video-kabel (optional) (D) an S-VIDEO (Videoquelle)
2. Für Maussteuerung:
 - das USB-Mauskabel (E) in den Anschluss MOUSE 2 stecken, nur bei DIGITAL COMPUTER DVI (1) oder ANALOG COMPUTER VGA (2)
 - Mauskabel (F) mit passendem Adapter (F1 oder F2) an MOUSE 1 anschließen, nur bei ANALOG COMPUTER (3)
3. Für Klang aus dem Computer das Audiokabel (G) in den Anschluss AUDIO IN stecken
4. Netzstecker des Projektors einstecken (H)
5. Zuerst Projektör und dann Quellgerät(e) einschalten

1. Connectez le projecteur à:
 - la source de donnée avec le Câble ordinateur analogique (VGA) (A) à la ANALOG COMPUTER VGA (2)
 - la source de donnée avec le Câble ordinateur digital (DVI) (B) à la DIGITAL COMPUTER DVI (1)
 - la source vidéo avec le Câble video (C) à la prise VIDEO IN/AUDIO IN
 - la source vidéo avec le Câble S-Video (en option) (D) à la prise S-VIDEO
2. Pour travailler avec la souris, connectez:
 - le câble souris USB (E) à MOUSE 2, uniquement avec un DIGITAL COMPUTER DVI (1) ou un ANALOG COMPUTER VGA (2)
 - le Câble (F) de la souris à MOUSE 1 avec un adaptateur adéquat (F1 ou F2), uniquement avec un ANALOG COMPUTER VGA (3)
3. Pour la connexion au son de l'ordinateur, reliez le Câble audio (G) à AUDIO IN
4. Branchez le cordon d'alimentation sur le projecteur (H)
5. Allumez d'abord le projecteur, puis la (les) source(s).

1. Conectar el proyector a:
 - la fuente de datos conectando el cable para ordenador analógico (A) al ANALOG COMPUTER VGA (2) o
 - la fuente de datos conectando el cable para ordenador digital (B) al DIGITAL COMPUTER DVI (1)
 - la fuente de vídeo conectando el cable de vídeo (C) a la entrada VIDEO/AUDIO IN
 - la fuente de vídeo conectando el cable de VIDEO S (opcional) (D) al S-VIDEO
2. Para el control del ratón, conecte:
 - el Cable de ratón USB (E) al MOUSE 2, solamente con el DIGITAL COMPUTER DVI (1) o con el ANALOG COMPUTER VGA (2)
 - el Cable del Ratón (F) a MOUSE 1 con el adaptador apropiado (F1 ó F2), solamente con el ANALOG COMPUTER VGA (3)
3. Para conectar el sonido del ordenador, conecte el cable de audio (G) a la entrada AUDIO IN
4. Conectar el cable de alimentación al proyector (H)
5. Poner en marcha el proyector, luego la(s) fuente(s)

1. Collegare il proiettore:
 - alla sorgente dei dati con il cavo analogico per computer (A) al ANALOG COMPUTER VGA (2) o
 - alla sorgente dei dati con il cavo digitale per computer (B) al DIGITAL COMPUTER DVI (1)
 - Alla sorgente video con il cavo video (C) sulla presa VIDEO IN/AUDIO IN
 - Alla sorgente video con il cavo S-Video (opzionale) (D) sulla presa S-VIDEO
2. Per il controllo del mouse collegare:
 - il cavo USB del mouse (E) collegato a MOUSE 2, solo con DIGITAL COMPUTER DVI (1) o ANALOG COMPUTER VGA (2)
 - il Cavo del Mouse (F) a MOUSE 1 con l'apposito adattatore (F1 o F2), solo con ANALOG COMPUTER VGA (3)
3. Per il collegamento audio con il computer, usare il cavo audio (G) collegato a AUDIO IN
4. Collegare il cavo di alimentazione al proiettore (H)
5. Accendere prima il proiettore e poi la/e sorgente/i

1. Conecte o projetar à:
 - fonte de dados com o Cabo de Computador Analógico (A) em ANALOG COMPUTER VGA (2) ou
 - fonte de dados com o Cabo de Computador Digital (B) em DIGITAL COMPUTER DVI (1)
 - fonte de vídeo com o Cabo de Vídeo (C) em VIDEO IN/AUDIO IN
 - fonte de vídeo com o Cabo de S-Video (opcional) (D) em S-VIDEO
2. Para o controle do rato ligue:
 - o cabo USB do mouse (E) a MOUSE 2 (USB), somente com DIGITAL COMPUTER DVI (1) ou ANALOG COMPUTER VGA (2)
 - o Cabo do Rato (F) a MOUSE 1 com o adaptador adequado (F1 ou F2), somente com ANALOG COMPUTER VGA (3)
3. Para a conexão do computador, use o Cabo de Áudio (G) em AUDIO IN
4. Conecta o cabo de alimentação no projetor (H)
5. Ligue o projetor, depois a(s) fonte(s)

1. Koble projektoren til:
 - datakilden med den analoge datamaskinkabelen (A) til ANALOG COMPUTER VGA (2) eller
 - datakilden med den digitale datamaskinkabelen (B) til DIGITAL COMPUTER DVI (1)
 - videokilden med videokabelen (C) til VIDEO/AUDIO IN
 - videokilden med S-VIDEO-kabelen (valgfritt) (D) til S-VIDEO
2. Muskontroll kobles til:
 - med USB-muskabelen (E) til MOUSE 2 (USB), bare med DIGITAL COMPUTER DVI (1) eller ANALOG COMPUTER VGA (2)
 - med Musekabel (F) til MOUSE 1 med korrekt adapter (F1 eller F2), bare med ANALOG COMPUTER VGA (3)
3. Lyd fra datamaskinen kobles til med audiokabelen (G) til AUDIO IN
4. Koble strømledningen til projektoren (H)
5. Slå på projektoren, og deretter kilden(e)

SETTING UP PROCEDURE

ANSCHLUSS INSTALLATION PROCEDIMIENTO DE CONEXIÓN PROCEDIMENTO DI IMPOSTAZIONE INSTALAÇÃO OPPSETT

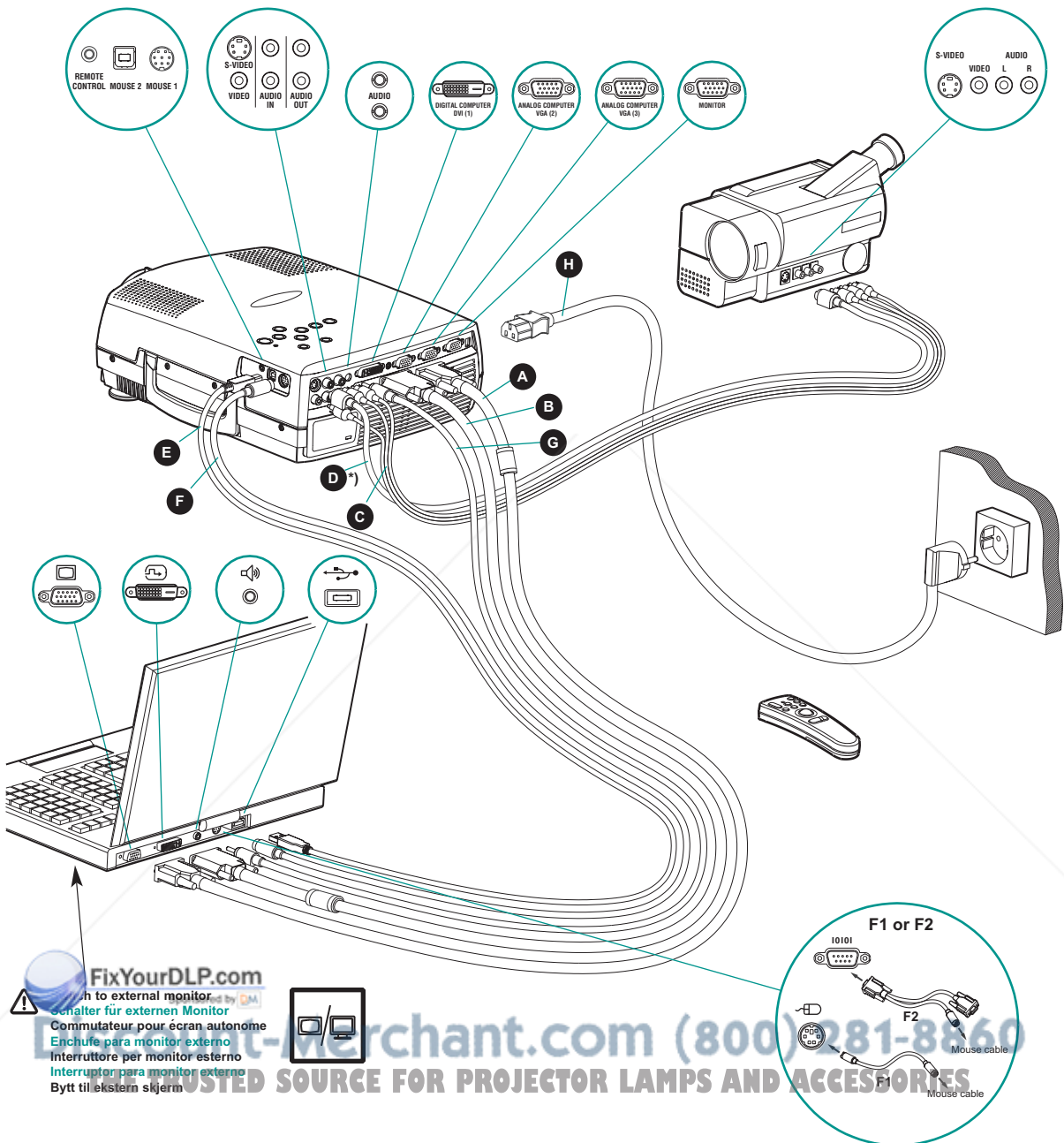



FixYourDLP.com
 Switch to external monitor
 Schalter für externen Monitor
 Commutateur pour écran autonome
 Enchufe para monitor externo
 Interruttore per monitor esterno
 Interruptor para monitor externo
 Bytt til ekstern skjerm

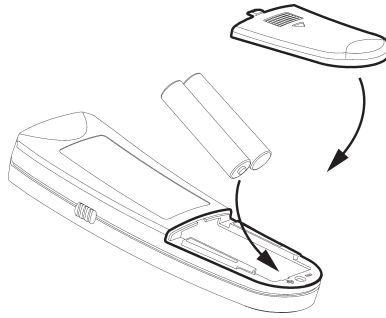

*) Optional equipment Zusatzausstattung Equipment optionnel Equipamiento opcional Componenti optional Equipamento opcional Tilleggsutstyr

Install batteries
 Batterien einlegen
 Mettre des piles en place
 Colocar las baterías
 Inserimento pile
 Colocar as pilhas
 Sett inn batteriene



Switch ON to operate remote control
 Auf ON stellen, um die Fernbedienung einzuschalten
 Mettez sur position ON pour utiliser la télécommande
 Poner el conmutador en ON para activar el control remoto
 Posizionare su ON per attivare il telecomando
 Coloque em on para ligar o controle remoto
 Trykk på ON for å slå på fjernkontrollen

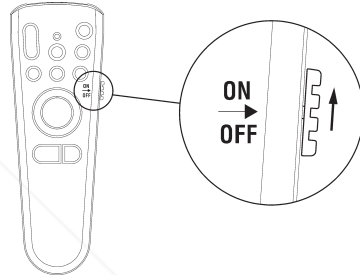

1

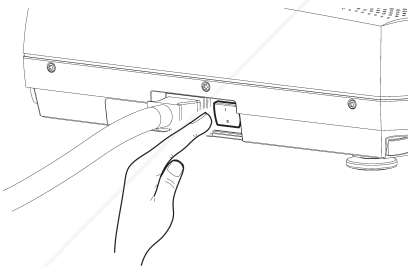

2

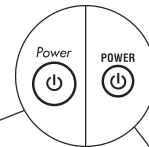
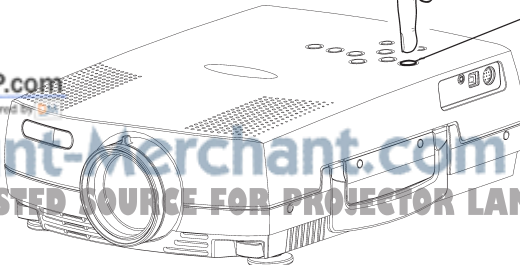

FixYourDLP.com
 sponsored by

Discount-Merchant.com (800) 281-8860
 THE TRUSTED SOURCE FOR PROJECTOR LAMPS AND ACCESSORIES

D IMAGE ADJUSTMENT

BILDESTELLUNG MISE AU POINT DE L'IMAGE ADJUSTE DE LA IMAGEN REGOLAZIONE ELL'IMMAGINE ADJUSTES DA IMAGEM JUSTERE BILDET

1

Zoom: adjust picture size
Zoom: Einstellen der Bildgröße
Zoom: règle les dimensions de l'image
Zoom: ajusta el tamaño de la imagen
Zoom: regola le dimensioni dell'immagine
Zoom: ajusta o tamanho da imagem
Zoom: justerer bildets størrelse

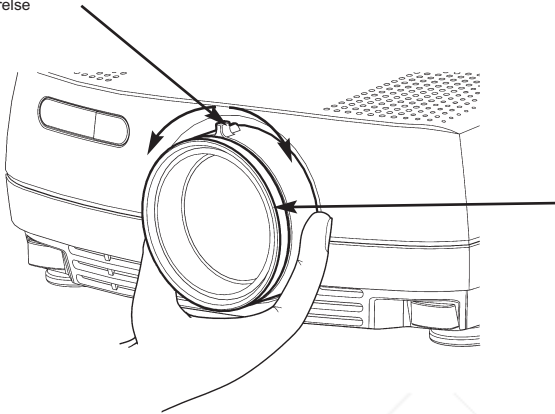

2

Focus: adjusts picture clearness
Focus: Einstellen der Bildschärfe
Focus: règle la netteté de l'image
Focus: ajusta la claridad de la imagen
Focus: regola la messa a fuoco dell'immagine
Focus: ajusta a nitidez da imagem
Fokus: justerer bildets skarphet

1

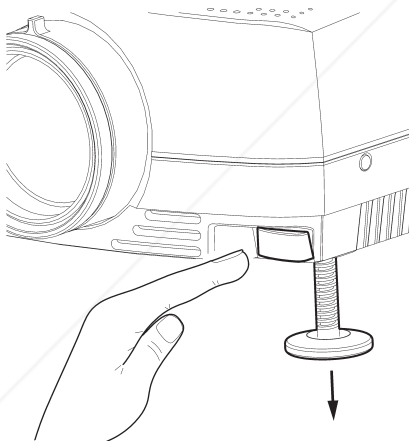

2

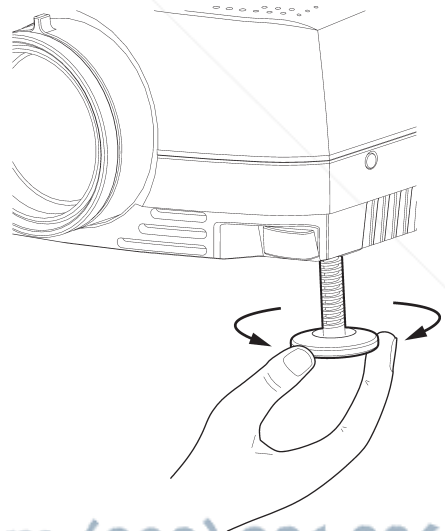

Release projector feet to adjust display angle (1) or manually adjust feet (2)

Fuß zur Einstellung des Projektionswinkels lösen (1) oder drehen (2)

Libère les pieds du projecteur pour régler l'angle de projection (1) ou régler les pieds manuellement (2)

Liberar la pata del proyector para ajustar el ángulo de presentación de imagen (1) o ajustar la pata manualmente (2)

Sblocca i piedi del proiettore per regolare l'angolazione dello schermo (1) o per regolare manualmente l'altezza dei piedi (2)

Solte os pés do projetor para ajustar o ângulo de exibição (1) ou ajuste os pés manualmente (2)

Frigjør projektorens føtter for å justere visningsvinkelen (1), eller justere føttene manuelt (2)

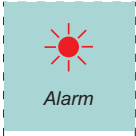
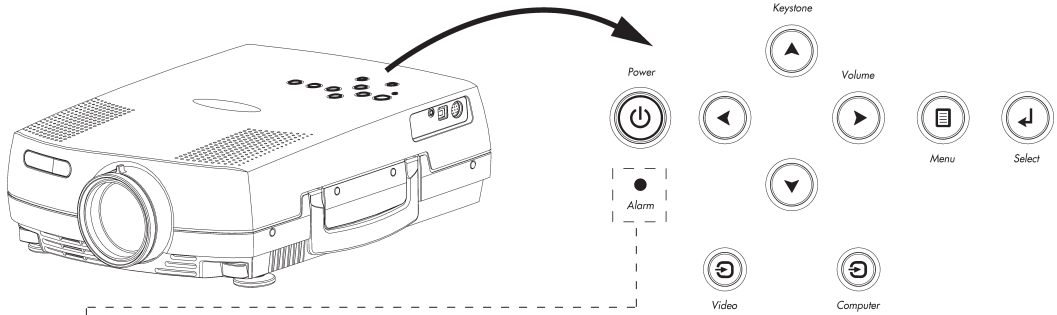

RED light indicates lamp replacement required. Ref. N (MAINTENANCE)
 Das ROTE Licht zeigt an, daß die Lampe ausgewechselt werden muß. Ref. N (WARTUNG)
 La lumière ROUGE indique que la lampe doit être remplacée. Ref. N (MAINTENANCE)
 La luz ROJA indica que se debe de reemplazar la bombilla. Ref. N (MANTENIMIENTO)
 La luce ROSA indica che bisogna sostituire la lampadina. Rif. N (MANUTENZIONE)
 A luz VERMELHA indica que a lâmpada deve ser substituída. Ref. N (MANUTENCÃO)
 RØDT lys angir at lampen må byttes ut. Se kap. N (VEDLIKEHOLD)



RED FLASHING when the projector is overheated. Power off and let cool down
 ROTES BLINKLICHT zeigt Überhitzung des Projektors an. Ausschalten und abkühlen lassen
 Un CLIGNOTEMENT ROUGE signale la surchauffe du projecteur. Débrancher l'alimentation et laisser refroidir
 LUZ ROJA PARPADEANTE cuando el proyector está sobrecalentado. Desconectar la alimentación y dejar enfriar
 La luce ROSSA INTERMITTENTE indica che il proiettore si è surriscaldato. Scollegare l'alimentazione e lasciare raffreddare
 A luz VERMELHA intermitente indica superaquecimento do projector. Desligar e deixar esfriar
 RØDT BLINKENDE når når projektoren er overopphetet. Slå av og la projektoren avkjøle seg

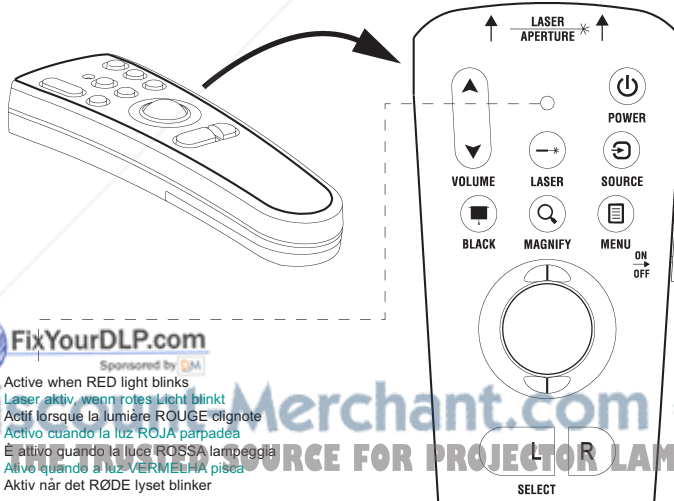

FixYourDLP.com

Sponsored by DM

Active when RED light blinks
 Laser aktiv, wenn rotes Licht blinkt
 Actif lorsque la lumière ROUGE clignote
 Activo cuando la luz ROJA parpadea
 È attivo quando la luce ROSSA lampeggia
 Ativo quando a luz VERMELHA pisca
 Aktiv når det RØDE lyset blinker

DirectForce.com (800) 281-8860

SELECT

- Activate by pressing actual key(s).
- Zum Aktivieren jeweilige Taste(n) drücken.
- Aktiver en pressant la (les) touches correspondante(s).
- Activar pulsando la(s) tecla(s) indicativa(s).
- Attivare premendo il / i tasto / i attivi.
- Ativar pressionando a(s) tecla(s) correspondante(s).
- Aktiver ved å trykke på aktuell(e) tast(er).

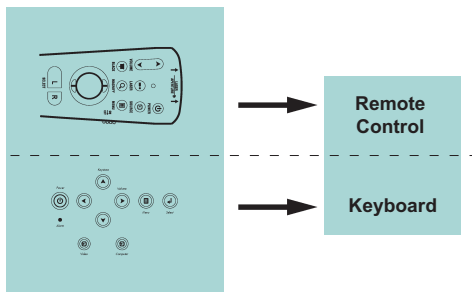

Turns the projector ON/OFF
 Projektor ein-/ausschalten
 Allume (ON)/Eteint (OFF) le projecteur
 Encender (ON)/Apagar (OFF) el proyector
 Accensione del proiettore ON/OFF
 Liga e Desliga o projetor
 Slår projektoren PÅ/AV

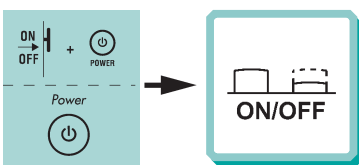

Adjust volume
 Lautstärke einstellen
 Régler le volume
 Ajustar el volumen
 Regolazione del volume
 Ajusta o volume
 Juster lydstyrken

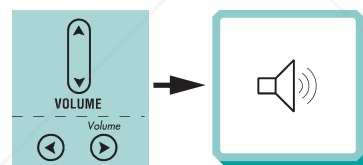

Blackens the projected image
 Bild verdunkeln
 Assombrir l'image
 Bajar la imagen proyectada a negro
 Oscuramento dell'immagine proiettata
 Preteja a imagem projetada
 Gjør bildet som vises sort



Adjust keystone angle
 Winkel Trapezverzerrung einstellen
 Régler de l'angle de la clef de voûte
 Ajustar el ángulo de distorsión de imagen
 Regolazione dell'angolo di distorsione
 Ajusta o ângulo trapezoidal
 Juster keystone-vinkelen



Switch between connected sources
 Zwischen angeschlossenen Geräten hin- und herschalten.
 Passage d'une source connectée à une autre source connectée.
 Conmutar entre las fuentes conectadas
 Commutazione fra le sorgenti collegate
 Alterna entre as fontes conectadas
 Bytt mellom de tilkoblede kildene

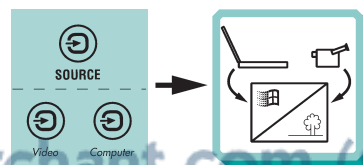

Activates/deactivates on screen menu (OSD)
 Bildschirmmenü aktivieren/deaktivieren (OSD)
 Active/Désactive le menu sur l'écran (OSD)
 Activa/desactiva el menú en pantalla
 Attivazione/disattivazione del menu sullo schermo
 Ativa/desativa o menu da tela
 Aktiverer/deaktiverer menyvisning på skjermen (OSD)

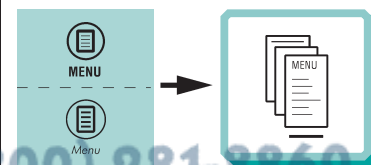

Discount-Merchant.com (800) 281-8860

THE TRUSTED SOURCE FOR PROJECTOR LAMPS AND ACCESSORIES

Scroll menu
 Menüpunkte ansteuern
 Menu déroulant
 Desplegar menú
 Scorrimento del menù
 Desloque-se no menu
 Gå gjennom menyen

Select on-screen menu function
 Funktion des Bildschirmmenüs aktivieren
 Sélectionnez une fonction du menu sur l'écran
 Seleccionar función de menú en pantalla
 Selezione della funzione sul menù dello schermo
 Selezione uma função no menu da tela
 Velg aktuell funksjon i menyen på skjermen

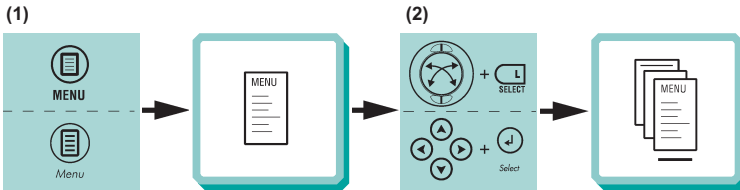

Press to zoom into picture
 Drücken, um Bild zu vergrößern
 Cliquez dans l'image pour faire un zoom
 Pulse para acercar la imagen
 Premere per ingrandire l'immagine
 Pressione para efetuar o "zoom" da imagem
 Press for å forstørre bildet

Press to pan
 Drücken, um zu panoramisieren
 Cliquez pour faire un panoramique
 Pulse para panorámica
 Premere per una panoramica
 Pressione para "pan"
 Press for å bevege bildet

Reset picture to full size
 Zurück zur Originalgröße
 Retour de l'image à ses dimensions
 Restablecer la imagen a tamaño completo
 Ripristino dell'immagine all dimensioni massime.
 Reajuste a imagem a seu tamanho máximo.
 Tilbakestill bildet til full størrelse

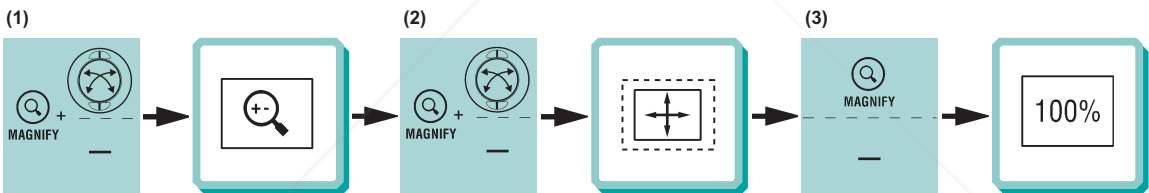

Laser pointer
 Laserzeiger
 Indicateur laser
 Puntero láser
 Puntatore laser
 Apontador laser
 Laserpeker

Mouse control
 Steuerung per Maus
 Contrôle souris
 Control del ratón
 Controllo del mouse
 Controle do mouse
 Musekontrol

FixYourDLP.com
 Sponsored by DM

DiscountMerch.com (800) 281-8860
 THE TRUSTED SOURCE FOR PROJECTOR LAMPS AND ACCESSORIES

Activate/deactivate by:
 Aktivieren/Deaktivieren mit:
 Activer et désactiver à l'aide:
 Activar/desactivar pulsando:
 Attivare/disattivare premendo:
 Ativa/Desativa com:
 Aktiver/deaktiver med:



Navigate by:
 Steuern mit:
 Pour naviguer:
 Navegar pulsando:
 Spostasi premendo:
 Navegar com:
 Naviger med:



Choose function with:
 Funktion wählen mit:
 Choisissez la fonction avec:
 Seleccionar función con:
 Scegliere la funzione:
 Escolha a função:
 Velg funksjon med:



1.0

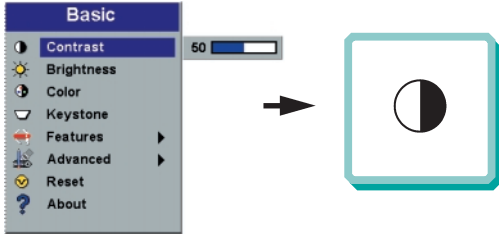

Adjusts contrast range from 0-100
 Kontrast von 0-100 einstellen
 Règle le contraste entre 0 et 100
 Ajusta el contraste entre 0-100
 Regolazione del contrasto da 0 a 100
 Ajusta o contraste de 0 a 100
 Justerer kontrasten innenfor området 0-100

4.0

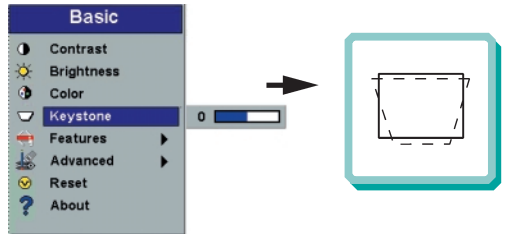

Adjust keystone from -63 to +64
 Trapezentzerrung von -63 bis +64 einstellen
 Règle la clé de voûte -63 et +64
 Ajusta la distorsión de imagen desde -63 a +64
 Regolazione della distorsione da -63 a +64
 Ajusta o ângulo trapezoidal de -63 a +64
 Justerer keystone-funksjonen fra -63 til +64

2.0

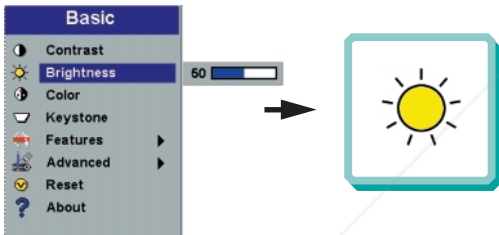

Adjusts brightness range from 0-100
 Helligkeit von 0-100 einstellen
 Règle la luminosité entre 0 et 100
 Ajusta el brillo entre 0-100
 Regolazione della luminosità da 0 a 100
 Ajusta o brilho de 0 a 100
 Justerer lysstyrken innenfor området 0-100

5.0

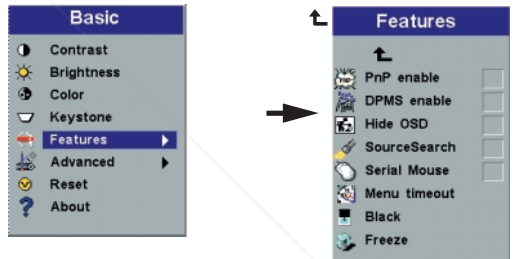

3.0

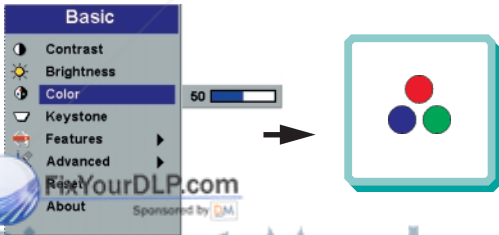

Adjusts colour intensity in video images from 0-100
 Farbintensität von Videobildern von 0-100 einstellen
 Règle l'intensité de la couleur des images vidéo entre 0 et 100
 Ajusta la intensidad del color de la imagen vídeo entre 0-100
 Regolazione dell'intensità del colore da 0 a 100 nelle immagini video
 Ajusta a intensidade da cor em imagens de vídeo de 0 a 100
 Justerer fargeintensiteten til videobilder fra 0-100

5.1

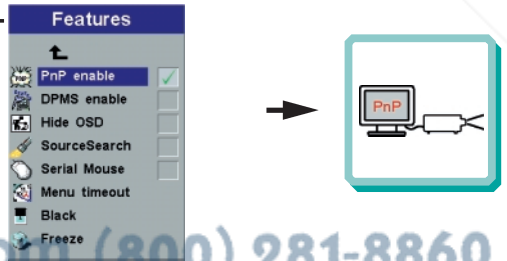

Select plug and play active/inactive
 Plug and Play aktivieren/deaktivieren
 Sélection "plug and play" actif/inactif
 Selecciona activar/desactivar "plug & play" (enchufar y jugar)
 Selezione del Plug & Play attivo/inattivo
 Selecciona plug and play ativo/inativo
 Velg om plug and play skal være aktiv/inaktiv

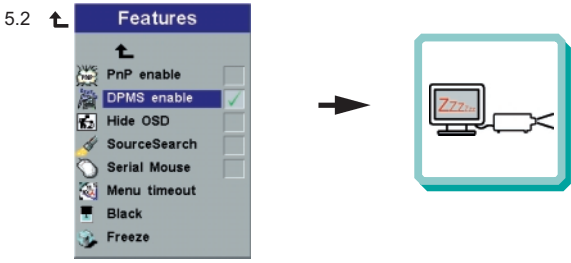

Select DPMS active/inactive. Ref. chapter J
 DPMS aktivieren/deaktivieren. Siehe Kapitel J
 Sélection DPMS actif/inactif. Voir chapitre H
 Selecciona activar/desactivar DPMS. Consultar capítulo J
 Selezione del DPMS attivo/inattivo. Vedere il capitolo J
 Selezione DPMS ativo/inativo. Ref. capítulo J
 Velg om DPMS-funksjonen skal være aktiv/inaktiv. Se kapittel J

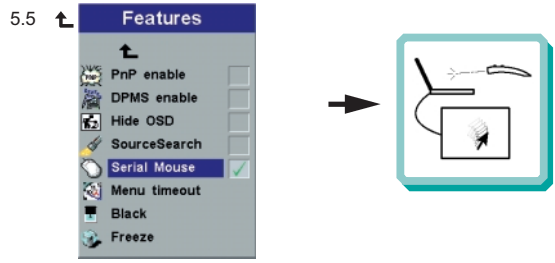

Activate to select mouse; Deactivate to select RS232 control. Ref chapter G
 Aktivieren für Maussteuerung; deaktivieren für RS232-Steuerung. Siehe Kapitel G
 Activer pour sélectionner la souris; Désactivez pour sélectionner la commande RS232. Voir chap G
 Active para seleccionar el ratón; Desactive para seleccionar el control RS232. Ref. Capítulo G
 Attivare per selezionare il mouse; Disattivare per selezionare il comando RS232. Rif. Cap. G
 Ative para selecionar o rato; Desative para selecionar o controle RS232. Ref. Capítulo G
 Aktivter for å velge mus; Deaktivter for å velge RS232 kontroll. Se kapittel G

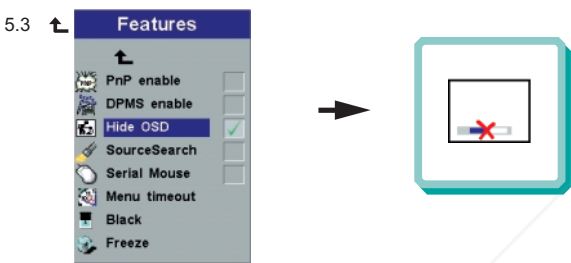

Select to hide On Screen Display (OSD)
 Markieren, um Bildschirmmenü zu verbergen
 Sélectionner pour effacer l'affichage sur l'écran
 Seleccionar para ocultar la presentación en pantalla
 Selezione per nascondere OSD
 Selezione para ocultar a exibição na tela (OSD)
 Velges hvis du vil slå av menyvisningen (OSD)

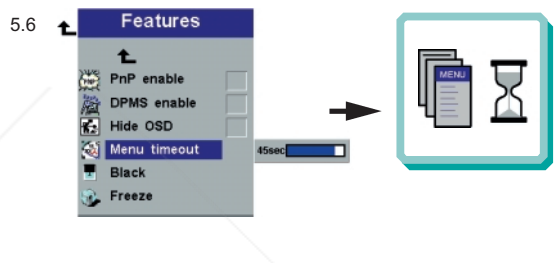

Select time from 5 to 50 sec. before the OSD menu-display hides
 Zeit von 5 bis 50 s einstellen, bevor Bildschirmmenü verborgen wird
 Sélection du temps, entre 5 et 50 sec., avant disparition de l'affichage menu OSD
 Selecciona entre 5 y 50 seg. antes de ocultar el menu de presentación de OSD
 Selezione del tempo da 5 secondi a 50 secondi prima che il menù sullo schermo scompaia
 Selezione un tempo de 5 a 50 seg. para que a exibição na tela (OSD) se oculte
 Velg tid fra 5 till 50 sek. for menyvisningen (OSD) på skjermen slås av

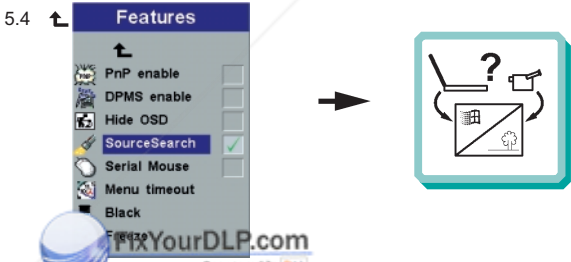

Select to activate/deactivate automatic source search
 Entsprechend wählen, um automatische Quellensuche zu aktivieren/deaktivieren
 Sélectionner 'activer/désactiver' la recherche automatique de source
 Seleccionar para activar/desactivar la búsqueda automática del origen
 Selezione per attivare/disattivare la ricerca della sorgente automatica
 Selezione para ativar/desativar a busca automática de fonte
 Velges om automatisk kildesøkning skal være aktiv/inaktiv

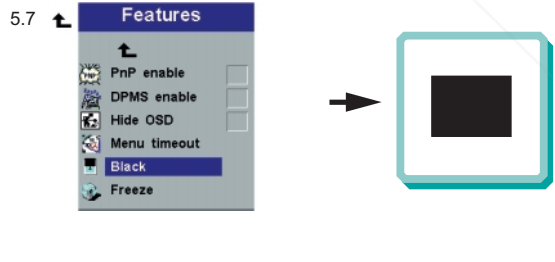

Select for blacking the projected image
 Wählen, um Bild zu verdunkeln
 Sélectionner pour assombrir l'image projetée
 Seleccionar para bajar la imagen proyectada a negro
 Selezione per oscurare l'immagine proiettata
 Selezione para pretejar a imagem projetada
 Velges hvis du vil gjøre bildet som vises sort

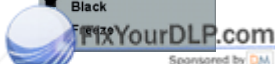

Discount-Merchant.com (800) 281-8860
 THE #1 RATED SOURCE FOR PROJECTOR LAMPS AND ACCESSORIES

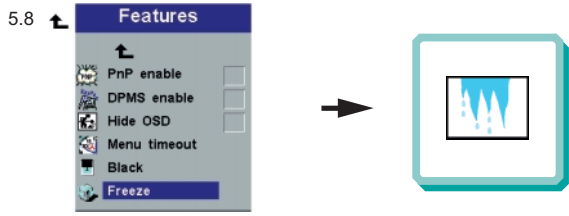

Freezes the projected image
 Einfrieren des projizierten Bildes
 Congèle l'image projetée
 Congela la imagen proyectada
 Congelamento dell'immagine proiettata
 Congela a imagem projetada
 Fryser bildet som vises

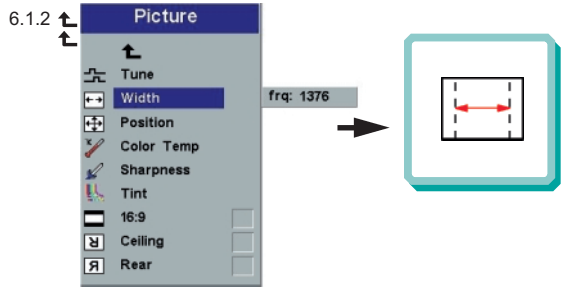

Adjusts width to computer analog image size
 Anpassung der Breite auf Größe des analogen Computerbildes
 Règle la largeur à la dimension de l'image analogique de l'ordinateur
 Ajusta el ancho al tamaño de la imagen del ordenador analógico
 Regolazione della larghezza alla dimensione dell'immagine analogica del computer
 Ajusta a largura ao tamanho da imagem analógica de computador
 Justerer bredden på datamaskinens analoge bilde

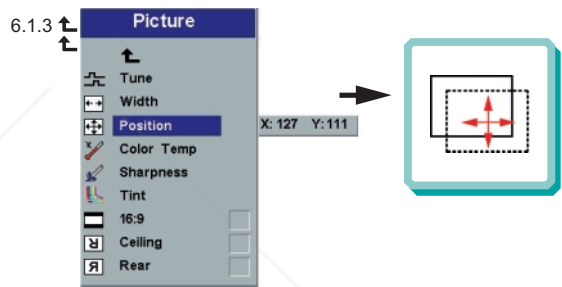
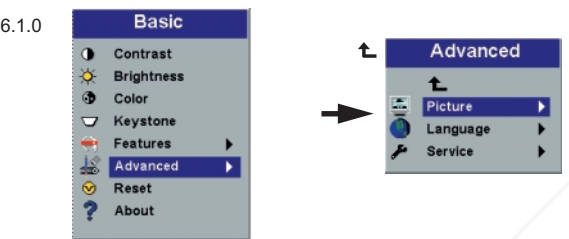

Adjusts position to computer analog and video image size
 Anpassung der Position auf Größe Analog- und Videobildes
 Règle la position à la dimension de l'image analogique de l'ordinateur et de la vidéo.
 Ajusta la posición al tamaño de la imagen del ordenador analógico y del vídeo
 Regolazione della posizione alle dimensioni dell'immagine analogica e video del computer
 Ajusta a posição ao tamanho de imagem de computador analógica e de vídeo
 Justerer plasseringen på datamaskinens analoge bilde og videobilde

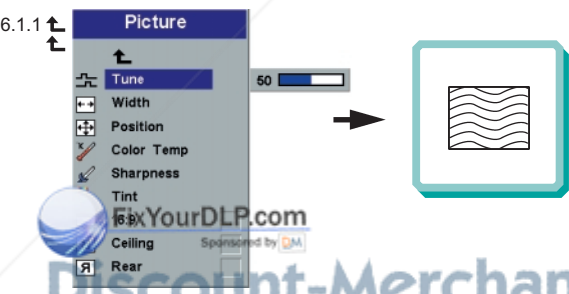

Adjusts horizontal phase/fine tunes computer analog image
 Einstellung der Horizontalfrequenz/Einstelle für analoge Computerbilder
 Règle la phase horizontale/met au point l'image analogique de l'ordinateur
 Ajusta la fase horizontal/sintoniza la imagen del ordenador analógico
 Regolazione della faseatura orizzontale/sintonizzazione fine dell'immagine analogica del computer
 Ajusta a sintonias fase/fina horizontais da imagem analógica de computador
 Justerer den horizontale fasen/finstiller datamaskinens analoge bilde

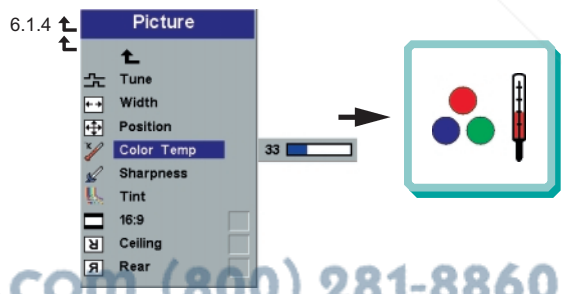

Modifies color temperature balance from 0-100
 Veränderung des Farbtemperaturwertes von 0-100
 Modifie l'équilibre de la température couleur de 0 à 100
 Modifica el equilibrio de temperatura del color entre 0-100
 Modifica dell'equilibrio della temperatura di colore da 0 a 100
 Modifica o equilíbrio da temperatura da cor de 0 a 100
 Endrer balansen for fargetemperatur innenfor området 0-100

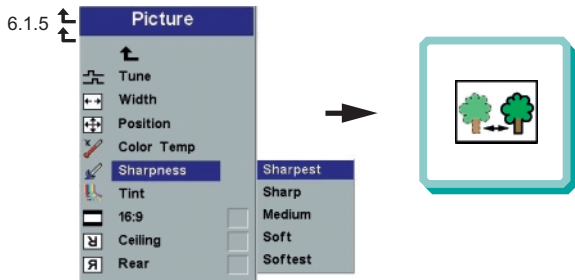

Adjusts sharpness in video images
 Einstellung der Schärfe von Videobildern
 Règle la netteté des images vidéo
 Ajusta la nitidez de la imagen de video
 Regolazione della nitidezza dell'immagine video
 Ajusta a nitidez nas imagens de video
 Justerer skarpheten i videobilder.

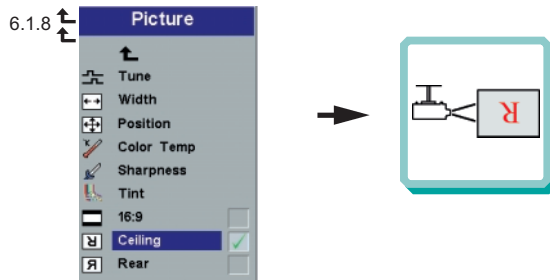

Select for ceiling mounted projection
 Markieren für Projektion bei Deckenmontage
 Sélectionner pour la projection appareil au plafond
 Seleccionar para proyección montada en el techo
 Selezione per la proiezione con montaggio al soffitto
 Seleccione para projeção com montagem no teto
 Velges hvis du vil bruke takmontert projeksjon

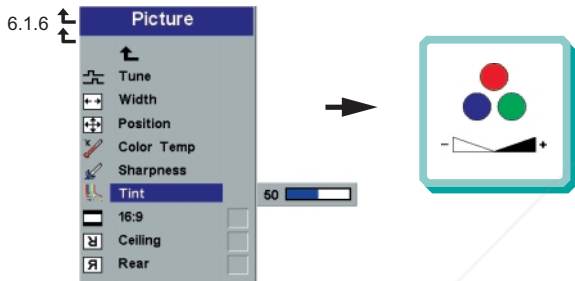

Varies the hue in video NTSC images from 0-100
 Veränderung der Farbe von NTSC Videobildern von 0-100
 Modifie le ton des images NTSC vidéo de 0 à 100
 Varía la tonalidad de la imagen de video NTSC entre 0-100
 Variazione della tonalità cromaticada 0 a 100 nelle immagini video NTSC
 Varia a tonalidade em imagens de video NTSC de 0 a 100
 Endrer fargenyansen til NTSC-videobilder innenfor området 0-100

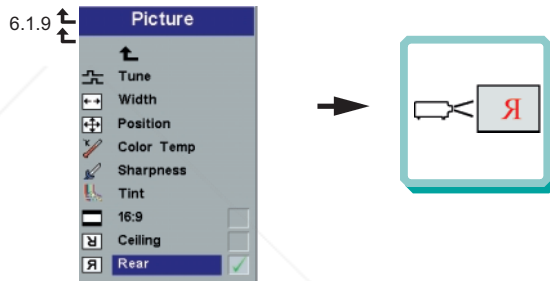

Select for rear projection
 Markieren für Projektion von hinten
 Sélectionner pour afficher l'information réparations
 Seleccionar para proyección de transparencias
 Selezione per la retroproiezione
 Seleccione para projeção de serviço autorizado
 Velges hvis du vil bruke bakprojeksjon

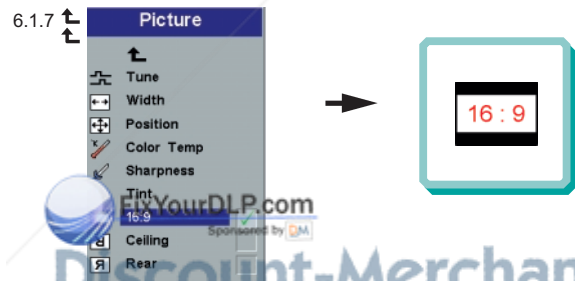

Select 16:9 widescreen image format
 Auswahl Breitbildformat 16:9
 Sélectionner pour remettre toutes les options sur paramètres usine
 Seleccionar el formato de imagen de pantalla ancha 16:9
 Selezione del formato panoramico 16:9
 Selecciona o formata de imagem com largura de tela 16:9
 Velg vidvinkelformatet 16.9 for bildet

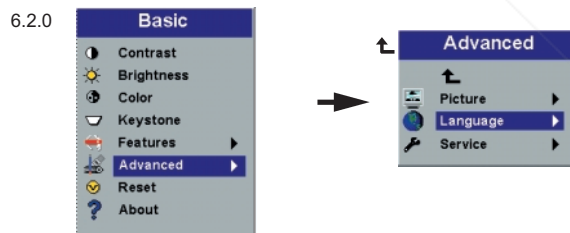

Discount-Merchant.com (800) 281-8860
 THE SOURCE FOR PROJECTOR LAMPS AND ACCESSORIES

MENU ADJUSTMENTS

MENÜEINSTELLUNGEN OPTIONS DE MENU MENÚ DE AJUSTES IMPOSTAZIONI DAL MENU AJUSTES DO MENU MENYINNSTILLINGER

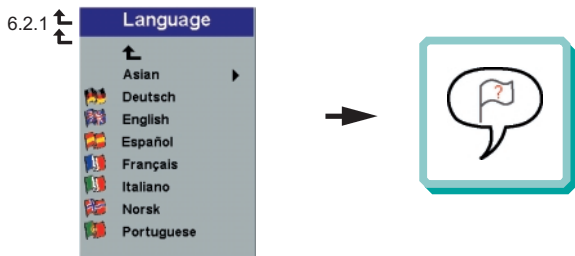

Select language
 Sprache auswählen
 Sélectionne la langue
 Seleccionar lenguaje
 Selezione della lingua
 Selecciona o idioma
 Velg språk

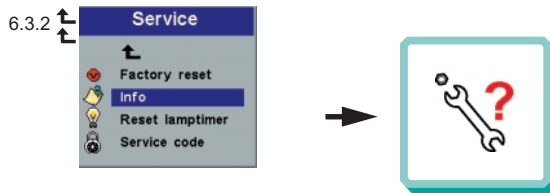

Select to display service information
 Aktivieren, um Serviceinformationen anzuzeigen
 Sélectionner pour afficher l'information réparations
 Sólo para personal técnico
 Selezione per visualizzare le informazioni sull'assistenza
 Selecciona para obter informação sobre a fonte seleccionada
 Velges hvis du vil vise serviceinformasjon

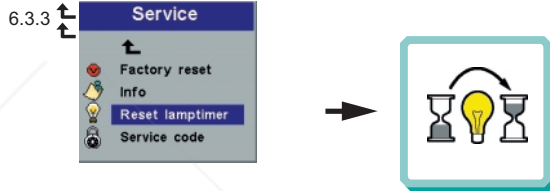
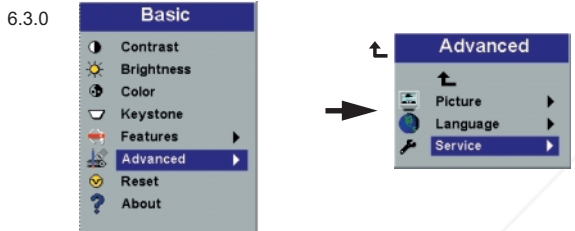

Select to reset lamp timer after lamp replacement
 Aktivieren, um Lampenstundenzähler nach dem Austausch auf Null zu setzen
 Sélectionner pour remettre l'horloge de la lampe à zéro après changement de lampe.
 Seleccionar para restablecer el temporizador de la bombilla tras la sustitución de la misma.
 Selezione per ripristinare il temporizzatore della lampadina dopo la sua sostituzione.
 Selecciona para zerar o cronômetro da lâmpada após substituição da mesma
 Velges for å tilbakestille telleverket for lamper etter lampeskift

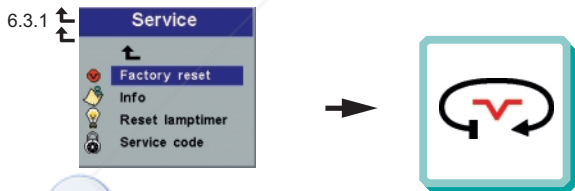

Select to reset all options to factory settings
 Aktivieren, um alle Optionen auf Werkseinstellung zu setzen
 Sélectionner pour remettre toutes les options sur paramètres usine
 Seleccionar para restablecer todas las opciones a la configuración original
 Selezione per il ripristino di tutte le opzioni sulle impostazioni di fabbrica
 Selecciona para que as opções retornem à programação inicial de fábrica
 Velges hvis du vil tilbakestille alle innstillinger til fabrikkinnstillingene

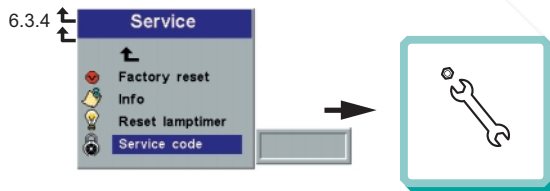

Only for service personnel
 Nur für Kundendienstpersonal
 Pour le personnel technique uniquement
 Sólo para personal técnico
 Ad uso esclusivo dei tecnici di assistenza
 Somente para serviço autorizado
 Bare for servicepersonell



Discount Merchant.com (800) 281-8860
 PROJECTOR PARTS AND ACCESSORIES

7.0

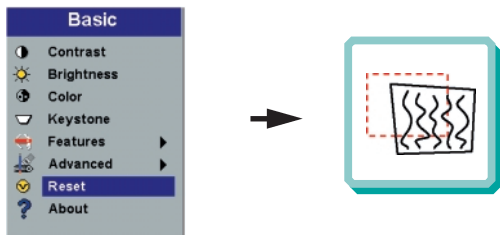

Synchronizes the projector settings to the active source
 Synchronisiert die Projektoreinstellungen für die aktive Quelle
 Synchronise les paramètres du projecteur avec la source active
 Sincroniza las configuraciones del proyector con la fuente activa
 Sincronizzazione delle impostazioni del proiettore sulla sorgente attiva
 Sincroniza a configuração do projetor com a fonte ativa
 Synkroneiserer projektorens innstillinger med den aktive kilden

8.0

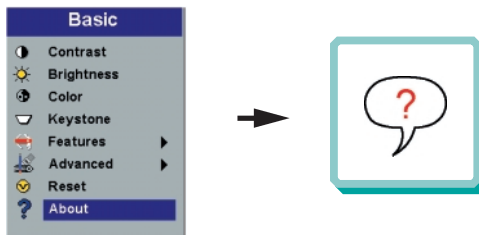

Indicates information about selected source
 Zeigt Information über die aktive Quelle an
 Renseigne sur la source sélectionnée
 Proporciona información sobre fuentes seleccionadas
 Informazioni sulla sorgente selezionata
 Fornece informação sobre a fonte selecionada
 Viser informasjon om den valgte kilden

G

CONTROL RS 232

STEUERN SIE RS 232 CONTRÔLE LES RS 232 CONTROLE RS 232 GESTIRE RS 232 CONTROLE RS 232 KONTROLLERE RS232



To enable the serial RS232 control please do the following:
 Um die serielle Schnittstelle RS232 zu aktivieren, ist folgende zu tun:
 Pour activer la commande série RS232, procédez comme suit.
 Para activar el control de serie RS232, proceda del siguiente modo:
 Per attivare il comando RS232 seriale effettuare le seguenti operazioni:
 Para habilitar o controle serial RS232 efetue as seguintes operações:
 Slik aktiverer du den serielle RS232-kontrollen

- Remove the checkmark from "Serial Mouse" in the projectors Feature Menu
 Entfernen Sie das Häkchen aus dem Kästchen "Serielle Maus" im Menü Eigenschaften des Projektors
 Retirez la marque de vérification de "Serial Mouse" en el Menu de Opciones del proyector
 Deselezionez a casella "Mouse Seriale" nel Menu Caratteristica del proiettore
 Remova a marca de verificação de "Rato Serial" no "Feature Menu" dos projetores
 Fjern avmerkingen for "Seriell Mus" på projektorens Egenskaper-meny
- Connect the serial (COM) port from the Host (Computer) to the Mouse 1 connector on the projector
 Schließen Sie die serielle Schnittstelle (COM) des Computers an den Mouse 1 Anschluss des Projektors
 Connectez le port en série (COM) de l'Host (Ordinateur) au connecteur de Mouse 1 (Souris 1) sur le projecteur
 Conecte el puerto de serie (COM) de Host (ordenador) al conector Mouse 1 del proyector
 Collegare la porta seriale (COM) dall'Host (Computer) al connettore del Mouse 1 sul proiettore
 Conecte a porta serial (COM) do Host (Computador) ao conector 1 do Mouse no projetor
 Koble den serielle porten (COM-porten) på verten (datamaskinen) til kontakten merket Mouse 1 på projektoren
- To make the connection use: (F) Mouse Cable (supplied) with (X) PC Mouse Adapter RS232 Straight (optional)
 Zur Herstellung der Verbindung: (F) Maus kabel (mitgeliefert) mit (X) PC Maus-Adapter RS232 gerade (optional)
 Pour réaliser la connexion, utilisez: le câble de la souris (F) (fourni avec l'appareil) avec l'adaptateur RS232 de souris PC (X) (en option)
 Para realizar la conexión, utilice: (F) Cable del Ratón (suministrado) con (X) Adaptador de Ratón para PC RS232 Directo (opcional)
 Per effettuare il collegamento utilizzare: (F) Cavo del Mouse (fornito) con (X) Adattatore Mouse per PC RS232 Diretto (facoltativo)
 Para efetuar a conexão use: (F) Cabo do Rato (fornecido) com o Adaptador do Rato PC (X) RS232 Reto (opcional)
 Tilkoblingen foretas ved hjelp av (F) musekabelen (vedlagt) eller (X) en adapter for PC-mus RS232 rett (tilleggsutstyr)

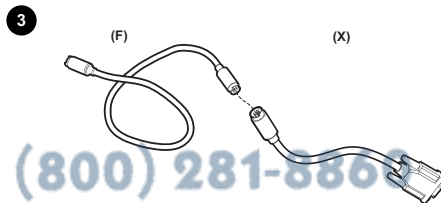
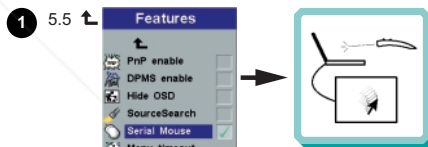

FixYourDLP.com

default RS232 control settings are:
 Die Standardeinstellungen für RS232 sind:
 Les paramètres de commande par défaut du RS232 sont:
 La configuración de control predeterminada para RS232 es:
 Le impostazioni predefinite del comando RS232 sono:
 As definições por defeito do controle RS232 são:
 Standardinnstillingene for RS232 kontroll er:

- Baudrate 9600
Data bit 8
- Parity bit None
Stop bit 1
- Flow Control None

Source for Projector Lamps and Accessories

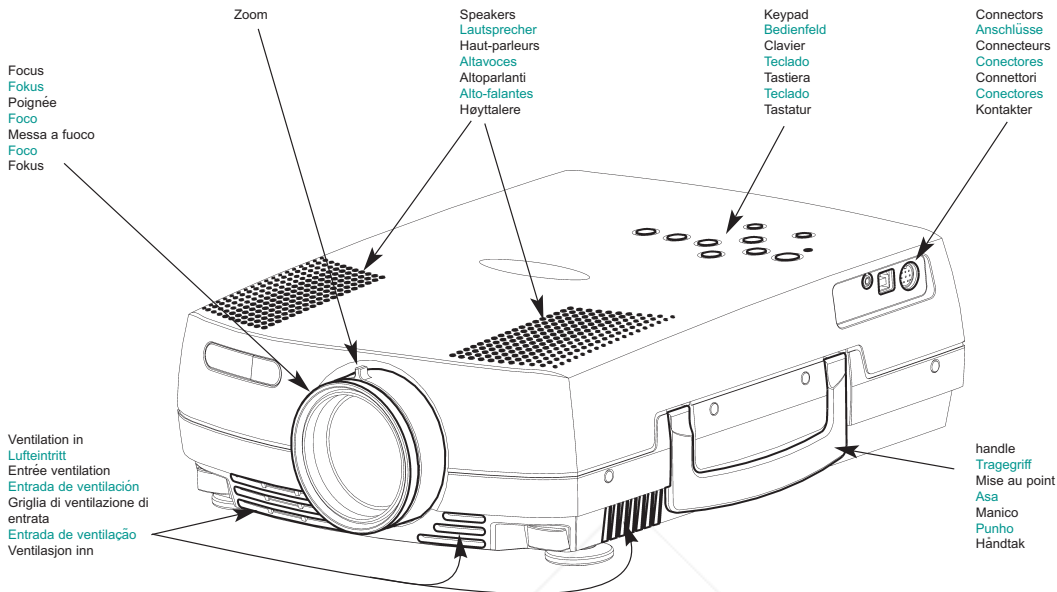

Ceiling mount (use 1/4" screw). Min. distance from ceiling/rear wall: 30/50 cm, 12/20 inch for proper ventilation.

Deckenmontage (1/4"-Schrauben verwenden). Mindestabstand von der Decke/Rückwand 30/50 cm, damit eine korrekte Belüftung gewährleistet ist
 Montage au plafond (utilisez un tournevis 1/4"). Distance minimum au plafond/mur arrière: 30/50 cm, pour garantir une ventilation adéquate
 Soporte de techo (utilice un tornillo de 1/4"). Distancia mínima desde el techo/pared posterior: 30/50 cm, para que exista una ventilación correcta
 Montaggio a soffitto (utilizzare viti da 1/4"). Distanza minima dal soffitto/muro posteriore 30/50 cm, per una ventilazione adeguata
 Montagem no teto (use parafuso de 1/4"). Distância min. do teto/pared traseira: 30/50 cm, para uma ventilação adequada
 Takbeslag (bruk 1/4" skruer). Min. distanse fra tak/bakvegg: 30/50 cm, for å få tilstrekkelig ventilasjon

Adjustable foot
Höhenverstellbarer Fuß
Pieds réglables
Pata ajustable
Piede regolabile
Pé ajustável
Justerbar fot

Adjustable foot
Höhenverstellbarer Fuß
Pieds réglables
Pata ajustable
Piede regolabile
Pé ajustável
Justerbar fot

Dust filter
Staubfilter
Filtre de la poussière
Filtro del polvo
Filtro della polvere
Filtro da poeira
Støv filter

Lamp housing
Lampenfach
Support de lampe
Lugar para la lámpara
Scomparto lampadina
Compartimento da lâmpada
Lampehus

Ventilation out
Luftaustritt
Sortie ventilation
Salida de ventilación
Griglia di ventilazione di uscita
Saída de ventilação
Ventilasjon ut





Power
Netzanschluss
Alimentation
Alimentación
Alimentazione elettrica
Alimentação elétrica
Strøm



Connectors
Anschlüsse
Connecteurs
Conectores
Connettori
Conectores
Kontakter



Count-Merchant.com (800) 281-1100

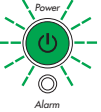

THE TRUSTED SOURCE FOR PROJECTOR LAMPS AND ACCESSORIES

| CONDITION LEUCHTANZEIGE ETAT INDICACIÓN CONDIZIONE CONDICÃO TILSTAND | STATUS ZUSTAND STATUT ESTADO STATO STATUS STATO STATUS | EXPLANATION ERLÄUTERUNG EXPLICATION EXPLICACIÓN SPIEGAZIONE EXPLICACÃO FORKLARING |
|--------------------------------------------------------------------------------------------------------------------------------------------------------------------------------------------------------------------------------------------------------------------------------------------------------------------|-----------------------------------------------------------------------------------------------------------------------------------------------------------------------------------------------------------------------------------------------------------------------------------------------------------------------------------------------------------------------------------------------------------------------------------------------------------------------------------------------------------------|------------------------------------------------------------------------------------------------------------------------------------------------------------------------------------------------------------------------------------------------------------------------------------------------------------------------------------------------------------------------------------------------------------------------------------------------------------------------------------------------------------------------------------------------------------------------------------------------------------------------------------------------------------------------------------------------------------------------------------------------------------------------------------------------------------------------------------------------------------------------|
| Green Grün Vert Luz verde Verde Verde Grønt  Alarm | Power ON (picture on the screen) EIN (Bild auf Leinwand) Position ON (image sur l'écran) Encendido (ON) (imagen en pantalla) Acceso (immagine sullo schermo) Ligado (imagem na tela) Strøm PÅ (bilde på skjermen) | Normal mode. Betriebsmodus Mode normal Modo normal Modalità normale Modo normal Normal modus. |
| Slow orange blinking. Orange (langsam blinkend). Orange pâle clignotant. Luz naranja parpadeando lentamente. Lampeggio arancione lento Laranja piscando lentamente Oranje, langsomt blinkende.  Alarm | Power OFF has been selected and OSD logo screen is displayed. Der Projektor wurde auf AUS gestellt, das OSD-Logo wird angezeigt. La position OFF a été sélectionnée et l'écran logo OSD est affiché Se ha seleccionado APAGADO y la (OFF) pantalla muestra el logotipo de OSD. É stato selezionato lo spegnimento OFF e viene proiettato sullo schermo il logo OSD A opção DESLIGAR foi selecionada e a tela do logotipo OSD é exibida. Strøm AV er valgt, og logoskjermbildet for OSD vises. | The projector is going to standby. Projektor geht in Standby-Modus über Le projecteur passe en standby (attente) El proyector se coloca en stndby Il proiettore sta entrando in stand-by O projetar está entrando em standby Projektoren går til ventemodus |
| Orange Orange Orange Luz naranja Arancione Laranja Oransje  Alarm | Standby mode Standby-Modus Mode standby (attente) Modo standby Modalità stand-by Modo standby Ventemodus | The projector is in standby (sleep) mode. Der Projektor befindet sich in Standby-Modus Le projecteur est en mode standby (attente) El proyector está en modo standby (sleep) Il proiettore è in modalità stand-by (sleep) O projetor está em modo standby (descanso) Projektoren er i ventemodus (dvaliemodus) |
| Red Rot Rouge Luz roja Rosso Vermelho Rødt  Alarm | Lamp life has expired, OSD message is displayed. Lampenwechsel ist fällig, OSD-Meldung erscheint. La durée de vie de la lampe est dépassée, un message OSD est affiché. Aparece un mensaje de OSD indicando que la bombilla se ha agotado. La vita utile della lampadina è giunta a termine, viene proiettato il messaggio OSD A vida útil da lâmpada expirou, uma mensagem OSD é exibida. Lampens levetid er overskredet, OSD-melding vises. | The lamp lifetime is overdue. Return the projector to qualified service personnel for lamp change. Die Lebensdauer der Lampe ist abgelaufen. Lassen Sie einen Lampenwechsel vonqualifiziertem Kundendienstpersonal durchführen. La durée de vie de la lampe est dépassée. Retournez le projecteur au personnel technique qualifié pour le changement de lampe. La vida útil de la bombilla se ha agotado. Lleve el proyector a un servicio técnico autorizado para cambiarla. È stata superata la durata della lampadina. Rendere il proiettore a tecnici di assistenza qualificati per la sostituzione della lampadina. A vida útil da lâmpada está ultrapassada. Leve o projetor a um serviço de assistência qualificado para troca de lâmpada. Lampens levetid er overskredet. Send projektoren til kvalifisert servicepersonell for lampeskiift. |

| CONDITION LEUCHTANZEIGE ETAT INDICACIÓN CONDIZIONE CONDICÃO TILSTAND | STATUS ZUSTAND STATUT ESTADO STATO STATUS STATUS | EXPLANATION ERLÄUTERUNG EXPLICATION EXPLICACIÓN SPIEGAZIONE EXPLICAÇÃO FORKLARING |
|---------------------------------------------------------------------------------------------------------------------------------------------------------------------------------------------------------------------------------------------------------------------------------------------------------------------------------------------------------------------------------------------------------------------------------|-------------------------------------------------------------------------------------------------------------------------------------------------------------------------------------------------------------------------------------------------------------------------------------------------------------------------------------------------------------------------------------------------------------------------------------------------------------------------------------------------------|------------------------------------------------------------------------------------------------------------------------------------------------------------------------------------------------------------------------------------------------------------------------------------------------------------------------------------------------------------------------------------------------------------------------------------------------------------------------------------------------------------------------------------------------------------------------------------------------------------------------------------------------------------------------------------------------------------------------------------------------------------------------------------------------------------------------------------------------------------------------------------------------------------------------------------------------------------|
| <p>Fast green blinking Grün (schnell blinkend) Vert à clignotement rapide Luz verde parpadeando rápidamente Lampeggio verde rapido Verde piscando rapidamente Grønt, raskt blinkende</p>  | <p>Lamp ignition failed (lamp is too hot) Lampe wird nicht gezündet (die Lampe ist zu warm) Lampe reste éteinte (surchauffe de la lampe) Lámpara sigue apagada (sobrecalentamiento de la lámpara) Lâmpada spenta (é surriscaldada) Lâmpada fica apagada (sobre-aquecimento) Tenning av lampen feilet (lampen er for varm)</p> | <p>The projector will cool down the lamp before turning on the lamp again Der Projektor kühlt ab bevor die Lampe wieder gezündet wird Le projecteur refroidit la lampe avant de la rallumer El proyector refrigera la lámpara antes de apagarla Il proiettore ventila la lampada prima di accenderla di nuovo O projector arrefece a lâmpada antes de a voltar a ligar Prosjektoren vil kjøle ned lampen, før lampen tennes på nytt</p> |
| <p>Fast red blinking Rot (schnell blinkend) Rouge à clignotement rapide Luz roja parpadeando rápidamente Lampeggio rosso rapido Vermelho piscando rapidamente Rødt, raskt blinkende</p>  | <p>High temperature, OSD message is displayed. Überhitzung, OSD-Meldung wird angezeigt. Température élevée, Un message OSD est affiché Aparece un mensaje de OSD que indica temperatura elevada. Temperatura elevata, viene proiettato il messaggio OSD. Temperatura alta. Uma mensagem OSD é exibida. OSD-melding om høy temperatur vises.</p> | <p>The projector temperature is above the critical limit. Please allow the projector to cool down by turning off the projector. Die Temperatur des Projektors befindet sich im kritischen Bereich. Schalten Sie den Projektor aus und lassen ihn abkühlen. La température du projecteur est trop élevée. Eteignez le projecteur et laissez-le refroidir. La temperatura del proyector ha alcanzado el punto crítico. Apague el proyector y deje que se enfríe. La temperatura del proiettore ha superato il limite critico. Spegnere il proiettore e lasciarlo raffreddare A temperatura do projetor está acima do limite crítico. Por favor permita que o projetor esfrie desligando-o. Projektorens temperatur er over den kritiske grensen. slå projektoren av slik at den kan kjøle seg ned.</p> |



Discount-Merchant.com (800) 281-8860
THE TRUSTED SOURCE FOR PROJECTOR LAMPS AND ACCESSORIES

| CONDITION LEUCHTANZEIGE ETAT INDICACIÓN CONDIZIONE CONDICÃO TILSTAND | STATUS ZUSTAND STATUT ESTADO STATO STATUS STATUS | EXPLANATION ERLÄUTERUNG EXPLICATION EXPLICACIÓN SPIEGAZIONE EXPLICACÃO FORKLARING |
|---------------------------------------------------------------------------------------------------------------------------------------------------------------------------------------------------------------------------------------------------------------------------------------------------------------------------------------------------------------------|--------------------------------------------------------------------------------------------------------------------------------------------------------------------------------------------------------------------------------------------------------------------------------------------------------------------------------|---------------------------------------------------------------------------------------------------------------------------------------------------------------------------------------------------------------------------------------------------------------------------------------------------------------------------------------------------------------------------------------------------------------------------------------------------------------------------------------------------------------------------------------------------------------------------------------------------------------------------------------------------------------------------------------------------------------------------------------------------------------------------------------------------------------------------------------------------------------------------------------------------------------------------------------------------------------------------------------------------------------------------------------------------------------------------------------------------------------------------------------------------------------------------------------------------------------------------------------------------------------------------------------------------------------------------------------------------------------------------------------------------------------------------------------------------------------------------------------------------------------------------------------------------------------|
| <p>Slow green blinking Grün (langsam blinkend) Vert à clignotement lent Luz verde parpadeando lentamente Lampeggio verde lento Verde piscando lentamente Grønt, langsomt blinkende</p>  | <p>DPMS Mode (black screen) DPMS-Modus (schwarze Leinwand) Mode DPMS (écran noir) Modo DPMS (pantalla en negro) Modalità DPMS (schermo nero) Modo DPMS (Tela preta) DPMS-modus (svart skjerm)</p> | <p>No valid source detected Keine zulässige Quelle gefunden Aucune source adéquate détectée No se ha detectado ninguna fuente válida Non viene rilevata nessuna sorgente Nenhuma fonte válida foi detectada Ingen gyldig kilde funnet</p> |
| <p>Slow green blinking Grün (langsam blinkend) Vert à clignotement lent Luz verde parpadeando lentamente Lampeggio verde lento Verde piscando lentamente Grønt, langsomt blinkende</p>  | <p>OSD logo screen is displayed OSD-Logo wird angezeigt L'écran logo OSD est affiché La pantalla muestra el logotipo de OSD Viene proiettato il logo OSD A tela do logotipo OSD é exibida Logoskjermbildet for OSD vises</p> | <p>The projector will search until a valid source is detected Der projektor versucht eine zulässige Quelle zu finden Le projecteur cherchera jusqu'à détecter une source adéquate El proyector buscará hasta detectar una fuente válida O projetore cercherà fino a trovare una sorgente valida O projetor procurará até detectar uma fonte válida Projektoren vil søke til en gyldig kilde blir funnet</p> |
| <p>Slow green blinking Grün (langsam blinkend) Vert à clignotement lent Luz verde parpadeando lentamente Lampeggio verde lento Verde piscando lentamente Grønt, langsomt blinkende</p>  | <p>DPMS Mode (Lamp is off) DPMS-Modus (Lampe ist aus) Mode DPMS (La lampe est éteinte) Modo DPMS (la bombilla está apagada) Modalità DPMS (la lampadina è spenta) Modo DPMS (a lâmpada está desligada) DPMS-modus (lampen er av)</p> | <p>No valid source detected in the last 3 minutes. The projector will stay in this mode for 5 minutes. If you get a valid source within 5 minutes, the projector will turn on again. Nach Ablauf von 3 Minuten keine zulässige Quelle gefunden. Der Projektor bleibt 5 Minuten lang in diesem Zustand. Wenn Sie in dieser Zeit eine zulässige Quelle anschließen, schaltet sich der Projektor wieder ein. Aucune source adéquate détectée au cours des 3 dernières minutes. La projecteur restera sur ce mode pensant 5 minutes. Si vous lui fournissez une source adéquate dans les 5 minutes, il s'allumera de nouveau. Han transcurrido 3 minutos sin detectar ninguna fuente válida. El proyector permanecerá en este modo durante 5 minutos. Si dentro de ese plazo se le proporciona una fuente válida, volverá a ponerse en marcha. Non è stata rilevata nessuna sorgente valida negli ultimi tre minuti. Il proiettore rimarrà in questa modalità per 5 minuti. Se si trova una sorgente valida entro 5 minuti, il proiettore tornerà ad accendersi. Nenhuma fonte válida foi detectada nos últimos 3 minutos. O projetor permanecerá neste modo por 5 minutos. O projetor ligará novamente se obtiver uma fonte válida dentro de 5 minutos. Ingen gyldig kilde funnet i løpet av de siste 3 minuttene. Projektoren holder seg i denne modusen i 5 minutter. Hvis det blir funnet en gyldig kilde i løpet av 5 minutter, slår projektoren seg på igjen.</p> |



No image on the screen
Kein Bild auf der Leinwand
Pas d'image sur l'écran
Sin imagen en pantalla
Assenza di immagine sullo schermo
Não há imagem na tela
Skjermen viser ikke bilde

1. Verify the power connections to the projector (check that the power light is on)
Stromanschluss des Projektors überprüfen (Power-Leuchtanzeige muss leuchten)
 Vérifiez les connexions de l'alimentation au projecteur (vérifiez que l'indicateur d'alimentation est allumé)
 Verifique las conexiones del proyector (compruebe que la luz de energía está encendida)
 Verificare la connessione dell'alimentazione del proiettore (controllare che la spia dell'alimentazione sia accesa)
 Verifique as conexões de alimentação elétrica do projetor (veja se a luz que indica o estado de ligado está acesa)
 Kontroller strømtilkoblingen for projektoren (sjekk at lyset for strøm er på)
2. Verify the settings on your laptop
Einstellungen am Laptop überprüfen
 Vérifiez les paramètres sur votre ordinateur
 Verifique las configuraciones de su ordenador
 Verificare le impostazioni del computer
 Verifique as configurações no seu laptop
 Kontroller innstillingene på den bærbare datamaskinen
3. Verify that the black-button is not activated on the remote
Prüfen, dass "Black" (Verdunkeln) an der Fernbedienung nicht aktiviert ist
 Vérifiez que le bouton noir n'est pas activé sur la télécommande
 Verifique que el botón negro no esté activado para control remoto
 Verificare che il pulsante nero sul telecomando non sia attivato
 Assegure-se de que botão preto não esteja ativado no controle remoto
 Kontroller at Black-knappen på fjernkontrollen ikke er aktivert
4. Check if lens cap is mounted
Sicherstellen, dass die Linseabdeckung abgenommen ist
 Assurez-vous que la protection de la lentille n'est pas posée
 Compruebe que la tapa de la lente está montada
 Controllare che non sia montato il coperchio della lente
 Verifique se o protetor de lente está colocado
 Kontroller om linsedekselet er på



The projected image is not focused
Das projizierte Bild ist nicht scharf
L'image projetée n'est pas au point
La imagen proyectada no está enfocada
L'immagine proiettata non è a fuoco
A imagem projetada está fora de foco
Bildet som projiseres er ikke i fokus

2. Adjust the focus ring on the projection lens
Fokusing an der Linse einstellen
 Réglez la bague de mise au point sur la lentille de projection
 Ajuste el aro de enfoque de la lente de proyección
 Regolare l'anello di messa a fuoco sulla lente di proiezione
 Ajuste o anel de foco à lente de projeção
 Vri på fokuseringsringen på projeksjonslinsen
3. Ensure that the projection lens is clean
Prüfen, ob Linse sauber ist
 Vérifiez que la lentille de projection est propre
 Asegúrese de que la lente de proyección está limpia
 Assicurarsi che la lente di proiezione sia pulita
 Assegure-se de que a lente de projeção está limpa
 Kontroller at projeksjonslinsen er ren
4. In Video: Check the sharpness setting in the advanced/picture menu and adjust if necessary
Bei Video: Schärfereinstellung im Menü Optionen/Bild prüfen und bei Bedarf ändern
 Source Vidéo: Vérifiez le réglage de netteté de l'image dans le menu "advanced/picture" et réglez si besoin est
 En vídeo: compruebe la configuración de la nitidez en el menú avanzado/de imagen y ajústelo si fuera necesario
 In Video: Controllare la regolazione della nitidezza nel menu Advanced / Picture e regolarla se necessario
 No vídeo: verifique a configuração da nitidez no menu avançado/imagem e ajuste-a se necessário
 I video-modus: Kontroller innstillingen for skarphet på menyen Advanced/picture, og tilpass den om nødvendig
5. Ensure that the projector is correctly aligned with the projected screen
Prüfen, ob der Projektor richtig zur Leinwand ausgerichtet ist
 Vérifiez que le projecteur est correctement aligné avec l'écran
 Verifique que el proyector está correctamente alineado con la pantalla proyectada
 Verificare che il proiettore sia allineato correttamente con lo schermo
 Verifique se o projetor está corretamente alinhado com a tela de projeção
 Kontroller at projektoren er korrekt plassert i forhold til skjermen det projiseres



No sound
Kein Ton
Pas de son
Sin sonido
Nessun suono
Não há som
Ingen lyd

1. Check the audio input connections
Verbindung am Audioeingang überprüfen
 Vérifiez les connexions entrée audio
 Compruebe las conexiones de entrada de audio
 Controllare i collegamenti di ingresso audio
 Verifique as conexões de entrada de áudio
 Kontroller tilkoblingene for lydinngangen
2. Adjust the volume
Lautstärke einstellen
 Réglez le volume
 Ajuste el volumen
 Regolare il volume
 Ajuste o volume
 Juster lydstyrken
3. Verify that the audio cables OK
Prüfen, ob Audiokabel in Ordnung ist
 Vérifiez que le câble audio n'est pas endommagé
 Verifique que el cable de audio está bien
 Verificare che il cavo audio sia a posto
 Verifique se o cabo de áudio está conforme
 Kontroller at lydkaabelen er OK
4. Adjust the audio source
Einstellungen an der Audioquelle vornehmen
 Réglez la source audio
 Ajuste la fuente de audio
 Regolare la sorgente audio
 Ajuste a fonte de áudio
 Juster lydkielen

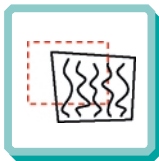

The projected image is distorted
Das projizierte Bild ist verzerrt
 L'Image projetée est déformée
La imagen proyectada está distorsionada
 L'immagine proiettata è distorta
A imagem projetada está distorcida
 Bildet som vises er forvrengt

2. Select Menu on remote or on projector
Menü über Fernbedienung oder Bedienfeld wählen
 Sélectionnez Menu sur la télécommande ou sur le projecteur
Seleccione el Menú por control remoto o en el proyector
 Selezionare Menù sul telecomando o sul proiettore
Selecione o Menu no controle remoto ou no projetor
 Trykk på Menu på fjernkontrollen eller projektoren



1. Press the Power button and go to Reset
Auf Power drücken und Reset durchführen
 Appuyez sur le bouton "Power" et Remettez à zéro
Pulse el botón Power y vaya a Reset (restablecer)
 Premere il tasto Power e iniziare il Ripristino (reset)
Desligue e ligue novamente o projetor pressionando o botão LIG/DES LIG
 Trykk på Power-knappen og gå til Reset



- 2.2 Select Picture
Bild wählen
 Sélectionnez Picture
Seleccione Picture
 Selezionare Picture
Selecione Imagem
 Velg Picture



- 2.1 Go to Advanced
Zu Optionen gehen
 Choisissez Advanced
Vaya a Advanced
 Portarsi su Advanced
Vá ao menu Avançado
 Gå til Advanced

- 2.3 Select Frequency or Tuning for image manual adjustments
Frequenz oder Tuning für manuelle Bildeinstellung wählen
 Sélectionnez Frequency ou Tuning pour le réglage manuel de l'image
Seleccione Frequency o Tuning para ajustar manualmente la imagen
 Selezionare Frequency o Tuning per la regolazione manuale dell'immagine
Selecione Frequência ou Sintonia para ajustes manuais da imagem
 Velg Frequency eller Tuning for å justere bildet manuelt

3. Verify that the projector is not tilted/elevated and that it is parallel with the projected screen
Sicherstellen, dass der Projektor nicht schief oder zu hoch steht und dass er parallel zur Leinwand ausgerichtet ist
 Vérifiez que le projecteur n'est pas incliné/surélévée et qu'il est parallèle à l'écran de projection
Verifique que el proyector no está inclinado/elevado y que está en paralelo con la imagen proyectada
 Verificare che il proiettore non sia inclinato/elevato e che sia parallelo allo schermo di proiezione
Verifique se o projetor não está inclinado/elevado e se está paralelo à tela projetada
 Kontroller at projektoren ikke er vippt opp- eller nedover eller hevet, og at den er parallell med skjermen det projiseres

4. Check if the digital keystone function is active. Adjust if necessary
Prüfen, ob Trapezverzerrung aktiv ist. Falls nötig, einstellen
 Regardez si la fonction keystone digitale est active. Réglez si besoin est
Compruebe si la función de distorsión digital está activada. Ajústela si fuera necesario
 Controllare che sia attiva la funzione di distorsione digitale. Regolarla se necessario
Veja se a função digital do ângulo trapezoidal está ativa. Ajuste se necessário
 Kontroller om den digitale keystone-funksjonen er aktiv. Juster den om nødvendig

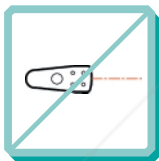

Remote does not respond
Fernbedienung funktioniert nicht
 La Télécommande ne marche pas
El control remoto no responde
 Il telecomando non risponde
O controle remoto não funciona
 Fjernkontrollen virker ikke

2. Check for other interfering IR sources in the room i.e. fluorescent light tubes, sunlight, active IR COM ports from laptops etc.
andere störende Infrarotquellen im Raum suchen, z.B. Leuchtstoffröhren, Sonnenlicht, aktive Infrarot-Anschlüsse von Laptops, etc.
 altri possibili fonti di interferenze IR pouvant interférer: tubes néons, lumière du soleil, ports COM IR actifs de portables, etc.
pruebe otras posibles fuentes de interferencias de infrarrojos en la habitación, p.e. tubos fluorescentes, luz solar, puerto COM infrarrojo del ordenador activo, etc.
 Controllare che nella stanza non vi siano altre sorgenti IR che possano interferire quali tubi luminosi fluorescenti, luce solare, PC portatili con porte COM attive ad IR, ecc.
Veja se há outras fontes de irradiação eletromagnética interferindo no local, ou seja, tubos de luz fluorescente, luz do sol, portos de comunicação a infravermelho de laptops etc.
 Kontroller om det finnes andre forstyrrende infrarøde kilder i rommet, f.eks. lysstoffrør, sollys, aktive IR COM-porter på bærbare datamaskiner osv.

1. Verify that working batteries are inserted in the remote and that it has been switched on
Prüfen, ob Batterien fehlen bzw. leer sind und ob Fernbedienung ei geschaltet ist
 Vérifiez que les piles sont en place et qu'elle est allumée Vérifiez el control remoto tiene pilas y que está encendido
Verifique que el control remoto tiene pilas y que está encendido
 Verificare che nel telecomando siano inserite batterie funzionanti e che il telecomando sia acceso
Verifique se as baterias estão boas, se estão corretamente inseridas no controle remoto e se este está ligado
 Kontroller om det er satt inn batterier som virker i fjernkontrollen, og at den er slått på



| GENERAL CONDITIONS | ALLGEMEINE DATEN | ENVIRONNEMENT | CONDICIONES GENERALES | CONDIZIONI GENERALI | CONDÇÕES GERAIS | GENERELLE KRAV | |
|----------------------------------|----------------------------------------|---------------------------------------------|-----------------------------------------------------|--------------------------------------------------|----------------------------------------------|-------------------------------------------|-------------------------------------------------------------------------------------------------|
| Storage temperature, sealevel | Lagertemperatur, Meeresspiegel | Température de stockage au niveau de la mer | Temperatura de almacenamiento a nivel del mar | Temperatura di conservazione, a livello del mare | Temperatura de armazenamento, a nível do mar | Temperatur ved lagring, havflaten | -40 - 60 °C -40 - 140 F |
| Storage humidity, non-condensing | Lagerfeuchtigkeit, nicht kondensierend | Humidité de stockage, sanscondensation | Humedad relativa de almacenamiento sin condensación | Umidità di conservazione, senza condensa | Umidade de armazenamento, sem condensação | Fuktighet ved lagring, ikke-kondenserende | 10 - 90 % RH |
| Operating temperature ambient | Raumtemperatur für Betrieb | Température ambiante de fonctionnement | Temperatura ambiente de funcionamiento | Temperatura di funzionamento ambiente | Temperatura de funcionamento | Romtemperatur ved bruk | 5 - 35 °C 0-1600 m 5 - 30 °C 1600-3200 m 41 - 95 F 0-5000 ft. 41 - 86 F 5000-10000 ft. |
| Operating humidity | Betriebsfeuchtigkeit | Humidité de fonctionnement | Humedad relativa de funcionamiento | Umidità di funzionamento | Umidade de funcionamento | Fuktighet ved bruk | 20 - 80 % RH Allow for slow acclimatization at high humidity |

| PROJECTOR UNIT | PROJEKTOR | PROJECTEUR | PROYECTOR | UNITÀ DEL PROIETTORE | PROJETOR | PROJEKTOR-ENHETEN | |
|---------------------|--------------------|-----------------------------------------|------------------------------------|--------------------------------------|-----------------------------------|---------------------|-----------------------------------------------|
| Dimensions (HxWxL) | Maße (HxBxL) | Encombrement (HxPxL) | Dimensiones (Alto x Ancho x Largo) | Dimensioni (Alt. x Largh. x Lunghe.) | Dimensões (Alt. x Larg. x Comp.) | Størrelse (HxBxL) | 98x250x340 mm 3.9x9.9x13.4 inch |
| Weight | Gewicht | Poids | Peso | Peso | Peso | Vekt | 3.4 kg/7.4 lbs |
| Projection lens | Linse | Objectif | Lente de proyección | Lente di proiezione | Lente de projeção | Projeksjonslinse | 1.3 zoom ratio f=36 - 47 mm F=1.8 - 2.1 |
| Projection distance | Projektionsabstand | Distance de projection | Distancia de proyección | Distanza di proiezione | Distância de projeção | Projeksjonsavstand | 1.1 -10m 3.1 - 32.5 ft. |
| Keystone correction | Trapezentrerrung | Compensation de distorsion trapézoïdale | Corrección de la clave | Correzione della deformazione | Correção da distorção trapezoidal | Keystone-korreksjon | 10 degrees |
| Projection lamp | Projektionslampe | Lampe de projection | Lámpara para proyección | Lampadina di proiezione | Lâmpada de projeção | Projeksjonslampe | 150 W UHP |
| Display | Anzeige | Affichage | Presentación en pantalla | Display | Tela de exibição | Bildeprocessor | 3 x LCD 0.9" Polysilikon |
| Colors | Farben | Couleurs | Colores | Colori | Cores | Farger | 16.7 MILLION |
| Contrast | Kontrast | Contraste | Contraste | Contrasto | Contrase | Kontrast | 450 : 1 |
| Pixels | Auflösung | Résolution | Pixels | Pixel | Resolução | Piksler | XGA: 1024x768 |

Subject to change Änderungen vorbehalten Sous réserve de modifications Sujetos a posibles cambios Soggetti a modifica Sujeito a modificações Kan endres



Discount-Merchant.com (800) 281-8860
THE TRUSTED SOURCE FOR PROJECTOR LAMPS AND ACCESSORIES

| PROJECTOR UNIT | PROJEKTOR/ GERÄT | PROJETEUR | PROYECTOR | UNITÀ DEL PROIETTORE | PROJETOR | PROJEKTOR- ENHETEN | |
|-----------------------------------------------------------|-----------------------------------------------------------------|-----------------------------------------------------------------------------------|------------------------------------------------------------------------------------|-----------------------------------------------------------------------------------|-----------------------------------------------------------------------|---------------------------------------------------------------------------|-------------------------------------------------------------------------------------------|
| Video frequency | Videofrequenz | Entrée ordinateur | Frecuencia de video | Frequenza video | Frequência de vídeo | Videofrekvens | 12-150 MHz |
| Horizontal sync. | Horizontalfrequenz | Sync. horizontale | Sinc. horizontal | Sinc. orizz | HorizontalSinc. | Horisontal synk. | 15-100 KHz |
| Vertical sync. | Verticalfrequenz | Sync. verticale | Sinc. vertical | Sinc. vert. | VerticalSinc. | Vertikal synk. | 43.5-130 Hz |
| Computer input | Computereingang | Entrée ordinateur | Entrada de señal del ordenador | Ingresso computer | Entrada Computador | Datamaskin-inngang | 0.5-1 Vpp |
| Audio input | Audioeingang | Entrée audio | Entrada de audio | Ingresso audio | Entrada de áudio | Lydinggang | 1 VRMS |
| Speakers | Lautsprecher | Haut-parleurs | Altavoces | Altoparlanti | Alto-falantes | Høytalere | 2x1 W |
| Conformance | Prüfzeichen | Conformité | Homologación | Conformità | Conformidade | Oppfyller kravene til | CE. UL. CUL. GOST R. FCC, Subpart J, Part 15. |
| Power supply | Stromversorgung | Alimentation électrique | Suministro de corriente | Alimentazione elettrica | Fonte de alimentação | Strømforsyning | 100-240 VAC, 50-60 HZ 2.5-1 A |
| Computer compatibility resized to native pixel resolution | Computer-kompatibilität. Resizing auf Originalauflösung (Pixel) | Compatibilité ordinateur au redimensionnement de la résolution d'origine (pixels) | Compatibilidad del ordenador ajustada a la resolución pixels. Resolución en pixels | Compatibilità computer (riclassificata in base alla risoluzione pixel originaria) | Compatibilidade do computador ajustada à resolução de origem (pixels) | Datamaskin-kompatibilitet, størrelse endret til naturlig pikseloppløsning | 640x480 720x400 800x600 832x624 1024x768 1152x864 1152x870 1280x1024 |
| Video compatibility | Videokompatibilität | Compatibilité vidéo | Compatibilidad de video | Compatibilità video | Compatibilidade de vídeo | Video-kompatibilitet | PAL BGHI, N, combination N, M, NTSC M, N, 4.43, Japan, SECAM |

Subject to change Änderungen vorbehalten
 Sous réserve a possibles modifications Sujetos a posibles cambios
 Soggetti a modifica Sujeito a modificações
 Kan endres

| PROJECTION DISTANCES | PROJEKTIONS- ABSTÄNDE | DISTANCES DE PROJECTION | DISTANCIAS DE PROYECCIÓN | DISTANZE DI PROIEZIONE | DISTÂNCIAS DE PROJEÇÃO | PROJEKSJONS- AVSTANDER | |
|----------------------|--------------------------|----------------------------|-----------------------------|---------------------------|---------------------------|---------------------------|------------------------|
| WIDE | WEITWINKEL | GRAND ANGULAIRE | GRAN ANGULAR | GRANDANGOLO | GRÃ ANGULAR | VIDVINKEL | |
| Distance | Entfernung | Distancia | Distancia | Distanza | Distância | Avstand | 1.1-10m/3.6-32.5 ft. |
| Diagonal | Diagonale | Diagonal | Diagonale | Diagonale | Diagonale | Diagonal | 0.7-6.5m/2.3-21.1 ft. |
| Width | Breite | Largeur | Ancho | Larghezza | Largura | Bredde | 0.6-5.2m/1.9-16.9 ft. |
| Height | Höhe | Hauteur | Alto | Altezza | Altura | Høyde | 0.5-3.9m/1.6-12.7 ft. |
| TELE | TELEOBJEKTIV | TELEOBJECTIF | TELEOBJETIVO | TELEOBIETTIVO | TELEOBJETIVA | TELE | |
| Distance | Entfernung | Distancia | Distancia | Distanza | Distância | Avstand | 1.1-10m/3.6-32.5 ft. |
| Diagonal | Diagonale | Diagonal | Diagonale | Diagonale | Diagonale | Diagonal | 0.6-5.2m/1.9-16.9 ft. |
| Width | Breite | Largeur | Ancho | Larghezza | Largura | Bredde | 0.5-4.2m/1.6-13.7 ft. |
| Height | Höhe | Hauteur | Alto | Altezza | Altura | Høyde | 0.35-3.2m/1.1-10.4 ft. |

Variation of +/- 10% Abweichung von +/- 10%
 Variation de +/- 10% Variazione di +/- 10%
 Variação de +/- 10% Variação de +/- 10%
 Variação de +/- 10% Variação de +/- 10%
 Variasjon på +/- 10%

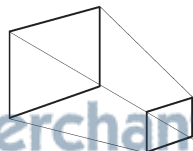

Discount-Merchant.com (800) 281-8860
 THE TRUSTED SOURCE FOR PROJECTOR LAMPS AND ACCESSORIES



CONNECTORS **ANSCHLÜSSE** CONNECTEURS **CONECTORES** CONNETTORI **CONECTORES** KONTAKTER

2



| S-VIDEO VIDEO | AUDIO IN | AUDIO OUT | AUDIO (1)(2) IN (3) |
|-----------------------------|--------------|-----------|---------------------|
| 3.5 mm JACK | | | |
| TIP: right | | | |
| RING: left | | | |
| STEM: common | | | |
| 4 PIN MINIDIN FEMALE | 3.5 mm JACK | | |
| 1 GND | TIP: right | | |
| 2 GND | RING: left | | |
| 3 Luma | STEM: common | | |
| 4 Chroma | | | |
| PHONO/RCA FEMALE | 3.5 mm JACK | | |
| STEM: composite SHIELD: GND | TIP: right | | |
| | RING: left | | |
| | STEM: common | | |

DIGITAL COMPUTER DVI (1)

DVI-D MAIN PIN FIELD

- 1 TMDS Data 2-
- 2 TMDS Data 2+
- 3 TMDS Data 2/4 Shield
- 4 Not used
- 5 Not used
- 6 DDC Clock
- 7 DDC Data
- 8 Analog Vertical Sync
- 9 TMDS Data 1-
- 10 TMDS Data 1+
- 11 TMDS Data 1/3 Shield
- 12 Not used
- 13 Not used
- 14 +5V Power
- 15 Ground (+5, Analog HV Sync.)
- 16 Hot Plug Detect
- 17 TMDS Data 0-
- 18 TMDS Data 0+
- 19 TMDS Data 0/5 Shield
- 20 Not used
- 21 Not used
- 22 TMDS Clock Shield
- 23 TMDS Clock+
- 24 TMDS Clock-

ANALOG COMPUTER VGA (2)

15 HIGH DENSITY DSUB FEMALE

- 1 Analog R in
- 2 Analog G in
- 3 Analog B in
- 4 AGND
- 5 AGND
- 6 Analog R GND in
- 7 Analog G GND in
- 8 Analog B GND in
- 9 Reserved
- 10 Sync GND in
- 11 AGND
- 12 DDC/SDA
- 13 HSync in
- 14 VSync in
- 15 DDC/SCL

ANALOG COMPUTER VGA (3)

15 HIGH DENSITY DSUB FEMALE

- 1 Analog R in
- 2 Analog G in
- 3 Analog B in
- 4 AGND
- 5 AGND
- 6 Analog R GND in
- 7 Analog G GND in
- 8 Analog B GND in
- 9 Reserved
- 10 Sync GND in
- 11 AGND
- 12 DDC/SDA
- 13 HSync in
- 14 VSync in
- 15 DDC/SCL

MONITOR

15 HIGH DENSITY DSUB FEMALE

- 1 Analog R OUT
- 2 Analog G OUT
- 3 Analog B OUT
- 4 Reserved
- 5 AGND
- 6 Analog R GND OUT
- 7 Analog G GND OUT
- 8 Analog B GND OUT
- 9 Reserved
- 10 Sync GND OUT
- 11 Not used
- 12 Not used
- 13 HSync OUT
- 14 VSync OUT
- 15 DDC/SCL

1



| REMOTE CONTROL | MOUSE 2 | MOUSE 1 |
|----------------|---------|----------------------|
| 2.5 MM JACK | | 8 PIN MINIDIN FEMALE |
| TIP: right | | 1 Mac ADB |
| RING: left | | 2 PS/2 clock |
| STEM: common | | 3 PS/2 data |
| | | 4 RS 232 TXD |
| | | 5 Not used |
| | | 6 RS 232 RXD |
| | | 7 RS 232 CTS |
| | | 8 GND |
| | | DIGITAL USB |
| | | 1 VCC |
| | | 2 -Data |
| | | 3 +Data |
| | | 4 GND |

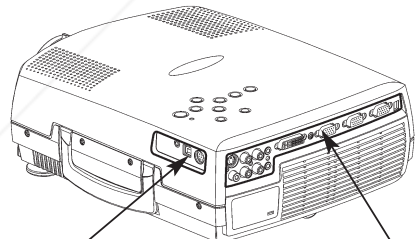

FixYourDLP.com
Sponsored by DLP

Discount-Merchant.com (800) 281-8860
THE TRUSTED SOURCE FOR PROJECTOR LAMPS AND ACCESSORIES

⚠ This product contains no user serviceable parts. Attempts to modify mechanics or electronics inside the housing will violate any warranties, and may be hazardous.

If for any reason the product fails to work properly, please contact your dealer for technical support. Prepare a list of the symptoms you observe to make diagnosing easier for your dealer.

Please also include the following:

- Serial number of the unit (SN)
- Part number of the unit (PN)
- Software revision (under Main Menu selection ADVANCED/SERVICE/INFO)
- Connected source information (under main menu selection HELP).

⚠ Dieses Gerät enthält keine Verschleißteile. Der Versuch, elektronische oder mechanische Komponenten im Gehäuse zu manipulieren führt zum Verlust der Garantie und kann eine Gefahr für den Benutzer darstellen.

Sollte das Gerät aus welchem Grund auch immer nicht korrekt funktionieren, wenden Sie sich bitte an Ihren Händler. Bitte halten Sie die auftretenden Probleme schriftlich fest. Damit erleichtern Sie Ihrem Händler die Fehlerdiagnose.

Bitte halten Sie auch folgende Daten bereit:

- Seriennummer des Geräts (SN)
- Teilnummer des Geräts (PN)
- Versionsnummer der Software (im Hauptmenü unter OPTIONEN/SERVICE/INFO)
- Information über angeschlossene Quelle (im Hauptmenü unter HILFE)

⚠ Aucune des pièces de ce produit n'est réparable par l'utilisateur. Les tentatives de modification des parties mécaniques ou électroniques de l'appareil annuleront toute garantie et peuvent être dangereuses.

Si le produit ne fonctionnait pas correctement, prenez contact avec votre concessionnaire. Préparez au préalable une liste des symptômes que vous avez observés pour que votre concessionnaire établisse plus aisément le diagnostic.

Veillez inclure les renseignements suivants:

- Numéro de série de l'unité (SN)
- Numéro de la pièce de l'unité (PN)
- Révision du logiciel (Sélectionnez ADVANCED/SERVICE/INFO dans le menu principal)
- Les renseignements concernant la source connectée (sélectionnez HELP dans le menu principal)

⚠ Este producto no contiene ninguna pieza útil para el usuario. Cualquier intento de modificar la mecánica o electrónica incluida en la carcasa anulará la garantía, y puede resultar peligroso.

Si por cualquier motivo el producto no funciona correctamente, póngase en contacto con su distribuidor para obtener asistencia técnica. Prepare una lista de los problemas que haya observado para facilitar su diagnóstico.

Incluya además los siguientes datos:

- Número de serie de la unidad (SN)
- Número de pieza de la unidad (PN)
- Revisión de software (consultar seleccionando AVANZANDO/SERVICIO/INFO en el menú principal)
- Información sobre fuentes conectadas (en AYUDA del menú principal)

⚠ Questo prodotto non contiene parti sostituibili dall'utente. Qualsiasi tentativo di modificare parti meccaniche o elettroniche interne alla scatola renderà nulla la garanzia e può risultare pericoloso.

Se per qualsiasi motivo il prodotto non funziona adeguatamente, si prega di contattare il rivenditore per l'assistenza tecnica. Preparare una lista dei sintomi osservati per rendere più facile la diagnosi al rivenditore.

Si prega anche di includere le seguenti informazioni:

- Numero di serie dell'apparecchiatura (SN)
- Numero del pezzo dell'apparecchiatura (PN)
- Revisione del software (vedere nel menu principale alla selezione ADVANCED/SERVICE/INFO)
- Informazioni sulla sorgente collegata (vedere nel menu principale alla selezione HELP)

⚠ Este produto não contém peças úteis ao usuário. Tentativas de modificação da mecânica ou eletrônica interna violará qualquer garantia e pode ser perigoso.

Se por qualquer razão o produto não funcionar corretamente, por favor contate o distribuidor para suporte técnico. Prepare uma lista dos sintomas observados a fim de facilitar o diagnóstico para o distribuidor.

Por favor também inclua o seguinte:

- Número de série da unidade (SN)
- Número da peça da unidade (PN)
- Revisão do software (no menu principal - seleção AVANÇADO/SERVICO/INFO)
- Informação da fonte conectada (no menu principal - seleção AJUDA)

Sponsored by

⚠ Dette produktet inneholder ingen deler som brukerne kan utføre service på. Forsøk på å endre mekaniske eller elektroniske komponenter innenfor dekslet vil gjøre alle garantier ugyldige, og kan også være farlig.

Hvis produktet av en eller annen grunn ikke virker som det skal, må du kontakte forhandleren for å få teknisk brukerstøtte. Lag en liste over symptomene du ser, slik at det blir lettere for forhandleren å finne ut hva problemet skyldes.

Ta også med følgende:

- Enhetens serienummer (SN)
- Enhetens delenummer (PN)
- Programvareversjon (under hovedmenyvalget ADVANCED/SERVICE/INFO)
- Informasjon om tilkoblede kilder (under hovedmenyvalget HELP)

1. Remove foot and screw to access the dustfilter
Fuß und Schraube entfernen, um an den Staubfilter zu gelangen
Enlevez les pieds et les vis pour accéder au filtre à poussière
Retire el pie y el tornillo para acceder al filtro del polvo
Togliere la base avvitata per accedere al filtro della polvere
Remove o pé e o parafuso para aceder ao filtro do pó
Fjern foten og festeskruen for tilgang til støvfilteret

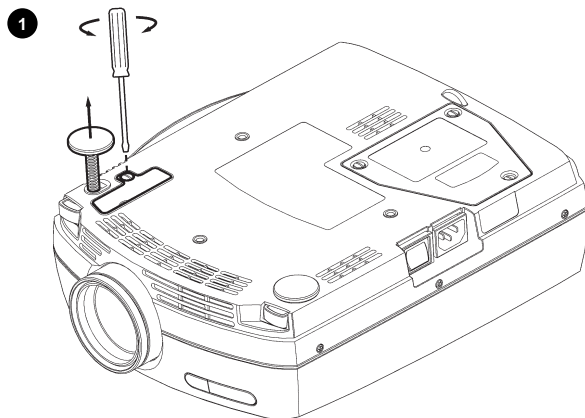

2. Carefully remove the dustfilter
Staubfilter vorsichtig entfernen
Enlevez le filtre à poussière avec précautions
Retire con cuidado el filtro del polvo
Togliere attentamente il filtro della polvere
Remove cuidadosamente o filtro do pó
Forsiktig fjern støvfilteret

3. Clean dustfilter
Staubfilter reinigen
Nettoyez le filtre à poussière
Limpie el filtro del polvo
Pulire il filtro della polvere
Limpe o filtro do pó
Rens støvfilteret

4. Replace clean dustfilter, tighten screw and replace foot
Gereinigten Staubfilter wieder einlegen, Schrauben festziehen und Fuß anbringen
Remettez le filtre à poussière en place, serrez les vis et remplacez les pieds
Coloque de nuevo el filtro del polvo limpio, apriete el tornillo e instale el pie
Sostituire il filtro della polvere pulito, avvitare bene e collocare nuovamente la base
Coloque o filtro do pó limpo, aperte o parafuso e substitua o pé
Sett tilbake rent støvfilter, stram festeskruen og sett tilbake foten

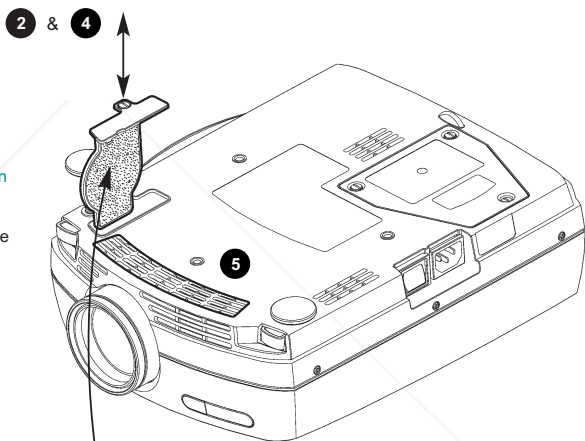

5. Clean all air intakes
Alle Lufteinlässe reinigen
Nettoyez toutes les entrées d'air
Limpie todas las tomas de aire
Pulire tutte le prese d'aria
Limpe todas as entradas de admissão do ar
Rens alle luft innsug

- ⚠ Clean dustfilter regularly for sufficient air flow
Staubfilter regelmäßig reinigen, um eine ausreichende Luftzufuhr zu gewährleisten
Nettoyez régulièrement le filtre à poussière pour assurer un flux d'air suffisant
Limpie con regularidad el filtro del polvo para que se produzca la suficiente circulación del aire
Pulire regolarmente il filtro della polvere per consentire un flusso dell'aria sufficiente
Limpe regularmente o filtro do pó para obter um fluxo de ar suficiente
Rens støvfilteret jevnlig for god luftgjennomstrømning

3

! Change lamp when lifetime expired. Replace expired lamp only with same type and rating

Lampe nach Ablauf der Lebensdauer austauschen. Nur Lampen gleicher Art und Stärke verwenden

Changez la lampe lorsque sa durée de vie arrive à expiration. Ne remplacez la lampe que par une lampe ayant les mêmes caractéristiques.

Cambie la lámpara al término de su vida útil. Sustituya siempre la lámpara gastada por otra del mismo tipo y capacidad
 Sostituire la lampada quando termina la sua vita utile. Sostituire la lampada utilizzando unicamente una della stesso tipo e caratteristiche
Troque a lâmpada quando o tempo útil de vida expirar. Substitua a lâmpada gasta somente por outra do mesmo tipo e valor nominal
 Skift lampe når levetiden er overskredet. Bruk kun lampe av samme t type og med samme effekt



! Disconnect power

Netzstecker ziehen

Débranchez l'appareil

Desconecte la corriente

Scollegare l'alimentazione

Desligue a alimentação

Trekk ut strømledningen



!

Reset lamp timer

Betriebsstundenzähler auf Null setzen

Remettez le compteur de la lampe à zéro

Reinicie el temporizador de la lámpara

Azzerare il temporizzatore della lampada

Etetue o reinicio do temporizador da lâmpada

Tilbakestill telleverket for lampen



1. Open screws on lamp housing
Schrauben des Lampengehäuses öffnen
 Dévissez les vis du logement de la lampe
Abra los tornillos del alojamiento de la lámpara
 Svitare le viti della sede della lampada
Desaperte os parafusos do alojamento da lâmpada
 Løse skruene til lampeholderen
2. Carefully pull out and remove lamp housing
Lampengehäuse vorsichtig herausnehmen
 Tirez avec précautions sur le logement de la lampe pour l'enlever
Extraiga cuidadoso el alojamiento de la lámpara
 Tirare attentamente verso fuori e togliere la sede della lampada
Puxe cuidadosamente para fora e remova o alojamento da lâmpada
 Forsiktig fjern lampeholderen
3. Insert new lamp housing
Neues Lampengehäuse einsetzen
 Posez le nouveau logement de la lampe
Introduzca el nuevo alojamiento de la lámpara
 Inserire la nuova sede della lampada
Insira um novo alojamento da lâmpada
 Sett tilbake ny lampeholder
4. Tighten screws
Schrauben festziehen
 Serrez les vis
Apriete los tornillos
 Avvitare le viti
Aperte os parafusos
 Stram skruene

5. Check filter pad
Filter überprüfen
 Vérifiez le tampon filtre
Examine la almohadilla del filtro
 Controllare il tampone del filtro
Controllar filter

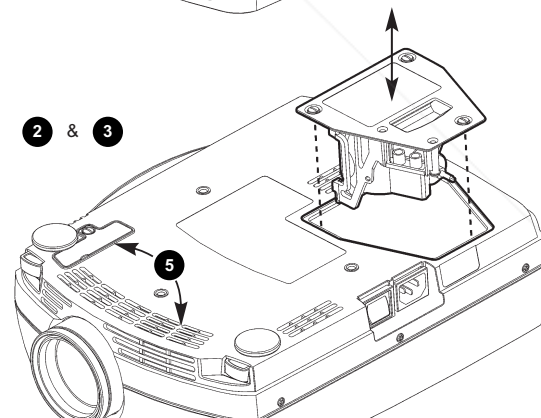
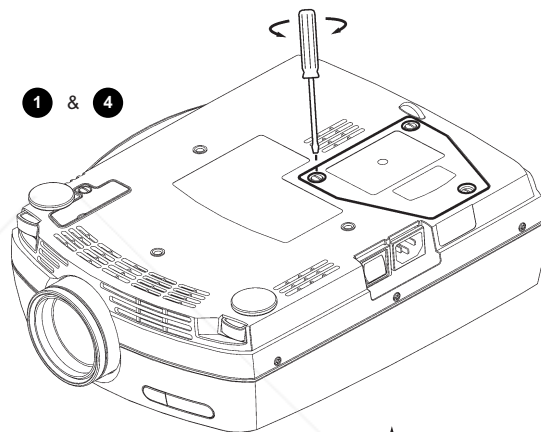
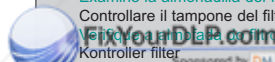

! Refer service to qualified personnel only

Service nur von qualifiziertem Personal durchführen lassen

Ne confiez l'entretien qu'à du personnel qualifié

Confie el mantenimiento solamente a personal cualificado

Affidare la manutenzione solo a personale qualificato

Remeta a assistência somente a pessoal qualificado

All service må overlates til kvalifisert personell





This equipment complies with the limits for a Class A computing device, pursuant to Subpart J of Part 15 of FCC rules. Only peripherals (computer input/output devices, terminals, printers, etc.) certified to comply with the Class A limits may be attached to a computer that complies with Class A limits. When connecting to a peripheral device, a shielded input/output cable is required to ensure compliance with FCC rules. The shielded cable that must be used is supplied with the equipment. Operation with non-certified peripherals or non-shielded cables is likely to result in interference to radio and TV reception.

This equipment generates and uses radio-frequency energy and, if not installed and used in accordance with the instruction manual, may cause interference to radio and television reception. It has been tested and found to comply with the limits for a Class A computing device in accordance with the specifications in Subpart J of Part 15 of the FCC rules, which are designed to provide reasonable protection against such interference when operated in a commercial environment. However, there is no guarantee that interference will not occur in a particular installation. If this equipment does cause interference to radio or television reception, which can be determined by turning the equipment off and on, the user is encouraged to try to correct the interference by one or more of the following measures:

- Reorient the receiving antenna.
- Relocate the projector with respect to the receiver.
- Plug the equipment to a different outlet so that equipment and receiver are on different branch circuits.
- Fasten cables using mounting screws to ensure adequate EMI control.

You may require the following booklet from the Federal Communications Commission (FCC): "How to identify and resolve radio and TV interference problems", available from the U.S. Government Printing Office, Washington, DC 20402, Stock No. 004-000-00345-4.



Discount-Merchant.com (800) 281-8860
THE TRUSTED SOURCE FOR PROJECTOR LAMPS AND ACCESSORIES



Disclaimer

This user manual is provided as a free service by FixYourDLP.com. FixYourDLP is in no way responsible for the content of this manual, nor do we guarantee its accuracy. FixYourDLP does not make any claim of copyright and all copyrights remain the property of their respective owners.

About FixYourDLP.com

FixYourDLP.com (<http://www.fixyourdpl.com>) is the World's #1 resource for media product news, reviews, do-it-yourself guides, and manuals.

Informational Blog: <http://www.fixyourdpl.com>

Video Guides: <http://www.fixyourdpl.com/guides>

User Forums: <http://www.fixyourdpl.com/forum>

FixYourDLP's Fight Against Counterfeit Lamps:

<http://www.fixyourdpl.com/counterfeits>

Sponsors:

RecycleYourLamp.org – Free lamp recycling services for used lamps:

<http://www.recycleyourlamp.org>

Lamp Research - The trusted 3rd party lamp research company:

<http://www.lampresearch.com>

Discount-Merchant.com – The worlds largest lamp distributor:

<http://www.discount-merchant.com>



FixYourDLP.com

Sponsored by 