



# Disclaimer

This user manual is provided as a free service by FixYourDLP.com. FixYourDLP is in no way responsible for the content of this manual, nor do we guarantee its accuracy. FixYourDLP does not make any claim of copyright and all copyrights remain the property of their respective owners.

About FixYourDLP.com

FixYourDLP.com (<http://www.fixyourdpl.com>) is the World's #1 resource for media product news, reviews, do-it-yourself guides, and manuals.

Informational Blog: <http://www.fixyourdpl.com>

Video Guides: <http://www.fixyourdpl.com/guides>

User Forums: <http://www.fixyourdpl.com/forum>

FixYourDLP's Fight Against Counterfeit Lamps:

<http://www.fixyourdpl.com/counterfeits>

## Sponsors:

RecycleYourLamp.org – Free lamp recycling services for used lamps:

<http://www.recycleyourlamp.org>

Lamp Research - The trusted 3rd party lamp research company:

<http://www.lampresearch.com>

Discount-Merchant.com – The worlds largest lamp distributor:

<http://www.discount-merchant.com>



**FixYourDLP.com**

Sponsored by 

Proxima  
Desktop Projector 4100/4200  
User's Guide  
*(not actual cover)*



FixYourDLP.com

Sponsored by  DM

**Discount-Merchant.com (800) 281-8860**

**THE TRUSTED SOURCE FOR PROJECTOR LAMPS AND ACCESSORIES**

## Warranty

Proxima Corporation warrants that the Proxima® Desktop Projector™ product manufactured by Proxima is free from defects in materials and workmanship under normal use during the Warranty Period. The Warranty Period commences on the day of purchase by the end-user. The Warranty Period is one year. The projector lamp is not covered by this Warranty.

Each Proxima product is manufactured from new parts, or new and some used parts. In some cases, the product may have been delivered to another end-user and then returned. In all cases, the product has undergone testing and quality inspection, and Proxima's full warranty terms apply.

The end-user's sales receipt or invoice showing the date of purchase of the product and the name of the Reseller is proof of date of purchase. The Warranty extends only to the original purchaser and is not transferable.

During the Warranty Period, Proxima will, at no additional charge, repair or replace defective parts or at the option of Proxima, replace the entire unit.

This limited Warranty does not extend to any Proxima product that has been damaged or been rendered defective (a) as a result of accident, misuse or other abuse; (b) by the use of parts not manufactured or sold by Proxima; (c) by modification of the product; or (d) as a result of servicing by non-authorized personnel.

## Limitation of Warranties

The foregoing Warranty is expressly in lieu of any other expressed or implied, warranties, including, without limitation, warranties of merchantability or fitness for a particular purpose. To the extent not prohibited by law, all statutory warranties are hereby waived and excluded from this Warranty. Proxima expressly disclaims all warranties not stated in this Limited Warranty.

## FCC Statement

Warning: This equipment generates, uses and can radiate radio frequency energy and, if not installed and used in accordance with the instruction manual, may cause interference to radio communications. It has been tested and found to comply with limits for a Class "A" computing device pursuant to Subpart B of Part 15 of the FCC Rules, which are designed to provide reasonable protection against such interference when operated in a commercial environment. Operation of this equipment in a residential area is likely to cause interference in which case the user, at his own expense, will be required to take whatever measures may be necessary to correct the interference.

## Trademarks, Patents, and Copyrights

Proxima and Cyclops are registered trademarks of Proxima Corporation. MediaExpress, LightBoard, Desktop Projector, Desktop Projection, and Fit-to-View are trademarks of Proxima Corporation. Digital Light Processing is a trademark of Texas Instruments. Macintosh is a registered trademark of Apple Computer, Inc. Other trademarks are the property of their respective owners. This product is covered by one or more of the following U.S. and foreign patent numbers: 5,062,001, 5,137,484, 5,153,568, 5,177,629, 5,181,015, 5,225,875, 5,264,835, 5,276,436, 5,298,892, 5,299,039, 5,300,944, 5,302,946, 5,321,450, 5,400,095, 5,453,803, 5,459,484, 5,483,382, 5,489,923, 5,499,036, 5,502,459, 5,504,501, 5,510,861, 5,512,967, 5,515,079, and DES. 360,426. Foreign patent numbers Canada Registered Design No. 74980 © Proxima Corporation 1994, British Registered Design No. 2 038 977, Germany Registered Design No. M 94.03 987.9 geschütztes Muster, Under Geschmacksusterschutz, China Patent for Design No. 94303399.3, Japan Registered Design No. 948294, South Korea Registered Design No. 174628, Australia Pat. Nos. 644 852, 668 823. Other US and foreign patents applied for.

© 1996 Proxima Corporation. All rights reserved. Specifications are subject to change without notice.



FixYourDLP.com

Sponsored by

Discount Projector Lamps  
THE TRUSTED SOURCE FOR PROJECTOR LAMPS AND ACCESSORIES

---

# Contents

## **Chapter 1**

### *Your Proxima Desktop Projector™ 4100/4200*

What's in the Box? .....	1-2
Quick Start .....	1-3
Connector Panel .....	1-5
Control Panel .....	1-6
Options and Accessories .....	1-7

## **Chapter 2**

### *Setting Up the Desktop Projector™ 4100/4200*

Your DP4100/4200 .....	2-1
Getting Started .....	2-2
Connector Panel .....	2-5
Connecting Power to the Projector .....	2-6
Connecting Computer Video .....	2-6
Connecting Computer Audio .....	2-10
Connecting Composite Video .....	2-11
Connecting an S-Video Source .....	2-11
Connecting Non-Computer Audio .....	2-12

## **Chapter 3**

### *Using the Desktop Projector™ 4100/4200*

Turning on the Projector and Lamp .....	3-1
Focusing the Image .....	3-2
Image Size .....	3-3
Turning off the Projector .....	3-4
Control Panel Keys .....	3-4
Control Panel Indicators .....	3-9
Using the Cyclops Remote Control .....	3-10
Operating the Projector .....	3-12
The Graphical User Interface .....	3-14
Using the Main Menu .....	3-15
Selecting a Tool .....	3-16
Input Source Menu .....	3-20
Image Menu .....	3-21
Audio Menu .....	3-24

Using the Audio Menus .....	3-26
Preferences Menu .....	3-27
Advanced Menu .....	3-28

## **Chapter 4**

### *Cyclops F/X*

Installing Cyclops F/X .....	4-2
Starting Cyclops F/X .....	4-2
Assignments Area .....	4-3
Customizing Effects .....	4-4
Using the Cyclops Interactive Pointer System .....	4-5
See-it/Show-it .....	4-7
Freeze .....	4-8
Starting an Effect .....	4-9
The Presentation Effects .....	4-9
Menu Commands .....	4-11

## **Chapter 5**

### *Maintenance*

Replacing the Lamp .....	5-1
Cleaning the Lens .....	5-3
Changing Remote Control Batteries .....	5-3
Changing Batteries—Cyclops Quick Remote .....	5-4
Cleaning and Replacing the Noise Filter .....	5-4

## **Chapter 6**

### *Troubleshooting*

Where to Get Help .....	6-1
Returning Your DP4100/4200 for Repair .....	6-5
Ordering Parts .....	6-5

## **Appendix A**

### *Specifications*

DP4100/4200 Specifications .....	A-1
----------------------------------	-----

## **Appendix B**

### *Accessories and Parts*

Replacement Parts .....	B-1
-------------------------	-----

## **Index**



FixYourDLP.com  
Sponsored by

Discount-Merchant.com (800) 281-8860  
THE TRUSTED SOURCE FOR PROJECTOR LAMPS AND ACCESSORIES

## Chapter 1

# Your Proxima Desktop Projector™ 4100/4200

The Proxima® Desktop Projector™ family consists of portable, color data and video LCD and Digital Light Processing™ (DLP) Desktop Projection™ products that make sharing data and presenting information as easy as connecting your computer to your monitor.

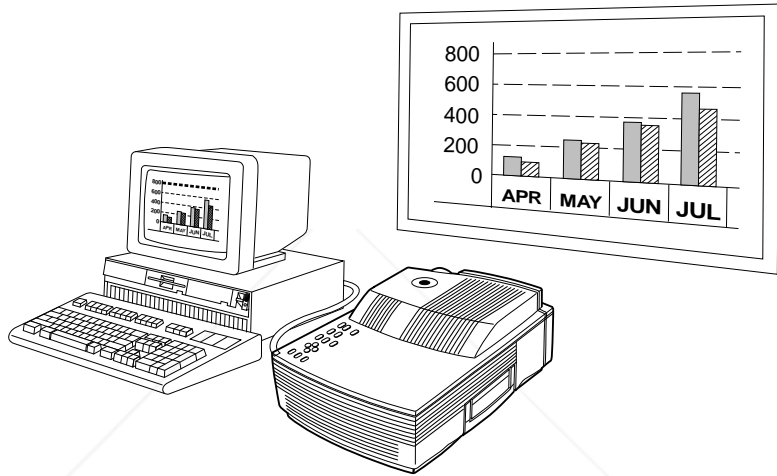

**Figure 1-1** The Proxima DP4100/4200 in use

This manual covers the Desktop Projector™ 4100 and 4200, which both use Digital Light Processing technology to provide images of unrivaled clarity and color accuracy.



**Discount-Merchant.com (800) 281-8860**  
**THE TRUSTED SOURCE FOR PROJECTOR LAMPS AND ACCESSORIES**

## WHAT'S IN THE BOX?

After you've opened the box and removed the DP4100/4200 and accessory packs, make sure you have all of the items shown in Figure 1-2.

**⚠ CAUTION!** *The DP4100/4200 should be treated like any other precision optical instrument. Handle it carefully.*

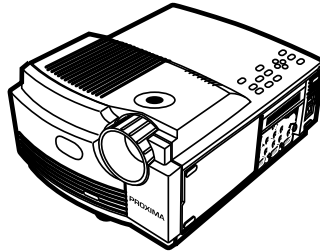

Proxima  
Desktop Projector



Remote Control



Power Cord

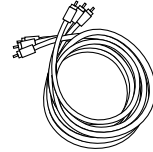

Audio/Video  
(AV) Cable

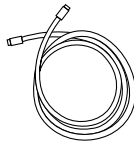

S-Video Cable



Computer  
Audio Cable

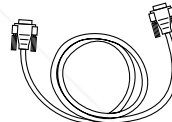

VGA Video Cable



Mini Jack to  
RCA Adapter



Mac - VGA  
Cable Adapter



VGA - Mac  
Monitor Adapter

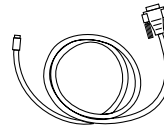

Serial Cable



ADB Cable



Cyclops Quick  
Remote Control  
A85

Also included but not shown:

- (2) AAA Alkaline Batteries
- User's Guide
- Product Registration Card

**Figure 1-2.** Items included with the DP4100/4200

All models also include power cords for Europe, Great Britain, and Italy.

## QUICK START

Place the DP4100/4200 on a solid flat surface at a right angle (perpendicular) to the projection screen, parallel to the floor. Follow the appropriate section below for the type of system that you have.

**NOTE:** The DP4100/4200 has two sets of computer video and audio inputs. The following examples describe the use of input 1.

### Desktop PCs

- 1 Unplug the monitor cable from the computer.
- 2 Plug the end of the supplied VGA cable with the large round collar into the COMPUTER 1 IN port on the projector. Plug the other end into the computer Monitor Out port.
- 3 Connect your audio source to the COMPUTER 1 AUDIO inputs on the projector.
- 4 You can project without using the PC monitor. To use the monitor, plug the monitor cable into the MONITOR OUT port on the projector.
- 5 Turn the projector on and press the  key.

### Desktop Macintosh Computers

- 1 Unplug the monitor cable from the computer.
  - 2 Plug the end of the supplied VGA video cable with the large round collar into the COMPUTER 1 IN port on the projector. Attach the VGA end of the Mac - VGA cable adapter to the other end of the VGA video cable.
  - 3 Plug the Mac end of the Mac - VGA cable adapter into your computer's video port.
  - 4 Connect your audio source to the COMPUTER 1 AUDIO inputs on the projector.
  - 5 To project and view the monitor at the same time, plug the monitor cable into the Mac end of the VGA - Mac monitor adapter.
- NOTE:** The DP4100/4200 only supports the Multi-Sync standard as separate monitors for Macintosh desktop computers.
- 6 Plug the VGA end of the VGA - Mac monitor adapter into the MONITOR OUT port on the projector.
  - 7 Turn the projector on and press the  key.



**NOTE:** If you turn the projector off while the computer is running, the external monitor will go blank. This is normal. Just turn the projector on again and the monitor display will return.

## Notebooks

**NOTE:** If you are connecting to an Apple PowerBook, attach the Mac - VGA cable adapter to the computer's Video Out port (or video adapter cable).

- 1 Plug the COMPUTER end of the VGA Video cable into the notebook's VGA Out port or into the Mac - VGA cable adapter (Macintosh only).
- 2 Plug the end of the VGA Video cable with the large round collar into the COMPUTER 1 IN port on the projector.
- 3 Connect your audio source to the COMPUTER 1 AUDIO inputs on the projector.
- 4 Turn on the projector and press the  key.

## Special Configurations

If your computer has an internal monitor but no external video capability (such as the Macintosh Performa 575, PowerMac 5200, and certain PowerBooks), you need a video adapter card in order to attach the DP4100/4200.

Setup for a third-party adapter is identical to the procedures outlined in the *Quick Start* section above. Contact your dealer, Proxima Customer Service, or a third-party supplier for more information about an appropriate video adapter.



**Discount-Merchant.com (800) 281-8860**  
**THE TRUSTED SOURCE FOR PROJECTOR LAMPS AND ACCESSORIES**

## CONNECTOR PANEL

All connections between the DP4100/4200 and computer or video source are made on the side connector panel.

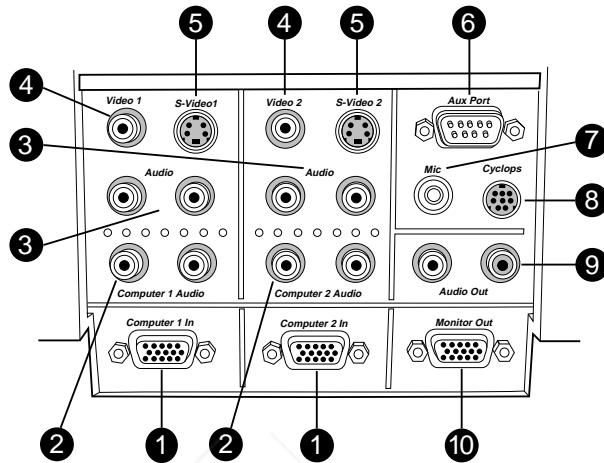

Figure 1-3 The Connector Panel

CONNECTOR	DESCRIPTION
1	COMPUTER 1 & 2 IN Connects computer video to the projector.
2	COMPUTER 1 & 2 AUDIO Allows stereo/mono audio input from the computer.
3	AUDIO Allows stereo/mono audio input from an NTSC, PAL, or SECAM source.
4	VIDEO 1 & 2 Allows video input from an NTSC, PAL, or SECAM source.
5	S-VIDEO 1 & 2 Allows S-Video video input.
6	AUX PORT For serial mouse use and software upgrades.
7	MIC Allows audio input from a microphone.
8	CYCLOPS Connects your computer for Cyclops input or output and for use of Cyclops F/X software.
9	AUDIO OUT Provides audio output to an external stereo system.
10	MONITOR OUT Provides computer video output to a separate monitor.

## CONTROL PANEL

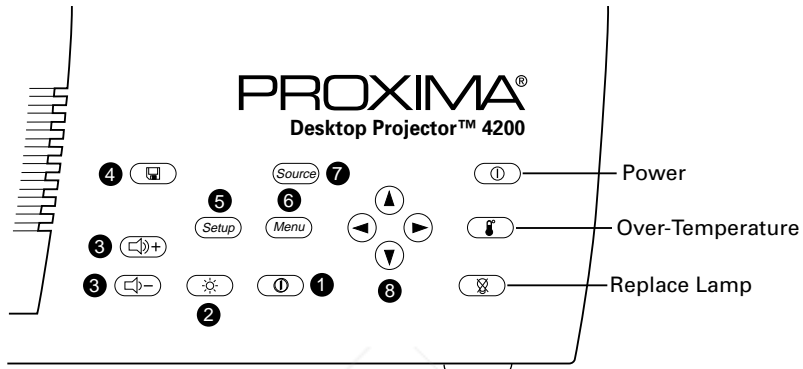

The DP4100/4200's control panel keys are used to turn the projector on or off, adjust the projected image, and to display and hide the menu.

Power, warning, and alert lights give you important information about how your projector is working.



**Figure 1-4** The Control Panel

	KEY	FUNCTION
1		Turns the projector on or off if AC power switch is on.
2		Turns the image to a black screen.
3		Adjusts the volume up or down.
4		Activates the MediaExpress system (if installed).
5		Activates the Setup menu.
6		Displays or hides the menu.
7		Switches the video inputs.
		Controls the menu and adjusts screen position.

LIGHT	FUNCTION
	Glows green if AC input and projector power supplies are okay. Glows red if not.
	Glows red to warn of an over-temperature condition.
	Glows red if the projection lamp burns out.

## OPTIONS AND ACCESSORIES

### The MediaExpress System

The MediaExpress™ system is a hybrid, next-generation product that brings the functionality of computers and projectors much closer together.

The MediaExpress system eliminates the need to hook up a computer to the DP4100/4200. Just print your presentation from whatever application you're using to a special kind of file (called a .PDF file), copy or store the file on a disk, then place the disk in the MediaExpress disk drive and start the show.

### Cyclops

The Proxima Cyclops® interactive pointer system uses a built-in camera to function like a cordless mouse. With Cyclops, you can control your computer's cursor by moving the hand-held wand or pointing with an optional hand-held laser.

### Wireless Audio

Proxima's exclusive wireless audio system operates in the 900 MHz RF band. A user-installable transmitter sends stereo audio to speakers that decode the signal for room-filling stereo sound.

The speakers have built-in RF receivers and can be switched to receive left, right, or monaural signals. The user can power the speakers with either AC or battery power.



**NOTE:** Check your local regulations to make sure that the 900 MHz frequency is available for use.

**Discount-Merchant.com (800) 281-8860**  
**THE TRUSTED SOURCE FOR PROJECTOR LAMPS AND ACCESSORIES**

## Chapter 2

# Setting Up the Desktop Projector 4100/4200

### YOUR DP4100/4200

Before you begin, locate the main parts of the DP4100/4200.

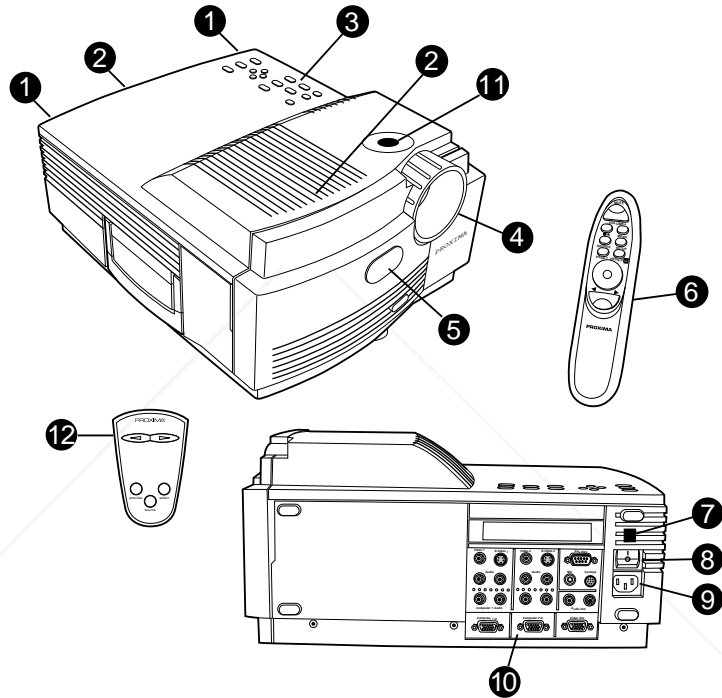

**Figure 2-1** The Proxima DP4100/4200 and Cyclops Remote Controls

- |                           |                          |
|---------------------------|--------------------------|
| 1. Internal Speakers      | 7. Circuit Breaker       |
| 2. Cooling Fans           | 8. Main AC Power Switch  |
| 3. Control Panel          | 9. Power Cord Receptacle |
| 4. Zoom Lens Assembly     | 10. Connector Panel      |
| 5. Cyclops/Infrared Lens  | 11. Workgroup Knob       |
| 6. Cyclops Remote Control | 12. Cyclops Quick Remote |

**NOTE:** The international version has three extra power cords for Europe, Great Britain, and Italy.

## GETTING STARTED

### Positioning the Projector

Place the projector on a solid, flat surface at a right angle (perpendicular) to the projection screen and parallel to the floor. If you're using a media cart, make sure the wheels are locked to prevent it from moving.

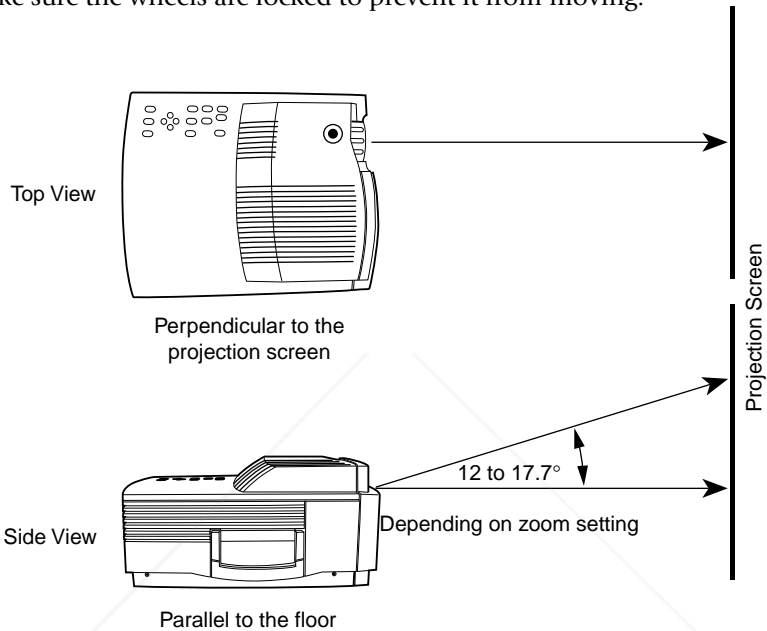

**Figure 2-2** Positioning the projector



**Discount-Merchant.com (800) 281-8860**  
**THE TRUSTED SOURCE FOR PROJECTOR LAMPS AND ACCESSORIES**

## Transporting and Moving the Projector

The projector has a recessed handle located in one of the side panels. Always use the handle to transport the projector. The projector has protective feet on the side opposite the handle, as well as on the bottom.

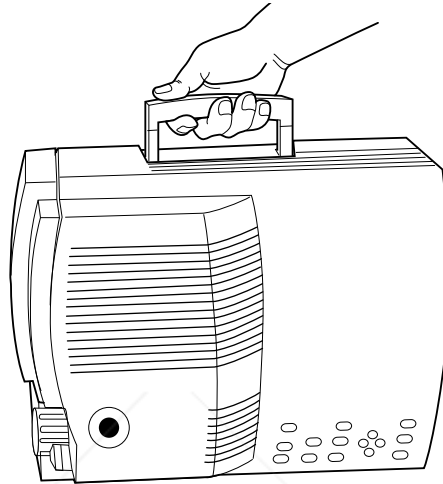

**Figure 2-3** Transporting the projector

If you are moving the projector a short distance, grasp it securely at the sides by the lower parts of the housing to support the weight of the unit.

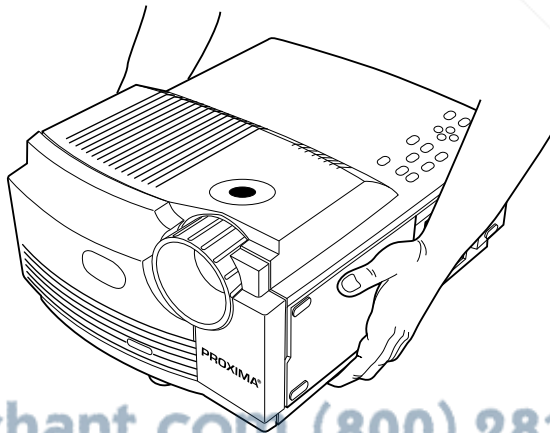
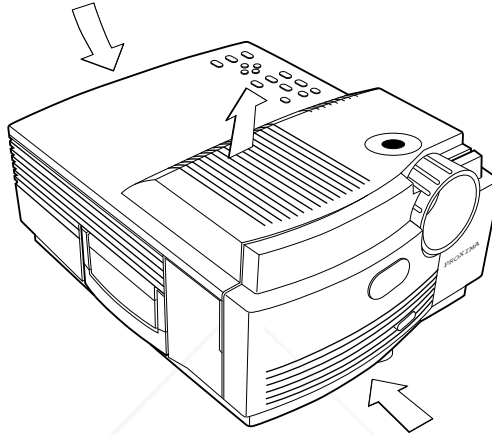

**Figure 2-4** Moving the projector

## Projector Cooling and Airflow

Locate the air intake grills on the front and rear of the projector, and the air exhaust grill on the top cover.

**⚠ CAUTION!** *Never operate the projector if these grills are clogged or obstructed, or if the electric fans are not running.*



**Figure 2-5** Allow for proper air flow



**Discount-Merchant.com (800) 281-8860**  
**THE TRUSTED SOURCE FOR PROJECTOR LAMPS AND ACCESSORIES**



## CONNECTOR PANEL

All connections between the projector and your computer or video source are made on the side connector panel.

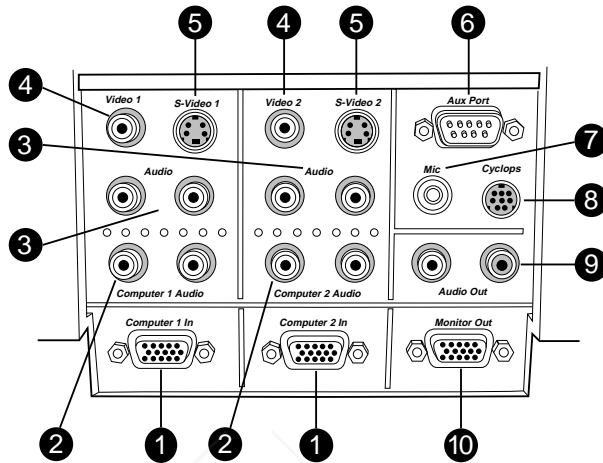
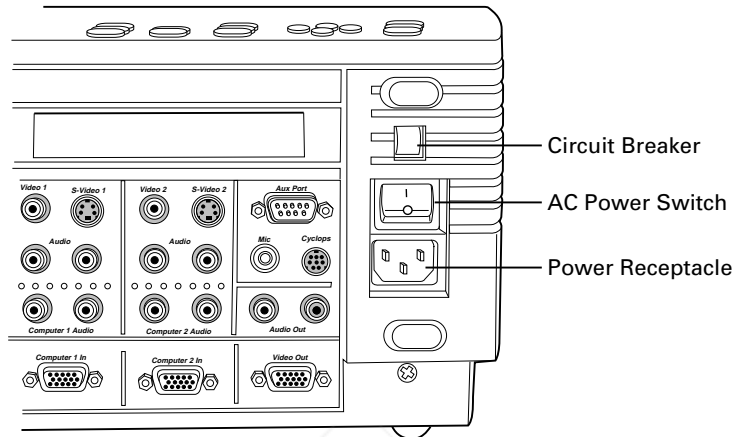

**Figure 2-6** The Connector Panel

	CONNECTOR	DESCRIPTION
1	COMPUTER 1 & 2 IN	Connects computer video to the projector.
2	COMPUTER 1 & 2 AUDIO	Allows audio input from the computer.
3	AUDIO	Allows audio input from an NTSC, PAL, or SECAM source.
4	VIDEO 1 & 2	Allows video input from an NTSC, PAL, or SECAM source.
5	S-VIDEO 1 & 2	Allows S-Video input.
6	AUX PORT	For serial mouse use and software upgrades.
7	MIC	Allows audio input from a microphone.
8	CYCLOPS	Connects computer for Cyclops input or output and for use of Cyclops F/X software.
9	AUDIO OUT	Provides stereo audio output to an external speaker system.
10	MONITOR OUT	Provides computer video output to a separate monitor.

## CONNECTING POWER TO THE PROJECTOR

The power cord receptacle, AC POWER switch, and circuit breaker are located next to the connector panel of the projector.



**Figure 2-7** Power receptacle, AC Power switch, and circuit breaker reset switch

- 1 Plug the appropriate power cord into the power receptacle on the side of the projector.
- 2 Connect the power cord to a properly-grounded wall outlet.

## CONNECTING COMPUTER VIDEO

### Connecting a PC

Use the included VGA video cable to connect your PC to the projector. Use your existing monitor cable to connect the projector to a separate monitor, so that you can use your monitor and DP4100/4200 at the same time.

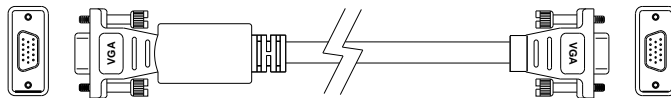

VGA Connector Cable

**Figure 2-8** VGA Video cable

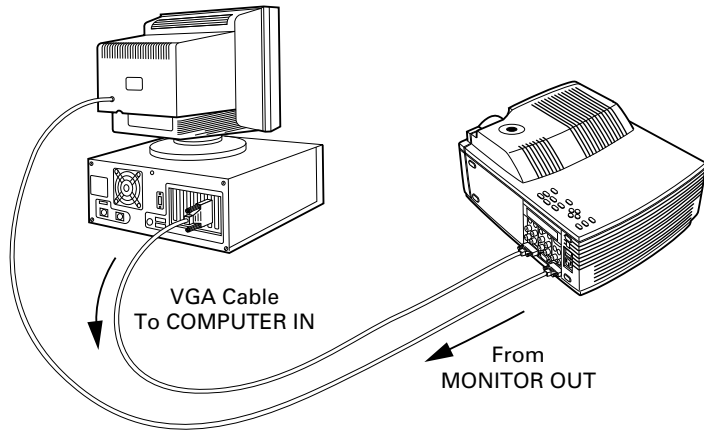

**Figure 2-9** VGA connections

- 1 Unplug the monitor cable from the computer.
- 2 Plug the end of the supplied VGA cable with the large round collar into the COMPUTER 1 IN port on the projector. Plug the other end of the VGA cable into the computer's Video Out (VGA) port.
- 3 Connect your audio source to the COMPUTER 1 AUDIO inputs on the projector.

**NOTE:** If you are using a second computer video or audio source, plug their outputs into the COMPUTER 2 IN and COMPUTER 2 AUDIO connectors.

- 4 If you want to use an external monitor, connect the monitor cable to the MONITOR OUT port of the projector.
- 5 Turn the projector on and press the  key.

**NOTE:** An external monitor is not required to use the DP4100/4200.



**Discount-Merchant.com (800) 281-8860**  
**THE TRUSTED SOURCE FOR PROJECTOR LAMPS AND ACCESSORIES**

## Connecting Macintosh Computers

The video adapters shown below are used to connect a Macintosh computer and monitor to the DP4100/4200.

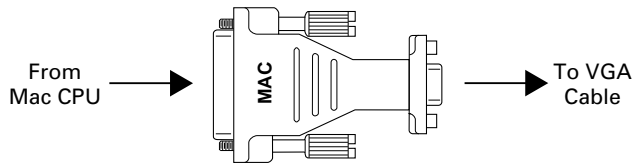

Mac - VGA Cable Adapter

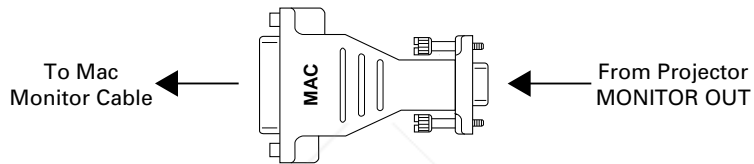

VGA - Mac Monitor Adapter

**Figure 2-10** The Macintosh adapters

Use the cable adapters and supplied VGA video cable to connect the projector to your Macintosh computer.

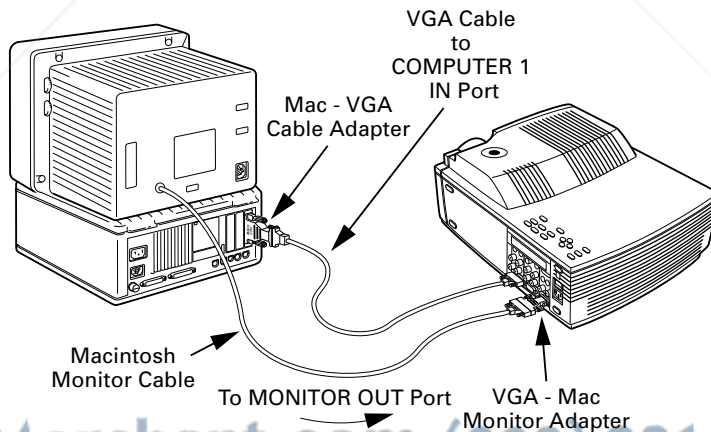

**Figure 2-11** Macintosh connections

- 1 Unplug the Macintosh monitor cable from the computer.
- 2 Plug the end of the supplied VGA video cable with the large round collar into the COMPUTER 1 IN port on the projector. Attach the VGA end of the Mac - VGA cable adapter to the other end of the VGA video cable.
- 3 Plug the Mac end of the Mac - VGA cable adapter into the Macintosh video port.
- 4 Connect the audio source to the projector's COMPUTER AUDIO 1 ports.

**NOTE:** If you are using a second computer video or audio source, plug their outputs into the COMPUTER 2 IN and COMPUTER 2 AUDIO connectors.

Use the VGA - Mac monitor adapter and your existing monitor cable to connect the projector to a separate computer monitor, so you can view computer video on the projector screen and the monitor at the same time.

**NOTE:** The DP4100/4200 only supports the Multi-Sync standard as separate monitors for Macintosh desktop computers.

- 5 To project and view the monitor at the same time, plug the monitor cable into the Mac end of the VGA - Mac monitor adapter.
- 6 Plug the VGA end of the VGA - Mac monitor adapter into the MONITOR OUT port on the projector.
- 7 Turn the projector on and press the  key.

**NOTE:** An external monitor is not required to use the DP4100/4200.

## Connecting Notebook Computers

Use the appropriate cable and adapter to connect your portable computer to the projector.

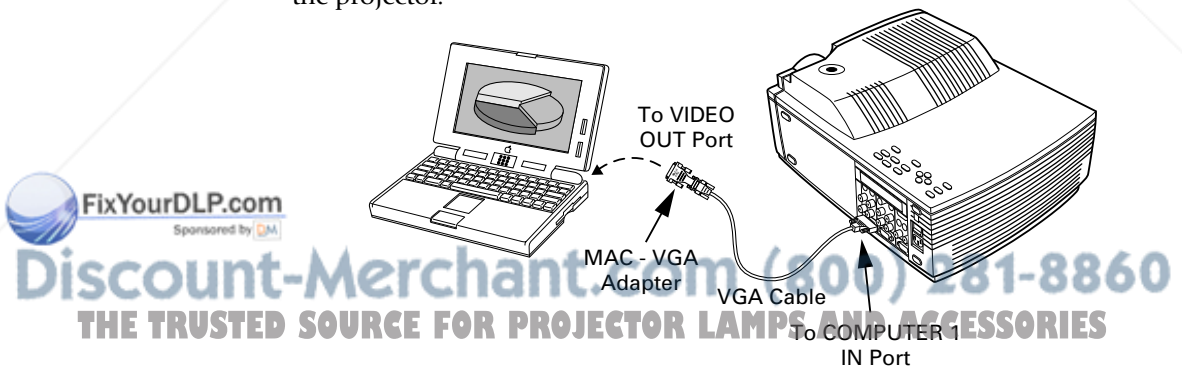

**Figure 2-12** Laptop connections

**NOTE:** If you are connecting to an Apple PowerBook, attach the Mac - VGA cable adapter to the computer's VIDEO OUTPUT port (or video adapter cable).

- 1 Plug the COMPUTER end of the VGA cable into the computer's VGA or Video Out port or into the Mac - VGA cable adapter (Macintosh only).
- 2 Plug the end of the supplied VGA cable with the large round collar into the COMPUTER 1 IN port on the projector.
- 3 Connect your audio source to the COMPUTER AUDIO 1 ports on the projector.
- 4 Turn the projector on and press the  key.

**NOTE:** If your projector is unable to project an image at the same time your laptop monitor displays an image, refer to your laptop documentation for information on switching between the internal screen and the video port.

## Special Configurations

If your computer has an internal monitor but no external video capability (Macintosh Performa 575, PowerMac 5200, and certain PowerBooks), you need a video adapter card in order to attach the DP4100/4200.

Setup for a third-party adapter is identical to the procedures outlined in the *Quick Start* section in Chapter 1. Contact your dealer, Proxima Customer Service, or a third-party supplier for more information about an appropriate video adapter.

## CONNECTING COMPUTER AUDIO

Connect audio inputs from a computer to the COMPUTER 1 & 2 AUDIO ports with the supplied audio cable.

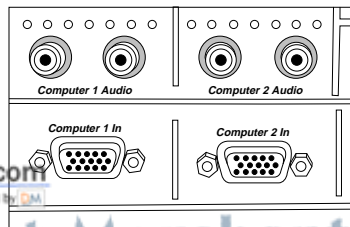

**Figure 2-13** Computer 1 & 2 Audio ports

- 1 Insert the mini-jack end of the computer audio cable into the AUDIO OUT port of a Macintosh or the sound card of a PC.

- 2 Insert the RCA jacks on the other end of the computer audio cable into the projector's left and right COMPUTER 1 AUDIO ports. If you are using two audio sources, connect the second one to the projector's COMPUTER 2 AUDIO ports.

If your audio source is monaural, your projector will provide a simulated stereo output. Connect your source to the left COMPUTER 1 AUDIO port.

**NOTE:** Although both COMPUTER AUDIO and AUDIO may be connected simultaneously, only one can be active. If computer video is selected, COMPUTER AUDIO is active. If NTSC/PAL/SECAM/S-Video video is being viewed, AUDIO is active.

## CONNECTING COMPOSITE VIDEO

You can display composite video (NTSC, PAL or SECAM) on the DP4100/4200.

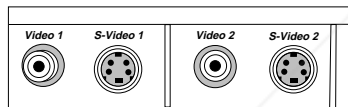

**Figure 2-14** Video 1 & 2 ports

Use the supplied AV cable (see page 1-2) to connect an NTSC, PAL, or SECAM source to your projector.

- 1 Find the RCA connector on your video source marked VIDEO OUT or something similar. This connector is usually yellow. Insert one of the AV cable's yellow connectors into the VIDEO OUT jack of the video source.
- 2 Insert the other yellow connector into the projector's VIDEO 1 port.

## CONNECTING AN S-VIDEO SOURCE

To connect an S-Video source, use the supplied S-Video cable (see page 1-2) instead of an RCA cable connection. The S-Video cable has identical, round, 4-pin mini-DIN connectors on both ends.



**Figure 2-15** The S-VIDEO port

To connect an S-video source:

- 1 Insert one end of the S-VIDEO cable into the mini-DIN Video Out port of the video source device.
- 2 Insert the other end of the S-VIDEO cable into the projector's S-VIDEO port.

## CONNECTING NON-COMPUTER AUDIO

The AUDIO ports allow the projector to receive stereo or monaural audio inputs from a composite video source.

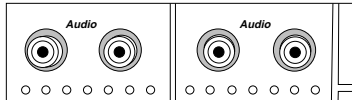

**Figure 2-16** Audio Input ports

For stereo audio, use the supplied AV cable.

- 1 Insert the red (right) and white (left) ends of the cable into the AUDIO OUT ports of a composite video's audio source.
- 2 Connect the other end of each cable to the projector's AUDIO ports.

**NOTE:** Although both *COMPUTER AUDIO* and *AUDIO* may be connected simultaneously, only one can be active. If computer video is selected, *COMPUTER AUDIO* is active. If *NTSC/PAL/SECAM/S-Video* video is being viewed, *AUDIO* is active.

If your TV audio source outputs only monaural audio, your Desktop Projector will provide simulated stereo audio. Connect the audio source to the left AUDIO port.



**Discount-Merchant.com (800) 281-8860**  
**THE TRUSTED SOURCE FOR PROJECTOR LAMPS AND ACCESSORIES**



## Connecting a Mouse to the AUX Port (Serial)

A Microsoft®-compatible mouse can be connected to the AUX PORT to control many of the projector's built-in features. You can use your mouse to navigate the projector's menus in Local Mode or to function as the computer's system mouse in Host Mode (see *Chapter 3*).

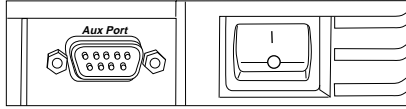

Figure 2-17 The Aux port

## Connecting a Microphone

When you need to address a larger audience while projecting an image, plug an amplified or wireless microphone equipped with a line level output (maximum level of 1 volt, peak-to-peak) into the MIC port.

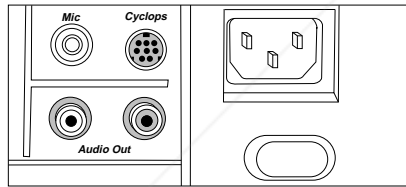

Figure 2-18 Microphone input

## Connecting Cyclops

Use the CYCLOPS port to connect the projector and optional Cyclops interactive pointer system to the computer.

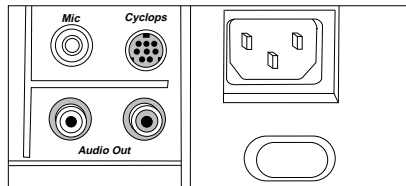

Figure 2-19 The Cyclops port

The optional Cyclops interactive pointer system is shipped with its own Installation and User's Guides. The Cyclops kit also includes extra cables to connect the projector and the computer.

- 1 Connect one end of the appropriate serial cable to the projector's CYCLOPS port.
- 2 Connect the other end of the cable to the computer:
  - On a PC, connect the computer end to a serial port.
  - On a Macintosh, connect the computer end to an ADB connector.

## Projector Audio Out

The projector contains an internal stereo system consisting of an amplifier and two speakers. Although this system provides high-quality stereo output, a multimedia presentation may require independently powered speakers or an external sound system.

**NOTE:** The projector's internal speakers can be turned on or off using the Audio menu (see page 3-24).

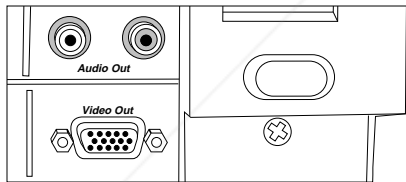

**Figure 2-20** The Audio Out port

To connect your projector to an external stereo system:

- 1 Insert the RCA jacks of the stereo system speaker composite video/audio cable into the projector's AUDIO OUT ports.
- 2 Insert the RCA jacks at the other ends into the external amplifier or powered speaker system's left and right AUDIO IN ports.

**NOTE:** A mini-jack to RCA adapter is provided (see page 1-2) in case your external speaker system has a mini-jack plug.



FixYourDLP.com  
Sponsored by



**Discount-Merchant.com (800) 281-8860**  
**THE TRUSTED SOURCE FOR PROJECTOR LAMPS AND ACCESSORIES**

## Chapter 3

# Using the Desktop Projector 4100/4200

### TURNING ON THE PROJECTOR AND LAMP

Power the DP4100/4200 up before the computer. This allows the computer to sense the projector during its startup sequence.

Move the AC POWER switch to the ON position. The  indicator on the projector control panel turns green and the  key turns orange to indicate a successful self-test.

The lamp is off when you first turn on the projector. Press the  key on the operator panel for one second to turn the lamp on. The key blinks for a few seconds while the lamp warms up, and then turns to a steady green color.

Next, turn on your computer. If you turn the projector off while the rest of your computer system is running, your external monitor will go blank. This is normal. Just turn the projector on again and your monitor display will return.

**⚠ CAUTION!** *Never operate the projector if the air intake or exhaust grills are clogged or obstructed, or if the electric fan is not running.*

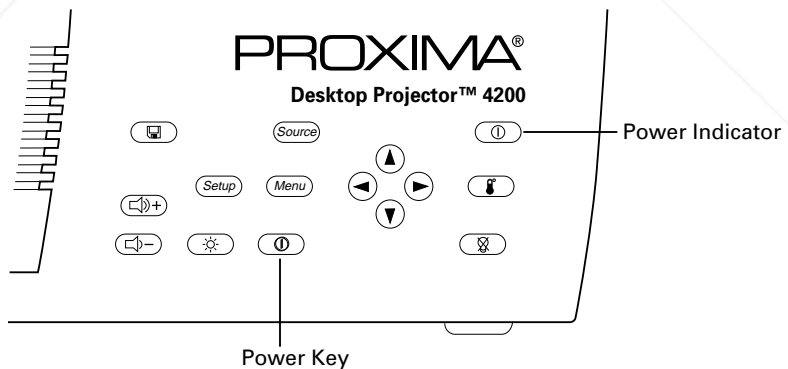



Figure 3-1 Projector power key

## FOCUSING THE IMAGE

- 1 Use the Setup menu (see page 3-6) to adjust the focus. Press the  key and use the right and left arrow keys to adjust the focus.
- 2 You can also use the [Prog 1] or [Prog 2] key on the Cyclops remote control to set the focus. These keys can be (and may have been) reprogrammed for other functions (see Advanced menu, page 3-28).



**Discount-Merchant.com (800) 281-8860**  
**THE TRUSTED SOURCE FOR PROJECTOR LAMPS AND ACCESSORIES**

## IMAGE SIZE

Use the following tables as a guide in focusing your image.

### *DP4100z*

<b>FEET (METERS) FROM IMAGE</b>	<b>MIN. DIAG.</b>	<b>MAX. DIAG.</b>
5 (1.5)	2.3 (0.7)	3.4 (1.0)
6 (1.8)	2.7 (0.8)	4.1 (1.2)
7 (2.1)	3.2 (1.0)	4.8 (1.5)
8 (2.4)	3.6 (1.1)	5.4 (1.7)
9 (2.7)	4.1 (1.2)	6.1 (1.9)
10 (3.0)	4.5 (1.4)	6.8 (2.1)
15 (4.6)	6.8 (2.1)	10.2 (3.1)
20 (6.1)	9.1 (2.8)	13.6 (4.1)
25 (7.6)	11.4 (3.5)	17.0 (5.2)
30 (9.1)	13.6 (4.2)	20.4 (6.2)



### *DP4200z*

<b>FEET (METERS) FROM IMAGE</b>	<b>MIN. DIAG.</b>	<b>MAX. DIAG.</b>
5 (1.5)	2.9 (0.9)	4.3 (1.3)
6 (1.8)	3.4 (1.0)	5.1 (1.6)
7 (2.1)	4.0 (1.2)	6.0 (1.8)
8 (2.4)	4.6 (1.4)	6.8 (2.1)
9 (2.7)	5.2 (1.6)	7.7 (2.3)
10 (3.0)	5.7 (1.7)	8.5 (2.6)
15 (4.6)	8.6 (2.6)	12.8 (3.9)
20 (6.1)	11.5 (3.5)	17.0 (5.2)
25 (7.6)	14.4 (4.4)	21.3 (6.5)
30 (9.1)	17.2 (5.2)	25.5 (7.8)



**Discount-Merchant.com (800) 281-8860**  
**THE TRUSTED SOURCE FOR PROJECTOR LAMPS AND ACCESSORIES**

## TURNING OFF THE PROJECTOR

- 1 Press and hold the  key for one second to turn the projector off. The key glows orange. When using the Cyclops remote control, press and hold the  key for two seconds. The projector will beep twice to acknowledge the command.
- 2 When the fan stops, the projector is cool and you can turn the AC POWER Switch off.

**NOTE:** Turning the lamp off does not turn the projector power off. The fan will still operate for 30 seconds. You must move the AC POWER switch to the OFF position to completely power down the projector.

## CONTROL PANEL KEYS

The DP4100/4200's control panel keys are used to turn the projector on or off, adjust the projected image, and to display and hide the menu.

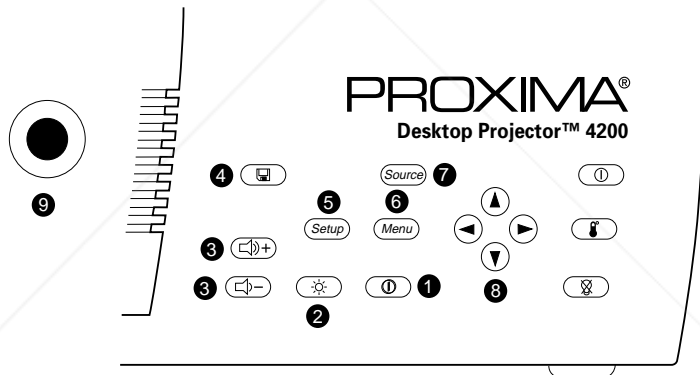















Figure 3-2 Control Panel keys

	<b>KEY(S)</b>	<b>FUNCTION</b>
1		Turns the lamp on or off if AC power switch is on.
2		Turns the image to a black screen.
3	 	Increases or decreases the volume.
4		Activates the MediaExpress system (if installed).
5		Activates the Setup menu.
6		Displays or hides the menu.
7		Switches through the video inputs.
8		Controls the menu and adjusts screen position.
9		Workgroup knob. Switches to Workgroup mode.





## Power

The  key is used to turn the lamp on or off. To turn the projector lamp off, press the  key for at least one second. On the Cyclops remote control, press the  key for at least two seconds. The projector will beep twice to acknowledge the command. The projector will shut off in 30 seconds.

## Hide

The  key is used to switch the image to a black screen. Use this key when you want to present information without displaying the computer or video image.

## Arrows

The   
  
  
 keys allow you to:

- Make small adjustments in the position of the projected image. Press the arrow keys to shift the images in the direction indicated by the arrow, or
- Modify settings in the Menus.



## **Menu**

Press the  key to display the menu options in the upper portion of the projected image. If a menu selection is not made within five seconds, the menu will disappear. Menu settings are automatically stored when you exit the menus.

## **Source**

The  key allows you to switch between active connected sources.

## **Volume**

The  keys display a slide bar to adjust the audio output levels of the projector. Press the  key to increase or the  key to decrease the audio output levels. These keys control both internal and external audio levels.

## **Setup**

Press the  key to display the Setup menu. The projector will display a set of slide bars to help you adjust the image. These include the adjustments on the Image menu (see page 3-21), as well as Horizontal and Vertical position controls to move the image on the screen.

**NOTE:** *The Setup adjustment choices will be different for each type of input source.*



**Discount-Merchant.com (800) 281-8860**  
**THE TRUSTED SOURCE FOR PROJECTOR LAMPS AND ACCESSORIES**



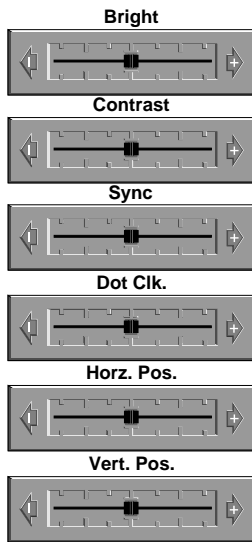

**Figure 3-3** Computer Source Setup slide bars

Use the ▲ and ▼ keys to select the item you want to adjust. The gray box and slide bars will appear. Press ► or ◀ to adjust the selected item. Press **Setup** again to accept the new setting. The display disappears after five seconds if no actions are taken.

SETTING	PURPOSE	AVAILABLE ON
<b>Focus</b>	Adjust focus	All Sources
<b>Zoom</b>	Zoom in or out	All Sources
<b>Bright</b>	Increase/decrease brightness	All Sources
<b>Contrast</b>	Increase/decrease the contrast level of the image	All Sources
<b>Sync</b>	Fine tune the dot clock phase	Computer Video
<b>Dot Clk.</b>	Adjust pixels per line	Computer Video
<b>Horz. Pos</b>	Move the image left or right	Computer Video
<b>Vert. Pos</b>	Move the image up or down	Computer Video
<b>Tint</b>	Increase/decrease red/green colors	Composite Video
<b>Saturation</b>	Increase/decrease color saturation	Composite Video

## The MediaExpress™ system

Press the  key to activate the MediaExpress system (if installed). The MediaExpress system is an optional, next-generation product that brings the functionality of computers and projectors closer together. A diskette with a .PDF file is placed into the DP4100/4200's optional MediaExpress disk drive, and a slide show can be run *without* connecting a computer to the projector.

## Workgroup Mode

The Workgroup knob switches the projector to an extra bright (1050 lumen for DP4100z and 1400 lumen for DP4200z) monochrome mode for displaying spreadsheets and other text-based information. Pull the knob up for Workgroup mode. Push it down for full color.

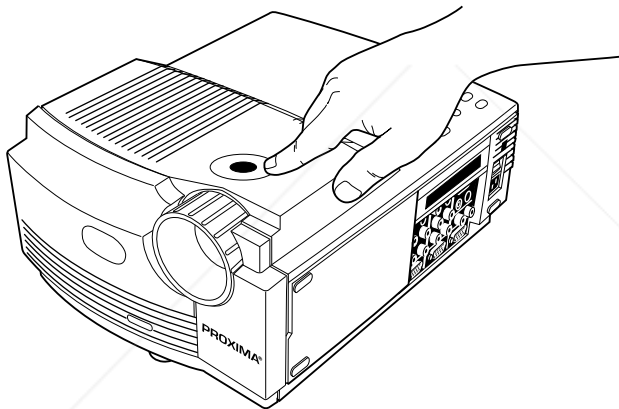

**Figure 3-4** Workgroup knob



FixYourDLP.com

Sponsored by 

**Discount-Merchant.com (800) 281-8860**

**THE TRUSTED SOURCE FOR PROJECTOR LAMPS AND ACCESSORIES**

## CONTROL PANEL INDICATORS

Power, warning, and alert indicators give you important information about how your projector is working.

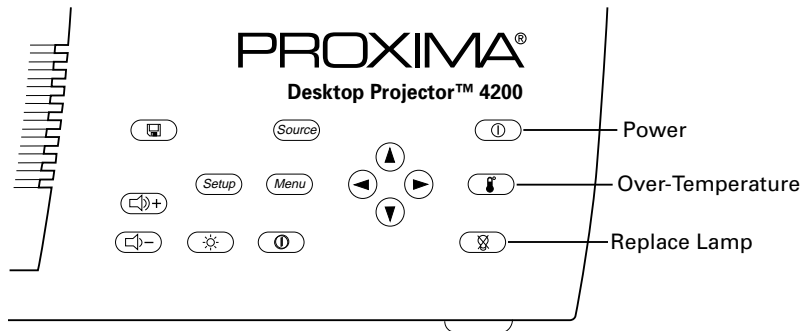

Figure 3-5 DP4100/4200's Control Panel indicators

INDICATOR	FUNCTION
	Glows green if AC input and projector power supplies are okay. Glows red if not.
	Glows red to warn of an over-temperature condition.
	Glows red if the projection lamp burns out.

### Power

The power indicator glows green after you turn on the AC power switch and the projector completes a self check.

### Over Temperature

The indicator illuminates if the projector overheats.

An over-temperature condition automatically turns off the power to the lamp until the projector cools.

If an over-temperature condition occurs, perform the following checks while you allow the projector to cool:

- Verify that the room temperature is below 104° F (40° C) when projecting in color or 95° F (35° C) when projecting in Workgroup (monochrome) mode.
- Check the intake and exhaust vents. Clear any obstruction to the air flow.

- Make sure that the fans are working. If the projector has reached an over-temperature condition and the fans are working, you should feel a strong flow of hot air from the top vent and a strong rush of air directly into the front and rear of the projector. If either fan is not working, the projector needs service.

After the projector returns to its normal operating temperature, you must turn the main power switch off and back on to clear the over temperature indicator. Press the  key on the control panel to relight the lamp.

**NOTE:** *The Cyclops remote control's  key will not function after an over temperature condition until the main power switch is turned off and on and the lamp is turned on from the control panel.*

## Replace Lamp

The  indicator will illuminate if the projection lamp burns out. If the lamp has burned out, you cannot continue your presentation until you replace the lamp assembly.

**⚠ CAUTION!** *If the lamp fails during a presentation, make sure that the projector cools for at least five minutes with the projector off before attempting to change the lamp. See page 5-1 to change lamps. The lamp assembly gets very hot. Use appropriate care when changing it.*

## USING THE CYCLOPS REMOTE CONTROLS

The Cyclops remote control contains all the key functions available on the DP4100/4200 control panel as well as several additional features. The Cyclops Quick Remote allows you to control several of the projector's most popular features.

For best results, aim the remote control at the projection screen or at the projector's front panel. Do not obstruct the red infrared eye located on the front of the projector.





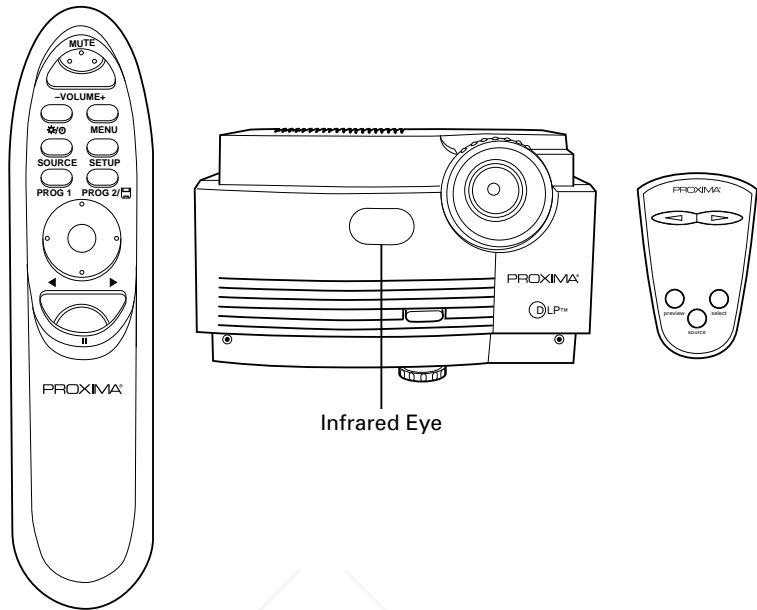

**Discount-Merchant.com (800) 281-8860**  
**THE TRUSTED SOURCE FOR PROJECTOR LAMPS AND ACCESSORIES**



**Figure 3-6** Remote Controls and Infrared Eye

## Cyclops Remote Control

KEY	FUNCTION
<b>MUTE</b>	Turns audio on or off.
<b>- VOLUME +</b>	Decreases or increases the volume of internal and/or external speakers.
<b>* / 0</b>	Hides or shows the image. Press and hold the button for two seconds to power down the projector. The projector will beep twice when the command is acknowledged.
<b>MENU</b>	Displays or hides the menu.
<b>SOURCE</b>	Switches between connected sources.
<b>SETUP</b>	Displays the Setup menu (see page 3-6).
<b>PROG1</b>	Programmable key (see page 3-27).
<b>PROG2/ </b>	This is a programmable key. If the MediaExpress system is installed and selected as the source, this becomes the MediaExpress key.

KEY	FUNCTION
	Pressing the center of the large round button sends a mouse click signal. Press the edges up, down, left or right to move the cursor around the screen. To drag an object, position the cursor over it, then press the center button for one second. Move the cursor to the new location, and press the center button again to release it.
	Pressing the right side of the button moves a MediaExpress presentation forward one slide.
	Pressing the left side of the button moves a MediaExpress presentation back one slide.
	Pressing the bottom of the button pauses a presentation. Press the bottom of the button again to restart the presentation.

## Cyclops Quick Remote

The Cyclops Quick Remote allows you to control the most often used projector functions.

**NOTE:** Several of the remote control functions require the installation of Proxima's Cyclops F/X software (see Chapter 4).

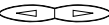
KEY	FUNCTION
	Moves a presentation (PowerPoint, Freehand, etc.) forward or back one frame. This function can only be used if Cyclops F/X is installed.
<b>Preview</b>	Allows you to preview an image from a presentation (PowerPoint, Persuasion, etc.) if Cyclops F/X and a separate monitor are installed. Refer to the See It/Show It feature in Chapter 4 for more information.
<b>Select</b>	Selects a pre-programmed projector feature that you can choose from the Preferences menu (see page 3-27).
<b>Source</b>	Switches between connected sources.



FixYourDLP.com

Sponsored by

## OPERATING THE PROJECTOR

The DP4100/4200 is simple to control using the control panel, Cyclops remotes or pointer, or your computer mouse.

Discount-Merchant.com (800) 281-8860  
THE TRUSTED SOURCE FOR PROJECTOR LAMPS AND ACCESSORIES

## Using the Control Panel and Cyclops Remote Controls

The control panel and Cyclops remote controls provide access to all of the projector's features. Simply press a key to select a function or to navigate through the menus. The remote controls can also be used to control the Cyclops F/X software (see Chapter 4).

## Using a Microsoft-Compatible Mouse

You can use a Microsoft-compatible mouse to control the menus and the LightBoard® tool in Local Mode. In Host Mode, use it as a system mouse. The mouse must be connected to the AUX port on the projector before powering up the projector (see page 2-13).

## Operating Modes

The DP4100/4200 can operate in Local or Host Mode.

### **Local Mode**

Any time you activate the projector's menus or the LightBoard tool, the projector is in Local Mode. In Local Mode, the mouse or Cyclops remotes can be used for projector menu and LightBoard functions only; they do not communicate with the computer.

In Local Mode, the projector mouse, Cyclops remotes or Cyclops pointer can be used to:

- Move through the projector menus.
- Select items in the projector menus.
- Control the LightBoard cursor.

### **Host Mode**

If a data cable is connected between the projector and the computer, the projector can operate in Host Mode. In Host Mode, a mouse connected to the projector functions as the system mouse. It communicates with the computer or the MediaExpress system and controls the screen cursor for all computer and MediaExpress functions. Host Mode can only be used when the projector's menu and the LightBoard tool are not active.

Please refer to the *Cyclops User's Guide* for more information on using a mouse with Cyclops.



Discount-Merchant.com (800) 281-8860  
THE TRUSTED SOURCE FOR PROJECTOR LAMPS AND ACCESSORIES

## THE GRAPHICAL USER INTERFACE

Your DP4100/4200 features a graphical user interface that makes it easy to control all of the projector's functions. Menu selections can be made with the control panel, Cyclops remotes or pointer, or your computer mouse.

**NOTE:** *Menus will change based on the type of video source you have connected.*

### Using the Menus with the Control Panel or Cyclops Remote

- 1 Press the MENU key to display the on-screen menus.
- 2 Press the ▲ and ▼ arrow keys to select the desired menu item. An item is highlighted when it is selected.
- 3 Use the ◀ and ▶ arrow keys to move across the menus.
- 4 Use the ▲ and ▼ arrow keys to move down a menu column or to change a menu value.
- 5 Press the MENU key again to close the menu or wait five seconds and they will automatically disappear. Settings are automatically saved when you exit the menus.

### Menu Selection Using a Mouse

If a Microsoft-compatible mouse is connected to the projector's AUX port, menu selections are even easier. When the menus are open, simply point to the desired item and click to select or change it.

### Using the Menus with the Cyclops Interactive Pointer System

For the ultimate in ease-of-use, you can use the optional Cyclops interactive pointer system to control the menus and the LightBoard tool in Local Mode, and the attached computer in Host Mode.

**NOTE:** *You must first calibrate the Cyclops interactive pointer system.*

- To open or close the menus, simply point the Cyclops wand or laser pointer just to the left or right of the projected image and hold the button down until the menus appear or disappear. As with a Microsoft-compatible mouse, you can control the menus with a point and click.



FixYourDLP.com  
Sponsored by

DiscountMerchant.com 800-247-8860  
THE TRUSTED SOURCE FOR PROJECTOR LAMPS AND ACCESSORIES



- To open or close the LightBoard tool, simply point the Cyclops wand or laser pointer just above the projected image and hold the button down until the LightBoard tool bar appears or disappears.

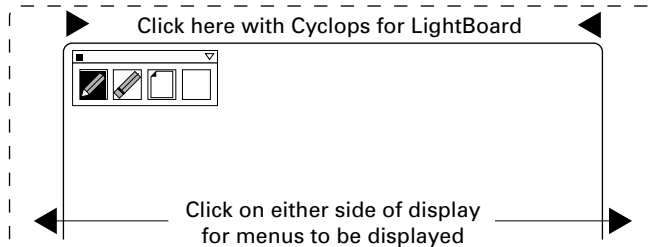

**Figure 3-7** Using Cyclops to activate the menus and LightBoard

## USING THE MAIN MENU

When the MENU key is pressed or when the Cyclops pointer or a mouse are used to open the menus, the Main menu appears at the top of the screen.



**Figure 3-8** Main menu

To turn the menu off, press the MENU key again or click on the Menu title bar with the Cyclops pointer or the mouse.

The menu displays only those items that are relevant to the selected input source (computer, video, or S-Video). The following table lists the main menu options that you can select:

<b>MENU</b>	<b>ACTIONS</b>
<b>Tools</b>	Selects a projector tool for use.
<b>Input Source</b>	Selects a video source and adjusts the settings of an incoming signal.
<b>Image</b>	Adjusts the display settings, selects the option for rear or ceiling projection.
<b>Audio</b>	Controls the audio (volume, balance, etc.).
<b>Preferences</b>	Programs a custom key on the Cyclops remote control or changes the language of the menu display.
<b>Advanced</b>	Provides advanced projector functions.

## SELECTING A TOOL

The Tools menu is used to set up and activate:

- The LightBoard tool
- The Cyclops interactive pointer
- The Timer

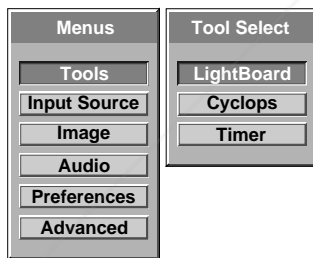

**Figure 3-9** Tool Select menu

## Using the LightBoard Tool

The LightBoard tool allows you to highlight text or other objects on the screen and draw on a white or black background with the Cyclops remote control or pointer, or a mouse.



FixYourDLP.com

Sponsored by 

**Discount-Merchant.com (800) 281-8860**  
**THE TRUSTED SOURCE FOR PROJECTOR LAMPS AND ACCESSORIES**

- 1 From the Tool Select menu, select the LightBoard tool.

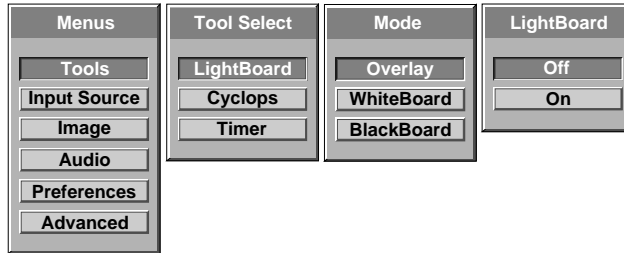
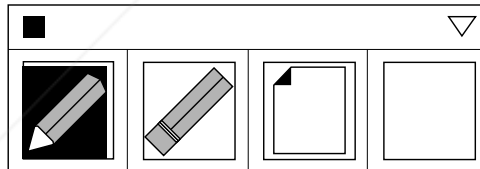

**Figure 3-10** LightBoard Tool menu Using the LightBoard

- 2 Select a LightBoard mode.

<b>Overlay</b>	Uses the Draw tool to highlight or annotate the displayed image.
<b>WhiteBoard</b>	Clears the screen and provides a white background for the Draw tool.
<b>BlackBoard</b>	Clears the screen and provides a dark background for the Draw tool.

- 3 Select ON on the LightBoard menu. The Draw toolbar appears in the upper left of the display.



**Figure 3-11** Toolbox

- 4 The currently selected tool (Draw or Erase) is highlighted and a cursor appears. Use the Cyclops wand, optional laser pointer, remote control, or a Microsoft-compatible mouse to draw on the screen.

## **Draw Tool Bar**

The Draw tool bar has four options:



Click to select the Drawing tool.



Click to select the Eraser. You can erase portions of your highlights.



Click to erase all previous highlighting.



Click to select a new color. This button also shows the currently selected color.

## **Choosing a Color**

- 1 Click the top color box or the down arrow in the upper right corner of the Draw tool bar to display the color palette.

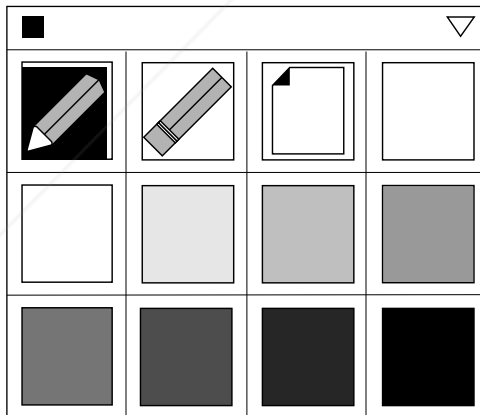

**Figure 3-12** Toolbox Color palette

- 2 Click the color you want to use. The Color box takes on the selected color, and the color palette remains on the screen.
- 3 Click the Color box or the down arrow in the upper right corner again to turn the color selection boxes off.



FixYourDLP.com

Sponsored by 

**Discount-Merchant.com (800) 281-8060**  
**THE TRUSTED SOURCE FOR PROJECTOR LAMPS AND ACCESSORIES**

- 4 To draw, click and hold down the Cyclops wand or laser pointer button, mouse button, or remote control mouse disc at the desired starting point. Draw with the cursor and release the mouse or wand button to end a draw motion.
- 5 To exit Draw, click the small box in the upper left corner of the Draw tool bar.

The Draw tool bar can be moved to another location on the screen. With the mouse, Cyclops wand, or remote control, click and hold on the top of the tool bar. Drag the bar to the new location and release the mouse or wand button.

### Using the Cyclops Menu

The Cyclops menu allows you to calibrate and adjust the Cyclops interactive pointer system. For more information, refer to the *Cyclops User's Guide*.

**NOTE:** The Cyclops menu will only be active if the Cyclops camera is installed.

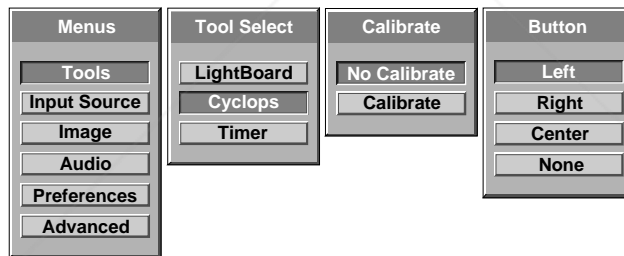
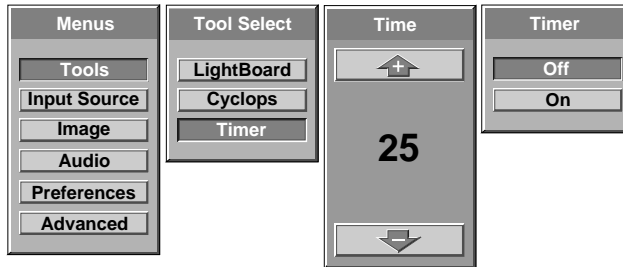

Figure 3-13 Cyclops Tool menu

MENUS	SETTING
<b>Calibrate</b>	Calibrates the Cyclops system for image size and ambient lighting conditions. Follow the on-screen instructions displayed when Calibrate is selected or refer to the <i>Cyclops User's Guide</i> .
<b>Button</b>	Select a mouse button action (Left, Right, Center or None) to send to the computer when the wand is clicked.

## Setting the Timer

Use this tool to start and reset the on-screen digital timer. Set the Timer to count down for breaks, class activities, and other presentation requirements.



**Figure 3-14** Timer Tool menu

- 1 From Tool Select, choose Timer and press the right arrow key.
- 2 When the Timer menu appears, use the ▲ and ▼ keys on the control panel, the mouse disc on the remote control, or a mouse to set the time.
- 3 From Timer (on the top menu bar), select On and the clock will begin to count down.

When the timer reaches zero, a series of beeps will be heard.

## INPUT SOURCE MENU

This menu provides a two-step method of selecting the video source.

- When a video input is connected, the Source Mode box indicates which video source has been detected by the projector.
- The Source Select box then allows the selection of other video input sources.

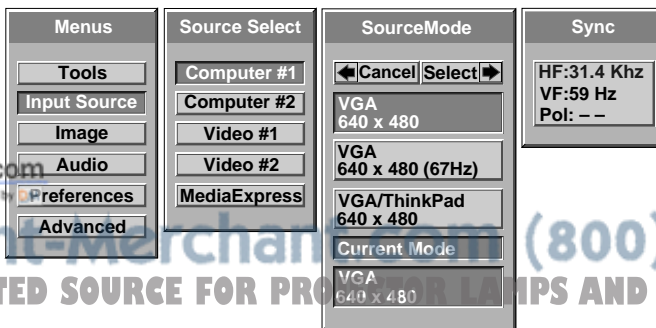

**Figure 3-15** Input Source menu

MENUS	SETTING
<b>Source Select</b>	Selects the desired video and audio source.
<b>Source Mode</b>	Changes to an input source that matches or is close to the current source.
<b>Sync Status</b>	Displays the Horizontal and Vertical frequency and polarity of the currently selected video source.

## Changing the Input Video Source

To change the input video source, use the right arrow key to move to the Source Select box and use the ▲ and ▼ keys to select Computer #1, Computer #2, Video #1, or Video #2.

**NOTE:** There will be a 2.5 second delay before the source changes.

## Changing the Source Mode

The Source Mode box lists all of the input source settings that match or are close to the type of source the projector sensed.

- 1 To change the Source Mode setting, use the arrow keys to move to the Source Mode box and use the ▲ and ▼ keys, mouse, or Cyclops pointer to select a different input source.
- 2 Use the arrow keys to Cancel (◀) or Select (▶) the new source entry.  
The input measurements of the current settings are displayed on the Sync menu.

## IMAGE MENU

This menu is used to adjust the projected video image and select how the projector will display.

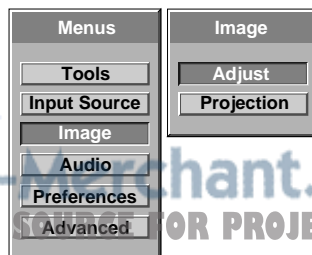
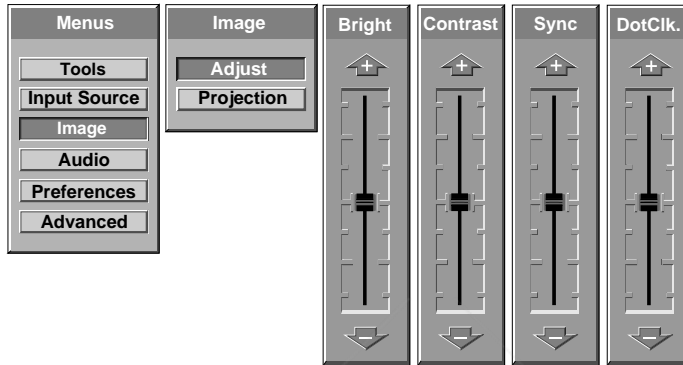

**Figure 3-16** Image menu

## Adjust Submenu

The Adjust Submenu displays a series of video adjustment slide bars with the current settings. Use the ▲ and ▼ keys to move the bars up or down to adjust the individual settings for the best picture. The menus vary according to the currently selected input source.

### Computer Source



### Video Source

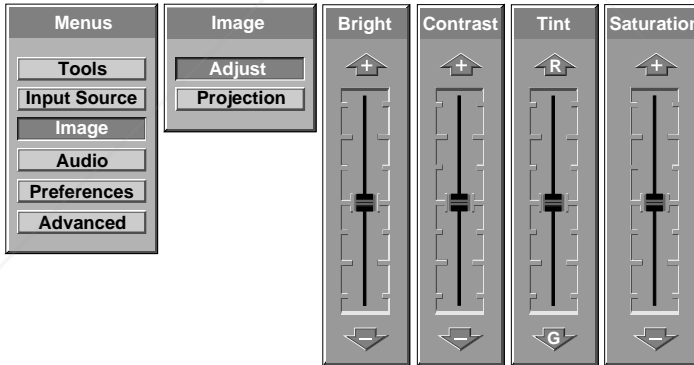

Figure 3-17 Image menu, Adjust submenu



The following table lists all of the available settings for the Image Adjust Submenu. Use the ▲ and ▼ keys to change them.

<b>ADJUSTMENT</b>	<b>FUNCTION</b>	<b>SOURCE</b>
<b>Bright</b>	Makes the screen image brighter or darker.	Computer, Video, MediaExpress
<b>Contrast</b>	Increases or decreases the contrast level of the image.	Computer, Video, MediaExpress
<b>Sync</b>	Helps reduce uneven horizontal features, such as lines of text, streaks or shimmering in the image.	Computer
<b>Dot Clk</b>	Adjusts the Dot Clock if vertical black lines appear on the screen. Do not adjust the Dot Clock until you have tried to fine tune the picture with the Sync setting.	Computer
<b>Tint</b>	Makes the screen image more red (up) or green (down).	Video
<b>Saturation</b>	Increases or decreases the saturation of the image colors.	Video
<b>Normal Video (DP4100 only)</b>	Allows panning around the image if it is wider than the screen. See page 3-6 for more information about horizontal and vertical position. This option is not available on SVGA models.	PAL/SECAM Video only
<b>Fit-to-View™ (DP4100 only)</b>	Compresses the image to fit on the display. This option is not available on SVGA models.	PAL/SECAM video only



**Discount-Merchant.com (800) 281-8860**  
**THE TRUSTED SOURCE FOR PROJECTOR LAMPS AND ACCESSORIES**

## Projection Submenu

Use this submenu to control the image position and display polarity.

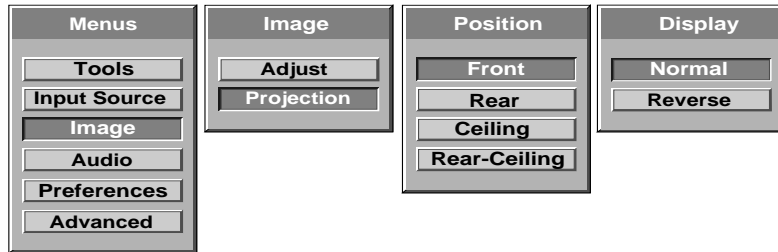

Figure 3-18 Image menu: Projection submenu

MENU	FUNCTION
<b>Position</b>	Flips the image for rear and ceiling projection.
<b>Display</b>	Switches between normal and reverse video modes. Reverse video inverts the colors your monitor and projector normally display.

## AUDIO MENU

This menu is used to select an audio source and adjust the audio output.

### Normal Adjustments Submenu

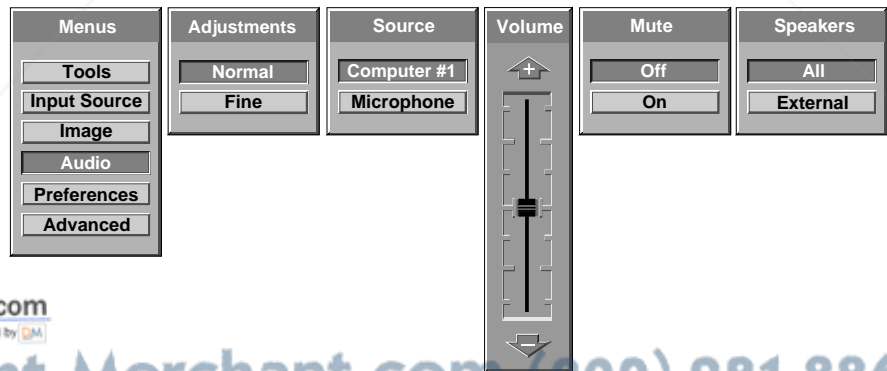

Figure 3-19 Normal Audio submenu

MENU ITEM	SETTING
<b>Source</b>	Selects either Computer/Video or Microphone as the audio source.
<b>Volume</b>	Raises or lowers the speaker volume for the selected source.
<b>Mute</b>	Mutes the speaker sound.
<b>Speakers</b>	Selects internal and external (All), or external speakers only.

### Fine Adjustments Submenu

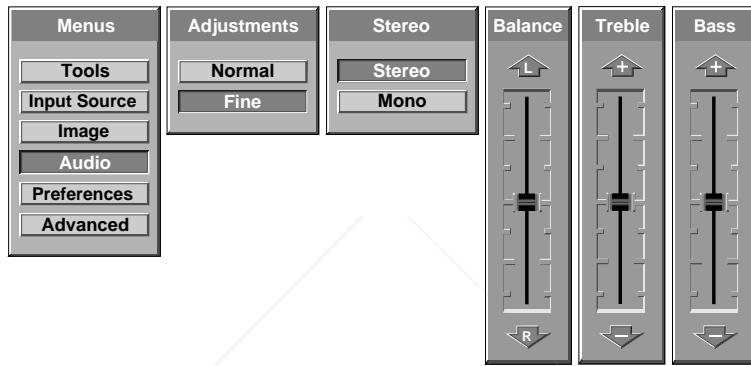

Figure 3-20 Fine Adjustments submenu

MENU ITEM	SETTING
<b>Stereo</b>	Selects stereo when playing a stereo source from both left and right audio inputs. Select Mono when using a monaural source for simulated stereo output.
<b>Balance</b>	Adjusts the balance between the left and right speakers.
<b>Treble</b>	Adjusts the speaker treble tone.
<b>Bass</b>	Adjusts the speaker bass tone.

## USING THE AUDIO MENUS

You can incorporate audio into your presentation in a variety of ways. If you will be using a video source (e.g. Computer), but want to use another audio source, connect the alternate audio source to the COMPUTER AUDIO IN port(s).

### Selecting Stereo Audio

- 1 Open the Audio menu.
- 2 Choose the source (e.g. Video) if microphone is selected.
- 3 Open the Audio Adjustment menu, and select Fine.
- 4 Select the Stereo menu and choose Stereo.
- 5 Adjust balance, treble and bass, if necessary.
- 6 Press the Menu key to exit and save your changes.

### Muting Audio

- 1 Choose the source (e.g. Computer) you will be using without any audio.
- 2 Return to the Audio menu and select Source.
- 3 Select Adjustments, then select Normal.
- 4 Select Mute, then select ON.
- 5 Press the Menu key to exit and save your changes.

### Simulating Stereo While Using a Monaural Source

- 1 Connect the monaural source to the left AUDIO or COMPUTER AUDIO port.
- 2 Open the Audio menu and select Source.
- 3 Choose the source (e.g. Video).
- 4 Select Adjustments, and then select Fine.
- 5 Select the Stereo menu, and then select Mono.
- 6 Press the Menu key to exit and save your changes.

When you close the menus, the settings will be saved. In the above example, the projector will activate simulated stereo audio when you select your Video source.



FixYourDLP.com

Sponsored by

Discount-Merchant.com (800) 281-8860

THE TRUSTED SOURCE FOR PROJECTOR LAMPS AND ACCESSORIES

## PREFERENCES MENU

This menu is used to tailor the DP4100/4200 to your personal presentation style.

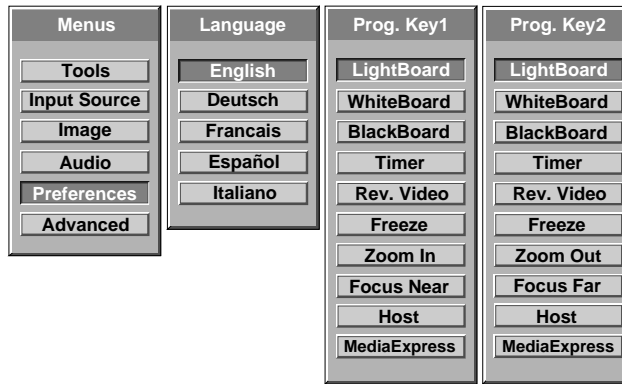

Figure 3-21 Preferences menu

MENU ITEM	SETTING
-----------	---------

<b>Language</b>	Displays menus in any of five languages.
-----------------	--

<b>Prog Key 1 and 2</b>	Assigns a specific projector function to one of the PROG keys on the Remote Control as a short cut:
-------------------------	---

LightBoard - Draws on a clear background

WhiteBoard - Draw on a white background

BlackBoard- Draw on a black background

Timer - Starts or resets the Timer

Rev. Video - Switches between normal and reverse video

Freeze- Freezes the image on the screen

Zoom In - Controls zoom lens

Zoom Out - Controls zoom lens

Focus Near - Controls zoom lens

Focus Far - Controls zoom lens

Host - Enables a special effect selected in Cyclops F/X

MediaExpress - selects MediaExpress as the input source



Discount-Merch.com (800) 281-8800  
THE TRUSTED SOURCE FOR PROJECTOR LAMPS AND ACCESSORIES

To set the Prog 1 or 2 keys, use the arrow keys to select the function that you want to assign to each key.

## ADVANCED MENU

Use the Advanced menu to adjust the projector settings to suit a particular presenter's style and taste. You may customize and save video mode adjustments and image settings for up to three users.

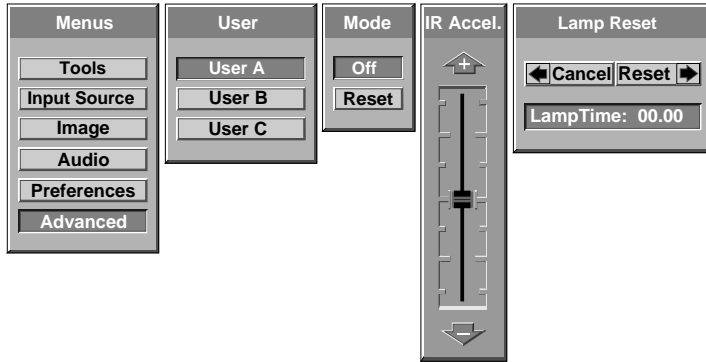

Figure 3-22 Advanced menu

MENU ITEM	SETTING
<b>User</b>	Selects one of three user sets of stored settings.
<b>Mode</b>	Selects Reset to return the Dot Clock and customized settings for the current image source to the factory defaults.
<b>IR Accel.</b>	Sets the speed of the mouse when using the mouse disc on the remote control.
<b>Lamp Reset</b>	Indicates the amount of time (hours) on the lamp. Reset this to zero when you replace the lamp.

### Saving Custom Settings

A set of customized values for every video mode can be stored for User A, User B, and User C.

- 1 From the User menu, select User A, User B, or User C.
- 2 Make any desired projector adjustments. These changes only affect the currently selected display mode (video or computer).
- 3 Close the menus to save your changes.



FixYourDLP.com

Sponsored by

Discount-Merchant.com (800) 281-8860  
THE TRUSTED SOURCE FOR PROJECTOR LAMPS AND ACCESSORIES

## Recalling Custom User Settings

- 1 The adjustments are recalled simply by selecting the desired User.
- 2 From the Advanced main menu access User, select User A, User B, or User C.
- 3 The projector recognizes the video input and recalls the custom settings.



**Discount-Merchant.com (800) 281-8860**  
**THE TRUSTED SOURCE FOR PROJECTOR LAMPS AND ACCESSORIES**



**Discount-Merchant.com (800) 281-8860**  
**THE TRUSTED SOURCE FOR PROJECTOR LAMPS AND ACCESSORIES**



## Chapter 4

# Cyclops F/X

Your projector comes with Cyclops F/X—software effects that you can use to make your presentations more interesting and effective. For example, you can use the Spotlight to call attention to specific areas on the image, use the Zoom or Magnify effects to focus on important information in the image, or use See-it/Show-it to preview images on your computer without distracting your audience.

You can use Cyclops F/X with either the remote that came with your projector or the optional Cyclops interactive pointer system, or both at the same time.

**Note:** *Cyclops F/X is not available for UNIX systems.*

**Note:** *You cannot use Cyclops F/X with the MediaExpress system.*

To use Cyclops F/X, follow these steps (details are covered throughout this chapter):

- 1 Use the serial cable appropriate for your system (PCs: C936-6 or Macs: C470-6) to connect the serial port on your computer to the CYCLOPS port on the projector.

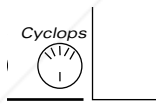

**Figure 4-1** Cyclops port on the projector

- 2 Install the Cyclops F/X software.
- 3 Start Cyclops F/X, customize the effects, and assign them to specific keys on the keyboard or buttons on the remote control.
- 4 Minimize the Cyclops F/X main screen.



Then, just press the assigned key or button during your presentation to start an effect.

This chapter is designed to give you a brief introduction to the Cyclops F/X software.

**Note:** *Updates to the Cyclops F/X software are available for download from the World Wide Web at <http://www.prxm.com>.*

## INSTALLING CYCLOPS F/X

Follow these steps to install the Cyclops F/X software:

- 1 Insert the disk labeled Proxima Cyclops F/X into your computer's floppy drive.
- 2 Do one of the following:
  - In Windows 95, choose **Start, Run**, then type a:\setup.exe (or the drive letter for your floppy drive).
  - In Windows 3.x, choose **File, Run**, then type a:\setup.exe (or the drive letter for your floppy drive).
  - On a Macintosh, double-click the disk icon, then double-click the **Cyclops F/X Installer** icon in the disk window. Drag the Cyclops F/X icon onto the hard disk icon.
- 3 Follow the instructions that appear on your screen.

## STARTING CYCLOPS F/X

Once you're finished with the installation, do one of the following:

- In Windows 3.x or Windows 95, double-click the **Cyclops F/X** icon to start the program.
- For Macintosh users, the software will automatically load each time you start your computer.

### Windows users

The first time you start the software, Cyclops F/X displays a Projector Setup Tutorial (Wizard). Follow the instructions that appear on your screen. When you have finished configuring your system, restart Windows.



**Discount-Merchant.com (800) 281-8860**  
**THE TRUSTED SOURCE FOR PROJECTOR LAMPS AND ACCESSORIES**

The main screen of the F/X program appears:

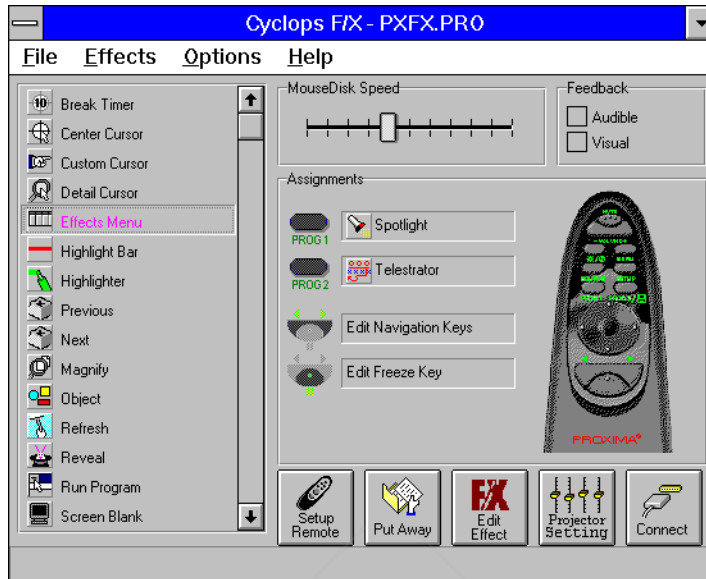

**Figure 4-2** Cyclops F/X special effects

On the left side of this window is a list of the special effects. The Assignments area in the middle of the window provides options that allow you to customize your remote and software.

**Note:** If you open a menu, or if you're using the LightBoard tool, Cyclops F/X will be suspended.

## ASSIGNMENTS AREA

The Assignments area displays the custom remote keys and their current assignments. To modify the custom remote keys:

- 1 Highlight the effect you want to assign.
- 2 Double-click the box next to the custom remote key in the Assignments area.



**Discount-Merchant.com (800) 281-8860**  
**THE TRUSTED SOURCE FOR PROJECTOR LAMPS AND ACCESSORIES**

The Assignments area also contains five buttons:

<b>BUTTON</b>	<b>FUNCTION</b>
<b>Setup Remote</b>	Lets you switch the assignments display between the included Cyclops remote control and the optional Cyclops wand or laser pointer.
<b>Put Away</b>	Minimizes the F/X screen.
<b>Edit Effect</b>	Allows you to assign a shortcut key to the effect. You can also use this option to customize an effect.
<b>Projector Setting</b>	Allows you to adjust image, audio, and general settings on your projector.
<b>Connect</b>	Allows you to choose the COM port to which you will connect your projector.

In addition, the Assignments area allows you to control the MouseDisk speed on your remote, and gives you checkboxes to turn on audible and visual feedback.

## **CUSTOMIZING EFFECTS**

Most effects have options that you can tailor to both the presentation and your own presentation style.

For example, you can customize the Spotlight effect to specify the shape and size of the spotlight. You can also change the name of each effect (for example, you can change the name from “Spotlight” to “Headlight”).

You can assign each effect to a key on the keyboard or a button on the remote control. The key or button you choose starts that effect.

To customize an effect:

- 1 Right-click the name of the effect and choose **Edit** from the menu. You can also select the desired effect and click the Edit Effect button to make your changes.
- 2 Adjust the settings in the appropriate dialog box and click **OK**.
- 3 When you're finished customizing the effect, choose **File** and **Save** to save your settings.
- 4 Click the control box in the upper right corner to minimize the Cyclops F/X main screen.



FixYourDLP.com

Sponsored by

DiscountMerchant.com (800) 201-8860

THE TRUSTED SOURCE FOR PROJECTOR LAMPS AND ACCESSORIES

**Note:** To access effects that are assigned to the Prog 1 and Prog 2 keys, assign the settings for those keys (in the projector's Preferences menu) to Host.

## USING THE CYCLOPS INTERACTIVE POINTER SYSTEM

You can use the Cyclops interactive pointer system with Cyclops F/X. To set up the software, click Setup Wand/Laser in the Assignments area of the main screen. The following screen appears:

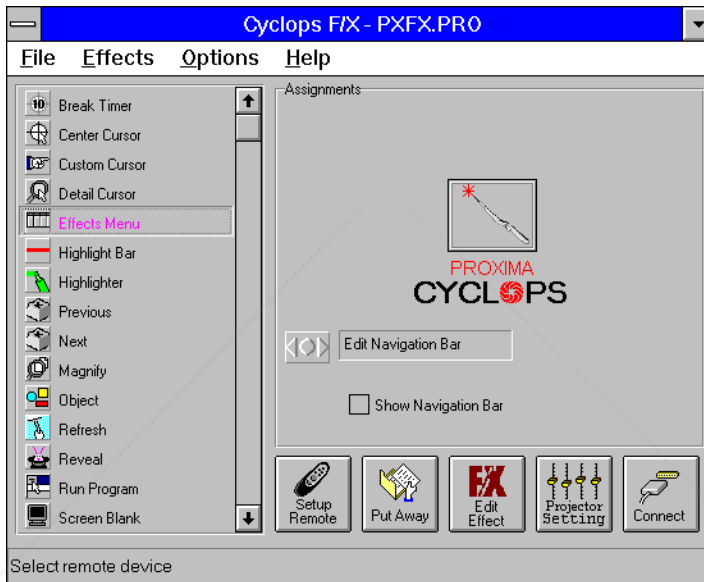

**Figure 4-3** Cyclops interactive pointer screen

Click the Show Navigation Bar checkbox to enable the navigation bar. This will provide you with a quick way to scroll through your slide show with the Cyclops wand or laser pointer.

Click on the Edit Navigation Bar button. The following screen appears:



**Discount-Merchant.com (800) 281-8860**  
**THE TRUSTED SOURCE FOR PROJECTOR LAMPS AND ACCESSORIES**

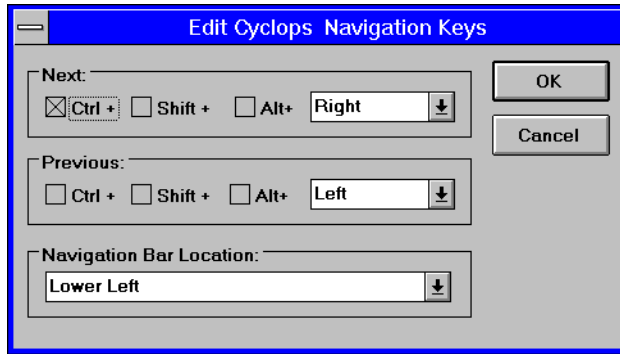

**Figure 4-4** Edit Cyclops Navigation screen

Use this screen to assign different options to the navigation bar. To assign a new function to the navigation bar, click the Next or Previous areas and assign a function using the list boxes to the right.

You can also use this screen to define where the navigation bar will appear on your display. The default is Lower Left.

## SEE-IT/SHOW-IT

See-it/Show-it is a feature of Cyclops F/X that previews the next slide in your presentation on your computer monitor—without switching from the slide your audience sees. The See-it/Show-it feature displays the image, along with a timer that counts down on your computer monitor until See-it/Show-it displays the next slide. You can use See-it/Show-it to preview slides so that you can interact with your audience, while preparing for the message on the next slide.

To use See-it/Show-it:

- 1 Click **Edit Navigation Keys** in the Assignments area of the Cyclops F/X main screen. The following screen appears:

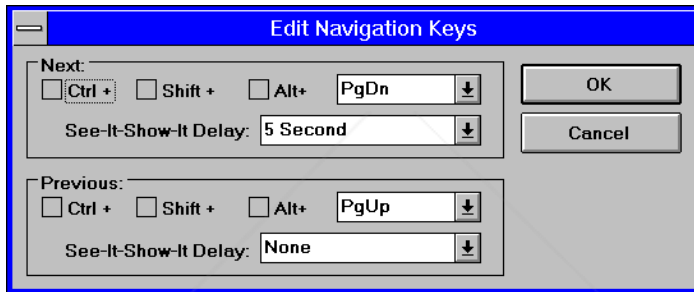

**Figure 4-5** Edit Navigation Keys screen

- 2 Select a countdown time for the Forward or Reverse keys, or both. When you select a countdown time, See-it/Show-it is automatically enabled.
- 3 To disable See-it/Show-it, select **None** from the Forward and Reverse key list boxes.

To switch to See-it/Show-it, press the Forward or Reverse key once quickly. To end See-it/Show-it, press the Forward or Reverse key a second time. The counter disappears and the next slide immediately displays.

## FREEZE

The Freeze option freezes the image on your projector so you can use your remote to control your computer. This might be handy when you want to perform functions on your computer without distracting your audience from your presentation. To edit the Freeze key settings, click the Edit Freeze Key option in the Assignments area. The following screen appears:

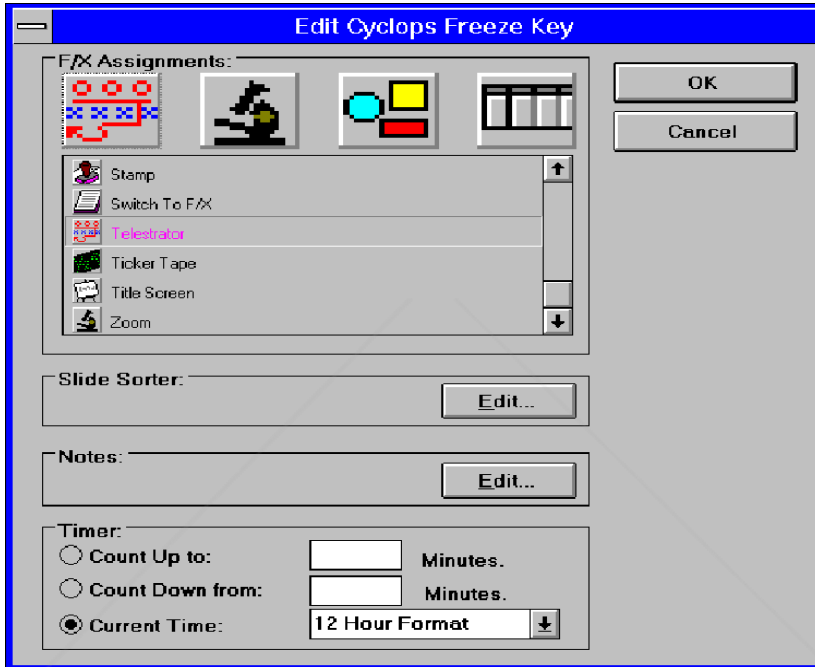

**Figure 4-6** Edit Freeze Key screen

To use Freeze:

- 1 Press **Pause** on your Cyclops remote.
- 2 Use any of the remote keys to control your computer.
- 3 Press **Pause** again when you're ready to return to your presentation.

Once you freeze your screen, all of the other keys on your remote are available to control your computer. This means you can edit your current presentation, display slides from another presentation, or even open another application — all without distracting your audience.

**Note:** If you adjust the projector settings from your computer while you're in Freeze mode, your changes will not display until you exit .



## STARTING AN EFFECT

Once you've customized an effect, you're ready to use it.

- 1 Before the presentation, start Cyclops F/X, then minimize the main screen.
- 2 During your presentation, press the key or button that you assigned to each effect to start the desired effect.

## THE PRESENTATION EFFECTS

The following are the Presentation Effects. To end any of the effects, press the Esc key on your keyboard or the key on remote that you assigned for that effect.

**Break Timer** is a digital timer that counts down from a duration you set. Once you start the timer, click the MouseDisk once to lengthen the duration.

You can also use Break Timer to play a sound or select a background color or picture. If your computer is equipped with a sound card, you can select a .WAV file and play it continuously while the timer is running, or use it as an alarm that sounds when the timer expires.

To set a transparent background, uncheck **Color** and **Picture**. To display a picture, check **Picture**, click **File**, then select the desired .BMP file.

**Center Cursor** centers the mouse pointer on the screen. This helps prevent "losing" the cursor.

**Custom Cursor** changes the appearance of the mouse pointer to one of 30 images. Only the standard arrow pointer changes. The other standard icons (such as the hourglass) are not affected.

**Detail Cursor** magnifies the area around the pointer in a small rectangle.

**Effects Menu** displays a list of effects. Use this feature to start effects that you haven't assigned to a button or key. To start an effect, double-click its name. Press Esc on the keyboard to close the list without starting an effect.

**Highlight Bar** draws a horizontal bar across the screen. Move the bar up or down to draw attention to different areas on the screen. You can also change the color and width of the bar.

**Highlighter** works like a highlighter pen on your computer screen, by overlaying a semitransparent color on your screen. You can change the color and width of the "pen."

**Magnify** enlarges a rectangular area around the mouse pointer. You can choose from three levels of magnification (200 percent, 400 percent, or 800 percent).

**Note:** *To enlarge the entire screen, use the Zoom effect.*

**Next/Previous** advances to the next or previous slide.

**Object** allows you to draw rectangles, squares, ellipses, and circles. You can change the color and width of each shape.

**Refresh** repaints the projected image. Use this feature to erase “remnants” of Stamp and Telestrator effects.

**Reveal** hides the image, then lets you incrementally reveal more and more of the image. You can specify a color for the hidden area, a horizontal or vertical effect, and the size of the Reveal window.

**Run Program** starts a program that you choose.

**Screen Blank** blanks the screen to a color that you choose.

**Sound** plays a .WAV file when you press a button. You can play the sound repeatedly or just once.

**Note:** *You must have a sound card to use this effect.*

**Spotlight** dims all of the image except for the area around the mouse pointer. You specify the shape and size of the spotlight (circular, square, or bar). Once you’ve started Spotlight, press the MouseDisk to change its size. Another setting makes the Spotlight visible against a black background.

**Stamp** allows you to choose from 15 different bitmaps to “stamp,” or paste, over the projected image. You can also choose to play a sound each time you stamp.

**Switch to F/X** switches to the Cyclops F/X main screen.

**Telestrator** turns the mouse into a freehand drawing tool. You can customize the color and width of the line and “constrain” the drawing to only horizontal or vertical lines.

**Ticker Tape** displays a scrolling text message across the image. Just specify the text of that you want to appear, the typeface, and the point size. You can play a sound file each time the message runs across the image, and customize the background color and picture.



FixYourDLP.com

Sponsored by DJI

Discount-Merchants.com (800) 281-8860

THE TRUSTED SOURCE FOR PROJECTOR LAMPS AND ACCESSORIES

**Title Screen** projects an image from a .BMP file. You can use this effect to show a predefined image with transition effects during a presentation. You can also play an associated sound. Just specify which file to play and indicate whether to play it when the image appears or continuously.

**Zoom** enlarges the entire image to 200, 400, or 800 percent of its original size. You choose whether to show the mouse pointer during a Zoom and indicate the level of magnification. If you check the Show Cursor During Zoom checkbox, left-click to manually cancel the zoom. If you uncheck the Show Cursor During Zoom checkbox, left-click to change the zoom factor.

**Note:** Most effects have an option that lets you rename the command itself.

## MENU COMMANDS

### File menu

The File menu offers the following commands for working with profiles of effects.

MENU ITEM	FUNCTION
<b>Reset to defaults</b>	Resets the F/X options to the factory defaults.
<b>Open</b>	Opens a previously saved profile of settings.
<b>Save</b>	Saves recent changes to the current profile.
<b>Save As</b>	Saves the profile settings under a name and location you specify.
<b>Exit</b>	Quits the F/X program.

### Effects menu

The Effects menu lets you change the items in the effects list.

MENU ITEM	FUNCTION
<b>Edit</b>	Allows you to edit F/X options.
<b>Test</b>	Tests the current effect.
<b>Add</b>	Allows you to add an effect.
<b>Duplicate</b>	Allows you to copy an effect.
<b>Delete</b>	Allows you to delete an effect.

## Options menu

The Options menu offers commands that allow you to set up assignments on the remote, wand, or laser pointer, change the look and feel of the cursor, and change the COM port settings.

MENU ITEM	FUNCTION
<b>Setup Remote</b>	Allows you to display the assignments area for the Cyclops remote control or the optional Cyclops wand or laser pointer.
<b>Cursor Options</b>	Changes the look and feel of the cursor. Also includes an option that allows you to apply one of the Cyclops F/X custom cursor options to Windows.
<b>Connect</b>	Allows you to edit the COM port settings for your computer.



**Discount-Merchant.com (800) 281-8860**  
**THE TRUSTED SOURCE FOR PROJECTOR LAMPS AND ACCESSORIES**

### REPLACING THE LAMP

Follow these steps to remove the lamp and install a new one:

- 1 Press the  key to turn the lamp off. This allows the fans to cool the lamp assembly for 30 seconds.
- 2 After the fan stops, turn off the projector and remove the power cord from the projector's power receptacle.

**⚠ CAUTION!** You must lower the projector's foot before you remove the front cover. Removing the cover with the foot extended may cause the foot to collapse.

**⚠ CAUTION!** Exercise care when detaching the front cover in the next step. A ribbon cable connects the cover to the projector.

- 3 Remove the two screws on the lower front panel. Snap the front panel off. The lamp is now accessible.

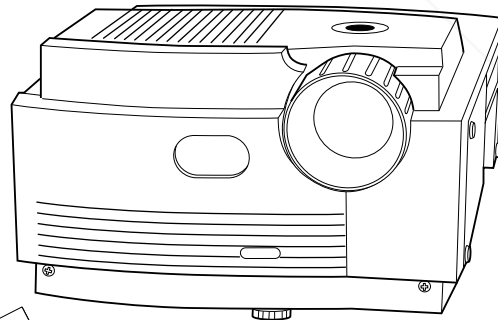

Remove  
Screw

Remove  
Screw

Figure 5-1 Removing the front panel

- 4 Unplug the cable from the board attached to the inside front panel. Set the front panel aside on a soft surface.

- 5 Rotate the lamp latch screw to release the lamp. Use your hand or a flat-tipped screwdriver.

**⚠ CAUTION!** *The lamp and surrounding areas get very hot; be careful when you remove the lamp. Make sure that the projector has cooled for at least five minutes.*

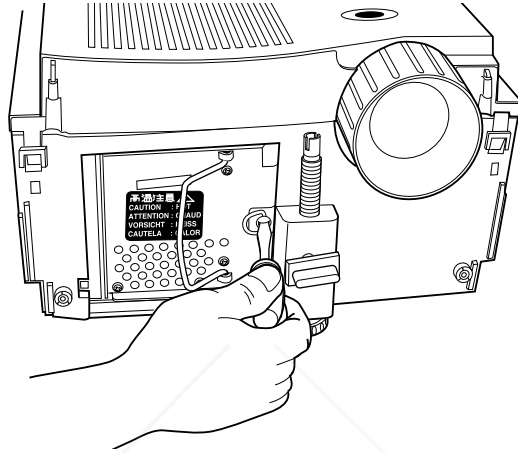

**Figure 5-2** Removing the lamp screw

- 6 Grasp the handle on the front of the lamp chamber and pull it out of the projector. Do not use excessive force.

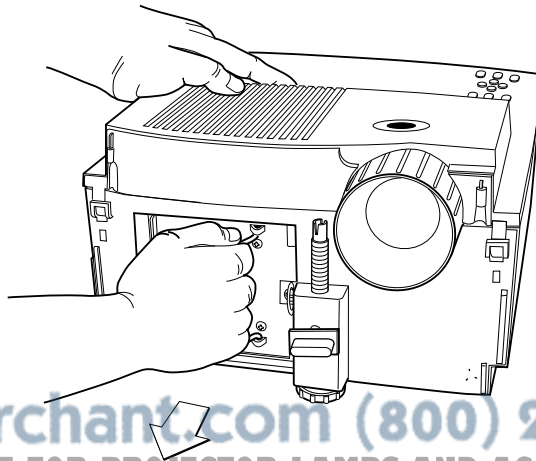

**Figure 5-3** Removing the lamp

- 7 Slide a replacement lamp into the projector, seating it firmly.

- 8 Rotate the lamp latch screw clockwise to lock it in place.
- 9 Carefully attach the ribbon cable to the board on the inside front panel.
- 10 Slide the front panel over the zoom lens.
- 11 Align the foot button with the hole in the front panel.
- 12 Continue to seat the front panel first on the lower left corner until you hear a click.
- 13 Snap the top corners into place and reinstall the lower screws.

## CLEANING THE LENS

From time to time, you'll need to clean the lens.

- 1 Form a piece of lens tissue into a loose swab. Wet it with lens cleaning fluid or denatured alcohol, and gently move it over the lens surface.
- 2 Take a part of the lens tissue that you haven't touched, and repeat the process, going over the lens in another direction.

**⚠ CAUTION!** *Your projector contains electric circuitry and sensitive optics. Protect it from potential fluid spills.*

## CHANGING REMOTE CONTROL BATTERIES

To install or change the two AAA alkaline batteries in the remote control unit:

- 1 Locate the battery compartment at the lower rear of the case. Slide the cover off the battery compartment.
- 2 Remove the old batteries and replace them with new ones. Make sure to align the batteries in the proper orientation (see Figure 5-4).
- 3 Replace the cover on the battery compartment.

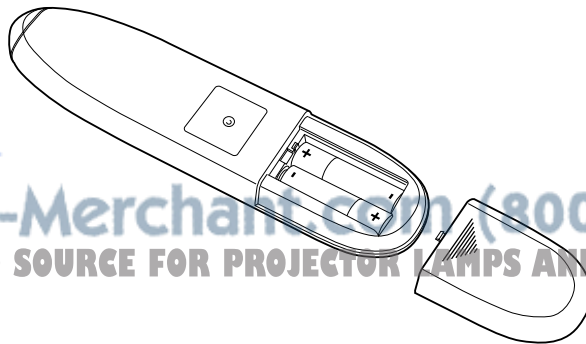
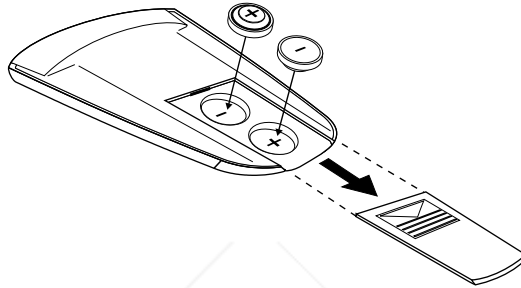

**Figure 5-4** Installing batteries

## CHANGING BATTERIES – CYCLOPS QUICK REMOTE

The Cyclops Quick Remote uses two 357A alkaline batteries.

- 1 Locate the battery compartment at the lower rear of the case. Press the corner down and slide it off.
- 2 Remove the old batteries and replace them with new ones. Make sure to align the batteries in the proper orientation.
- 3 Replace the battery cover.



**Figure 5-5** Installing batteries in the Cyclops Quick Remote

## CLEANING AND REPLACING THE NOISE FILTER

The noise filter is found only on early models of the DP4100. Follow the instructions below to determine if your projector contains a noise filter. The DP4200 does not use a noise filter.

You should rinse off the noise filter after every 100 hours of use. If you are using the projector in dusty areas, clean it more frequently. If you are experiencing a high number of over-temperature problems, you may need to clean the filter more often.

**⚠ CAUTION!** *Be sure to turn off the main AC power before opening the projector.*

- 1 Remove the two screws on the lower front panel and snap the front panel off (see Figure 5-1). Remove it carefully, as it is attached to the projector with a ribbon cable.
- 2 Press in on the tabs on the upper front sides of the projector and pull up gently on the top panel to remove it. Remove it carefully, as it is attached to the projector with a ribbon cable.



FixYourDLP.com

Sponsored by

Discount-Merchant.com (800) 281-8860

THE TRUSTED SOURCE FOR PROJECTOR LAMPS AND ACCESSORIES



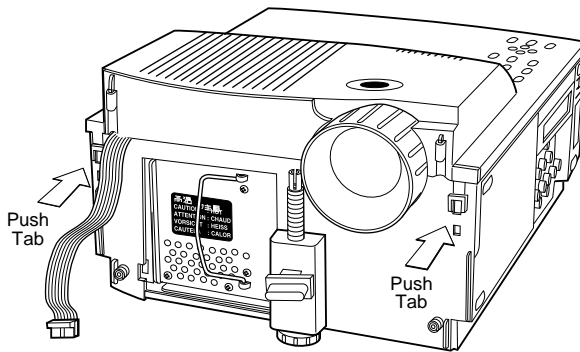

**Figure 5-6** Removing the top panel

- 3 Pull the noise filter out.

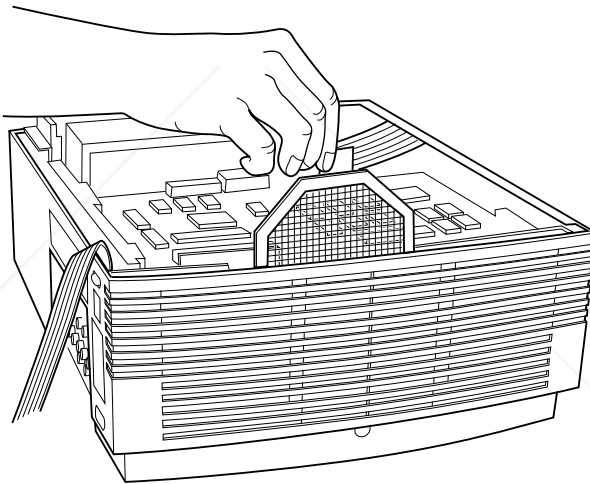

**Figure 5-7** Removing the noise filter

- 4 Rinse the filter, dry it, and replace it.
- 5 Replace the top cover (starting at the rear of the projector engaging the two tabs at the rear first, then working forward) and front panels to complete the installation. Be sure to reattach the ribbon cable on the front panel and tighten the two Phillips (crosspoint) screws that hold the front panel in place.

---

## Chapter 6

# Troubleshooting

### **WHERE TO GET HELP**

If you need help:

- 1** Check the Troubleshooting Chart.
- 2** Call your dealer's technical support line and explain your problem.
- 3** Call Proxima at:

**USA. and Canada:**

(619) 457-5500

(619) 457-8542 (Fax)

**Outside USA and Canada:**

(619) 457-5500

(619) 622-0173 (Fax)

**Europe:**

+31 -43-358 5200

+31-43-358 5201 (Fax)

**Internet (World Wide Web)**

<http://www.prxm.com> (Click on Customer Service)



**Discount-Merchant.com (800) 281-8860**  
**THE TRUSTED SOURCE FOR PROJECTOR LAMPS AND ACCESSORIES**

## Projector

<b>PROBLEM</b>	<b>LIKELY CAUSE</b>	<b>POSSIBLE SOLUTION(S)</b>
<b>No image projected</b>	No power to projector	Turn power ON Check AC cord Check power to electrical outlet
	Lamp not on	Turn lamp ON
	Lamp burned out	Replace lamp assembly
	Circuit breaker tripped	Correct overload situation; press circuit breaker reset button
	Over-temperature indication	Allow projector to cool; turn projector OFF and then ON
<b>No computer image projected</b>	Loose cable	Check and secure cable connections
	No power to computer	Turn on computer
	Incompatible video system	If possible, check computer with another monitor
<b>No video image projected</b>	Video source(s)	Check video source(s)
	Loose/improper cabling	Check and secure cabling between video source(s) and projector
<b>REPLACE LAMP indication</b>	Burned-out lamp	Replace lamp
<b>Displayed image not square (keystoning)</b>	Projector not placed at a proper angle to projection screen	Adjust position of the projector and the screen
<b>Projected image out of focus</b>	Projection lens not focused	Adjust the focus
<b>Projected image larger than screen</b>	Projector too far from screen Zoom not set correctly on zoom mode!	Move projector closer to screen Adjust power zoom



FixYourDLP.com

Sponsored by

DiscountMerchant.com (800) 981-8860  
 THE TRUSTED SOURCE FOR PROJECTOR LAMPS AND ACCESSORIES

<b>PROBLEM</b>	<b>LIKELY CAUSE</b>	<b>POSSIBLE SOLUTION(S)</b>
<b>Projected image smaller than screen</b>	Projector too close to screen	Move projector away from screen
	Zoom not set correctly on zoom model	Adjust zoom
<b>No image on the monitor</b>	Power switch off or projector not running	Computer must be on for computer monitor to display Turn on projector and light the lamp
	Cable not connected	Connect cable
<b>Streaks on monitor</b>	Video cable for monitor plugged into projector is upside-down	Check and reset cable connection
<b>Faint screen</b>	Low CONTRAST or BRIGHTNESS settings	Adjust CONTRAST and/or BRIGHTNESS
<b>Jittery, fuzzy text</b>	Out of sync	Adjust SYNC Adjust Dot Clock
	<b>Image off-center</b>	Position controls (arrow keys)
	Compatibility problem	Make sure the projector is compatible with one of the standards listed in Appendix A
	Misalignment or damage to optical elements	Projector requires service
<b>Cannot get entire image on screen; scrambled image</b>	Compatibility problems	Make sure projector is compatible with one of the standards listed in Appendix A
	Wrong video resolution	Set video resolution on computer to 640 x 480
<b>"Shimmering" colors</b>	SYNC out of adjustment	Adjust SYNC
<b>Colors weak</b>	Weak video signal	Check for faulty video source, bad connection, or frayed cable
<b>Getting excessive white or washout</b>	CONTRAST and/or	Adjust CONTRAST and/or
	BRIGHTNESS too high	BRIGHTNESS

<b>PROBLEM</b>	<b>LIKELY CAUSE</b>	<b>POSSIBLE SOLUTION(S)</b>
<b>Black and white image from color SECAM input</b>	Video signal ambiguous	Select the correct video source mode
<b>No audio</b>	Audio source(s)	Make sure that the audio source is turned on and functioning properly
	Loose/improper cabling	Check and secure cabling between audio source(s) and projector
<b>Over-Temperature indication</b>	Air vent(s) clogged	Allow projector to cool; clear obstructions from vents
	Fan malfunction	Allow projector to cool; check for fan operation, service if necessary
	Noise filter dirty	Allow projector to cool; clean noise filter
<b>Remote control doesn't work</b>	Batteries upside-down or old	Check battery placement or replace with new batteries
	Projector IR receiver window blocked	Remove object obstructing red IR receiver on front of projector
<b>Cyclops pointer and Cyclops F/X Software don't work at the same time</b>	Compatibility problem	Disable Cyclops pointer



FixYourDLP.com

Sponsored by 

**Discount-Merchant.com (800) 281-8860**  
**THE TRUSTED SOURCE FOR PROJECTOR LAMPS AND ACCESSORIES**

## **RETURNING YOUR DESKTOP PROJECTOR FOR REPAIR**

If the Desktop Projector or any of its accessories are determined to be defective:

- 1** Contact Proxima Customer Service to request a Return Material Authorization (RMA) number.
- 2** Send the defective unit, including any accessories, cables, and the remote controls, with the RMA number clearly marked on the outside of the shipping box, freight prepaid, to:

**USA and Canada:**

Proxima Corporation  
RMA #  
9440 Carroll Park Drive  
San Diego, CA 92121

**Europe:**

Proxima Corporation  
RMA #  
Horsterweg 24  
6191 RX Beek  
The Netherlands

- 3** Pack the projector in its original box for safe shipment (include all accessories, cables, and the remote controls). If you no longer have the original shipping materials, contact Proxima Customer Service for packaging.

## **ORDERING PARTS**

Please order replacement and accessory parts through your local reseller, or call Proxima at:

**USA and Canada:**

(800) 447-7694 or  
(619) 457-5500  
Fax: (619) 457-8542

**Europe:**

+44 (0) 1628 481555  
Fax: +44 (0) 1628 487744

**Outside USA and Canada:**

(619) 457-5500  
Fax: (619) 622-0173



**FixYourDLP.com**

Sponsored by DM

**Discount-Merchant.com (800) 281-8860**

**THE TRUSTED SOURCE FOR PROJECTOR LAMPS AND ACCESSORIES**

# Appendix A

## DP4100/4200 SPECIFICATIONS

<b>Color</b>	16.7 Million Colors
<b>Display Technology</b>	Digital Light Processing (DLP)
<b>Resolution</b>	VGA: 640 (H) x 480 (V) pixels; SVGA: 800 (H) x 600 (V)
<b>Contrast Ratio</b>	125:1 Typical
<b>Aspect Ratio</b>	4:3
<b>Projection Lamp</b>	270 Watt Metal Halide
<b>Brightness</b>	Color (typ. ANSI lumens): DP4100z - 315; DP4200z - 400 Grayscale (typical): DP4100z - 1050; DP4200z - 1400
<b>Optics</b>	High Definition Lens with Variable Focus or Zoom Lens
<b>Keystone Correction</b>	12.0 - 17.7 degrees depending on zoom lens adjustment; 17.7 degrees fixed lens
<b>Audio System</b>	Digital Stereo Sound, two built-in 3 Watt Speakers
<b>Inputs</b>	2 Computer Video 2 Composite Video (NTSC, PAL, SECAM, S-VIDEO) 2 Computer Stereo Audio 2 Composite Video Stereo Audio 1 Microphone RS-232 Aux Port Cyclops
<b>Outputs</b>	Stereo Audio (2 RCAs) 1 Monitor
<b>Power Source</b>	90-260 VAC, 47-63 Hertz
<b>Dimensions</b>	7.9" (H) x 13" (W) x 16" (D)
<b>Weight</b>	28 lbs.
<b>Throw Ratio</b>	1.5:1 Fixed Lens; 1.5 - 2.2:1 Zoom Lens
<b>Compatibility</b>	PC (VGA, SVGA), Apple Macintosh & PowerBook Series Quadra, Centris NTSC/PAL/SECAM/S-VIDEO



FixYourDLP.com

Sponsored by DM

Discount-Merchant.com (800) 281-8860

THE TRUSTED SOURCE FOR PROJECTOR LAMPS AND ACCESSORIES

---

<b>Screen Size (Diagonal)</b>	2.9 ft. (0.9m) to 25.5 ft. (7.8m)
<b>Projection Distance</b>	5 ft. (1.5m) to 30 ft. (9.1m) from screen
<b>Lamp</b>	270 watt metal Halide Replaceable lamp indicator light Lamp life 400 hours

---



**Discount-Merchant.com (800) 281-8860**  
**THE TRUSTED SOURCE FOR PROJECTOR LAMPS AND ACCESSORIES**



## Appendix B

# Accessories and Parts

### REPLACEMENT PARTS

<b>PART</b>	<b>PART NUMBER</b>
Lamp Assembly	L80
Cyclops Remote Control	A95
Cyclops Quick Remote	A85
Power Cord - US	C1002-10
Power Cord - Germany	C1001-10
Power Cord - Great Britain	C1004-10
Power Cord - Italy	C1003-10
VGA Video Cable	C951-6
Mac - VGA Cable Adapter	C922
VGA - Mac Monitor Adapter	C924
S-Video Cable	C466-6
Computer Audio Cable	C498-6
Serial Cable	C936-6
Mini-jack TO RCA Audio Adapter	C5105
Macintosh ADB Cable	C470-6
Noise Filter	140-01305-1
Cyclops F/X Driver Kit	A50F/X
Composite A/V Cable	C497-6
User's Guide, Multilingual	710-00496-1



FixYourDLP.com

Sponsored by EM

Discount Merchant.com (800) 281-8860

THE TRUSTED SOURCE FOR PROJECTOR LAMPS AND ACCESSORIES

## Optional Accessories

<b>OPTION</b>	<b>MODEL / PART NUMBER</b>
MediaExpress with Floppy Drive	ME40F
MediaExpress with Floppy Drive and Hard Drive	ME40H
Rolling Hard Case	A300
Rolling Soft Case	A298
Cyclops	A2074
Wireless Audio	A56 or A57



**Discount-Merchant.com (800) 281-8860**  
**THE TRUSTED SOURCE FOR PROJECTOR LAMPS AND ACCESSORIES**

# Index

## A

- AC Power switch 2-6
- Accessories B-2
- Advanced Menu 3-28
- Arrow Keys 1-6, 3-5
- AUDIO 1-5, 2-5
- Audio Menu
  - Fine Adjustments Submenu 3-25
  - Normal Audio Submenu 3-24
- AUDIO OUT 1-5, 2-5
- Audio Out Ports 2-14
  - External Speaker System Connection 2-14
  - External Stereo System Connection 2-14
- Audio Ports
  - Monaural Source 2-12
  - Stereo Source 2-12
- AUX PORT 1-5, 2-5
- Aux Port (Serial) 2-13

## B

- Batteries
  - Changing Quick Remote 5-4
  - Changing Remote Control Batteries 5-3
- Bright 3-3, 3-7, 3-23

## C

- Circuit Breaker Reset switch 2-6
- Color Palette 3-18
- COMPUTER 1 & 2 AUDIO 1-5, 2-5
- COMPUTER 1 & 2 IN 1-5, 2-5
- Computer Audio Port
  - Connecting a Monaural Source 2-10
  - Connecting a Stereo Source 2-10
- Computer Video Connection
  - Macintosh Computers 2-8
  - Notebook Computers 2-9
  - PC 2-6
  - Special Configurations 2-10
- Connector Panel 1-5, 2-5
- Connector Table 1-5, 2-5

- Contents of Box
  - Accessories 1-2
- Contrast 3-3, 3-7, 3-23
- Control Panel
  - Keys Table 1-6
- Control Panel Keys 3-4
- Control Panel Lights 1-7, 3-9
- Custom Settings
  - Recalling 3-28
  - Saving 3-28
- CYCLOPS 1-5, 2-5
- Cyclops 1-7
- Cyclops Connection 2-13
- Cyclops Remote Control 3-10
- Cyclops Tool Menu
  - Button 3-19
  - Calibrate 3-19

## D

- Desktop Projector
  - Powering Up 3-1
  - Turning Off 3-4
- Dot Clk 3-7, 3-23
- DP4100 Specifications A-1
- Draw Tool Bar
  - Clear All 3-18
  - Eraser 3-18
  - New Color 3-18
  - Pencil 3-18

## F

- Fit to View 3-23
- Focus 3-3, 3-7
- Focusing the Image
  - Non-Zoom Models 3-2, 3-3
  - Zoom Lens Models 3-2, 3-3
- Frame Advance
  - Quick Remote 3-12

## G

- Getting Started 2-2
- Graphical User Interface 3-14

## H

- Hide Key 1-6, 3-5
- Horz. Pos 3-7

## I

- Image Adjust Submenu 3-23
- Image Menu
  - Adjust Submenu 3-21
  - Projection Submenu 3-24
- Infrared Eye 3-11
- Input Source Menu
  - Source Mode 3-20
  - Source Select 3-20
  - Sync Status 3-20
- Input Video Source
  - Changing 3-21
- IR Speed 3-28

## L

- Lamp Assembly Replacement 5-1
- Lamp Reset 3-28
- Laptop Connections 2-9
- Lens Cleaning 5-3
- LightBoard Tools
  - BlackBoard 3-16
  - Overlay 3-16
  - WhiteBoard 3-16

## M

- Macintosh Adapters 2-8
- Macintosh Connections 2-8
- Main Menu 3-15
- Maintenance
  - Changing Remote Control Batteries 5-3
  - Lamp Assembly Replacement 5-1
  - Lens Cleaning 5-3
- MediaExpress 1-7, 3-8
- MediaExpress Key 1-6
- MENU 3-11
- Menu Key 1-6, 3-6
- Menu Selection
  - Using a Cyclops Interactive Pointer System 3-14
  - Using a Mouse 3-14
  - Using Control panel or Cyclops Remote 3-14
- MIC 1-5, 2-5
- Microphone Connection 2-13
- Mode 3-28



FixYourDLP.com

Sponsored by DMI

DiscountMerchant.com (800) 251-8360

THE TRUSTED SOURCE FOR PROJECTOR LAMPS AND ACCESSORIES

Monaural Audio 3-26  
MONITOR OUT 1-5, 2-5  
MUTE 3-11  
Muting Audio 3-26

## **N**

Noise Filter 5-4  
Normal Video 3-23  
Notebooks 1-4

## **O**

Operating Modes  
    Host Mode 3-13  
    Local Mode 3-13  
Ordering Parts 6-5  
Over-Temperature 3-9

## **P**

Parts  
    Optional Accessories B-2  
    Replacement B-1  
Power 3-9  
Power Key 1-6, 3-5  
Power Key and Light 3-1  
Power receptacle 2-6  
Power to the Projector 2-6  
Powering Up Projector 3-1  
Preferences Menu 3-27  
    Language 3-27  
    Prog Key 1 and 2 3-27  
Preview Key  
    Quick Remote 3-12  
PROG1 3-11  
PROG2 3-11  
Projection Submenu 3-24  
    Display 3-24  
    Mode 3-24  
    Position 3-24  
    Positioning 2-2  
    Transporting 2-3  
    Troubleshooting 6-2  
Projector Cooling and Airflow 2-4  
Projector Operation  
    Using a Mouse 3-12

Using Control Panel and  
Remote 3-12

## **Q**

Quick Remote Batteries 5-4  
Quick Remote Keys 3-12  
Quick Start  
    Desktop Macintosh computers  
    1-3  
    Desktop PCs 1-3  
    Notebooks 1-4

## **R**

Remote Control Batteries 5-3  
Remote Control Keys 3-11  
Remote Control Unit 3-11  
Repair of your Desktop Projector  
6-5  
Replace Lamp 3-10  
Replacement Parts B-1  
Returning your Desktop Projector  
for repair 6-5

## **S**

S-VHS 1 & 2 1-5, 2-5  
Saturation 3-7, 3-23  
See-it/Show-it 4-7  
Select Key  
    Quick Remote 3-12  
Settings Table 3-3, 3-7  
SETUP 3-11  
Setup Key 3-6  
Setup Menu Key 1-6  
SOURCE 3-11  
Source Key 1-6, 3-6  
    Quick Remote 3-12  
Source Mode  
    Changing 3-21  
Special Configurations 1-4  
Specifications A-1  
Stereo Audio 3-26  
Submenu Adjustment  
    Computer Source 3-22  
    Video Source 3-22  
Sync 3-7, 3-23

## **T**

Tint 3-7, 3-23  
Tool Selection  
    Choosing a Color 3-18  
    Draw Tool Bar 3-18  
Tool Selection Menu  
    Cyclops 3-19  
    LightBoard 3-16  
    Timer 3-20  
Troubleshooting  
    Projector 6-2  
    Where to Call 6-1

## **U**

User 3-28

## **V**

Vert. Pos 3-7  
VGA Connections 2-7  
VGA Video Cable 2-6  
VIDEO 1 & 2 1-5, 2-5  
Video Input Ports  
    Composite Video Connections  
    2-11  
    S-VHS Connections 2-11  
VOLUME 3-11  
Volume Key 1-6, 3-6

## **W**

Wireless Audio 1-7  
Workgroup  
    knob 3-8  
    mode 3-8

## **Z**

Zoom 3-7

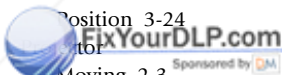

Discount-Merch.com (800) 281-8860  
THE TRUSTED SOURCE FOR PROJECTOR LAMPS AND ACCESSORIES



# Disclaimer

This user manual is provided as a free service by FixYourDLP.com. FixYourDLP is in no way responsible for the content of this manual, nor do we guarantee its accuracy. FixYourDLP does not make any claim of copyright and all copyrights remain the property of their respective owners.

About FixYourDLP.com

FixYourDLP.com (<http://www.fixyourdpl.com>) is the World's #1 resource for media product news, reviews, do-it-yourself guides, and manuals.

Informational Blog: <http://www.fixyourdpl.com>

Video Guides: <http://www.fixyourdpl.com/guides>

User Forums: <http://www.fixyourdpl.com/forum>

FixYourDLP's Fight Against Counterfeit Lamps:

<http://www.fixyourdpl.com/counterfeits>

## Sponsors:

RecycleYourLamp.org – Free lamp recycling services for used lamps:

<http://www.recycleyourlamp.org>

Lamp Research - The trusted 3rd party lamp research company:

<http://www.lampresearch.com>

Discount-Merchant.com – The worlds largest lamp distributor:

<http://www.discount-merchant.com>



**FixYourDLP.com**

Sponsored by 