



Disclaimer

This user manual is provided as a free service by FixYourDLP.com. FixYourDLP is in no way responsible for the content of this manual, nor do we guarantee its accuracy. FixYourDLP does not make any claim of copyright and all copyrights remain the property of their respective owners.

About FixYourDLP.com

FixYourDLP.com (<http://www.fixyourdlp.com>) is the World's #1 resource for media product news, reviews, do-it-yourself guides, and manuals.

Informational Blog: <http://www.fixyourdlp.com>

Video Guides: <http://www.fixyourdlp.com/guides>

User Forums: <http://www.fixyourdlp.com/forum>

FixYourDLP's Fight Against Counterfeit Lamps:

<http://www.fixyourdlp.com/counterfeits>

Sponsors:

RecycleYourLamp.org – Free lamp recycling services for used lamps:

<http://www.recycleyourlamp.org>

Lamp Research - The trusted 3rd party lamp research company:

<http://www.lampresearch.com>

Discount-Merchant.com – The worlds largest lamp distributor:

<http://www.discount-merchant.com>



FixYourDLP.com

Sponsored by 

EPSON® PowerLite® 600p/811p/820p Multimedia Projector

User's Guide

 **FixYourDLP.com**
Sponsored by 

Discount-Merchant.com (800) 281-8860

THE TRUSTED SOURCE FOR PROJECTOR LAMPS AND ACCESSORIES

Important Safety Information

WARNING: Never look into the projector lens when the lamp is turned on; the bright light can damage your eyes. Never let children look into the lens when it is on. Never open any cover on the projector, except the lamp and filter covers. Dangerous electrical voltages inside the projector can severely injure you. Except as specifically explained in this *User's Guide*, do not attempt to service this product yourself. Refer all servicing to qualified service personnel.

WARNING: The projector and its accessories come packaged in plastic bags. Keep plastic bags away from small children to avoid any risk of suffocation.

Caution: When you replace the lamp, never touch the new lamp with your bare hands; the invisible residue left by the oil on your hands may shorten the lamp life. Use a cloth or glove to handle the new lamp.

Copyright Notice

All rights reserved. No part of this publication may be reproduced, stored in a retrieval system, or transmitted in any form or by any means, electronic, mechanical, photocopying, recording, or otherwise, without the prior written permission of SEIKO EPSON CORPORATION. The information contained herein is designed only for use with this EPSON product. EPSON is not responsible for any use of this information as applied to other products.

Neither SEIKO EPSON CORPORATION nor its affiliates shall be liable to the purchaser of this product or third parties for damages, losses, costs, or expenses incurred by purchaser or third parties as a result of: accident, misuse, or abuse of this product or unauthorized modifications, repairs, or alterations to this product, or (excluding the U.S.) failure to strictly comply with SEIKO EPSON CORPORATION's operating and maintenance instructions.

SEIKO EPSON CORPORATION shall not be liable for any damages or problems arising from the use of any options or any consumable products other than those designated as Original EPSON Products or EPSON Approved Products by SEIKO EPSON CORPORATION.

EPSON is a registered trademark of SEIKO EPSON CORPORATION.

EPSON Connection, EPSON Store, and Extra Care, are service marks; SizeWise is a trademark; and PrivateLine, Presenters Club, and PowerLite are registered trademarks of Epson America, Inc.

General Notice: Other product names used herein are for identification purposes only and may be trademarks of their respective owners. EPSON disclaims any and all rights in those marks.

Copyright © 2002 by Epson America, Inc.

4/02

Printed on recycled paper.

CPD-13953



Discount-Merchant.com (800) 281-8860

THE TRUSTED SOURCE FOR PROJECTOR LAMPS AND ACCESSORIES

C

Contents

- Welcome* 1
- Getting the Most from Your Projector 2
- Using Your Documentation 3
 - Getting More Information 3
- Registration and Warranty 4
- Unpacking the Projector 5
 - Additional Components 6
 - Optional Accessories 7

1

- Setting Up the Projector* 9
- Positioning the Projector 10
- Connecting to a Laptop Computer 12
 - Connecting the Computer Cable 12
 - Connecting the Cable for Remote Mouse Control 13
 - Amplifying Computer Audio 14
- Connecting to Video Sources 15
 - Connecting the RCA A/V Cable 16
 - Connecting an S-Video Cable 17
 - Connecting a Component Video Cable 18

2

- Using the Projector* 19
- Turning On Your Equipment 20
 - Turning On the Projector 20
 - What To Do If You See a Blank Screen 22
- Adjusting the Image 24
 - Focusing and Zooming Your Image 25
 - Adjusting the Height of Your Image 26
 - Adjusting the Image Shape 27
 - Resizing the Image 28
 - Adjusting the Tracking and Synchronization 28



Discount-Merchant.com (800) 281-8860

THE TRUSTED SOURCE FOR PROJECTOR LAMPS AND ACCESSORIES

- Controlling the Projector 29
 - Switching Between Picture Sources 29
 - Adjusting the Volume 29
 - Turning Off the Picture and Sound 30
- Shutting Down the Projector 30

3 *Using the Remote Control* 33

- Turning On and Using the Remote Control 34
 - Installing Batteries 34
 - Turning On the Remote Control 34
 - Using the Remote Control 35
- Controlling the Picture and Sound 35
 - Switching Between Picture Sources 35
 - Adjusting the Volume 36
 - Turning Off the Picture and Sound 36
 - Stopping Action 36
 - Zooming Your Image 37
 - Resizing the Image 37
 - Displaying Picture-in-Picture Video 38
- Highlighting Your Presentation 39
 - Using the Pointer 39
 - Spotlighting Your Image 40
 - Using Horizontal and Vertical Highlights 40
- Using the Remote Control as a Wireless Mouse 41

4 *Fine-tuning the Projector* 43

- Using the Projector's Menu System 44
 - Changing Menu Settings 45
- Adjusting the Image 47
 - Repositioning the Image 48
 - Adjusting Image Appearance 48
 - Saving and Recalling Computer Settings 50
- Adjusting the Sound 51
- Customizing the Highlighting Tools 52
- Creating Your Own Startup Screen 53
 - Capturing the Image 53
 - Choosing When to Display the Image 54



Discount-Merchant.com (800) 281-8860

THE TRUSTED SOURCE FOR PROJECTOR LAMPS AND ACCESSORIES

Customizing Projector Features 55
 Setting Advanced Features 57
 Viewing Lamp Usage and Other Information..... 58
 Restoring the Default Settings 59

5 *Maintaining and Transporting the Projector* 61
 Cleaning the Lens..... 62
 Cleaning the Projector Case 62
 Cleaning and Replacing the Air Filter..... 63
 Replacing the Lamp 64
 Resetting the Lamp Timer 67
 Transporting the Projector 68

6 *Solving Problems* 69
 Using On-Screen Help 70
 What To Do When the Lights Flash..... 71
 Solving Problems with the Image or Sound 73
 Solving Problems with the Remote Control 79
 Where To Get Help 80
 Telephone Support Services 80

A *Appendix A: Connecting to Additional Equipment* 81
 Installing the Projector 82
 Controlling the Projector from a Computer..... 83
 Connecting to an External Audio System..... 83
 Connecting to a PC Desktop Computer..... 84
 Connecting the Computer Cable 84
 Connecting the Mouse Cable..... 86
 Connecting the Audio Cable 87
 Connecting to a Desktop Macintosh 88
 Connecting the Computer Cable 88
 Connecting the Mouse Cable..... 90
 Connecting the Audio Cable 91
 Connecting to a Second Computer..... 92



Discount-Merchant.com (800) 281-8860

THE TRUSTED SOURCE FOR PROJECTOR LAMPS AND ACCESSORIES

Connecting to a High-End Workstation 93
Connecting to a DVI Video Source 93

B *Appendix B: Notices* 95
Important Safety Instructions 95
Remote Control Information 97
Declaration of Conformity 98
FCC Compliance Statement 99
Warranty 100

C *Appendix C: Technical Specifications* 103
General 103
Projection Lamp 104
Remote Control 104
Mouse Compatibility 104
Dimensions 104
Electrical 104
Environmental 105
Safety 105
Computer Video Port Pin Assignments 105
Compatible Video Formats 106
ESC/VP21 Commands 108

Index 109



Discount-Merchant.com (800) 281-8860

THE TRUSTED SOURCE FOR PROJECTOR LAMPS AND ACCESSORIES

W *Welcome*

The EPSON® PowerLite® 600p, 811p, and 820p are portable projectors that weigh less than 10 pounds and offer up to 2500 ANSI lumens of brightness. From classrooms to auditoriums, your full-color presentations and videos will be bright and visible even in ordinary room lighting.

Images are displayed at a resolution of 1024 × 768 pixels (PowerLite 811p and 820p) or 800 × 600 pixels (PowerLite 600p). The 0.9-inch LCD provides a high contrast ratio for incredibly vivid images and clear text. Improved color processing technology reduces “video noise” for rich, saturated images, while 5-watt amplified sound and whisper-quiet operation contribute to theater-quality video.

With EPSON’s patented SizeWise™ chip, the projector supports computer displays ranging from VGA through UXGA (or SXGA on the PowerLite 600p). The projector also supports the Digital Visual Interface (DVI) format.

You can connect the projector to a wide range of computers, including PCs and laptops, Apple® Macintosh®, Power Macintosh® series (including G3 and G4 systems), PowerBook® computers, many iMac® and iBook® series systems, and high-end workstations such as the Sun® SPARCstation.™

You can use any of the following video sources: VCR, DVD player, camcorder, digital camera, or laser disc player. The projector supports composite video, S-Video, and component video, and it automatically senses the video format (HDTV, NTSC, PAL, or SECAM).

Support for USB audio and horizontal keystone control contribute to ease of setup in a wide variety of environments.



Discount-Merchant.com (800) 281-8860

THE TRUSTED SOURCE FOR PROJECTOR LAMPS AND ACCESSORIES

Welcome

Getting the Most from Your Projector

note

You can connect a maximum of four sources at the same time.

Your EPSON PowerLite projector is a highly versatile presentation tool. You can connect it to one or two computer sources and up to three video sources and easily switch between them. You can also include sound for up to three of the sources.

Depending on your presentation, you can take advantage of any or all of these options:

- **Connecting to a laptop or other computer**

If you want to connect to a PC laptop or Macintosh PowerBook or iBook, see page 12. To connect to a desktop computer, a workstation, a computer that outputs video in Digital Visual Interface (DVI) format, or more than one computer, see Appendix A.

- **Connecting to video sources**

You can connect a DVD player, VCR, camcorder, laser disc player, digital camera, or any other video source to your projector. You can connect up to three video sources at the same time (with or without a computer) and easily switch between them. See page 15 for instructions.

- **Using the remote control**

The remote control lets you switch from one computer or video source to another, with access to picture-in-picture, pointer, zoom, and many other projector features. For details, see Chapter 3.

By connecting an additional cable, you can also use the remote control as a wireless mouse. This lets you click through slideshow-style presentations (such as PowerPoint®) from up to 30 feet away. For more information, see page 41.

- **Including sound in your presentation**

If your presentation includes sound, you can connect the USB cable or an optional audio cable to use the projector's built-in speakers. For details, see page 14 (for laptops) or Appendix A (for other systems).

If you're permanently installing the projector, you may wish to connect external speakers or a public address system to the projector's **Audio Out** port; see page 83.

■ **Controlling the Projector from a Computer**

If you want to be able to control the projector's settings from a computer (for example, if the projector is ceiling-mounted), you can install the EMP Link program. You can download this program, plus its *User's Guide*, from EPSON's web site at support.epson.com. You'll also need a serial or USB cable to connect the projector to the computer.

Using Your Documentation

To connect the projector to your laptop and get your presentation up and running fast, see the *Quick Setup* sheet in your owner's kit.

This book contains all the information you need to set up and use your projector. Please follow these guidelines as you read through it:

- Warnings must be followed carefully to avoid bodily injury.
- Cautions must be observed to avoid damage to your equipment.
- Notes contain important information about your projector.

Getting More Information

Need tips on giving presentations? Quick steps for setting up your projector? Here's where you can look for help:

- **presentersonline.com**
Includes a library of articles covering presentation tips, tricks, and technology. The site provides templates, clip art and sound clips, as well as Presenters Services to use on the road. Even more resources and services are available if you register to join the Presenters Club®—and it's free.
- **Quick Setup sheet**
Gives you all the instructions you need to get your projector set up and connected to a laptop or PowerBook computer.

- **Owner's Kit**
Includes your *Quick Setup* sheet, warranty brochures, and EPSON PrivateLine® Support card. Store this *User's Guide* in the folder and keep the folder with your projector at all times.
- **Built-in help system**
Provides assistance for common problems. Available from the Help button on the projector or the remote control. See page 70 for details.
- **support.epson.com**
Download FAQs and e-mail your questions to EPSON support.

If you still need help after checking this *User's Guide* and the sources listed above, you can use the EPSON PrivateLine Support service to get help fast. Call (800) 637-7661 and enter the PIN on the card in your owner's kit. Or take advantage of EPSON's automated support services 24 hours a day. See page 80 for more information.

Registration and Warranty

Your projector comes with a basic carry-in warranty (on page 100) as well as an international warranty that let you project with confidence anywhere in the world. For details, see the warranty brochure included in your owner's kit.

In addition, for customers who register their projector, EPSON offers free Extra CareSM Road Service. In the unlikely event of an equipment failure, you won't have to wait for your unit to be repaired. Instead, EPSON will ship you a replacement unit anywhere in the United States or Canada, usually via overnight delivery. See the brochure in your owner's kit for details.

To register, simply fill out the registration card included in your owner's kit and mail it to EPSON. Or you can register online at <http://epsonwebreg.info2.net/>. Registering also lets you receive special updates on new accessories, products, and service.



Discount-Merchant.com (800) 281-8860

THE TRUSTED SOURCE FOR PROJECTOR LAMPS AND ACCESSORIES

Unpacking the Projector

After unpacking the projector, make sure you have all the parts shown below:

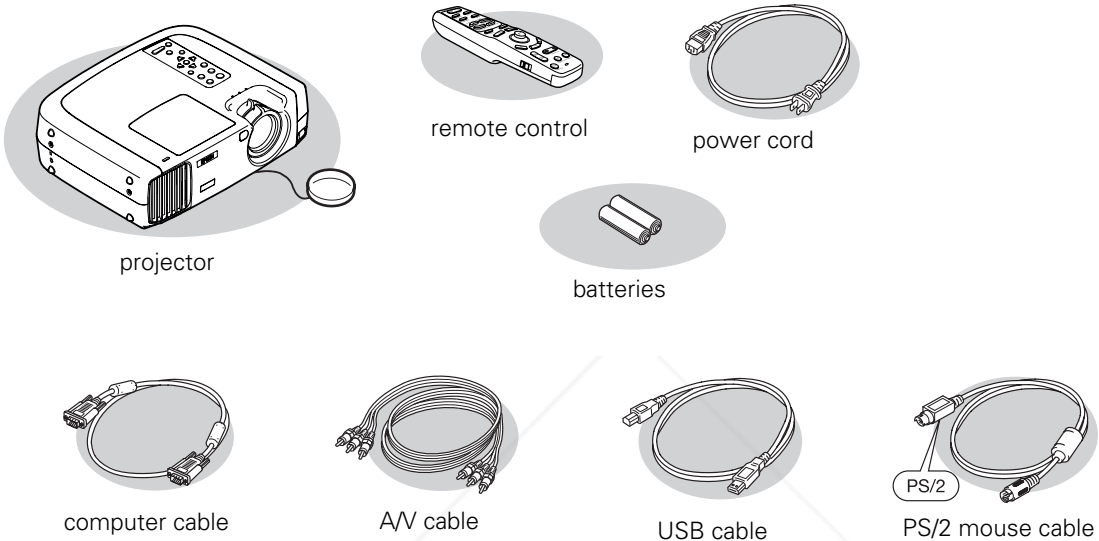

Save all packaging in case you need to ship the projector. Always use the original packaging (or the equivalent) when you need to send the projector to another location.

If you are moving the projector by hand, use a carrying case (such as the optional cases available from EPSON). See page 7 for more information about cases.

Additional Components

Depending on how you plan to use the projector, you may need additional components:

- To receive an S-Video signal, you need an S-Video cable. (One is usually provided with your video device.)
- To receive a component video signal from a VCR or other video device, you need a VGA-to-component video cable. You can purchase this from EPSON; see page 7.
- To connect two computers to the projector at the same time, you need a DVI/analog interface cable. You can purchase this from EPSON; see page 7.
- Some older PowerBooks and Macintosh desktop models may need the Macintosh adapter set shown on page 89 (available from EPSON; see page 7). Older iMac systems may need a special adapter to provide a VGA output port; see your computer dealer.
- Some systems may need an additional cable to use the remote control as a wireless mouse. If your Macintosh doesn't have a USB port, you'll need a Macintosh mouse cable. If your PC doesn't have a USB or PS/2 port, you'll need a PC serial mouse cable. See your projector dealer to obtain the correct cable.
- To take advantage of the projector's Digital Visual Interface, you need a DVI cable, and your computer must be capable of producing video signals in DVI format (for details, see page 93). You can purchase this cable from EPSON; see page 7.
- To receive an audio signal, you may need a stereo mini-jack cable, available from most electronics dealers.

Optional Accessories

To enhance your use of the projector, EPSON provides the following optional accessories. You can purchase these accessories from your dealer, by calling EPSON at (800) 873-7766, or by visiting the EPSON StoreSM at www.epsonstore.com (U.S. sales only). In Canada, please call (800) 463-7766 for dealer referral.

Product	Product number
Replacement lamp and air filter	V13H010L15
Customized carrying cases: Samsonite® wheeled soft case ATA molded hard shell case ATA shipping case Soft shoulder bag	ELPKS35 ELPKS40 ELPKS41 ELPKS13
Ceiling mount Suspension adapter False ceiling plate	ELPMB36 ELPMBAPL ELPMBFCP
Kensington® security lock	ELPSL01
Projection screens: 50-inch portable screen 60-inch Insta Theatre screen 80-inch Insta Theatre screen	ELPSC06 ELPSC07 ELPSC08
Wireless microphone and two satellite speakers	ELPCVSII
Auxiliary audio system	ELPPAS1
Remote control receiver (plugs into projector to extend range of remote control)	ELPST02
Remote control receiver kit (includes standard receiver and clip-on receiver for attachment directly to remote control)	ELPST04
Macintosh adapter set (includes monitor adapter and desktop adapter)	ELPAP01
Component video cable (VGA to component video)	ELPKC19
Digital video cables: DVI to DVI, 10 feet (3 meters) DVI to DFP, 10 feet (3 meters) DVI to analog video, 10 feet (3 meters)	ELPKC20 ELPKC21 V12H005C25
High resolution document imager Motion presentation camera High resolution document camera	ELPDC02 ELPDC03 V12H064020

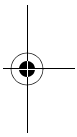
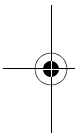
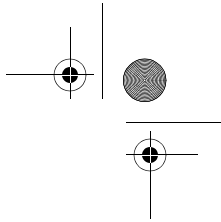
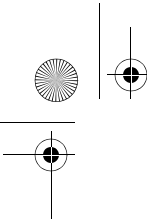

Sponsored by 

Discount-Merchant.com (800) 281-8860

THE TRUSTED SOURCE FOR PROJECTOR LAMPS AND ACCESSORIES

8 *Welcome*

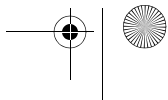
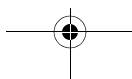
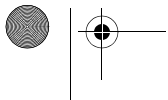

1 *Setting Up the Projector*

This chapter tells you how to set up the projector for a laptop computer or video presentation. If you need to set up the projector for a permanent installation or connect it to a desktop or workstation computer, see Appendix A.

You'll find instructions for the following in this chapter:

- Positioning the projector
- Connecting to a laptop computer
- Connecting to video sources

Positioning the Projector

Before connecting the projector, you need to decide where to place it. The location you choose depends on the size of the room and what you are projecting.

- Place the projector on a sturdy, level surface, approximately 2.85 to 41 feet from the screen.
- Make sure there is plenty of space for ventilation around and under the projector.
- Make sure the projector is within 10 feet of a grounded electrical outlet or extension cord, and within 5 feet of your computer and/or video source.
- Place the projector directly in front of the center of the screen, facing it toward the screen squarely.

note

It's easier to position the projector when the screen is directly in front of the room. However, if you need to place it off-center, you can use the keystone correction feature to maintain a square image. See page 27 for more information.

Most presenters find it convenient to place the projector in front of the audience, leaving as much space as possible between the projector and the screen to get a good-sized image. This lets the presenter stand in the front of the room, face the audience, and remain close enough to the equipment to be able to control it.

Use the figure below as a guideline to help you determine how far from the screen to place the projector. Image size generally increases with distance, but may vary depending on how you position the zoom ring and whether you have adjusted the image size with other settings.

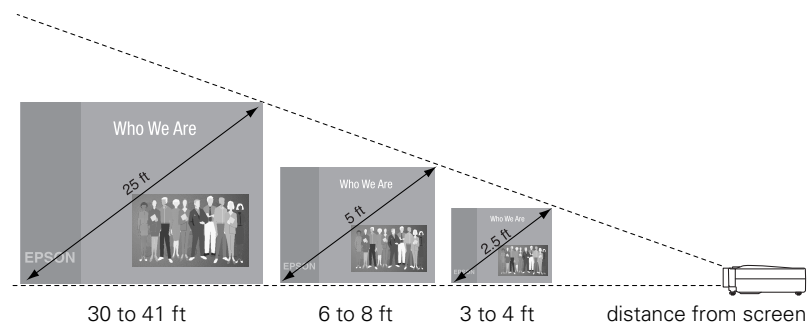

If you place the projector below the level of the screen, you'll have to tilt it up by extending the feet as shown. Tilting the projector upward causes the image to lose its square shape, but you can correct the distortion by pressing the Keystone button as described in the next chapter.

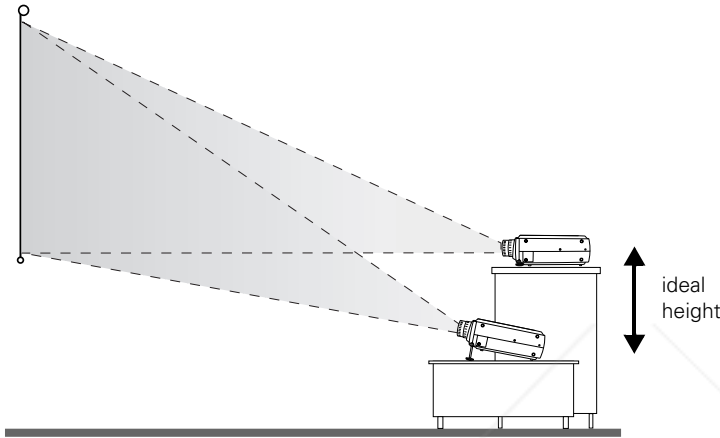

If you place the projector level with the bottom of the screen, the image will be square and you won't have to adjust it. If you place the projector higher than the bottom of the screen, the image will still be square, but you won't be able to fill the whole screen with the image.

note

After positioning the projector, you may want to connect a Kensington MicroSaver® anti-theft device to the lock port on the projector's left side. You can purchase this from EPSON; see "Optional Accessories" on page 7.

Connecting to a Laptop Computer

note

To connect to desktops and other computer systems, see Appendix A. If you have an iBook with an RCA video-out port, follow the instructions for connecting to a video device on page 16.

You can connect the PowerLite projector to any computer that has a standard video output (monitor) port, including PC notebook and laptop computers, Macintosh PowerBooks and iBooks, and hand-held devices.

Connecting the Computer Cable

Before you start, make sure your computer and the projector are turned off.

1. Connect one end of the computer cable to the projector's Computer2/Component Video port.

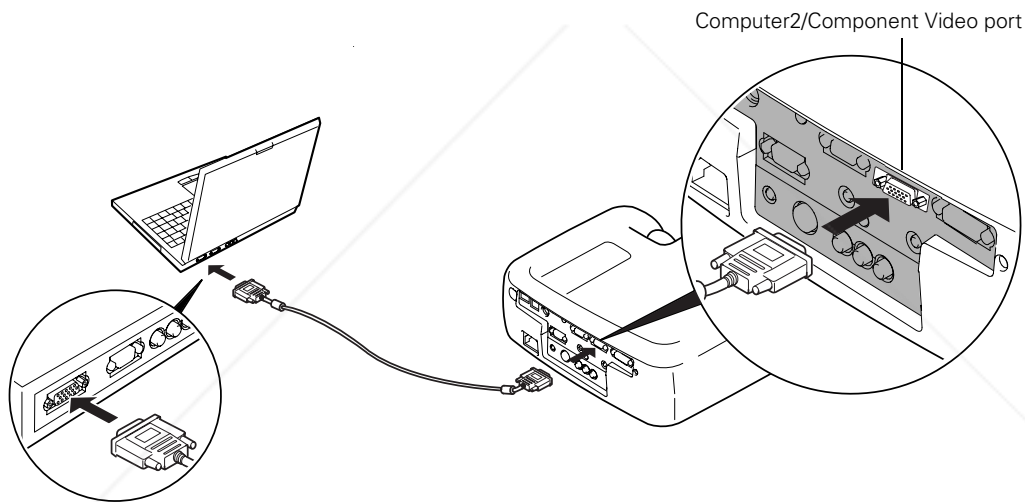

note

Laptop configurations vary. See your computer manual for the location of the ports needed to connect your projector.

2. Connect the other end of the computer cable to your laptop's video-out or monitor port.

If you're using a PowerBook and you can't connect the cable, you may need to use the Macintosh desktop adapter as shown on page 89 (available from EPSON; see page 7).

3. Tighten the screws on the connectors.

If you don't need to make any other connections, you can plug in your projector and turn it on. See page 20 for instructions.

Connecting the Cable for Remote Mouse Control

Using the remote control as a wireless mouse lets you control your computer and click through slideshow-style presentations, such as PowerPoint, from up to 30 feet away (for details, see page 41). This gives you more flexibility in delivering your presentation, since you won't need to stand near your computer.

The USB cable also provides audio support. If your presentation includes sound, you can play it through the projector's speakers by connecting the USB cable.

1. Locate the cable you need, depending on whether your laptop has a round PS/2 mouse port or a flat USB mouse port.
2. Connect one end of the cable to the projector's  USB or Mouse port.

note

If you're using a PowerBook that has a round mouse port, you'll need a Macintosh mouse cable. If you have a PC laptop with a serial mouse port, you'll need a serial mouse cable. See your projector dealer to obtain the correct cable.

On a PowerBook or iBook, USB audio support is available for Mac OS 9.0 and 9.1 only.

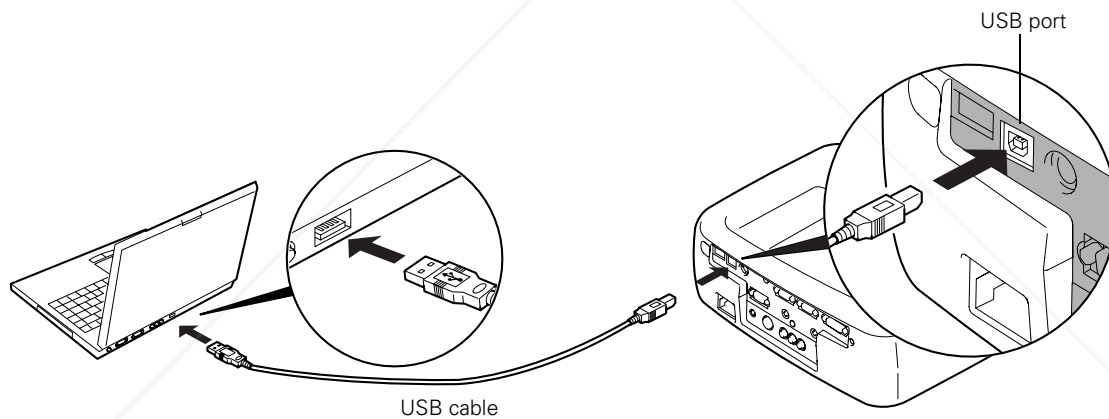

3. Connect the other end of the cable to the external mouse port or USB port on your laptop.
4. If necessary, configure your laptop to work with an external mouse.

If you don't need to make any other connections, you can plug in your projector and turn it on. See page 20 for instructions.

note



If you connected the USB cable, you may not need a separate audio cable to amplify audio from your computer.

Amplifying Computer Audio

Your laptop probably has its own sound system; however, it may not be adequate for your presentation. If you need more volume or better sound quality, you can connect a stereo, mini-jack audio cable (not included).

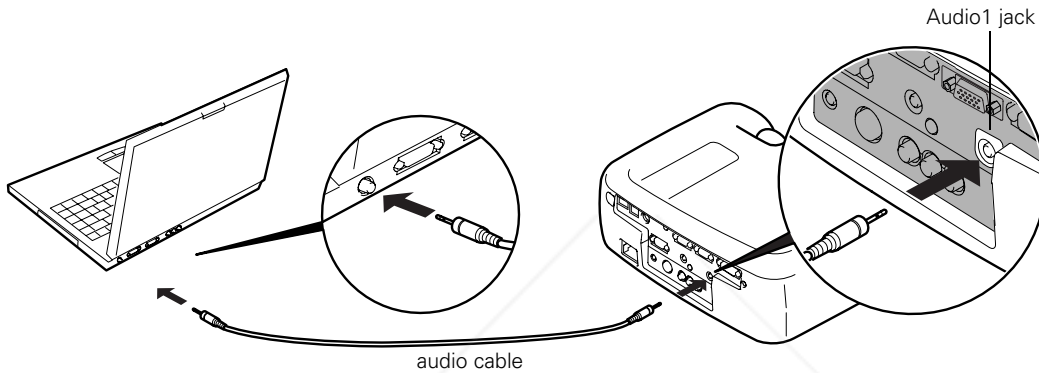
1. Connect one end of the audio cable to the **Audio1** jack on the projector.



2. Connect the other end of the audio cable to your laptop's  headphone jack or  audio-out jack. (Jack locations vary; see your computer manual if you're not sure which jack to use.)

If you don't need to make any other connections, you can plug in your projector and turn it on. See page 20 for instructions.

Connecting to Video Sources

You can connect a DVD player, VCR, camcorder, laser disc player, digital camera, or any other compatible video source to your projector.

The projector supports HDTV, NTSC, PAL, and SECAM, and automatically detects the video format.

The projector can receive composite video, S-Video, and component video. You can connect one or more of these video sources at the same time.

The type of cable you use depends on whether you have composite video, S-Video, or component video.

- For composite video, use the RCA A/V cable included with the projector.
- For S-Video, use the S-Video cable supplied with your video device or obtain one from your electronics dealer.
- For component video, you'll need a VGA-to-component video cable. You can purchase this from EPSON; see page 7. Component video connectors are usually colored green, blue, and red.

note

The projector does not support TV antenna cable F-connectors.

See the following illustration if you're not sure which type of connectors you have.

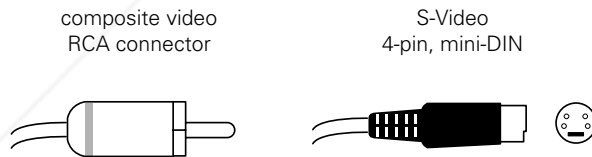

Follow the instructions below for your type of connection.

Connecting the RCA A/V Cable

Before starting, make sure the projector and your DVD player or other video source are turned off.

1. Connect the yellow plug on one end of the A/V cable to the projector's yellow **Video** jack.
2. Connect the other yellow plug to the video-out jack on your video source.
3. Connect the red and white plugs on the A/V cable to the projector's **Audio L** (white) and **R** (red) jacks.
4. Connect the red and white plugs on the other end of the cable to the corresponding audio output jacks on your video source.

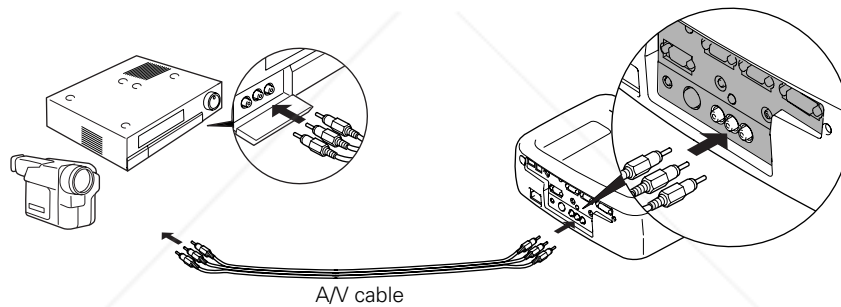

If your video source has a stereo mini-jack instead of RCA jacks, you can use a stereo mini-jack cable (not included). Connect it to the **Audio 1** jack on the projector.

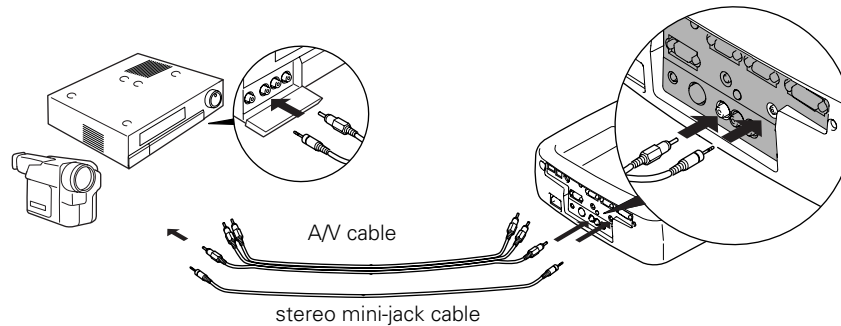

Connecting an S-Video Cable

If your video source has an S-Video jack, you can use it to project a higher quality video image. However, you'll need an S-Video cable, which may be included with your video source, or can be purchased separately.

Before starting, make sure the projector and your DVD player or other video source are turned off.

1. Insert one end of an S-Video cable into the projector's **S-Video** connector.
2. Insert the other end into the S-Video output port of your video source.
3. If your video source has RCA audio, you can use the A/V cable to connect to the projector's **Audio L** (white) and **R** (red) jacks.

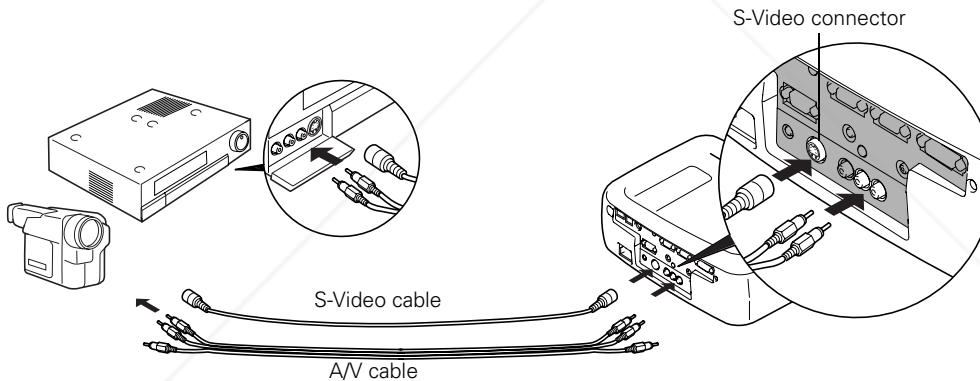

If your video source has a stereo mini-jack instead of RCA jacks, you can use a stereo mini-jack cable (not included). Connect it to the **Audio 1** jack on the projector.

Connecting a Component Video Cable

If your video source has component (blue, green, and red) connectors, you can use them to project a higher quality video image. However, you'll need a VGA-to-component video cable, which is available from EPSON; see page 7.

Before starting, make sure the projector and your DVD player or other video device are turned off.

1. Connect the VGA end of the cable to the projector's **Computer 2/Component Video** port.
2. Connect the red, green, and blue leads at the opposite end of the cable to the corresponding connectors on your video source.
3. If your video source has RCA audio, you can use the A/V cable to connect to the projector's **Audio L** (white) and **R** (red) jacks.

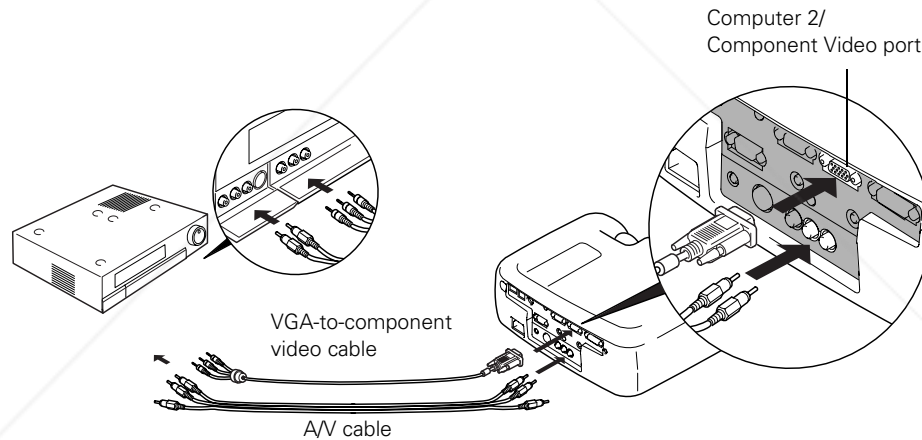

If your video source has a stereo mini-jack instead of RCA jacks, you can use a stereo mini-jack cable (not included). Connect it to the **Audio 1** jack on the projector.

4. If the image doesn't display properly, you may need to change the **Comp2/YCbCr** option in the projector's Setting menu (see page 56).

2

Using the Projector

Once you've connected the projector to your computer or other equipment (as described in Chapter 1 or Appendix A), you're ready to turn on the projector, adjust the image, and give your presentation.

Although you can operate the projector without it, the remote control lets you use additional features. See Chapter 3 for instructions on using the remote. This chapter covers the following:

- Turning on the projector and other equipment
- Adjusting the image
- Controlling the projector
- Shutting down the projector

Turning On Your Equipment

Make sure your projector and other equipment are set up and connected correctly, as described in Chapter 1 or Appendix A. Then turn on your projector, as described below, followed by any equipment you've connected to it. You can turn on your computer and video equipment in any order, but if you have more than one computer or video source connected, you may have to switch to the desired source as described on page 29.

Turning On the Projector

Follow these steps to plug in and turn on the projector:

1. If you're projecting video, first plug in and turn on your VCR, DVD player, or other video source. (If you're projecting from a computer, go to step 2.)
2. Connect one end of the power cord to the power inlet on the back of the projector.

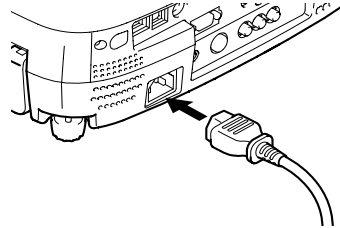

3. Connect the other end to a grounded electrical outlet.
The  power light on top of the projector turns orange, indicating that the projector is receiving power but not yet turned on.
4. Remove the lens cap.

5. Press the red **Power** button on top of the projector.

The power light flashes green as the projector warms up, and the projection lamp comes on in about 30 seconds. The power light stays green, and you may see a blue screen with the **No Signal** message displayed. This is normal.

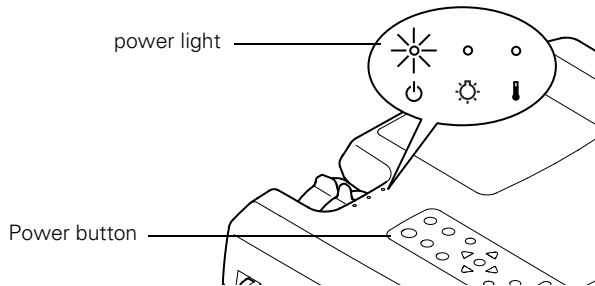

6. Do one of the following:

- If you're projecting from a computer, turn on or restart your computer. In a few moments, you should see your computer display projected.

If you see a New Hardware Wizard message saying that it has found a plug-and-play monitor, click **Cancel**. If you see a New Hardware Wizard message about USB audio, click **Next** and follow the instructions on the screen. (Windows only).

- If you're projecting a video, press the **Play** button on your video source.

If a projected image fails to appear, see the next section for help.

Once you see your image, turn to page 24 for instructions on focusing and making other image adjustments.

When you're done with your presentation, shut down the projector as described on page 30. Shutting down the projector correctly prevents premature lamp failure and possible damage to the projector from overheating.

warning

Never look into the lens when the lamp is on. This can damage your eyes, and is especially dangerous for children.

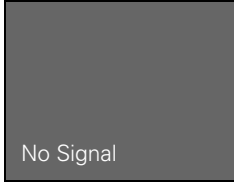



What To Do If You See a Blank Screen

If you see a blank screen or a blue screen with the **No Signal** message after turning on your computer or video source, try the following:

- Make sure the cables are connected correctly, as described on page 12 (for laptops) or in Appendix A (for other systems).
- Make sure the power light is green and not flashing and the lens cover is off.
- Try restarting your computer.
- If you've connected more than one computer and/or video source, you may need to press the **Computer/YCbCr** or **Video** button on the projector's control panel to select the correct source. (Allow a few seconds for the projector to sync up after pressing the button.)

If you're using a PC laptop:

- Press the function key that lets you display on an external monitor. It's often labelled with an icon such as  but it may also be labelled **CRT/LCD**. You may have to hold down the **Fn** key while pressing it. Check your laptop's manual or online help for details.

On most systems, the  key lets you toggle between the LCD screen and the projector, or display on both at the same time. Allow a few seconds for the projector to sync up after pressing it.

- Depending on your computer's video card, you might need to use the Display utility in the Control Panel to make sure that both the LCD screen and external monitor port are enabled. See your computer's documentation or online help for details.

If you're using a PowerBook or iBook with OS 9.x:

You may need to set up your system to display on the projector screen as well as the LCD screen. Follow these steps:

1. From the Apple menu, select **Control Panels**, then click **Monitors and Sound**.
2. Click the **Arrange** icon.

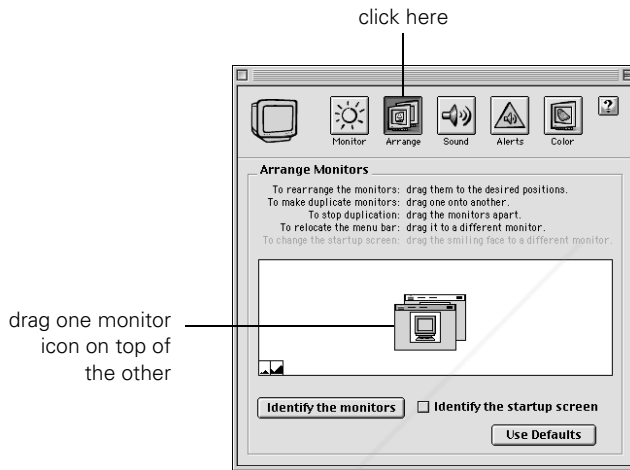

3. Drag one monitor icon on top of the other.

If the Arrange option isn't available, you may need to select one of the Simulscan resolution settings:

1. Click the **Monitor** icon.

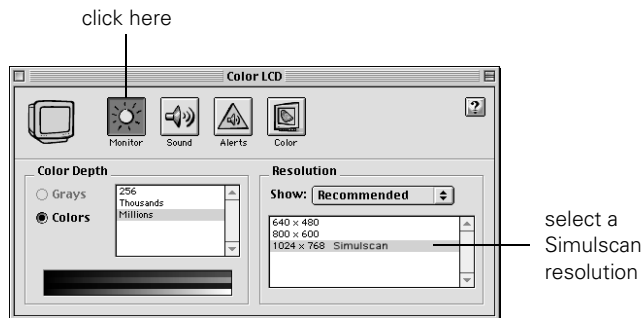

2. Select a Simulscan resolution as shown. (Allow a few seconds for the projector to sync up after making the selection.)

If you're using Macintosh OS X:

You may need to set up your system to display on the projector screen as well as the LCD screen. Follow these steps:

1. From the Apple menu, select **System Preferences**, then select **Displays**.
2. Make sure the **VGA Display** dialog box is selected.
3. Click the **Arrange** tab.

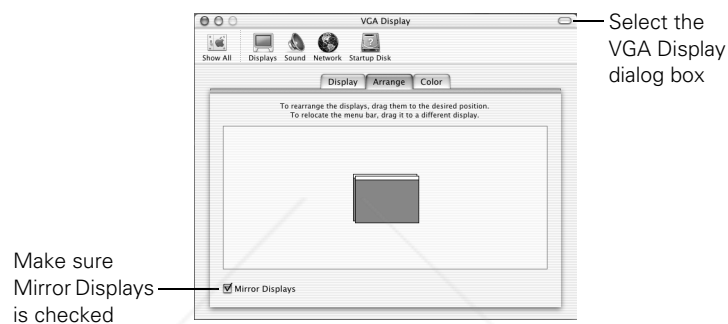

4. Make sure the **Mirror Displays** checkbox is selected.

Adjusting the Image

Once you see your image, you'll need to make certain adjustments:

- To focus or zoom your image, see below.
- If the image is too high or too low, you can reposition it. See page 26.
- If the image isn't square, see page 27.
- If only part of a computer image is displayed, you may need to press the **Resize** button. See page 28 for more information.
- If the projected image is flickering or "noisy," see page 28.

Focusing and Zooming Your Image

Rotate the focus ring to sharpen the image.

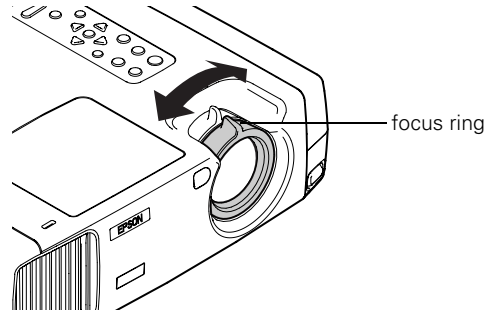

Rotate the zoom ring to reduce or enlarge the image.

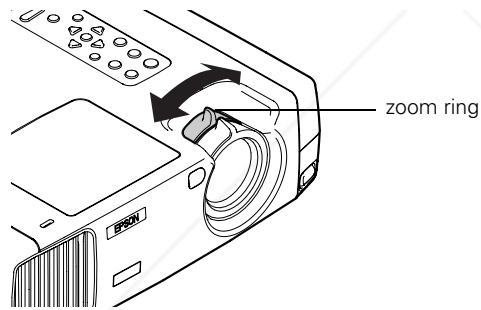

If the image still isn't large enough, you may need to move the projector farther away from the screen. You can also use the E-Zoom button on the remote control to zoom in on a portion of the image. See page 37 for instructions.

Adjusting the Height of Your Image

If the image is too low, you can raise it by extending the projector's foot.

1. Stand behind the projector. Press the foot release button and lift the front of the projector. This unlocks the foot.

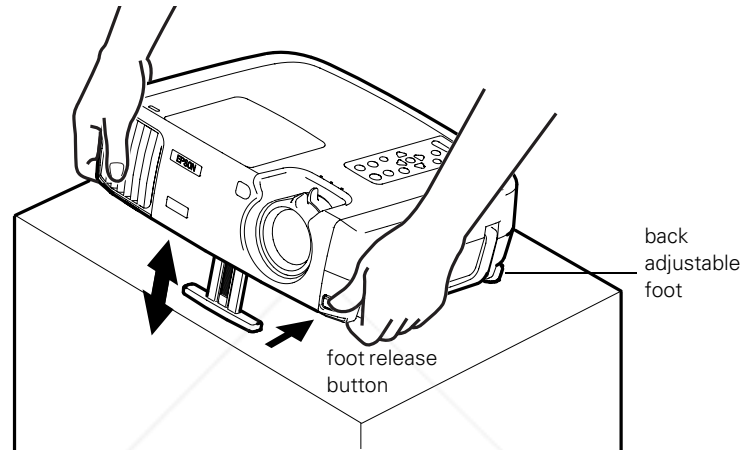



2. Once the image is positioned where you want it, release the button to lock the foot in position.
3. If you need to straighten the image, rotate the round adjustable foot at the back of the projector.



If the image is no longer square after raising it, see the next section.

Adjusting the Image Shape

If the projected image isn't square or has a "keystone" shape, do one or more of the following:

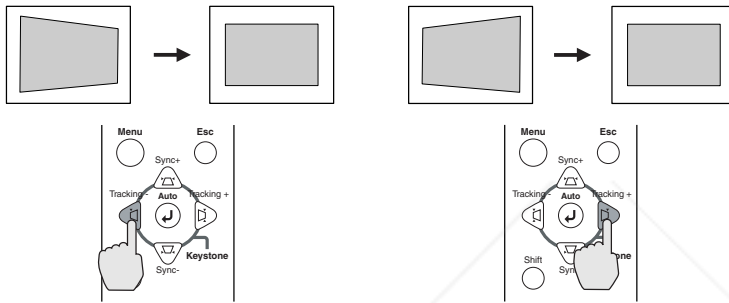
- If your image looks like  or , you've placed the projector off to one side of the screen, at an angle. Move it directly in front of the center of the screen, facing the screen squarely. If you still can't get a square image, press the left or right **Keystone** button on the projector's control panel:



- If your image looks like  or , press the top or bottom **Keystone** button to correct the shape of the image. After correction, your image will be slightly smaller.

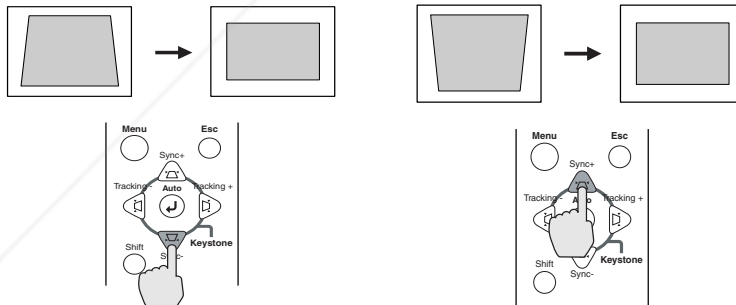

You can also perform electronic keystone correction using the projector's Setting menu. See page 55.

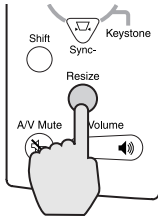

Resize button

Resizing the Image

Some computer images need to be resized to display in the projector's native resolution. If only part of your computer image is displayed, you can correct it with the **Resize** button.

- Press the **Resize** button on the projector's control panel (or on the remote control). The screen image is automatically compressed.
- Continue pressing the **Resize** button to pan around the screen in the original resolution.

If you're projecting from video equipment, pressing the **Resize** button switches the aspect ratio between 4:3 and 16:9. If you've zoomed in on your image (using the **E-ZOOM** button on the remote), you can press the **Resize** button to return it to the original display size.

Adjusting the Tracking and Synchronization

If you're projecting from a computer and displaying an image that contains a lot of detail (such as the text of a letter), you may notice one or more vertical stripes or bands, or some of the characters may look heavy or blurred. You can increase the clarity by pressing the **Auto** button on the projector's control panel (or the **Auto** button on the remote control). This resets the projector's tracking, sync, and position settings.

If further adjustment is needed, you can correct the image manually using the **Tracking** and **Sync** buttons as described on page 77.

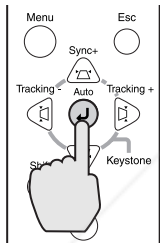

Auto button

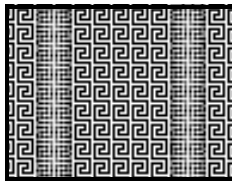

incorrect tracking

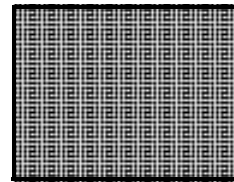

incorrect sync

Controlling the Projector

While giving your presentation, you may want to switch between picture sources, adjust the volume, or temporarily turn off the picture and sound. Follow the instructions below to access these features from your projector's control panel. You can also access these features, plus many others, using the remote control as described in Chapter 3.

Switching Between Picture Sources

If your projector is connected to more than one computer and/or video source, you can use the buttons on the control panel (or remote control) to switch between the different sources.

On the projector's control panel, press the **Computer/YCbCr** button to switch between computer sources and component video. Press the **Video** button to switch between standard (composite) video and S-Video.

After you select a source, the screen goes dark for a moment before the image appears.

Adjusting the Volume

If your presentation includes sound, you can adjust the volume from the projector's control panel.

- To increase the volume, press on the right side of the **Volume** button.
- To reduce the volume, press on the left side of the **Volume** button.

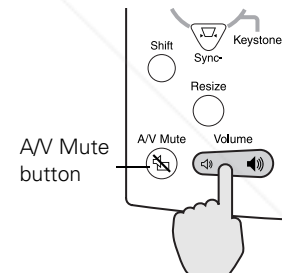
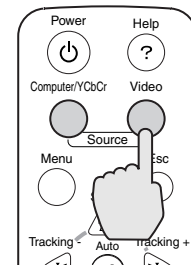

note

You can also have an image, such as a company logo, display on the screen whenever you press the A/V Mute button. See page 53 for instructions.

note

When the projector has not received any input signals for 30 minutes, it automatically turns off the projector lamp and enters "sleep mode." This conserves electricity, cools the projector, and extends the life of the lamp. If you are done using the projector, unplug the power cord. If you want to start projecting again, press the Power button.

Turning Off the Picture and Sound

You can use the A/V Mute button on the control panel to darken your screen and turn off the sound. This is useful if you want to temporarily re-direct your audience's attention without the distraction of a bright screen.

- To turn off the picture and sound, press the A/V Mute button. The screen goes dark.
- To turn the picture and sound back on, press the button again.

Shutting Down the Projector

When you've finished using the projector, follow the recommended procedure to shut it down. This extends the life of the lamp and protects the projector from possible overheating.

1. If you've connected a computer or laptop and it's displaying only through the projector (the computer's monitor is disconnected or turned off), shut down the computer first; otherwise you may not be able to see your computer's display to shut it down properly.
2. To turn off the projector, press the red Power button on the projector or remote control.

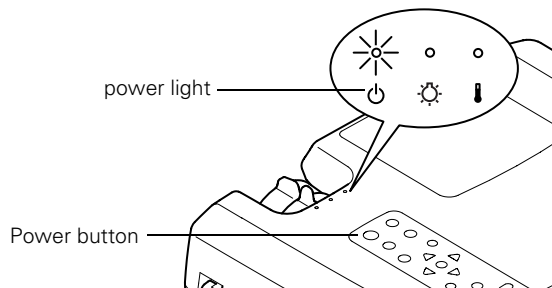

You see a confirmation message. (If you don't want to turn it off, press any other button.)

Power OFF?
Please press  Power key again
to power off.

3. Press the **Power** button again. The power light flashes orange for about a minute and a half as the projector cools down. When the projector has cooled, the orange light stays on and the exhaust fan shuts off.

If you want to turn the projector on again, wait until the orange light stops flashing. Then press the **Power** button.

4. If you extended the front foot, press the foot adjust button to retract it.
5. Replace the lens cap and unplug the power cord.
6. If you're using a VCR or other video source, turn it off after you turn off the projector.
7. Disconnect all equipment, and store the projector in a protective case.

caution

To avoid damaging the projector or lamp, never unplug the power cord when the power light is green or flashing orange.

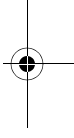
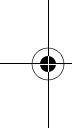
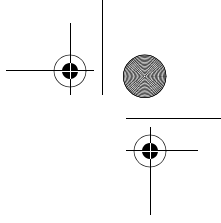
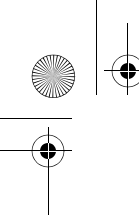

Discount-Merchant.com (800) 281-8860

THE TRUSTED SOURCE FOR PROJECTOR LAMPS AND ACCESSORIES

32 *Using the Projector*

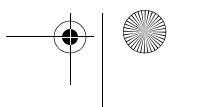
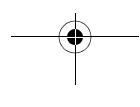
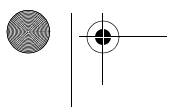
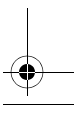
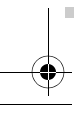

3

Using the Remote Control

The remote control lets you access your projector's features from anywhere in the room—up to 30 feet away. You can use it to turn the projector on and off, zoom in on a portion of your image, and highlight your presentation.

If you're using a computer and you've connected the mouse cable (as described in Chapter 1 or Appendix A), you can use the remote control as a wireless mouse.

This chapter covers the following information:

- Turning on and using the remote control
- Controlling the picture and sound
- Highlighting your presentation
- Using the remote control as a wireless mouse

Turning On and Using the Remote Control

caution

When replacing batteries, take the following precautions:

- Don't mix old and new batteries.
- Replace batteries as soon as they run out. If the batteries leak, wipe away battery fluid with a soft cloth. If fluid gets on your hands, wash them immediately.
- Do not expose batteries to heat or flame.
- Dispose of used batteries according to local regulations.
- Remove batteries if you won't be using the projector for a long period of time.

Before using the remote control, you need to install its batteries and turn it on as described below.

Installing Batteries

Follow these steps to install or replace the batteries:

1. Press the tab to release the battery compartment cover.
2. Remove the cover and insert the two AA batteries included with the projector as shown.
3. Replace the battery compartment cover.

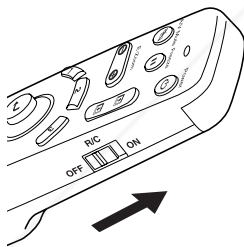
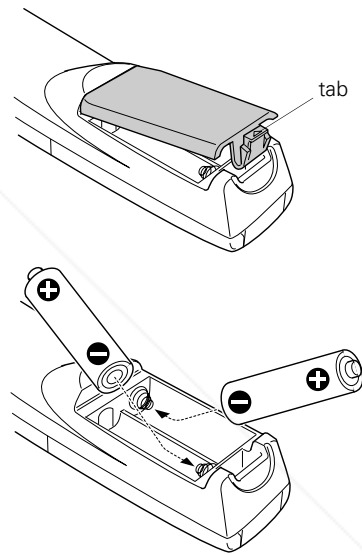

Turning On the Remote Control

Make sure batteries are installed. Then push up the on/off switch on the side of the remote control to turn it on.

Turn off the remote control before transporting it or storing it in a projector case. This prevents the batteries from discharging if something presses against one of the buttons.

Using the Remote Control

When using the remote control, stand within 30 feet of the projector. Point the remote control either at the front or back of the projector or at the screen (the projector's front sensor can detect signals bounced off the screen).

- Press the button for the function you want to use. See the following pages for instructions.
- For some functions, you need to use the  button like a mouse to navigate on the screen. Press the edge of the button with your thumb—or grasp it between your thumb and finger and tilt it in the direction you want to move.



Controlling the Picture and Sound

You can use the remote control to select your source, adjust the volume, temporarily turn off the picture and sound, freeze the action, zoom in on the picture, or display a picture-in-picture video image. Make sure you have set up your projector and connected any equipment as described in Chapter 1 or Appendix A.

Switching Between Picture Sources

If you've connected your projector to a computer and/or video sources, you can use the buttons on the remote control to switch between the different sources.

- Press the **Comp2/YCbCr** button to select a computer or video source connected to the Computer 2/Component Video port on the projector.
- Press the **Comp 1** button to select a computer connected to the DVI Computer 1 port on the projector.
- Press the **Video** button to select a composite video source.
- Press the **S-Video** button to select an S-Video source.

After you select a source, the screen goes dark for a moment before the image appears.

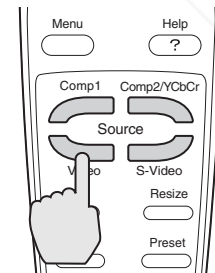

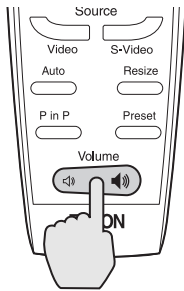

Adjusting the Volume

If you've connected an audio source to the projector, you can adjust the sound that's output through the projector's speakers.

- To increase the volume, press on the right side of the **Volume** button.
- To reduce the volume, press on the left side of the **Volume** button.

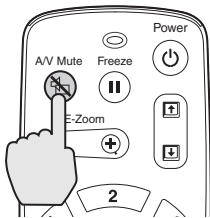

Turning Off the Picture and Sound

You can use the **A/V Mute** button on the remote control to turn off the image and sound and darken your screen. This is useful if you want to temporarily re-direct your audience's attention without the distraction of a bright screen.

- To turn off the picture, press the **A/V Mute** button. The screen goes dark.
- To turn the image back on, press the button again.

You can also have an image, such as a company logo, display on the screen whenever you press the **A/V Mute** button. See page 53 for instructions.

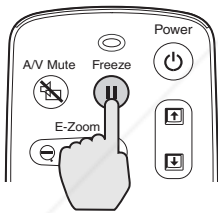



Stopping Action

You can use the remote control to stop the action in your video or computer image.

- Press the **Freeze** button to stop the action and keep the current image on the screen. The sound will continue.
- Press the **Freeze** button again to re-start it.

Zooming Your Image

You can zoom in on a portion of the image using the E-Zoom button on the remote control.

1. Press the E-Zoom button.
 - A crosshair indicating the center of the zoom-in area appears on the screen.
2. Use the  button to move the crosshair where you want it.
3. Press the right side of the E-Zoom button to enlarge the selected area.
 - Press the button repeatedly to enlarge it up to four times in 25 steps.
 - Press and hold the button to zoom in to the size you want.
 - You can use the  button to scroll around the image.
4. Press the left side of the E-Zoom button to zoom out. You can also press the **Resize** or **Esc** button to return to the original size.

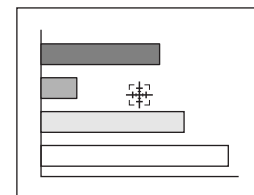
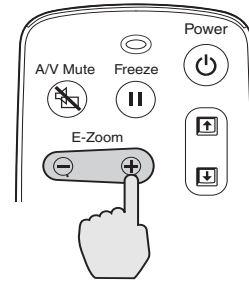

Resizing the Image

Some computer images need to be resized to display in the projector's native format—1024 × 768 pixels. If only part of your computer image is displayed, you can correct it with the **Resize** button.

- Press the **Resize** button on the remote control (or on the projector's control panel). The screen image is automatically compressed.
- Continue pressing the **Resize** button to pan around the screen in the original resolution.

If you're projecting from video equipment, pressing the **Resize** button switches the aspect ratio between 4:3 and 16:9. If you've zoomed in on your image (using the E-Zoom button on the remote), you can press the **Resize** button to return it to the original display size.

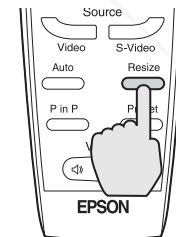



Displaying Picture-in-Picture Video

You can open a small video window on your computer image, and view a video at the same time as your computer presentation. If you're using component video, you can display a second video (from a composite or S-Video source) in the window.

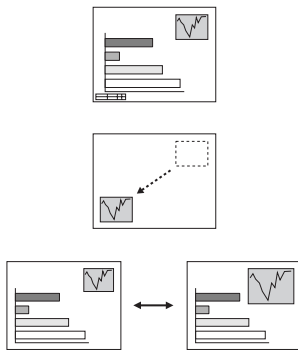
First make sure you have connected your VCR or other video sources as described in Chapter 1. If you're using S-Video, you need to select it in the P in P menu option as described on page 55.



1. Press the P in P button on the remote control. The screen may go dark for a moment, and then your video image appears in a small window on the screen. A menu appears in the lower left corner of the screen, describing how to move and resize the image.
2. Use the  button to reposition the video window on the screen.
3. Press the E-Zoom button to enlarge or reduce the video window.
4. When the window is located and sized the way you want, press the  button. The menu disappears, and your video plays on the screen.

note

You can use the Effects buttons to switch between sounds for the presentation and video. Press Effect 1 for the main screen; press Effect 2 for the video.



video window

5. When you're finished viewing the picture-in-picture, press the P in P button again. The video window disappears.

Highlighting Your Presentation

You can highlight areas on the screen using the numbered buttons on the remote control. You can use these “special effects” features to annotate your presentation slides or call attention to your most important points. The following three highlighting tools are available:

- Pointer or cursor stamp (button 1)
- Spotlight (button 2)
- Bar (button 3)

You can customize the highlighting tools through the Effect menu. See page 52 for instructions.

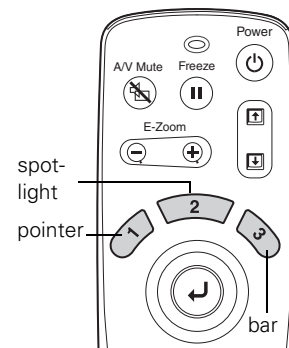

Using the Pointer

You can choose from three types of pointers and place them anywhere on your screen.

1. To activate the pointer tool, press button 1 on the remote control. A pointing hand appears in the center of the screen. To change it to an arrow, press 1 again. Press 1 a third time to see a different arrow.
2. Press the side of the ↵ button (or grasp it between your thumb and finger) to move the arrow wherever you want it.
3. To “paste” the pointer on the screen, press down in the center of the ↵ button. You can then continue to work with another pointer, moving it around the screen or pasting it wherever you want.
4. To erase the pointer(s) pasted on the screen and cancel the effect, press Esc.

note

You can use the projector's Effect menu to select different pointers. See page 52.

Spotlighting Your Image

With the Spotlight tool, you can highlight part of the screen.

1. To activate the spotlight tool, press button **2** on the remote control. A square spotlight appears on the image.

You can continue pressing button **2** to switch between three spotlight sizes.

2. Use the **↔** button to move the spotlight where you want it.
3. To remove the spotlight, press **Esc**.

You can change the default size of the spotlight using the Effect menu; see page 52.

Using Horizontal and Vertical Highlights

With the bar tool, you can draw bold horizontal or vertical lines on the screen to underline or highlight your presentation points. You can choose from three types of bars.

1. To activate the bar tool, press button **3** on the remote control. A horizontal bar appears across the screen. If you want a vertical bar, press **3** again. If you want to try another horizontal bar, press **3** again.
2. Use the **↔** button to move the bar up and down the screen (or left and right if you are using the vertical bar).
3. To cancel the bar drawing feature, press **Esc**.



note

You can change the color and width of the bars using the Effect menu. See page 52.

Using the Remote Control as a Wireless Mouse

When you use the remote control as a wireless mouse, you can control your computer or click through slideshow-style presentations (such as PowerPoint) from up to 30 feet away. This gives you more flexibility, since you won't need to stand near your computer to change slides, for example.

To control your computer with the remote, make sure you have connected the mouse cable between the projector and your computer as described on page 13 (for laptops) or in Appendix A (for other systems).

- To move the mouse pointer on the screen, aim the remote at the screen and press on the edge of the  button with your thumb—or grasp it between your thumb and finger and tilt it in the direction you want to move. This button works like the mouse button on many laptop keyboards.
- To click (or left-click), press the left mouse button below the  button. Or, press down on the center of the  button. This changes slides in a PowerPoint presentation in Slide Show mode.
- To right-click, press the Esc button.

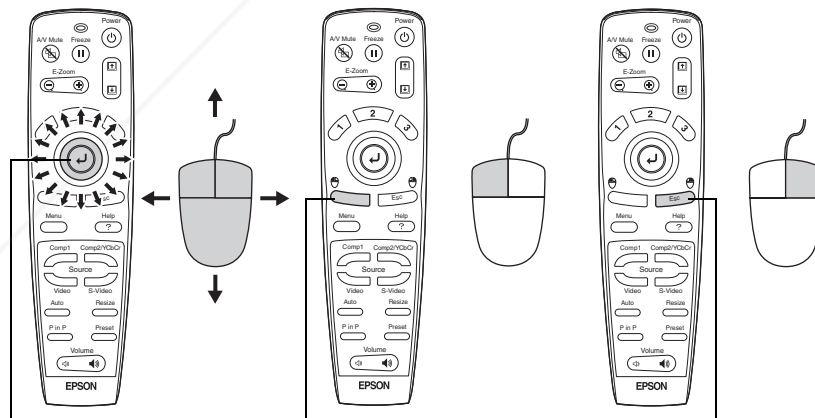

Use the  button to move the mouse pointer

To left-click, press the left mouse button

To right-click, press Esc

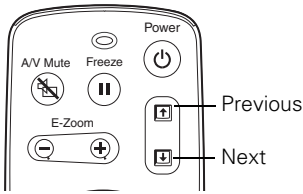

- To double-click, press down twice on the left mouse button.
- To click and drag, press down on the left mouse button and then tilt the ↵ button in the direction you want to drag.

You can use the up and down arrow buttons on the remote control to move the cursor or move through a PowerPoint presentation. This works only when you use the USB mouse cable.

- Press the down arrow to move forward through a presentation or display the next slide.
- Press the up arrow to move backward or display the previous slide.

4 *Fine-tuning the Projector*

You can use the projector's on-screen menus to adjust the image, sound, and other features. You can also create your own startup screen, customize the highlighting tools, and find out how long your lamp has been in use. This chapter covers the following information:

- Using the menu system
- Adjusting the image
- Adjusting the sound
- Customizing the highlighting controls
- Creating your own startup screen
- Customizing projector features
- Viewing lamp usage and other information
- Restoring the default settings

Using the Projector's Menu System

The eight projector menus let you adjust and customize the projector features from either the control panel or remote control:

- The Video menu controls the look and quality of the projected image. It lets you adjust the image position and fine-tune settings such as Brightness, Sharpness, and Contrast.
- The Audio menu controls the volume level, treble, and bass settings.
- The Effect menu lets you change the cursor speed and modify the highlighting tools available on the remote control.
- The Setting menu allows you to set or adjust features such as the Picture in Picture (P in P) video source, blank screen color, A/V Mute display option, and sleep mode.
- The User's Logo menu lets you capture and store a custom image or logo which you can then use as a startup screen or with the A/V Mute option.
- The Advanced menu lets you specify additional projector settings, including menu language, startup screen, color setting, and rear or ceiling projection.
- The About menu provides information about lamp status and computer or video settings.
- The Reset All menu lets you restore the factory defaults for all the projector settings.

Changing Menu Settings

You can use the buttons on the control panel or remote control to access the menus and change settings. Follow these steps:

1. To display the menu screen, press the **Menu** button on the control panel or the remote control.

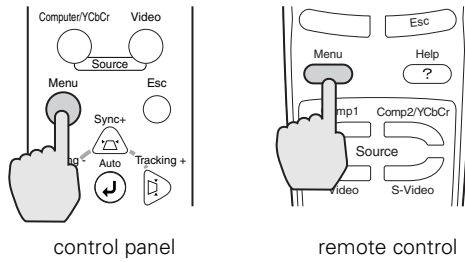

You see the menu screen:

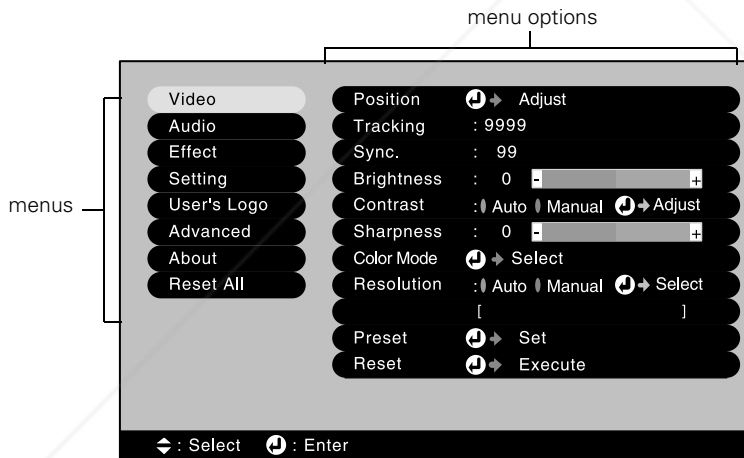

The eight menus are listed on the left, and the options available for the highlighted menu are shown on the right.

2. Press the **Sync+** or **Sync-** button on the control panel, or press up or down on the **Up/Down** button on the remote control, to scroll through the menu list.
3. When the menu you want is highlighted, press the **Enter** button on the control panel or the remote control to select it. The highlight moves to the first option for that menu.









FixYourDLP.com
Sponsored by

Discount-Merchant.com (800) 281-8860

THE TRUSTED SOURCE FOR PROJECTOR LAMPS AND ACCESSORIES *Fine-tuning the Projector* 45

note

If you want to go back to the default settings on any menu, select Reset, press ↵, select Yes, and then press ↵.

4. Use the  Sync+ or  Sync- button (control panel) or the  button (remote control) to scroll through the list of options. (If a computer or video source isn't connected, certain options may be unavailable.)
5. Use the  Tracking- or  Tracking+ button (control panel) or the  button (remote control) to change the setting for the selected option.
Enabled settings are indicated by a green light, while disabled ones are blank.
6. Press the Esc button to return to the main menu. Your changes are saved automatically.
7. Press Esc again (or the Menu button) to exit the menu system.

Adjusting the Image

The Video menu lets you make adjustments to the projected image. The options available in the menu depend on which source is connected to the projector: standard computer video (analog RGB), DVI computer video (digital RGB), composite or S-Video, component video, or RGB video (standard TV).

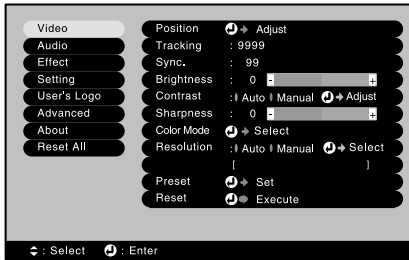

Video menu for standard computer display (Analog-RGB)

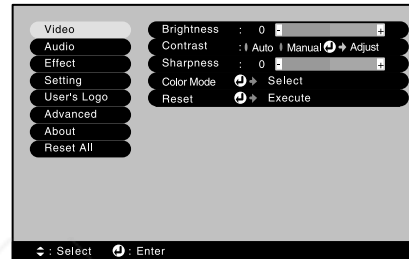

Video menu for DVI computer display (Digital-RGB)

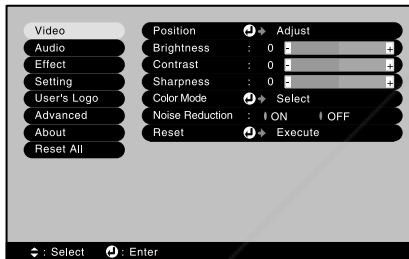

Video menu for RGB-Video

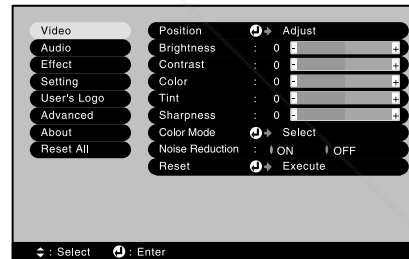

Video menu for component video

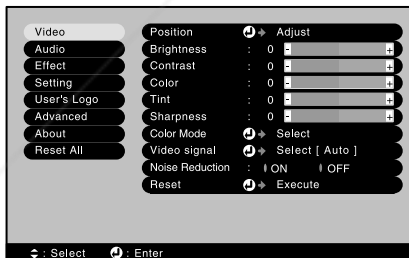

Video menu for composite video or S-Video

note

If you have repositioned the image or adjusted the sync setting, you can use the ↵ button on the control panel or the Auto button on the remote control to restore the default settings.

Repositioning the Image

Follow these steps to move the image to a different position:

1. Press the **Menu** button. You see the menu screen.
2. Press the ↵ button to select the Video menu.
3. Press ↵ to select the **Position** option. You see a positioning screen.
4. Use the **Tracking** and **Sync** buttons (control panel) or the ↵ button (remote control) to move the image left, right, up, or down.
5. When the image is positioned the way you want, press **Esc** to exit.

Adjusting Image Appearance

Follow these steps to adjust the appearance of your image:

1. Press the **Menu** button. You see the menu screen.
2. Press the ↵ button to select the Video menu.
3. Use the **Tracking** and **Sync** buttons (control panel) or the ↵ button (remote control) to set the following options:
 - **Tracking (analog computer images only)**
Removes unwanted vertical lines from a computer image by matching the projector's internal clock to the computer display signal.
 - **Sync (analog computer images only)**
Corrects fuzziness by synchronizing the projector with the tracking signal sent from the computer.
 - **Brightness**
Lightens or darkens the overall image.
 - **Contrast**
Adjusts the difference between light and dark areas. When **Auto** is selected (the default), the projector performs gain adjustment periodically.
 - **Color (video only)**
Adjusts the color depth or intensity of the image.

- **Tint (NTSC video only)**
Adjusts the balance of green to magenta in the image.
 - **Sharpness**
Adjusts the sharpness of the image.
 - **Color Mode**
Corrects the vividness of image color. You can select from the following six settings, and save a different one for each computer and/or video source:
 - sRGB:** To use the sRGB standard for computer displays (the default when projecting from a computer with analog video)
 - High Brightness:** For presentations in bright rooms
 - Meeting:** For projecting without color enhancement
 - Presentation:** For presentations in dark rooms
 - Theater:** For optimizing movie images with natural color (the default for video or S-Video display)
 - Amusement:** For optimizing games
 - **Resolution (analog computer images only)**
Leave this setting at **Auto** to allow the projector to detect the video signal automatically. If the projector is unable to sync up with the computer, select **Manual** and choose one of the settings.
 - **Video Signal (video only)**
Leave this setting at **Auto** unless you are using a 60-hertz PAL system (select **PAL60**).
 - **Noise Reduction (video only)**
Reduces visual “noise.” This is especially useful when text and video images are combined, as in movies with subtitles.
4. When the image is set correctly, press **Esc** or **Menu**. Your settings are automatically saved.

Saving and Recalling Computer Settings

When you are projecting from an analog computer source, you can save and recall settings (resolution, tracking, sync signal, and position) in up to five different combinations. This is useful if you use more than one computer with the projector; you can save the settings for each one and recall them when necessary. Follow these steps to save the projector's current settings:



1. Press the **Menu** button to display the Main menu.
2. Press the **↵** button to select the Video menu.
3. Use the **▽** **Sync-** button (control panel) or the **↵** button (remote control) to move down to the **Preset** option.
4. Press **↵**. You see the Preset Selection menu with the current resolution setting displayed.
5. Use the **▽** **Sync-** button (control panel) or the **↵** button (remote control) to select the number to which you want to assign the current settings.
6. Press **↵**. If you see an **Overwrite?** prompt, select **Yes** and press **↵**.
7. Press **Esc** or **Menu** to exit.

When you want to use a saved setting, press the **Preset** button on the remote control. You see the selected setting displayed on the screen.



To select another number, press the **Preset** button again until the setting number you want is displayed. The projector resets itself according to the selected setting.

Adjusting the Sound

You can use the Audio menu to select the audio source or adjust the sound volume or treble/bass balance.

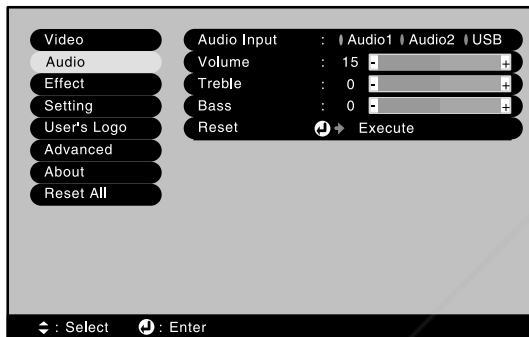

1. Press the **Menu** button. You see the menu screen.
2. Use the  **Sync-** button (control panel) or the  button (remote control) to highlight **Audio**. You see the following:





3. Press  to select the Audio menu.
4. Use the **Tracking** and **Sync** buttons (control panel) or the  button (remote control) to set the following options:
 - **Audio Input**
Audio 1 is automatically selected for computer sound, and Audio2 for video. Select **USB** to amplify computer sound through a USB cable connected to the projector.
 - **Volume**
 - **Treble**
 - **Bass**
5. When you're finished adjusting the sound, press **Esc** or **Menu**.

Customizing the Highlighting Tools

The highlighting tools let you add pointers and other types of annotations to your image, as described on pages 39 to 41. You can use the Effect menu to customize these tools and set the pointer speed for highlighting. The **Reset** option lets you return all the highlighting tools to their default settings.

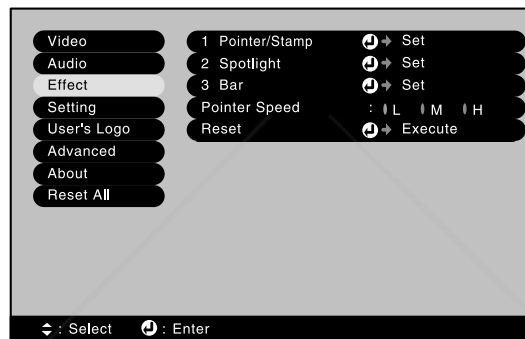
1. Press the **Menu** button. You see the main menu.
2. Use the  **Sync** button (control panel) or the  button (remote control) to highlight **Effect**. You see the Effect menu:



3. Press  to select the **Effect** menu.
4. Use the **Tracking** and **Sync** buttons (control panel) or the  button (remote control) to customize the following:
 - **Pointer/Stamp**
Lets you define the shape and size for three different pointers.
 - **Spotlight**
Lets you choose a large, medium, or small spotlight.
 - **Bar**
Lets you define three different bars. For each one, you can set the color and width, and choose between vertical and horizontal.
 - **Pointer speed**
Lets you choose low, medium, or high speed.
5. When you're finished customizing the highlighting tools, press **Esc** or **Menu**. Your selections are saved.

Creating Your Own Startup Screen

You can transfer any image from your computer or video source to the projector, and then use it as your startup screen. You can also use it as the screen displayed when the projector is not receiving a signal or when you press the **A/V Mute** button. The image can be a company logo, slogan, photograph, or any other image you want to use.

Capturing the Image

Start by displaying the image you want to use. It can be an image from either a computer or video source such as a DVD player or digital camera. Then follow these steps to capture the image and transfer it to the projector:

1. Press the **Menu** button on the control panel or remote control. You see the menu screen.
2. Use the **Sync-** button (control panel) or the **↵** button (remote control) to highlight the **User's Logo** menu, then press **↵**.

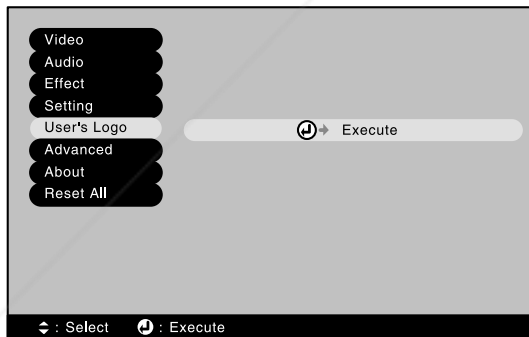

3. When you see the screen shown at right, select **Yes** and press **↵**. A selection box displays over the image.
4. Use the **Tracking** and **Sync** buttons (control panel) or the **↵** button (remote control) to select the area of the image you want to use. Then press **↵**.

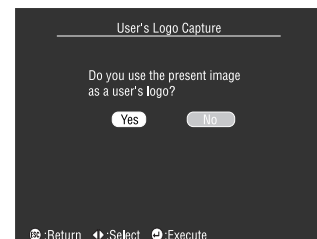



- When you see the message “Do you use this image?” select **Yes** and press **↵**.

You see the screen shown at the left.

- Use the **Tracking** and **Sync** buttons (control panel) or the **↵** button (remote control) to select a zoom rate (display size), and then press **↵**.
- When the message “Do you save the user’s logo?” appears, select **Yes** and press **↵**.

Saving the logo may take a few moments. Do not use your projector or video source (computer, DVD player, etc.) while the logo is being saved.

- When you see the message “Saving the user’s logo is completed,” press **Esc** to return to the menu screen.

note

You can also set up your image as the startup screen using the Advanced menu; see page 57.

Choosing When to Display the Image

After your image is saved, you can set it up as the no-signal message and/or the screen that’s displayed when you press **A/V Mute**.

- Press the **Menu** button to display the menu screen (if not already displayed).
- Use the **▽ Sync-** button (control panel) or the **↵** button (remote control) to highlight the **Setting** menu.
- Press the **↵** button to select the Setting menu.
- Use the **▽ Sync-** button (control panel) or the **↵** button (remote control) to highlight either **No-Signal Msg.** or **A/V Mute**, depending on when you want the image to display.
- Use the **▷ Tracking+** button (control panel) or the **↵** button (remote control) to select **Logo**. This sets your image as the screen to be displayed.
- When you’re finished, press **Esc** or **Menu** to exit.

Customizing Projector Features

You can use the Setting menu to disable the projector's sleep mode, adjust the image shape, and customize several other features.

1. Press the **Menu** button.
2. Use the **Sync** button (control panel) or the **↵** button (remote control) to highlight **Setting**. You see the options and their settings on the right side:

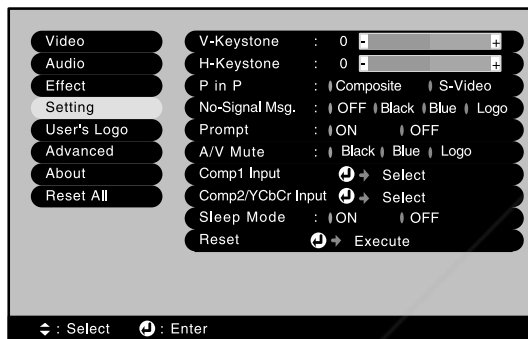

3. Press **↵** to select the Setting menu.
4. Use the Tracking and Sync buttons (control panel) or the **↵** button (remote control) to set the following options:
 - **V-Keystone or H-Keystone**
Correct the shape of the image. Keystone correction makes the image smaller, especially if you use both vertical (V-Keystone) and horizontal (H-Keystone) correction. If you need to adjust the shape in both directions, adjust the vertical first. If the image looks uneven after you adjust the shape, decrease the Sharpness setting (see page 49).
 - **P in P**
Selects the source used by the picture-in-picture display (standard composite video or S-Video).
 - **No-Signal Msg.**
Selects a screen color or image to display when the projector is not receiving a signal. The logo setting displays an image that you have transferred to the projector (see page 53).

- **Prompt**
Turns off the identifying text that appears briefly when you switch picture sources. (It's best to leave this on.)
 - **A/V Mute**
Selects the screen color or image to display when you press the **A/V Mute** button. The logo setting displays an image that you have transferred to the projector (see page 53).
 - **Comp1 Input**
Specifies the format for input to the **Computer1** port. Select **Digital-RGB/Analog-RGB**, **Analog-RGB**, or **RGB-Video**.
 - **Comp2/YCbCr Input**
Specifies the format for input to the **Computer 2/ Component Video** port. If the source is a computer, select **Analog-RGB**. If the source is a video device, select **YCbCr** for DVD images or **YPbPr** for progressive scan DVD or HDTV images.
 - **Sleep mode**
When sleep mode is on, the projector turns off the lamp if it has not received any input signals for 30 minutes. Turn sleep mode off if you want the lamp to remain on all the time.
5. When you're finished, press **Esc** or **Menu**.

Setting Advanced Features

You can use the Advanced menu to configure the projector for rear projection or ceiling mounting, and adjust several other features.

1. Press the **Menu** button.
2. Use the **Sync-** button (control panel) or the **←** button (remote control) to highlight **Advanced**. You see the features and their settings on the right side:

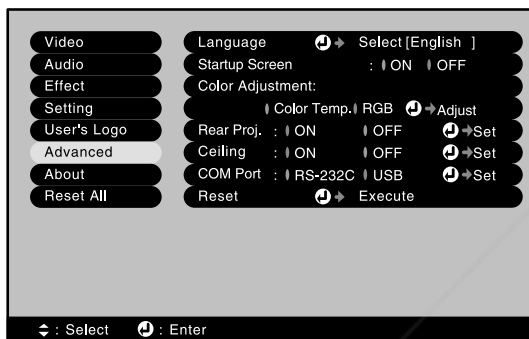

3. Press **←** to select the **Advanced** menu.
4. Use the **Tracking** and **Sync** buttons (control panel) or the **←** button (remote control) to set the following options:
 - **Language**
Select from 9 languages to be used for the projector menus.
 - **Startup Screen**
Turn on to display your captured image or logo whenever the projector starts. (See page 53 for more information.)
 - **Color Adjustment**
Adjusts the color temperature of the projected image. Select **Color Temp.** to set a temperature between 5000 and 10000 K. Select **RGB** to adjust individual red, green, and blue values, as shown. (Not available if **sRGB** is selected as the Color Mode setting in the Video menu. See page 49 for more information.)

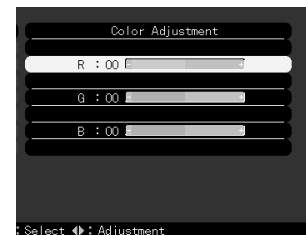

■ Rear Proj.

Turn on to project from behind onto a transparent screen.



- **Ceiling**
Turn on when the projector is mounted upside-down from the ceiling.
 - **COM Port**
Switches between serial (RS-232C) and USB communication for programming/projector control.
5. When you're finished, press Esc or Menu.

Viewing Lamp Usage and Other Information

Use the About menu to view information about the display settings of your computer and the number of hours the lamp has been used.

note

If you access the About menu when the projector display is set to video, you see only the lamp life and the video signal setting.

1. Press the **Menu** button. You see the main menu.
2. Use the  **Sync-** button (control panel) or the  button (remote control) to highlight **About**.

You see the lamp usage hours and computer display settings on the right:

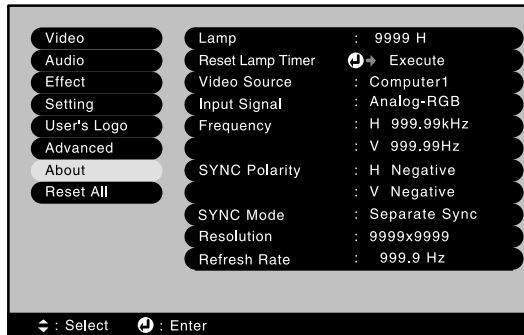

The life span of the lamp is about 1500 hours. If the number shown is close to 1500, make sure you have a spare lamp handy.

After you change the lamp, you need to reset the lamp timer.

note

The lamp usage timer doesn't register until you've used the lamp for at least 10 hours.



Discount-Merchant.com (800) 281-8860

THE TRUSTED SOURCE FOR PROJECTOR LAMPS AND ACCESSORIES

3. If you have changed the lamp, press **↵** to select **Reset Lamp Timer**. Press **↵** again, then select **Yes** when you see the prompt. Press **↵** to confirm the reset.
4. When you're finished, press **Esc** or **Menu**.

Restoring the Default Settings

The Reset All option lets you return all the projector settings to their default values.

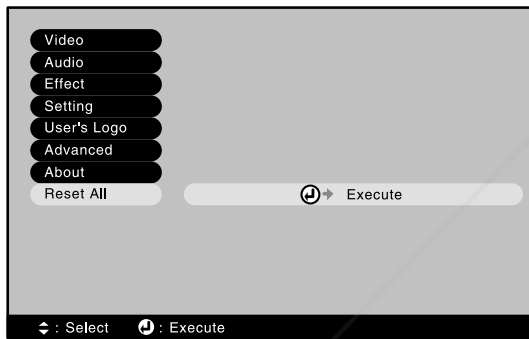

Select **Reset All** and press the **↵** button on the control panel or remote control to display the confirmation screen. Select **Yes** to reset all the default settings or **No** to cancel.

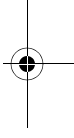
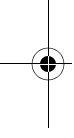
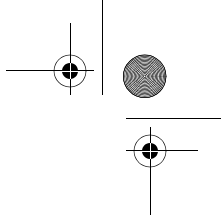
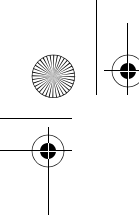

Discount-Merchant.com (800) 281-8860

THE TRUSTED SOURCE FOR PROJECTOR LAMPS AND ACCESSORIES

60 *Fine-tuning the Projector*

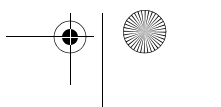
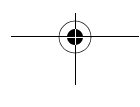
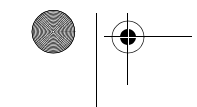
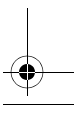
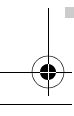

5

Maintaining and Transporting the Projector

warning

Before you clean any part of the projector, turn it off and unplug the power cord. Never open any cover on the projector, except the lamp and filter covers. Dangerous electrical voltages in the projector can injure you severely. Do not try to service this product yourself, except as specifically explained in this User's Guide. Refer all other servicing to qualified service personnel.

Your projector needs little maintenance. All you need to do on a regular basis is keep the lens clean. Any dirt or smears on the lens may show up on your projected image.

You also need to periodically clean the air filter on top of the projector. A clogged air filter can block ventilation needed to cool the projector and keep it from overheating.

The only parts you should replace are the lamp and air filter. If any other part needs replacing, contact your dealer or a qualified servicer.

This chapter covers the following:

- Cleaning the lens
- Cleaning the projector case
- Cleaning and replacing the air filter
- Replacing the lamp
- Transporting the projector

Cleaning the Lens

Clean the lenses whenever you notice dirt or dust on the surface.

- Use a canister of compressed air to remove dust.
- To remove dirt or smears on the lenses, use lens-cleaning paper. If necessary, moisten a soft cloth with lens cleaner and gently wipe the lens surface.

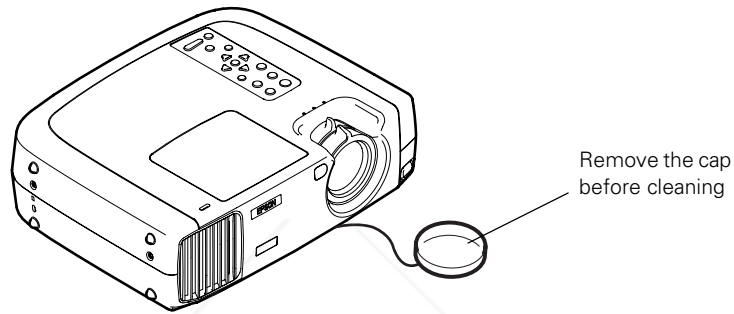

Cleaning the Projector Case

Before you clean the case, first turn off the projector and unplug the power cord.

- To remove dirt or dust, wipe the case with a soft, dry, lint-free cloth.
- To remove stubborn dirt or stains, moisten a soft cloth with water and a neutral detergent. Then wipe the case.
- Do not use wax, alcohol, benzene, thinner, or other chemical detergents. These can damage the case.

Cleaning and Replacing the Air Filter

Clean the air filter on the bottom of the projector after every 100 hours of use. If it is not cleaned periodically, it can become clogged with dust, preventing proper ventilation. This can cause overheating and damage the projector. To clean the air filter, follow these steps:

1. Turn off the projector, allow it to cool down, and unplug the power cord.
2. Stand the projector on end with the handle on top to keep dust and dirt from falling inside.
3. To clean the filter, EPSON recommends using a small vacuum cleaner designed for computers and other office equipment. If you don't have one, gently clean the filter using a very soft brush (such as an artist's camel-hair brush).

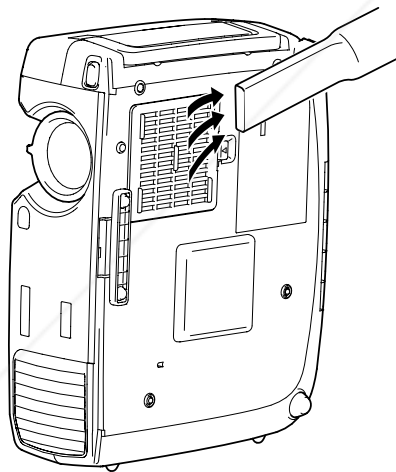

If the dirt is difficult to remove or if the filter is broken, replace it. Contact your dealer or call EPSON at (800) 873-7766 in the United States to obtain a new one. In Canada, please call (800) 463-7766 for dealer referral.

note

When you get a replacement lamp for your projector, a new air filter is included. You should replace the filter when you replace the lamp.

4. If you need to replace the filter, press the arrow tab and lift up the filter to remove it.

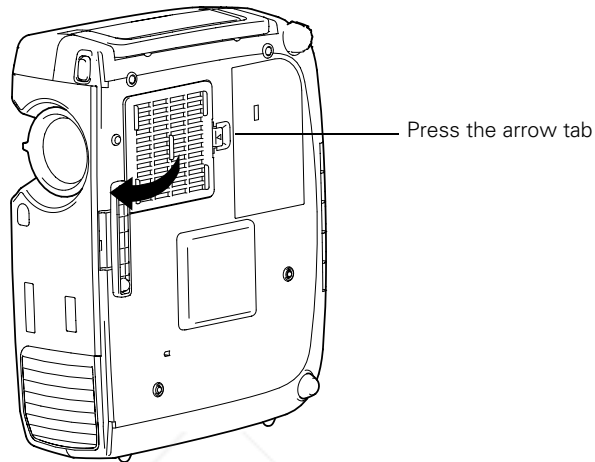

5. To install a new filter, first insert the tabs, then press down until it clicks in place.

warning

Be extremely careful when removing the lamp module. In the unlikely event that the bulb has ruptured, small glass fragments may be present and should be removed with caution.

If your projector is mounted on the ceiling, you should unmount it before accessing the lamp compartment. This will make it easier for you to replace the lamp and minimize the chance of any small glass fragments dropping from the projector.

Replacing the Lamp

The projection lamp typically lasts for about 1500 hours of use. It is time to replace the lamp when:

- The projection image gets darker or starts to deteriorate.
- The lamp warning light  is red or flashing red.
- The message LAMP REPLACE appears on the screen when the lamp comes on (after about 1400 hours of use). To maintain projector brightness and image quality, replace the lamp as soon as possible.

Contact your dealer or call EPSON at (800) 873-7766 in the United States for a replacement lamp. Request part number V13H010L15. In Canada, please call (800) 463-7766 for dealer referral

Follow these steps to replace the lamp:

1. Turn off the projector, wait for it to cool down (when the light stops flashing), then unplug the power cord.
2. Allow the projector to cool for at least half an hour (if it has been on).
3. Use a screwdriver to slide the latch and pop open the lamp cover. Then lift up and remove it.

warning

Let the lamp cool before replacing it. If the lamp breaks, handle the shards carefully to avoid injury.

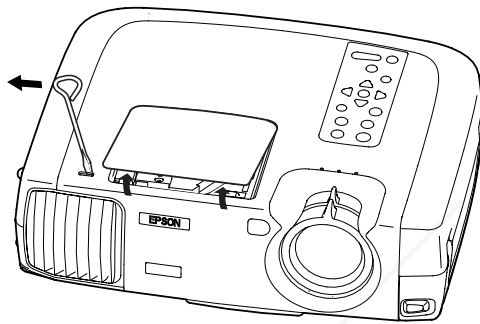

4. Use a screwdriver to loosen the two silver screws holding the lamp in place. (You can't remove these screws.)

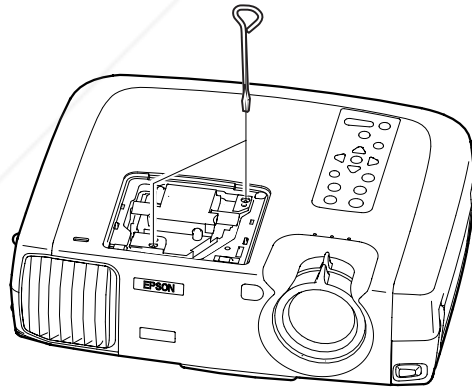

caution

Do not touch the glass portion of the lamp assembly. Touching the glass could result in premature lamp failure.

5. Grasp the lamp as shown and pull it straight out.

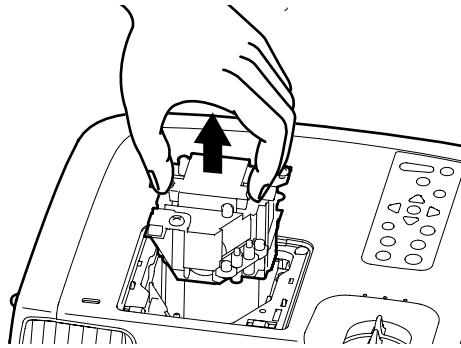

6. Gently insert the new lamp.
7. Once the lamp is fully inserted, tighten its screws.
8. To replace the lamp cover, insert the tabs and then snap the cover into place. (The projector won't come on if the lamp cover is loose.)

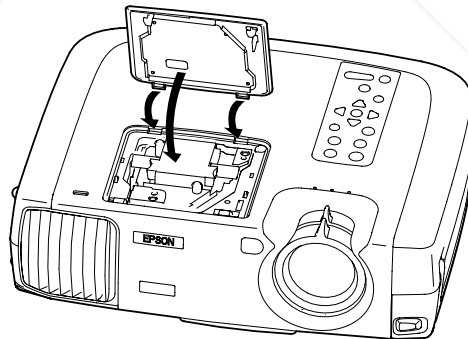

Resetting the Lamp Timer

After you replace the lamp, you need to reset the lamp timer using the projector's menu.

1. Press the **Menu** button on the control panel or the remote control. You see the main menu.
2. Use the **Sync-** button (control panel) or the **↵** button (remote control) to highlight **About**.
You see the lamp usage hours and other settings.
3. Press **↵** to select **Reset Lamp Timer**. Press **↵** again. You see this prompt:
4. Select **Yes**, then press **↵**.
5. When you're finished, press **Esc** or **Menu**.

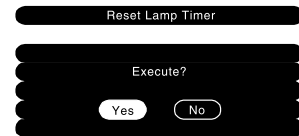

Transporting the Projector

note

EPSON shall not be liable for any damages incurred during transportation.

The projector contains many glass and precision parts. If you need to transport it, follow these packing guidelines to prevent damage to the projector:

- When shipping the projector for repairs, use the original packaging material if possible. If you do not have the original packaging, use equivalent materials, placing plenty of cushioning around the projector.
- When transporting the projector a long distance, first put it in a carrying case (such as an optional EPSON case), then pack it in a firm box, using cushioning around the case.
- If you want to store the remote control inside the projector's carrying case, be sure to turn it off using the switch on its side. This prevents the batteries from discharging if something presses against one of the buttons.
- When you are hand-carrying the projector, use the carrying handle.

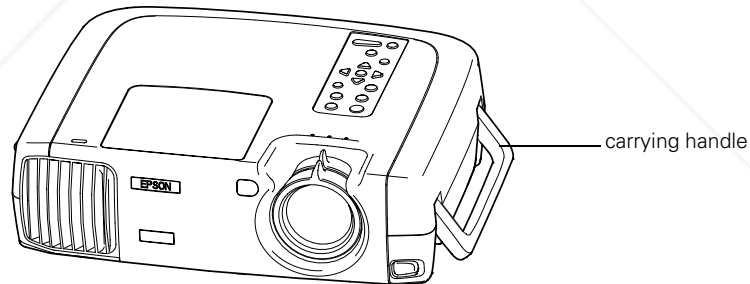

6 *Solving Problems*

This chapter helps you solve problems with your projector, and tells you how to contact technical support for problems you can't solve yourself. This chapter explains the following:

- Using the projector's on-screen help system
- What to do when the projector's status lights flash
- Solving problems with the image or sound
- Solving problems with the remote control
- Contacting technical support

Using On-Screen Help

If the image doesn't look right or your audio isn't working, you can get help by pressing the blue ? Help button on top of the projector or on the remote control. The following choices are available:

- Help for the image
- Help for the sound
- Language selection (Language)

Follow these steps to get help:

1. Press the blue ? Help button on the projector or the remote control.

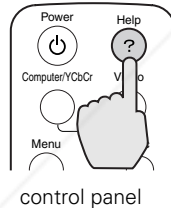



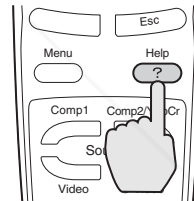



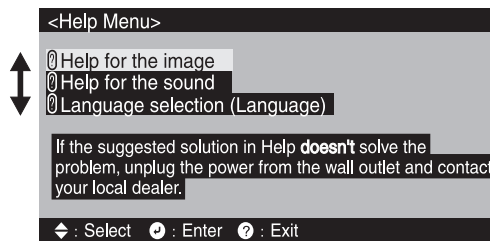

control panel



remote control



You see the Help menu:



2. Press the  Sync+ or  Sync- button on the projector (or use the  button on the remote control) to highlight one of the options. Then press the  button to select it.
3. Press the  Tracking- or  Tracking+ button on the projector (or use the  button on the remote control) to highlight the problem you want to solve. Then press the  button to view the solution(s).

4. Highlight a solution (if this choice is available). Then press the  button to select the solution.

Press the Esc button if you need to back up.

If the solution is to adjust one of the settings, press either the  Tracking- or  Tracking+ button on the projector (or use the  button on the remote control) to adjust it.

5. To exit the Help system, press the blue ? Help button.

If none of the suggestions solves your problem, see additional solutions to problems in the following sections.

What To Do When the Lights Flash



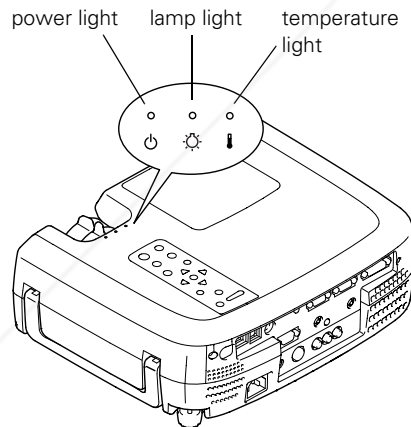







The lights on top of the projector indicate the projector's status and let you know when a problem occurs.



If the projector is not working correctly, first turn it off, let it cool, and unplug it. Then plug the power cord back in and turn on the projector. If this does not solve the problem, check the status lights on top of the projector and try the solutions recommended on the following pages.

Refer to the following table for a complete description of the projector's status lights and their meaning:

Status lights

Light	Status	Description
	orange	The projector is in sleep mode. You can unplug it or press the Power button to turn it on.
	flashing green	The projector is warming up. Wait for the image to appear.
	green	The projector is operating normally.
	flashing orange	The projector is cooling down. You can't turn it back on (and you should not unplug it) until the light stops flashing and remains orange.
	flashing red	Power is cut off because of an internal problem. Remove the power cord and contact EPSON for help.
	red	The lamp is burned out. Replace it as described on page 64.
	flashing orange	The lamp is almost burned out. Make sure you have a replacement lamp ready.
	flashing red	There is a problem with the lamp, power supply, fan, or circuit. If necessary, replace the lamp as described on page 64.
	flashing orange	The projector is too hot. Make sure the temperature surrounding the projector does not exceed 95 °F (35 °C) and there is plenty of space around and under the projector for ventilation. The air filter may be clogged. Clean or replace it as described on page 63.
	red	The projector is overheating, which turns the lamp off automatically. Wait until the cooling fan stops, then unplug the power cord. Plug the power cord back in and press the Power button. Make sure the room temperature is not above 95 °F (35 °C) and there is plenty of space around and under the projector for ventilation. The air filter may be clogged. Clean or replace it as described on page 63. If the projector continues to overheat after you clean the air filter, the problem may be caused by damage to the cooling fan or temperature sensor. Contact EPSON for help. Warning: Except as specifically explained in this <i>User's Guide</i> , do not attempt to service this product yourself.
	flashing red	There is a problem with the cooling fan or temperature sensor. Turn off the projector and unplug it. Contact EPSON for help.

The  power light is flashing orange and you cannot turn on the projector.



The lamp is cooling down. Wait until the light turns off and then press the **Power** button to turn on the projector.

The  power light does not come on.

Make sure the power cord is connected securely both at the power outlet and the projector. If you have just replaced the lamp, make sure the cover is securely fastened.

Solving Problems with the Image or Sound

No image appears on the screen.

- Check that the  power light is green, not flashing, and the lens cap is off.
- The projector may be in sleep mode. If the  power light is orange, press the **Power** button to turn the projector on.
- If the power was switched off and then on again, the projector may still be cooling down. Wait until the power light stops flashing and remains orange; then press the **Power** button again.
- Try pressing the **Power** button on the remote control.
- Make sure the **Brightness** setting on the Video menu is correct. See page 48 for more information. Try selecting the **Reset All** setting to return all setup menus to their default values.
- Press the **A/V Mute** button to make sure the picture has not been turned off temporarily.
- The attached computer may be in sleep mode or displaying a black screen saver. Try pressing a key on the computer.

You see a blue screen with the message No Signal displayed.

- Make sure the cables are connected correctly, as described in Chapter 1.
- Try restarting your computer.
- If you've connected a computer and one or more video sources, you may need to press the **Computer/YCbCr** or **Video** button (on the projector) or the **Comp1**, **Comp2/YCbCr**, **Video**, or **S-Video** button (on the remote control) to select the correct source. Allow a few seconds for the projector to sync up after pressing the button.

If you're using a PC laptop:

- Hold down the **Fn** key and press the function key that lets you display on an external monitor. It may have an icon such as , or it may be labelled **CRT/LCD**. Allow a few seconds for the projector to sync up after pressing it. Check your laptop's manual or online help for details.

On most systems, the  key lets you toggle between the LCD screen and the projector, or display on both at the same time.

- Depending on your computer's video card, you might need to use the **Display** utility in the **Control Panel** to make sure that both the LCD screen and external monitor port are enabled. See your computer's documentation or online help for details.

If you're using a PowerBook or iBook with OS 9.x:

1. From the **Apple** menu, select **Control Panels**, then click **Monitors and Sound**.
2. Click the **Arrange** icon.
3. Drag one monitor icon on top of the other. This lets you display on the projector screen as well as the LCD screen.
4. If this option isn't available, click the **Monitor** icon.
5. Select one of the listed **Simulscan** resolutions. (Allow a few seconds for the projector to sync up after making the selection.)

If you're using Macintosh OS X:

1. Select **System Preferences**.
2. Select **Displays**.
3. Make sure the **VGA Display** dialog box is selected.
4. Click the **Arrange** tab.
5. Make sure the **Mirror Displays** checkbox is selected.

The message Not Supported is displayed.

- Make sure the **Comp1 Input** and **Comp2/ YCbCr** options in the **Setting** menu are correct. See page 56.
- Make sure your computer's resolution doesn't exceed **UXGA** (1600 × 1200), and the frequency is supported by the projector (see page 106). If necessary, change your computer's resolution setting as described on the following page.





Only part of the computer image is displayed.

- Press the **Resize** button on the remote control.
- Make sure the image **Position** setting is correct on the **Video** menu. See page 48 for more information.
- Make sure your computer's resolution setting is correct. Ideally, it should be 1024 × 768 (811p and 820p) or 800 × 600 (600p) to match the projector's native resolution. If this option isn't available, select one of the other compatible video formats listed on page 106.
 - **Windows:**
Right-click the desktop, select **Properties**, click the **Settings** tab, and select a different resolution.
 - **Macintosh:**
On the Apple menu, choose **Control Panels**, then click **Monitors and Sound**. Select a different resolution.

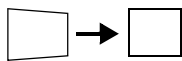
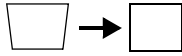
- You also may need to modify existing presentation files if you created them for a different resolution. See your software documentation for specific information.

The image isn't square, but trapezoid-shaped.



- If you've tilted the projector upward by extending the legs, the image will be broader at the top. Hold down the  or  button on top of the projector until the image is square.
- If the projector isn't directly in front of the screen, facing the screen squarely, the image will be broader at the left or right side. Hold down the  or  button on top of the projector until the image is square.

The image contains static or noise.

- Make sure the Comp1 Input and Comp2/ YCbCr options in the Setting menu are correct. See page 56.
- If you're using a computer cable longer than 6 feet (2 meters), or an extension cable, the image quality may be reduced.
- Keep your computer and video cables away from the power cord as much as possible to prevent interference.
- The video signal may be split between the computer and the projector. If you notice a decline in the projected image quality when the image is displayed simultaneously on your laptop computer and the projector, turn off the laptop's LCD display.

The image is blurry.

- There may be dirt or smears on the lens. Clean the lens as described on page 62.
- Adjust the focus using the focus ring.
- Make sure the lens is not fogged by condensation. You may need to wait before using the projector after moving it from a cold environment to a warm environment.

- Adjust the **Sharpness** setting on the Video menu (see page 48). When you change video settings, you should be able to see the effect on the screen immediately. If you're projecting from a computer, you may also need to adjust the tracking and sync as described in the next section. If you don't like the new settings, you can always select **Reset** to return to the factory default settings.

You see vertical stripes or the image still looks blurry after trying the solutions in the previous section.

- If you're projecting from a computer and displaying an image that contains a lot of fine detail, you may notice one or more vertical stripes or bands, or some of the characters may look heavy or blurred. Press the **↵** button on the projector or the **Auto** button on the remote control. This resets the projector's tracking and sync settings.
- If further adjustment is needed, you can fine-tune the **Tracking** and **Sync** settings manually using the buttons on the projector's control panel (or using the Video menu as described on page 48).
 1. Fill the screen with an image containing fine detail when making these adjustments. For example, in Windows you can select a pattern to appear as your desktop background. If this option isn't available, try projecting black text on a white background.
 2. Hold down the **Shift** button and press the **Tracking-** or **Tracking+** buttons to eliminate vertical stripes.

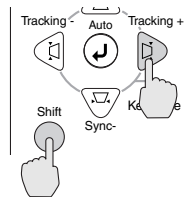
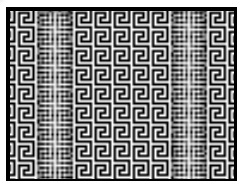

(If you don't see any changes on screen while pressing the buttons, select **Reset All** in the projector's menu system as described on page 59; then repeat the tracking adjustment.)

3. Hold down the **Shift** button and press the **Sync-** and **Sync+** buttons to increase the sharpness of the image.

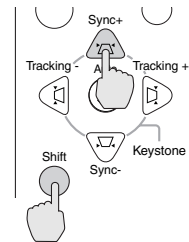
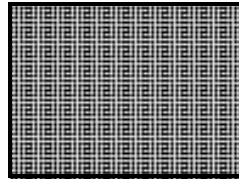



The colors of the image are not right.

note

Because of the different technologies used, your projected image may not exactly match the colors on your laptop or computer monitor.

- If you're displaying a computer image, use the **Color Mode** option in the projector's Video menu to adjust the color. If you're displaying video, adjust the **Color**, **Tint**, and **Color Mode** settings on the Video menu.
- Try changing the **Color Adjustment** setting on the Advanced menu.
- Check your computer display settings to correct the color balance.

There is no sound.

- Try turning up the volume. Press the right side of the **Volume** button on the remote control or the projector's control panel.
- If you're using a VCR or other video source, make sure the volume is not turned all the way down or muted. Also, make sure the cables are connected correctly, as described in Chapter 1.
- If your presentation includes computer audio, make sure the volume control on your computer is not turned all the way down or muted. Make sure the USB cable is securely connected to the projector and your computer, and the drivers are installed (if you're using a Macintosh, audio via a USB cable is supported on Mac OS 9.0 and 9.1 only.) If you're using the audio cable, make sure it is securely connected to both the projector and your computer's  headphone jack or  audio out jack. See page 14 (for laptops) or Appendix A (for other systems).

- Make sure the Windows volume controls on your computer are not turned all the way down or set to Mute. You may be able to check this by clicking the volume control in your Windows System Tray (lower right corner of the screen).
- Make sure the **A/V Mute** button is not enabled.
- The wrong source may be selected. Press the **Computer/YCbCr** or **Video** button on the projector—or the **Comp1**, **Comp2/YCbCr**, **Video**, or **S-Video** button on the remote control—to select the correct source.

Solving Problems with the Remote Control

The projector doesn't respond to remote control commands.

- Make sure the remote control is turned on.
- Make sure you are within 30 feet (9 meters) of the projector, and within range of the projector's front or back sensor (approximately 30° to left or right and 15° above or below).
- The remote control batteries may not be installed correctly or may be low on power. To change the batteries, see page 34.
- Dim the room lights and turn off any fluorescents. Make sure the projector is not in direct sunlight. Strong lighting, especially fluorescent lights, may affect the projector's infrared receivers.
- Turn off any nearby equipment that emits infrared energy, such as a radiant room heater.

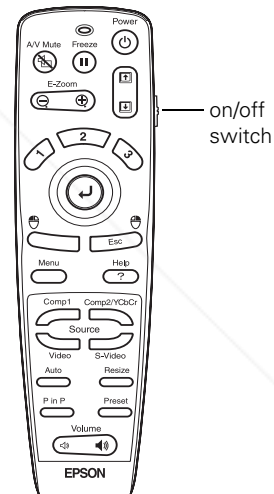

You can't control the mouse pointer with the remote control.

Make sure the cable is securely connected to both your computer's mouse or USB port and the projector's mouse or USB port. For details, see page 13 (for laptops) or Appendix A (for other systems).

Where To Get Help

EPSON provides technical assistance through electronic support services 24 hours a day, as listed in the following table.

Service	Access
World Wide Web	From the Internet, you can reach EPSON's product support page at http://support.epson.com . After selecting your product, you can access troubleshooting information, download product documentation, and receive technical advice through e-mail.
Presenters Online	Access tips, templates, and training for developing successful presentations at http://www.presentersonline.com

Telephone Support Services

To use the EPSON PrivateLine Support service, call (800) 637-7661 and enter the PIN on the EPSON PrivateLine Support card included in your owner's kit. This is the fastest way of speaking to a live representative, and it's free. This service is available 6 AM to 6 PM, Pacific Time, Monday through Friday, for the duration of your warranty period.

You may also speak with a projector support specialist by dialing one of these numbers:

- U.S.: (562) 276-4394, 6 AM to 6 PM, Pacific Time, Monday through Friday
- Canada: (905) 709-3839, 6 AM to 6 PM, Pacific Time, Monday through Friday

Toll or long distance charges may apply.

Before you call, please have the following information ready:

- Product name (EPSON PowerLite 600p, 811p, or 820p)
- Product serial number (located on the bottom of the projector)
- Computer configuration
- Description of the problem

You can purchase screens, carrying cases, or other accessories from EPSON at (800) 873-7766 or by visiting the EPSON Store at www.epsonstore.com (U.S. sales only). In Canada, please call (800) 463-7766 for dealer referral.



Discount-Merchant.com (800) 281-8860

THE TRUSTED SOURCE FOR PROJECTOR LAMPS AND ACCESSORIES

A

Appendix A: Connecting to Additional Equipment

This appendix explains how to connect the projector to a desktop PC or Macintosh, high-end workstation, more than one computer, or a DVI video source. It also provides guidance on setting up the projector in a permanent installation.

The following information is covered:

- Installing the projector
- Connecting to a PC desktop computer
- Connecting to a desktop Macintosh
- Connecting to a second computer
- Connecting to a high-end workstation
- Connecting to a DVI video source

Installing the Projector

The projector can be installed for four different viewing setups: front projection, ceiling mounting, rear projection onto a semi-transparent screen, or rear/ceiling projection, as shown:

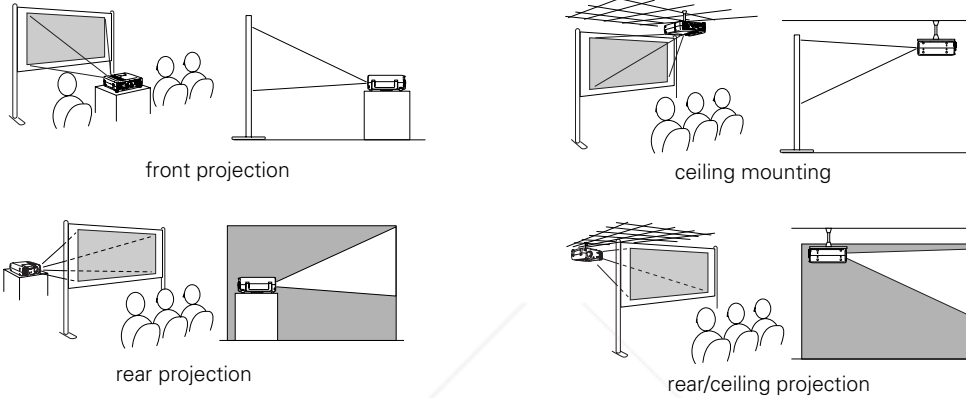

To project from overhead, you'll need to select **Ceiling** in the projector's Advanced menu. To project from the rear, select **Rear Proj.** See "Setting Advanced Features" on page 57.

If you're mounting the projector on the ceiling and you place it above screen level, you'll have to tilt it down to position the image on-screen. This causes the image to lose its square shape. You can then correct the distortion by using the **V Keystone** function in the projector's menu system (see "Customizing Projector Features" on page 55) or by using the **Keystone** buttons on the projector's control panel.

If you place the projector's lens so it's level with the top of the screen, the image will be square and you won't have to adjust it. If you place the lens lower than the top of the screen, you'll have to tilt the projector upward if you want to fill the whole screen with the image.

note

See "Positioning the Projector" on page 10 for more information.

Controlling the Projector from a Computer

If you want to be able to control the projector's settings from a computer, you can install the EMP Link program. You can download this program, plus its User's Guide, from EPSON's web site at support.epson.com. You'll also need a serial or USB cable to connect the projector to the computer.

Connecting to an External Audio System

The projector's internal speakers are loud enough for most rooms. However, if your installation requires maximum volume and sound quality, you can connect the projector to external speakers or a public address (PA) system. This disables the projector's internal speakers.

If you've connected multiple audio and video sources to the projector, the projector will automatically switch the audio along with the video source whenever you choose a different video source. (See "Switching Between Picture Sources" on page 29 or page 35.)

To connect the projector to an external sound system, you will need an RCA-to-3.5 mm stereo audio cable, which may be included with your sound system, or may be purchased from an electronics store.

Before you start, make sure the projector and speakers or PA system are turned off.

1. Connect the cable's 3.5-mm stereo miniplug to the projector's **Audio Out** jack.

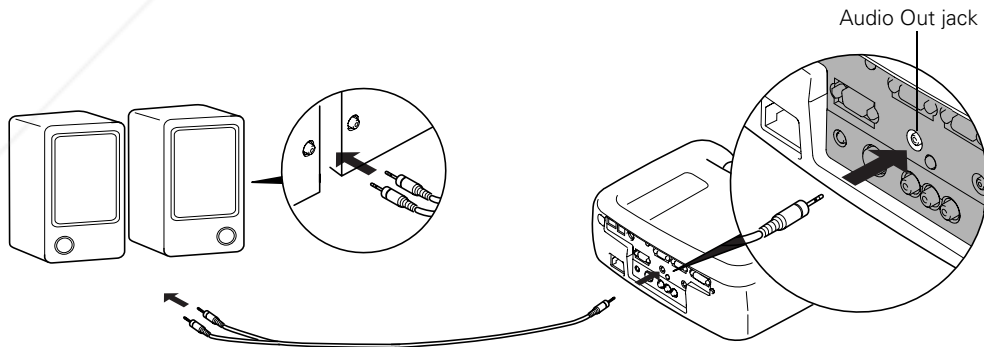

Connecting to a PC Desktop Computer

You can connect the projector to any IBM-compatible PC. This section includes instructions for the following:

- Connecting the computer cable
- Connecting the mouse cable (if you want to use the remote control as a mouse or use USB audio)
- Connecting the audio cable (if you'll be projecting with audio)

Follow the steps in each section for the cables you need to connect. Before beginning, make sure the projector and computer are turned off. If you need help with positioning the projector, see page 10.

Connecting the Computer Cable

1. Disconnect the monitor cable from the video port on the back of the computer.
2. If you'll be viewing the display on your computer monitor as well as the projector screen, connect the monitor cable to the projector's **Monitor Out** port, as shown.

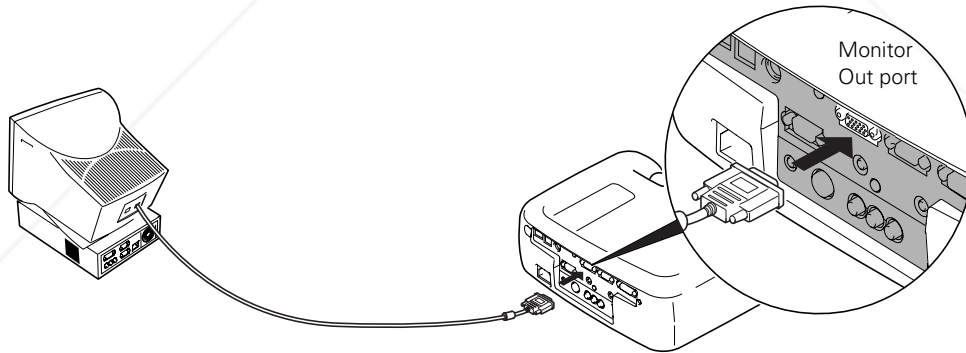

3. Connect one end of the computer cable to the projector's Computer2/Component Video port, as shown.

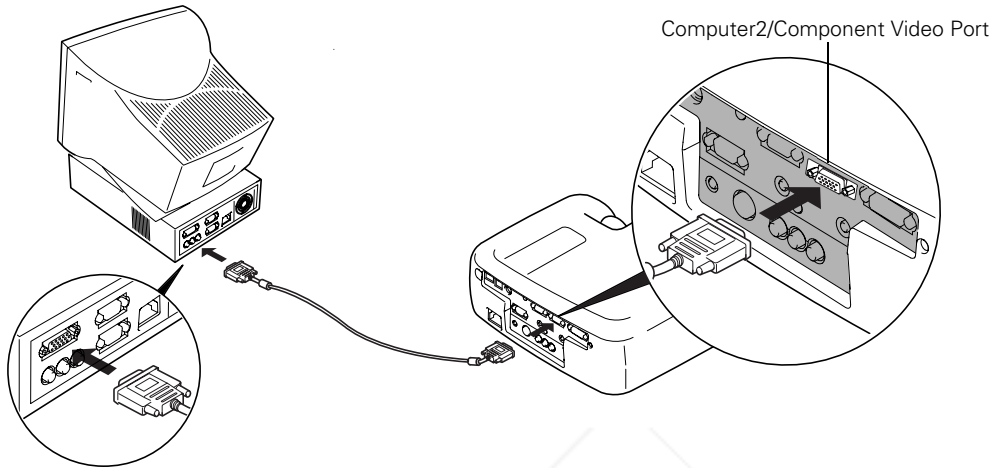

4. Connect the other end of the cable to the computer's video port.
5. Tighten the screws on the connectors.

Connecting the Mouse Cable

note

If you have a PC with a serial mouse port, you'll need a serial mouse cable. See your projector dealer to obtain the correct cable.

To use the remote control as a mouse, follow the steps below. You'll use a different mouse cable, depending on whether your computer has a round PS/2 mouse port or a flat USB port.

The USB cable also provides audio support. If your computer supports USB and your presentation includes sound, you can play it through the projector's speakers by connecting the USB cable.

1. Connect the square end of the USB cable to the projector's USB port as shown.

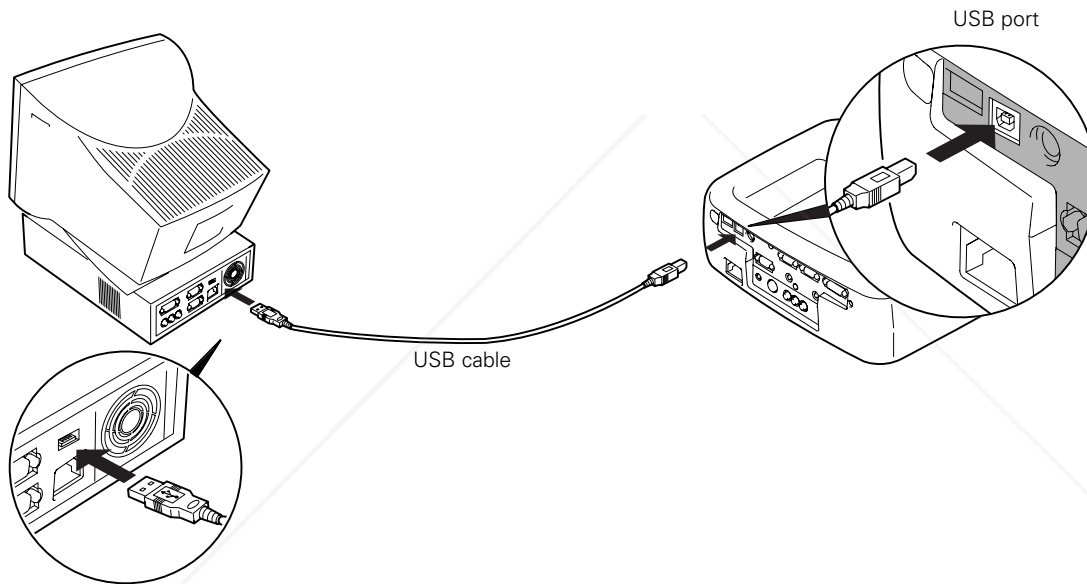

2. Disconnect your mouse from the port on the back of your computer and replace it with the other end of the cable. (Your computer's mouse will be disabled while you are using the remote control as a mouse.)

Connecting the Audio Cable

If your presentation includes sound and you want to use the projector's built-in speakers, you'll need to connect a stereo, mini-jack audio cable (not included). If you connected the USB cable, you may not need a separate audio cable.

1. Connect one end of the audio cable to the **Audio 1** jack on the projector.

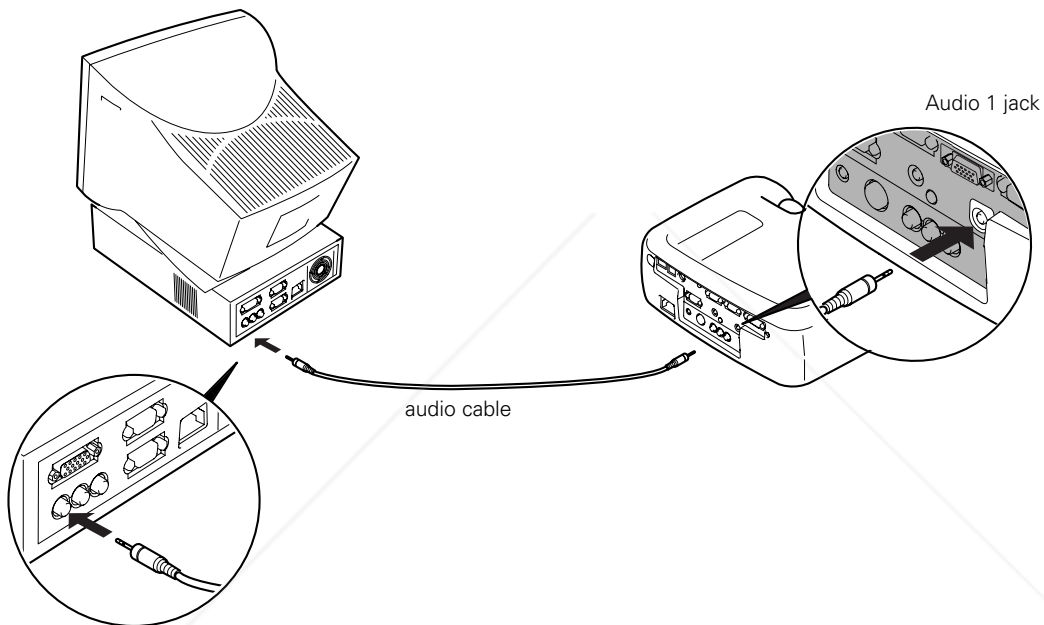

2. Connect the other end of the audio cable to the speaker or audio out port on the computer's sound card.

Connecting to a Desktop Macintosh

note

Macintosh configurations vary. See your computer manual for the location of the ports needed to connect your projector. Older models may require a Macintosh adapter set, which you may purchase from EPSON; see page 7.

You can connect the projector to any desktop Macintosh. This section includes instructions for the following:

- Connecting the computer cable
- Connecting the mouse cable (if you want to use your remote control as a mouse or use USB audio)
- Connecting the audio cable (if you'll be projecting with audio)

Follow the steps in each section for the cables you need to connect. Before beginning, make sure the projector and computer are turned off. If you need help with positioning the projector, see page 10.

Connecting the Computer Cable

1. Disconnect the monitor cable from the video port on the back of the Macintosh.
2. If you'll be viewing the display on your computer monitor as well as the projector screen, connect the monitor cable to the projector's **Monitor Out** port, as shown.

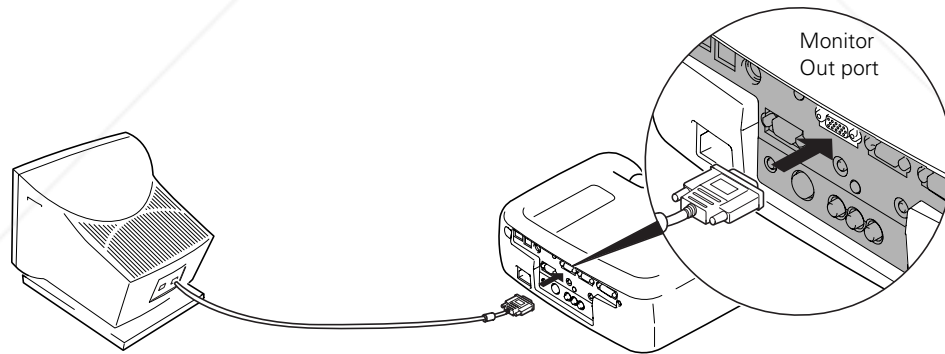

3. Connect one end of the computer cable to the projector's Computer 2/ Component Video port, as shown.

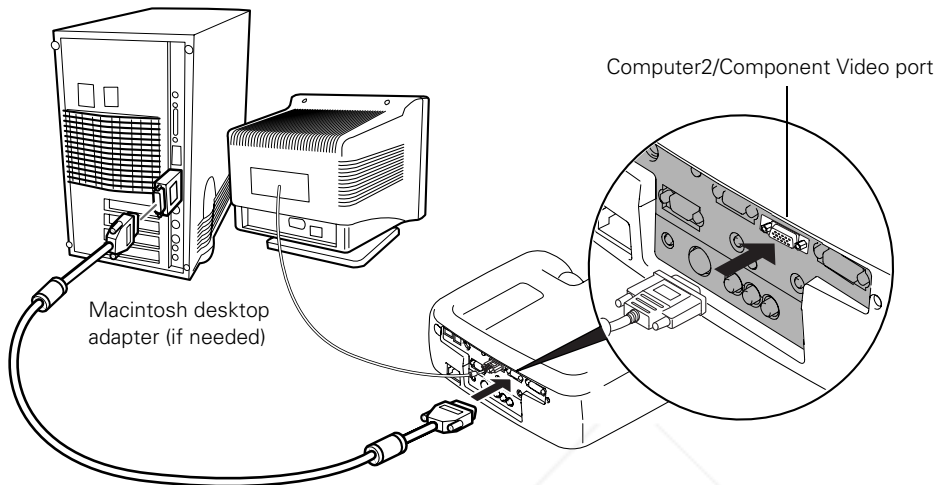

4. Connect the other end of the computer cable to the video port on the Macintosh. If it doesn't fit, you may have to use a Macintosh desktop adapter, which you can buy from EPSON (see page 7).

To use the adapter, remove its cover as shown and set its DIP switches according to the resolution you want to use, such as 16-inch mode. See your Macintosh documentation for instructions.

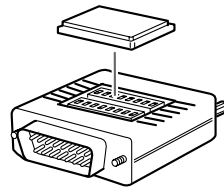

Replace the cover and connect the adapter to the free end of the computer video cable. Then plug the cable (with the adapter) into the video port on your Macintosh.

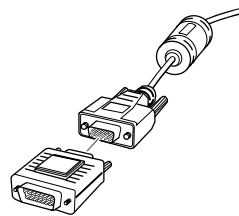

5. Tighten the screws on the connectors.

Connecting the Mouse Cable

To use the remote control as a mouse follow the steps below. If the Macintosh has a USB port, you can use the USB mouse cable included with the projector. If it has a round mouse port, you'll need a Macintosh mouse cable; see your projector dealer for help in obtaining the correct cable.

The USB cable also provides audio support on Mac OS 9.0 and 9.1. If your Macintosh supports USB and your presentation includes sound, you can play it through the projector's speakers by connecting the USB cable.

1. Connect the square end of the USB cable to the projector's **USB** port.

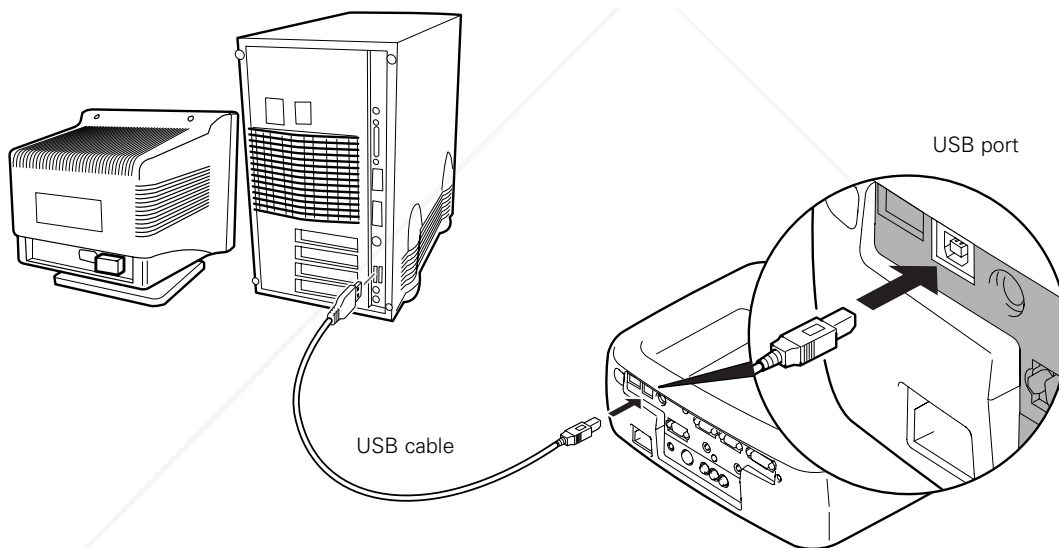

2. Disconnect your Macintosh's mouse cable. Connect the other end of the projector's mouse cable to a USB port on your Macintosh.

Connecting the Audio Cable

If your presentation includes sound and you want to use the projector's built-in speakers, you'll need to connect a stereo, mini-jack audio cable (not included). If you connected the USB cable, you may not need a separate audio cable.

1. Connect one end of the audio cable to the **Audio 1** jack on the projector.

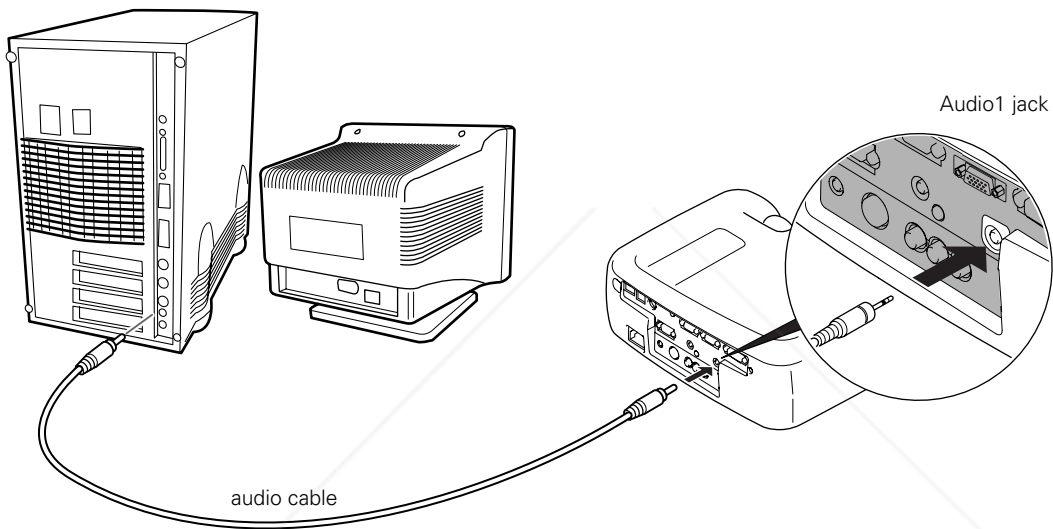

2. Connect the other end of the audio cable to the speaker or audio out port on the Macintosh.

Connecting to a Second Computer

To connect a second computer to the projector, you need to use the projector's **Computer1** port. You'll need the optional DVI-analog cable, unless the computer supports DVI (Digital Visual Interface) video.

1. Connect one end of the cable to the computer's video port.
2. Connect the other end to the projector's **Computer1** port as shown.

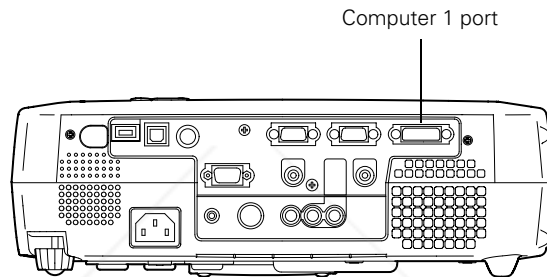

3. To display images properly, make sure the **Comp1 Input** option in the projector's Setting menu is set correctly. See page 56 for instructions.
4. If you want to hear the computer's audio through the projector, you'll need to connect the USB cable or purchase an RCA-to-3.5 mm stereo cable (available from your electronics store or video dealer).

Insert the cable's 3.5-mm plug into your computer's audio-out port. Then attach the connectors at the other end of the cable to the projector's **Audio 2** jacks, matching the white plug to the **L** jack and the red plug to the **R** jack.

Connecting to a High-End Workstation

There is no across-the-board standard for workstation video output. However, your PowerLite projector is capable of remapping input resolutions up to 1600 × 1200 pixels. Workstations that follow the SXGA standard and use the HD15 (standard VGA) connector won't need an adapter cable or any special connection device. If your system varies, contact your computer dealer for help in connecting your workstation.

Connecting to a DVI Video Source

The projector's DVI (Digital Visual Interface) port receives pictures directly from your computer in digital format. This lets the projector display images of greater clarity than can be achieved using a standard analog VGA connection.

To project images in digital video format, follow these steps:

1. Connect the computer's DVI cable to the projector's **Computer1** port.

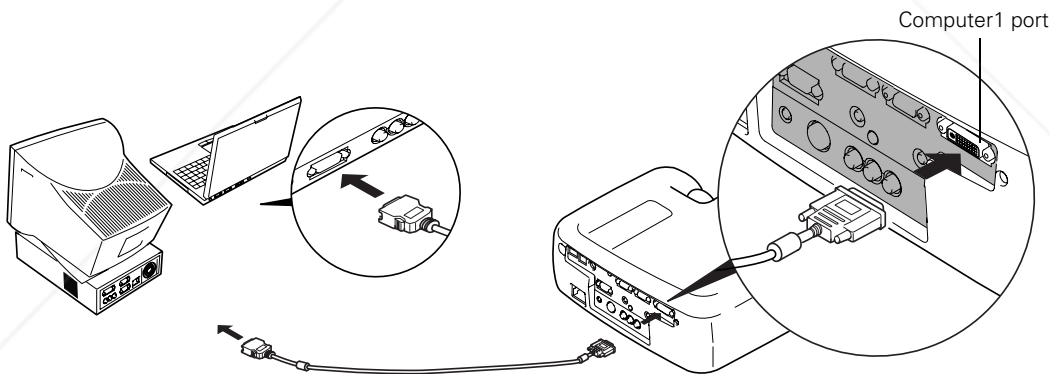

2. To display images properly, make sure the **Comp1 Input** option in the projector's Setting menu is set correctly. See page 56 for instructions.

If you want to connect audio for this computer, use the projector's **Audio 1** port; if you want to connect a mouse cable (to use the remote control as a wireless mouse), use the **Mouse** or **USB** port.

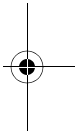
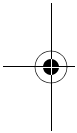
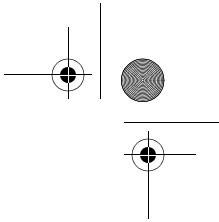
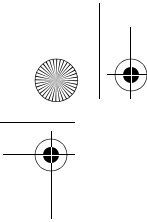

Discount-Merchant.com (800) 281-8860

THE TRUSTED SOURCE FOR PROJECTOR LAMPS AND ACCESSORIES

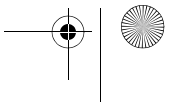
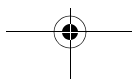
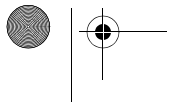
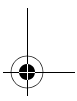
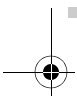

B

Appendix B: Notices

This chapter includes safety instructions and other important information about your EPSON PowerLite projector.

Important Safety Instructions

Follow these safety instructions when setting up and using the projector:

- Do not place the projector on an unstable cart, stand, or table.
- Do not use the projector near water or sources of heat.
- Use the type of power source indicated on the projector. If you are not sure of the power available, consult your dealer or power company.
- Place the projector near a wall outlet where the plug can be easily unplugged.

Placez l'appareil près d'une prise de courant où la fiche peut être débranchée facilement.

- Insert the projector's three-wire grounding-type plug into a properly grounded outlet. If you have a two-prong outlet, contact an electrician to replace it. Do not hold the plug with wet hands.
- Take the following precautions for the plug. Failure to comply with these precautions could result in sparks or fire: Do not insert the plug into an outlet with dust present. Insert the plug firmly into the outlet.
- Do not overload wall outlets, extension cords, or integral convenience receptacles. This can cause fire or electric shock.
- Do not place the projector where the cord can be walked on. This may result in fraying or damage to the plug.
- Unplug the projector from the wall outlet before cleaning. Use a damp cloth for cleaning. Do not use liquid or aerosol cleaners.
- Do not block the slots and openings in the projector case. They provide ventilation and prevent the projector from overheating. Do not operate the projector on a sofa, rug, or other soft surface, or in a closed-in cabinet unless proper ventilation is provided.

- Never push objects of any kind through the cabinet slots. Never spill liquid of any kind into the projector.
- Except as specifically explained in this *User's Guide*, do not attempt to service this product yourself. Refer all servicing to qualified personnel. Opening or removing covers may expose you to dangerous voltages and other hazards.
- Unplug the projector from the wall outlet and refer servicing to qualified service personnel under the following conditions: When the power cord or plug is damaged or frayed. If liquid has been spilled into the projector, or if it has been exposed to rain or water. If it does not operate normally when you follow the operating instructions, or if it exhibits a distinct change in performance, indicating a need for service. If it has been dropped or the housing has been damaged.
- This product includes a lamp component that contains mercury. Please consult your state and local regulations regarding proper disposal and do not place in a waste stream.
- Unplug the projector during lightning storms or when it will not be used for extended periods.
- Do not place the projector and/or remote control on top of heat-producing equipment or in a hot location.
- If you use the projector in a country other than where you purchased it, use the correct power cord for that country.
- Do not stand on the projector or place heavy objects on it.
- Do not use the projector outside of the required temperature range of 41 to 95 °F (5 to 35 °C). Doing so may cause an unstable display and could lead to projector damage.
- Do not store the projector outside of the required temperature range of 14 to 140 °F (-10 to 60 °C) or in direct sunlight for long periods of time. Doing so may cause damage to the case.

Remote Control Information

You can operate the projector by remote control via a line-of-sight infrared (IR) receiver at the front and rear of the projector. The projector may not respond to remote control commands under the following conditions:

- There is an object between the remote control IR emitter and the IR receiver on the projector.
- Ambient light is too bright.
- Certain types of fluorescent lighting are used.
- A strong light source shines into the IR receiver.
- Other equipment that emits infrared energy, such as a radiant room heater, is in the room.

These conditions commonly cause problems for most infrared-controlled equipment. Try the following:

- Make sure the remote control is turned on.
- The remote control unit's batteries may be low on power; replace them.
- Dim the ambient lighting and/or turn off any fluorescent lights.
- Close any window coverings and/or move the projector out of direct sunlight.
- Turn off other equipment that emits infrared energy.

If the remote control still does not work properly, remember you can always control your computer-based presentation directly from the computer, even in an environment containing one of the conditions listed above.

Declaration of Conformity

According to 47CFR, Part 2 and 15, Class B Personal Computers and Peripherals; and/or CPU Boards and Power Supplies used with Class B Personal Computers

We: EPSON AMERICA, INC.
Located at: 3840 Kilroy Airport Way
MS: 3-13
Long Beach, CA 90806-2469
Telephone: (562) 290-5254

Declare under sole responsibility that the product identified herein, complies with 47CFR Part 2 and 15 of the FCC rules as a Class B digital device. Each product marketed, is identical to the representative unit tested and found to be compliant with the standards. Records maintained continue to reflect the equipment being produced can be expected to be within the variation accepted, due to quantity production and testing on a statistical basis as required by 47CFR §2.909. Operation is subject to the following two conditions: (1) this device may not cause harmful interference, and (2) this device must accept any interference received, including interference that may cause undesired operation.

Trade Name: EPSON
Type of Product: Multimedia Projector
Model: EMP-600/811/820

FCC Compliance Statement

For United States Users

This equipment has been tested and found to comply with the limits for a Class B digital device, pursuant to Part 15 of the FCC Rules. These limits are designed to provide reasonable protection against harmful interference in a residential installation. This equipment generates, uses, and can radiate radio frequency energy and, if not installed and used in accordance with the instructions, may cause harmful interference to radio or television reception. However, there is no guarantee that interference will not occur in a particular installation. If this equipment does cause interference to radio and television reception, which can be determined by turning the equipment off and on, the user is encouraged to try to correct the interference by one or more of the following measures:

- Reorient or relocate the receiving antenna.
- Increase the separation between the equipment and receiver.
- Connect the equipment into an outlet on a circuit different from that to which the receiver is connected.
- Consult the dealer or an experienced radio/TV technician for help.

WARNING

The connection of a non-shielded equipment interface cable to this equipment will invalidate the FCC Certification of this device and may cause interference levels which exceed the limits established by the FCC for this equipment. It is the responsibility of the user to obtain and use a shielded equipment interface cable with this device. If this equipment has more than one interface connector, do not leave cables connected to unused interfaces. Changes or modifications not expressly approved by the manufacturer could void the user's authority to operate the equipment.

For Canadian Users

This Class B digital apparatus meets all requirements of the Canadian Interference-Causing Equipment Regulations.

Cet appareil numérique de la classe B respecte toutes les exigences du Règlement sur le matériel brouilleur du Canada.

Warranty

Epson America, Inc. Limited Warranty

Basic Two-Year Warranty and 90-Day Lamp Warranty

What Is Covered: Epson America, Inc. ("EPSON") warrants to the first end user customer of the EPSON product enclosed with this limited warranty statement that the product, if purchased and used in the United States or Canada, conforms to the manufacturer's specifications and will be free from defects in workmanship and materials for a period of two (2) years from the date of original purchase (except that the warranty period is 90 days for projector lamps).

What EPSON Will Do To Correct Problems: If you elect carry-in warranty service, please bring the product securely packaged in its original container or an equivalent, along with proof of the date of original purchase, to your EPSON Dealer or EPSON Customer Care Center. EPSON will, at its option, repair or replace on an exchange basis the defective unit, without charge for parts or labor. When warranty service involves the exchange of the product or of a part, the item replaced becomes EPSON property. The exchanged product or part may be new or previously repaired to the EPSON standard of quality. Exchange or replacement products or parts assume the remaining warranty period of the product covered by this limited warranty. However, each replacement lamp carries the limited 90-day warranty stated above.

What This Warranty Does Not Cover: This warranty covers only normal consumer use in the United States and Canada. For lamps, 24-hour-per-day use causes unusual strain and is not considered normal use. This warranty does not cover consumables (e.g., fuses), other than lamps. EPSON is not responsible for warranty service should the EPSON label or logo or the rating label or serial number be removed or should the product fail to be properly maintained or fail to function properly as a result of misuse, abuse, improper installation, neglect, improper shipping, damage caused by disasters such as fire, flood, and lightning, improper electrical current, software problems, interaction with non-EPSON products, or service other than by an EPSON Authorized Servicer. Postage, insurance, or shipping costs incurred in presenting your EPSON product for carry-in warranty service are your responsibility. If a claimed defect cannot be identified or reproduced in service, you will be held responsible for costs incurred.

THE WARRANTY AND REMEDY PROVIDED ABOVE ARE EXCLUSIVE AND IN LIEU OF ALL OTHER EXPRESS OR IMPLIED WARRANTIES INCLUDING, BUT NOT LIMITED TO, THE IMPLIED WARRANTIES OF MERCHANTABILITY OR FITNESS

FOR A PARTICULAR PURPOSE. SOME LAWS DO NOT ALLOW THE EXCLUSION OF IMPLIED WARRANTIES. IF THESE LAWS APPLY, THEN ALL EXPRESS AND IMPLIED WARRANTIES ARE LIMITED TO THE WARRANTY PERIOD IDENTIFIED ABOVE. UNLESS STATED HEREIN, ANY STATEMENTS OR REPRESENTATIONS MADE BY ANY OTHER PERSON OR FIRM ARE VOID. EXCEPT AS PROVIDED IN THIS WRITTEN WARRANTY, NEITHER EPSON AMERICA, INC. NOR ITS AFFILIATES SHALL BE LIABLE FOR ANY LOSS, INCONVENIENCE, OR DAMAGE, INCLUDING DIRECT, SPECIAL, INCIDENTAL OR CONSEQUENTIAL DAMAGES, RESULTING FROM THE USE OR INABILITY TO USE THE EPSON PRODUCT, WHETHER RESULTING FROM BREACH OF WARRANTY OR ANY OTHER LEGAL THEORY. IF THE REMEDY ABOVE FAILS, EPSON'S ENTIRE LIABILITY SHALL BE LIMITED TO A REFUND OF THE PRICE PAID FOR THE EPSON PRODUCTS COVERED BY THIS LIMITED WARRANTY.

In Canada, warranties include both warranties and conditions.

Some jurisdictions do not allow limitations on how long an implied warranty lasts and some jurisdictions do not allow the exclusion or limitation of incidental or consequential damages, so the above limitations and exclusions may not apply to you.

This warranty gives you specific legal rights, and you may also have other rights, which vary from jurisdiction to jurisdiction.

To locate the Authorized EPSON Servicer nearest you, call the EPSON ConnectionSM at (800) 637-7661 + PIN or (562) 276-4394 in the U.S. and (905) 709-3839 in Canada or write to: Epson America, Inc., P.O. Box 93012, Long Beach, CA 90809-3012.



Discount-Merchant.com (800) 281-8860

THE TRUSTED SOURCE FOR PROJECTOR LAMPS AND ACCESSORIES

Appendix B: Notices 101

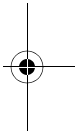
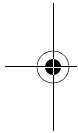
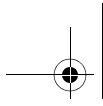

Sponsored by 

Discount-Merchant.com (800) 281-8860

THE TRUSTED SOURCE FOR PROJECTOR LAMPS AND ACCESSORIES

102 *Appendix B: Notices*

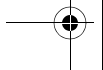
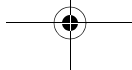

C

Appendix C: Technical Specifications

General

Type of display	Poly-silicon TFT active matrix
Size of LCD panels	Diagonal: 0.9 inches (22.9 mm)
Lens	F=1.74 to 2.06, f=28.3 mm to 37.98 mm
Resolution (native format)	811p and 820p: 1024 × 768 pixels (XGA) 600p: 800 × 600 pixels (SVGA)
Color reproduction	24 bit, 16.7 million colors
Brightness	820p: 2500 lumens (ANSI) 811p: 2000 lumens (ANSI) 600p: 1700 lumens (ANSI)
Contrast ratio	400:1
Image size	30 to 300 inches
Projection distance	2.85 to 40.7 feet (0.87 to 12.4 meters)
Projection methods	Front, rear, upside-down (ceiling mount)
Internal sound system	5 W monaural
Optical aspect ratio	4:3 (horizontal : vertical)
Zoom ratio	1:1.35
Noise level	38 dB
Keystone correction angle	Vertical: ± 30° (maximum) Horizontal: ± 10° (maximum)

Projection Lamp

Type	UHE (Ultra High Efficiency)
Power consumption	200 W
Lamp life	About 1500 hours
Part number	V13H010L15

Remote Control

Range	32.8 feet (10 meters)
Batteries	Alkaline AA (2)

Mouse Compatibility

Supports PS/2 and USB

Dimensions

Height	4.1 inches (104 mm)
Width	13.7 inches (348 mm)
Depth	10.8 inches (274 mm)
Weight	9.3 lb (4.2 kg)

Electrical

Rated frequency	50/60 Hz AC
Power supply	100 to 120 VAC, 3.1A 200 to 240 VAC, 1.5 A
Power consumption	Operating: 280 W Standby: 5.5 W

Environmental

Temperature	Operating: 41 to 95 °F (5 to 35 °C) Storage: 14 to 140 °F (-10 to 60 °C)
Humidity	Operating: 20 to 80% RH, non-condensing Storage: 10 to 90% RH, non-condensing

Safety

United States	FCC Part 15J Class B UL1950 Rev. 3
Canada	DOC SOR/88-475 CSA C22.2 No. 950 Rev. 3 (cUL)
CE Marking	Directive 73/23/EEC EN 60950 Directive 89/336/EEC EN 55022, EN 55024

Computer Video Port Pin Assignments

The Computer2/Component Video port is a female video RGB, 15-pin micro-D-style connector. Here are its pin assignments:

Pin no.	Computer port	Pin no.	Computer port
1	Red video	9	Reserved
2	Green video	10	Synchronous GND
3	Blue video	11	GND
4	GND	12	SDA
5	GND	13	Horizontal sync / composite sync
6	Red GND	14	Vertical sync
7	Green GND	15	SCL
8	Blue GND		

Compatible Video Formats

The projector supports NTSC, PAL, and SECAM international video standards, as well as the monitor display formats listed below.

To project images output from a computer, the computer's video card must be set at a refresh rate (vertical frequency) that's compatible with the projector; see the following table for compatible formats. As noted below, some images are automatically resized to display in one of the projector's "native" formats (such as XGA). In addition, the frequencies of some computers may not allow images to display correctly; see your computer's documentation for details.

Mode	Refresh Rate (Hz)	Resolution	DVI support
PC98	57	640 × 400	supported
VGAEGA	70	640 × 350	supported
VGA60	60	640 × 480	supported
VESA72	72	640 × 480	supported
VESA75	75	640 × 480	supported
VESA85	85	640 × 480	supported
VGA120	120	640 × 480	
SVGA56	56	800 × 600	supported
SVGA60	60	800 × 600	supported
SVGA72	72	800 × 600	supported
SVGA75	75	800 × 600	supported
SVGA85	85	800 × 600	supported
SVGA120	120	800 × 600	
XGA43i	43	1024 × 768 ¹	
XGA60	60	1024 × 768 ¹	supported
XGA70	70	1024 × 768 ¹	supported
XGA75	75	1024 × 768 ¹	supported
XGA85	85	1024 × 768 ¹	supported
XGA120	120	1024 × 768 ¹	
SXGA1—70	70	1152 × 864 ²	supported
SXGA1—75	75	1152 × 864 ²	supported
SXGA1—85	85	1152 × 864 ²	supported
SXGA1—100	100	1152 × 864 ²	
SXGA2—60	60	1280 × 960 ²	supported
SXGA2—75	75	1280 × 960 ²	supported
SXGA2—85	85	1280 × 960 ²	
SXGA3—43i	43	1280 × 1024 ²	
SXGA3—60	60	1280 × 1024 ²	supported

Mode	Refresh Rate (Hz)	Resolution	DVI support
SXGA3—75	75	1280 × 1024 ²	supported
SXGA3—85	85	1280 × 1024 ²	
SXGA+60	60	1400 × 1050 ²	supported
SXGA+75	75	1400 × 1050 ²	supported
SXGA+85	85	1400 × 1050 ²	supported
UXGA48i	48	1600 × 1200 ^{2,3}	
UXGA60	60	1600 × 1200 ^{2,3}	
UXGA65	65	1600 × 1200 ^{2,3}	
UXGA70	70	1600 × 1200 ^{2,3}	
UXGA75	75	1600 × 1200 ^{2,3}	
UXGA80	80	1600 × 1200 ^{2,3}	
UXGA85	85	1600 × 1200 ^{2,3}	
iMAC VGA	117	640 × 480	
iMAC SVGA	95	800 × 600	
iMAC XGA	75	1024 × 768 ¹	supported
MAC II 13	67	640 × 480	supported
MAC16	75	832 × 624	supported
MAC19	75	1024 × 768 ¹	supported
MAC21	75	1152 × 870 ²	supported
TV525i	60	2	
TV625i	50	2	
SDTV480p	60	2	supported
HDTV720p	60	2	supported
HDTV1080i	60	2	
NTSC	60	2	
NTSC4.43	60	2	
PAL	50	2	
M-PAL	60	2	
N-PAL	50	2	
PAL60	60	2	
SECAM	50	2	

- ¹ The image is resized so that it displays using one of the projector's native formats (PowerLite 600p only).
- ² The image is resized so that it displays using one of the projector's native formats.
- ³ Not supported on the PowerLite 600p

ESC/VP21 Commands

When the projector is in a command ready state, it returns the : code. When command processing is complete, the projector also returns a : code. If command processing terminates with an error, an error message is output and then the : code is sent.

Item		Command
Power ON/OFF	ON	PWR ON
	OFF	PWR OFF
Signal selection	Computer1 (Analog-RGB)	SOURCE 11
	Computer1 (Digital-RGB)	SOURCE 12
	Computer1 (RGB-Video)	SOURCE 13
	Computer2/Component Video (Analog-RGB)	SOURCE 21
	Computer2/Component Video (RGB-Video)	SOURCE 22
	Computer2/Component Video (YCbCr)	SOURCE 23
	Computer2/Component Video (YPbPr)	SOURCE 24
	Video	SOURCE 41
S-Video	SOURCE 42	
A/V Mute ON/OFF	ON	MUTE ON
	OFF	MUTE OFF
A/V Mute selection	Black	MSEL 00
	Blue	MSEL 01
	User's Logo	MSEL 02

Index

A

- A/V Mute, 30, 54, 56
- A/V Mute button, 29, 36
- About menu, 44, 58 to 59, 67
- Accessories, 6 to 7, 80
- Advanced menu, 44, 57 to 58
- Air filter, cleaning and replacing, 63 to 64
- Anti-theft device, 7, 11
- Arrow button, remote control, 42
- Aspect ratio, 28, 103
- Audio
 - adjusting tone, 51
 - adjusting volume, 29, 36, 51
 - connecting desktop, 87, 91
 - connecting laptop, 14
 - connecting second computer, 92
 - menu, 44, 51
 - outputting to external sound system, 83
 - problems, troubleshooting, 78
 - turning off (using A/V Mute), 30, 36
- Audio Out jack, 83
- Auto button, 28, 48

B

- Back adjustable foot, 26
- Bar tool, 40, 52
- Bass, adjusting, 51
- Batteries, installing, 34
- Blank screen, 22 to 24
- Blurry image, 76
- Brightness, 1, 103
- Brightness setting, 48

C

- Cables
 - A/V, 5 to 7, 15 to 18
 - audio, 5 to 7, 14, 83, 87, 91
 - computer, 5 to 7, 12, 84, 88 to 89
 - mouse, 5 to 7, 13, 86, 90
 - USB, 5 to 7, 13, 86, 90
 - video, 5 to 7, 15 to 18
- Capturing image, 53 to 54
- Carrying case, 7, 68
- Ceiling mount, 7, 82
- Cleaning
 - air filter, 63 to 64
 - lens, 62
 - projector case, 62
- Color
 - problems, 78
 - settings, 48 to 49, 57
- Color Mode setting, 49
- Comp1 button, 35, 56, 79
- Comp2/YCbCr button, 35, 56, 79
- Component video cable, 6, 15
- Composite video cable, 15
- Computer
 - cable, 5
 - saving settings for, 50
- Computer connector pin assignments, 105
- Computer/YCbCr button, 29, 79
- Computers supported, 1
- Connecting projector
 - to a desktop Macintosh, 88 to 91
 - to a desktop PC, 84 to 87
 - to a DVI computer source, 93
 - to a high-end workstation, 93
 - to a laptop, 12 to 14
 - to a second computer, 92
 - to a video source, 15 to 18

Connector pin assignments, 105
 Contrast setting, 48
 Cursor/Stamp tool, 39, 52

D

Declaration of Conformity, 98
 Default settings, restoring, 46, 59
 Desktop adapter, Macintosh, 88 to 89
 Desktop computer, connecting, 84 to 87,
 88 to 91
 Digital visual interface, *see* DVI
 Distance from projector to screen, 10, 103
 Down arrow button, remote control, 42
 Drawing on the screen, 39 to 40
 DVI (Digital Visual Interface)
 cable, 6, 7
 source, connecting to, 93

E

Effect menu, 44, 52
 Electrical specifications, 104
 Enter button, 35, 41
 Environmental specifications, 105
 EPSON
 accessories, 7, 80
 PrivateLine Support, 4, 80
 technical support, 4, 80
 Esc button, 41
 E-Zoom button, 37

F

FCC compliance statement, 99
 Filter, *see* Air filter
 Focusing, 25
 Foot release button, 26
 Freeze button, 36

H

Height of image, adjusting, 26
 Help, 3 to 4, 80
 Help button, 70
 Help system, using, 70

Highlighting tools, 39 to 40, 52
 H-Keystone setting, 55

I

iBook, connecting to, 12
 iMac, connecting to, 6
 Image
 adjusting, 24 to 28, 47 to 49
 capturing and saving in projector, 53 to 54
 correcting shape, 27, 55, 76
 focusing, 25
 height, adjusting, 26
 positioning, 26, 48
 problems with, troubleshooting, 73 to 79
 raising, 26
 resizing, 28, 37
 shape, correcting, 27, 55, 76
 size and projection distance, 10, 103
 turning off (using A/V Mute), 30, 36
 zooming, 25, 37
 Installing projector, 82 to 83

K

Kensington anti-theft device, 7, 11
 Keystone correction, 27, 55, 76, 103

L

Lamp
 number of hours used, 58
 replacing, 64 to 67
 status light, 71
 Lamp timer, resetting, 67
 Language setting, 70
 Laptop computer
 connecting to, 12 to 14
 displaying on, 22, 74
 Lens
 cleaning, 62
 specifications, 103
 Lights, status, 71 to 73
 Lines, drawing on screen, 40
 Logo, saving on projector, 53 to 54

M

Macintosh

- connecting, 88 to 91
- desktop adapter, 88 to 89

Manuals, 3 to 4

Menus

- About, 44, 58 to 59, 67
- Advanced, 44, 57 to 58
- Audio, 44, 51
- changing settings, 44 to 46
- Effect, 44, 52
- Reset All, 44, 59
- Setting, 44, 55 to 56
- User's Logo, 44, 53 to 54
- using, 44 to 46
- Video, 44, 47 to 49

Mouse buttons, 41

N

New Hardware Wizard, 21

No-Signal Msg setting, 55

O

Options for projector, 7

P

P in P (picture in picture) button, 38

Picture source, selecting, 29, 35

Picture, *see* Image

Picture-in-picture video source, selecting, 55

Pin assignments, connector, 105

Pointer tool, 39, 52

Positioning

- image, 26
- projector, 10 to 11

Power

- button, 21
- specifications, 104
- status light, 71

Presenters Online, 3, 80

Preset button, 50

PrivateLine Support, 4, 80

Problems

- color, 78
- image, 73 to 78
- remote control, 79
- sound, 78

Projection lamp, *see* Lamp

Projector

- carrying case, 7, 68
- cleaning, 62 to 64
- connections, *see* Connecting projector
- distance from screen, 10, 103
- feet, adjusting height with, 26
- installing, 82 to 83
- lamp specifications, 104
- options, 7
- positioning, 10 to 11
- resolution, 1, 103
- specifications, 103 to 105
- transporting, 68
- troubleshooting, 69 to 79
- turning off, 30
- turning on, 20
- unpacking, 5 to 6
- viewing information about, 58

Prompt setting, 56

R

Raising image, 26

Rear-screen projection, 82

Registration, 4

Remote control

- information, 97
- numbered buttons, 39
- problems, 79, 97
- specifications, 104
- troubleshooting, 79
- turning on, 34
- using, 33 to 42
- wireless mouse, using as, 41 to 42

Replacing lamp, 64 to 67

Reset All menu, 59

Resetting lamp timer, 67

Resetting menu options, 44, 46, 59

Resizing image, 28, 37
Resolution, 1, 49, 103

S

Safety
instructions, 95 to 96
specifications, 105

Screen
blank, 22 to 24
distance from projector, 10

Screen image
See Image

Setting menu, 44, 55 to 56

Shift button, 77

Sleep mode, 30, 56

Sound
adjusting, 51
turning off (using A/V Mute), 30
see also Audio

Source, selecting, 29, 35

Speaker, specifications, 103

Speakers, connecting to external, 83

Special effects buttons, 39 to 40

Specifications
brightness, 1, 103
dimensions, 104
electrical, 104
environmental, 105
general, 103
lens, 103
remote control, 104
resolution, 1, 103
safety, 105

Spotlight tool, 40, 52

Startup screen, creating, 53 to 54

Status lights, 71 to 73

Stopping action, 36

Support, *see* Technical support

S-Video button, 35, 79

S-Video cable, 6, 15

Switching picture source, 29, 35

Sync buttons, 27, 77

Synchronization, adjusting, 28, 48

T

Technical support, 4, 80

Temperature
requirements, 105
status light, 71

Tone setting, 51

Tracking buttons, 27, 77

Tracking, adjusting, 28, 48

Transporting projector, 68

Treble, adjusting, 51

Troubleshooting
blank screen, 22 to 24
image and sound problems, 73 to 79
projector problems, 69 to 79
remote control problems, 79

Turning off picture (using A/V Mute), 30, 36

Turning off projector, 30

Turning on projector, 20

U

Unpacking projector, 5 to 6

Up arrow button, remote control, 42

USB
audio, 21
cable, 5 to 6, 13, 86, 90

User's Logo menu, 44, 53 to 54

V

Video
button, 29, 35
cables, 5
display settings, viewing, 58
formats, supported, 1, 106 to 107
menu, 44, 47 to 49
picture in picture, 55
selecting source, 29, 35

Video button, 79

Video port pin assignments, 105

Video sources, connecting projector to,
15 to 18

V-Keystone setting, 55

Volume

- adjusting, 29, 36, 51
- button, 29, 36
- setting, 51

W

- Warning lights, 71 to 73
- Warranty, 4
- Workstations, connecting projector to, 93

Z

- Zoom ratio, 103
- Zooming image, 25, 37



Discount-Merchant.com (800) 281-8860

THE TRUSTED SOURCE FOR PROJECTOR LAMPS AND ACCESSORIES

Index 113



Disclaimer

This user manual is provided as a free service by FixYourDLP.com. FixYourDLP is in no way responsible for the content of this manual, nor do we guarantee its accuracy. FixYourDLP does not make any claim of copyright and all copyrights remain the property of their respective owners.

About FixYourDLP.com

FixYourDLP.com (<http://www.fixyourdpl.com>) is the World's #1 resource for media product news, reviews, do-it-yourself guides, and manuals.

Informational Blog: <http://www.fixyourdpl.com>

Video Guides: <http://www.fixyourdpl.com/guides>

User Forums: <http://www.fixyourdpl.com/forum>

FixYourDLP's Fight Against Counterfeit Lamps:

<http://www.fixyourdpl.com/counterfeits>

Sponsors:

RecycleYourLamp.org – Free lamp recycling services for used lamps:

<http://www.recycleyourlamp.org>

Lamp Research - The trusted 3rd party lamp research company:

<http://www.lampresearch.com>

Discount-Merchant.com – The worlds largest lamp distributor:

<http://www.discount-merchant.com>



FixYourDLP.com

Sponsored by 