



Disclaimer

This user manual is provided as a free service by FixYourDLP.com. FixYourDLP is in no way responsible for the content of this manual, nor do we guarantee its accuracy. FixYourDLP does not make any claim of copyright and all copyrights remain the property of their respective owners.

About FixYourDLP.com

FixYourDLP.com (<http://www.fixyourdpl.com>) is the World's #1 resource for media product news, reviews, do-it-yourself guides, and manuals.

Informational Blog: <http://www.fixyourdpl.com>

Video Guides: <http://www.fixyourdpl.com/guides>

User Forums: <http://www.fixyourdpl.com/forum>

FixYourDLP's Fight Against Counterfeit Lamps:

<http://www.fixyourdpl.com/counterfeits>

Sponsors:

RecycleYourLamp.org – Free lamp recycling services for used lamps:

<http://www.recycleyourlamp.org>

Lamp Research - The trusted 3rd party lamp research company:

<http://www.lampresearch.com>

Discount-Merchant.com – The worlds largest lamp distributor:

<http://www.discount-merchant.com>



FixYourDLP.com

Sponsored by 

EPSON® PowerLite® 8150i User's Guide

EPSON®

EPSON® PowerLite® 8150i
Multimedia Projector



EPSON® PowerLite® 8150i
Multimedia Projector

 FixYourDLP.com
Sponsored by 

Discount-Merchant.com (800) 281-8860
THE TRUSTED SOURCE FOR PROJECTOR LAMPS AND ACCESSORIES

**EPSON® PowerLite® 8150i
Multimedia Projector**

User's Guide



Discount-Merchant.com (800) 281-8860
THE TRUSTED SOURCE FOR PROJECTOR LAMPS AND ACCESSORIES

Important Safety Information

WARNING: Never look into the projector lens when the lamp is turned on; the bright light can damage your eyes. Never let children look into the lens when it is on. Never open any cover on the projector, except the lamp and filter covers. Dangerous electrical voltages inside the projector can severely injure you. Except as specifically explained in this *User's Guide*, do not attempt to service this product yourself. Refer all servicing to qualified service personnel.

WARNING: The projector and its accessories come packaged in plastic bags. Keep plastic bags away from small children to avoid any risk of suffocation.

Caution: When you replace the lamp, never touch the new lamp with your bare hands; the invisible residue left by the oil on your hands may shorten the lamp life. Use a cloth or glove to handle the new lamp.

Copyright Notice

All rights reserved. No part of this publication may be reproduced, stored in a retrieval system, or transmitted in any form or by any means, electronic, mechanical, photocopying, recording, or otherwise, without the prior written permission of SEIKO EPSON CORPORATION. The information contained herein is designed only for use with this EPSON product. EPSON is not responsible for any use of this information as applied to other products.

Neither SEIKO EPSON CORPORATION nor its affiliates shall be liable to the purchaser of this product or third parties for damages, losses, costs, or expenses incurred by purchaser or third parties as a result of: accident, misuse, or abuse of this product or unauthorized modifications, repairs, or alterations to this product, or (excluding the U.S.) failure to strictly comply with SEIKO EPSON CORPORATION's operating and maintenance instructions.

SEIKO EPSON CORPORATION shall not be liable for any damages or problems arising from the use of any options or any consumable products other than those designated as Original EPSON Products or EPSON Approved Products by SEIKO EPSON CORPORATION.

EPSON is a registered trademark of SEIKO EPSON CORPORATION.

SizeWise is a trademark; Extra Care and EPSON Store are service marks; and PrivateLine and PowerLite are registered trademarks of Epson America, Inc.

General Notice: Other product names used herein are for identification purposes only and may be trademarks of their respective owners. EPSON disclaims any and all rights in those marks.

Contents

Introduction

Getting the Most from Your Projector	2
Using Your Documentation	4
Reading This Manual Online	4
Getting Help	5

1 *Presenting Without a Computer*

Creating Your Presentation	8
Supported Applications and File Formats	8
Creating Scenarios	8
Transferring Your Presentation to the Projector	11
Sending the Presentation from Your Office	11
Downloading Your Presentation While in the Meeting Room	13
Copying Your Presentation Directly to the Memory Card	16
Delivering Your Presentation	17
Highlighting Your Presentation	20
Choosing a Drawing Tool	20
Drawing on the Screen	23
Saving Your Drawings and Notes	25

2 *Presenting from a Laptop or VCR*

Positioning the Projector	30
Connecting to a Laptop	31
Connecting the Computer Video Cable	31
Connecting the Mouse Cable	34
Connecting the Audio Cable	35
Connecting to a Video Device	36

3 *Displaying and Adjusting the Image*

Displaying an Image	38
Turning On the Projector	38
Selecting the Image Source	39



FixYourDLP.com

Sponsored by

Discount-Merchant.com (800) 281-8860

THE TRUSTED SOURCE FOR PROJECTOR LAMPS AND ACCESSORIES

Adjusting the Image and Sound	41
Focusing and Zooming Your Image	41
Adjusting the Height of Your Image	42
Adjusting the Image Shape	43
Resizing the Image	44
Adjusting the Volume	44
Turning On the Projector Automatically	45
Shutting Down the Projector	47

4 *Using the Remote Control*

Turning On the Remote Control	50
Using the Remote Control as a Wireless Mouse	51
Controlling the Picture and Sound	53
Switching Between Picture Sources	53
Adjusting the Volume	53
Turning Off the Picture and Sound	54
Stopping Action	54
Zooming Your Image	54
Displaying Picture-in-Picture Video	55
Highlighting Your Presentation	56
Using the Pointer	56
Using Box Highlights	57
Spotlighting Your Image	57
Using Horizontal and Vertical Highlights	58
Clearing the Screen	58

5 *Solving Problems*

Using On-Screen Help	60
What To Do When the Lights Flash	61
Solving Problems with the Image or Sound	62
Solving Problems with the Remote Control	69
Solving Problems with EasyMP.net	70
Where To Get Help	72
Telephone Support Services	72

.....	75
-------	----



Discount-Merchant.com (800) 281-8860

— THE TRUSTED SOURCE FOR PROJECTOR LAMPS AND ACCESSORIES

Introduction

Follow these guidelines when reading this manual:

warnings

Warnings must be followed carefully to avoid bodily injury.

cautions

Cautions must be observed to avoid damaging your equipment.

notes

Notes contain important information and useful tips.

The EPSON® PowerLite® 8150i is a highly versatile presentation tool. You can connect it to one or two computer sources and up to three video sources and easily switch between them. In addition, the projector's EasyMP.net features let you transfer presentations directly to the projector (over a network) and then deliver them without having to connect a PC or laptop.

See the following pages to learn about:

- Getting the most from your projector
- Using your documentation
- Getting help

Getting the Most from Your Projector

Depending on how you plan to use the projector, you can take advantage of the following options:

- **Presenting without a computer**

If the projector is connected to your network, you can use its EasyMP.net features to transfer your presentation directly to the projector. This lets you walk into the meeting room hands-free and deliver your presentation without having to connect a PC or laptop.

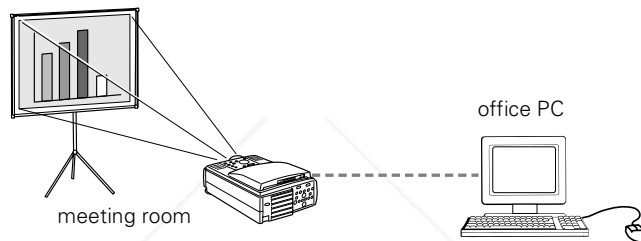

EasyMP.net lets you project various Microsoft® applications—such as PowerPoint®, Excel, and Word—as well as certain types of image files. For instructions, see Chapter 1 starting on page 7.

- **Connecting a computer or video device**

If you're not using EasyMP.net, you'll need to connect the projector directly to a computer or video device. See page 30 for guidelines on positioning the projector. Then turn to page 31 to connect a Macintosh® or PC, or page 36 to connect a VCR, DVD player, or other type of video device.

When done connecting your equipment, turn to Chapter 3 starting on page 37 for instructions on displaying and adjusting the image.

- **Using the remote control**

You can use the remote control to start and run your presentation, control the picture and sound, and highlight your presentation by using it as a digital pointer. If you're giving a PowerPoint presentation, you can use the remote as a wireless mouse to click through from one slide to the next. See Chapter 4 starting on page 49 for details.

- **Drawing on the screen**

If you're using EasyMP.net, you can connect a USB device, such as a mouse or drawing tablet, directly to the projector. This lets you draw on the screen, make notes, and highlight your presentation. See page 20.

If you don't have access to a USB mouse or tablet, you can use the projector's EMP Tablet software to draw on screen using your laptop's mouse; see page 21. (You can also connect a drawing tablet to your laptop.) Your laptop needs to be on the network, but if it's equipped with a wireless Ethernet card, you won't have to worry about connecting any cables before starting your presentation.

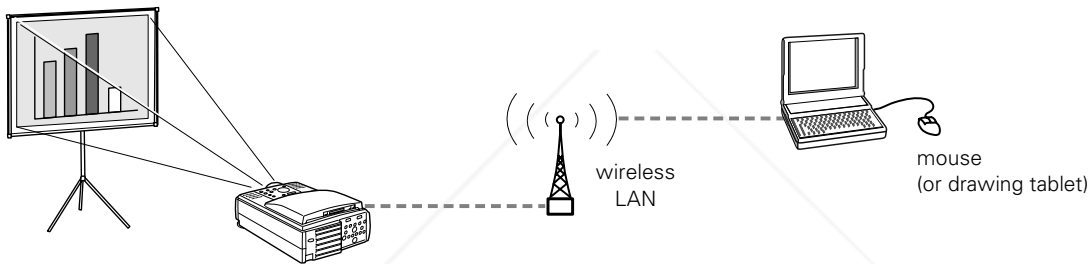

Whichever drawing tool you choose, keep in mind that it can also be used in place of the remote control to operate the EasyMP.net software and deliver your presentation.

- **Including sound in your presentation**

If you've connected a computer or video device and your presentation includes sound, you can take advantage of the projector's built-in stereo speaker system. For details, see page 35 (for computers) or page 36 (for video devices).

Using Your Documentation

This book contains all the information you need to operate your projector and its software. For complete setup and maintenance information, or to order additional parts and accessories, see the projector *Administrator's Manual*.

Reading This Manual Online

The projector CD-ROM includes an electronic copy of this manual. You may find it convenient to copy it onto your computer's hard drive so it's always with you. Just insert the CD-ROM in your CD-ROM drive, select the **Install/View Documentation** button and click **Install User's Guide** or **View User's Guide**.

To view your electronic manual, you need to use Adobe® Acrobat®. If you don't have it, you can install it from the CD-ROM.

When you open the manual, you see this screen:

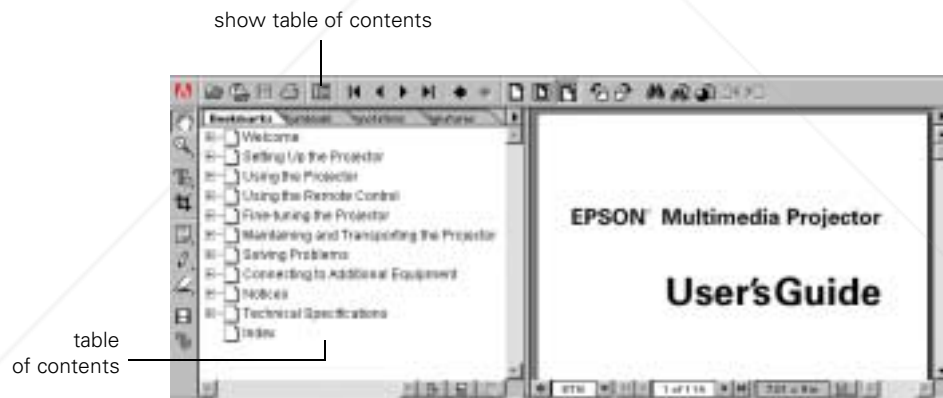

note

If the hand icon changes to an index finger when you pass the mouse pointer over a text link, you can click the link to jump to a related topic

You can move quickly to the top of your choice by clicking in the table of contents on the left side of the screen. You can also use the arrows in the toolbar or the vertical scroll bar on the right side of the screen to move through the manual.

For more information, see your Adobe Acrobat online guide.

Getting Help

If you experience a problem with the projector, check with your network or projector administrator first. You can also check for troubleshooting tips in Chapter 5 starting on page 59.

If you still need help after checking these sources, you can use the EPSON PrivateLine® Support service. Call (800) 637-7661 and enter the PIN on the PrivateLine card in the projector *Owner's Kit*. Or take advantage of EPSON's automated support services 24 hours a day. See "Where To Get Help" on page 72 for more information.



Discount-Merchant.com (800) 281-8860
THE TRUSTED SOURCE FOR PROJECTOR LAMPS AND ACCESSORIES



Discount-Merchant.com (800) 281-8860

THE TRUSTED SOURCE FOR PROJECTOR LAMPS AND ACCESSORIES

1

Presenting Without a Computer

If the projector is connected to the network, you can use its EasyMP.net features to deliver your presentation without having to connect a PC or laptop. (If you plan to connect a computer or video device, see Chapter 2 for instructions.)

If your network is set up for it, you can start your presentation without having to download any files to the projector beforehand (the projector can receive the data while your presentation is running); see “Delivering Your Presentation” on page 17 for instructions. Otherwise, you’ll have to copy your files to the projector’s memory card (either directly or over the network) before starting your presentation; see page 11.

Follow the instructions in this chapter to:

- Create your presentation
- Transfer your presentation to the projector
- Deliver your presentation
- Highlight your presentation with drawings and notes



Discount-Merchant.com (800) 281-8860

THE TRUSTED SOURCE FOR PROJECTOR LAMPS AND ACCESSORIES

note

For help designing your presentation, log on to www.presentersonline.com. This site includes a library of articles covering presentation tips and tricks, and provides templates and clip art you can use.

Creating Your Presentation

Follow the guidelines below to create your presentation in a file format that's compatible with the projector. You can use a variety of Microsoft application files and image files in their native formats, or you can prepare a specially modified file called a *scenario*. The scenario lets you combine different kinds of files in a slideshow format and set certain automatic playback features.

Supported Applications and File Formats

EasyMP.net supports a variety of Microsoft applications and image formats. You can create your presentation using any of the following:

- PowerPoint 97 and 2000
- Word 97, 98, and 2000
- Excel 97 and 2000
- text (including unicode) and rich text format (RTF)
- jpeg (JPG), bitmap (BMP and DIB), and portable network graphics (PNG)

EasyMP.net supports multi-page Word documents as well as multi-sheet Excel files. Note that you can't edit documents while viewing them on screen, and certain applications' formatting features may look slightly different from how they appear on your monitor. (For example, some PowerPoint special effects cannot be used; for details, see the Notices section in the *Administrator's Manual*.)

Creating Scenarios

Another type of file you can send to the projector is a scenario. You can create this special-purpose file using the EMP Scenario software included with the projector. This lets you combine in a slideshow format any of the supported file types listed above. In addition, you can define certain playback attributes, such as how long each slide remains on screen, and you can even set the scenario to begin playing automatically—either when the projector is first turned on, or at a preset time.

To create a scenario, follow these steps:

1. Open the EMP Scenario program from your desktop or from the EasyMP programs folder.
2. To create a scenario, use the folder window to navigate to the files you want to use. Available files appear in the file window:

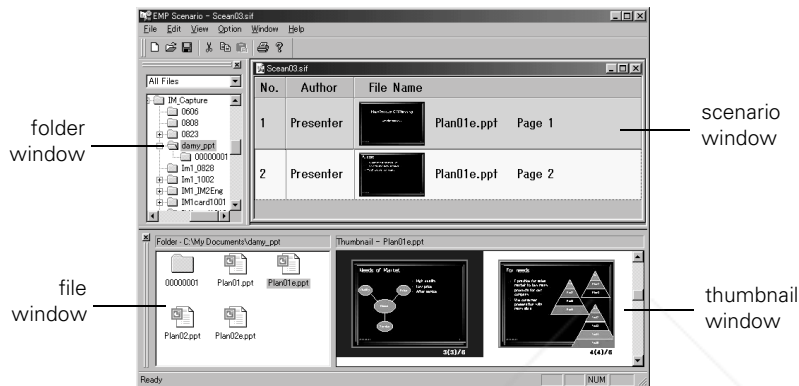

3. Drag the files you want to use from the file window to the scenario window.

If you want to incorporate individual slides from a PowerPoint file, double-click the file in the file window, then drag the slides that open in the thumbnail window to the scenario window.

4. If you want the scenario's slides to advance automatically when played, select them in the scenario window. Right-click, choose **Properties**, then set the length of time you want each slide to remain on the screen.
5. To transfer the completed scenario to the projector, select **File, Send scenario**; select the projector's name from the list that appears on screen. If you have a laptop with a PCMCIA slot, you can also copy the scenario directly onto the memory card; select **Local Drive** instead of the projector's name. See page 16 for instructions on removing and inserting the card in the projector.

note

For more information on creating scenarios, see the online help in the EMP Scenario program.

Once the scenario has been transferred to the projector, you can view it using Easy View:

1. Start Easy View as described on page 17. Then highlight the scenario's file name and click **Play**.
2. To advance to the next slide, press the **Esc** button on the remote control (or right-click with your mouse), then click the ► forward arrow in the navigation menu that appears on the screen:

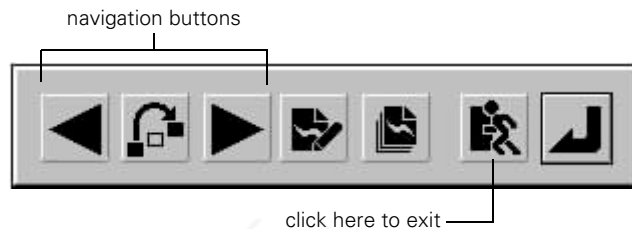

3. To exit your presentation early (before showing the last slide), click the  exit icon.

If you want a scenario to start playing automatically when the projector is first turned on, select it in Easy View and click **Properties**, then select **Play Automatically**. (You can also set the scenario to repeat automatically or delete itself after playing.) To make the projector itself turn on automatically (at a preset time), see page 45.

To delete a scenario, select it in Easy View and click the **Delete** icon.

Transferring Your Presentation to the Projector

Follow the instructions in this section to transfer a supported application or image file directly to the projector; to copy a scenario to the projector, see the previous section.

When you send your presentation to the projector, it gets stored on the projector's removable memory card. Depending on how your network is set up and where you're located, choose one of these ways to transfer your presentation to the projector:

- To send your presentation from your office PC to the projector, see below.
- If you're in the meeting room with the projector and you need to download your presentation files from a remote location, see page 13.
- If you want, you can copy your presentation directly onto the memory card; see page 16.

Sending the Presentation from Your Office

If you've created your presentation on your office PC, the easiest way of getting it to the projector is by using the EMP File Utility software; see below.

If your network is set up to prevent sending a presentation directly to the projector, you may have to upload it to a file server first. Use the file utility you would normally use (such as Windows® Explorer) to transfer your presentation to the server; then see "Downloading Your Presentation While in the Meeting Room" on page 13 to finish getting your presentation to the projector.

Using the EMP File Utility Software

Follow these steps to send your presentation to the projector:

1. Click Start, Programs, EasyMP, then select EMP File Utility.

note

You may be able to launch your presentation without first transferring it to the projector; see page 17.



Discount-Merchant.com (800) 281-8860

THE TRUSTED SOURCE FOR PROJECTOR LAMPS AND ACCESSORIES

Presenting Without a Computer 11

You see this screen, with the files on your PC listed on the left:

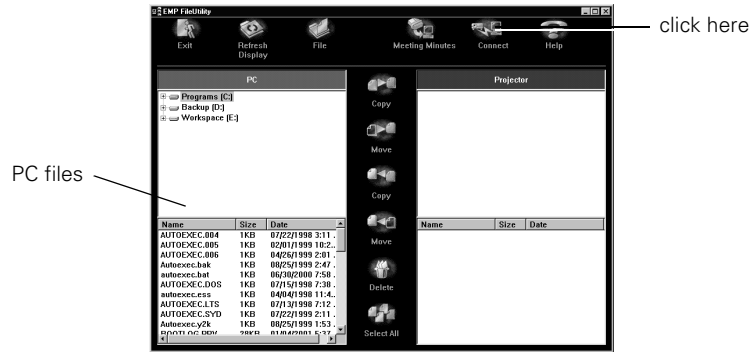

2. Click the **Connect** icon, as shown above. You see this screen:

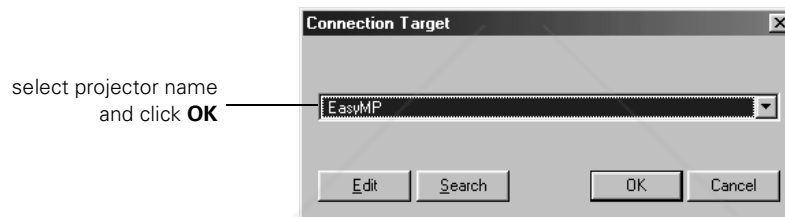

3. Select the name of your projector, then click **OK**. (If necessary, click the ▼ drop-down arrow and select the correct projector from the list. If it isn't listed, you may need to click the **Search** button; see the *Administrator's Manual* for details.)

All files currently stored on the projector appear on the right, as shown:

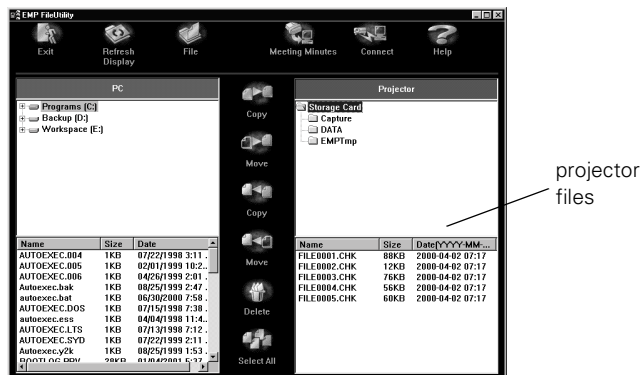

note

You can click the **File** icon to create a new folder, or to rename an existing file or folder.



Discount-Merchant.com (800) 281-8860

THE TRUSTED SOURCE FOR PROJECTOR LAMPS AND ACCESSORIES

- To copy your presentation to the projector, highlight its name on the left side of the screen, then highlight the folder's name where you want to copy it on the right side of the screen. Then click the  copy icon.

When you're done transferring your presentation, see page 17 for instructions on projecting it. For additional information on using the EMP File Utility, see the online help.

Downloading Your Presentation While in the Meeting Room

If you're in the meeting room and want to copy files to the projector that are in a remote location (such as on a file server or another PC on the network), you can use the projector's Easy File utility. You'll need to use one of the following to control the projector:

- the remote control (see page 51)
- a USB device (mouse, tablet, and/or keyboard) directly connected to the projector (see page 20)
- the EMP Tablet software (on a networked PC in the meeting room); see page 21

Follow these steps:

- Turn on the projector as described in "Displaying and Adjusting the Image" on page 37.
- If necessary, select **EasyMP.net** as the source. (Press the **EasyMP.net** button on the remote control.) You see this screen:



click here

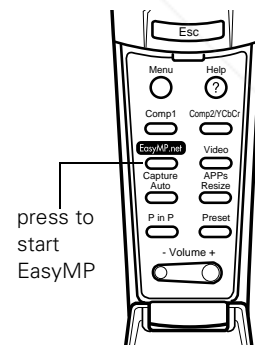

press to start EasyMP

- Click the **Easy File** icon.

You see this screen, with the files on the projector listed on the left:

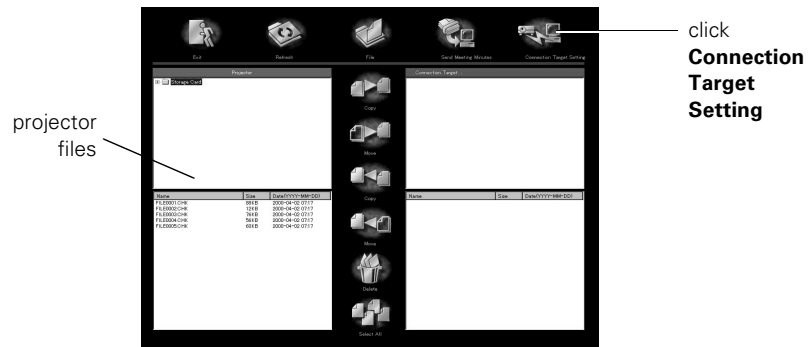

4. Click **Connection Target Setting**, as shown above.

You see this screen:

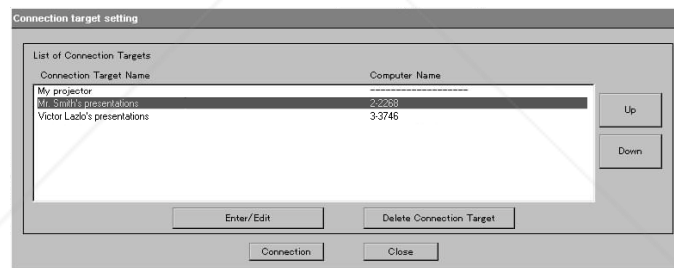

5. Select the name of the PC (or shared folder) where your presentation is located, then click **Connection**. (If the computer or folder name isn't listed, contact your projector or network administrator to have it added.)

All files currently stored on the connected computer appear on the right side of the screen:

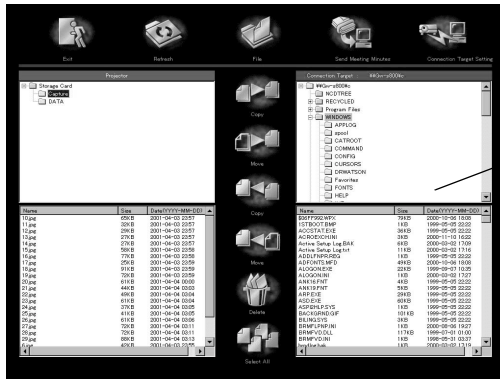

files on
connected
PC

note

You can click the *File* icon to create a new folder, or to rename an existing file or folder. If you need to type a file or folder name, use a USB keyboard or a PC running the EMP Tablet software.

- To copy your presentation to the projector, highlight its name on the right side of the screen, then highlight the projector folder where you want to copy it on the left side of the screen. Then click the  copy icon.

When you're done transferring your presentation, see page 17 for instructions on delivering it.

Copying Your Presentation Directly to the Memory Card

If you have a laptop with a PCMCIA slot, you can insert the projector's memory card in the slot and copy your presentation directly onto the card. Before starting your presentation, you'll need to place the card in the projector as described below.

1. If necessary, remove the memory card that's already in the projector. Press the button to the left of the card slot to eject the card:

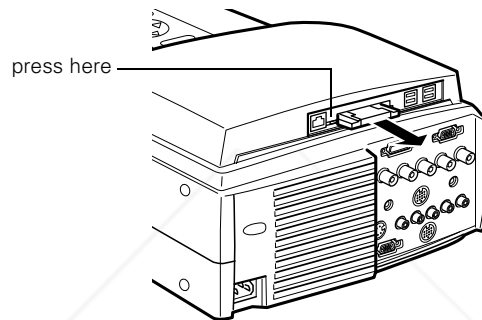

If the button is recessed, press and release it so that it extends. Then press it a second time to eject the card.

2. If using a CompactFlash™ card, place the card in the card adapter:

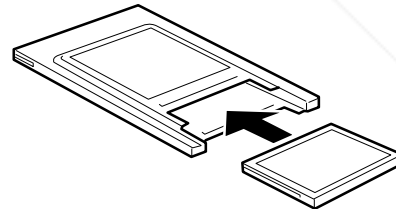

3. Insert the card (with the adapter) into the projector's card slot:

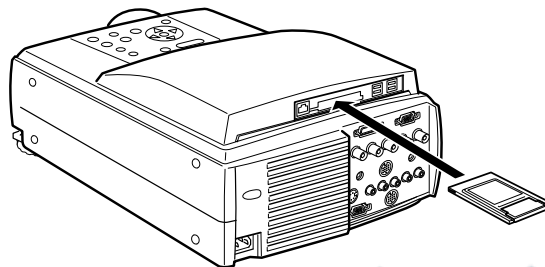

Delivering Your Presentation

If your presentation is on a remote PC (you haven't copied it to the projector's memory card), you can start and run it as long as the projector and the PC are on the same network. Otherwise, you'll have to copy your presentation to the projector's memory card, as described on page 11, before starting your presentation.

Follow these steps to start your presentation:

1. Turn on the projector as described in "Displaying and Adjusting the Image" on page 37.
2. If necessary, select **EasyMP.net** as the source. (Press the **EasyMP.net** button on the remote control.) You see this screen:

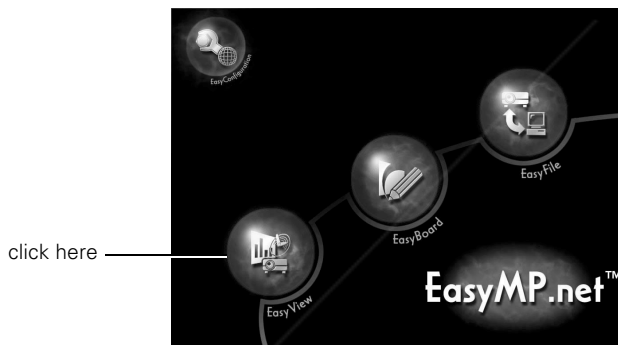

note

If you're in the meeting room and want to project a file that's on your laptop, simply drag it onto the EMP Tablet icon on your desktop. The file opens automatically on screen.

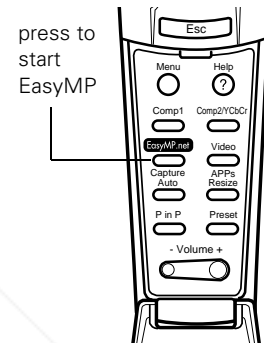

3. Using the **Enter** button on the remote control (see page 51), click the **Easy View** icon. You see this screen:

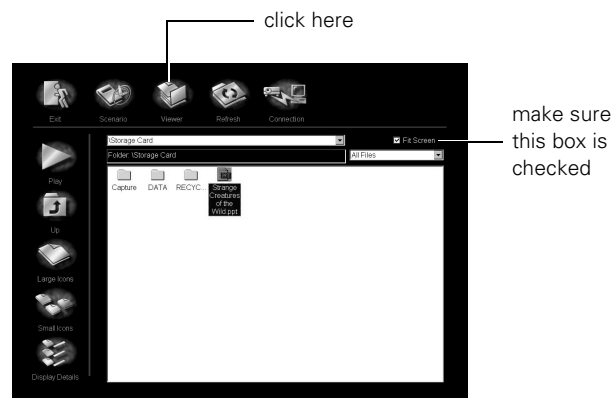

note

You can also use a **USB mouse** or **drawing tablet** (page 20) or the **EMP Tablet software** (page 21) instead of the remote control to operate the projector.

note

To ensure that your images display correctly, make sure **Fit to screen** is selected in the Viewer window.

4. Click **Viewer** as shown in the previous screen.
5. Do one of the following:
 - If your presentation is on the projector's memory card, locate its file name in the file window.
 - If your presentation is on a remote PC, click the **Connection** icon at the top of the screen. Enter the name of the remote computer and its shared drive or folder name, then click **Connection**. You may need to contact your network administrator for assistance in determining the computer's name.

If you've connected to this computer before, you can select its name from the drop-down list as shown below:



Once you're connected, locate the presentation's file name in the file window.

6. To start your presentation, double-click its file name, or highlight it and click the  **Play** icon.

Follow these guidelines when viewing your presentation:

- If you're showing a Microsoft Word or Excel file, you can move through it using the scroll bars on the sides of the screen.

Excel spreadsheet tabs

Regional	National	Baseline	West			East		
	Revenue	COG	Expenses	Revenue	COG	Expenses	Revenue	
Jan	\$45,263	\$33,578.72	\$31,625.46	\$8,506.71	\$43,740.49	\$39,007.37	\$40,183.1	
Feb	9,330	5,205	9,897	87	13,266	22,502	5,111	
Mar	30,032	22,786	24,808	408	37,096	26,455	38,111	
Apr	17,559	17,649	47	7,823	14,425	32,947	17,111	
May	3,442	2,442	30,234	3,571	6,378	17,667	4,111	
Jun	3,208	16,906	1,098	3,245	15,865	10,166	5,111	
Jul	15,515	27,009	10,271	5,067	11,260	26,807	19,111	
Aug	23,544	24,676	22,018	5,087	22,483	22,521	26,111	
Sep	35,727	8,920	26,085	6,913	11,695	18,422	8,111	
Oct	5,982	596	18,668	2,305	6,192	17,338	28,111	
Nov	5,359	17,210	8,234	6,454	17,363	26,506	19,111	
Dec	42,734	27,832	10,813	5,584	28,194	29,165	25,111	
Total	\$237,695	\$204,809	\$193,799	\$55,053	\$227,958	\$289,506	\$241,111	

scroll bars

If you're displaying a multi-page Excel spreadsheet, you can jump to a different page by clicking one of the tabs at the top of the screen.

- When viewing a PowerPoint presentation, press the **Enter** button on the remote control to advance to the next slide. To return to the previous slide, press the **Esc** button and then click the **◀** back arrow in the menu that appears on the screen:

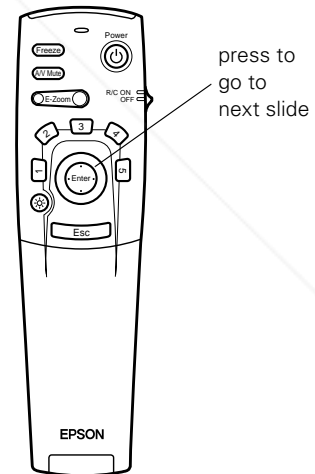
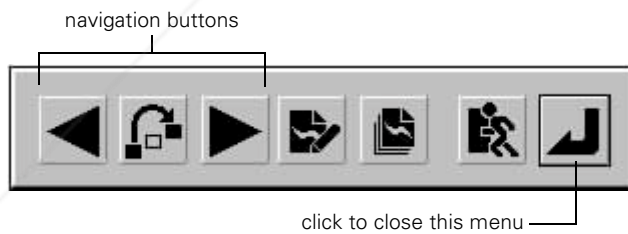

You can also click the jump icon and then use the arrow buttons to go directly to the slide of your choice. When done making your selection, click the return icon to close the navigation menu and continue with your presentation.

When you're done with your presentation, press the **Esc** button on the remote control, then click the exit icon to return to Easy View.

Highlighting Your Presentation

You can highlight your presentation with special symbols or your own drawings, and you can annotate it with on-screen text. For simple pointer effects, you can use the remote control, or for more sophisticated effects you can use a mouse or drawing tablet.

Choosing a Drawing Tool

If all you want to do is place simple figures on the screen—such as an arrow or an underline to highlight key points—you can use the remote control to guide the cursor. For details, see page 52.

To make actual drawings, or to write text on the screen, you can use either a mouse or drawing tablet. (A drawing tablet works best.) If you have a USB mouse or a Wacom Graphire™ tablet, you can connect it directly to the projector's USB port as described below. Otherwise you'll need to use the projector's EMP Tablet program on a PC or laptop that's networked to the projector; see page 21.

Using a USB Mouse or Tablet

To connect a USB mouse or Wacom Graphire drawing tablet directly to the projector, plug it into one of the four USB ports on the back of the projector as shown:

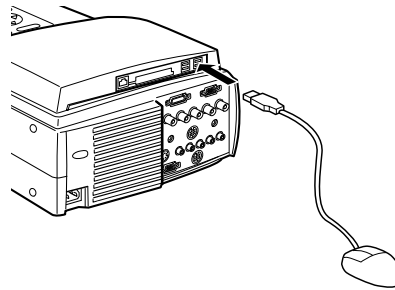

When drawing with the tablet, note that you can use the upper end of the pen as an eraser. Keep in mind that you can also use the pen to click and double-click like a regular mouse. Tap the tip of the pen against the tablet's surface to click or double-click; to right-click, press the lower part of the button on the side of the pen.

note

Other drawing tablet models won't work with this projector.

A special template comes with the projector that you can place under the tablet's clear plastic overlay. The template includes the same highlighting tool icons and toolbar functions as the EMP Tablet software, described in the next section.

Using the EMP Tablet Software

If you have a PC or laptop on the same network as the projector, you can use the EMP Tablet software to control the projector and draw on the screen. You can use either your laptop's mouse or a drawing tablet connected to the laptop. Note that you can use any model of tablet that's compatible with your laptop.

To open EMP Tablet, follow these steps:

1. Click Start, Programs, EasyMP, then click EMP Tablet.

You see this screen:

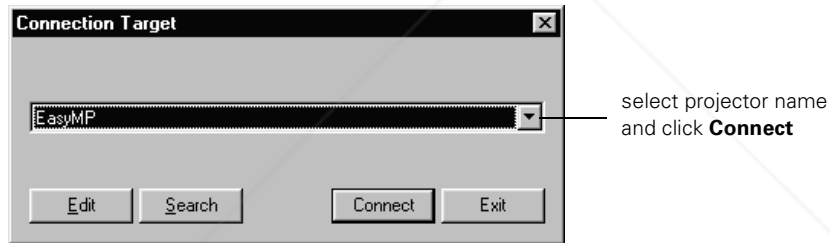

2. Select the name of your projector, then click **Connect**. The EMP Tablet software opens on your laptop:

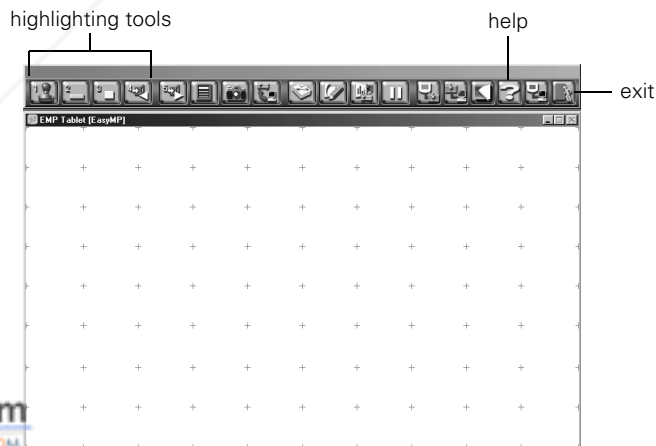



note

When EMP Tablet is open, you can use your keyboard to type text in dialog boxes on screen.

3. While viewing the projected image, use your laptop's mouse or drawing tablet to control the cursor. In some cases, you may need to move or resize the EMP Tablet window on your laptop to be able to guide the cursor near the edge of the projected image.

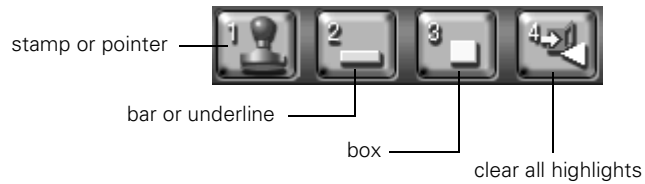
You can use the buttons at the top of the screen to change the cursor to various highlighting marks, as shown:



The other buttons on the toolbar give you access to various projector features. If you're unsure of what a button is for, you can hold the cursor over it until a mouseover text appears. Or click the  help button for more information.

4. When you're done using EMP Tablet, click the  exit icon to close it.

Drawing on the Screen

You can draw and write either on a projected image, as described below, or on a blank screen (using it like a digital white board). Follow the instructions in the sections below.

Drawing on a Projected Image

Follow these steps to sketch or make notes on an image you're projecting:

1. Begin by displaying the image you want to view. It can be a PowerPoint slide, Excel spreadsheet, or any other type of image supported by the projector.
2. Right-click with the mouse. (If you're using the drawing tablet, press the lower part of the button on the side of the pen.)

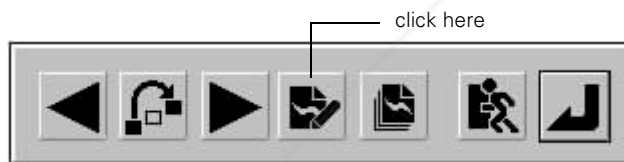

Expenses	Revenue	COG
\$31,625.46	\$8,506.71	\$43,740.49
9,897	87	13,266
24,808	408	37,096
47	7,823	14,425
30,234	3,571	6,378
1,098	3,245	15,865
10,271	5,067	11,260
22,018	5,067	22,483
26,085	6,913	11,695
18,668	2,305	6,192
8,234	6,454	17,363
10,811	5,584	28,194
\$193,749	\$55,053	\$227,958

You see the menu shown below:

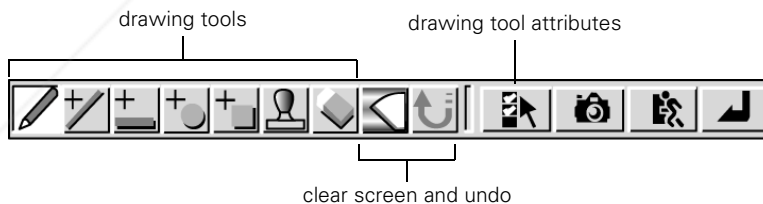

3. Click the  drawing tool icon. The cursor changes to a pencil, letting you draw.
4. To change from a pencil tool to a different drawing tool, right-click. You see this menu:



Select one of the other drawing tools as shown. You can adjust drawing tool attributes by clicking the  checkbox icon; a second menu appears on screen. After making your selections, click the  return icon to close both menus and resume drawing.

5. When done drawing on screen, right-click, then click the  exit icon to continue your presentation. (Your drawings and notes will be erased; to save them, see page 25.)

Drawing on a Blank Screen

If you prefer, you can draw or make notes on a blank screen.

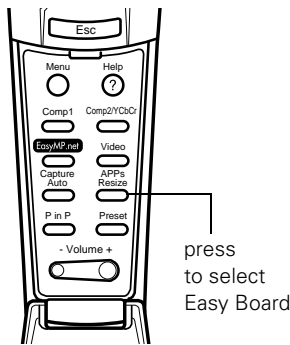

1. Do one of the following:



- If using the remote control, press the APPs (applications) button, then select Easy Board.
- If you're using a drawing tablet or the EMP Tablet software, click the  APPs icon on the toolbar, then select Easy Board.
- If the EasyMP.net main menu screen is visible, click the Easy Board icon:

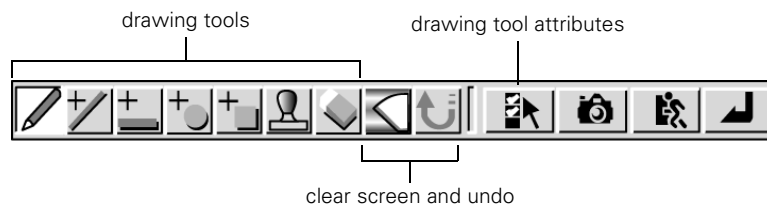

A white screen appears and the cursor changes to a pencil, letting you draw.

2. To change from a pencil tool to a different drawing tool, right-click. You see this menu:



Select one of the other drawing tools as shown. You can adjust drawing tool attributes by clicking the  checkbox icon; a second menu appears on screen. After making your selections, click the  return icon to close both menus and resume drawing.

- When done drawing on screen, right-click, then click the  exit icon. (Your drawings and notes will be erased; to save them, see the next section.)

Saving Your Drawings and Notes

You can capture images displayed on the screen, including your drawings and notes, and save them on the projector's memory card. This lets you view them at a later time.

You can also share your captured images by transferring them to other systems on the network. You can copy them as individual JPEG files, or you can use the projector's "meeting minutes" function to combine them into a single HTML file. This lets you (and others) view them on a PC using a standard web browser.

Capturing an Image

To capture a displayed image, do one of the following:

- Using the remote control, press the **Capture** button as shown.
- If you're using a drawing tablet or the EMP Tablet software, click the  capture icon.
- If you're currently using one of the drawing tools, right-click with your mouse. You see this menu:



Click the capture icon as shown.

The image is saved as a numbered file (1.jpg, 2.jpg, etc.) in the memory card's Capture folder. If you wish to display it on screen, use Easy View as described on page 17. To send it to other systems on the network, see the next section.

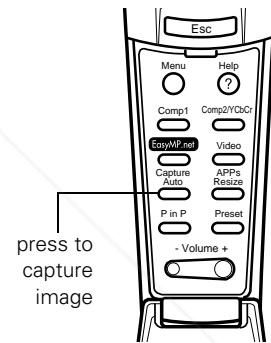

note

If you're using the EMP Tablet software, you can save the image directly to your laptop instead of to the projector's memory card. Click this toolbar icon:



Sharing Captured Images

If you wish to copy your captured JPEG files to another system without first converting them to HTML, do one of the following:

- If you're in the meeting room, you can copy the files to a remote PC or file server using Easy File as described on page 13.
- If you're in your office, you can download the files to your computer using the EMP File Utility software as described on page 11.

If you prefer to save the captured images as an HTML file (so you can view them later using a web browser), follow these steps:

1. Do one of the following:
 - If using the remote control, press the APPS (applications) button, then select Easy Review.
 - If you're using a drawing tablet or the EMP Tablet software, click the  APPS icon on the toolbar, then select Easy Review.
 - If the EasyMP.net main menu screen is visible, click the EasyMP.net icon in the lower-right, then select Easy Review from the applications menu:

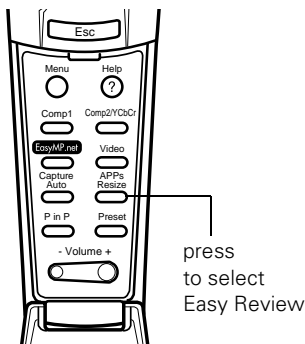

applications menu

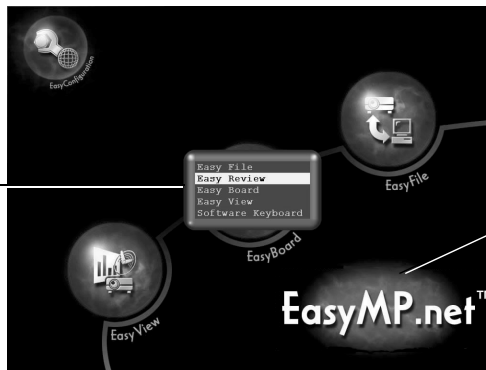

click here to show the applications menu

You see the Easy Review screen:

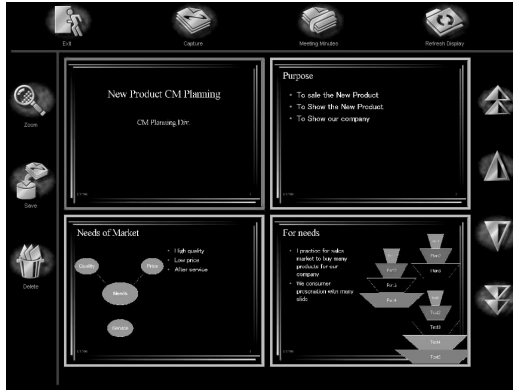

note

You can enlarge an image by selecting it and clicking the Zoom icon. To return to normal view, right-click and select Exit Zoom Display.

2. Delete any images you don't want to save by selecting each image and clicking the Delete icon.
3. To save the remaining images as an HTML file, click the Save icon. You see this screen:

4. Enter a name for your meeting minutes and, optionally, a password. To type the name, use one of the following:
 - a USB keyboard directly connected to the projector (connect it as you would a USB mouse or tablet, as shown on page 20)
 - your computer's keyboard if you're using the EMP Tablet software (see page 21)

note

To enter a password for the meeting minutes, you can use the numbered buttons (1 through 5) on the remote control.

5. Click Save.

Once the captured images have been saved, you can view them on the projector at a later time by clicking the  **Meeting Minutes** icon at the top of the Easy Review screen. While viewing meeting minutes, you can click **Add** to append additional captured images to your meeting minutes file, or click **Delete** to remove an individual image or delete the entire file.

note

*You can also download the meeting minutes to your office PC using the EMP File Utility software. After connecting to the projector (see page 11), click the **Meeting Minutes** icon at the top of the screen; make sure your meeting minutes file is selected, then click **Copy** to transfer it to your PC.*

To transfer the saved meeting minutes to another system on the network, follow these steps:

1. Open Easy File, as described on page 13, and connect with the computer to which you want to transfer the files.
2. Click the  **Send Meeting Minutes** icon.
3. Make sure the meeting minutes file you want to transfer is selected. Then select the folder on the computer to which you want to transfer it and click **Copy**.

The meeting minutes are saved on the computer with the date and time they were created as part of the file name. To view the file, use a standard web browser such as Microsoft Internet Explorer.

2

Presenting from a Laptop or VCR

If you're presenting from a laptop, you'll need to connect it to the projector as described in this chapter. If you're presenting a video, you'll need to connect your VCR, DVD player, or other video device. Except as noted, all cables required for the connections described in this chapter are included with the projector.

You'll find instructions in this chapter for the following:

- Positioning the projector
- Connecting to a laptop (PC or Macintosh)
- Connecting to a video device



Discount-Merchant.com (800) 281-8860

THE TRUSTED SOURCE FOR PROJECTOR LAMPS AND ACCESSORIES

Positioning the Projector

caution

- Don't hold or lift the projector by the lens, or you may damage it.
- Make sure there is plenty of space for ventilation around and under the projector.

You can place the projector approximately 3.1 to 48 feet from the screen when equipped with the standard lens. Use the figure below as a guideline to help you determine the projector's placement.

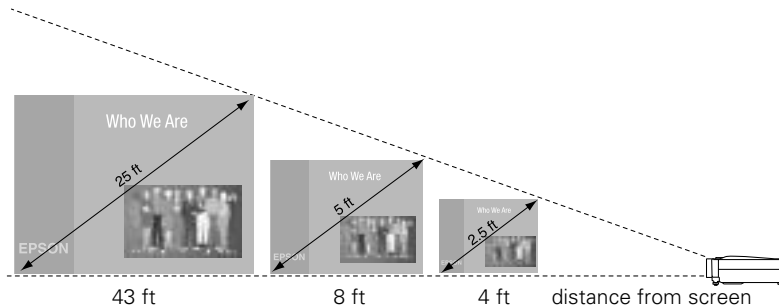

Keep in mind that the image size generally increases with distance, but may vary depending on how you position the zoom ring and whether you have adjusted the image size with other settings.

After positioning the projector, you may wish to connect a Kensington MicroSaver® anti-theft device to the lock port on the projector's left side. You can purchase this from EPSON; see the *Administrator's Manual* for details.

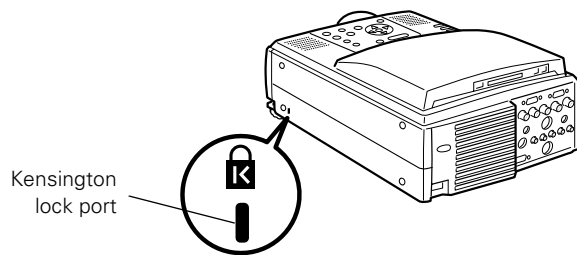

Connecting to a Laptop

Follow the instructions in this section to connect a laptop (PC or Macintosh) to the projector. The connections you make depend on how you plan to use the projector:

- To project computer images, you need to connect the computer video cable as described below.
- If you want to use the remote control in place of your computer's mouse (for example, to click through slideshow presentations), you need to connect the mouse cable as described on page 34.
- If you want to use the projector's built-in sound system, you need to connect an audio cable as described on page 35.

Before beginning, turn off the projector and computer if they are on.

When done making the connections, turn to “Displaying and Adjusting the Image” on page 37 to start your presentation.

Connecting the Computer Video Cable

To project images output from your laptop, connect the computer video cable as described below.

1. Connect one end of the VGA computer video cable to the projector's Computer 1 (VGA) port.

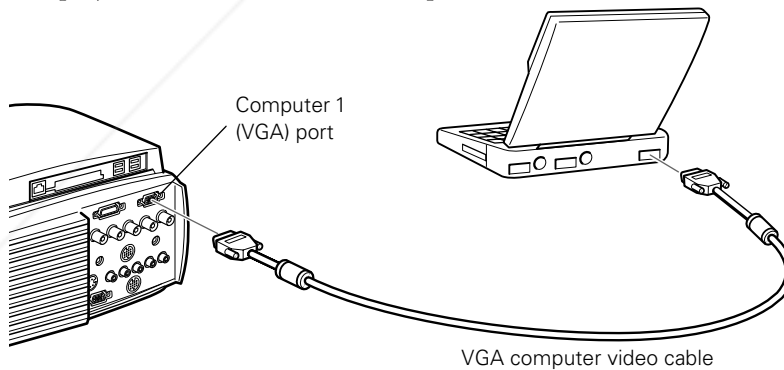

2. Connect the other end of the cable to the laptop's video (monitor) port.
3. Tighten the screws on the connectors.

note

If you have an iBook™ with an RCA video-out port, follow the instructions for connecting to a video device on page 36.

For other types of computer connections, see the Administrator's Manual.

note

If you have an older PowerBook®, you may need a special connector. See page 32.

4. Make sure the **Computer 1** switch is flipped to the right, as shown. If necessary, use the tip of a pen or a small screwdriver to slide it over.

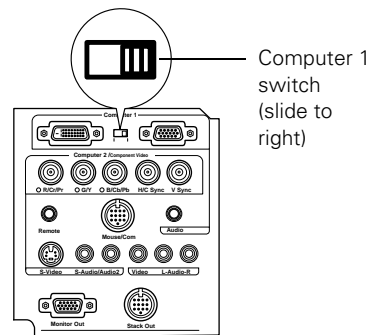

Connecting to an Older PowerBook

If you're connecting to a Macintosh PowerBook and the computer video cable doesn't fit properly, you may need a special video-out cable (available from Apple) or a Macintosh desktop adapter (available from Epson; see the projector *Administrator's Manual*).

Refer to the figure below to make the proper connections:

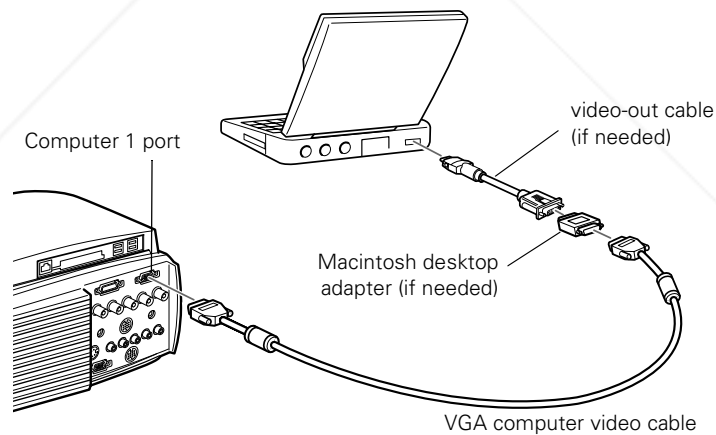

1. To use the desktop adapter, remove its cover as shown and set the DIP switches according to the resolution you want to use, such as 16-inch mode. See your Macintosh documentation for instructions.
2. Replace the cover and connect the adapter to one end of the computer video cable. Then plug the cable (with the adapter) into the monitor port on your Macintosh.
3. If your PowerBook requires a video-out cable, connect its larger end to the adapter, as shown below. Then plug the video-out cable into the video port on your Macintosh.

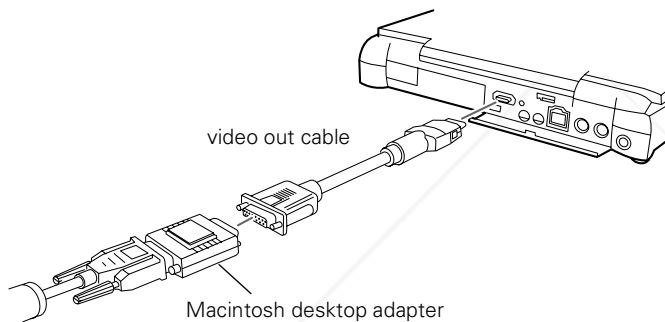
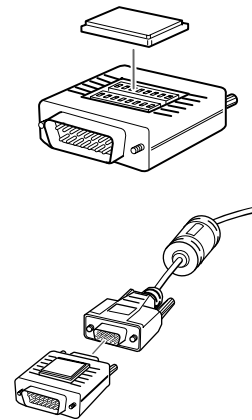

4. Tighten the screws on the connectors.

Connecting the Mouse Cable

If you want to use the remote control in place of your laptop's mouse, follow the steps below. This illustration shows the connections you'll be making:

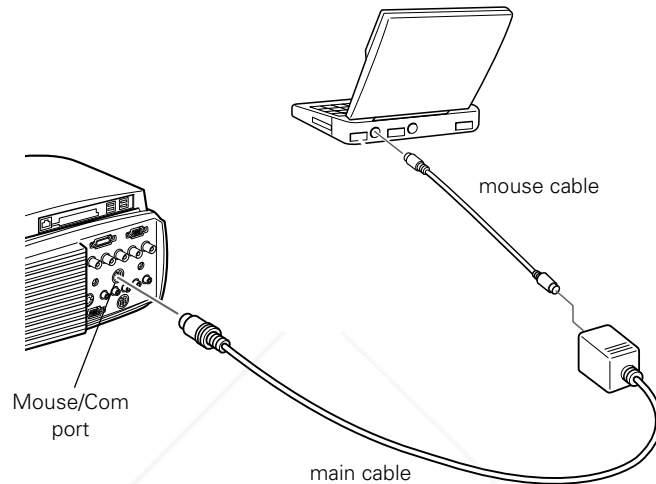

1. Connect the round end of the main cable to the projector's **Mouse/Com port**, as shown.
2. To use the remote control as a wireless mouse, choose the correct mouse cable for your laptop. (Note that some of the cables look very similar, but are labeled with a tag as shown.)

- PS/2 mouse



- PC serial mouse



- USB mouse

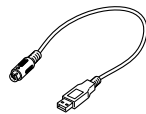

- Mac mouse



3. Connect one end of the mouse cable to the **MOUSE** terminal on the square end of the main cable.

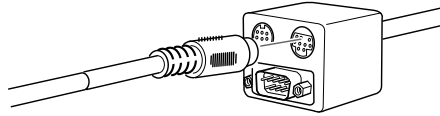

4. Connect the other end of the mouse cable to the mouse port (or USB port) on your laptop.
5. Tighten the screws on the connectors.
6. If necessary, configure your laptop to work with an external mouse.

Connecting the Audio Cable

To use the projector's built-in stereo speaker system, connect the 3.5-mm audio cable between the laptop's speaker or audio-out port and the projector's **Audio** port.

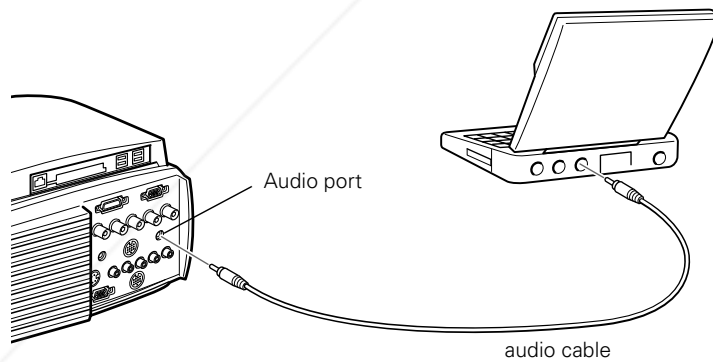

Connecting to a Video Device

note

To connect using S-video or component (BNC) video, see the projector Administrator's Manual.

Follow the steps below to connect the projector to a VCR, DVD player, or any other video device that has RCA-style (composite video) connectors. Before starting, make sure the projector and your video device are turned off.

1. Connect the yellow RCA plug on one end of the RCA video cable to the projector's Video port. Connect the other end of the cable to the video-out port of your video source.

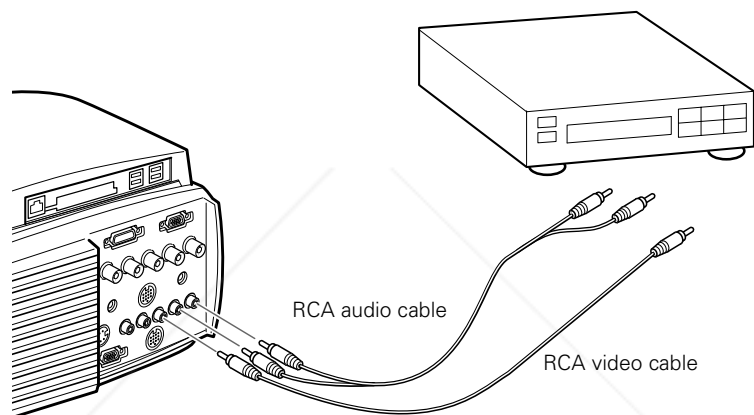

2. To use the projector's built-in speaker system, connect the RCA audio cable to the left and right Audio ports of the projector (insert the white plug into the L port and the red plug into the R port). Connect the plugs at the other end of the cable to the audio output ports of the video source.

When done making the connections, turn to "Displaying and Adjusting the Image" on page 37 to start your presentation.

3

Displaying and Adjusting the Image

Once you've transferred your presentation to the projector (as described in Chapter 1) or connected the projector to your computer or other equipment (as described in Chapter 2), you're ready to turn on the projector and adjust the image.

This chapter covers the following:

- Turning on the projector
- Selecting the image source
- Adjusting the image and sound
- Shutting down the projector
- Turning on the projector automatically

Displaying an Image

Follow the steps below to turn on the projector and any connected equipment, and to display an image.

Turning On the Projector

Follow these steps to turn on the projector:

1. Make sure the projector is plugged in and the lens cap is off.

note

You can also set the projector to turn on automatically at a preset time. See page 45.

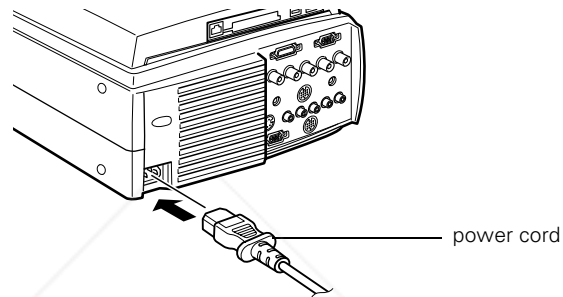

The power light on the projector's control panel glows orange, indicating that the projector is receiving power but the lamp is not turned on.

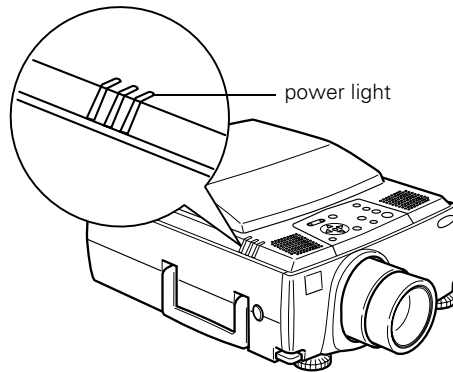

2. Press the red **Power** button on the control panel. You can also use the **Power** button on the remote control, but make sure batteries are installed and the remote control is turned on first. (For details, see page 50.)

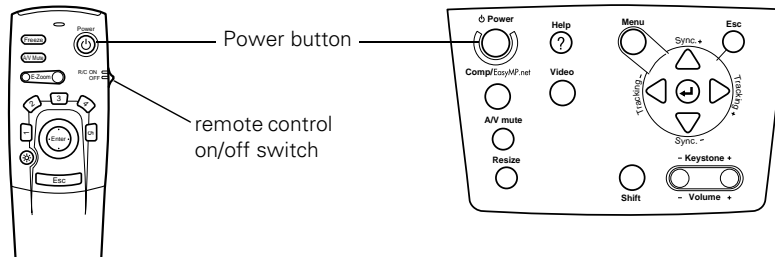

The projector's power light flashes green as the projector warms up, and the projection lamp comes on in about 30 seconds. (To turn off the lamp, see page 47.)

warning

Never look into the lens when the lamp is on. This can damage your eyes.

Selecting the Image Source

The screen you see when turning on the projector depends on which image source was selected when the projector was last used. If EasyMP.net was selected, you see the EasyMP.net main screen, as shown below; if a computer or video source was selected, you see a blue screen with the No Signal message.

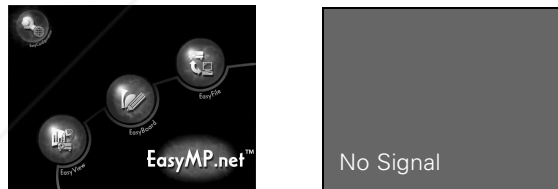

If necessary, follow these steps to display the correct image:

1. If you're presenting from a computer or video device, turn on the device. (If you're projecting a video, press **Play** on the video device.)
2. If you've connected a computer that's running Windows and it displays a New Hardware Found message saying that it has found a plug-and-play monitor, click **Cancel**.

note

It takes a few seconds for the projector to sync up after selecting the source. After pressing one of the source buttons, wait a moment for the image to appear.

3. To display the image, do one of the following:

- On the projector's control panel, press the **Comp/EasyMP.net** button to switch between EasyMP, Computer 1, and Computer 2; or press the **Video** button to switch between the video sources (composite, component, or S-video).

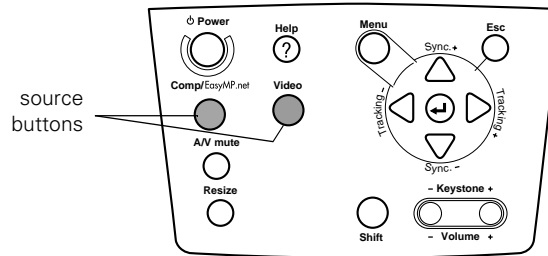

- On the remote control, press the **Comp1**, **Comp2/YCbCr**, **EasyMP.net**, or **Video** button to switch sources.

If you see a blue screen with the No Signal message, you may have to press the button again to select the correct source. If a projected image fails to appear, see page 63 for help.

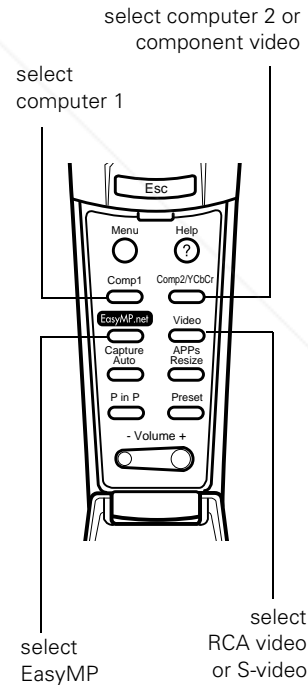

Adjusting the Image and Sound

If the projector is already installed in a meeting room, you probably won't need to make any adjustments. If you set up the projector yourself, check the following:

- To focus or zoom your image, see below.
- If the image is too high or too low, you can reposition it. See page 42.
- If the image isn't square, see page 43.
- If only part of a computer image is displayed, you may need to press the **Resize** button. See page 44 for more information.
- If you're using an audio source, see page 44 to adjust the sound.

Focusing and Zooming Your Image

Rotate the focus ring to sharpen the image.

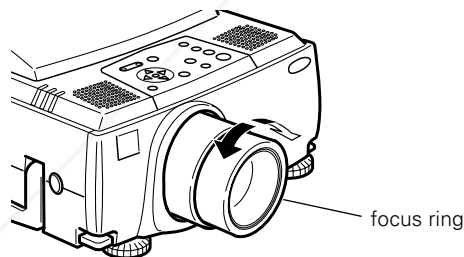

Rotate the zoom ring to reduce or enlarge the image.

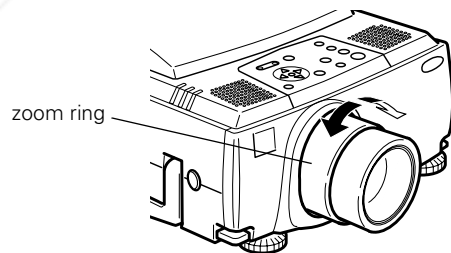

If the image still isn't large enough, you may need to move the projector farther from the screen.

Adjusting the Height of Your Image

You can adjust the height of the image using the lens shift knob and the projector's feet.

Using the Lens Shift Knob

If possible, set the projector flat on a table and use the lens shift knob (instead of raising the projector's feet) to position the image on-screen. This delivers the best-looking picture.

You won't need to tilt the projector upward as long as you position it so that its lens is at least as high as the bottom of the screen, but no higher than the middle of the screen, as shown:

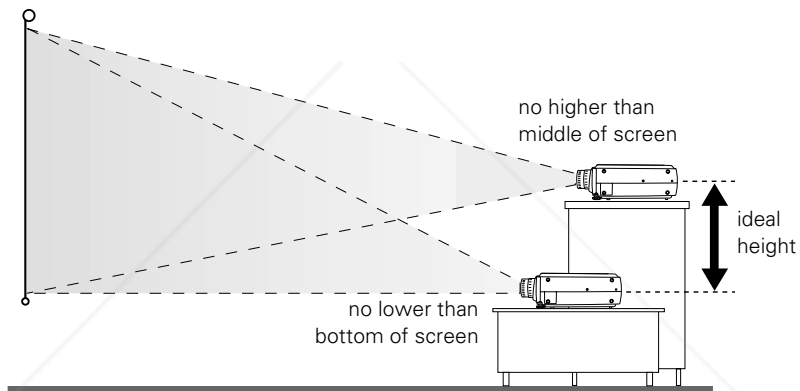

Use the lens shift knob to raise or lower the image. If the knob is recessed, press and release it to make it extend; then turn it clockwise or counterclockwise to move the image up or down. When you're finished, press the knob back in.

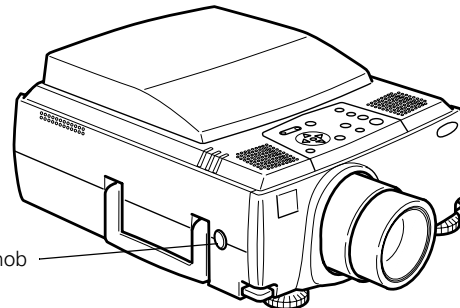

Using the Projector's Feet

If the image is still too low, you can raise it by extending the projector's feet.

1. Stand behind the projector. Pull up the blue foot release levers and lift the front of the projector. This unlocks the feet.

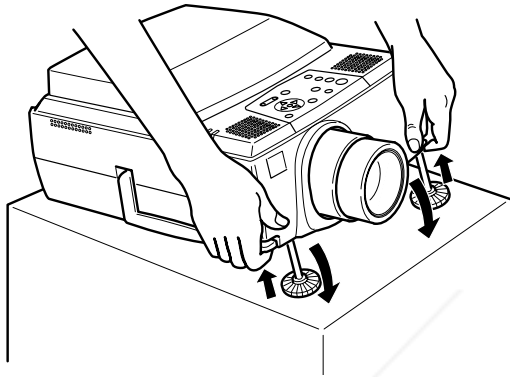





2. Once the image is positioned where you want it, release the levers to lock the feet in position.
3. To fine-tune the height of the image, rotate the thumb wheels attached to the projector's feet.

If the image is no longer square after raising it, see the next section.

Adjusting the Image Shape

If the projected image isn't square or has a "keystone" shape, do one or more of the following:

- If your image looks like  or , you've placed the projector off to one side of the screen, at an angle. Move it directly in front of the center of the screen, facing the screen squarely.
- If your image looks like  or , press the + or - side of the Keystone button to correct the shape of the image. After correction, your image will be slightly smaller.

caution

Do not hold the projector by the lens; this can damage it.

- Keystone +

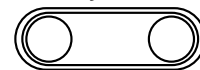

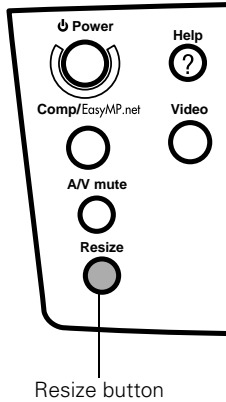

Resizing the Image

Some computer images need to be resized to display in the projector's native resolution. If only part of your computer image is displayed, you can correct it with the **Resize** button.

- Press the **Resize** button on the control panel. The screen image is automatically compressed.
- Continue pressing the **Resize** button to pan around the screen in the original resolution.

If you're projecting from video equipment, pressing the **Resize** button switches the aspect ratio between 4:3 and 16:9.

Adjusting the Volume

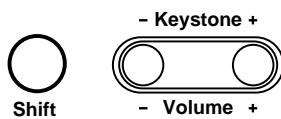

If you've connected an audio source, you can adjust the projector's volume from the control panel. Hold the **Shift** button down while pressing the **+** or **-** side of the **Volume** button. You can also adjust the volume using the remote control.

Turning On the Projector Automatically

You can set the projector to turn on at a preset time. You can set either a specific time for the projector to come on, or you can set it to come on everyday or on certain days of the week.

When the projector comes on, it displays whichever source was selected when last used. (See page 39 for instructions on switching sources.) The only exception is if a scenario is set to begin playing automatically (see page 8); in this case, the projector automatically switches to EasyMP so that the scenario can begin playing.

Follow these instructions to set the timer:

1. Turn on the projector (page 38) and select EasyMP.net as the source (page 39). You see this screen:

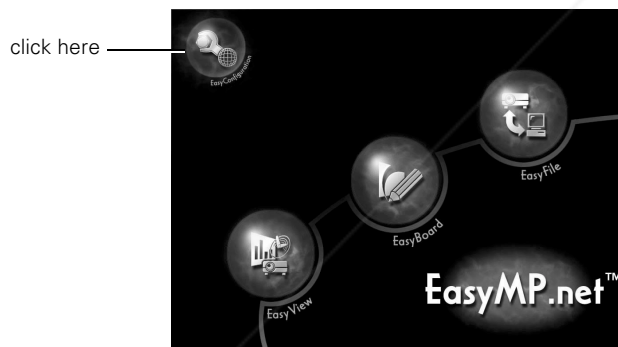

2. Click the Easy Configuration icon, as shown above.

You see this screen:

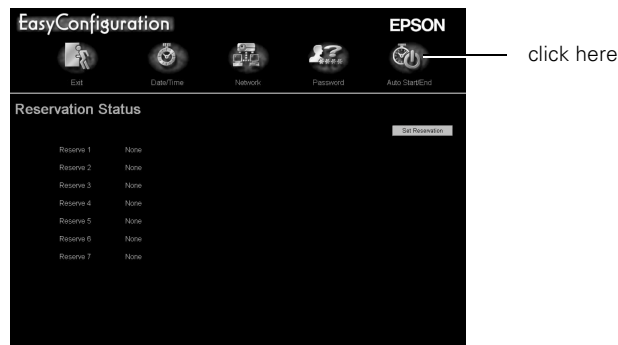

3. Click Set Reservation, as shown above.

You see this screen:

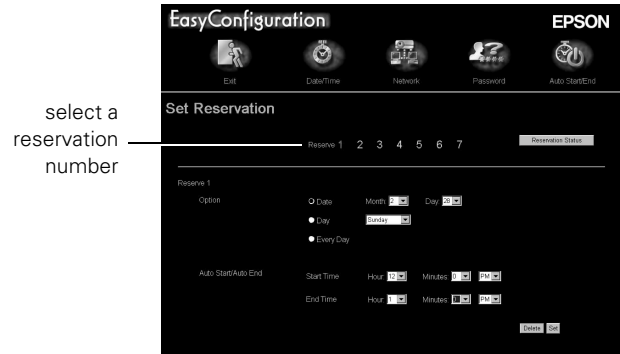

4. You can program up to seven different power-on times. Click one of the reservation numbers, as shown above. Then select the desired options for the day, start time, and end time.

When done, click **Set**. (If you want to cancel a programmed time, click **Delete**.) The scheduled power-on time appears in the Reservation Status window.

Shutting Down the Projector

When done using the projector, turn off the projection lamp. If the projector is connected to your network, leave it plugged in so that it can continue to receive data over the network. If you need to unplug the projector, as when moving it, be sure to turn off the projection lamp (if it's on) and let the projector cool before unplugging it.

Follow these steps to turn off the projection lamp:

1. Press the red **Power** button on the projector or remote control. You see a confirmation message. (If you don't want to turn it off, press any other button.)

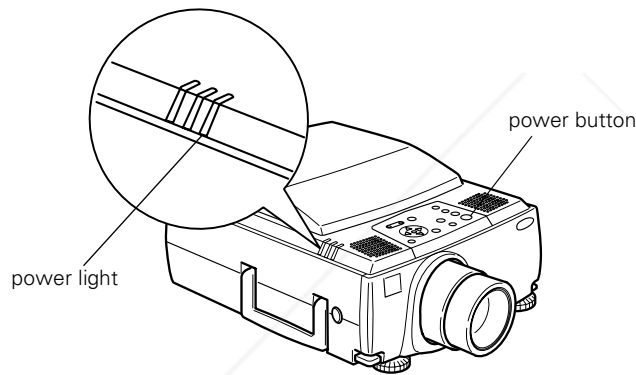

2. Press the **Power** button again. The power light flashes orange for about a minute as the projector cools down. Once the projector has finished cooling, the orange light stays on and the exhaust fan shuts off. This means the projector is in "sleep mode," but it can still receive data over the network.
3. If necessary, unplug the power cord. (When unplugged, the projector won't be accessible to users over the network.)

note

When the projector has not received any input signals for 30 minutes, it automatically turns off the projection lamp and enters "sleep mode." This conserves electricity, cools the projector, and extends the life of the lamp.

caution

To avoid damaging the projector or lamp, never unplug the power cord when the power light is green or flashing orange.



Discount-Merchant.com (800) 281-8860

THE TRUSTED SOURCE FOR PROJECTOR LAMPS AND ACCESSORIES

4 *Using the Remote Control*

Using the remote control, you can access your projector's features from anywhere in the room—up to 30 feet away. You can use it to start and run your presentation, control the picture and sound, and highlight your presentation by using it as a digital pointer. If you're giving a PowerPoint presentation, you can use the remote as a wireless mouse to click from one slide to the next.

This chapter covers the following information:

- Turning on the remote control
- Using the remote control as a wireless mouse
- Controlling the picture and sound
- Highlighting your presentation

Turning On the Remote Control

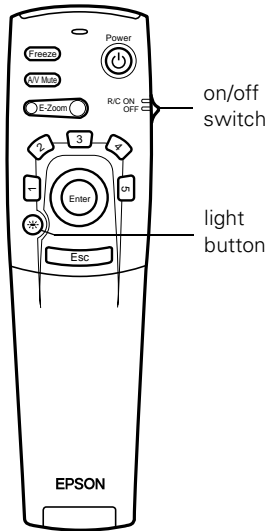

The remote control has an on/off switch on its side, as shown. Before using it, make sure batteries are installed (as described in the *Administrator's Manual*), then push up the on/off switch to turn it on.

Turn off the remote control before transporting it or storing it with the projector in a carrying case; this prevents the batteries from discharging if something presses against one of the buttons.

Keep the following in mind when using the remote control:

- Stand within about 30 feet of the projector.
- Point the remote either at the front or back of the projector or at the screen (the projector's front sensor can detect signals bounced off the screen).
- When presenting in a darkened room, press the ☀ light button to make the other buttons on the remote light up temporarily. (This is also a good way of testing the batteries.)
- To access additional buttons, pull open the cover as shown:

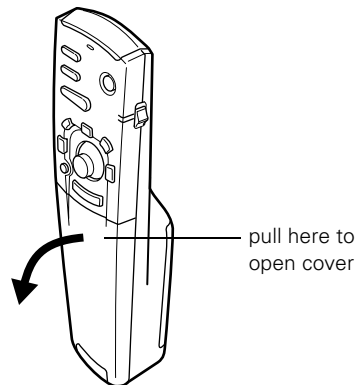

Using the Remote Control as a Wireless Mouse

The remote control works as a wireless mouse to let you access various projector features and control your presentations; see the next page for instructions. You can use it as a mouse in the following situations:

- when using EasyMP.net

The remote control lets you select the image you want to view, click through your PowerPoint slides, and draw on screen to highlight your presentation. See “Delivering Your Presentation” on page 17 for details.

In some cases you may be asked to enter a number as a password; if you don't have a keyboard, you can use the numbered buttons (1 through 5) on the remote control, as shown.

- when presenting from a computer

If you're presenting from a laptop instead of using EasyMP.net, you can use the remote control's built-in pointer and highlighting features. These let you mark up your presentation on-screen. See page 56.

You can also use the remote control in place of your computer's mouse. This gives you more flexibility when delivering PowerPoint and other slideshow-style presentations, since you won't need to stand next to your computer to change slides. To use the remote control in this way, you have to connect the mouse cable between your computer and the projector. See page 34.

- when accessing the projector's help and menu functions

The remote control lets you access and use the projector's help system; see “Using On-Screen Help” on page 60. It also lets you navigate the menu system to fine-tune various projector features; see the *Administrator's Manual* for details.

Turn to the next page for details on using the remote control's mouse buttons.

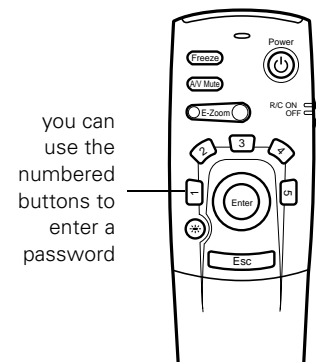

Follow the guidelines in the figure below to use the remote control as a mouse:

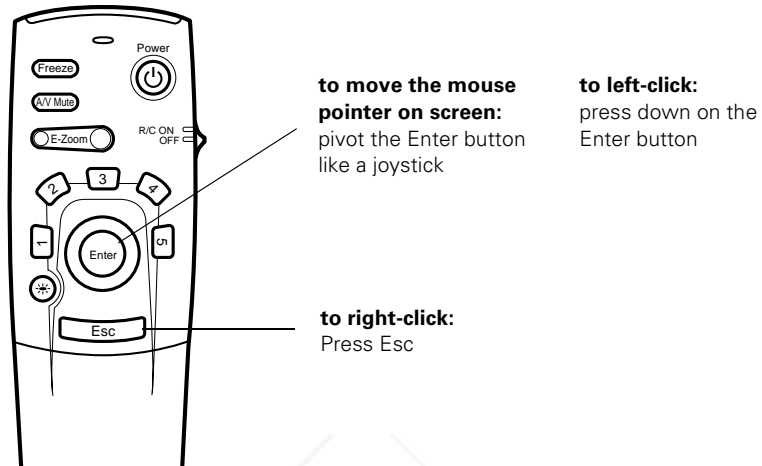

If you need to double-click, press down twice on the Enter button. To click and drag, press down on the Enter button and tilt it the direction you want to go.

Controlling the Picture and Sound

You can use the remote control to select your image source, adjust the volume, temporarily turn off the picture and sound, freeze the action, zoom in on the picture, or display a picture-in-picture video image.

Switching Between Picture Sources

If you've connected your projector to more than one computer and/or video source, you can use the remote control to switch between the different sources.

- Press the **Video** button to switch between a composite (RCA) video source and an S-video source.
- Press the **Comp1** button to select your first computer.
- Press the **Comp2/YCbCr** button to select your second computer or a component video source.
- Press **Easy-MP** to switch to the EasyMP.net main menu screen.

After you select a source, the screen goes dark for a moment before the image appears.

Adjusting the Volume

If you've connected an audio source to the projector, you can adjust the sound that's output through the projector's speakers.

- To increase the volume, press on the right (+) side of the **Volume** button.
- To reduce the volume, press on the left (-) side of the **Volume** button.

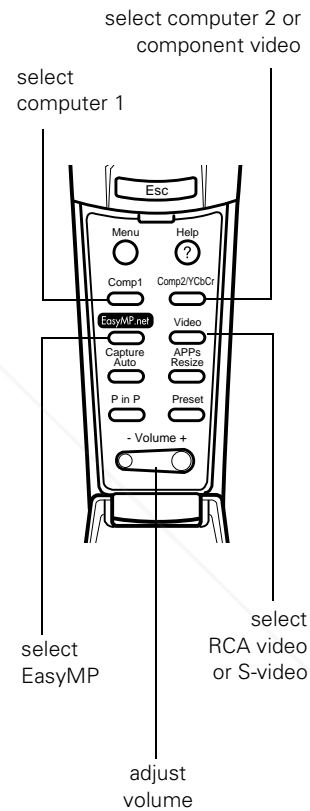

note

You can also have an image, such as a company logo, display on the screen whenever you press the **A/V Mute** button. See the *Administrator's Manual* for instructions.

Turning Off the Picture and Sound

You can use the **A/V Mute** button on the remote control to darken your screen and turn off the sound. This is useful if you want to temporarily re-direct your audience's attention without the distraction of a bright screen.

- To turn off the picture and sound, press the **A/V Mute** button. The screen goes dark.
- To turn the image back on, press the button again.

Stopping Action

You can use the remote control to freeze the screen image when projecting from a computer or video device.

- Press the **Freeze** button to stop the action and keep the current image on the screen. The sound will continue.
- Press the **Freeze** button again to re-start it.

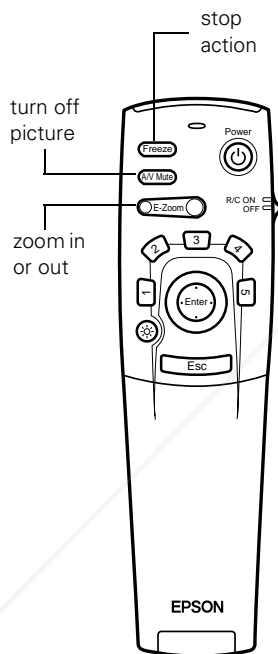

Zooming Your Image

You can zoom in on a portion of the image using the **E-Zoom** button on the remote control.

1. Press the right side of the **E-Zoom** button to zoom in on your image; you can enlarge it up to four times its original size. You can press the button repeatedly (up to 32 times), or press and hold the button to zoom to the size you want.
2. Use the **Enter** button to pan around the screen if necessary.
3. Press the left side of the **E-Zoom** button to zoom out. You can press the button repeatedly, or press and hold it to zoom all the way out. You can also press the **Resize** button to return to the original size.

Displaying Picture-in-Picture Video

You can open a small video window on your computer image, and view a video at the same time as your computer presentation.

First make sure you have connected your VCR or other video source using an RCA cable as described on page 36. You can also use S-video, but be sure to follow the instructions in the *Administrator's Manual* to connect the cable and select S-video in the P in P menu option. (You can't display the picture-in-picture window using component video.)

1. Press the P in P button on the remote control. The screen may go dark for a moment before you see your video image in a small window on screen.
2. Use the Enter button to reposition the video window; use the E-Zoom button to reduce or enlarge it.
3. Once the window is located and sized the way you want, press the Enter button; your video plays on the screen.

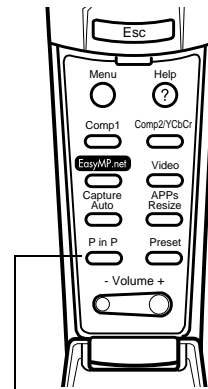

display picture in picture



video window

4. When you're finished viewing the picture-in-picture, press the P in P button again. The video window disappears.

Highlighting Your Presentation

note

EasyMP.net has its own highlighting features. To use them, see page 20.

If you're presenting from a computer or video source (not EasyMP.net), you can highlight areas on the screen using the numbered buttons on the remote control. You can use these "special effects" features to annotate your presentation or call attention to your most important points. Five highlighting tools are available, as shown:

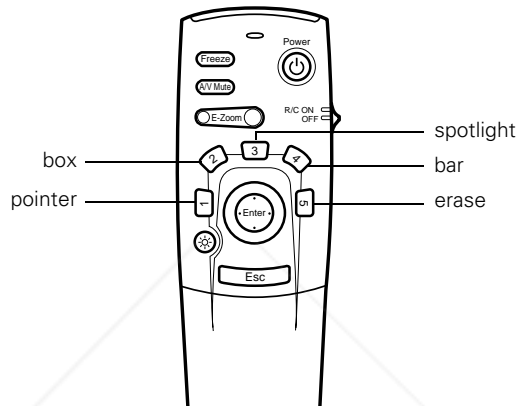

You can customize the highlighting tools (by changing their color and shape) through the Effect menu. See the *Administrator's Manual* for instructions.

Using the Pointer

You can choose from three types of pointers and place them anywhere on your screen.

1. To activate the pointer tool, press button 1 on the remote control. A  colored pointer appears in the upper left corner of the screen. To try a different look, press 1 again. Press 1 again to see the third one.
2. Use the Enter button to place the pointer wherever you want it.
3. To "paste" the pointer on the screen, press down in the center of the Enter button. You can then continue to work with another pointer, moving it around the screen or pasting it wherever you want.

4. To erase the pointers pasted on the screen, press button 5.
5. To cancel the pointer feature, press Esc.

Using Box Highlights

You can draw outline boxes on the screen to highlight areas of your presentation or video.

1. To activate the box tool, press button 2 on the remote control.
A  colored square appears in the upper left corner of the screen. This is the box-drawing tool.
2. Use the Enter button to place the square where you want to begin drawing the box.
3. Press down in the center of the Enter button. You see a corner mark on the screen; this defines one corner of the box.
4. Use the Enter button to drag the square to where you want the opposite corner of the box to be.
5. Press down in the center of the Enter button. You see the box outlined on the screen.

You can continue placing boxes on the screen by repeating steps 2 through 5.

6. To erase the box(es), press button 5.
7. To cancel the box drawing feature, press Esc.

Spotlighting Your Image

With the Spotlight tool, you can highlight part of the screen.

1. To activate the spotlight tool, press button 3 on the remote control. A spotlight appears on the image.

You can continue pressing button 3 to switch between three spotlight sizes.
2. Use the Enter button to move the spotlight where you want it.
3. To remove the spotlight, press Esc.

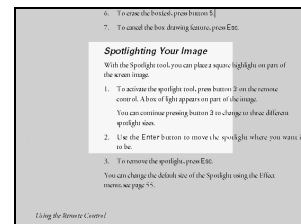

Using Horizontal and Vertical Highlights

With the bar tool, you can draw bold horizontal or vertical lines on the screen to underline or highlight your presentation points. You can choose from three types of bars.

1. To activate the bar tool, press button **4** on the remote control. A horizontal bar appears across the screen. If you want a vertical bar, press **4** again. If you want to try another horizontal bar, press **4** again.
2. Use the **Enter** button to move the bar up and down the screen (or left and right if you are using the vertical bar).
3. After placing the bar where you want it, press down in the center of the **Enter** button to lock it in position on screen.
4. To cancel the bar drawing feature, press **Esc**.

Clearing the Screen

When done highlighting your presentation, press button **5**. This erases any highlighting marks you've added to the screen.

5

Solving Problems

This chapter helps you solve problems with the projector, and tells you how to contact technical support for problems you can't solve yourself. This chapter explains the following:

warning

Except as specifically explained in this User's Guide, do not attempt to service this product yourself.

- Using the projector's on-screen help system
- What to do when the projector's status lights flash
- Solving problems with the image or sound
- Solving problems with the remote control
- Contacting technical support

Using On-Screen Help

If you see a **No Signal** message or your audio isn't working, you can get help by pressing the blue **? Help** button on top of the projector or under the cover on the remote control. The following choices are available:

- **Help for the image**
Tells you what to do if you see a **No Signal** message
- **Help for the sound**
Tells you what to do when your audio isn't working
- **Language selection**
Lets you display the help information and projector menus in any of nine different languages

Follow these steps to get help:

1. Press the blue **? Help** button. You see the help menu.
2. Use the **▲** up or **▼** down arrow buttons on the control panel (or move the **Enter** button up or down on the remote control) to highlight one of the options. Then press the **↵** or **Enter** button to select it.
3. Press the **↵** or **Enter** button again to view the solutions. (Press **Esc** if you need to back up.)
4. Press the down arrow button on the control panel (or press down on the **Enter** button on the remote control) to display additional text.
5. To exit the Help system, press the blue **? Help** button.

If none of the suggestions solves your problem, see additional solutions to problems in the following sections.

caution

*Don't hold the **? Help** button for more than 5 seconds, or the projector will enter the mode for resetting the lamp timer.*

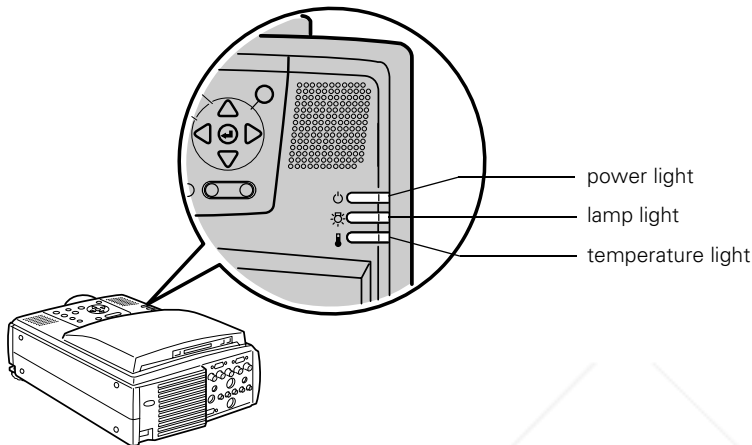

What To Do When the Lights Flash

The lights on top of the projector indicate the projector's status and let you know when a problem occurs.



If the projector is not working correctly, first turn it off and unplug it. Then plug the power cord back in and turn on the projector. If this does not solve the problem, check the status lights on top of the projector and try the solutions recommended below.

Light	Status	Description
	does not come on	Make sure the power cord is connected securely. If you've just replaced the lamp, make sure its cover is fastened securely.
	green	The projector is operating normally.
	flashing green	The projector is warming up. Wait for the image to appear.
	orange	The projector is in sleep mode. You can unplug it to turn it off or press the Power button to turn it on.
	flashing orange	The lamp is cooling down. Don't unplug the projector until the light stops flashing. If you want to turn the projector back on, wait until the light stops flashing and press the Power button.
	red	Power is cut off because of an internal problem. Remove the power cord and contact EPSON for help; see page 72.
	flashing orange	The lamp is almost burned out. This is a good time to replace it. See the <i>Administrator's Manual</i> for instructions.
	flashing red	The lamp is burned out. See the <i>Administrator's Manual</i> for replacement instructions.

Light	Status	Description
	flashing orange	The projector is getting too hot. Turn it off and let it cool for five minutes. Make sure the temperature surrounding the projector does not exceed 104 °F and there is plenty of space around and under the projector for ventilation. You should also check the air filter; if necessary, clean or replace it as described on in the <i>Administrator's Manual</i> .
	red	The projector has overheated and turned itself off. Let it cool for five minutes, then turn it back on. Make sure there is plenty of space around and under the projector for ventilation. If necessary, clean or replace the air filter as described in the <i>Administrator's Manual</i> . If the projector continues to overheat, the problem may be caused by damage to the cooling fan or internal circuits. Contact EPSON for help; see page 72.
	flashing red	There is a problem with the cooling fan or temperature sensor. Turn off the projector and unplug it. Contact EPSON for help; see page 72.

Solving Problems with the Image or Sound

No image appears on the screen.

- Check that the power light is green, not flashing, and the lens cover is off.
- The projector may be in sleep mode. If the power light is orange, press the **Power** button to turn the projector on.
- If the power was switched off and then on again, the projector may still be cooling down. Wait until the power light stops flashing and remains orange; then press the **Power** button again.
- Make sure the **Brightness** setting on the Video menu is correct. See the *Administrator's Manual* for more information. Try selecting the **Reset All** setting to return all setup menus to their default values.
- Press the **A/V Mute** button to make sure the picture has not been turned off temporarily.
- The attached computer may be in sleep mode or displaying a black screen saver. Try pressing a key on the computer.

You see a blue screen with the message No Signal displayed.

- Make sure the cables are connected correctly, as described in Chapter 2.
- You may need to switch image sources. Press the **Comp/Easy-MP** or **Video** button (on the control panel) or the **Comp1**, **Comp2/YCbCr**, **Easy-MP**, or **Video** button (on the remote control) to select the correct source. Allow a few seconds for the projector to sync up after pressing the button.
- Make sure the **Computer 1** selector switch on the projector's interface panel is flipped to the right for a computer outputting standard video signals (analog VGA) or to the left for a computer using DVI (digital video). See page 32.
- Try restarting your computer.

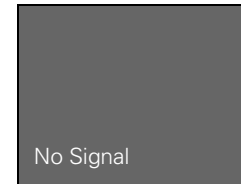

If you're using a PC laptop:

- Hold down the Fn key and press the function key that lets you display on an external monitor. It's often labelled with an icon such as  or it may be labelled **CRT/LCD**. Allow a few seconds for the projector to sync up after pressing it.

On most systems, the  key lets you toggle between the LCD screen and the projector, or to display on both at the same time. Check your laptop's manual or online help for details.

- Depending on your computer's video card, you might need to use the Display utility in the Control Panel to make sure that both the LCD screen and external monitor port are enabled. See your computer's documentation or online help for details.

If you're using a PowerBook:

1. From the Apple menu, select **Control Panels**, then click **Monitors and Sound**.
2. Click the **Arrange** icon.

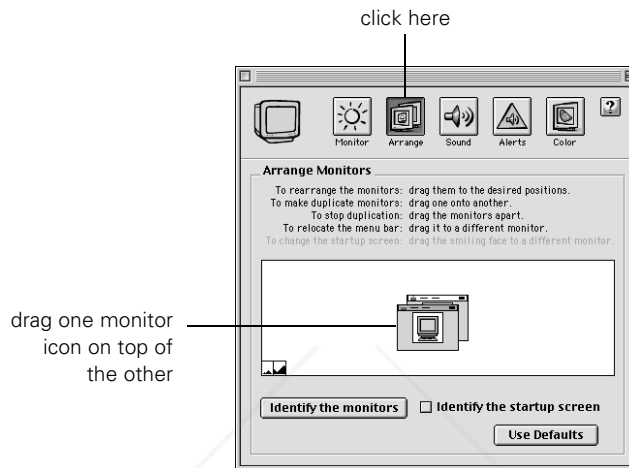

3. Drag one monitor icon on top of the other. This lets you display on the projector screen as well as the LCD screen.
4. If the **Arrange** option isn't available, click the **Monitor** icon.

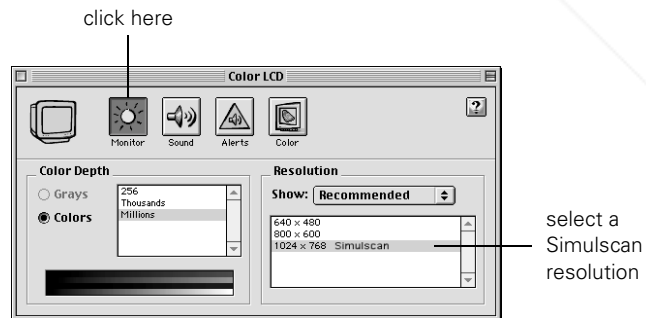

5. Select one of the listed **Simulscan** resolutions. (It may take a moment for the projector to sync up.)

The message Not Supported is displayed.

- If you've connected a second computer or you're using component video, make sure the **BNC** option in the Setting menu is correct. See the *Administrator's Manual*.
- Make sure your computer's resolution doesn't exceed UXGA (1600 × 1200), and the frequency is supported by the projector (see the *Administrator's Manual*). If necessary, change your computer's resolution setting as described below.

Only part of the computer image is displayed.

- Press the **Resize** button on the control panel or remote control.
- Make sure the image **Position** setting is correct on the Video menu. See the *Administrator's Manual* for more information.
- If you've connected a second computer, make sure the **BNC** option in the Setting menu is set to **RGB**. See the *Administrator's Manual*.
- If you're using a Macintosh adapter to connect the cable to your computer's video-out port, make sure the DIP switches on the adapter are set correctly. (See your Macintosh documentation for instructions.)
- Make sure your computer's resolution setting is correct. Ideally, it should be 1024 × 768 to match the projector's native resolution. If this option isn't available, select one of the other compatible video formats listed in the *Administrator's Manual* by doing the following:
 - **Windows:**
Right-click the desktop, select **Properties**, click the **Settings** tab, and use the dialog box to select a different resolution.
 - **Macintosh:**
On the Apple menu, choose **Control Panels**, then click **Monitors and Sound**. Select a different resolution.
- You also may need to modify existing presentation files if you created them for a different resolution. See your software documentation for specific information.



FixYourDLP.com
Sponsored by

Discount-Merchant.com (800) 281-8860

THE TRUSTED SOURCE FOR PROJECTOR LAMPS AND ACCESSORIES

Solving Problems 65

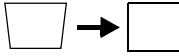
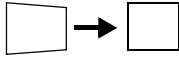

The image isn't square, but trapezoid-shaped.

- Make sure the projector isn't placed off to one side of the screen, at an angle. Place the projector directly in front of the center of the screen, facing the screen squarely.
- If you've tilted the projector upward by extending the legs, the image will be broader at the top. Hold down the + or - side of the Keystone button on top of the projector until the image is square.

The image contains static or noise.

- If you've connected a device to the Computer 2/Component Video port, make sure the BNC option in the Setting menu is correct. See the *Administrator's Manual*.
- If you're using a computer cable longer than 6 feet, the image quality may be reduced.
- Keep your computer and video cables separated from the power cord as much as possible to prevent interference.
- The video signal may be split between the computer and the projector. If you notice a decline in the projected image quality when the image is displayed simultaneously on your laptop computer and the projector, turn off the laptop's LCD display; see your laptop's manual for instructions.

The image is blurry.

- There may be dirt or smears on the lens. Clean the lens as described in the *Administrator's Manual*.
- Adjust the focus using the focus ring.
- Adjust the Sharpness setting in the Video menu (see the *Administrator's Manual*). If you're projecting from a computer, you may also need to adjust the Tracking and Sync as described in the next section. If you don't like the new settings, you can always select Reset to return to the factory default settings.

You see vertical stripes or the image still looks blurry after trying the solutions in the previous section.

- If you're projecting from a computer and displaying an image that contains a lot of fine detail (such as the body of a letter), you may notice one or more vertical stripes or bands, or some of the characters may look heavy or blurred. Press **Auto** on the remote control or the **↵** Enter button on the control panel. This resets the projector's tracking and sync settings.
- If further adjustment is needed, you can fine-tune the **Tracking** and **Sync** settings manually using the buttons on the control panel (or using the Video menu as described in the *Administrator's Manual*):
 1. Fill the screen with an image containing fine detail when making these adjustments. For example, in Windows you can click **Start**, **Settings**, and **Control Panel**, then double-click **Display**; select a pattern to appear as your desktop background. If this option isn't available, try projecting black text on a white background (such as a letter).
 2. Press the **Tracking -** and **Tracking +** buttons to eliminate vertical stripes.

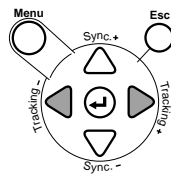
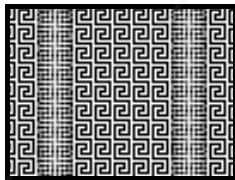

3. Press the **Sync -** and **Sync +** buttons to increase the sharpness of the image.

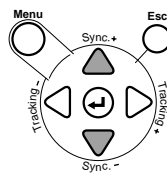
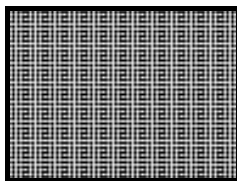



note

Because of the different technologies used, your projected image may not exactly match the colors on your laptop or computer monitor.

The colors of the image are not right.

- The color balance may be incorrect. If you're displaying a computer image, use the **Gamma** option in the projector's Video menu to adjust the balance of red, green, and blue. If you're displaying video, adjust the **Color**, **Tint**, and **Gamma** settings on the Video menu. Also try adjusting the **Color Setting** option in the Advanced menu.
- Check your computer display settings to correct the color balance.

There is no sound.

- Try turning up the volume. Hold down the **Shift** button and press the right side of the **Volume** button (control panel) or press the right side of the **Volume** button (remote control).
- Make sure the **A/V Mute** button is not enabled.
- If you're using a VCR or other video source, make sure the volume is not turned all the way down or muted. Also, make sure the cables are connected correctly, as described in Chapter 2.
- If your presentation includes computer audio, make sure the volume control on your computer is not turned all the way down or muted. Make sure the audio cable is securely connected to both the projector and your computer's  headphone jack or  audio out jack. See page 35.
- Make sure the Windows volume controls on your computer are not turned all the way down or set to Mute. You may be able to check this by right-clicking the sound icon on your Windows desktop.
- The wrong source may be selected. Press the **Comp/Easy-MP** or **Video** button on the control panel—or the **Comp1**, **Comp2/YCbCr**, **Easy-MP**, or **Video** button on the remote control—to select the proper source. Allow a few seconds for the projector to sync up after pressing the button.

Solving Problems with the Remote Control

The projector doesn't respond to remote control commands.

- Make sure the remote control is turned on.
- Make sure you are within 30 feet of the projector, have a direct line-of-sight to the projector's front or back sensor, and are no more than 30° to the left or right, or 15° above or below, the sensor.
- The remote control batteries may not be installed correctly or may be low on power. To test the batteries, press the ☼ light button. The other buttons on the remote should light up temporarily. If they don't, you need to change the batteries.
- Dim the room lights and turn off any fluorescent lights. Make sure the projector is not in direct sunlight. Strong lighting, especially fluorescent lights, may affect the projector's infrared receivers.
- Turn off any nearby equipment that emits infrared energy, such as a radiant room heater.

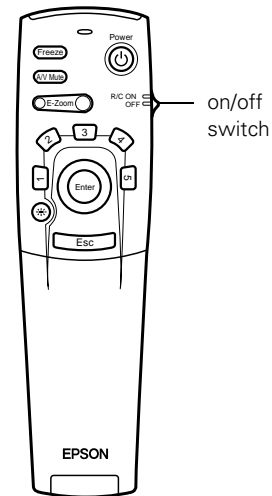

You can't control your computer's cursor with the remote control.

- Make sure the mouse cable is securely connected to both your computer's mouse port (using the main cable) and the projector's mouse port. See page 34 for details.
- Make sure you've used the correct cable. The PS/2 mouse cable and Macintosh mouse cable look similar, but they aren't identical. Check the label on the end of the cable.

Solving Problems with EasyMP.net

You cannot send your presentation to the projector.

- Make sure the projector is plugged into a power outlet (the projector doesn't have to be turned on, though). It must also be properly connected to your network, as described in the *Administrator's Manual*.
- Make sure the memory card is inserted in the projector's PCMCIA slot. See page 16.

You've copied your presentation to the projector, but it doesn't show up in Easy View.

Make sure the presentation file is in one of the compatible formats listed on page 8.

Projected images don't fit on the screen.

Select Fit to screen in Easy View, as described on page 18.

Your presentation doesn't look exactly the same as it did on your computer screen.

Certain PowerPoint special effects are unavailable when using EasyMP.net, including sound effects. Microsoft Word and Excel files may not display with the same font you used on your computer. See Chapter 8 of the *Administrator's Manual* for more information.

The remote control's highlighting tools don't work when using EasyMP.net.

The numbered buttons on the remote control can be used to highlight images only when you're projecting directly from a computer or video source. Use EasyMP's highlighting tools instead; see page 20.

When using the EMP Tablet software, you can't move the cursor all the way to the edge of the screen.

You may need to move or resize the EMP Tablet window on your computer's desktop. You can also drag the toolbar out of the way, if necessary.

When using EMP Scenario, you can't drag a PowerPoint file into the scenario window.

You have to double-click the PowerPoint file in EMP Scenario's file window to open the individual slides; then drag each slide from the thumbnail window into the scenario window.



Discount-Merchant.com (800) 281-8860
THE TRUSTED SOURCE FOR PROJECTOR LAMPS AND ACCESSORIES

Solving Problems

Where To Get Help

EPSON provides technical assistance through electronic support services and automated telephone services 24 hours a day, as listed in the following table.

Electronic support and automated telephone services

Service	Access
World Wide Web Technical Support	From the Internet, you can reach EPSON's product support page at http://support.epson.com . After selecting your product, you can view frequently asked questions and answers, download product documentation, and receive technical advice through e-mail.
Automated Telephone Services	A variety of automated help services are available 24 hours a day, seven days a week. To use these services, you must have a touch tone telephone and call (800) 922-8911 .
Presenters Online	Access tips, templates, and training for developing successful presentations at http://www.presentersonline.com

Telephone Support Services

To use the EPSON PrivateLine Support service, call (800) 637-7661 and enter the PIN on the EPSON PrivateLine Support card included in your *Owner's Kit*. This is the fastest way of speaking to a live representative, and it's free. This service is available 6 AM to 6 PM, Pacific Time, Monday through Friday, for the duration of your warranty period.

You may also speak with a projector support specialist by dialing one of these numbers:

- U.S.: (562) 276-4394, 6 AM to 6 PM, Pacific Time, Monday through Friday
- Canada: (905) 709-3839, 6 AM to 6 PM, Pacific Time, Monday through Friday

Toll or long distance charges may apply.



Discount-Merchant.com (800) 281-8860

THE TRUSTED SOURCE FOR PROJECTOR LAMPS AND ACCESSORIES

Before you call, please have the following information ready:

- Product name (EPSON PowerLite 8150i)
- Product serial number (located on the bottom of the projector)
- Video source (computer, DVD player, etc.) and how it's connected
- Description of the problem

You can purchase screens, carrying cases, and other accessories from EPSON by calling (800) 873-7766; in Canada, please call (800) 873-7766 for dealer referral. To purchase accessories online or view EPSON's complete product catalog, visit the EPSON Store® at www.epsonstore.com (U.S. sales only). To see our full line of multimedia projectors, go to www.epson.com/mul_proj.

caution

See the Administrator's Manual for a list of optional and included accessories.



Discount-Merchant.com (800) 281-8860
THE TRUSTED SOURCE FOR PROJECTOR LAMPS AND ACCESSORIES



Discount-Merchant.com (800) 281-8860

THE TRUSTED SOURCE FOR PROJECTOR LAMPS AND ACCESSORIES

Index

A

- A/V Mute, 54
- Accessories, 73
- Adapter, Macintosh desktop, 32
- Adobe Acrobat Reader, 4
- Anti-theft device, 30
- Aspect ratio, 44
- Audio
 - adjusting volume, 44, 53
 - connecting cables, 35, 36
 - problems, 60, 68
 - turning off (using A/V Mute), 54

B

- Bar tool, 58
- Box tool, 57

C

- Computer, connecting to, 31 to 35

D

- Drawing on the screen, 20 to 25, 56 to 58
- Drawing tablet, 3, 20

E

- EasyMP.net
 - capturing an image, 25
 - drawing on screen, 20 to 25
 - Easy File, 13 to 15
 - Easy View, 17 to 19
 - introduction, 2
 - problems, 70
 - sharing captured images, 25 to 28
 - starting presentation, 17 to 19
 - supported file formats, 8
 - transferring presentation to projector, 11 to 16
 - EMP File Utility, 11 to 13

- EMP Scenario software, 8 to 10
- EMP Tablet software, 21 to 22
- Enter button, 52
- EPSON
 - accessories, 73
 - PrivateLine Support, 72
 - technical support, 72 to 73
- Esc button, 52
- Excel, Microsoft, 8, 19
- E-Zoom button, 54

F

- Focusing, 41
- Foot release levers, 43
- Freeze button, 54

H

- Height of image, adjusting, 42 to 43
- Help, 5, 72 to 73
- Help button, 60
- Highlighting tools, 20 to 25, 56 to 58

I

- iBook, connecting to, 31
- Image
 - adjusting, 41 to 44
 - correcting shape, 43, 66
 - focusing, 41
 - height, adjusting, 42 to 43
 - positioning, 42 to 43
 - problems, 62 to 68
 - raising, 42 to 43
 - resizing, 44
 - selecting source, 39 to 40, 53
 - turning off (using A/V Mute), 54
 - zooming, 41, 54

K

- Kensington anti-theft device, 30
- Keystone correction, 43, 66

L

- Lamp status light, 61
- Language setting, 60
- Laptop computer, displaying on, 63
- Lens shift knob, 42
- Lights, status, 61 to 62

M

- Macintosh
 - connecting to, 32 to 33
 - displaying on a PowerBook, 64
- Manuals, 4
- Meeting minutes, 25 to 28
- Memory card, 16
- Mouse, connecting to projector, 20

N

- Network, wireless connection, 3

P

- P in P (picture in picture) button, 55
- Password
 - entering using remote control, 51
 - for meeting minutes, 27
- Picture, *see* Image
- Pointer tool, 56
- Positioning
 - image, 42 to 43
 - projector, 30
- Power
 - button, 39
 - status light, 61
- PowerPoint, 8, 19
- Presenters Online, 72
- PrivateLine Support, 72
- Projector
 - feet, adjusting height with, 43
 - troubleshooting, 60 to 68
 - turning off, 47
 - turning on, 38 to 39
 - turning on automatically, 45 to 46

R

- Raising image, 42 to 43
- Remote control
 - as wireless mouse, 51 to 52
 - problems, 69
 - using, 50 to 52
- Resizing image, 44

S

- Scenarios, creating, 8 to 10
- Sleep mode, 47
- Software, *see* EMP software
- Sound
 - adjusting volume, 53
 - problems, 60, 68
 - turning off (using A/V Mute), 54
- Source, selecting, 39 to 40, 53
- Special effects buttons, 56 to 58
- Spotlight tool, 57
- Status lights, 61 to 62
- Stopping action, 54
- Supported file formats, 8
- Switching picture source, 39 to 40, 53

T

- Tablet, 20
- Technical support, 72 to 73
- Temperature status light, 61 to 62
- Troubleshooting
 - EasyMP.net problems, 70
 - image problems, 62 to 68
 - remote control problems, 69
 - sound problems, 68
 - status lights, 61 to 62
 - using on-screen help, 60
- Turning off picture (using A/V Mute), 54
- Turning off projector, 47
- Turning on projector
 - automatically, 45 to 46
 - manually, 38 to 39



Discount-Merchant.com (800) 281-8860

76 *Index* THE TRUSTED SOURCE FOR PROJECTOR LAMPS AND ACCESSORIES

V

Video

- button, 53
 - selecting source, 39 to 40, 53
- Video device, connecting to, 36
- Volume, adjusting, 44, 53

W

- Warning lights, 61 to 62
- Wireless Ethernet card, 3
- Word, Microsoft, 8, 19

Z

- Zooming image, 41, 54



Discount-Merchant.com (800) 281-8860
THE TRUSTED SOURCE FOR PROJECTOR LAMPS AND ACCESSORIES

EPSON® PowerLite® 8150i User's Guide

EPSON®

EPSON® PowerLite® 8150i
Multimedia Projector



EPSON® PowerLite® 8150i
Multimedia Projector

 FixYourDLP.com
Sponsored by 

Discount-Merchant.com (800) 281-8860
THE TRUSTED SOURCE FOR PROJECTOR LAMPS AND ACCESSORIES



Disclaimer

This user manual is provided as a free service by FixYourDLP.com. FixYourDLP is in no way responsible for the content of this manual, nor do we guarantee its accuracy. FixYourDLP does not make any claim of copyright and all copyrights remain the property of their respective owners.

About FixYourDLP.com

FixYourDLP.com (<http://www.fixyourdpl.com>) is the World's #1 resource for media product news, reviews, do-it-yourself guides, and manuals.

Informational Blog: <http://www.fixyourdpl.com>

Video Guides: <http://www.fixyourdpl.com/guides>

User Forums: <http://www.fixyourdpl.com/forum>

FixYourDLP's Fight Against Counterfeit Lamps:

<http://www.fixyourdpl.com/counterfeits>

Sponsors:

RecycleYourLamp.org – Free lamp recycling services for used lamps:

<http://www.recycleyourlamp.org>

Lamp Research - The trusted 3rd party lamp research company:

<http://www.lampresearch.com>

Discount-Merchant.com – The worlds largest lamp distributor:

<http://www.discount-merchant.com>



FixYourDLP.com

Sponsored by 