



Disclaimer

This user manual is provided as a free service by FixYourDLP.com. FixYourDLP is in no way responsible for the content of this manual, nor do we guarantee its accuracy. FixYourDLP does not make any claim of copyright and all copyrights remain the property of their respective owners.

About FixYourDLP.com

FixYourDLP.com (<http://www.fixyourdlp.com>) is the World's #1 resource for media product news, reviews, do-it-yourself guides, and manuals.

Informational Blog: <http://www.fixyourdlp.com>

Video Guides: <http://www.fixyourdlp.com/guides>

User Forums: <http://www.fixyourdlp.com/forum>

FixYourDLP's Fight Against Counterfeit Lamps:

<http://www.fixyourdlp.com/counterfeits>

Sponsors:

RecycleYourLamp.org – Free lamp recycling services for used lamps:

<http://www.recycleyourlamp.org>

Lamp Research - The trusted 3rd party lamp research company:

<http://www.lampresearch.com>

Discount-Merchant.com – The worlds largest lamp distributor:

<http://www.discount-merchant.com>



FixYourDLP.com

Sponsored by 

EPSON®

User's Guide

MM PROJECTOR
ULTI EDIA

EMP-745
EMP-740
EMP-737
EMP-732

 **FixYourDLP.com**
Sponsored by 

Discount-Merchant.com (800) 281-8855
THE TRUSTED SOURCE FOR PROJECTOR LAMPS AND ACCESSORIES





Projector Features

Colour mode function

The following six preset colour modes are provided so that you can easily obtain optimum images simply by selecting a Colour mode.

In addition, if projecting onto blackboards rather than projection screens in places such as schools, you can select the "Blackboard" setting to allow images to be projected in their natural tints.

☛ p.47, p.56, p.58

- Dynamic
- Living Room
- Presentation
- [sRGB](#)
- Theatre
- Blackboard

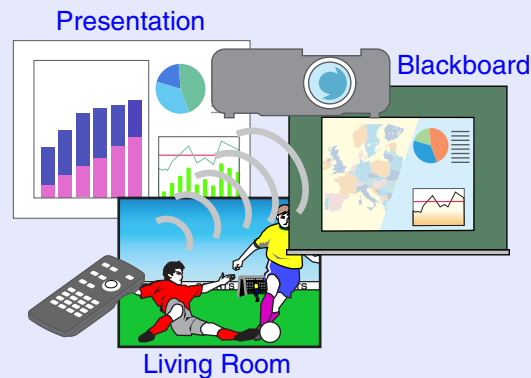

Compact and lightweight

The projector is compact B5 size (19.3 (D) × 27.6 (W) × 7 (H) cm) and lightweight (EMP-745/737 : approx. 1.8 kg, EMP-740/732 : approx. 1.7 kg). Easy to carry it with the included Soft carrying case which has a pocket to put cables and other accessories.

FixYourDLP.com
Sponsored by DM

Brilliant, attractive images

Despite its compact size, the projector can display images at high resolutions with a high degree of luminance, providing beautifully clear images even in bright environments.

Brightness Control

The brightness of the lamp can be set to one of two settings. Fine and clear images can be obtained even in a bright room like a conference room and a classroom.

If projecting images in a dark room or onto a small screen and the images are too bright, change the setting to "Low".

The advantages of the "Low" setting are

- Reduction in power consumption of approximately 20%
- Reduction in operating noise of approximately 12%
- Approximately 1.5 times longer lamp life

☛ p.62

Automatic keystone correction function

The vertical angle of the projector is detected, so that any vertical keystone distortion in the projected images can be automatically corrected. ☛ p.41

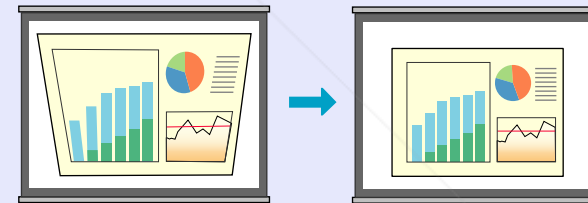

Easy Selection of Projection Images

Automatically detects images input from connected equipment. You can switch between the images with just a single touch of a button. ☛ p.37

Discount-Merchant.com (800) 281-8860

THE TRUSTED SOURCE FOR PROJECTOR LAMPS AND ACCESSORIES





Projector Features

Easy to Operate

The accessory remote control can be used to carry out operations such as pausing projection (Freeze function [p.51](#)), zooming in on important parts of images (E-Zoom function [p.52](#)) and pointing out important parts of images using a pointer icon (Pointer function [p.53](#)).

In addition, the remote control can be used to move the pointer around on the computer screen during projection (Wireless Mouse Function [p.22](#)).



Direct Power On

You can make the projector turn on and be ready to project images simply by connecting the power cable. You can also turn the power on for projectors in places such as meeting rooms where the power is centrally controlled, simply by turning the power on at the central control point. [p.65](#)

Operation Lock

This function locks the buttons on the projector's control panel.

This function is useful at times such as during shows and exhibitions, or in places such as schools to limit the range of buttons that can be used. [p.54](#)

Password protect function assists administration and theft prevention

Password protection function allows you to limit the use of the projector. This means that the projector cannot be used if it is taken without authorisation, and thus serves as a theft-prevention feature. [p.31](#)

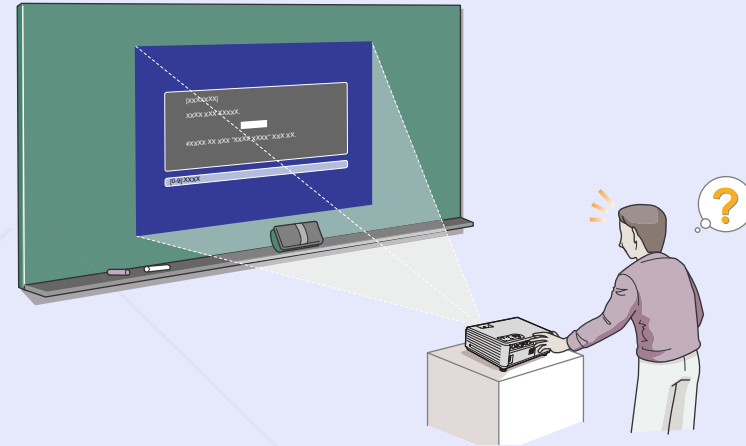

Projector's Control panel.

Sponsored by

Discount-Merchant.com (800) 281-8860

THE TRUSTED SOURCE FOR PROJECTOR LAMPS AND ACCESSORIES

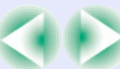



Projector Features

Network Support

(EMP-745/737 only)

When something goes wrong with the projector, such as a lamp blowing during projection, the projector can notify you of the error via e-mail.

In addition, by using EasyMP...

- Make easy network connection with a computer via a wireless LAN.
- Project a computer's image over a network.

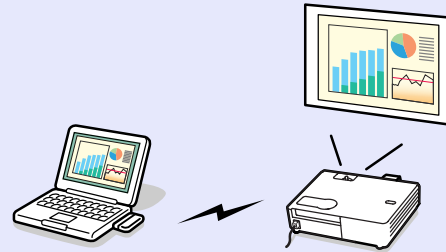

☛ For instructions on how to use EasyMP, refer to *EasyMP Network Setup Guide* and *EasyMP Operation Guide*.

Large-volume USB Storage is Available to Use

(EMP-745/737 only)

As well as a USB-compatible digital camera, you can use a USB-compatible hard disc and a USB-compatible memory device. This allows you to make a presentation without having a computer connected to the projector. ☛ [p.29](#), "[Showing the Presentation \(Using the CardPlayer\)](#)" in the *EasyMP Operation Guide*

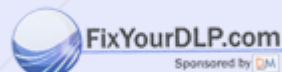

Discount-Merchant.com (800) 281-8860
THE TRUSTED SOURCE FOR PROJECTOR LAMPS AND ACCESSORIES





Contents

Projector Features	1
--------------------------	---

Before Using the Projector

Part Names and Functions	7
Front/Top	7
Control Panel	8
Rear	9
Base	10
Remote Control	11
Before Using the Remote Control	12
Inserting the Batteries	12
Using the Remote Control and Remote Operating Range	13
Installation	15
Setting Up the Projector	15
Screen Size and Projection Distance	16
Inserting and Removing Cards (EMP-745/737 only)	17
Installation	17
Removal	18
Access Lamp Status	19
Connecting to a Computer	20
Eligible Computers	20
Projecting Images from a Computer	21
Using the Remote Control to Operate the Mouse Pointer (Wireless Mouse Function)	22
Connecting to a Video Source	24
Projecting Composite Video Images	24
Projecting S-Video Images	25
Projecting Component Video Images	25
Projecting RGB Video Images	26
Playing Sound from Video Equipment	27

Playing Sound from External Speakers (EMP-745/737 only)	28
Connecting USB Devices (Digital Camera, Hard Disk Drive or Memory Devices) (EMP-745/737 only)	29
Connecting USB Devices	29
Disconnecting a USB Device from the Projector	30
Preventing theft (Password Protect)	31
When Password Protect is enabled	31
Setting Password Protect	32

Basic Operations

Turning the Projector On	35
Connecting the Power Cable	35
Turning the Power On and Projecting Images	36
Turning the Projector Off	38
Adjusting the Screen Image	40
Adjusting the Image Size (Zoom Function)	40
Focusing the Screen Image	40
Adjusting the Image Angle and Automatic Keystone Correction Function	41
Manually Correcting Keystone Distortion	43
Adjusting the Image Quality	44
Adjusting Computer Images and RGB Video Images	44
Selecting the Projection Quality (Colour Mode Selection)	47
Adjusting the Volume	48





Advanced Operations

Functions for Enhancing Projection.....	50
A/V Mute	50
Freeze	51
Wide-screen Projection of Images from Video Equipment (Changing the Aspect Ratio)	51
E-Zoom	52
Pointer function.....	53
Operation Button Lock Function	54
Using the Configuration Menu Functions	55
List of Functions	56
Using the Configuration Menus.....	69

Troubleshooting

Using the Help.....	73
Problems Solving	75
Reading the Indicators	75
When the Indicators Provide No Help	78

Appendices

Maintenance	99
Cleaning	99
Replacing Consumables	100
Saving a User's Logo	105
Optional Accessories and Consumables	108
Glossary	109
List of ESC/VP21 Commands	113
Command List	113
USB connection.....	113
USB Connection Setup.....	114
List of Supported Monitor Displays	115
Specifications	116
Appearance.....	118

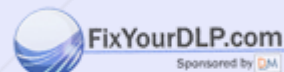

Discount-Merchant.com (800) 281-8860
THE TRUSTED SOURCE FOR PROJECTOR LAMPS AND ACCESSORIES



Before Using the Projector



This chapter describes the procedures for setting up the projector before use.













Part Names and Functions	7	• Projecting Images from a Computer	21
• Front/Top	7	• If the Monitor Port is a Mini D-Sub 15-pin Port (Example).....	21
• Control Panel	8	• Using the Remote Control to Operate the Mouse Pointer (Wireless Mouse Function)	22
• Rear	9	Connecting to a Video Source	24
• Base	10	• Projecting Composite Video Images	24
• Remote Control	11	• Projecting S-Video Images	25
Before Using the Remote Control	12	• Projecting Component Video Images	25
• Inserting the Batteries	12	• Projecting RGB Video Images	26
• Using the Remote Control and Remote Operating Range	13	Playing Sound from Video Equipment	27
• Using the Remote Control	13	Playing Sound from External Speakers (EMP-745/737 only)	28
• Remote Operating Range.....	14	Connecting USB Devices (Digital Camera, Hard Disk Drive or Memory Devices) (EMP-745/737 only)	29
Installation	15	• Connecting USB Devices	29
• Setting Up the Projector	15	• Disconnecting a USB Device from the Projector	30
• Screen Size and Projection Distance	16	Preventing theft (Password Protect)	31
Inserting and Removing Cards (EMP-745/737 only)	17	• When Password Protect is enabled	31
• Installation	17	• When "Power ON Protect" is enabled (ON)	31
• Removal	18	• If the "Timer" Setting is for One Hour or More	32
• Access Lamp Status	19	• When "User's Logo Protect" is enabled (ON).....	32
• Card Slot Access Lamp Status.....	19	• Setting Password Protect	32
• Wireless LAN Card Access Lamp Status.....	19		
Connecting to a Computer	20		
• Eligible Computers	20		

FixYourDLP.com
Sponsored by
Discount-Merchant.com (800) 281-8860
THE TRUSTED SOURCE FOR PROJECTOR, LAMPS AND ACCESSORIES



Part Names and Functions

Front/Top

-
- **Zoom ring**  [p.40](#)
Adjusts the image size.
 - **Focus ring**  [p.40](#)
Adjusts the image focus.
 - **Air exhaust vent**
 Do not touch during or immediately after projection, as it can become hot.
 - **Card slot (EMP-745/737 only)**  [p.17](#)
Insert a LAN card or memory card in here when using EasyMP.
 - **Foot adjust lever**  [p.41](#)
Pull out the foot lever to extend and retract the front foot.
 - **Front adjustable foot**  [p.41](#)
Extend and retract to adjust the projection angle when the projector is placed on a surface such as a shelf.
 - **Control panel**  [p.8](#)
 - **Temperature indicator**  [p.75](#)
Flashes or lights in different colours to indicate problems with the internal temperature of the projector.
 - **Lamp indicator**  [p.75](#)
Flashes or lights in different colours to indicate problems with the projection lamp.
 - **Power indicator**  [p.75](#)
Flashes or lights in different colours to indicate the operating status of the projector.
 - **Remote control light-receiving area**  [p.13](#)
Receives signals from the remote control.
 - **Security lock (A)**  [p.110](#)
 - **Lens cover**
Attach when not using the projector to prevent the lens from becoming dirty or damaged.



FixYourDLP.com
Sponsored by DM

Discount-Merchant.com (800) 281-8860
THE TRUSTED SOURCE FOR PROJECTOR LAMPS AND ACCESSORIES



Control Panel

• [Source Search] button p.37

The next input source is searched for automatically in the following order and the image input from the connected equipment is projected each time this button is pressed.

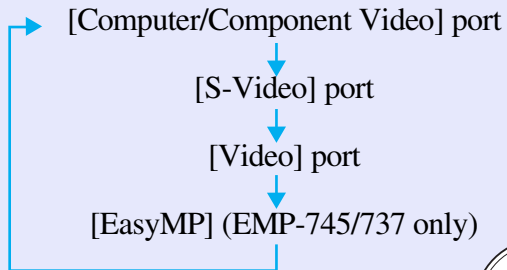

• [Power] button p.36, p.38

Turns the projector power on or off.

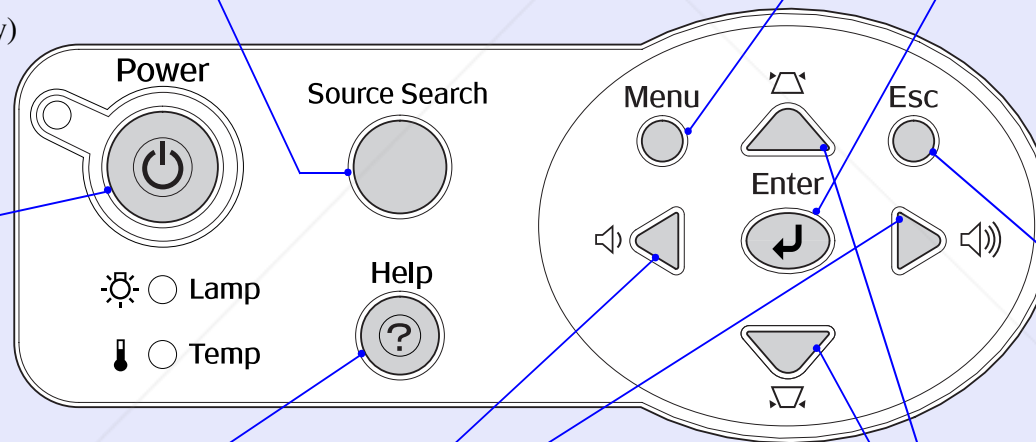

• [Menu] button p.69

Displays or hides the configuration menu.

• [Enter] button p.44, p.69, p.73

Automatically adjusts analogue RGB images from computers and RGB video images to the optimum display. If a configuration menu or help screen is displayed, it accepts the current selection and moves on to the next-lowest level.

• [Esc] button p.23

Stops the current function. Displays the previous screen or menu while viewing a configuration menu.

• [Help] button p.73

Each time this button is pressed, it displays or hides the online help menu that can assist you if you have a problem.

• [Left] [Right] button p.48, p.73

Press to adjust the sound volume. If a configuration menu or help screen is displayed, it selects menu items and setting values.









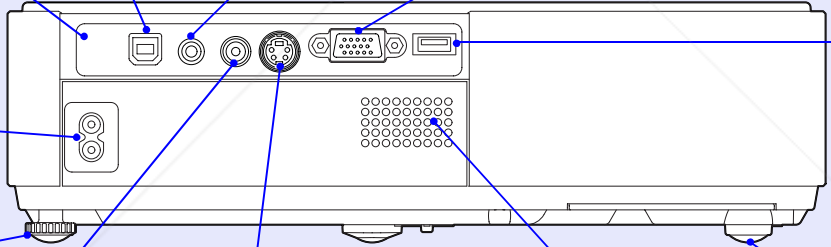

• [Up] [Down] button p.42, p.69, p.73

Press to correct keystone distortion. If a configuration menu or help screen is displayed, it selects menu items and setting values.



Part Names and Functions

Rear

- 
- **[USB TypeB] port**  [p.22, p.113](#)
Connects the projector to a computer via the [USB](#) cable when using the wireless mouse function.
This port cannot be used for receiving images from your computer via USB.
 - **Remote control light-receiving area**  [p.13](#)
Receives signals from the remote control.
 - **Power inlet**  [p.35](#)
Connects to the power cable.
 - **Rear adjustable foot**  [p.42](#)
 - **[Video] port**  [p.24](#)
Inputs [composite video](#) signals to projector from other video sources.
 - **[S-Video] port**  [p.25](#)
Inputs [S-Video](#) signals to the projector from other video sources.
 - **[Audio] port**  [p.27](#)
Input audio signals from connected equipment. When projecting using the CardPlayer function of EasyMP, this port can be used to output the audio signals to external speakers by setting "EasyMP Audio Out". (EMP-745/737 only)  [p.63](#)
 - **[Computer/Component Video] port**  [p.21, p.25, p.26](#)
Input analogue RGB video signals from a computer and RGB video signals and [component video](#) signals from other video sources.
 - **[USB TypeA] port (EMP-745/737 only)**  [p.29](#)
Connects a digital camera or USB hard disc/memory device to project image/movie files or scenarios from such media using the CardPlayer function of EasyMP.
 - **Rear adjustable foot**
 - **Speaker**



Base

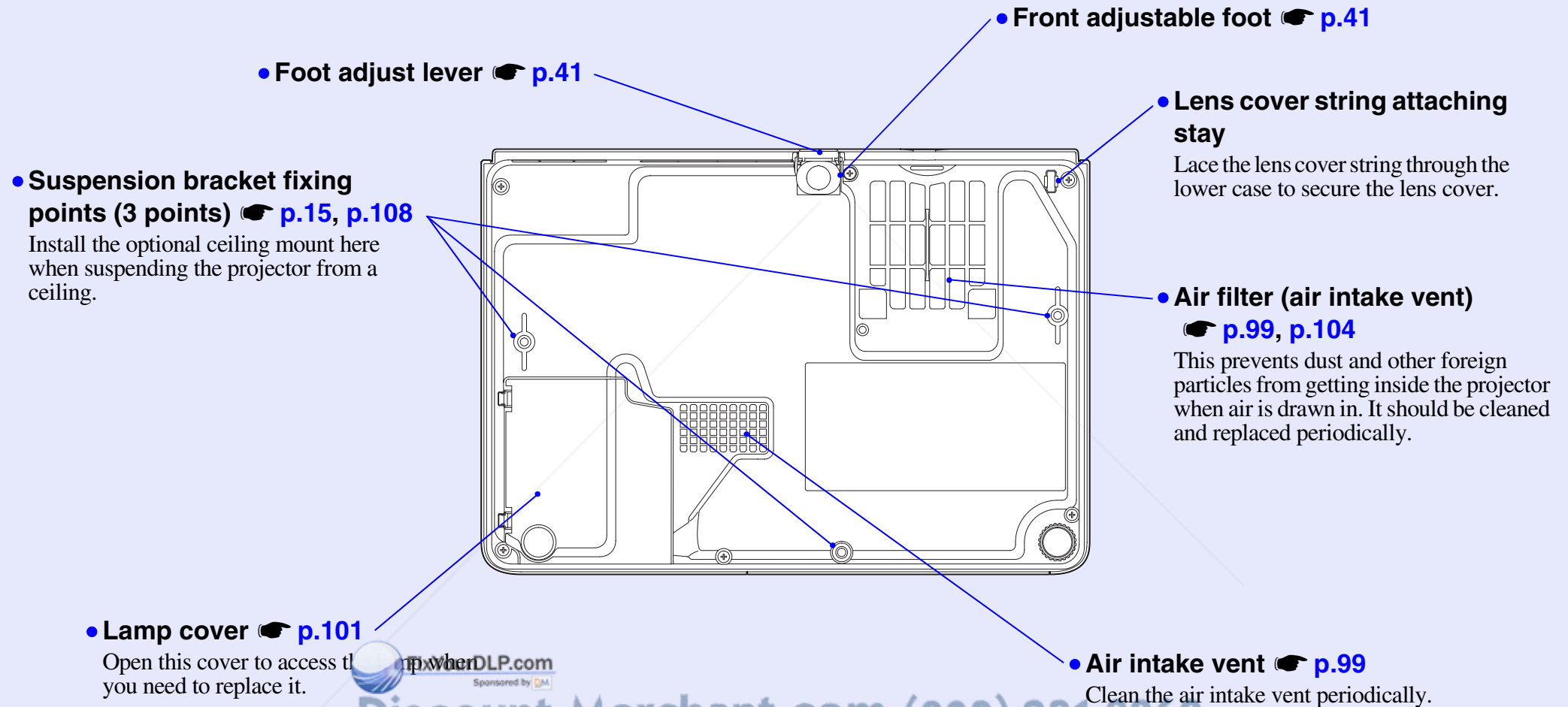



Remote Control

If you position the  over the button icon or button name, a description of that button will appear.

- [Page down] [Page up] buttons  [p.22](#)

- [E-Zoom] button (⊕) (⊖)  [p.52](#)

- [Enter] button  [p.23, p.69, p.73](#)

- [Esc] button  [p.23](#)

- [Pointer] button  [p.53](#)

- [A/V Mute] button  [p.50](#)

- [Computer] button  [p.37](#)

- [EasyMP] button  [p.37](#)

- [S-Video] button  [p.37](#)

- [Video] button  [p.37](#)

- [Auto] button  [p.44](#)

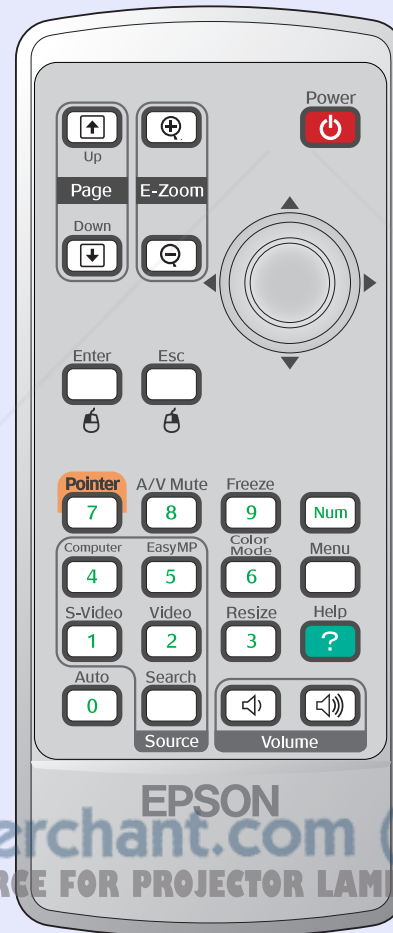

- Remote control light-emitting area  [p.13](#)

- [Power] button  [p.36, p.38](#)

- [⊕/⊖] buttons  [p.23, p.69, p.73](#)

- [Freeze] button  [p.51](#)

- [Num] button  [p.31](#)

- [Color Mode] button  [p.47](#)

- [Menu] button  [p.69](#)

- [Resize] button  [p.51](#)

- [Help] button  [p.73](#)

- [Volume] buttons  [p.48](#)

- [Search] button  [p.37](#)

- Numeric buttons  [p.31](#)



Before Using the Remote Control

Inserting the Batteries

The batteries are not already inserted into the remote control at the time the projector is purchased. You will need to insert the batteries that are provided with the projector before the remote control can be used.



CAUTION

Make sure you read the separate Safety Instructions/World-Wide Warranty Terms before handling the batteries.

PROCEDURE

1 Remove the battery cover.

While pushing the catch of the battery compartment cover, lift the cover up.

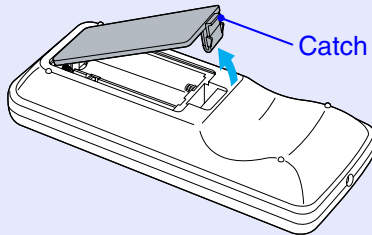

2

Insert the batteries.

Check the positions of the (+) and (-) marks inside the battery holder to ensure that the batteries are inserted the correct way.

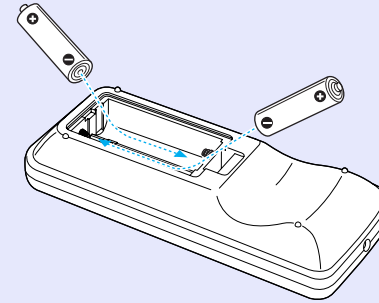

3

Replace the battery cover.

Press the battery compartment cover until it clicks into place.

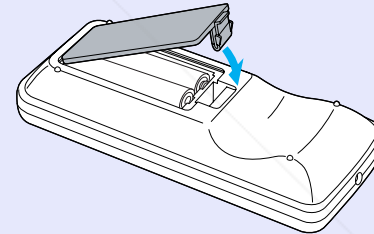

TIP

If delays in the responsiveness of the remote control occur or if it does not operate after it has been used for some time, it probably means that the batteries are becoming flat. Have two spare AAA-size alkali batteries ready to use when required.



Before Using the Remote Control

Using the Remote Control and Remote Operating Range

Using the Remote Control

The remote control is used in the following way.

PROCEDURE

Point the remote control light-emitting area toward one of the remote control light-receiving areas on the projector and operate the remote control buttons.

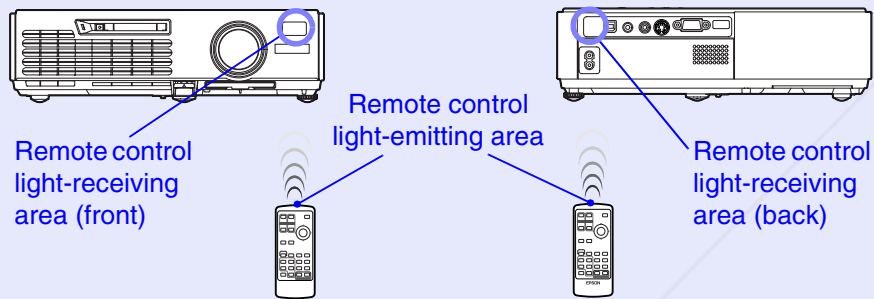

TIP

- Do not allow sunlight or light from fluorescent lamps to shine directly onto the projector's remote control light-receiving areas, otherwise it may interfere with the reception of signals from the remote control.
- If delays in the responsiveness of the remote control occur or if it does not operate after it has been used for some time, it probably means that the batteries are becoming flat. If this happens, replace the batteries with new ones. [p.12](#)
- If any of the buttons on the remote control are pressed down for more than 30 seconds, the remote control stops to send signals (remote control's sleep mode). The purpose of this is to prevent the batteries from being consumed due to something being placed on top of the remote control. When the button is released, normal remote control operation will resume.

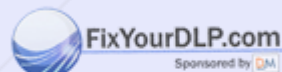

Discount-Merchant.com (800) 281-8860
THE TRUSTED SOURCE FOR PROJECTOR LAMPS AND ACCESSORIES



Before Using the Remote Control

Remote Operating Range

Use the remote control within the ranges indicated below. If the distance or angle between the remote control and the remote control light-receiving area is outside the normal operating range, the remote control may not work.

Operating distance	Operating angle
Approx. 6 m (20 ft.)	Approx. $\pm 30^\circ$ horizontally Approx. $\pm 15^\circ$ vertically

Operating angle (horizontal)

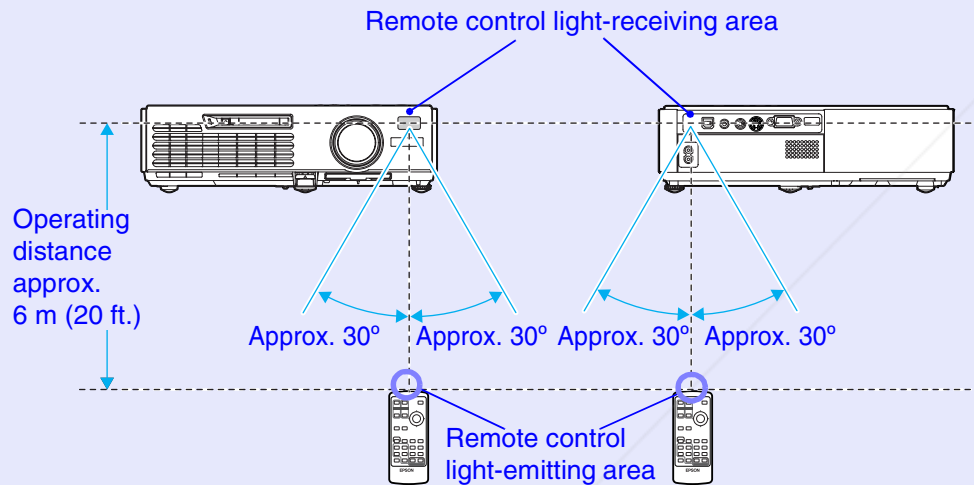

Operating angle (vertical)

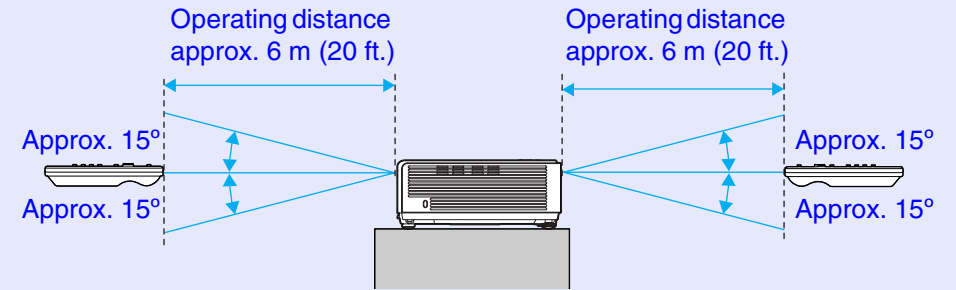

When suspended from the ceiling

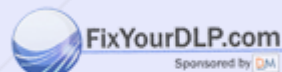
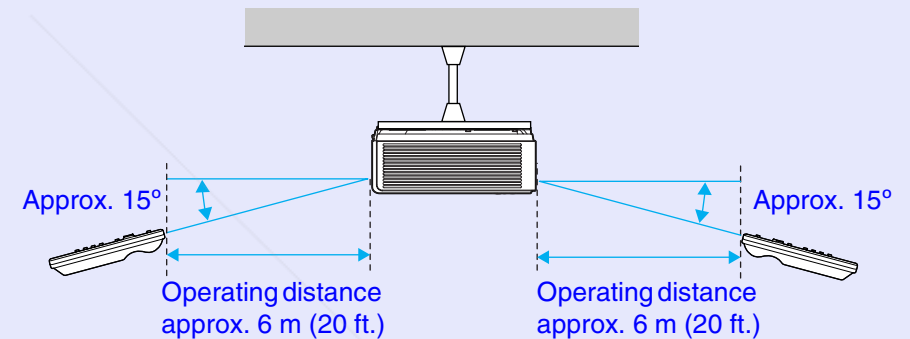

Discount-Merchant.com (800) 281-8860
THE TRUSTED SOURCE FOR PROJECTOR LAMPS AND ACCESSORIES



Installation

Setting Up the Projector

The projector supports the following four different projection methods, allowing you to choose the best method for displaying your images.



CAUTION

- *Before setting up the projector, make sure you read the separate Safety Instructions/World-Wide Warranty Terms first.*
- *Do not set this projector up on its side to carry out projection, otherwise malfunctions may occur.*

- Front projection

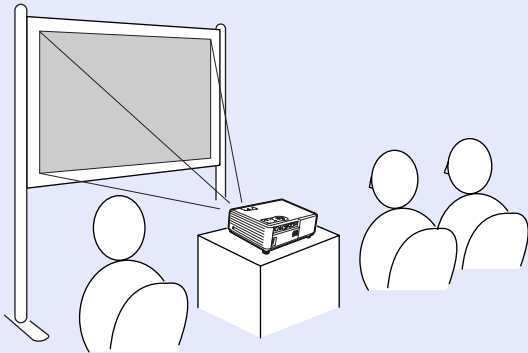

- Rear projection using a translucent screen

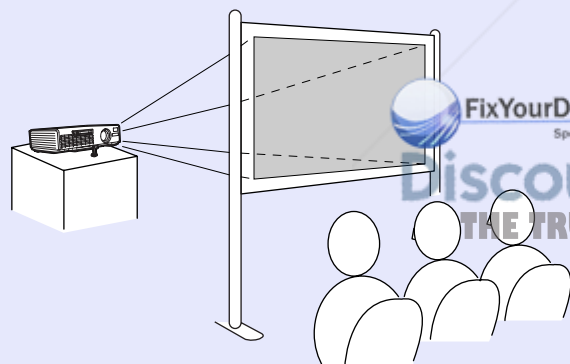

- Front/ceiling projection

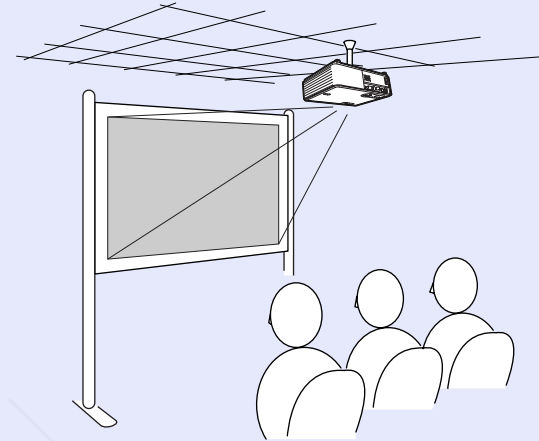

- Rear/ceiling projection using a translucent screen

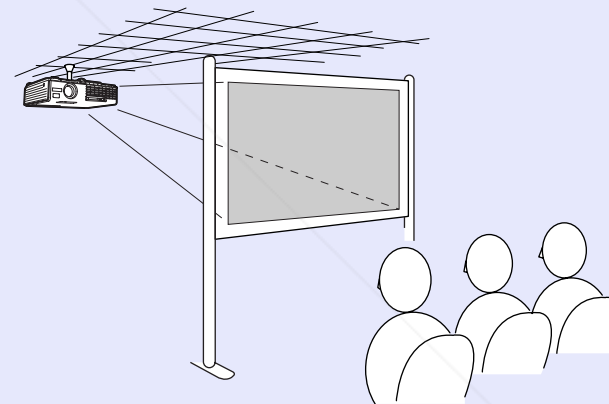

* A special method of installation is required for suspending the projector from the ceiling. Please contact your supplier if you would like to use this installation method. The optional ceiling mount is required when installing the projector on the ceiling. [p.108](#)

TIP (800) 281-8860

When using ceiling projection or projection using a translucent screen, set the "Projection" command in the "Extended" menu to match the installation method. [p.65](#)

FixYourDLP.com
Sponsored by DLP

Discount-Merchant.com THE TRUSTED SOURCE FOR PROJECTOR LAMPS AND ACCESSORIES



Screen Size and Projection Distance

The distance between the projector's lens and the screen determines the actual image size.

Recommended distance	100–1210 cm (3.2–39.7 ft.)
-----------------------------	----------------------------

While referring to the following table, position the projector so that the images are projected onto the screen at the optimum size.

The values should be used as a guide for setting up the projector. The actual values will vary depending on projection conditions and the zoom setting.

4:3 Screen size	Units: cm (in.)		Units: cm (ft.)	Units: cm (in.)
	Projection distance A		Distance from centre of lens to bottom edge of screen B	
	Shortest (wide)	Longest (tele)		
30"	61 × 46 (24.0 × 18.1)	100–120 (3.2–3.9)	6.5 (2.6)	
40"	81 × 61 (31.9 × 24.0)	130–160 (4.4–5.2)	8.7 (3.4)	
50"	100 × 76 (39.4 × 30.0)	166–200 (5.5–6.6)	10.9 (4.3)	
60"	120 × 90 (47.2 × 35.4)	200–240 (6.6–7.9)	13.1 (5.1)	
80"	160 × 120 (63.0 × 47.2)	270–320 (8.8–10.5)	17.4 (6.9)	
100"	200 × 150 (78.7 × 59.1)	340–400 (11.0–13.2)	21.8 (8.6)	
200"	410 × 300 (161.4 × 118.1)	670–810 (22.0–26.4)	43.5 (17.1)	
300"	610 × 460 (240.2 × 181.1)	1010–1210 (33.1–39.7)	65.3 (25.7)	

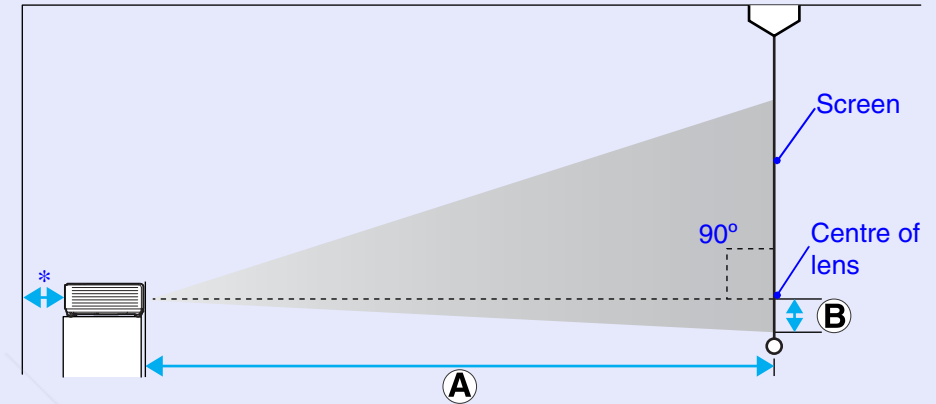

* When installing against a wall, leave a space of about 20 cm (7.9 in.) between the projector and the wall.



TIP

- The projector's lens allows a zoom ratio of up to about 1.2. The image size at the maximum zoom setting is about 1.2 times bigger than the image size at the minimum zoom setting.
- The image size will be reduced when keystone correction is carried out.



Inserting and Removing Cards (EMP-745/737 only)

You can use PC cards such as wireless LAN cards and memory cards with the EMP-745/737.

Inserting and removing PC cards will be explained using the included wireless LAN card provided as an example. The wireless LAN card provided with the projector will be used as an example in this manual to explain how to insert and remove PC cards.



TIP

The following PC cards can be inserted into the projector's card slot.

- **Wireless LAN card** (only the one supplied with the projector)
- **Wired LAN card** (For details on compatible cards, please visit this web site "<http://www.epson.co.uk/>".)
- **Memory card** ➔ "Specifications" p.116

Installation



CAUTION

- **Insert the PC card facing the correct way. Installing the device back to front or upside down may cause failure or damage.**
- **Make sure you remove the card before transporting the projector.**

PROCEDURE

Insert the PC card into the card slot so that it is facing upwards.

Insert firmly into the slot until it is secure.

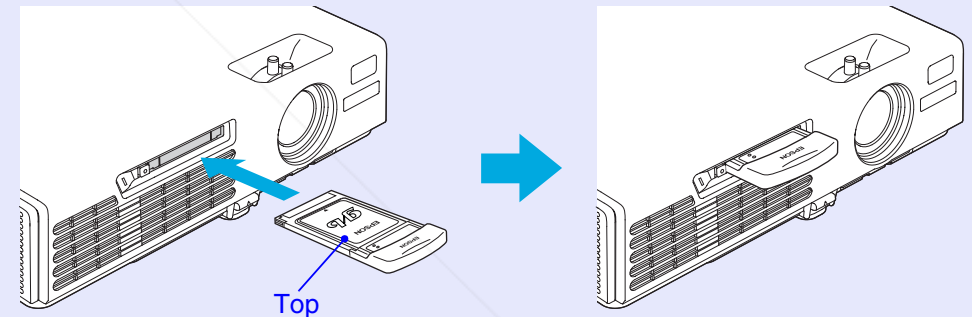



Removal

CAUTION

- Do not remove the wireless LAN card while the access lamp on the wireless LAN card is flashing green, this may damage the card.
- Do not remove a memory card while the access lamp of the projector's card slot is flashing green, or while projecting a scenario. Doing so may damage the memory card or data in the card.
- The PC card gets hot during and immediately after projector use. Handle the card carefully when removing it from the card slot to avoid personal injury or burns.
- When you wish to remove a memory card while using CardPlayer, make sure you close CardPlayer before removal. CardPlayer may malfunction if a memory card is removed without closing CardPlayer first. ➔ "Closing CardPlayer" in the EasyMP Operation Guide

PROCEDURE

- 1 Press the eject button to the left of the card slot.
The eject button will pop out.

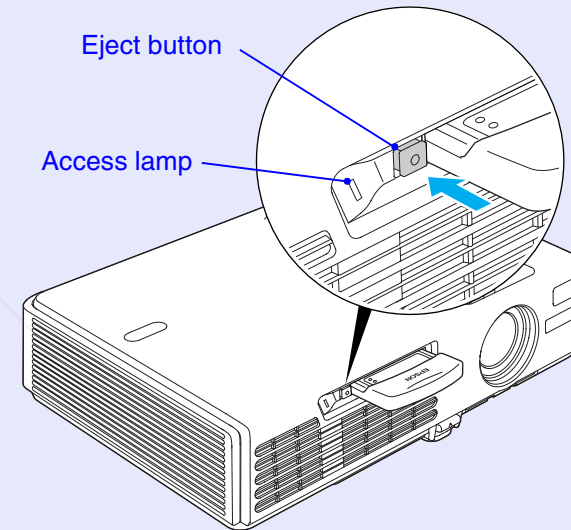

- 2 Press the eject button again.
Enough of the PC card will be ejected so that you can grasp the edge of the card and pull it straight out of the slot.

CAUTION

Make sure you press the eject button back in to prevent it from being broken or damaged.





Access Lamp Status

■ Card Slot Access Lamp Status

When a memory card has been inserted into the projector's card slot, you can check the access status of the memory card by noting whether the access lamp is lit and what colour it is, as described below.

 Lit  Off

Status	Access status
Green 	Data is being read from the memory card.
Off 	The memory card is in standby state.
Red 	An error occurred while data was being read from the memory card.



■ Wireless LAN Card Access Lamp Status

The card slot access lamp does not light when a wireless LAN card has been inserted into the projector.

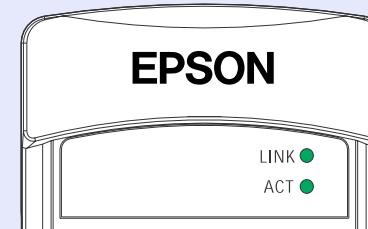
You can check the network communication status by observing the status of the wireless LAN access lamps as described below.



 Lit  flashing

Lamp	Status	Communication status
LINK	Green 	The projector is connected to the network and communication is possible.
	Green 	Connection to a valid network is in progress.
ACT	Green 	Data is being transmitted or received.



Connecting to a Computer



CAUTION

When connecting the projector to a computer, make sure you check the following.

- *Turn the power off for both the projector and the computer before connecting them. If the power for either device is on at the time of connection, damage may result.*
- *Check the shapes of the cable connectors and the device ports before making the connections. If you try to force a connector to fit a device port with a different shape or number of terminals, damage to the connector or port may result.*
- *Do not bind the power cable and the connecting cable together. If the power cable and the connecting cable are bound together, image interference or errors in operation may result.*

Eligible Computers

The method for connecting the projector to a computer using a cable is explained here.

If using an EMP-745/737, see the EasyMP Network Setup Guide for information on how to connect to a computer over a network.

The projector cannot be connected to some types of computer, or projection of images may not be possible even if actual connection is possible. Make sure that the computer you intend to use satisfies the conditions given below.

- **Condition 1:** The computer must have an image signal output port. Check that the computer has a port such as an "RGB port", "monitor port" or "CRT port" which can output image signals.
If the computer has a built-in monitor, or if using a laptop computer, it may not be possible to connect the computer to the projector, or alternatively you may need to purchase a separate external output port. Refer to the documentation for your computer under a heading such as "Connecting an external monitor" or similar for further details.
- **Condition 2:** The display resolution and frequency of the computer must be listed in the "List of Supported Monitor Displays".
☛ "Appendices: List of Supported Monitor Displays" [p.115](#).
Some computers allow you to change the output resolution, so if necessary, change the resolution to one that matches a setting in the "List of Supported Monitor Displays", while referring to the documentation provided with the computer.



TIP

- *You may need to purchase a separate adapter depending on the shape of the computer's port. Refer to the documentation provided with the computer for further details.*
- *If the computer and projector are too far away from each other for the accessory computer cable to reach, use the optional VGA-HD15 PC cable. "Appendices: Optional Accessories and Consumables" [p.108](#)*



Projecting Images from a Computer

The shape and specifications of the computer's monitor port will determine what type of cable should be used. Check the following to see which type of port your computer has.

■ If the Monitor Port is a Mini D-Sub 15-pin Port (Example)

Use the accessory computer cable to make the connection.

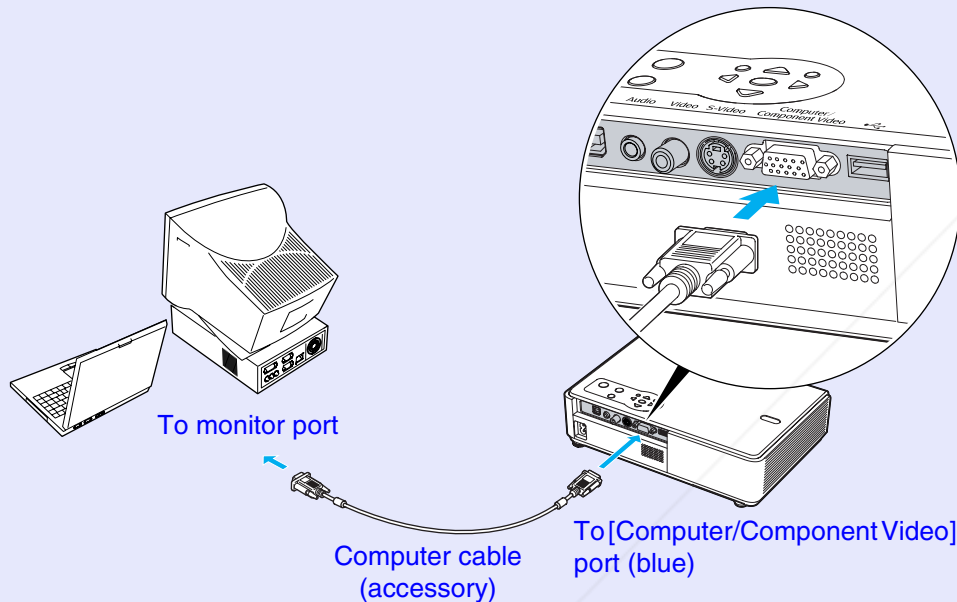

TIP

- *The input source is determined automatically based on the input signals.
Some computer signals may be reproduced with different colours from the original images. In such case, set the input source to "Computer".* 🖱️ [p.60](#)
- *If more than one input source is connected to the projector at the same time, you can use button operations to select the signals to be projected.* 🖱️ [p.37](#)

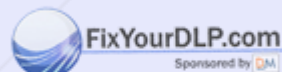

Discount-Merchant.com (800) 281-8860
THE TRUSTED SOURCE FOR PROJECTOR LAMPS AND ACCESSORIES



Using the Remote Control to Operate the Mouse Pointer (Wireless Mouse Function)

You can use the remote control as a wireless mouse to control the mouse pointer on the computer screen. To do this, you must use the accessory [USB](#) cable to connect the computer's USB port to the [USB TypeB] port at the rear of the projector.

Computer	Mouse used	Applicable cable
Windows 98/2000/Me/XP Home Edition/XP Professional	USB mouse	USB cable (accessory)
Macintosh (OS 8.6–9.2/10.0–10.3)	USB mouse	USB cable (accessory)

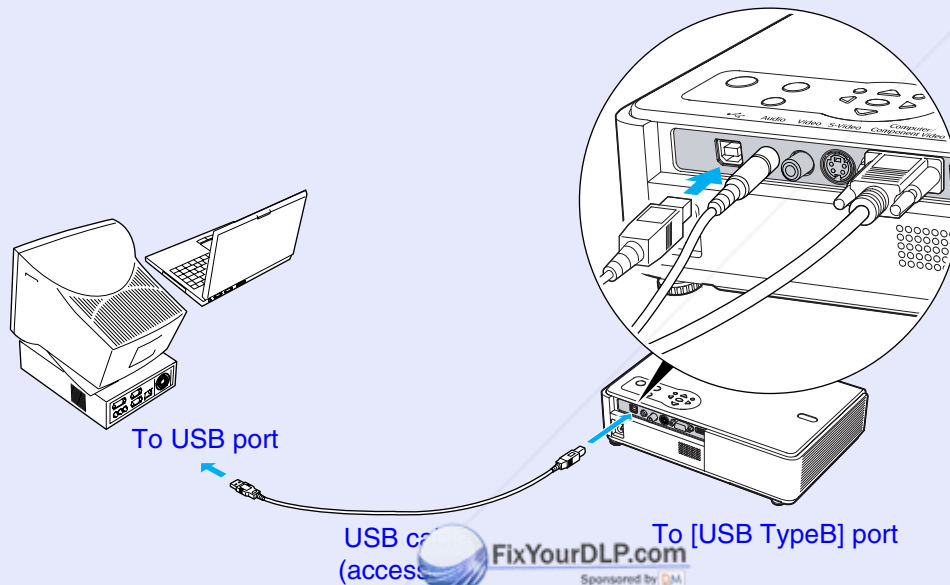

TIP

- *If your projector is an EMP-745/737, the [USB TypeA] port on the back of the projector does not function as a USB hub.*
- *The USB cable can only be connected to computers with a standard USB interface. If using a computer which is running Windows, the computer must have had a full version of Windows 98/2000/Me/XP Home Edition/XP Professional installed. If the computer is running a version of Windows 98/2000/Me/XP Home Edition/XP Professional that has been upgraded from an earlier version of Windows, correct operation cannot be guaranteed.*
- *It may not be possible to use the mouse function under some versions of both the Windows and Macintosh operating systems.*
- *Some computer settings may have to be changed in order for the mouse function to be used. Consult the computer's documentation for further details.*

* When using the remote control as a wireless mouse, the [Page down] and [Page up] buttons on the remote control can be used to scroll back and forth through slides when projecting a PowerPoint presentation.





Connecting to a Computer

Once the connection has been made, the mouse pointer can be operated as follows.

Moving the mouse pointer

If you tilt the [Dial] button on the remote control, the mouse pointer will move in the direction of tilt.

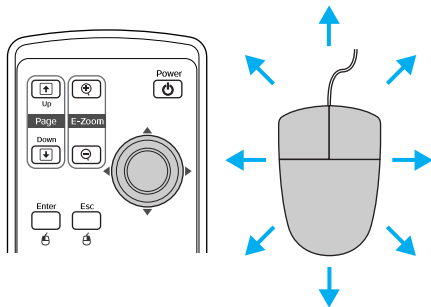

Left click

Press the [Enter] button.

If you press the [Enter] button twice in rapid succession, it has the effect of a double-click.

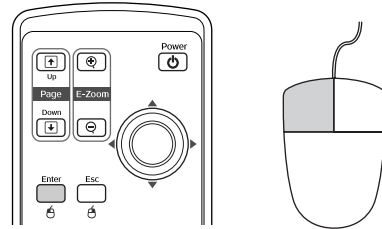

Right click

Press the [Esc] button.

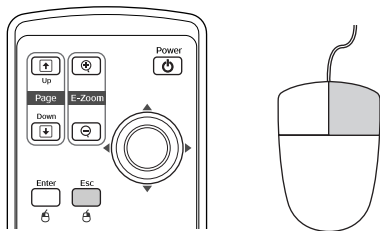

Drag and drop

If you tilt the [Dial] button while keeping the [Enter] button pressed down, you can carry out drag operations. Press the [Enter] button at the desired location to drop the item being dragged.

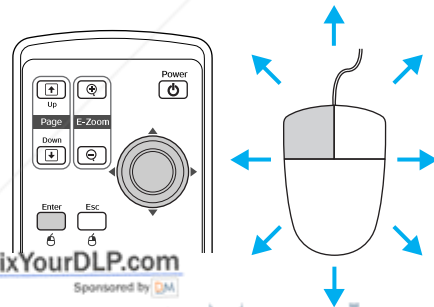

TIP

- *If the mouse button settings have been reversed at the computer, the operation of the remote control buttons will also be reversed.*
- *The wireless mouse function cannot be used while the following functions are being used.*
 - *While a configuration menu is being displayed*
 - *While a help menu is being displayed*
 - *While the E-Zoom function is being used*
 - *While a user's logo is being captured*
 - *Pointer function*
 - *While adjusting the sound volume*



FixYourDLP.com
Sponsored by DLP

Discount-Merchant.com (800) 281-8860
THE TRUSTED SOURCE FOR PROJECTOR LAMPS AND ACCESSORIES





Connecting to a Video Source

CAUTION

When connecting the projector to video equipment, take the following precautions.

- Turn the power off for both the projector and the video equipment before connecting them. If the power for either device is on at the time of connection, damage may result.
- Check the shapes of the cable connectors and the device ports before making the connections. If you try to force a connector to fit a device port with a different shape or number of terminals, a malfunction or damage to the connector or port may result.
- Do not bind the power cable and the connecting cable together. If the power cable and the connecting cable are bound together, image interference or errors in operation may result.

Projecting Composite Video Images

Use a commercially- available A/V cable to make the connection.

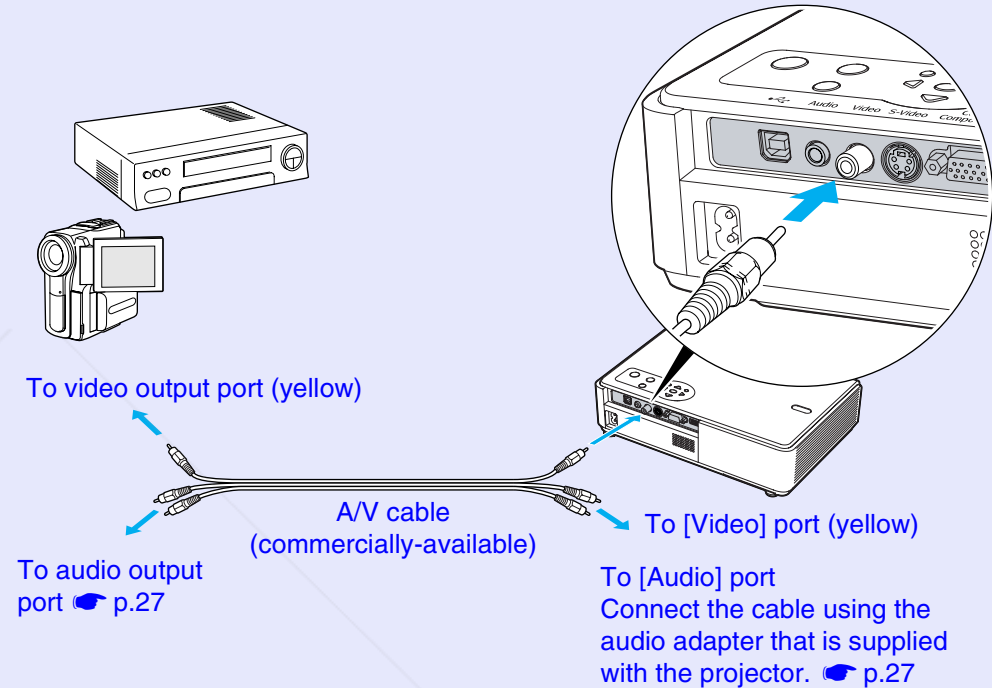

TIP

If more than one input source is connected to the projector at the same time, you can use button operations to select the signals to be projected. p.37

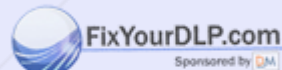

Discount-Merchant.com (800) 281-8860
THE TRUSTED SOURCE FOR PROJECTOR LAMPS AND ACCESSORIES



Connecting to a Video Source

Projecting S-Video Images

Use a commercially-available [S-Video](#) cable to make the connections.

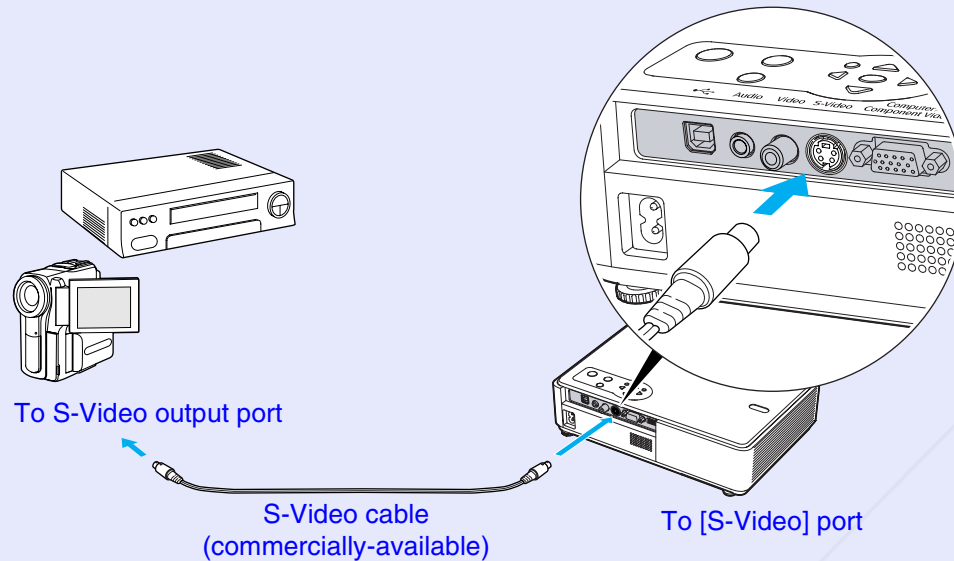

TIP

If more than one input source is connected to the projector at the same time, you can use button operations to select the signals to be projected. [p.37](#)

Projecting Component Video Images

Use the optional [component video](#) cable to make the connection. "Appendices: Optional Accessories and Consumables" [p.108](#)

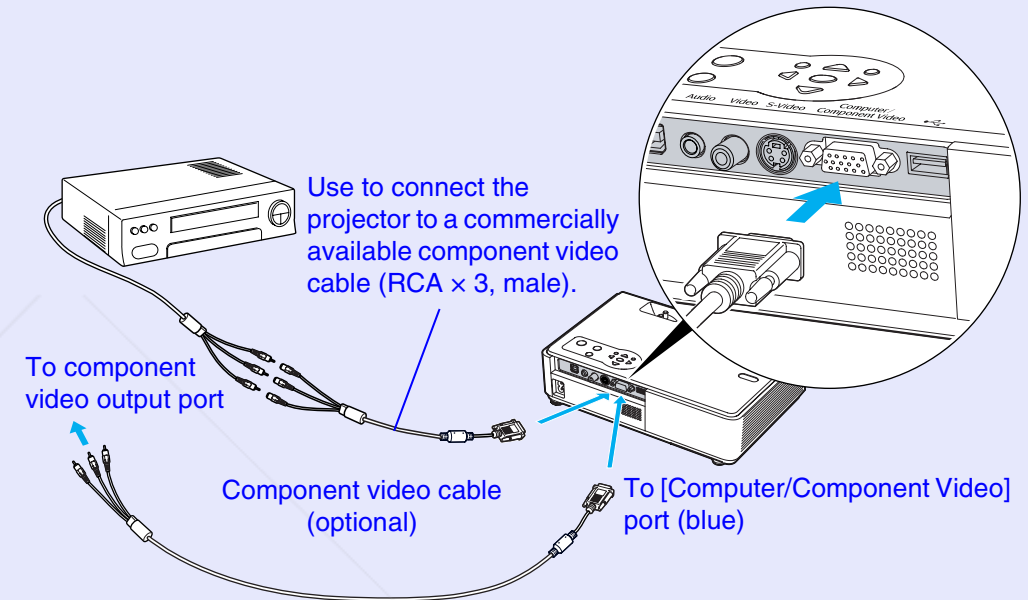

TIP

- *The input source is determined automatically based on the input signals. Some video signals may be reproduced with different colours from the original images. In such case, set the input source to "Component Video". [p.61](#)*
- *If more than one input source is connected to the projector at the same time, you can use button operations to select the signals to be projected. [p.37](#)*



Connecting to a Video Source

Projecting RGB Video Images

Use the accessory computer cable to make the connections.

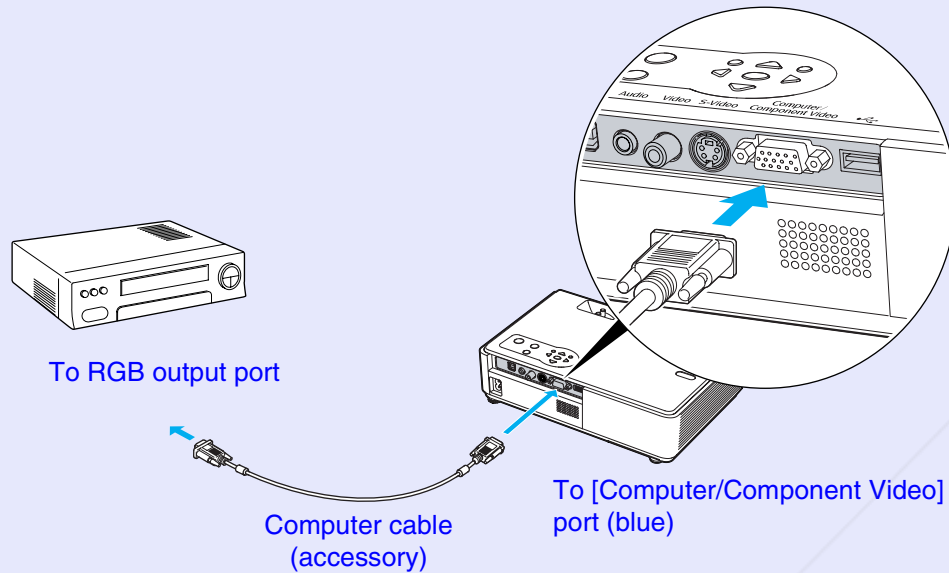

TIP

- *The input source is determined automatically based on the input signals. Some video signals may be reproduced with different colours from the original images. In such case, set the input source to "Computer".* 🖱️ [p.60](#)
- *If more than one input source is connected to the projector at the same time, you can use button combinations to select the signals to be projected.* 🖱️ [p.37](#)

Discount-Merchant.com (800) 281-8860

THE TRUSTED SOURCE FOR PROJECTOR LAMPS AND ACCESSORIES



Playing Sound from Video Equipment

The projector has a built-in speaker with a maximum output of 1 W. You can output sound from connected video equipment (such as a computer or video deck) through the projector's built-in speaker if the video equipment has an audio output port.

Select the audio cable that is used for this connection from the following, depending on the shape of the other equipment's port.

- If connecting to a stereo mini jack (such as the audio output port of a computer): Use a commercially-available stereo mini jack audio cable to make the connection.
- If connecting to an RCA pin jack ×2 (red/white) (such as the audio output port of video equipment): Use the audio adapter that is supplied with the projector and a commercially-available A/V cable to make the connection.



TIP

- *You can adjust the volume after projection has started.* [p.48](#)
- *If using a commercially-available 2RCA (L/R)/stereo mini-jack audio cable, use one that is marked as "No resistance".*

If the image signals are being input to the [Computer/Component Video] port

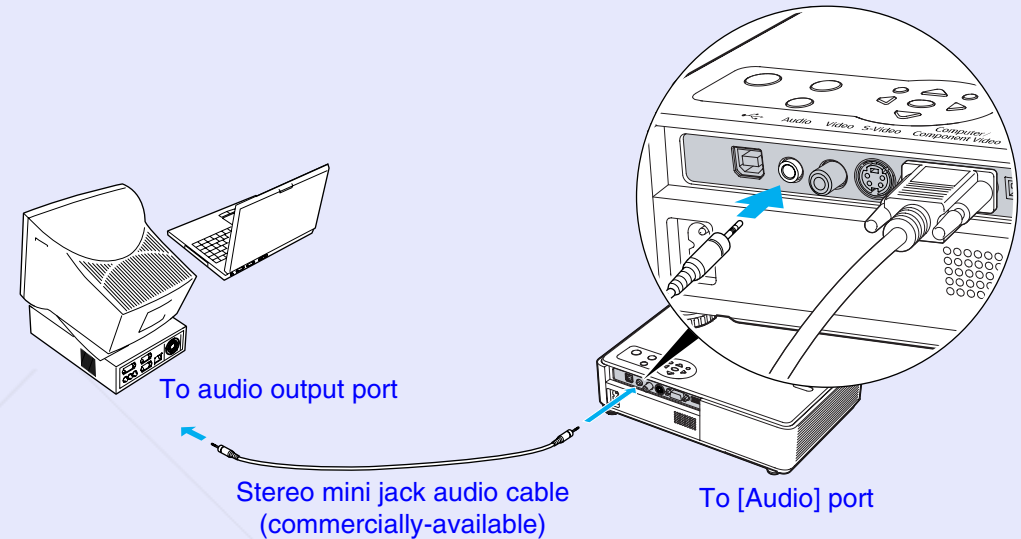

If the video signals are being input to the [Video] port

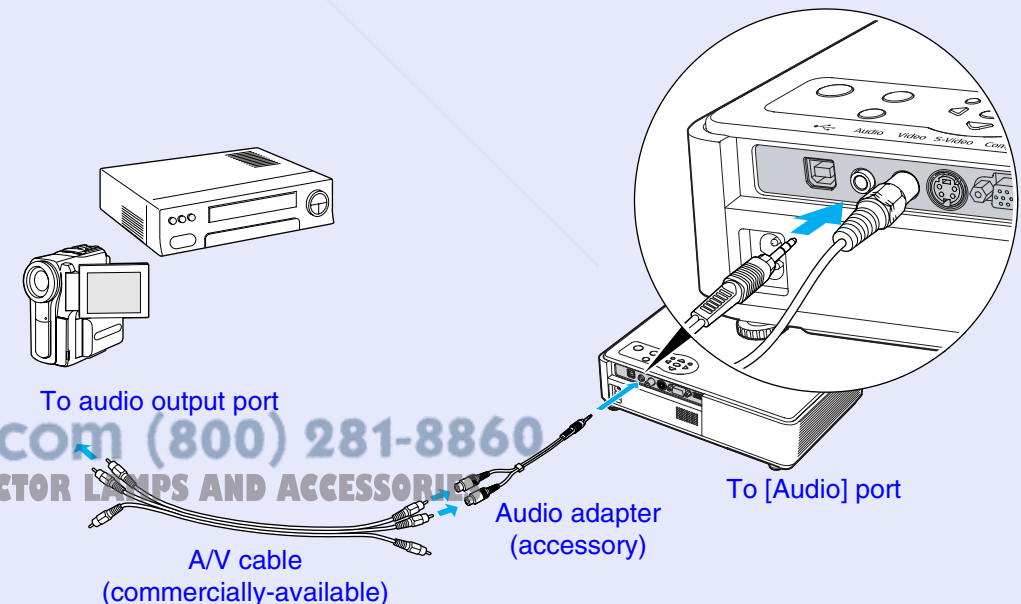

FixYourDLP.com
Sponsored by

Discount-Merchant.com (800) 281-8860

THE TRUSTED SOURCE FOR PROJECTOR LAMPS AND ACCESSORIES



Playing Sound from External Speakers (EMP-745/737 only)

When projecting using the CardPlayer function of EasyMP, you can output the audio signals to external speakers.

Set the "EasyMP Audio Out" to "External" and connect speakers with built-in amplifiers to the projector's [Audio] port in order to enjoy a fuller quality of sound.  p.63

Use a commercially-available audio cable with pin jack ↔ stereo mini jack (3.5 mm) plugs or similar.

Use an audio cable with a plugs that match the ports for the external audio equipment.

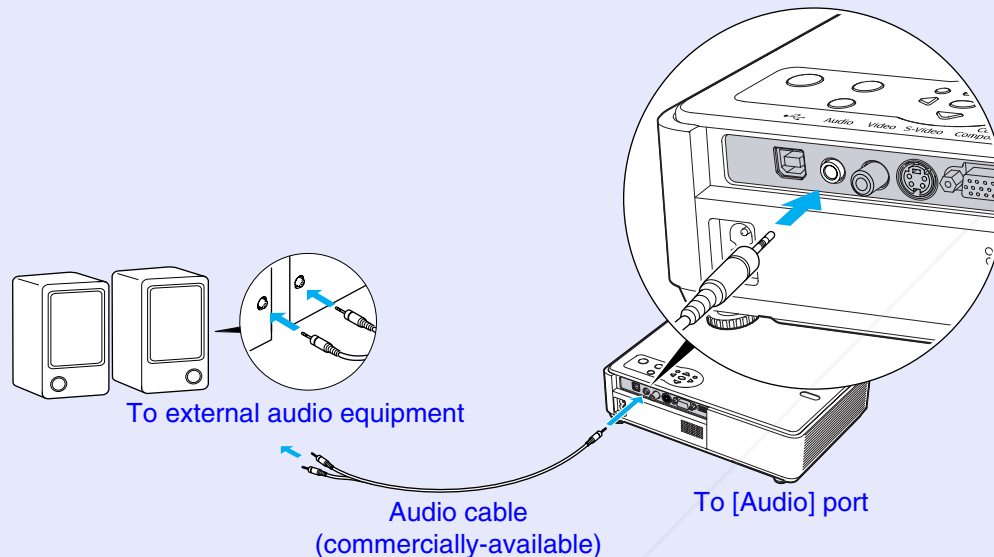

TIP

- When using an external speaker to output the sound, you cannot control the volume.
- When projecting images using the LAN connection function of EasyMP, audio signals cannot be output by the projector.



FixYourDLP.com

Sponsored by 

Merchant.com (800) 281-8860
THE TRUSTED SOURCE FOR PROJECTOR LAMPS AND ACCESSORIES



Connecting USB Devices (Digital Camera, Hard Disk Drive or Memory Devices) (EMP-745/737 only)

USB1.1-compatible digital cameras, hard disk drives and USB storage devices can be connected to the projector. Image files that are stored inside the digital camera and scenarios, images and movies that are stored inside USB storage devices can be played back by EasyMP CardPlayer.  "[Showing the Presentation \(Using the CardPlayer\)](#)" in the *EasyMP Operation Guide*

Connecting USB Devices

The following procedure describes how to connect USB devices, using a digital camera as an example.

Connect a digital camera to the projector using a USB cable provided with, or specified for use with your digital camera.



TIP

- Use a USB cable less than 3m in length. If the cable exceeds 3m, CardPlayer may not function correctly.
- Check that there is no wireless LAN card or memory card in the projector's card slot before connecting any USB device.

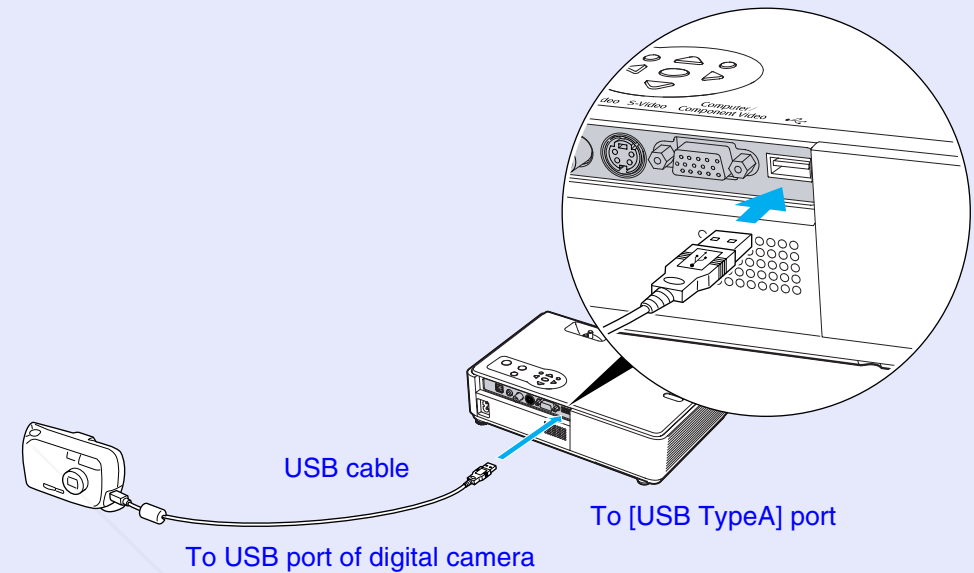

CAUTION

- If you use a USB hub, the connection may not operate correctly. Devices such as digital cameras and USB storage devices should be connected to the projector directly.
- When using a USB-compatible hard disc, make sure you connect the AC adaptor supplied with the hard disc.



FixYourDLP.com

Sponsored by 

Discount-Merchant.com (800) 281-8860

THE TRUSTED SOURCE FOR PROJECTOR LAMPS AND ACCESSORIES



Disconnecting a USB Device from the Projector

After projection has finished, disconnect the USB device from the projector by following the procedure below.

PROCEDURE

- 1 Position the cursor with the "EJECT" button on the CardPlayer screen and press the [Enter] button on the remote control to close CardPlayer. ➡ "Showing the Presentation (Using the CardPlayer)" in the *EasyMP Operation Guide*

CAUTION

Make sure you shut down CardPlayer first before disconnecting a USB cable or a USB storage device from the projector. If you do not shut down CardPlayer before disconnecting the USB device, CardPlayer may no longer operate correctly.

- 2 Disconnect the USB cable or USB storage device from the projector's [USB TypeA] port.

CAUTION

When a USB-compatible hard disk drive is connected, disconnect the hard disk drive or turn the power for the hard disk drive off before turning the power for the projector off. If this is not done, it may cause problems with the projector.



Preventing theft (Password Protect)

When the Password Protect function is activated, people who do not know the password cannot use the projector to project images when the power is turned on. Furthermore, the user's logo that is displayed on the background of the screen cannot be changed. This is to deter theft.

When Password Protect is enabled

■ When "Power ON Protect" is enabled (ON)

When the power is turned on for the first time after the projector's power cable is connected to the electrical outlet, or when Direct Power On is carried out, the following password entry screen will be displayed.

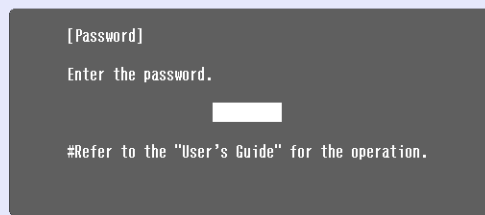

[0-9]:Enter

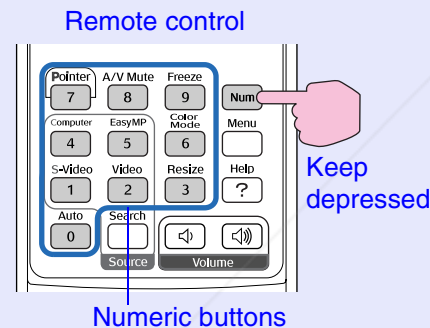

While holding down the [Num] button, press the numeric keypad buttons to enter the password. If the password is entered correctly, projection will start.

If you leave the power cable connected to the electrical outlet and turn the projector's power on when it is in standby mode, projection will start without the password entry screen appearing. The password entry screen will only be displayed when the power is turned on for the first time after the power cable has been disconnected and then reconnected. If Direct Power On is set to "ON" and you are using a circuit breaker or similar to centrally control the power, the password entry screen will be displayed the first time the projector is turned on after the power supply is restored.



TIP

• ***If an incorrect password is entered three times in succession, the message "The projector's operation will be locked." will be displayed for approximately five minutes, and then the projector will switch to standby mode. If this happens, disconnect the power plug from the electrical outlet and then reinsert it and turn the projector's power back on. A window requesting you to enter the password will be displayed.***

If you forget the password, make a note of the "Request Code: xxxxx" number that appears in the Password screen and contact the nearest address provided in the "International Warranty Conditions" section of the Safety Instructions/World-Wide Warranty Terms booklet.

• ***If you repeat the above operations ten times resulting in an incorrect password being entered thirty times, the following message will be displayed and the projector will not accept password entries any more.***

"The projector's operation will be locked. Contact the nearest address provided in the "International Warranty Conditions" section of the Safety Instructions/World Wide Warranty Terms booklet."



Preventing theft (Password Protect)

If the "Timer" Setting is for One Hour or More

The password entry screen will not be displayed at all when the power is turned on until the length of time that has been set has elapsed. When the set length of time has elapsed, the password entry screen will be displayed each time the power is turned on. The length of time referred to here is the total illumination time for the projector's lamp from the point when the projector's menu is closed.

If "Timer" is set to "0", the password entry screen will be displayed each time the power plug is disconnected and reinserted from the electrical outlet. If the projector is powered on when it is in standby mode, the password entry screen will not be displayed.

When "User's Logo Protect" is enabled (ON)

If an attempt is made to carry out any of the following user logo operations, a message is displayed and the setting cannot be changed. To change the setting, set "User's Logo Protect" to "OFF" first. [p.33](#)

- Capturing a user's logo
- When the "Extended" - "Display" - "Background Color" menu setting is changed from "Logo" to "Black" or "Blue", or changed from "Black" or "Blue" to "Logo".
- When the "Extended" - "Display" - "Startup Screen" menu setting ("ON" or "OFF") is changed.

Setting Password Protect

Use the following procedure to set Password Protect.

PROCEDURE

1

Hold down the [Freeze] button for approximately 5 seconds.

The "Password Protect" menu will be displayed. This can also be displayed by pressing the [Menu] button while holding down the [▷] button continuously for about 5 seconds.

Remote control

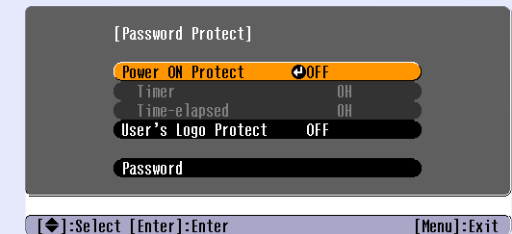
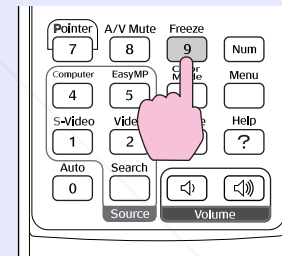

TIP

- *If Password Protect has already been enabled, the Password screen will be displayed.*
- *If the password has been entered correctly, the "Password Protect" menu will be displayed.*
- *"When Password Protect is enabled" [p.31](#)*
- *If Password Protect is set to "ON", attach the accessory Password Protect sticker to your preferred position on the projector as a theft-prevention measure.*





Preventing theft (Password Protect)

2 Turn "Power ON Protect" on.

- (1) Select "Power ON Protect", and then press the [Enter] button.
- (2) Select "ON", and then press the [Enter] button.
- (3) Press the [Esc] button.

3 "Timer" setting allows you to specify the time interval for password prompt.

If you don't use this setting, proceed to step 4.

- (1) Select "Timer" and then press the [Enter] button.
- (2) While holding down the [Num] button, use the numeric keypad buttons to enter the setting time within the range of 0 to 9999 hours and then press the [Enter] button.
If you make a mistake entering the time, press the [Esc] button and re-enter the time.
When you have finished using the "Password Protect" menu, the countdown for the elapsed time will start.

4 Turn "User's Logo Protect" on.

- (1) Select "User's Logo Protect", and then press the [Enter] button.
- (2) Select "ON", and then press the [Enter] button.
- (3) Press the [Esc] button.

5 Enter the password.

- (1) To set a password, select "Password" and then press the [Enter] button.
- (2) The message "Change the password?" will be displayed, so select "Yes" and then press the [Enter] button.
The default setting for the password is "0000", but you should change this to your own desired password.
If you select "No", the screen shown at step 1 will be displayed again.
- (3) While holding down the [Num] button, use the numeric keypad buttons to enter a 4-digit number. The number entered will be displayed as "* * * *".
Once four digits have been entered, the confirmation screen will be displayed.
- (4) Re-enter the password.
The message "The new password is stored." will be displayed.
If you enter the password incorrectly, a message will be displayed prompting you to re-enter the password.

6 Once the setting is complete, press the [Menu] button.



TIP

- *When the set time has elapsed and the password is entered, projection will start and the "Timer-elapsed" counter will be reset.*
- *Make a note of the password so that you do not forget it and keep it in a safe place.*
- *If you lose the remote control, you will not be able to enter the password. Keep the remote control in a safe place at all times.*



Basic Operations

This chapter describes basic operations such as turning the projector on and off and adjusting the projected images.

Turning the Projector On.....	35	Adjusting the Image Quality.....	44
• Connecting the Power Cable	35	• Adjusting Computer Images and RGB Video Images	44
• Turning the Power On and Projecting Images	36	• Automatic Setup	44
Turning the Projector Off	38	• Adjusting the Tracking	45
Adjusting the Screen Image	40	• Adjusting the Sync	46
• Adjusting the Image Size (Zoom Function)	40	• Selecting the Projection Quality	
• Focusing the Screen Image	40	(Colour Mode Selection)	47
• Adjusting the Image Angle and Automatic Keystone		Adjusting the Volume.....	48
Correction Function.....	41		
• Manually Correcting Keystone Distortion.....	43		



Turning the Projector On

Turn the power on to start projecting images.



CAUTION

Make sure you to read the separate Safety Instructions/World-Wide Warranty Terms before projecting images.

Connecting the Power Cable



TIP

When the "Extended" - "Operation" - "Direct Power ON" menu item is set to "ON", a confirmation buzzer sounds and the projector's power turns on as soon as the power plug is inserted into the electrical outlet, and projection will start. [p.65](#)

The power for the equipment that is connected to the projector should be turned on beforehand.

PROCEDURE

1 Check that the power is turned off for the projector and all components connected to the projector.

2 Connect the computer or other video source to the projector. [p.20](#), [p.21](#)

FixYourDLP.com
Sponsored by

3 Remove the lens cover. Hold the lens cover by the knob in the middle of the cover and remove it.

4

Connect the accessory power cable to the projector.

Check that the power cable connector is facing the same way as the power inlet on the projector, and then insert the power cable connector securely into the projector.

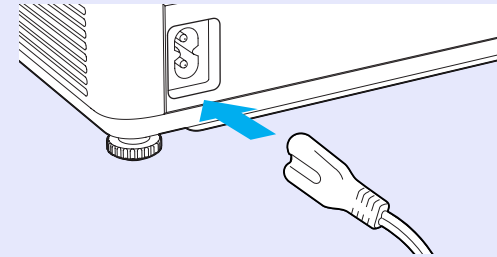

5

Connect the other end of the power cable to an earthed electrical outlet.

The Power indicator will light orange.

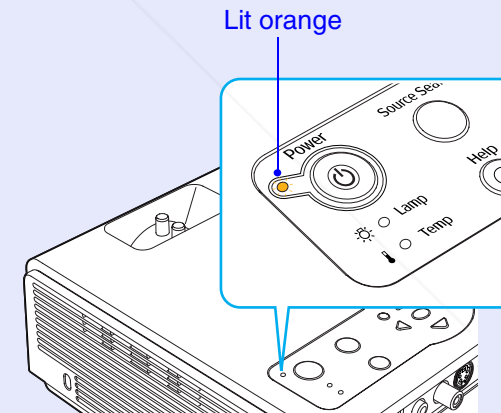

Discount-Merchant.com (800) 281-8860

THE TRUSTED SOURCE FOR PROJECTOR LAMPS AND ACCESSORIES



Turning the Projector On

Turning the Power On and Projecting Images



TIP

The Password Protect setting may cause the password entry screen to be displayed each time the power is turned on. If this happens, enter the password. [p.31](#)

PROCEDURE

- 1 Check that the Power indicator has stopped flashing and is lit orange.

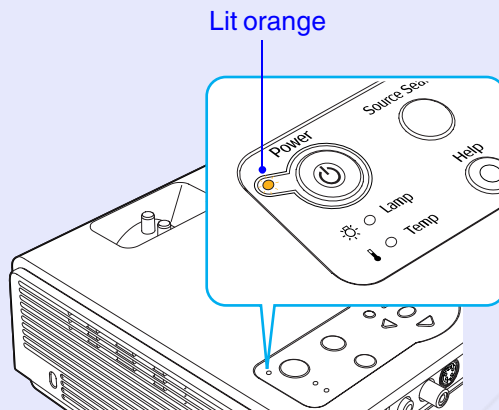

- 2 Turn the power on for all equipment connected to the projector.

For a video source, press the [Play] button at the video source to start playback if necessary.

3

- 3 Press the [Power] button on either the projector's control panel or the remote control to turn the projector's power on.

A beep will sound to indicate that the projector is starting up. The Power indicator starts to flash green as the projector warms up, and an image begins to appear.

Changes from flashing to lit green

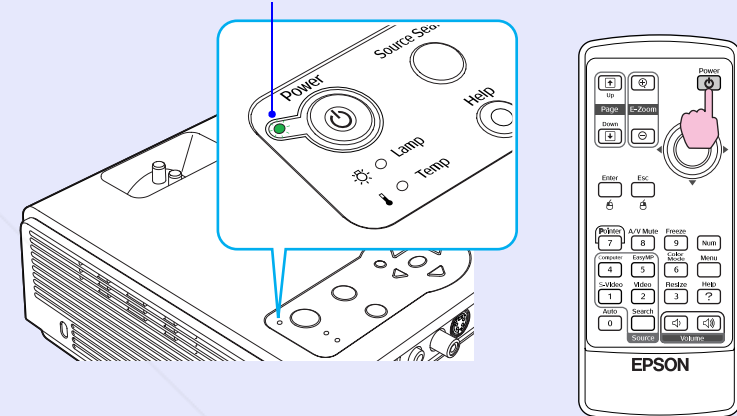

Remote control



TIP

If the Power indicator is flashing green, operation of the [Power] buttons is disabled.



FixYourDLP.com

Sponsored by

Discount-Merchant.com (800) 281-8860

THE TRUSTED SOURCE FOR PROJECTOR LAMPS AND ACCESSORIES





Turning the Projector On

- 4** If more than one external device is connected to the projector, use the remote control or projector control panel buttons to select the image source to be projected while referring to the following table. The input source can also be searched for and projected automatically each time the [Source Search] button is pressed.

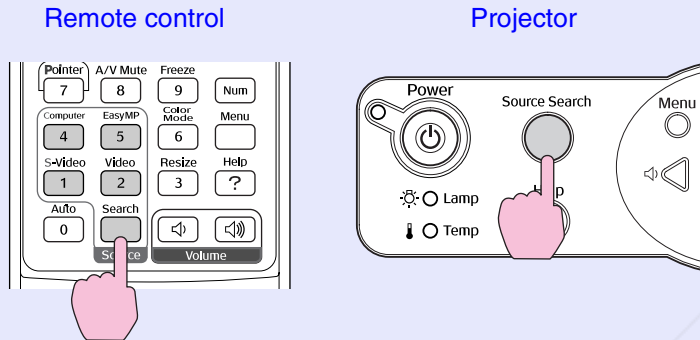

Source	Remote control button selected	Display at top-right of screen
Computer/ Component Video	Computer	Computer (Auto) ^{*1} Computer ^{*1} Component Video ^{*1}
S-Video	S-Video	S-Video
Video	Video	Video
EasyMP ^{*2}	EasyMP	EasyMP

*1 Displays the selected source as the "Computer Input" - "Signal" in the configuration menu.

*2 Only changes when using the Discount-Merchant.com [P-745/737.com](http://www.P-745/737.com) [EasyMP Operation Guide](#) and the [EasyMP Network Setup Guide](#) for details on using EasyMP.



TIP

- If only one signal source has been connected, the signals from that source will be projected without the need to press any of the buttons on the remote control or the projector's control panel.
- If using an EMP-745/737, EasyMP is detected as a source by pressing the [Source Search] button only when the CardPlayer is running with an inserted memory card or connected USB equipment, or when a LAN card is inserted. When EasyMP is not displayed by the [Source Search] button, press the [EasyMP] button on the remote control to switch the projected image to EasyMP.
- If the "No Signal." message does not disappear, check the connections again.
- If a laptop computer or a computer with an LCD screen has been connected to the projector, the images may not be projected straight away. After starting projection, check that the computer has been set up to output signals externally. The following table shows examples of how to toggle output settings. For details, refer to the section of the documentation provided with your computer under a heading such as "External output", "Connecting an external monitor" or similar.

NEC	Panasonic	Toshiba	IBM	Sony	Fujitsu	Macintosh
[Fn]+[F3]	[Fn]+[F3]	[Fn]+[F5]	[Fn]+[F7]	[Fn]+[F7]	[Fn]+[F10]	Set mirror setting or display detection.

- If the same still picture is projected for a long period of time, the projected image may become burned into the screen. You should avoid leaving the same image displayed for long periods.

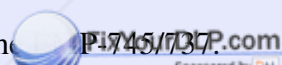

Discount-Merchant.com (800) 281-8860

THE TRUSTED SOURCE FOR PROJECTOR LAMPS AND ACCESSORIES





Turning the Projector Off

Follow the procedure below to turn the projector's power off.

PROCEDURE

- 1 Turn the power off for the signal sources that are connected to the projector.

Check that the power for all connected components has been turned off.

- 2 Press the [Power] button.

Remote control

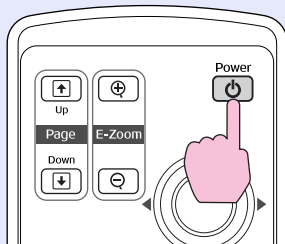

Projector

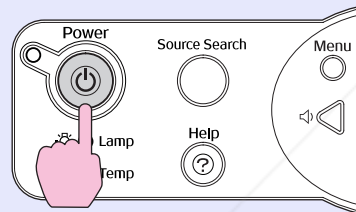

The following confirmation message will appear.

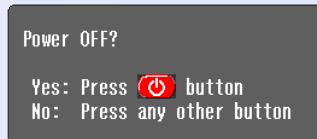

If you do not want to turn the power off, press any button except the [Power], [Page down], [Page up] and [Num] button.

If you do not press any button, the message will disappear automatically after seven seconds. (The power will not turn off at this time.)



CAUTION

If the message "The projector is over heating. Make sure nothing is blocking the air vent, and clean or replace the air filter." appears on the screen, press the [Enter] button on either the projector's control panel or on the remote control to turn the power off. "Cleaning the Air Filters and Air Intake Vent". [p.99](#)

- 3 Press the [Power] button once more.

The lamp will switch off. The Power indicator will flash orange and [cool-down](#) will start.

The cool-down period lasts for about 20 seconds.

When the cool-down is complete, a "pip-pip" confirmation buzzer will sound, and the Power indicator will change to light orange.

Stops flashing and lights orange

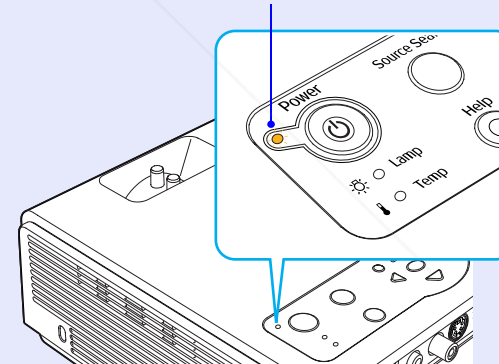

**TIP**

- If the Power indicator is flashing orange, operation of the [Power] buttons is disabled. Wait until the indicator lights continuously.
- If "Standby Mode" in the configuration menu is set to "Network ON", fans will continue operating. This is normal and does not indicate a problem. (EMP-745/737 only)

4

If the projector is not being used, it is recommended that you unplug the power cable from the electrical outlet.

**CAUTION**

Do not disconnect the power cable from the outlet while the Power indicator is still flashing orange, otherwise it may result in errors in projector operation and reduce the lamp unit operating life.

5**Attach the lens cover.**

Attach the lens cover to the lens when not using the projector, in order to prevent the lens from getting dusty or dirty.

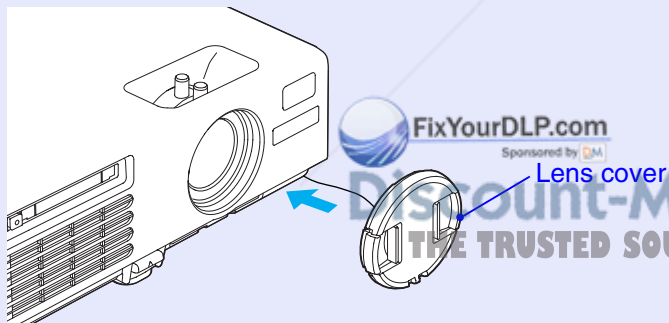

FixYourDLP.com
Sponsored by DM
Discount-Merchant.com (800) 281-8860
THE TRUSTED SOURCE FOR PROJECTOR LAMPS AND ACCESSORIES





Adjusting the Screen Image

These functions correct and adjust the projected images so that optimum images can be obtained.

Adjusting the Image Size (Zoom Function)

The size of the projected image is basically determined by the distance from the projector to the screen. [p.16](#)

The following procedures explain how to adjust the screen image once the projector itself has been set up.



TIP

The E-Zoom function lets you enlarge parts of the image. [p.52](#)

PROCEDURE

Adjust by turning the zoom ring.

The image can be enlarged in this way to 1.2 times the normal size.

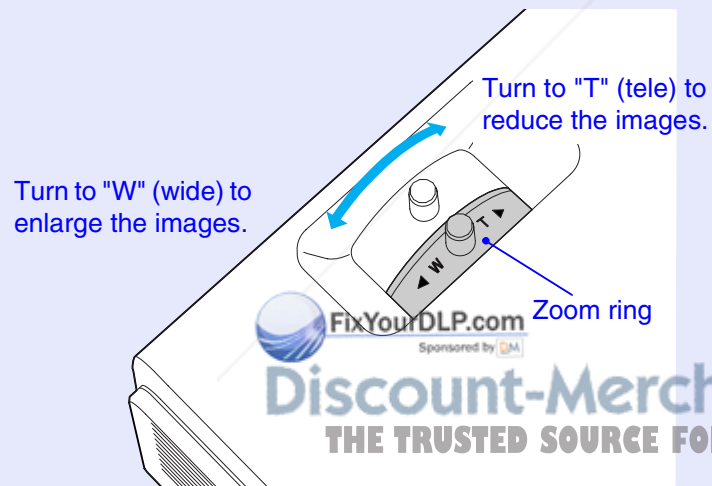

If you would like to enlarge the image further, move the projector further away from the screen. [p.16](#)

Focusing the Screen Image

PROCEDURE

Turn the focus ring to adjust the image focus.

If keystone correction or Sharpness settings have been made, it may not be possible to adjust the focus correctly.

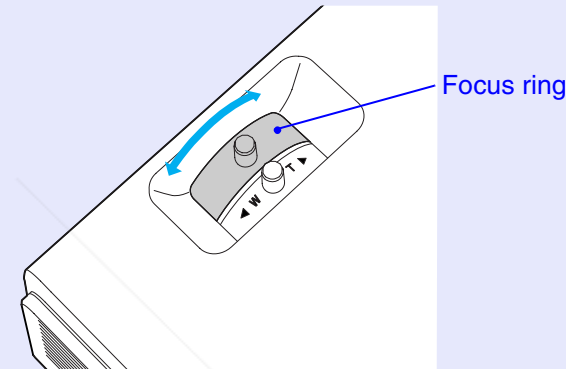

TIP

- *If the surface of the lens is dirty or misted over as a result of condensation, it may not be possible to adjust the focus correctly. If this happens, clean or de-mist the lens. [p.82, p.99](#)*
- *If the projector is positioned outside the normal projecting range of 100–1210 cm (3.2–39.7 ft.), it may not be possible to obtain the correct focus. If you have trouble obtaining the correct focus, check the projection distance.*



Adjusting the Image Angle and Automatic Keystone Correction Function

The projector should be set up so that it is as perpendicular to the screen as possible.

Seen from the side

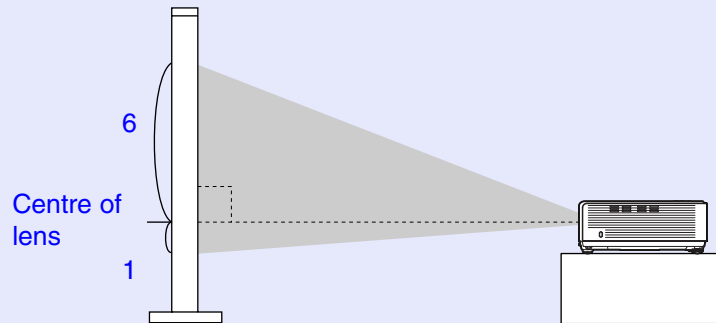

Seen from above

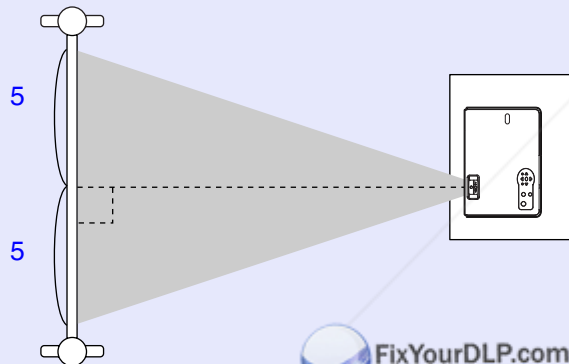

If you can not set up the projector so that it is at right angle to the screen surface, you can tilt the projector up. By extending or retracting the front adjustable foot, you can adjust the projection angle upward to a maximum 12°.



CAUTION

Do not tilt the projector at more than the maximum angle. Doing so may cause the projector to fall down or fall off a desk and may result in injury.





Adjusting the Screen Image

PROCEDURE

While pulling the foot adjust lever at the front of the projector, lift up the front of the projector to extend the front adjustable foot.

Extend the front adjustable foot until the desired angle is obtained, and then release the foot adjust lever.

To retract the front adjustable foot, gently push down on the projector while pulling the foot adjust lever.

Foot adjust lever (Front)

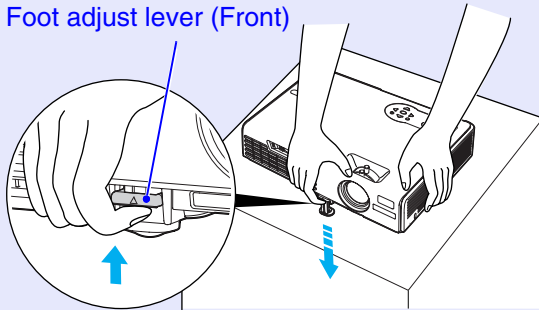

TIP

When the projector is tilting horizontally, turn the left rear adjustable foot until the projection is level. When the projector is tilted horizontally, the correction may not be carried out correctly. p.42

Rear adjustable foot

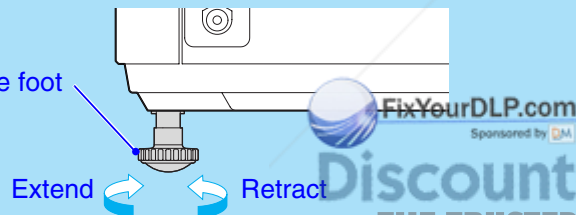

FixYourDLP.com
Sponsored by DM

Discount-Merchant.com (800) 991-9800
THE TRUSTED SOURCE FOR PROJECTOR LAMPS AND ACCESSORIES

If you tilt the projector up, keystone distortion will occur in the projected screen. However, the projector is equipped with an automatic keystone correction function that can automatically correct this keystone distortion on the screen. Automatic keystone correction is carried out approximately one second after the projector is tilted vertically while the power is on.

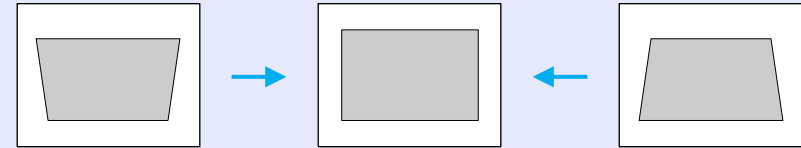

Keystone distortion can be corrected automatically as long as the vertical angle of tilt is within a range of approximately 30°*.

- * • This value applies when the zoom ring is turned to the maximum "T" setting. If the zoom ring is turned to the "W" setting, the available angle of tilt for automatic adjustment will be less.
- If the angle of tilt is large, it will become more difficult to adjust the focus correctly. In order to obtain better picture quality, set the projector up so that the angle of tilt is small.



TIP

- Automatic keystone correction is not carried out when the "Projection" command in the "Extended" menu is set to "Front".
- If you would like to make further fine adjustments after automatic keystone correction has been carried out, press the [▽] and [△] buttons on the projector's control panel. p.43
- When keystone correction is carried out, the projected image will become smaller.
- If the text part of the image is blurred after keystone correction is carried out, decrease the sharpness setting. p.56, p.58
- If automatic keystone correction is not required, set "Auto Keystone" in the "Setting" menu to "OFF". p.62





Adjusting the Screen Image

Manually Correcting Keystone Distortion

The projector is provided with an automatic keystone correction function which detects the vertical angle of the projector and carries out keystone correction automatically. If you would like to make further fine adjustments to the results of automatic keystone correction, press the [∇] and [∇] buttons.

PROCEDURE

If the bottom of the image is elongated

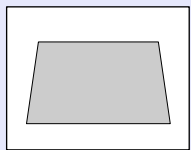

Projector

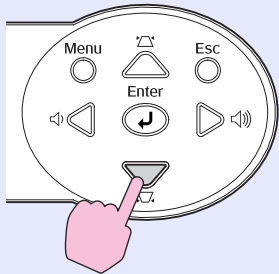

If the top of the image is elongated

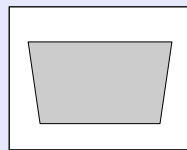

Projector

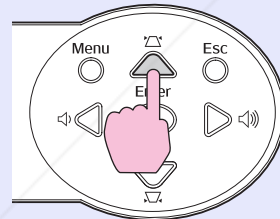

TIP

- When keystone correction is carried out, the projected image will become smaller.
- If the text part of the image is blurred after keystone correction is carried out, decrease the sharpness setting. [p.56](#), [p.58](#)
- Keystone correction can also be carried out using the configuration menu. [p.62](#)
- If the value displayed in the gauge on the screen stops changing when keystone correction is being carried out, it indicates that the limit for keystone correction has been reached. Check that the projector has not been set up at an angle which exceeds the proper limit.



FixYourDLP.com

Sponsored by DM

Discount-Merchant.com (800) 281-8860

THE TRUSTED SOURCE FOR PROJECTOR LAMPS AND ACCESSORIES



Adjusting the Image Quality

The quality of the screen images can be adjusted as follows.

Adjusting Computer Images and RGB Video Images

Automatic Setup

Automatic setup detects analogue RGB signals coming from a connected computer, and automatically adjusts these signals so that the optimum images can be obtained.

Automatic setup involves adjustment of the following three items: [Tracking](#), Position and [Sync \(synchronisation\)](#).



TIP

- If "Auto Setup" in the "Signal" menu is set to "OFF" (the default setting for this item is "ON"), automatic setup is not carried out. In this case, press the [Auto] button on the remote control or the [Enter] button on the projector's control panel to make the adjustment while computer or RGB video images are being projected.

Remote control

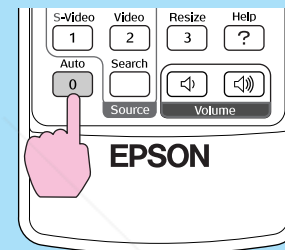

Projector

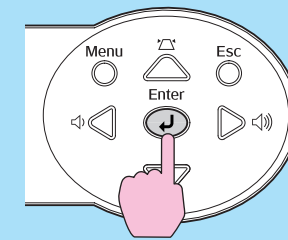

When you press the [Auto] button, the screen will turn to solid black colour for a moment and then return to a previous image. The auto adjustment is still in progress even after returning to the previous image. Wait about 3 seconds before pressing any other buttons.

- If you press the [Auto] button while the E-Zoom function or Freeze function is activating, the auto adjustment will start after canceling those functions.
- Sometimes the signals may not be adjusted correctly depending on the type of computer or RGB video signals being output. In such cases, use the configuration menu commands to adjust the tracking and sync settings manually. [p.45](#), [p.46](#)

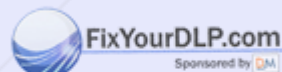

Discount-Merchant.com (800) 281-8860

THE TRUSTED SOURCE FOR PROJECTOR LAMPS AND ACCESSORIES



Adjusting the Image Quality

Adjusting the Tracking

If vertical stripes appear in the projected computer or RGB video images, and this cannot be fixed using automatic setup, you will need to adjust the [Tracking](#) manually using the following procedure.

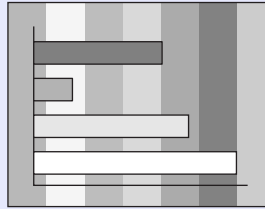

PROCEDURE

- 1 Press the [Menu] button on the remote control or the projector's control panel, and then select "Tracking" from the "Signal" configuration menu.

For details on this operation, refer to "Using the Configuration Menus". [p.69](#)

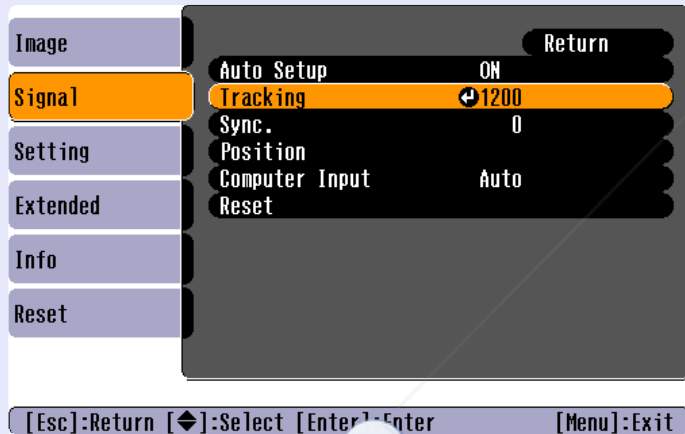

- 2 Tilt the [⊙] button on the remote control or press the [◀] and [▶] buttons on the projector's control panel to adjust the tracking value until the vertical stripes disappear from the images.

The tracking value increases or decreases each time a button is pressed.

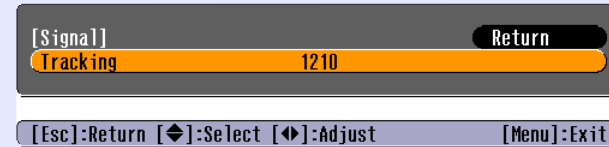

- 3 After making the adjustment, press the [Menu] button to exit the configuration menu.



TIP

The image will flash when continuous tracking adjustment is carried out, but this is normal.



FixYourDLP.com

Sponsored by DM

Discount-Merchant.com (800) 281-8860

THE TRUSTED SOURCE FOR PROJECTOR LAMPS AND ACCESSORIES



Adjusting the Image Quality

Adjusting the Sync

If flickering, fuzziness or interference appear in computer or RGB video images, and this cannot be fixed using automatic setup, you will need to adjust the [Sync \(synchronisation\)](#) manually using the following procedure.

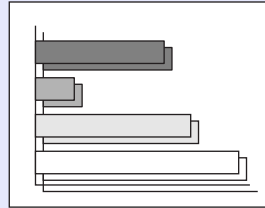

PROCEDURE

- 1 Press the [Menu] button on the remote control or the projector's control panel, and then select "Sync." from the "Signal" configuration menu.

For details on this operation, refer to "Using the Configuration Menus". p.69

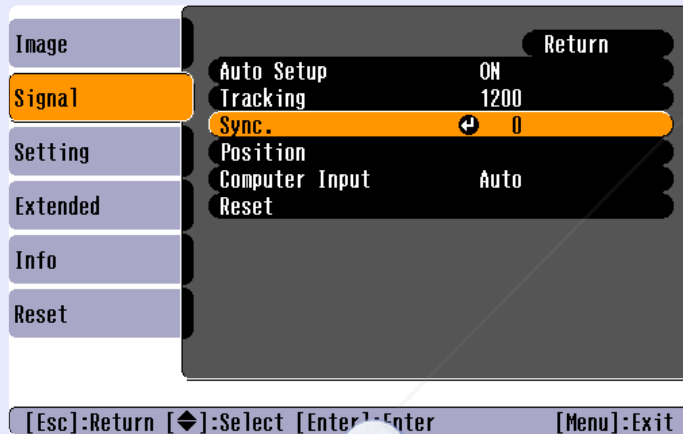

- 2 Tilt the [⊙] button on the remote control or press the [◀] and [▶] buttons on the projector's control panel to adjust the synchronisation value until the flickering, fuzziness or interference disappears from the images.

The sync value increases or decreases each time a button is pressed.

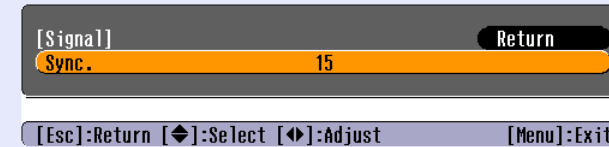

- 3 After making the adjustment, press the [Menu] button to exit the configuration menu.



TIP

- If you adjust the sync without adjusting the [tracking](#) first, it will not be possible to get the best adjustment results. Incorrect tracking adjustment may not be noticeable with some types of picture. However, pictures with lots of lines and shading will tend to show incorrect tracking adjustments more clearly, so be sure to check the tracking adjustment first.
- Flickering and fuzziness may also occur when the brightness, [contrast](#), sharpness and keystone correction settings are adjusted.



FixYourDLP.com

Sponsored by DLP

Discount-Merchant.com (800) 281-8860

THE TRUSTED SOURCE FOR PROJECTOR LAMPS AND ACCESSORIES



Adjusting the Image Quality

Selecting the Projection Quality (Colour Mode Selection)

The following six preset colour modes are available for use depending on the characteristics of the images that are being projected. You can easily obtain the optimum image quality simply by selecting the colour mode that corresponds to the projected images. The brightness of the images will vary depending on which colour mode is selected.

Mode	Application
Dynamic	Brightness is emphasised, so that images are fresher and have greater modulation than in Presentation mode.
Presentation	Brightness is emphasised to produce images that are ideal for presentations.
Theatre	Movie images are optimised using natural tints.
Living Room	Brightness is emphasised to produce images that are ideal for projecting TV images, etc. in bright rooms.
sRGB	Images conform to the sRGB colour standard. If the connected source has a sRGB mode, set both the projector and the connected signal source to sRGB.
Blackboard	Images with natural tints can be obtained when projecting onto a blackboard (green).

The default setting for the colour mode is as follows.
 When computer or RGB video images are being input: "Presentation"
 When other images are being input: "Dynamic"

PROCEDURE

The colour mode changes as follows each time the [Color Mode] button is pressed.

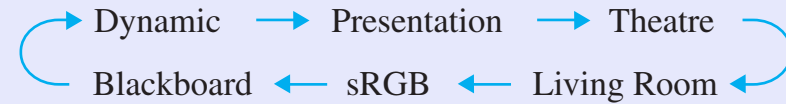

Remote control

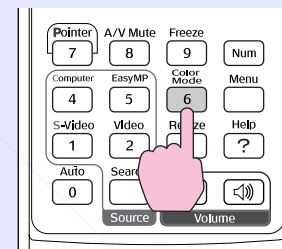

The current setting appears in the top-right corner of the screen each time the colour mode is changed.

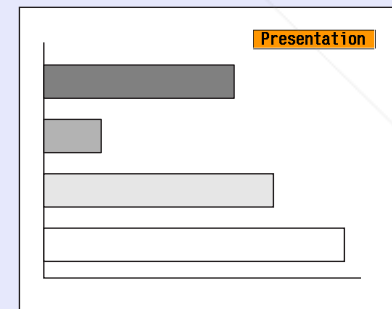

TIP

The colour mode can also be set using the "Color Mode" command in the "Image" menu. [p.56](#), [p.58](#)



Adjusting the Volume

The volume of the projector's built-in speaker can be adjusted as follows.

PROCEDURE

Press the [Volume] buttons on the remote control or the [◀] and [▶] buttons on the projector's control panel to adjust the volume.

When the button is pressed to the [▶] side, the volume increases, and when it is pressed to the [◀] side, the volume decreases. The volume gauge appears on the screen when the volume is being adjusted.

Remote control

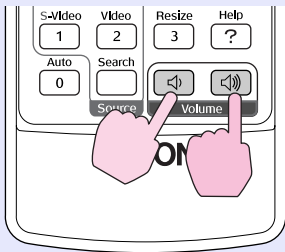

Projector

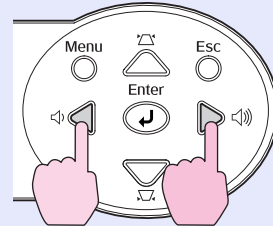

TIP

- If the value displayed in the gauge on the screen stops changing when the volume is being adjusted, it indicates that the limit for volume adjustment has been reached.
- Volume adjustments are stored separately for each input source.
- The volume can also be adjusted using the configuration menu.

➔ p.62



Discount-Merchant.com
Sponsored by DM

Discount-Merchant.com (800) 281-8860
THE TRUSTED SOURCE FOR PROJECTOR LAMPS AND ACCESSORIES

Advanced Operations

This chapter describes functions for enhancing the projection of images, and how to use the configuration menus.

Functions for Enhancing Projection	50	Using the Configuration Menu Functions.....	55
• A/V Mute.....	50	• List of Functions	56
• Freeze	51	• "Image" Menu	56
• Wide-screen Projection of Images from Video Equipment (Changing the Aspect Ratio)	51	• "Signal" Menu	60
• E-Zoom.....	52	• "Setting" Menu	62
• Pointer function.....	53	• "Extended" Menu	64
• Operation Button Lock Function	54	• "Info" Menu.....	67
		• "Reset" Menu	68
		• Using the Configuration Menus	69



Functions for Enhancing Projection

This section describes the various useful functions that can be used to enhance presentations.

A/V Mute

This function momentarily pauses the image and sound. For example, it can be used when you do not want to show details of operations such as selecting different files while computer images are being projected. However, if you use this function when projecting moving images, the images and sound will still continue to be played back by the source, and you cannot return to the point where the mute function was activated.

PROCEDURE

Press the [A/V Mute] button.

The image and sound will then be paused.

Projection starts again when the [A/V Mute] button on the remote control is pressed.

You can also continue normal projection by pressing the [Esc] button.

Remote control

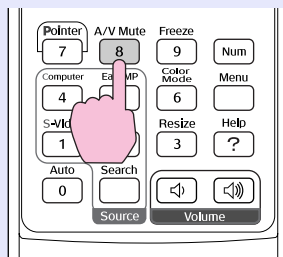

You can use the "Extended" - "Display" - "Background Color" menu setting to select the screen status when video and audio are paused from the following three options. p.64

Solid black



Solid blue



Default setting

User's logo



TIP

- The default user's logo is the EPSON logo. To change the user's logo, you need to record your own logo. p.105
- When the A/V Mute function is being used, the "Brightness Control" setting in the "Setting" menu will automatically change to "Low". When the A/V mute function is cancelled, the "Brightness Control" setting will return to the original setting.



Discount-Merchant.com (800) 281-8860
THE TRUSTED SOURCE FOR PROJECTOR LAMPS AND ACCESSORIES



Functions for Enhancing Projection

Freeze

This function pauses only the projected images. The sound keeps playing without pausing.

The image source will still be playing back the images even while projection is paused, and so it will not be possible to resume projection from the point where it was paused.

PROCEDURE

Press the [Freeze] button.

The images will then be paused.

To cancel the pause, press the [Freeze] button once more. You can also cancel it by pressing the [Esc] button.

Remote control

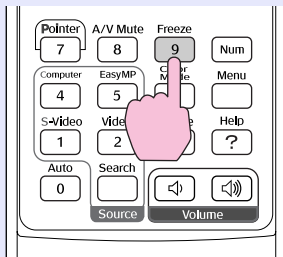

Wide-screen Projection of Images from Video Equipment (Changing the Aspect Ratio)

This function changes the [aspect ratio](#) of images from 4:3 to 16:9 when [component video](#) images, [S-Video](#) or [composite video](#) images are being projected.

Images which have been recorded in digital video or onto DVDs can be viewed in 16:9 wide-screen format.

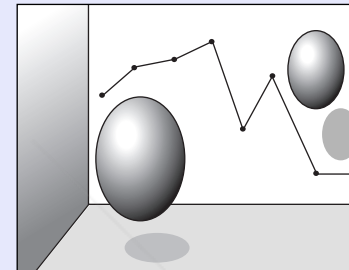

When images in [Squeeze mode](#) are projected at 4:3

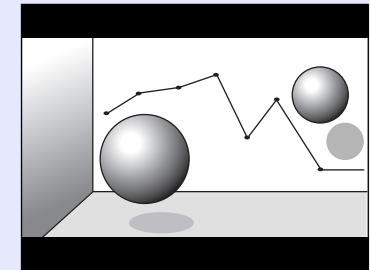

When images in [squeeze mode](#) are projected at 16:9

PROCEDURE

The aspect ratio changes each time the [Resize] button is pressed.

Remote control

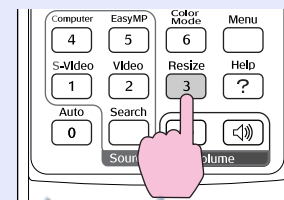

TIP

- Pressing the [Freeze] button also clears configuration menu displays and help messages.
- The freeze function still works while the E-Zoom function is being used.



FixYourDLP.com

Discount-Merchant.com (800) 281-8860

THE TRUSTED SOURCE FOR PROJECTOR LAMPS AND ACCESSORIES



TIP

You can also make this setting using the "Resize" command in the "Signal" menu.



Functions for Enhancing Projection

E-Zoom

This function lets you enlarge and reduce a part of projected images such as graphs and tables.

PROCEDURE

1 Press the [E-Zoom ⊕] button.

A cursor (cross) indicating the centre point for the area to be enlarged will appear on the screen.

Remote control

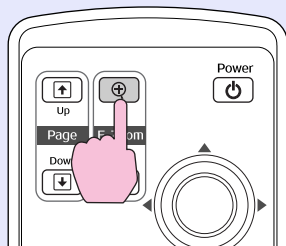

2 Move the cross to the area of the image that is to be enlarged or reduced.

Tilt the [⊙] button on the remote control to move the cross.

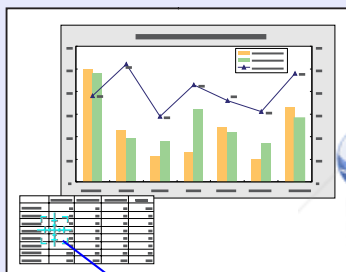

Cross

3

When the [⊕] button is pressed, the image is enlarged with the cross at its centre. When the [⊖] button is pressed, the enlarged image is then reduced.

The enlargement ratio will appear on the screen. You can scroll the screen by tilting the [⊙] button.



Shows enlargement ratio

To cancel the E-Zoom, press the [Esc] button.



TIP

The selected area can be enlarged to between 1–4 times, in 25 steps of $\times 0.125$.

FixYourDLP.com
Sponsored by DM

Discount-Merchant.com (800) 281-8860
THE TRUSTED SOURCE FOR PROJECTOR LAMPS AND ACCESSORIES



Functions for Enhancing Projection

Pointer function

This function lets you use the remote control to move a pointer icon around on the images being projected.

This function can be used to emphasise parts of an image that you want to draw attention to.

Use the remote control to carry out pointer function operations.

TIP

You can use the "Pointer Shape" command in the "Setting" menu to change the shape of the pointer to one of three different shapes.

☞ p.62

PROCEDURE

1 Press the [Pointer] button.

The pointer icon will appear in the middle of the projection area.

Remote control

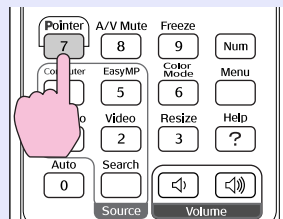

2 Tilt the [Pointer] button to move the pointer icon.

To cancel the Effect function, press the [Pointer] button. The pointer icon will then disappear from the screen.



Pointer icon



FixYourDLP.com

Sponsored by DM

Discount-Merchant.com (800) 281-8860

THE TRUSTED SOURCE FOR PROJECTOR LAMPS AND ACCESSORIES



Operation Button Lock Function

This function locks the buttons on the projector's control panel. This function is useful at times such as during show events so that only projection is carried out deactivating all buttons operation, or in places such as schools to limit the range of buttons that can be operated.

PROCEDURE

1 Press the [Menu] button on either the remote control or the projector's control panel, and then select "Setting" - "Operation Lock" from the configuration menu.

2 Set to "ON".
If set to "ON", none of the buttons on the control panel except the [Power] button can be operated.

3 When the confirmation message is displayed, select "Yes".
The control panel buttons will be locked in accordance with the selected setting.



TIP

There are two methods to cancel the projector's control panel lock.

- Using remote control, change the "Setting" - "Operation Lock" in the configuration menu to "OFF".*
- Hold down the projector's [Enter] button continuously for about 7 seconds, a message will be displayed and the lock will be cancelled.*



projector.com

Sponsored by

Discount-Merchant.com (800) 281-8860

THE TRUSTED SOURCE FOR PROJECTOR LAMPS AND ACCESSORIES



Using the Configuration Menu Functions

The configuration menus can be used to carry out a variety of settings and adjustments.

The menus have a hierarchical structure, with a main menu that is divided into sub-menus, which are further divided into other sub-menus.

Refer to "Using the Configuration Menus"  p.69 for details on using the menus.

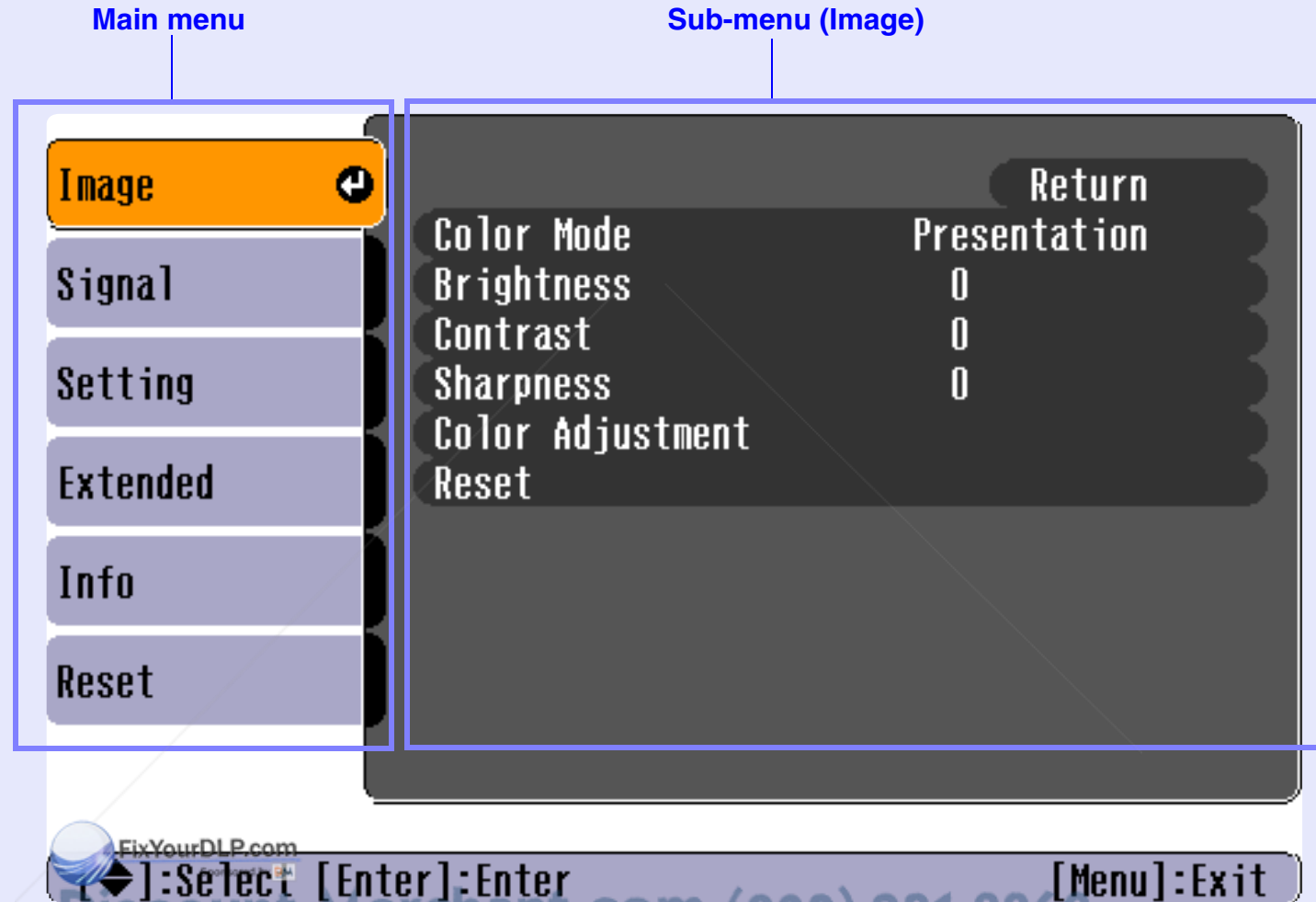

Discount-Merchant.com (800) 281-8860

THE TRUSTED SOURCE FOR PROJECTOR LAMPS AND ACCESSORIES



List of Functions

"Image" Menu

- None of the settings can be adjusted if no signals are being input.
- The commands displayed in the "Image" menu change depending on the input signal that is being projected. Menu commands that do not apply to the current input signal cannot be adjusted.

Computer/RGB video/EasyMP (EMP-745/737 only)



Sub-menu	Function	Default
Color Mode	<p>Corrects the vividness of the image colour. The settings can be saved separately for each type of source (computer or video source). You can select from six different quality settings depending on the surroundings.</p> <ul style="list-style-type: none"> •Dynamic : Brightness is emphasised, so that images are fresher and have greater modulation than in Presentation mode. •Presentation : Brightness is emphasised to produce images that are ideal for presentations. •Theatre : Images are optimised using natural tints. It emphasises colour gradations (differences between light and dark) when projecting images that are very dark or very light and bright, to make such images easier to see. •Living Room: Brightness is emphasised to produce images that are ideal for projecting TV images, etc. in bright rooms. •sRGB : Images conform to the sRGB standard. If set to "sRGB", the Abs. Color Temp. for the "Color Adjustment" command in the "Image" menu will be set to 6500K. •Blackboard : Images with natural tints can be obtained when projecting onto a blackboard (green). 	Presentation
Brightness	Adjusts the image brightness.	Median value (0)
Contrast	Adjusts the difference between light and shade in the images.	Median value (0)
Sharpness	Adjusts the image sharpness.	Median value (0)





Sub-menu	Function	Default
Color Adjustment	<p>Adjusts the absolute colour temperature and the intensity of the red, green and blue components for each input source.</p> <p>Abs. Color Temp. ▶: Lets you adjust bright colours within a range from reddish tinges to bluish tinges. If the colour temperature is lower, colours appear reddish and color tones appear softer. If the colour temperature is higher, colours appear bluish and colour tones appear sharper.</p> <p>RGB: Adjust the intensity of each color; R(red), G(green) and B(blue).</p> <p>(This item cannot be selected if "sRGB ▶" has been selected as the "Color Mode" setting in the "Image" menu.)</p>	<p>Abs. Color Temp.: 7500K</p> <p>Red: Median value (0) Green: Median value (0) Blue: Median value (0)</p>
Reset	<p>Resets all adjustment values for the "Image" menu functions to their default settings.</p> <ul style="list-style-type: none"> • Press the [Enter] button on the remote control or on the projector's control panel. • To return all settings such as the "Image" and "Signal" menu settings to their default values, select "Reset All" from the "Reset" menu. p.68 	-





Using the Configuration Menu Functions

[Component video](#) / [Composite video](#) / [S-Video](#)

Sub-menu	Function	Default
Color Mode	<p>Corrects the vividness of the image colour. The settings can be saved separately for each type of source (computer or video source). You can select from six different quality settings depending on the surroundings.</p> <ul style="list-style-type: none"> •Dynamic : Brightness is emphasised, so that images are fresher and have greater modulation than in Presentation mode. •Presentation : Brightness is emphasised to produce images that are ideal for presentations. •Theatre : Images are optimised using natural tints. It emphasises colour gradations (differences between light and dark) when projecting images that are very dark or very light and bright, to make such images easier to see. •Living Room: Brightness is emphasised to produce images that are ideal for projecting TV images, etc. in bright rooms. •sRGB : Images conform to the sRGB standard. If set to "sRGB", the Abs. Color Temp. for the "Color Adjustment" command in the "Image" menu will be set to 6500K. •Blackboard : Images with natural tints can be obtained when projecting onto a blackboard (green). 	Dynamic
Brightness	Adjusts the image brightness.	Median value (0)
Contrast	Adjusts the difference between light and shade in the images.	Median value (0)
Color Intensity	Adjusts the colour intensity for the images.	Median value (0)
Tint	(Adjustment is only possible when component video or NTSC signals are being input.) Adjust the image tint.	Median value (0)
Sharpness	Adjusts the image sharpness.	Median value (0)





Sub-menu	Function	Default
Color Adjustment	<p>Adjusts the absolute colour temperature and the intensity of the red, green and blue components for each input source.</p> <p>Abs. Color Temp. ▶▶: Lets you adjust bright colours within a range from reddish tinges to bluish tinges. If the colour temperature is lower, colours appear reddish and color tones appear softer. If the colour temperature is higher, colours appear bluish and colour tones appear sharper.</p> <p>RGB: Adjust the intensity of each color; R(red), G(green) and B(blue).</p> <p>(This item cannot be selected if "sRGB ▶▶" has been selected as the "Color Mode" setting in the "Image" menu.)</p>	<p>Abs. Color Temp.: 6500K</p> <p>Red: Median value (0) Green: Median value (0) Blue: Median value (0)</p>
Reset	<p>Resets all adjustment values for the "Image" menu functions to their default settings.</p> <ul style="list-style-type: none"> • Press the [Enter] button on the remote control or on the projector's control panel. • To return all settings such as the "Image" and "Signal" menu settings to their default values, select "Reset All" from the "Reset" menu. p.68 	-





Using the Configuration Menu Functions

"Signal" Menu

- The "[Tracking](#)", "[Sync.](#)", "Position" and "Resize" settings can not be adjusted if no signals are being input.
- The items displayed in the "Signal" menu change depending on the input signal that is being projected. Menu commands that do not apply to the current input signal cannot be adjusted.
- If using the EMP-745/737, you cannot change any of the "Signal" configuration menu settings while EasyMP is running.

Computer/RGB video

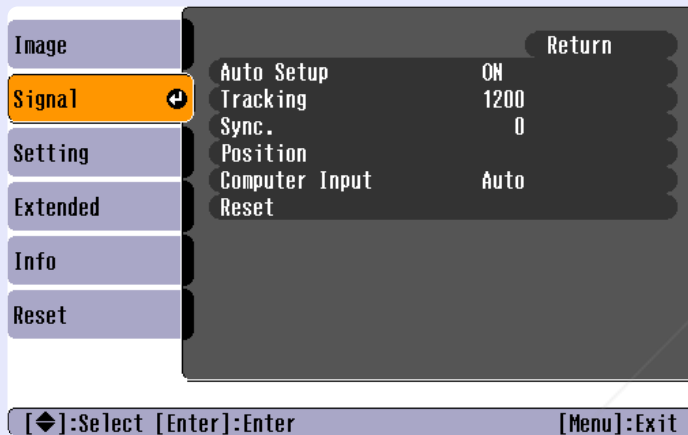

Sub-menu	Function	Default
Auto Setup	Selects whether the automatic adjustment function for automatically optimising images when the input source is changed is turned "ON" or "OFF".	ON
Tracking	Adjusts computer images when vertical stripes appear in the images.	Depends on connection
Sync.	Adjusts computer images when flickering, fuzziness or interference appear in the images. <ul style="list-style-type: none"> •Flickering and fuzziness may also appear when the brightness, contrast, sharpness or keystone settings are adjusted. •You can obtain the best results if you adjust the tracking first and then adjust the sync. 	Depends on connection
Position	Moves the image display position vertically and horizontally. <ul style="list-style-type: none"> •Press the [Enter] button on the remote control or on the projector's control panel and then make the adjustment using the display position adjustment screen that appears. 	Depends on connection
Computer Input	Selects the input signal in accordance with the equipment that is connected to the [Computer/Component Video] port. If set to "Auto" the input signal is set automatically in accordance with the connected equipment. If you select "Auto", and the colours appear unnatural, select "Computer".	Auto
Reset	Return the all settings in the "Signal" menu to their default except the "Computer Input" setting. <ul style="list-style-type: none"> •Press the [Enter] button on the remote control or on the projector's control panel. •To return all settings such as the "Image" and "Signal" menu settings to their default values, select "Reset All" from the "Reset" menu. p.68 	-

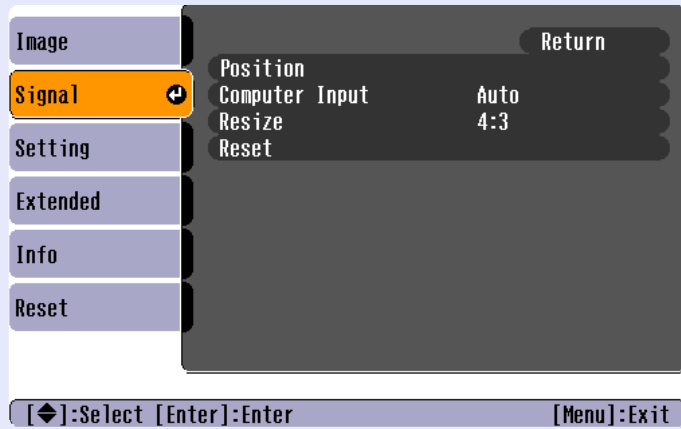
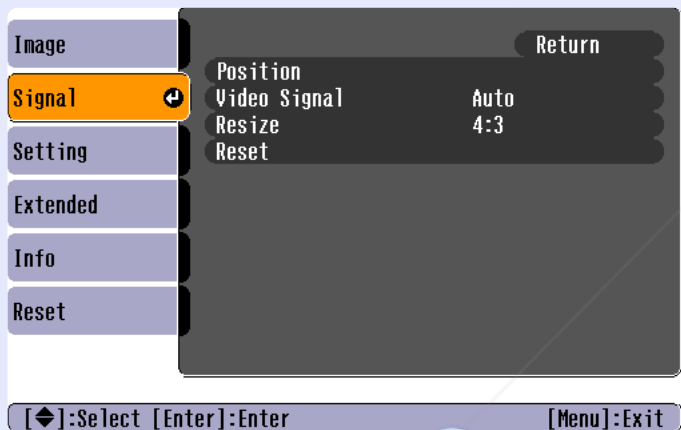

Using the Configuration Menu Functions

[Component video](#)[Composite video](#) / [S-Video](#)



Sub-menu	Function	Default
Position	Moves the image display position vertically and horizontally. •Press the [Enter] button on the remote control or on the projector's control panel and then make the adjustment using the display position adjustment screen that appears.	Depends on connection
Computer Input	(Adjustment is only possible when component video signals are being input.) Selects the input signal in accordance with the equipment that is connected to the [Computer/Component Video] port. If set to "Auto" the input signal is set automatically in accordance with the connected equipment. If you select "Auto", and the colours appear unnatural, select "Component Video".	Auto
Video Signal	(Adjustment is only possible when composite video/S-Video signals are being input.) Sets the video signal format. •Press the [Enter] button on the remote control or on the projector's control panel and then make the selection from the video signal format selection menu that appears. •When set to "Auto", the video signal format is set automatically.	Auto
Resize	Sets the aspect ratio for projected images.	Depends on connection
Reset	Returns "Position" and "Resize" settings in the "Signal" menu to their default settings. •Press the [Enter] button on the remote control or on the projector's control panel. •To return all settings such as the "Image" and "Signal" menu settings to their default values, select "Reset All" from the "Reset" menu. p.68	-

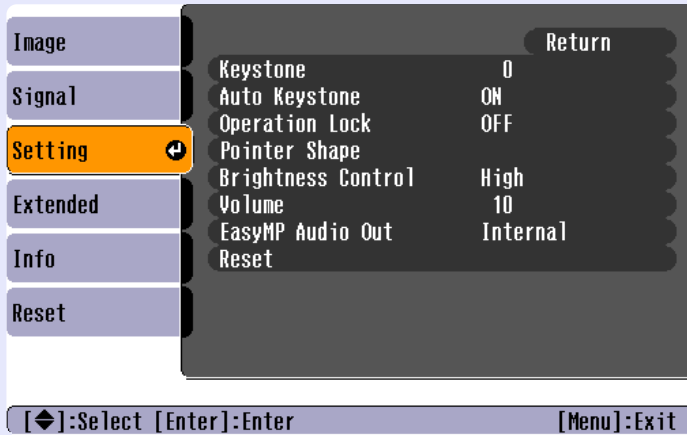

Using the Configuration Menu Functions

"Setting" Menu



Sub-menu	Function	Default
Keystone	<p>Corrects vertical keystone distortion in images.</p> <ul style="list-style-type: none"> •When keystone correction is carried out, the projected image will become smaller. •If the text part of the image is blurred after keystone correction is carried out, decrease the sharpness setting. 	Median value (0)
Auto Keystone	<p>Sets the function for automatically detecting the projector angle and correcting keystone "ON" or "OFF" when the projector is tilted vertically.</p> <p>This function is only enabled when the "Projection" command in the "Extended" menu is set to "Front". If it is set to something other than "Front", this menu cannot be selected.</p>	ON
Operation Lock	<p>When set to "ON", the operation of all buttons on the projector's control panel except for the [Power] button will be disabled.</p> <ul style="list-style-type: none"> •When "Operation Lock" is set to "ON", the operation lock function can be cancelled by holding down the [Enter] button on the projector's control panel for approximately 7 seconds. •If you change the setting, the new setting will take effect after exiting the configuration menu. 	OFF
Pointer Shape	<p>The shape of the pointer icon that appears when you press the [Pointer] button on the remote control can be selected from the following three shapes.</p> <p>Pointer 1:  Pointer 2:  Pointer 3: </p>	Pointer 1
Brightness Control	<p>This lets you set the lamp brightness to one of two settings. Select "Low" if the images being projected are too bright such as when projecting images in a dark room or onto a small screen.</p> <p>When "Low" is selected, the brightness of the images is reduced, the amount of electricity consumed and noise produced during projection are reduced and the lamp's operating life is extended.</p>	Low (Varies depending on country of purchase)
Volume	Adjusts the volume.	Median value (10)





Sub-menu	Function	Default
EasyMP Audio Out	<p>(EMP-745/737 only. Can be used only when projecting using EasyMP.)</p> <p>Select the way to output sound when projecting using EasyMP.</p> <p>Select the "External" to output the sound from external speakers with built-in amplifiers. Select the "Internal" to output the sound from the projector's built-in speaker.</p> <p>☛ p.28</p> <p>*The audio output to an external speaker is possible only when the audio data of scenarios (.wav) or that of MPEG files are played back by Card Player.</p>	Internal
Reset	<p>Resets all adjustment values for the "Setting" menu functions to their default settings.</p> <ul style="list-style-type: none"> • Press the [Enter] button on the remote control or on the projector's control panel. • To return all settings such as the "Image" and "Signal" menu settings to their default values, select "Reset All" from the "Reset" menu. ☛ p.68 	-

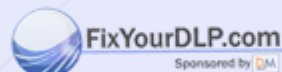

Discount-Merchant.com (800) 281-8860
THE TRUSTED SOURCE FOR PROJECTOR LAMPS AND ACCESSORIES





Using the Configuration Menu Functions

"Extended" Menu

- The "User's Logo" setting can not be adjusted if no signals are being input.

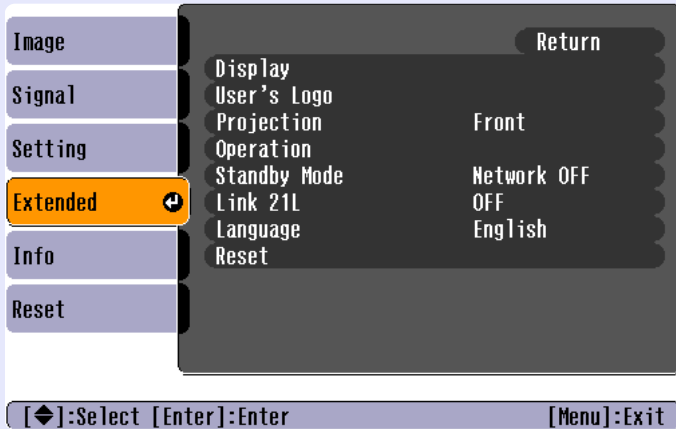

Sub-menu	Function	Default
Display	<p>This lets you make settings related to the projector's display.</p> <p>Message: Sets whether display of the following messages is turned "ON" or "OFF".</p> <ul style="list-style-type: none"> Signal name when the video signal is switched Colour mode name when the colour mode is switched When no image signals are being input When an incompatible signal is input When the air filter needs replacing <p>Background Color: Sets the screen status when the [A/V Mute] button on the remote control is being pressed or when no image signals are being input to "Black", "Blue" or "Logo".</p> <ul style="list-style-type: none"> To change the user's logo, you need to record your own logo. p.105 If the "User's Logo Protect" function of Password Protect has been set to "ON", the "Logo" setting cannot be changed from "Logo" to "Black" or "Blue", or from "Black" or "Blue" to "Logo". Cancel the Password Protect function before changing these settings. p.33 <p>Startup Screen: Sets whether the startup screen is displayed or not. To change the user's logo, you need to record your own user's logo. p.105 This cannot be changed from enabled ("ON") to disabled ("OFF") if the "User's Logo Protect" function of Password Protect has been set to "ON". Cancel the Password Protect function before changing the setting. p.33</p>	<p>Message: ON</p> <p>Background Color: Blue</p> <p>Startup Screen: ON</p>
User's Logo	<p>Records a user's logo. p.105</p> <ul style="list-style-type: none"> Press the [Enter] button on the remote control or on the projector's control panel and then follow the instructions that appear on the screen. A user's logo cannot be recorded if the "User's Logo Protect" function of Password Protect has been set to "ON". Cancel the Password Protect function before recording a user's logo. p.33 	EPSON logo





Sub-menu	Function	Default
Projection	<p>Sets the projection position for the projector.</p> <ul style="list-style-type: none"> • Front : Select when the projector is in front of the screen. • Front/Ceiling : Select when the projector is in front of the screen and suspended from the ceiling. • Rear : Select when the projector is behind the screen. • Rear/Ceiling : Select when the projector is behind the screen and suspended from the ceiling. 	Front
Operation	<p>This lets you make settings related to projector operation.</p> <p>Direct Power ON: When the projector's power cable is connected, projection starts without needing to press the [Power] button. * When "Direct Power ON" is set to "ON", turn the power off by pressing the [Power] button, then wait for the cool-down period to finish and then disconnect the power cable. If the power cable is left connected to the wall outlet when "Direct Power ON" is set to "ON", the projector will turn on if a power outage occurs and then the power is restored.</p> <p>Sleep Mode: Sets the energy saving operation when no signal is being input.</p> <ul style="list-style-type: none"> • When set to "ON", projection stops automatically and then after the cool-down period is finished, the projector changes to sleep mode if no operations are carried out for 30 minutes while the "No Signal." message is being displayed. (The Power indicator lights orange.) • Projection starts again when the [Power] button is pressed. 	<p>Direct Power ON: OFF</p> <p>Sleep Mode: OFF</p>

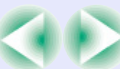



Using the Configuration Menu Functions

Sub-menu	Function	Default
Standby Mode	(EMP-745/737 only) Set to "Network ON" to use network monitoring and control functions and the standby monitor out function while the projector is in standby mode. To enable the new settings, turn the projector's power off and wait until the cool-down is finished. * When set to "Network ON", the Power indicator will flash orange and then remain orange after disconnecting the power plug and reinserting it into the electrical outlet.	Network OFF
Link21L	Sets whether the EMP Link21L utility software is being used or not. To enable the EMP Link21L, turn the projector's power off and wait until the cool-down is finished.	OFF
Language	Sets the language for message displays. • Press the [Enter] button on the remote control or on the projector's control panel and then make the selection.	English (Varies depending on country of purchase)
Reset	Returns "Display" and "Operation" settings in the "Extended" menu to their default settings. However, if "Background Color" has been set to "Logo" or if "Startup Screen" has been set to "OFF", the settings will not be returned to their defaults if "User's Logo Protect" is set to "ON". p.33 • Press the [Enter] button on the remote control or on the projector's control panel. • To return all settings such as the "Image" and "Signal" menu settings to their default values, select "Reset All" from the "Reset" menu. p.68	-



Discount-Merchant.com (800) 281-8860
THE TRUSTED SOURCE FOR PROJECTOR LAMPS AND ACCESSORIES





Using the Configuration Menu Functions

"Info" Menu

- The "Info" menu shows the setting details for the current image source.
- The "Lamp Hours" item appears as 0H for 0–10 hours, and after that, it appears in units of 1 hour.

Computer/RGB Video/[Component video](#)

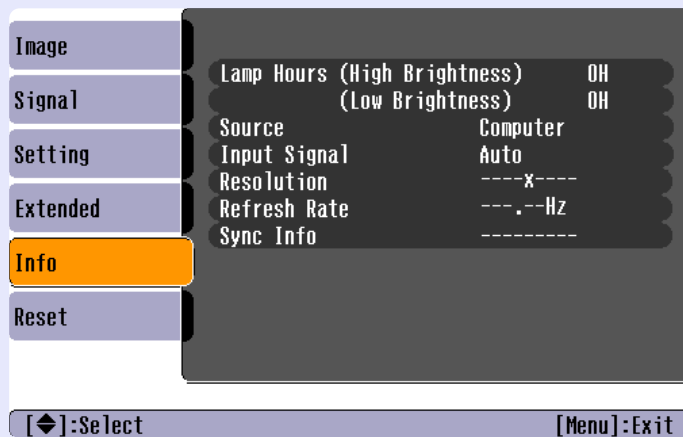

[Composite video](#) / [S-Video](#)



Sub-menu	Function	Default
Lamp Hours	Displays the cumulative lamp operating time for both "High Brightness" and "Low Brightness". •When the lamp warning period is reached, the display characters appear in red.	0H
Source	Displays the input source which is currently being projected.	
Input Signal	Displays the input signal settings. (Does not appear when the input source is Composite Video, S-Video or EasyMP.)	
Resolution	Displays the input resolution. (Does not appear when the input source is Composite Video, S-Video or EasyMP.)	-
Video Signal	Shows the video signal format. (Does not appear when the input source is Computer, RGB video, Component Video or EasyMP.)	-
Refresh Rate	Displays the refresh rate. (Does not appear when the input source is Composite Video, S-Video or EasyMP.)	-
Sync. Info	Informations in this menu may be required in case that you ask for service to your dealer or the nearest address provided at "International Warranty Conditions" section of the <i>Safety Instructions/World Wide Warranty Terms</i> booklet. (Does not appear when the input source is Composite Video, S-Video or EasyMP.)	-



Using the Configuration Menu Functions

■ "Reset" Menu

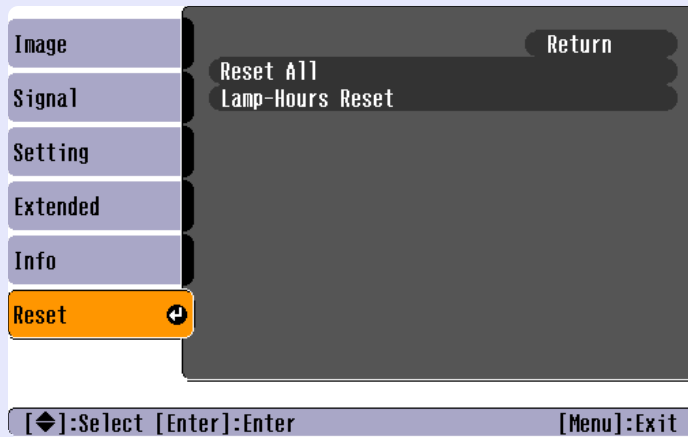

Sub-menu	Function	Default
Reset All	<p>Resets all items in all menus to their default settings.</p> <ul style="list-style-type: none"> • Press the [Enter] button on the remote control or on the projector's control panel. • To reset settings such as "Image" or "Signal", select "Reset" from the respective sub menus. • The "Computer Input", "Video Signal", "User's Logo", "Lamp Hours" and "Language" settings will not be reset to their defaults. However, if "Background Color" is set to "Logo" or "Startup Screen" is set to "OFF", these settings will not be returned to their defaults when "User's Logo Protect" is set to "ON". <p> p.33</p>	-
Lamp-Hours Reset	<p>Initialises the lamp operating time. When this command is selected, the cumulative lamp operating time is reset to the initial default value.</p>	-

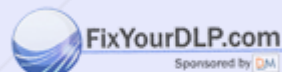

Discount-Merchant.com (800) 281-8860
 THE TRUSTED SOURCE FOR PROJECTOR LAMPS AND ACCESSORIES



Using the Configuration Menu Functions

Using the Configuration Menus

The configuration menus can be operated using either the remote control or the projector's control panel.

PROCEDURE

1 Press the [Menu] button.

The configuration menu appears.

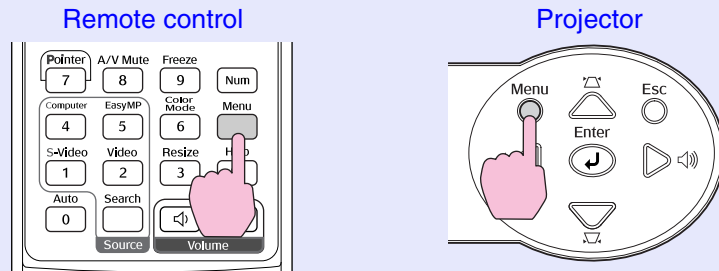

2 Select a menu item.

Tilt the [◀▶] button on the remote control up and down or press the [▲] and [▼] buttons on the projector's control panel to move to the item to be set.



3 Confirm the selection.

Press the [Enter] button to confirm the selection of a menu item.

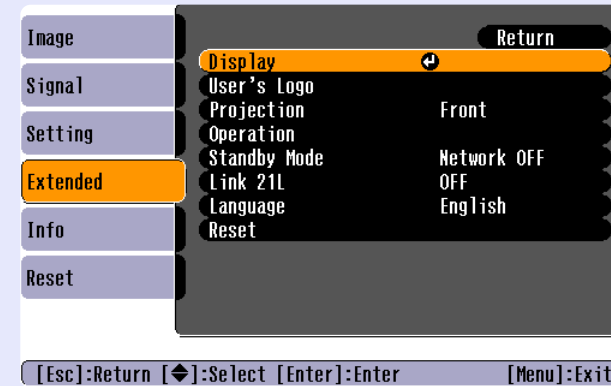

Discount-Merchant.com (800) 281-8860
THE TRUSTED SOURCE FOR PROJECTOR LAMPS AND ACCESSORIES





Using the Configuration Menu Functions

4 Select a sub-menu item.

Tilt the [\odot] button on the remote control up and down or press the [\triangle] and [∇] buttons on the projector's control panel to move to the sub-item to be set, and then press the [Enter] button.

The items that are displayed in the "Image" menu, "Signal" menu and "Info" menu vary depending on the input source that is being projected.

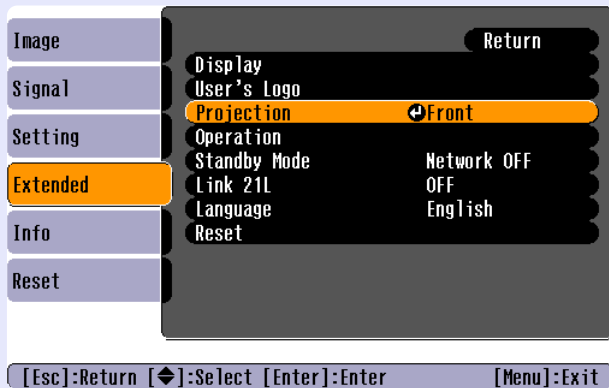

5 Change the setting.

Example 1

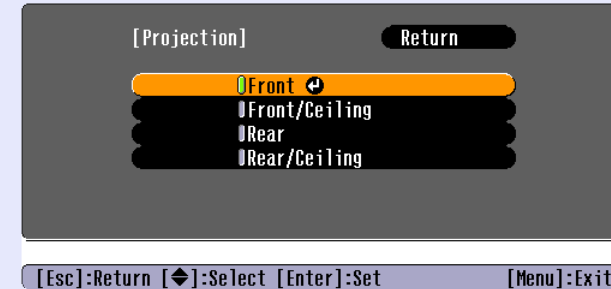

- (1) Tilt the [\odot] button on the remote control or press the [\triangle] and [∇] buttons on the projector's control panel to change the setting.

\odot : Current setting value

\circ : Currently-selected setting item

- (2) If you press the [Enter] button when at items with a \odot displayed, the setting screen for that item will be displayed.

After making the setting, press the [Enter] button to accept the setting. The \odot will change to green.

Example 2



Tilt the [\odot] button on the remote control to the left or right or press the [\triangleleft] and [\triangleright] buttons on the projector's control panel to change the setting.

Press the [Enter] button to accept the setting.





Using the Configuration Menu Functions

6**Close the menu.**

Press the [Menu] button.

**TIP**

Refer to "List of Functions" for details on the functions of each menu item.  [p.56](#)

**FixYourDLP.com**Sponsored by **Discount-Merchant.com (800) 281-8860****THE TRUSTED SOURCE FOR PROJECTOR LAMPS AND ACCESSORIES**

Troubleshooting

This chapter describes how to identify problems and what to do if a problem is found.

Using the Help.....	73
Problems Solving.....	75
• Reading the Indicators.....	75
• Power indicator lights red.....	75
• Lamp or Temp indicator flashes orange	76
• Power indicator lights green or orange/flashes green or orange	77
• When the Indicators Provide No Help	78
• Problems relating to images	80
• Problems when projection starts.....	86
• Other problems	87
• Problems Relating to Monitoring and Controlling Projectors Using a Network (EMP-745/737 only).....	88

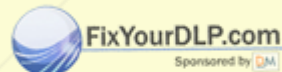

Discount-Merchant.com (800) 281-8860
THE TRUSTED SOURCE FOR PROJECTOR LAMPS AND ACCESSORIES



Using the Help

If a problem occurs with the projector, the Help function uses on-screen displays to assist you in solving the problem. It uses a series of menus in a question and answer format.

PROCEDURE

1 Press the [Help] button.

The help menu will be displayed.

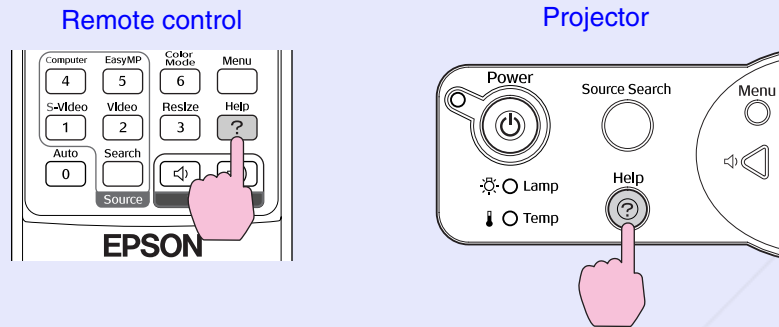

2 Select a menu item.

Tilt the [] button on the remote control or press the [] and [] buttons on the projector's control panel to select an item.

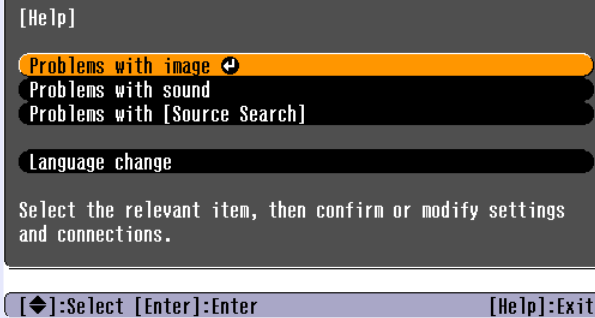
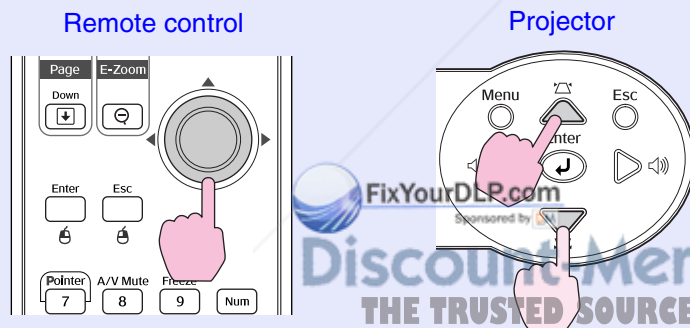

3 Confirm the selection.

Press the [Enter] button to confirm the selection of a menu item.

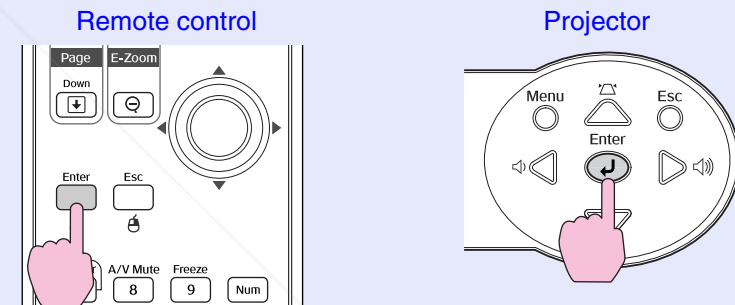



4 Repeat the operations in steps 2 and 3 to proceed through the menu to more detailed items.

The help menu is cleared when the [Help] button is pressed.

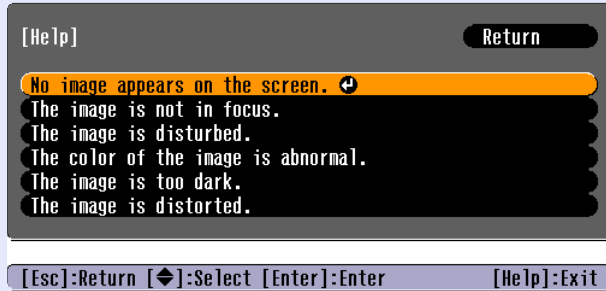

TIP

If the Help function does not provide a solution to the problem, refer to "Problem Solving"  p.75



FixYourDLP.com

Sponsored by 

Discount-Merchant.com (800) 281-8860

THE TRUSTED SOURCE FOR PROJECTOR LAMPS AND ACCESSORIES





Problems Solving

If you are having a problem with the projector, first check the projector's indicators and refer to "Reading the Indicators" below. If the indicators do not show clearly what the problem might be, refer to "When the Indicators Provide No Help". [p.78](#)

Reading the Indicators

The projector is provided with the following three indicators which indicate the operating status of the projector.

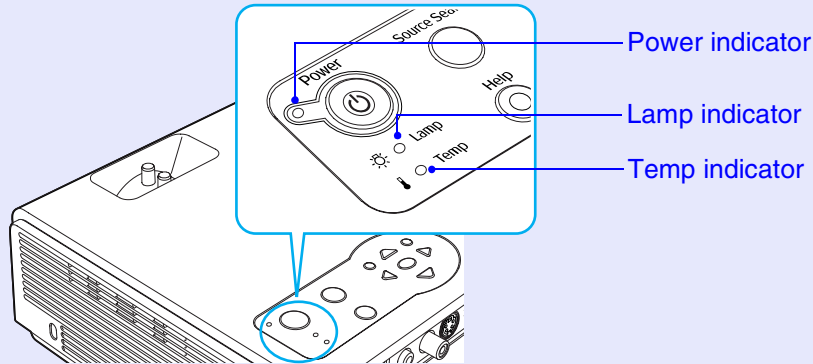

The following tables show what the indicators mean and how to remedy problems that they indicate.

If all indicators are switched off, check that the power cable is connected correctly and that power is being supplied normally.

■ Power indicator lights red **Abnormal**

● : lit ⚡ : flashing ○ : off

Status	Cause	Remedy or Status
⏻ ● Red ☀️ ⚡ Red 🌡️ ⚡ Red	Internal error	Stop using the projector, disconnect the power cable from the electrical outlet, and contact your dealer or the nearest address provided in the "International Warranty Conditions" section of the <i>Safety Instructions/World-Wide Warranty Terms</i> booklet.
⏻ ● Red ☀️ ○ 🌡️ ⚡ Red	Fan related error Sensor error	Stop using the projector, disconnect the power cable from the electrical outlet, and contact your dealer or the nearest address provided in the "International Warranty Conditions" section of the <i>Safety Instructions/World-Wide Warranty Terms</i> booklet.

www.YourDLP.com
 Sponsored by DM
Discount-Merchants.com (800) 281-8860
THE TRUSTED SOURCE FOR PROJECTOR LAMPS AND ACCESSORIES





● : lit ⚡ : flashing ○ : off

Status	Cause	Remedy or Status
⏻ ● Red ⚡ ○ 🌡 ● Red	Internal temperature error (overheating)	<p>The lamp will turn off automatically and projection will stop. Wait for about 5 minutes. After about 5 minutes the projector will switch to standby mode, so check the following two points. After checking, press the [Power] button to turn the power back on.</p> <ul style="list-style-type: none"> •Check that the air filter and air exhaust vent are clear, and that the projector is not positioned against a wall. 🖱 p.16 •If the air filters are blocked, clean or replace them. 🖱 p.99, p.104 <p>If this does not solve the problem and the projector continues to overheat or the indicators continue to show a problem when the power is turned on, stop using the projector, disconnect the power cable from the wall outlet, and contact your dealer or the nearest address provided in the "International Warranty Conditions" section of the <i>Safety Instructions/World-Wide Warranty Terms</i> booklet.</p>
⏻ ● Red ⚡ ⚡ Red 🌡 ○	Lamp timer failure/ Lamp out	<p>Take out the lamp and check if it is broken. 🖱 p.101</p> <p>If the lamp is not broken, put it back in and then turn the power on. If the lamp still does not turn on, replace it with a new lamp.</p> <p>If this does not solve the problem, stop using the projector and disconnect the power cable from the electrical outlet. Then contact your dealer or the nearest address provided in the "International Warranty Conditions" section of the <i>Safety Instructions/World-Wide Warranty Terms</i> booklet</p> <hr/> <p>If the lamp is broken replace it with a new lamp, or contact your local dealer for further advice. If replacing the lamp yourself, be careful to avoid pieces of broken glass. (Projection cannot be carried out until the lamp is replaced.)</p> <hr/> <p>Check that the lamp and the lamp cover are securely installed. If the lamp or lamp cover is not securely installed, the lamp will not switch on.</p>

■ Lamp or Temp indicator flashes orange **Warning**

● : lit ⚡ : flashing ○ : off

Status	Cause	Remedy or Status
⏻ ⚡ Red ⚡ ○ 🌡 ⚡ Orange	High-speed cooling in progress	<p>(This is not an abnormality, but if the temperature rises too high again, projection will stop automatically.)</p> <ul style="list-style-type: none"> •Check that the air filters and air exhaust vent are clear and that they are not up against a surface such as a wall. 🖱 p.16 •If the air filters are clogged, clean or replace them. 🖱 p.99, p.104

FixYourDLP.com
Sponsored by DM

Discount-Media.com (800) 281-8860

THE TRUSTED SOURCE FOR PROJECTOR LAMPS AND ACCESSORIES

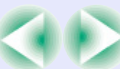



● : lit ⚡ : flashing ○ : off

Status	Cause	Remedy or Status
● ⚡ Orange ○	Lamp replacement notification	Replace the lamp with a new one. p.101 If you continue to use the lamp after it has passed the replacement period, the possibility that the lamp may break will increase. Replace the lamp with a new one as soon as possible. The Power indicator status will vary depending on the projector status at the time.

■ Power indicator lights green or orange/ flashes green or orange **Normal**

● : lit ⚡ : flashing ○ : off

Status	Cause	Remedy or Status
● Orange ○ ○	Standby condition	Projection starts again when the [Power] button is pressed. You can disconnect the power plug from the electrical outlet when the status light is in this condition.
● Green ○ ○	Warm-up in progress	Warm-up time is approximately 40 seconds. After warm-up is complete, the indicator stops flashing.
● Green ○ ○	Projection in progress	
⚡ Orange ○ ○	Cool-down in progress	Please wait. <ul style="list-style-type: none"> •The cool-down period lasts about 20 seconds. •The [Power] button will not operate if it is pressed while cool-down is in progress. When the cool-down period is finished and the confirmation buzzer has sounded and the indicator changes to light orange, repeat the operation.



TIP

- If the projector is not operating properly even though the indicators are all showing normal, refer to "When the Indicators Provide No Help" on the following page.
- If an indicator is showing a status which does not appear in the previous tables, contact your dealer or the nearest address provided in the "International Warranty Conditions" section of the Safety Instructions/World-Wide Warranty Terms booklet.



FixYourDLP.com

Sponsored by

Discount-Merchant.com (800) 281-8860
 THE TRUSTED SOURCE FOR PROJECTOR LAMPS AND ACCESSORIES





When the Indicators Provide No Help

If any of the following problems occur and the indicators do not offer a solution, refer to the pages given for each problem.

Problems relating to images

- No images appear p.80
Projection does not start, the projection area is completely black, the projection area is completely blue, etc.
- Can not switch projection to a video source by pressing the [Source Search] button p.80
- Projection stops automatically p.81
- The message "Not Supported." is displayed p.81
- The message "No Signal." is displayed p.82
- Images are fuzzy or out of focus p.82
- Interference or distortion appear in images p.83
Problems such as interference, distortion or black & white checked patterns appear.
- Image is truncated (large) or small p.84
Only part of the image is displayed.
- Image colours are not right p.85
The whole image appears purplish or greenish, images are black & white, colours appear dull, etc.
(Computer monitors and LCD screens have different colour reproduction performance, so that the colours projected by the projector and the colours appearing on the monitor may not necessarily match, but this is not a sign of a problem.)
- Images appear dark p.86

Problems when projection starts

- Power does not turn on p.86

Other problems



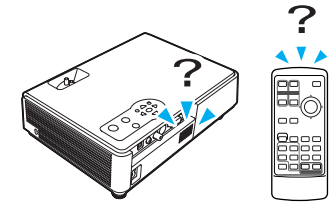











- No sound can be heard or the sound is faint p.87
- The remote control does not work p.87
- The projector's control panel does not work p.87
- The fans do not stop when power is turned off (EMP-745/737 only) p.88





Problems Relating to Networks and EasyMP

For EMP-745/737 only

- Mail notification messages are not being sent when a problem occurs with the projector  [p.88](#)
- The projector cannot be monitored and controlled using the EMP Monitor function  [p.89](#)
- An error message is displayed (error message when EMP Monitor is running)  [p.97](#)
- You cannot connect from another computer when images are being projected during a network connection  [p.89](#)
- EMP NS Connection starts, but a projector is not found  [p.90](#)
- Connection cannot be established in access point mode or wired LAN connection mode  [p.91](#)
- Connection cannot be made in ad hoc mode  [p.91](#)
- Network Screen images are not displayed, or the display is slow  [p.92](#)
- The PowerPoint slideshow does not work when using the Network Screen  [p.92](#)
- Keynote slideshows cannot be played back with Network Screen  [p.92](#)
- Network Screen cannot be used  [p.93](#)
- When running Microsoft Office applications using Network Screen, the screen does not change as required  [p.93](#)
- Files do not work correctly with EMP SlideMaker2  [p.93](#)
- An error message is displayed  [p.94–p.97](#)

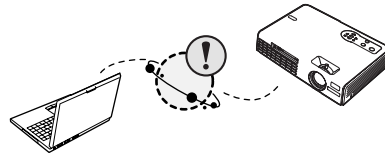



Problems Solving

■ Problems relating to images

■ No images appear

Check	Remedy
Was the [Power] button pressed?	Press the [Power] button to turn the power on.
Are both indicators switched off?	The power cable is not connected correctly or power is not being supplied normally. Connect the projector's power cable correctly. p.35 Check that your power supply socket is working.
Is A/V Mute mode active?	Press the [A/V Mute] button on the remote control to cancel the mute. p.50
Has "Message" been set to "OFF"?	If the "Message" command is set to "OFF", set it to "ON" so that messages can be displayed. When a message is displayed, refer to the item that it indicates. "Extended" - "Display" - "Message" p.64
Have the configuration menu settings been made correctly?	Reset all of the settings. "Reset" - "Reset All" p.68
Is the projected image completely black? Only when projecting computer images	Some input images, such as screen savers, may be completely black.
Are the image signal format settings correct? Only when projecting images from a video source	If a composite video or S-Video source is connected to the projector, use the "Video Signal" menu command to select the signal format. "Signal" - "Video Signal" p.61

■ Can not switch projection to a video source by pressing the [Source Search] button

Check	Remedy
Is the image signal output from the video equipment? Only when projecting images from a video source	Press the [Play] button of the video equipment. Or press one of the source buttons on the remote control ([Computer], [S-Video] or [Video] button) to switch to the desired source.

FixYourDLP.com
powered by DM

Discount-Merchant.com (800) 281-8860
THE TRUSTED SOURCE FOR PROJECTOR LAMPS AND ACCESSORIES



Problems Solving

■ Projection stops automatically

Check	Remedy
Is "Sleep Mode" set to "ON"?	When the "Sleep Mode" menu command has been set to "ON", the lamp turns off automatically if no operations are carried out for about 30 minutes while no video signal is being input. The Power indicator will flash orange at this time. Press the [Power] button to turn the power on. If you do not want sleep mode to be used, change the "Sleep Mode" setting to "OFF". "Extended" - "Operation" - "Sleep Mode" p.65

■ The message "Not Supported." is displayed

Check	Remedy
Are the image signal format settings correct? Only when projecting images from a video source	If a composite video or S-Video source is connected to the projector, use the "Video Signal" menu command to select the signal format. "Signal" - "Video Signal" p.61
Does the mode match the frequency and resolution of the image signals? Only when projecting computer images	Refer to the documentation provided with your computer for details on changing the resolution and frequency of the image signals being output from the computer. "List of Supported Monitor Displays" p.115



Discount-Merchant.com (800) 281-8860
THE TRUSTED SOURCE FOR PROJECTOR LAMPS AND ACCESSORIES



Problems Solving

■ The message "No Signal." is displayed

Check	Remedy
Are the cables connected correctly?	Check that all of the cables required for projection are securely connected. p.20– p.26
Has the correct video input port been selected?	Press the [Computer], [S-Video], [Video] or [EasyMP](EMP-745/737 only) button on the remote control or the [Source Search] button on the remote control or the projector's control panel to change the image. p.37
Is the power for the computer or video source turned on?	Turn the power on for the devices. p.36
Are the image signals being output to the projector? <div style="background-color: #333; color: #fff; padding: 5px; margin-top: 10px;"> Only when projecting images from a laptop computer or computer with a built-in LCD screen </div>	<p>If the image signals are only being output to the computer's LCD monitor or to the accessory monitor, you need to change the output to an external destination as well as the computer's own monitor. For some computer models, when the image signals are output externally, they no longer appear on the LCD monitor or accessory monitor.</p> <p> Computer documentation, under a title such as "External output" or "Connecting an external monitor"</p> <p>If the connection is made while the power is already turned on, the function [Fn] key that switches the computer's video signal to external output may not work. Turn the power for the projector and the computer off and then back on again. p.36, p.38</p>

■ Images are fuzzy or out of focus

Check	Remedy
Has the focus been adjusted correctly?	Turn the focus ring on the projector to adjust the focus. p.40
Is the lens cover still attached?	Remove the lens cover. p.35
Is the projector at the correct distance?	The recommended projection distance range is 100–1210 cm (3.2–39.7 ft.). Set the projector up so that it is within this range. p.16
Is the keystone adjustment value too large?	Decrease the projection angle to reduce the amount of keystone correction. p.43
Has condensation formed on the lens?	<p>If the projector is suddenly taken from a cold environment to a warm environment or if sudden ambient temperature changes occur, condensation may form on the surface of the lens, and this may cause the images to appear fuzzy. Set the projector up in the room approximately one hour before it is to be used. If condensation forms on the lens, turn the power off and wait for the condensation to disappear.</p>



■ Interference or distortion appear in images

Check	Remedy
<p>Are the image signal format settings correct?</p> <p>Only when projecting images from a video source</p>	<p>If a composite video or S-Video source is connected to the projector, use the "Video Signal" menu command to select the signal format. "Signal" - "Video Signal" p.61</p>
<p>Are the cables connected correctly?</p>	<p>Check that all of the cables required for projection are securely connected. p.20– p.26</p>
<p>Is an extension cable being used?</p>	<p>If an extension cable is used, electrical interference may affect the signals. Use the accessory cables and check if this helps.</p>
<p>Has the correct resolution been selected?</p> <p>Only when projecting computer images</p>	<p>Set the computer so that the signals that are output are compatible with this projector. "List of Supported Monitor Displays" p.115 Computer documentation</p>
<p>Have the "Sync." and "Tracking" settings been adjusted correctly?</p> <p>Computer and RGB video signals only</p>	<p>Press the [Auto] button on the remote control or the [Enter] button on the projector's control panel to carry out automatic adjustment. If the images have not been adjusted correctly after using automatic adjustment, you can make the adjustments using the "Sync." and "Tracking" menus. p.45, p.46</p>

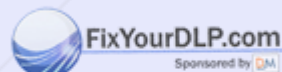

Discount-Merchant.com (800) 281-8860
THE TRUSTED SOURCE FOR PROJECTOR LAMPS AND ACCESSORIES



■ Image is truncated (large) or small

Check	Remedy
Has the "Resize" been set correctly?	Press the [Resize] button on the remote control. p.51
Is the image still being enlarged by the E-Zoom function?	Press the [Esc] button on the remote control to cancel the E-Zoom function. p.52
Has the "Position" setting been adjusted correctly?	<p>If analogue RGB images from a computer or RGB video images are being projected, press the [Auto] button on the remote control or the [Enter] button on the projector's control panel to carry out automatic adjustment.</p> <p>If the images have not been correctly adjusted after using the automatic setup function, adjust the setting manually using the "Position" menu command.</p> <p>If signals other than analogue RGB images from a computer or RGB video images are being input, adjust the setting manually using the "Position" menu command.</p> <p>"Signal" - "Position" p.60, p.61</p>
Has the computer been set for dual display? <div style="background-color: black; color: white; padding: 2px; display: inline-block;">Only when projecting computer images</div>	<p>If dual display has been activated in the Display Properties of the computer's Control Panel, the projector will only project about half of the image on the computer screen. To display the whole of the image on the computer screen, turn off the dual display setting.</p> <p> Computer video driver documentation</p>
Has the correct resolution been selected? <div style="background-color: black; color: white; padding: 2px; display: inline-block;">Only when projecting computer images</div>	<p>Set the computer so that the signals that are output are compatible with this projector.</p> <p>"List of Supported Monitor Displays" p.115</p> <p> Computer documentation</p>



■ Image colours are not right

Check	Remedy
<p>Do the input signal settings match the signals from the connected device?</p>	<p>If you connect a computer or RGB video to the [Computer/Component Video] port, and select "Component Video" for "Computer Input" in the configuration menu, the projected image is tinged with purplish red.</p> <p>If you connect a component video to the [Computer/Component Video] port, and select "Computer" for "Computer Input" in the configuration menu, the projected image is tinged with green.</p> <p>Select the correct signal format for the connected source.</p> <p>"Signal" - "Computer Input" p.60, p.61</p> <p>If a component video or S-Video source is connected to the projector, use the "Video Signal" menu command to select the video signal format.</p> <p>"Signal" - "Video Signal" p.61</p>
<p>Has the image brightness been adjusted correctly?</p>	<p>Use the "Brightness" menu command to adjust the brightness.</p> <p>"Image" - "Brightness" p.56, p.58</p>
<p>Are the cables connected correctly?</p>	<p>Check that all of the cables required for projection are securely connected. p.20– p.26</p>
<p>Has the image contrast been adjusted correctly?</p>	<p>Use the "Contrast" menu command to adjust the contrast.</p> <p>"Image" - "Contrast" p.56, p.58</p>
<p>Has the colour been adjusted correctly?</p>	<p>Use the "Color Adjustment" menu command to adjust the colour.</p> <p>"Image" - "Color Adjustment" p.57, p.59</p>
<p>Have the colour intensity and tint been adjusted correctly?</p> <p>Only when projecting images from a video source</p>	<p>Use the "Color Intensity" and "Tint" menu commands to adjust the colour and tint.</p> <p>"Image" - "Color Intensity", "Tint" p.58</p>



Problems Solving

■ Images appear dark

Check	Remedy
Have the image brightness and luminance been adjusted correctly?	Use the "Brightness" and "Brightness Control" menu commands to adjust the brightness and luminance. "Image" - "Brightness" 🖱️ p.56, p.58 "Setting" - "Brightness Control" 🖱️ p.62
Has the image contrast been adjusted correctly?	Use the "Contrast" menu command to adjust the contrast. "Image" - "Contrast" 🖱️ p.56, p.58
Is the lamp due for replacement?	When the lamp is nearly due for replacement, the images will become darker and the colour quality will become poorer. When this happens, the lamp should be replaced with a new one. 🖱️ p.101

■ Problems when projection starts

■ Power does not turn on

Check	Remedy
Have you pressed the [Power] button?	Press the [Power] button to turn the power on.
Are all of the indicators switched off?	The power cable is not connected correctly or power is not being supplied. Connect the power cable to the projector correctly. 🖱️ p.35 Alternatively, check the circuit breaker to see if power is being supplied.
Do the indicators turn off and on when the power cable is touched?	There is probably a poor contact in the power cable, or the power cable may be defective. Reinsert the power cable. If this does not solve the problem, stop using the projector, disconnect the power cable from the wall outlet and contact the nearest address provided in the "International Warranty Conditions" section of the <i>Safety Instructions/World-Wide Warranty Terms</i> booklet.



Discount-Merchant.com (800) 281-8860
THE TRUSTED SOURCE FOR PROJECTOR LAMPS AND ACCESSORIES



Problems Solving

■ Other problems

■ No sound can be heard or the sound is faint

Check	Remedy
Is the audio source connected correctly?	Check that the cable is connected to the [Audio] port correctly. p.27
Has the audio output setting been set to "External"? (EMP-745/737 only)	If using the EMP-745/737, you cannot play sound through the projector's built-in speaker when the "EasyMP Audio Out" in the configuration menu is set to "External". Change the setting to "Internal" to play sound through the projector. "Setting" - "EasyMP Audio Out" p.63
Has the volume been adjusted to the minimum setting?	Adjust the volume so that sound can be heard. p.48
Is A/V Mute mode active?	Press the [A/V Mute] button on the remote control to cancel the A/V mute function. p.50

■ The remote control does not work

Check	Remedy
Is the remote control light-emitting area facing towards the remote control light-receiving area when it is operated?	Face the remote control towards the remote control light-receiving area. The operating angle for the remote control is approximately $\pm 30^\circ$ horizontally and approximately $\pm 15^\circ$ vertically. p.14
Is the remote control too far from the projector?	The operating range for the remote control is approximately 6m. p.14
Is direct sunlight or strong light from fluorescent lamps shining onto the remote control light-receiving area?	Set the projector up in a location where strong light will not shine onto the remote control light-receiving area.
Are the batteries dead, or have the batteries been inserted correctly?	Insert new batteries, while making sure that they are inserted the correct way around. p.12

■ The projector's control panel does not work.

Check	Remedy
Has the "Operation Lock" been set to "ON"?	All buttons except the [Power] button on the control panel are disabled when the "Operation Lock" in the configuration menu is set to "ON". Use the remote control to operate the projector, or change the lock setting to "OFF" p.54



Problems Solving

- The fans do not stop when power is turned off (EMP-745/737 only)

Check	Remedy
Is the "Standby Mode" configuration menu set to "Network ON"?	If the menu is set to "Network ON", the fans will continue to operate after the cool-down period has finished. "Extended" - "Standby Mode" p.66

■ Problems Relating to Monitoring and Controlling Projectors Using a Network (EMP-745/737 only)

- Mail notification messages are not being sent when a problem occurs with the projector

Check	Remedy
Is the wireless or wired LAN card inserted?	Check that the wireless or wired LAN card is correctly inserted into the card slot of the projector. "Inserting and Removing Cards" p.17
Is the network cable connected correctly? When connected to a wired LAN	Check that the network cable is connected correctly. If it is not connected or is connected incorrectly, reconnect it.
Are the settings for connecting to a network correct?	Check the network settings for the projector. "Connecting in Access Point Mode or Wired LAN Mode" in the <i>EasyMP Network Setup Guide</i>
Has "Standby Mode" been set to "Network ON"?	If using the mail notification function while the projector is in standby mode, change the "Standby Mode" menu setting to "Network ON". "Extended" - "Standby Mode" p.66
Has a critical problem developed causing the projector to momentarily stop working?	When the projector has momentarily stopped working, it cannot send e-mail messages. If the projector cannot be reset even after it has been checked, contact your dealer or the nearest address provided in the "International Warranty Conditions" section of the <i>Safety Instructions/World-Wide Warranty Terms</i> booklet.
Is power being supplied to the projector?	Check if the power supply to the location where the projector is set up has been interrupted, or if the circuit breaker for the electrical outlet that the projector is connected to has been tripped.

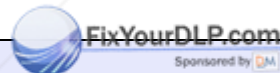



- The projector cannot be monitored and controlled using the EMP Monitor function

Check	Remedy
Is the wireless or wired LAN card inserted?	Check that the wireless or wired LAN card is correctly inserted into the card slot of the projector. "Inserting and Removing Cards" p.17
Is the network cable connected correctly? When connected to a wired LAN	Check that the network cable is connected correctly. If it is not connected or is connected incorrectly, reconnect it.
Are the settings for connecting to a network correct ?	Check the network settings for the projector. "Connecting in Access Point Mode or Wired LAN Mode" in the <i>EasyMP Network Setup Guide</i>
Has EMP Monitor function been correctly installed to the computer?	Uninstall EMP Monitor and then re-install it. "If You would like to Uninstall the EasyMP Software" and "Installing EasyMP Software" in the <i>EasyMP Network Setup Guide</i>
Have all projectors that are to be monitored and controlled been registered in the projector list?	Register the projector in the projector list. <i>EMP Monitor Operation Guide</i>
Has "Standby Mode" been set to "Network ON"?	If using the EMP Monitor function while the projector is in standby mode, change the "Standby Mode" menu setting to "Network ON". "Extended" - "Standby Mode" p.66
Is power being supplied to the projector?	Check if the power supply to the location where the projector is set up has been interrupted, or if the circuit breaker for the electrical outlet that the projector is connected to has been tripped.

- When Network Screen is running, the current image stays projected and connection from another computer is not possible

Check	Remedy
Has the person making the presentation left the meeting room without closing the connection?	<p>If you try to connect to a projector from a computer while Network Screen is running and the projector is already connected to another computer, the connection to the first computer will be terminated and the projector will then connect to the next computer.</p> <p>If no projector keyword has been set in the projector or the keyword is known, it is possible to terminate the current connection and connect to the projector by establishing a new connection from the computer.</p> <p>If a projector keyword has been set in the projector and the projector keyword is unknown, terminate the connection from the projector and then reconnect. To terminate the connection from the projector, press the [Esc] button on the remote control, select the "Exit" button from the displayed menu and then press the [Enter] button on the remote control. Connect from the desired computer after terminating the connection.</p> <p> "Disconnecting from a Network Connection" in the <i>EasyMP Network Setup Guide</i></p>



■ EMP NS Connection starts, but a projector is not found

Check	Remedy
Is the wireless or wired LAN card inserted?	Check that the wireless or wired LAN card is correctly inserted into the card slot of the projector. "Inserting and Removing Cards" p.17
Is the network cable connected correctly? When connected to a wired LAN	Check that the network cable is connected correctly. If it is not connected or is connected incorrectly, reconnect it.
Is the access lamp of the wireless LAN card that is inserted into the projector lit green?	If the access lamp is off, remove the wireless LAN card and re-insert it. "Inserting and Removing Cards" p.17
Is the projector displaying the EasyMP configuration menu screen?	Network connections are disabled while the EasyMP configuration setting screen is displayed. Close the configuration settings to return to the EasyMP standby window.
Is the computer ready for LAN card or in-built LAN functionality to be used?	Check whether the LAN device is functioning in the Device Manager. For example, "Control panel" - "System" - "Device Manager".
Is the wireless LAN setting for the computer set to ad hoc mode? When connected to a wireless LAN in easy connection mode	Change the wireless LAN settings at the computer to ad hoc mode. "Computer Wireless LAN Settings" in the <i>EasyMP Network Setup Guide</i> Depending on the manufacturer of the wireless LAN card, you may be able to use a communication setting utility (such as Client Manager) to set ad hoc mode. "Ad hoc mode" may be expressed using some other terminology such as "Computer communication using wireless LAN (WiFi)", "Wi-Fi ad hoc", "802.11 ad hoc", "802.11 Mode Connection" or "Peer to Peer".
Is the DHCP function of the wired LAN set to "ON"? When connected to a wireless LAN	Set the DHCP setting of the wired LAN to "OFF" in the EasyMP configuration setting screen. "Connecting in Access Point Mode or Wired LAN Mode" in the <i>EasyMP Network Setup Guide</i>
Has the network adapter been selected correctly in EMP NS Connection?	If the computer that you are using has several LAN environments, the correct network adapter to be used by EMP NS Connection must be selected, otherwise it will not be possible to connect. Start EMP NS Connection and select the network adapter from the "Extension" - "Switch LAN" (Windows) or "Extension" - "Network Set" (Macintosh) menu.
If making a wireless LAN connection, are there any settings within the power saving features of your computer which disable the wireless LAN?	Please enable the wireless LAN.
Is the computer's radio wave setting for the wireless LAN set to low-intensity?	Change the radio wave setting to the highest possible intensity.



FixYourDLP.com

Digit-Merchant.com (800) 281-8860
THE TRUSTED SOURCE FOR PROJECTOR LAMPS AND ACCESSORIES





Check	Remedy
Is the LAN card you are using 802.11g or 802.11b compliant?	Only 802.11g or 802.11b compliant equipment can be used. You cannot use equipment conforming to any other standards (such as 802.11 or 802.11a).
Is WEP encryption set to "ON" at the computer?	If using easy connection mode (ad hoc mode), WEP must be set to "OFF", otherwise connection will not be possible. Set WEP encryption to "OFF". "Connecting Using Easy Connect Mode (Wireless LAN)" in the <i>EasyMP Network Setup Guide</i>

■ Connection cannot be established in access point mode or wired LAN connection mode

Check	Remedy
Is the ESSID setting correct?	Enable the automatic ESSID search function, or set the ESSID for the computer or access point and the projector so that they are the same. "Connecting in Access Point Mode or Wired LAN Mode" in the <i>EasyMP Network Setup Guide</i>
Has an identical WEP key been set?	If "WEP" is selected in the "Security" configuration menu, set the WEP key for the computer or access point and the projector to the same key. "Connecting in Access Point Mode or Wired LAN Mode" in the <i>EasyMP Network Setup Guide</i>
Are the connection refusal functions of the access point, such as the MAC address and port restrictions, set correctly?	Set the projector connection permissions on the access point.
Have the IP address , subnet mask and gateway address for the access point and the projector been set correctly?	If not using DHCP , make all of the settings manually. "Connecting in Access Point Mode or Wired LAN Mode" in the <i>EasyMP Network Setup Guide</i>
Have the same subnet masks been set for the access point and the projector?	Select "Use IP connect mode" in EMP NS Connection and connect using IP connect mode. " If No Connected Projectors Appear " in the <i>EasyMP Operation Guide</i>

■ Connection is not possible in easy connection mode ([ad hoc mode](#))

Check	Remedy
Is there an access point manufactured by BUFFALO operating nearby?	Ad hoc connection is not possible if there is a BUFFALO access point set to the same ESSID , operating nearby. Turn off the power to the Melco access point or select an ESSID different to that access point.





■ Network Screen images are not displayed or the speed is slow

Check	Remedy
Are you trying to watch a movie in the Media Player, or preview a screen saver?	Depending on the computer, the Media Player video area may not be displayed, or the screen saver preview may not be displayed correctly.
Are you connecting in wireless LAN access point mode or wired LAN connection mode?	When using Network Screen in access point mode or wired LAN connection mode, display speed falls compared to easy connect mode.
Are you using WEP encryption, or connecting to multiple projectors?	Display speed falls when WEP encryption or two or more connections are being used.
Are you using DHCP when in wireless LAN access point mode or wired LAN connection mode?	If DHCP is enabled when using access point mode or when connecting to a wired LAN, it will take some time for EasyMP to get to standby mode if it cannot locate a DHCP server to connect to.
Was EMP NS Connection started or was the resolution or number of colours changed while a movie was playing? For Macintosh	When playing a movie, start EMP NS Connection before starting movie playback. If you start the EMP NS Connection while a movie is being played back, or change the resolution and colour settings of the display after starting the movie, the movie will freeze. In such cases, do something to activate the window such as moving it, or minimizing and restoring it.

■ PowerPoint slideshows will not play back in Network Screen

Check	Remedy
Are you trying to start Network Screen when PowerPoint is running? For Windows	Close the PowerPoint application before connecting with Network Screen. If you connect when PowerPoint is already running, you will not be able to project any slideshows.

■ Keynote slideshows cannot be played back with Network Screen

Check	Remedy
Are you using a Mac OS X 10.2.x-based computer? For Macintosh	Keynote slideshows may not be displayed correctly with Mac OS X 10.2.x due to limitations of the operating system. Play back Keynote slideshows with Mac OS X 10.3.x or later.



FixYourDLP.com
Sponsored by

Discount-Material.com
THE TRUSTED SOURCE FOR PROJECTOR LAMPS AND ACCESSORIES



■ Network Screen cannot be used

Check	Remedy
Are you using a personal firewall? For Windows	Network Screen may be unusable when a personal firewall other than NS Protect is set up.

■ When running Microsoft Office applications using Network Screen, the screen does not change as required

Check	Remedy
Have you been moving the mouse constantly?	As long as the mouse cursor is moved, the screen does not change. Stop moving the mouse cursor when having trouble changing the screen.

■ Files do not work correctly with EMP SlideMaker2

Check	Remedy
Are you trying to use a PowerPoint (.ppt) file created in the PowerPoint 95/97 format?	Files that have been created using PowerPoint 95/97 or saved in PowerPoint 95/97 format cannot be edited using EMP SlideMaker2. Resave the file in PowerPoint 2000/2002/2003 format before using it. ➡ "Files that Can be Included in Scenarios" in the <i>EasyMP Operation Guide</i>
When PowerPoint files (.ppt) cannot be pasted into a scenario, or thumbnails cannot be displayed, has the Microsoft Office JPEG converter been installed?	Install the JPEG converter. For more information about Microsoft Office JPEG converter installation, refer to the documentation for the Microsoft Office.

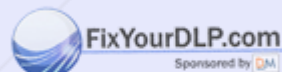



- An error message is displayed
Error messages from EMP NS Connection

Check	Remedy
Failed to connect to a projector.	Try to reconnect. If connection is still not possible, check the network settings at the computer and at the projector. For details on EasyMP network settings: <i>EasyMP Network Setup Guide</i>
Network settings are being made automatically.	If the computer has been set to use DHCP , it may take some time for the IP address to be set. If the IP address has not been determined within about 70 seconds after the message is displayed, an error message will be displayed. If this happens, try closing EMP NS Connection and then restarting it.
Projector detection error. No connectable projector exists, or the projector's power is not turned on.	Carry out the following. <ul style="list-style-type: none"> • Turn the power on for the projector, complete the projector preparation and then click the "Search Again" button. • Check the projector's configuration setting for EasyMP. • Check the security software settings for the computer, and cancel the port settings if the ports have been limited.
Incorrect keyword. Enter the keyword displayed on the projector.	Check the keyword for the projector that is displayed in the EasyMP standby window, and enter that projector's keyword.
Select a connecting projector from the list.	Select the name of each projector for the connection, and click the "Connect" button. <i>EasyMP Network Setup Guide</i>
The selected projector is in use. Continue to connect?	You are attempting to connect to a projector already connected to another computer. Click "Yes" to connect to the projector. The connection between the projector and the other computer will be terminated. Click "No" to end the connection attempt to the projector. The connection to the other computer will not be affected.
Failed to initialize EMP NS Connection.	Uninstall and then reinstall EMP NS Connection. "If You would like to Uninstall the EasyMP Software" and "Installing EasyMP Software" in the <i>EasyMP Network Setup Guide</i>



Discount-Merchant.com (800) 281-8860

THE TRUSTED SOURCE FOR PROJECTOR LAMPS AND ACCESSORIES





Check	Remedy
<p>Communication error occurred. Do you want to retry connection?</p>	<p>A communication error occurred between the computer and the projector, and the connection was closed. If you click the "Yes" button, a reconnection will be attempted. If the connection attempt is not successful, check the network settings at the computer and the EasyMP network settings at the projector. For details on network settings: <i>EasyMP Network Setup Guide</i> If you click the "No" button, the connection will remain closed and the message window will close.</p>
<p>One of the projectors cannot be connected with the keyword entered.</p>	<p>The wrong keyword was entered when trying to connect to a projector with a projector keyword. Check EasyMP standby screen for the correct projector keyword. Terminate the connection, reconnect and enter the projector keyword on the displayed keyword input screen. "Connecting the Computer and Projector via the Network" in the <i>EasyMP Network Setup Guide</i></p>
<p>Failed to obtain network adaptor information. Check network settings and restart.</p>	<p>Check the following:</p> <ul style="list-style-type: none"> •Is a network adapter installed in the computer ? •Is the driver for the network adapter installed in the computer ? <p>After checking, restart the computer and try to connect. If connection is still not possible, check the followings. Check the network settings at the computer and the EasyMP network settings at the projector. For details on network setting: <i>EasyMP Network Setup Guide</i></p>
<p>Some projectors do not support SXGA. Reduce resolution and retry.</p>	<p>One of the projectors you are connecting to is an EMP-735. Change the screen resolution of the computer to SXGA (1280 × 1024) or lower.</p>
<p>There is a projector not responding.</p>	<p>One or more projectors failed to connect when an attempt was made to connect simultaneously to multiple projectors. The successfully connected projectors can be used. To connect to the projectors that failed to connect, terminate the connection and try again. If connection is still not possible, check the network settings at the computer and the EasyMP network settings at the projector. For details on network settings: <i>EasyMP Network Setup Guide</i></p>
<p>Enter the keyword displayed on the projector.</p>	<p>Check the keyword for the projector that is displayed in the EasyMP standby screen, and enter that projector's keyword.</p>

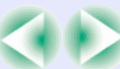



Check	Remedy
<p>Cannot find a projector of the specified IP address.</p>	<p>Check that "Wired LAN connection mode" or "Access Point Mode (Wireless LAN)" setting is being used in the EasyMP configuration settings for the projector to be connected. In the wireless LAN setting screen, change to "Access Point Mode" if it is set to "Easy Connect Mode". Next, check the "IP Address" setting in the "Wired LAN" - "Basic" or the "Wireless LAN" - "Basic" configuration menu, and specify that IP address when connecting in IP connection mode. 🖱️ "If No Connected Projectors Appear" in the <i>EasyMP Operation Guide</i>. If connection is still not possible, check the network settings at the computer and the EasyMP network settings at the projector. For details on network setting: 🖱️ "Connecting in Access Point Mode or Wired LAN Mode" in the <i>EasyMP Network Setup Guide</i></p>
<p>Image transfer slows if PC resolution is higher than XGA (1024 × 768 pxl.) Do you want to continue?</p> <p>For Windows</p>	<p>The display of the computer being connected to the projector is set to resolution higher than XGA (1024 × 768). Clicking "Yes" connects the projector. However, the display speed of the projection screen will be slow. Clicking "No" aborts the projector connection. To avoid slow display speeds on the projection screen, change the computer display settings to: XGA (1024 × 768) or lower.</p>
<p>Image transfer slows if screen color is more than 24 bits. NS Connection converts it to 16 bits. Do you want to continue?</p> <p>For Windows</p>	<p>The display colours of the computer being connected to the projector is set to 24 bits or higher. Clicking "Yes" connects the projector. However, the display will be in 16 bit colour.</p>

If an error message not described above is displayed, refer to the EMP NS Connection help.

Error messages from EMP SlideMaker2

Check	Remedy
<p>**SIT already registered. (** is the scenario file name)</p>	<p>It is not possible to add a scenario file name if it already exists in the "Autorun Scenario List". 🖱️ "Sending a Scenario" in the <i>EasyMP Operation Guide</i></p>
<p>Not enough disk space.</p>	<p>The drive to which a scenario is being sent has insufficient free space and the scenario cannot be sent. Delete unneeded files on the destination drive to free sufficient disk space to save the scenario on the drive.</p>

FixYourDLP.com
Sponsored by DM

Discount-Merchants.com (800) 281-8880

THE TRUSTED SOURCE FOR PROJECTOR LAMPS AND ACCESSORIES

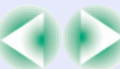



Check	Remedy
** contains an invalid path. (** is the path name containing the scenario file.)	The path of the file to be opened could not be found. This could be for the following reasons. <ul style="list-style-type: none"> •After the last time the scenario file was saved by EMP SlideMaker2, the file was moved to another folder. •After the last time the scenario file was saved by EMP SlideMaker2, the folder name was changed. •The desired scenario file has been deleted. Open the desired scenario file by selecting "File"->"Open", or search for the file using the Windows "Search for Files or Folders" function or other methods.
Disk full while accessing **. (** is the path name including the scenario file)	The drive containing the scenario folder has insufficient free space, and could not save the scenario file. Delete unneeded files on the drive containing the scenario folder to free sufficient disk space allowing the scenario file to be saved.
Cannot open the proposed file.	The PowerPoint file to be added to the scenario is damaged or corrupted and cannot be used. Use a different PowerPoint file.
Change name or directory	A file or scenario folder of the same name already exists. Change the scenario name or the scenario folder name and try saving again.

Error messages from EMP Monitor

Check	Remedy
The password is incorrect.	An incorrect password was entered. Enter the correct password. If you forget the password, check the "Password for WEB control " setting in the "Wired LAN" - "Basic" or the "Wireless LAN" - "Basic" configuration menu.
Cannot connect to the projector of the IP address entered.	Check that "Wired LAN Connect Mode" or "Access Point Mode (Wireless LAN)" setting is being used in the EasyMP configuration settings for the projector to be connected. If "Easy Connect Mode" is selected in the "Wireless LAN" - "Basic" configuration menu, change the setting to "Access Point Mode". Next, check the "IP Address" setting in the "Wired LAN" - "Basic" or the "Wireless LAN" - "Basic" configuration menu, and specify that IP address when connecting in IP connection mode. ☛ " Registration Using IP Address (Manual Registration) " in the <i>EMP Monitor Operation Guide</i> If connection is still not possible, check the network settings at the computer and the EasyMP network settings at the projector. For details on network settings: ☛ "Connecting in Access Point Mode or Wired LAN Mode" in the <i>EasyMP Network Setup Guide</i>



Discount-Merchants.com
THE TRUSTED SOURCE FOR PROJECTOR LAMPS AND ACCESSORIES



Appendices

This chapter provides information on maintenance procedures to ensure the best level of performance from the projector.

Maintenance	99	List of ESC/VP21 Commands.....	113
• Cleaning	99	• Command List	113
• Cleaning the Projector's Surface.....	99	• USB connection.....	113
• Cleaning the Lens	99	• USB Connection Setup.....	114
• Cleaning the Air Filters and Air Intake Vent.....	99	List of Supported Monitor Displays	115
• Replacing Consumables.....	100	• Computer/RGB Video	115
• Lamp Replacement Period.....	100	• Component Video/RGB Video.....	115
• Replacing the Lamp.....	101	• Composite Video/S-Video.....	115
• Resetting the Lamp Operating Time.....	103	Specifications	116
• Replacing the Air Filter	104	Appearance.....	118
Saving a User's Logo	105		
Optional Accessories and Consumables	108		
• Optional Accessories	108		
• Consumables.....	108		
Glossary	109		

Maintenance



This section describes maintenance tasks such as cleaning the projector and replacing consumable parts.

Cleaning

You should clean the projector if it becomes dirty or if the quality of projected images starts to deteriorate.



CAUTION

Be sure to read the separate Safety Instructions/World-Wide Warranty Terms before cleaning.

Cleaning the Projector's Surface

Clean the projector's surface by wiping it gently with a soft cloth. If the projector is particularly dirty, moisten the cloth with water containing a small amount of neutral detergent, and then firmly wring the cloth dry before using it to wipe the projector's surface. Then wipe it again with a soft, dry cloth.



CAUTION

Do not use volatile substances such as wax, alcohol or thinner to clean the projector's surface. These can cause the projector to warp and make the coating finish peel off.

Cleaning the Lens

Use a commercially-available air blower, or use a lens cleaning paper to gently wipe the lens.



CAUTION

Do not rub the lens with harsh materials or subject the lens to shocks, as it can easily become damaged.

Cleaning the Air Filters and Air Intake Vent

If dust collects on the air filter or the air outlet, it can cause the internal temperature of the projector to rise, and this can lead to problems with operation and shortening of the optical engine's service life. It is recommended that you clean these parts at least once every three months. Clean them more often than this if using the projector in particularly dusty environments.

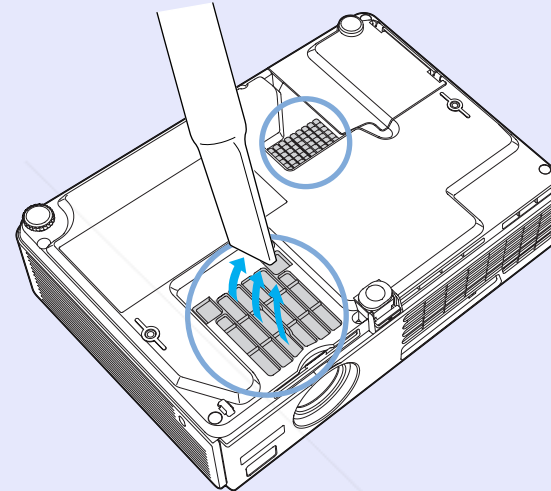

TIP

If the air filters are broken or if the warning message reappears after they have been cleaned, they should be replaced. Replace with a new air filter. See "Replacing the Air Filter". [p.104](#)



Replacing Consumables

This section describes how to replace the lamp and the air filters.

Lamp Replacement Period

It is time to replace the lamp when:

- The message "Replace the Lamp." appears on the screen when projection starts.

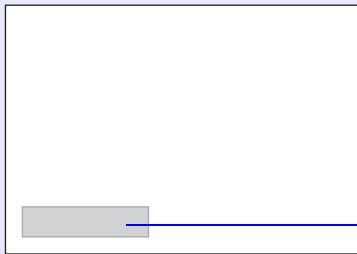

A message will be displayed.

- When the Lamp indicator is flashing orange.

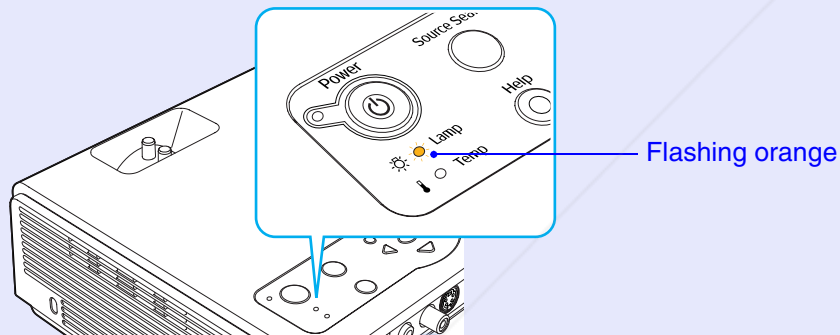

- The projected image gets dark or starts to deteriorate.



TIP

- **The lamp replacement message is set to appear after the following periods of time in order to maintain the initial brightness and quality of the projected images.**
 - When used continuously at high brightness: Approx. 1900 hours
 - When used continuously at low brightness : Approx. 2900 hours**"Brightness Control" p.62**
- **If you continue to use the lamp after this period, the possibility of the lamp breaking becomes greater. When the lamp replacement message appears, replace the lamp with a new one as soon as possible, even if it is still working.**
- **Depending on the characteristics of the lamp and on the way it has been used, the lamp may become darker or stop working before the lamp warning message appears. You should always have a spare lamp ready in case it is needed.**
- **Contact your dealer for a spare lamp.**

FixYourDLP.com

Discount-Merchant.com (800) 281-8860

THE TRUSTED SOURCE FOR PROJECTOR LAMPS AND ACCESSORIES



■ Replacing the Lamp

! CAUTION

- *If you are replacing the lamp because it has stopped working, it is possible that the lamp is broken. If replacing the lamp of a projector which has been installed on the ceiling, you should always assume that the lamp is broken and handle it with extreme care during removal. Furthermore, you should stand to the side of the projector, not underneath it.*
- *Wait until the lamp has cooled down sufficiently before removing the lamp cover. It takes a further one hour after the **cool-down** period has finished for the lamp to be cool enough.*

PROCEDURE

- 1 Turn off the projector's power, wait until the cool-down period has ended and a "pip-pip" confirmation buzzer sounds, and then disconnect the power cable.**

The cool-down period lasts for about 20 seconds.

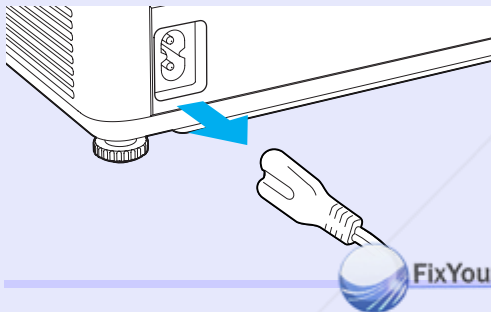

FixYourDLP.com
Sponsored by

Discount-Merchant.com (800) 281-8860

THE TRUSTED SOURCE FOR PROJECTOR LAMPS AND ACCESSORIES

- 2 Wait until the lamp has cooled down, then remove the lamp cover from the base of the projector.**

It takes approximately one hour for the lamp to cool down by itself after the cool-down period has finished. While pressing the two hooks, pull the lamp cover up to remove it.

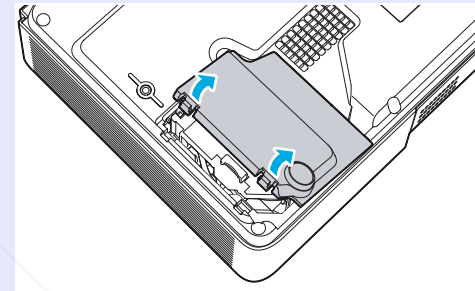

- 3 Loosen the two lamp fixing screws.**

Loosen the two lamp fixing screws with the screwdriver that is supplied with the spare lamp (or your own cross head screwdriver).

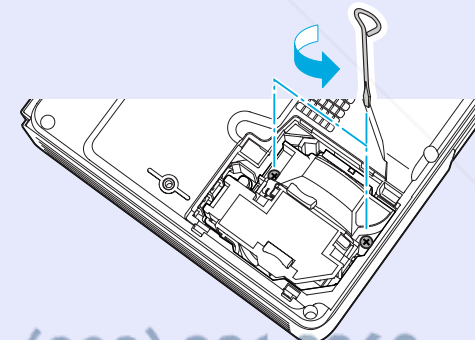



4 Take out the lamp.

Hold the lamp as shown in the illustration below and lift it up and out of the projector. If the lamp is broken replace it with a new lamp, or contact your local dealer for further advice. If replacing the lamp yourself, be careful to avoid pieces of broken glass.

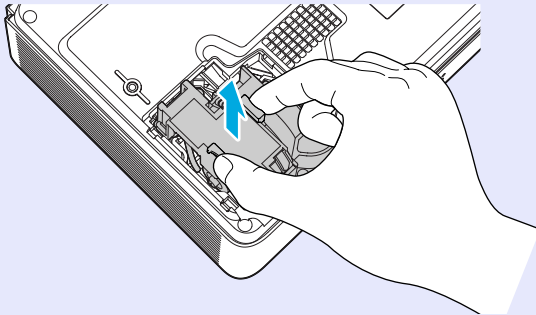

5 Install the new lamp.

Insert the new lamp so that the lamp fits the place correctly and once it is fully inserted, tighten the two screws.

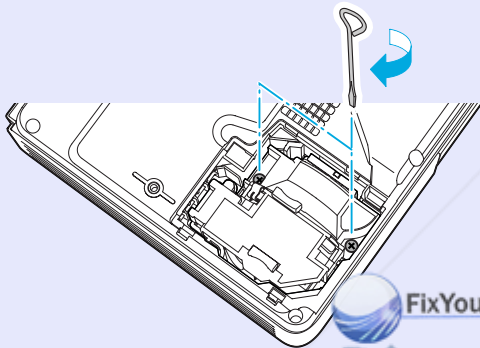

6 Install the lamp cover.

Insert the two cover tabs into the projector, and then press the other side of the lamp cover until it clicks into place.

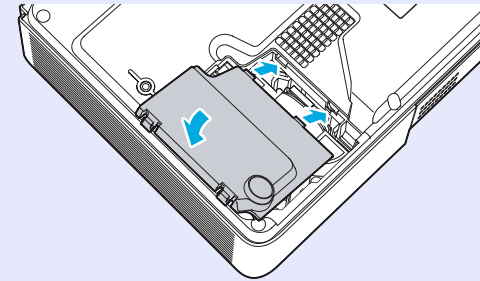

TIP

- *Install the lamp securely. If the lamp cover is removed, the lamp turns off automatically as a safety precaution. Moreover, the lamp will not turn on if the lamp or the lamp cover is not installed correctly.*
- *The lamp contains mercury. Dispose of used lamps properly in accordance with your local regulations.*

FixYourDLP.com
Sponsored by DM

Discount-Merchant.com (800) 281-8860
THE TRUSTED SOURCE FOR PROJECTOR LAMPS AND ACCESSORIES





Resetting the Lamp Operating Time

The projector has a built-in counter which keeps track of the lamp operating time. When the cumulative operating time reaches a certain point, it causes the replacement warning message to be displayed. Therefore, the counter needs to be reset after the lamp has been replaced with a new one. You can do this using the configuration menu.



TIP

Do not reset the lamp operating time except after the lamp has been replaced, otherwise the lamp replacement period will not be indicated correctly.

PROCEDURE

- 1 Connect the power cable, turn on the projector's power, and then press the [Menu] button.

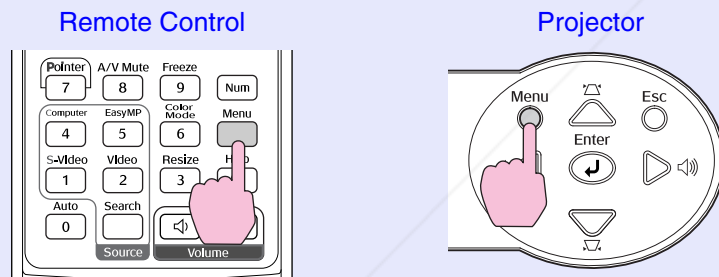
The configuration menu will be displayed.



- 2 Select "Lamp-Hours Reset" from the "Reset" menu and then press the [Enter] button.

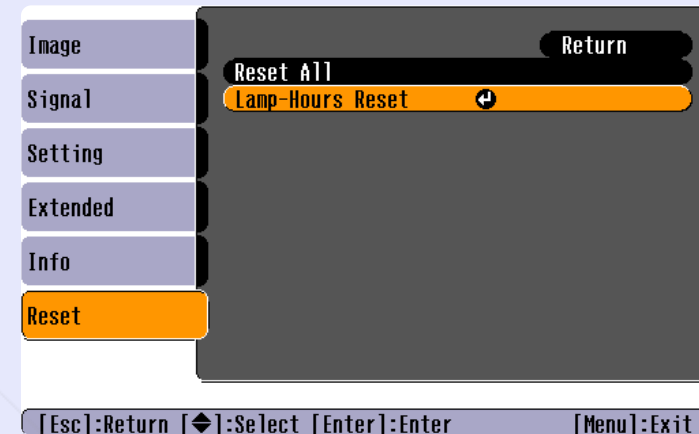

- 3 Select "Yes" and then press the [Enter] button. The lamp operating time will then be reset.

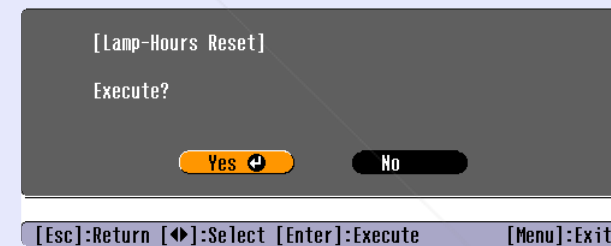



Replacing the Air Filter

If the air filters are broken or if the warning message reappears after they have been cleaned, they should be replaced.

The air filter can be replaced even if the projector is installed on a ceiling.

PROCEDURE

- 1** Turn off the projector's power, wait until the **cool-down** period has ended and a "pip-pip" confirmation buzzer sounds, and then disconnect the power cable.

The cool-down period lasts for about 20 seconds.

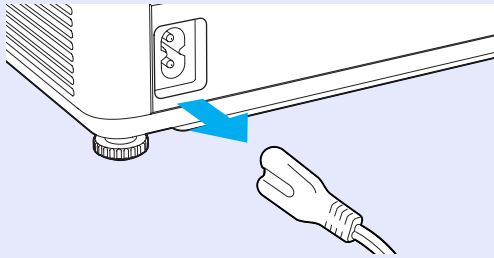

- 2** Remove the air filter.

Put your finger into the recess of the air filter and slide it forward to remove it.

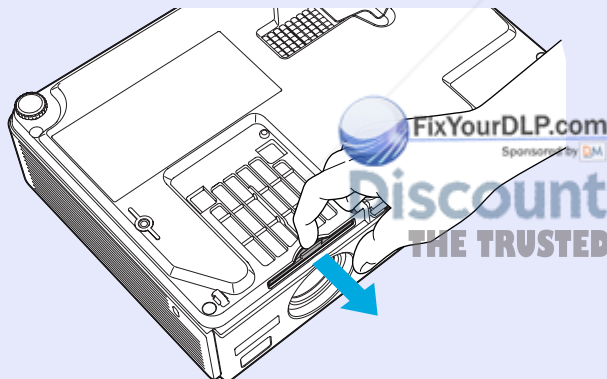
**3**

- 3** Install the new air filter.

Slide the air filter covers in from the outside and push them in until they click into place.

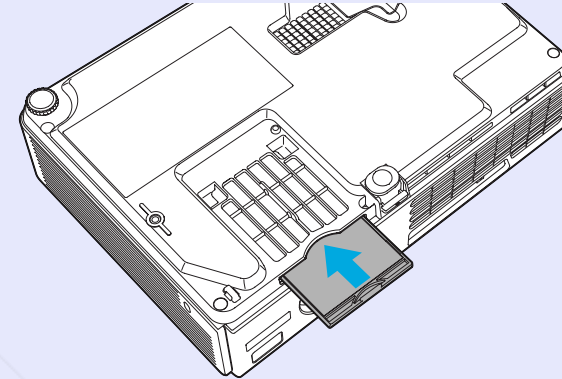
**TIP**

Dispose of used air filters properly in accordance with your local regulations.

Air filter frame: Polycarbonate, ABS plastic

Air filter: Polyurethane foam



Saving a User's Logo

You can record the image that is currently being projected as a user's logo.



TIP

When a user's logo is recorded, the previous user's logo will be erased.

PROCEDURE

1

Project the image that you would like to use as a user's logo, and then press the [Menu] button.

Remote Control

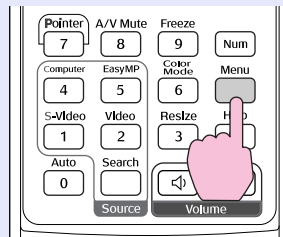

Projector

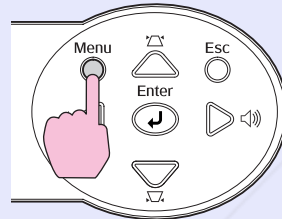

2

Select "User's Logo" from the "Extended" menu, and then press the [Enter] button.

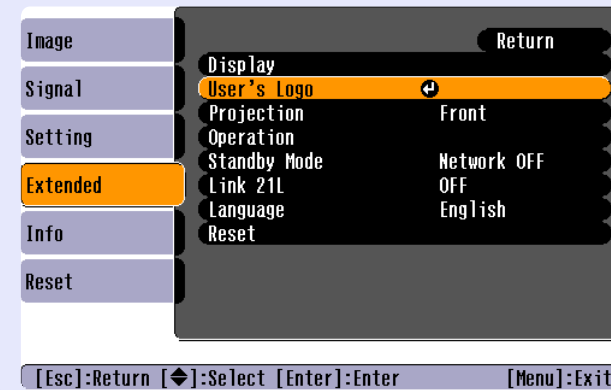

TIP

- If the "User's Logo Protect" function of "Password Protect" is set to "ON", a message is displayed and the user's logo can not be recorded. To record a user's logo, set "User's Logo Protect" to "OFF" first. [p.33](#)
- If keystone correction or E-Zoom have been carried out, they will be cancelled when the "User's Logo" menu is selected.





Saving a User's Logo

- 3** Select "Yes" in the sub-menu, then press the [Enter] button.

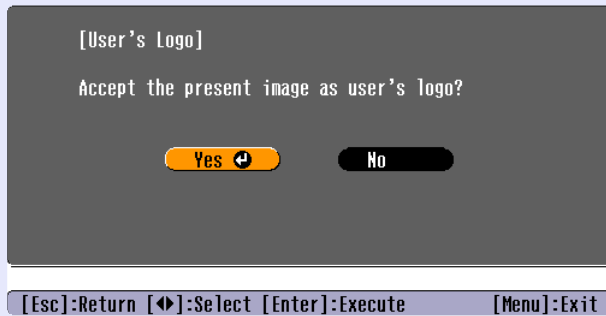

TIP

When you press the [Enter] button on either the remote control or the projector's control panel, the image signal will be displayed at their original resolution, so if a signal with a resolution that is different from the panel resolution of the projector is projected, or if a video image is being projected, the display size will change.

- 4** The image to be recorded and a selection marquee box will be displayed. Move the marquee box to select the part of the image to use.

Tilt the [⊙] button on the remote control or press the [△], [▽], [◀] and [▶] buttons on the projector's control panel to select the area of the image to use as the user's logo, and then press the [Enter] button.

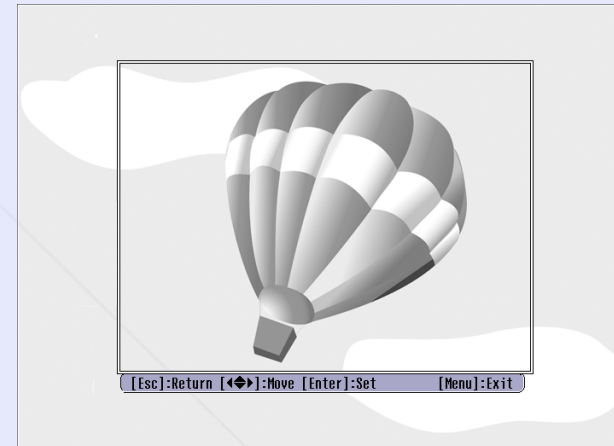

TIP

User's logos can be saved at up to 480 × 360 dots in size.



Discount-Merchant.com (800) 281-8860

THE TRUSTED SOURCE FOR PROJECTOR LAMPS AND ACCESSORIES

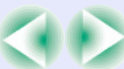



Saving a User's Logo

- 5** Select "Yes" at the confirmation screen, and then press the [Enter] button.

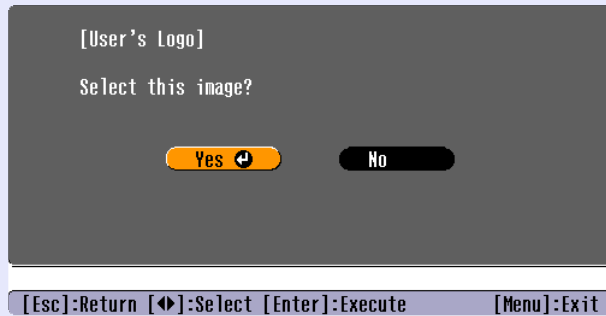

- 6** Select the zoom rate in the Zoom rate setting screen, and then press the [Enter] button.

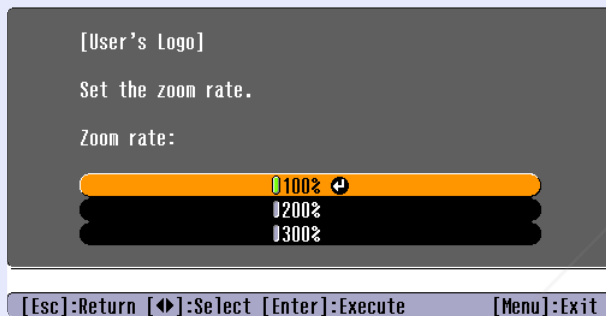

- 7** Select "Yes" at the confirmation screen, and then press the [Enter] button.

The image will then be saved. Once the image has been saved, the message "Completed." will be displayed.

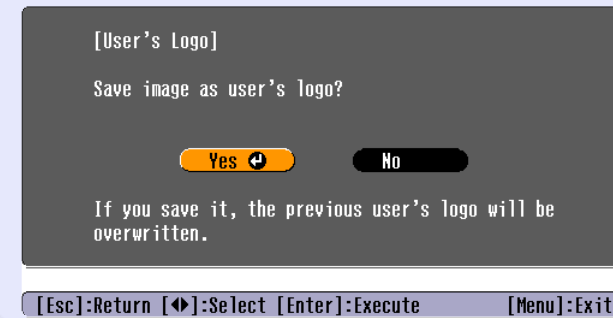

TIP

- *Saving the user's logo may take a few moments (about 15 seconds). Do not use the projector or any other sources which are connected to the projector while the user's logo is being saved, otherwise it may result in errors in projector operation.*
- *Once a user's logo has been saved, the logo setting cannot be returned to the factory default.*





Optional Accessories and Consumables

The following optional accessories are available for purchase if required. This list of optional accessories is current as of June, 2004. Details of accessories are subject to change without notice.

■ Optional Accessories

Soft carrying case ELPKS16

Use this case if you need to carry the projector by hand.
You can put a laptop computer into the case.

60" screen ELPSC07

80" screen ELPSC08

100" screen ELPSC10

A portable roll-type screen. ([Aspect ratio](#)» 4:3)

50" portable screen ELPSC06

A compact screen which can be carried easily. (Aspect ratio 4:3)

VGA-HD15 PC cable ELPKC02

(1.8 m (6 ft.) - for mini D-Sub 15-pin/mini D-Sub 15-pin)

This is the same computer cable as the projector's accessory computer cable.

VGA-HD15 PC cable ELPKC09

(3 m (9.8 ft.) - for mini D-Sub 15-pin/mini D-Sub 15-pin)

VGA-HD15 PC cable ELPKC10

(20 m (65.6 ft.) - for mini D-Sub 15-pin/mini D-Sub 15-pin)

Use this extension cable if the accessory computer cable is too short.

Component video cable ELPKC19

(3 m (9.8 ft.) - for mini D-Sub 15-pin/RCA male × 3)

Component video cable ELPKC27

(0.35 m (1.15 ft.) - for mini D-Sub 15-pin/RCA female × 3)

Use to connect a [component video](#)» source.

Image presentation camera ELPDC04

Use to project books, OHP films and slides.

Ceiling plate* ELPFC03

Pipe 370 (370 mm (14.57 in.)/silver)* ELPFP04

Pipe 570 (570 mm (22.44 in.)/silver)* ELPFP05

Pipe 770 (770 mm (30.31 in.)/silver)* ELPFP06

Use when installing the projector on a high ceiling or a ceiling with veneer panels.

Ceiling mount * ELPMB18

Use when installing the projector to a ceiling.

* A special method of installation is required in order to suspend the projector from the ceiling. Please contact your dealer if you would like to use this installation method.

■ Consumables

Spare lamp ELPLP32

Use as a replacement for spent lamps.

Filter kit ELPAF08

(2 air filters)

Use as a replacement for used air filters.



Sponsored by

Discount-Merchant.com (800) 281-8860

THE TRUSTED SOURCE FOR PROJECTOR LAMPS AND ACCESSORIES



Glossary

The following is an explanation of some of the terms used in this guide which may be unfamiliar or which are not explained in the text of this guide itself. Further information can be obtained by referring to other commercially-available publications.

5BNC	A port used to input analogue video signals.
Abs. Color Temp.	The temperature of an object which is emitting light. If the absolute colour temperature is high, the colours tend to take on a bluish tinge. If the absolute colour temperature is lower, the colours tend to take on a reddish tinge.
Ad hoc mode	A method of wireless LAN connection that communicates with wireless LAN clients without using an access point.
Aspect ratio	The ratio between an image's length and its height. HDTV images have an aspect ratio of 16:9 and appear elongated. The aspect ratio for standard images is 4:3.
Authentication server	This is a server that centrally manages user authentication. By using an authentication server, management of user information and user authentication tasks can be centralised. In addition, many authentication servers use high-level authentication methods and so they also tend to be highly secure.
CCX	Abbreviation for Cisco Compatible Extensions. This is a security technology for wireless LANs developed by Cisco Systems, Inc. It uses RADIUS server for authentication. Several authentication methods are available for CCX, and this projector uses LEAP authentication.
Component video	Video signals which have the video brightness signals and colour signals separated, in order to provide better image quality. In high-definition TV (HDTV), it refers to images which consist of three independent signals: Y (luminance signal), and Pb and Pr (colour difference signals).
Composite video	Video signals which have the video brightness signals and colour signals mixed together. The type of signals commonly used by household video equipment (NTSC, PAL and SECAM formats). The carrier signal Y (luminance signal) and chroma (colour) signal which are contained in the colour bar are overlapped to form a single signal.
Contrast	The relative brightness of the light and dark areas of an image can be increased or decreased in order to make text and graphics stand out more clearly, or to make them appear softer. Adjusting this particular property of an image is called "contrast adjustment".
Cool-down	This is the process by which the projector's lamp is cooled down after it has become hot through use. Cool-down is carried out automatically when the [Power] button is pressed to turn off the power. Do not disconnect the power cable while cool-down is in progress, otherwise the cool-down process will not work properly. If the cool-down period is not allowed to finish normally, the projector's lamp and internal components will remain at high temperatures, and this may shorten the operating life of the lamp or cause problems with the operation of the projector.
DHCP	Dynamic Host Configuration Protocol. This protocol automatically assigns an IP address to a computer connected to a network.
Dolby Digital	A sound format developed by Dolby Laboratories. Normal stereo is a 2-channel format which uses two speakers. Dolby Digital is a 6-channel (5.1-channel) system which adds to this a centre speaker, two rear speakers and a sub-woofer.
DPOF	Abbreviation of Digital Print Order Format, which is a format used to record information concerning the printing of photographs taken with a digital camera (which images to print, how many copies, etc.) to recordable media, such as a memory card.





EMP Link 21L	A utility software program that allows the projector to be connected to a computer so that the computer can be used to control the projector. For details on acquiring the software and for instructions on using the software and compatible projector models, please visit the Web site http://www.epson.co.uk/support/download/index.htm .
ESSID	ESS is an abbreviation of Extended Service Set. The ESSID is an identification number for connecting with a counterpart on a wireless LAN. Wireless communication is possible between devices with corresponding ESSID numbers. With Macintosh computers, the ESSID is used as the network name that is displayed for "computer-to-computer" networks.
Gateway	A server (router) for communicating across a network divided according to subnet masks.
HDTV	An abbreviation for High-Definition Television. It refers to high-definition systems which satisfy the following conditions. <ul style="list-style-type: none"> • Vertical resolution of 750p or 1125i or greater (p = progressive scanning, i = interlaced scanning) • Screen aspect ratio of 16:9 • Dolby Digital audio reception and playback (or output)
Interlaced scanning	A method of image scanning whereby the image data is divided into fine horizontal lines which are displayed in sequence starting from left to right and then from the top to the bottom of the screen. The even-numbered lines and odd-numbered lines are displayed alternately.
IP Address	A series of numbers that identifies a device that is connected to a network.
LEAP	One of the authentication methods used by CCXg. It uses usernames and passwords for authentication without using electronic signatures.
MAC address	MAC is an abbreviation of Media Access Control. The MAC address is an ID number unique to each network card. A unique number is assigned to each network card. Data is transmitted between cards (devices) based on this identification.
Progressive scanning	A method of image scanning whereby the image data from a single image is scanned sequentially from top to bottom to create a single image.
RADIUS server	RADIUS is an abbreviation for Remote Authentication Dialin User Service. It is a protocol that is used for authenticating transmissions for a variety of network servers including wireless LANs. A RADIUS server is an authentication server that stores information such as usernames and passwords and concentrates functions such as authenticating access to wireless LAN access points. By using a RADIUS server, access points and user information can be centrally managed without needing to store user information separately at each access point when there are several access points on a wireless LAN.
Refresh rate	The light-emitting element of a display maintains the same luminosity and colour for an extremely short time. Because of this, the image must be scanned many times per second in order to refresh the light-emitting element. The number of refresh operations per second is called the "refresh rate", and is expressed in hertz (Hz).
Resize display	This function is used to allow images that have a resolution more than or less than the projector's panel resolution to be projected so that they fill the whole of the projection area.
SDTV	An abbreviation for Standard Definition Television. It refers to standard television systems which do not satisfy the conditions for High-Definition Television.
Security lock	A device consisting of a projector case with a hole in it that a commercially-available theft-prevention cable can be passed through in order to secure the device to a table or pillar. This projector is compatible with the Microsaver Security System manufactured by Kensington.

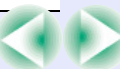



Glossary

SNMP	This is an abbreviation of Simple Network Management Protocol. It is a protocol in a TCP/IP network for monitoring and controlling communication devices on the network, such as routers, computers, and terminals across the network.
Squeeze mode	In this mode, wide-screen images in 16:9 mode are compressed in the horizontal direction so that they are stored on the recording medium as 4:3 images. When these images are played back by the projector in squeeze mode, they are restored to their original 16:9 format.
sRGB	An international standard for colour intervals that was formulated so that colours which are reproduced by video equipment can be handled easily by computer operating systems (OS) and the Internet.
Subnet mask	This is a number which defines, from the IP address, the number of bits used in network addresses of assigned networks (subnets).
SVGA	A type of video signal with a resolution of 800 (horizontal) × 600 (vertical) dots which is used by IBM PC/AT-compatible computers.
S-Video	A video signal which has the luminance component and colour component separated in order to provide better image quality. It refers to images which consist of two independent signals: Y (luminance signal), and C (colour signal).
SXGA	A type of video signal with a resolution of 1280 (horizontal) × 1024 (vertical) dots which is used by IBM PC/AT-compatible computers.
Sync (synchronisation)	The signals output from computers and RGB video equipment have a specific frequency. If the projector frequency does not match this frequency, the resulting images will not be of a good quality. The process of matching the phases of these signals (the relative position of the crests and troughs in the signal) is called "synchronisation". If the signals are not synchronized, problems such as flickering, blurriness and horizontal interference can occur.
TKIP	Abbreviation for Temporal Key Integrity Protocol. This is an encoding method used for WPA . The encryption key is renewed after a certain period of time to make it harder to break the encryption code.
Tracking	The signals output from computers and RGB video equipment have a specific frequency. If the projector frequency does not match this frequency, the resulting images will not be of a good quality. The process of matching the frequency of these signals (the number of crests in the signal) is called "tracking". If tracking is not carried out correctly, wide vertical stripes will appear in the projected images.
Trap IP address	This is the IP address of the messaged computer used for error notification in SNMP.
USB	An abbreviation for Universal Serial Bus. USB is an interface for connecting personal computers to peripheral devices which only support relatively low data transmission speeds.
UXGA	A type of video signal with a resolution of 1600 (horizontal) × 1200 (vertical) dots which is used by IBM PC/AT-compatible computers.
VGA	A type of video signal with a resolution of 640 (horizontal) × 480 (vertical) dots which is used by IBM PC/AT-compatible computers.
WEP	This is an abbreviation of Wired Equivalent Privacy. This is a security method which encrypts data during transmission. Data communication cannot be performed unless the sending and receiving machines are registered with the same encryption key by the WEP.

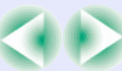



WPA	Abbreviation for Wi-Fi Protected Access. This is an encryption standard that improves security which is a weak point of WEP . TKIP is used as the encryption method.
XGA	A type of video signal with a resolution of 1024 (horizontal) × 768 (vertical) dots which is used by IBM PC/AT-compatible computers.

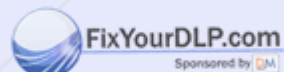

Discount-Merchant.com (800) 281-8860
THE TRUSTED SOURCE FOR PROJECTOR LAMPS AND ACCESSORIES





List of ESC/VP21 Commands

Command List

When a power on command is sent to the projector, the power will turn on and the projector will change to warm-up mode. When the power has turned on, a colon ":" (3Ah) will be returned.

When the projector executes a command, it returns a ":" and waits for the next command to be sent.

If command processing terminates with an error, the projector outputs an error message and then returns the ":" code.

	Item	Command
Power ON/OFF	ON	PWR ON
	OFF	PWR OFF
Signal selection	Computer (Auto)	SOURCE 1F
	Computer	SOURCE 11
	Component Video	SOURCE 14
	Video	SOURCE 41
	S-Video	SOURCE 42
A/V Mute ON/OFF	ON	MUTE ON
	OFF	MUTE OFF
A/V Mute Selection	Black	MSEL 00
	Blue	MSEL 01
	User's Logo	MSEL 02

* When issuing any of the above commands, tack a Carriage Return (CR) code (0Dh) on to the end.

USB connection

- Connector shape: USB (type B)

<At projector>

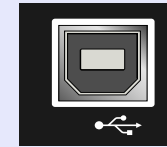

(type B)

<At computer>

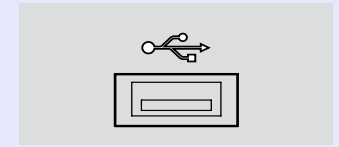

*The [USB Type A] port (EMP-745/737 only) cannot be used as a USB hub.



Discount-Merchant.com (800) 281-8860
 THE TRUSTED SOURCE FOR PROJECTOR LAMPS AND ACCESSORIES



USB Connection Setup

In order to control the projector using ESC/VP21 commands via a USB connection, the following preparations must be carried out.

PROCEDURE

- 1 Download the USB driver (USB-COM Driver) from the EPSON website to your computer.**

The URL is as follows.

<http://www.epson.co.uk/support/download/index.htm>.

- 2 Install the downloaded USB driver on your computer.**

Read the instructions displayed on the download screen.

- 3 Change the "Link 21L" setting in the "Extended" menu to "ON".**

- 4 Turn the projector's power off.**

- 5 Wait until the **cool-down** period has ended and a "pip-pip" confirmation buzzer sounds, and then turn on the power.**

Once the projector's power has turned back on, communication via a USB Connection will then be possible.



CAUTION

The setting you made will be disabled if you disconnect the power cable before the cool-down period has ended and a "pip-pip" confirmation buzzer sounds.



FixYourDLP.com

Sponsored by

Discount-Merchant.com (800) 281-8860

THE TRUSTED SOURCE FOR PROJECTOR LAMPS AND ACCESSORIES



List of Supported Monitor Displays

Computer/RGB Video

Signal	Refresh rate [»] (Hz)	Resolution (dots)	Resolutions for resize display [»] (dots)
VGA [»]	60	640×480	1024×768
VGAEGA		640×350	1024×560
VESA	60/72/75/85,iMac*	640×480	1024×768
SVGA [»]	56/60/72/75/85,iMac*	800×600	1024×768
XGA [»]	60/70/75/85,iMac*	1024×768	1024×768
SXGA [»]	70/75/85	1152×864	1024×768
SXGA	60/75/85	1280×960	1024×768
SXGA	60/75/85	1280×1024	960×768
UXGA [»]	60	1600×1200	1024×768
MAC13"		640×480	1024×768
MAC16"		832×624	1024×768
MAC19"		1024×768	1024×768
MAC19"	60	1024×768	1024×768
MAC21"		1152×870	1016×768
SDTV [»] (625i)	50	720×576	1024×768
SDTV(525i)	60	720×480	1024×768
SDTV(525p)	60	720×480	1024×768
HDTV [»] (750p)	60	1280×720	1024×576

* Connection is not possible if the equipment does not have a VGA output port.

The projection of some signals not listed in the table may still be possible. However, not all functions may be supported.

Component Video/RGB Video

Signal	Refresh rate [»] (Hz)	Resolutions (dots)	
		Aspect ratio [»] 4:3	Aspect ratio 16:9
SDTV [»] (525i) (D1)	60	1024×768	1024×576
SDTV (625i)	50	1024×768	1024×576
SDTV (525p) (D2)	60	1024×768	1024×576
HDTV [»] (750p) 16:9 (D4)	60	1024×768	1024×576
HDTV (1125i) 16:9 (D3)	60	1024×768	1024×576

Composite Video/S-Video

Signal	Refresh rate [»] (Hz)	Resolutions (dots)	
		Aspect ratio [»] 4:3	Aspect ratio 16:9
TV (NTSC)	60	1024×768	1024×576
TV (PAL, SECAM)	50	1024×768	1024×576

FixYourDLP.com
Sponsored by DM

Discount-Merchant.com (800) 281-8860
THE TRUSTED SOURCE FOR PROJECTOR LAMPS AND ACCESSORIES



Specifications

Product name	EMP-745	EMP-737	EMP-740	EMP-732
Dimensions	276 (W) × 70 (H) × 193 (D) mm (not including feet)			
Panel size	0.7 inches			
Display method	Polysilicon TFT active matrix			
Resolution	XGA 786,432 pixels (1024 (W) × 768 (H) dots) × 3			
Focus adjustment	Manual			
Zoom adjustment	Manual (approx. 1:1.2)			
Lamp (light source)	UHE lamp, 170 W, Model No.: ELPLP32			
Max. audio output	1W monaural			
Speaker	1			
Power supply	100–240VAC 50/60Hz 2.7–1.1A			
Electric power consumption	Power Consumption Operating : 240W Standby Network OFF: 4W Network ON : 35W		Power Consumption Operating : 240W Standby: 4W	
Operating temperature	+5°– +35°C (No condensation)			
Storage temperature	-10°– +60°C (No condensation)			
Weight	Approx. 1.8 kg		Approx. 1.7 kg	
Connectors				
Computer/Component Video	1 Mini D-Sub 15-pin (female) Blue			
Audio	1 Stereo mini jack			
S-Video	1 Mini DIN 4-pin			
Video	1 RCA pin jack			
USB*1	2 USB connector (type A,B)		1 USB connector (type B)	
Card Slot*2	PCMCIA TypeII slot × 1		–	

*1 The USB connector is not guaranteed to operate correctly with all USB-compatible devices.

*2 Supported Memory Cards by Projector's Card Slot

- CompactFlash cards (using a PC card adapter)
- ATA Flash cards
- Memory Sticks (using a PC card adapter)
- Smart Media (using a PC card adapter)
- SD/MMC cards (using a PC card adapter)

FixYourDLP.com
 ScanIt-Merchant.com (800) 281-8860

THE TRUSTED SOURCE FOR PROJECTOR LAMPS AND ACCESSORIES



Pixelworks DNX™ ICs are used in this Projector.



Safety

USA

UL60950 Third Edition

Canada

CSA C22.2 No.60950

European Community

The Low Voltage Directive (73/23/EEC)

IEC60950 3rd Edition

EMC

USA

FCC Part15B Class B (DoC)

Canada

ICES-003 Class B

European Community

The EMC Directive (89/336/EEC)

EN55022, 1998 Class B

EN55024, 1998

IEC/EN61000-3-2, IEC/EN61000-3-3

Australia/New Zealand

AS/NZS CISPR 22:2002 Class B



Discount-Merchant.com (800) 281-8860

THE TRUSTED SOURCE FOR PROJECTOR LAMPS AND ACCESSORIES



Appearance

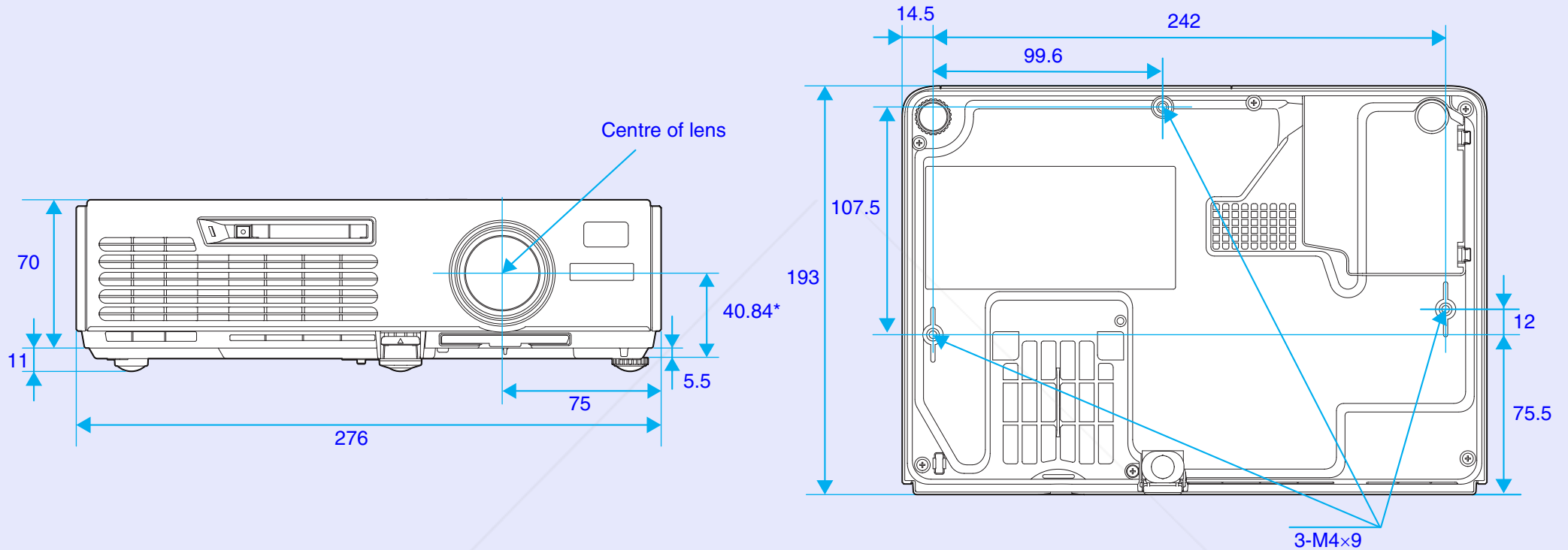

*Distance from center of lens to suspension bracket fixing point

Units: mm



Discount-Merchant.com (800) 281-8860
THE TRUSTED SOURCE FOR PROJECTOR LAMPS AND ACCESSORIES



DECLARATION of CONFORMITY

According to 47CFR, Part 2 and 15
Class B Personal Computers and Peripherals; and/or
CPU Boards and Power Supplies used with Class B
Personal Computers

We :EPSON AMERICA, INC.
Located at :3840 Kilroy Airport Way
MS: 3-13
Long Beach, CA 90806
Tel :562-290-5254

Declare under sole responsibility that the product identified herein, complies with 47CFR Part 2 and 15 of the FCC rules as a Class B digital device. Each product marketed, is identical to the representative unit tested and found to be compliant with the standards. Records maintained continue to reflect the equipment being produced can be expected to be within the variation accepted, due to quantity production and testing on a statistical basis as required by 47CFR 2.909. Operation is subject to the following two conditions : (1) this device may not cause harmful interference, and (2) this device must accept any interference received, including interference that may cause undesired operation.

Trade Name :EPSON
Type of Product :Projector
Model :EMP-745/740/737/732



Discount-Merchant.com (800) 281-8860

THE TRUSTED SOURCE FOR PROJECTOR LAMPS AND ACCESSORIES

FCC Compliance Statement For United States Users

This equipment has been tested and found to comply with the limits for a Class B digital device, pursuant to Part 15 of the FCC Rules. These limits are designed to provide reasonable protection against harmful interference in a residential installation. This equipment generates, uses, and can radiate radio frequency energy and, if not installed and used in accordance with the instructions, may cause harmful interference to radio or television reception. However, there is no guarantee that interference will not occur in a particular installation. If this equipment does cause interference to radio and television reception, which can be determined by turning the equipment off and on, the user is encouraged to try to correct the interference by one or more of the following measures.

- Reorient or relocate the receiving antenna.
- Increase the separation between the equipment and receiver.
- Connect the equipment into an outlet on a circuit different from that to which the receiver is connected.
- Consult the dealer or an experienced radio/TV technician for help.

WARNING

The connection of a non-shielded equipment interface cable to this equipment will invalidate the FCC Certification or Declaration of this device and may cause interference levels which exceed the limits established by the FCC for this equipment. It is the responsibility of the user to obtain and use a shielded equipment interface cable with this device. If this equipment has more than one interface connector, do not leave cables connected to unused interfaces. Changes or modifications not expressly approved by the manufacturer could void the user's authority to operate the equipment.



All rights reserved. No part of this publication may be reproduced, stored in a retrieval system, or transmitted in any form or by any means, electronic, mechanical, photocopying, recording, or otherwise, without the prior written permission of SEIKO EPSON CORPORATION. No patent liability is assumed with respect to the use of the information contained herein. Neither is any liability assumed for damages resulting from the use of the information contained herein.

Neither SEIKO EPSON CORPORATION nor its affiliates shall be liable to the purchaser of this product or third parties for damages, losses, costs, or expenses incurred by the purchaser or third parties as a result of: accident, misuse, or abuse of this product or unauthorized modifications, repairs, or alterations to this product, or (excluding the U.S.) failure to strictly comply with SEIKO EPSON CORPORATION's operating and maintenance instructions.

SEIKO EPSON CORPORATION shall not be liable against any damages or problems arising from the use of any options or any consumable products other than those designated as Original EPSON Products or EPSON Approved Products by SEIKO EPSON CORPORATION.

General Notice:

EPSON is a registered trademark of SEIKO EPSON CORPORATION.

EasyMP is a trademark of SEIKO EPSON CORPORATION.

Macintosh, Mac, and iMac are registered trademarks of Apple Computer, Inc.

IBM is a registered trademark of International Business Machines Corporation.

Windows and Windows NT are registered trademarks of Microsoft Corporation in the United States of America.

Dolby is a registered trademark of Dolby Laboratories.

Cisco Systems is a registered trademark of Cisco Systems Inc. in the United States of America and other countries.

Pixelworks and DNX are trademarks of Pixelworks Inc.

Portions of this software are based in part on the work of the Independent JPEG Group.

Portions Copyright©2003 Instant802 Networks Inc. All rights reserved.

Other product names used herein are also for identification purposes only and may be trademarks of their respective owners. EPSON disclaims any and all rights in those marks.

This product uses open source software.

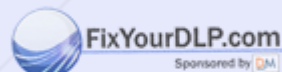

Discount-Merchant.com (800) 281-8860
THE TRUSTED SOURCE FOR PROJECTOR LAMPS AND ACCESSORIES



Disclaimer

This user manual is provided as a free service by FixYourDLP.com. FixYourDLP is in no way responsible for the content of this manual, nor do we guarantee its accuracy. FixYourDLP does not make any claim of copyright and all copyrights remain the property of their respective owners.

About FixYourDLP.com

FixYourDLP.com (<http://www.fixyourdpl.com>) is the World's #1 resource for media product news, reviews, do-it-yourself guides, and manuals.

Informational Blog: <http://www.fixyourdpl.com>

Video Guides: <http://www.fixyourdpl.com/guides>

User Forums: <http://www.fixyourdpl.com/forum>

FixYourDLP's Fight Against Counterfeit Lamps:

<http://www.fixyourdpl.com/counterfeits>

Sponsors:

RecycleYourLamp.org – Free lamp recycling services for used lamps:

<http://www.recycleyourlamp.org>

Lamp Research - The trusted 3rd party lamp research company:

<http://www.lampresearch.com>

Discount-Merchant.com – The worlds largest lamp distributor:

<http://www.discount-merchant.com>



FixYourDLP.com

Sponsored by 