



Disclaimer

This user manual is provided as a free service by FixYourDLP.com. FixYourDLP is in no way responsible for the content of this manual, nor do we guarantee its accuracy. FixYourDLP does not make any claim of copyright and all copyrights remain the property of their respective owners.

About FixYourDLP.com

FixYourDLP.com (<http://www.fixyourdlp.com>) is the World's #1 resource for media product news, reviews, do-it-yourself guides, and manuals.

Informational Blog: <http://www.fixyourdlp.com>

Video Guides: <http://www.fixyourdlp.com/guides>

User Forums: <http://www.fixyourdlp.com/forum>

FixYourDLP's Fight Against Counterfeit Lamps:

<http://www.fixyourdlp.com/counterfeits>

Sponsors:

RecycleYourLamp.org – Free lamp recycling services for used lamps:

<http://www.recycleyourlamp.org>

Lamp Research - The trusted 3rd party lamp research company:

<http://www.lampresearch.com>

Discount-Merchant.com – The worlds largest lamp distributor:

<http://www.discount-merchant.com>



FixYourDLP.com

Sponsored by 



User's Guide

Multimedia Projector

EB-826W

EB-825

EB-824

EB-85

EB-84





Discount-Merchant.com (800) 281-8860

THE TRUSTED SOURCE FOR PROJECTOR LAMPS AND ACCESSORIES





Notations Used in This Guide

- **Safety indications**

The documentation and the projector use graphical symbols to show how to use the projector safely. Please understand and respect these caution symbols in order to avoid injury to persons or property.

 Warning	This symbol indicates information that, if ignored, could possibly result in personal injury or even death due to incorrect handling.
 Caution	This symbol indicates information that, if ignored, could possibly result in personal injury or physical damage due to incorrect handling.

- **General information indications**

Attention	Indicates procedures which may result in damage or injury if sufficient care is not taken.
	Indicates additional information and points which may be useful to know regarding a topic.
	Indicates a page where detailed information regarding a topic can be found.
	Indicates that an explanation of the underlined word or words in front of this symbol appears in the glossary of terms. See the "Glossary" section of the "Appendix".  p.102
Procedure	Indicates operating methods and the order of operations. The procedure indicated should be carried out in the order of the numbered steps.
[(Name)]	Indicates the name of the buttons on the Remote Control or the Control panel. Example: [Return] button
"(Menu Name)" Brightness	Indicates Configuration Menu items. Example: Select "Brightness" from the Image menu. Image menu - Brightness

Notations Used in This Guide..... 2

Introduction

Projector Features..... 7

Features Common to Each Model.	7
Easy to handle.	7
Enhanced security functions.	7
EB-826W/825/85 Features.	8
Taking full advantage of a network connection.	8
Projecting JPEG images without connecting a computer.	8

Part Names and Functions..... 9

Front/Top.	9
Rear.	10
Base.	11
Control panel.	12
Remote Control.	13

Useful Functions

Changing the Projected Image..... 16

Automatically Detect Input Signal and Change the Projected Image (Source Search)	16
Switch to the target image by Remote Control.	17

Functions for Enhancing Projection..... 18

Selecting the Projection Quality (Selecting Color Mode).	18
Setting the Auto Iris.	19
Hiding the Image and Sound Temporarily (A/V Mute).	19
Freezing the Image (Freeze).	20
Changing the Aspect Ratio.	20
Changing methods.	20
Changing the Aspect for video equipment images.	21
Changing the Aspect for computer images (EB-825/824/85/84).	22

Changing the Aspect for computer images (EB-826W).	23
Pointer Function (Pointer).	25
Enlarging Part of the Image (E-Zoom).	26
Operating the Mouse Pointer by Remote Control (Wireless Mouse).	27

Security Functions..... 29

Managing Users (Password Protect).	29
Type of Password Protect.	29
Setting Password Protect.	29
Entering the Password.	30
Restricting Operation (Control Panel Lock).	31
Anti-Theft Lock.	32
Installing the wire lock.	32

Configuration Menu

Using the Configuration Menu..... 34

List of Functions..... 35

Image Menu.	35
Signal Menu.	36
Settings Menu.	37
Extended Menu.	39
Network Menu (EB-826W/825/85/84 only).	41
Notes on operating the Network menu.	42
Soft keyboard operations.	42
Basic Menu.	43
Wireless LAN Menu (EB-826W/825/85 only).	44
Security Menu (EB-826W/825/85 only).	45
When WEP is selected.	46
When WPA-PSK (TKIP) or WPA2-PSK (AES) is selected.	46
Wired LAN Menu.	47
Mail Menu.	48
Others Menu.	49
Reset Menu.	50
Info Menu (Display Only).	51
Reset Menu.	52



Troubleshooting

Using the Help.	54
Problem Solving.	55
Reading the Indicators.	55
⏻ Indicator is lit or flashing red.	56
🔊 Indicator is flashing or lit orange.	57
When the Indicators Provide No Help.	58
Problems relating to images.	59
Problems when projection starts.	63
Other problems.	63

Appendix

Installation Methods.	66
Cleaning.	67
Cleaning the Projector's Surface.	67
Cleaning the Lens.	67
Cleaning the Air filter.	67
Replacing Consumables.	68
Replacing the Remote Control Batteries.	68
Replacing the Lamp.	69
Lamp replacement period.	69
How to replace the Lamp.	69
Resetting the Lamp Hours.	72
Replacing the Air Filter.	72
Air filter replacement period.	72
How to replace the air filter.	72
Optional Accessories and Consumables.	75
Optional accessories.	75
Consumables.	75

Saving a User's Logo.	76
Screen Size and Projection Distance.	78
Projection Distance (EB-825/824/85/84).	78
Projection Distance (EB-826W).	78
Connecting and Removing USB Devices (EB-826W/825/824/85 only).	80
Connecting USB Devices.	80
Removing USB Devices.	81
Connecting with a USB cable and Projecting (USB Display).	82
Connecting.	82
Connecting for the first time.	83
From the second time.	84
Connecting a LAN Cable (EB-826W/825/85/84 only).	85
Installing the Wireless LAN Unit (EB-826W/825/85 only).	86
Connecting to External Equipment.	87
Connecting to an external monitor (EB-826W/825/85/84 only).	87
Connecting to an external speaker (EB-826W/825/85/84 only).	88
Connecting a microphone.	88
Reading Problem Mail Notification Function (EB-826W/825/85/84 only).	89
ESC/VP21 Commands.	90
Command List.	90
Cable Layouts.	90
Serial Connection.	90
Communications protocol.	91
About PjLink.	92
Supported Monitor Displays.	93
Supported Monitor Displays (EB-825/824/85/84).	93
Computer signals (analog RGB).	93
Component Video.	94



Composite Video/S-Video.	94
Supported Monitor Displays (EB-826W).	95
Computer signals (analog RGB).	95
Component Video.	96
Composite Video/S-Video.	96
Specifications.	97
Projector General Specifications.	97
Software Requirement.	99
Appearance.	101
Glossary.	102
General Notes.	104
General Notice:	104
Index.	120



Discount-Merchant.com (800) 281-8860
THE TRUSTED SOURCE FOR PROJECTOR LAMPS AND ACCESSORIES



Introduction

This chapter explains the projector's features and the part names.





Discount-Merchant.com (800) 281-8860
THE TRUSTED SOURCE FOR PROJECTOR LAMPS AND ACCESSORIES

Features Common to Each Model

Easy to handle

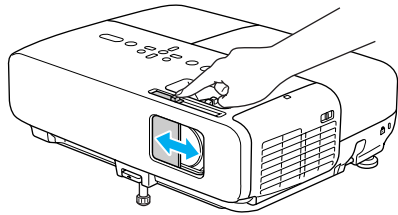
- **The A/V mute slide knob makes it easy to project and store**
You can stop and resume projection easily by opening and closing the A/V mute slide knob which makes giving clear presentations easier.



- **A single foot design means you do not have to make any difficult leveling adjustments**
You can easily make height adjustments with one hand.  *Quick Start Guide*

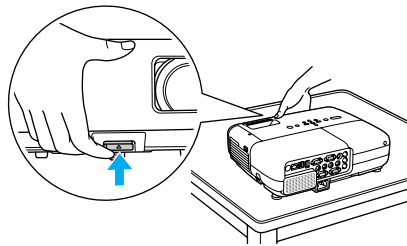

- **No cool down delay**
After turning the projector's power off, you can disconnect the projector's power cable without having to wait for the projector to cool down.

- **Projection screen for WXGA (EB-826W)**

With a computer that has a 16:10 WXGA wide LCD display, the image can be projected in the same aspect. You can use whiteboards and other landscape format screens.

- **Enlarge and project your files with the Document Camera**

A USB compatible Document Camera is available as an optional extra. With this Document Camera there is no need for a power cable. You can connect easily with one USB cable, and its clean design really simplifies projecting and enlarging your documents.

- **Connecting with a USB cable and Projecting (USB Display)**

Simply by connecting the projector to a Windows Computer with the supplied USB cable you can project images from the computer screen.

 [p.82](#)

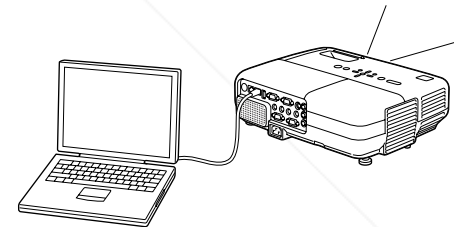

Enhanced security functions

- **Password Protect to restrict and manage users**

By setting a Password you can restrict who can use the projector.

 [p.29](#)

- **Control Panel Lock restricts button operation on the Control panel**

You can use this to prevent people changing projector settings without permission at events, in schools, and so on.  [p.31](#)

- **Equipped with various anti-theft devices**

The projector is equipped with the following types of anti-theft security devices.  [p.32](#)

- Security slot
- Security cable installation point

EB-826W/825/85 Features

Taking full advantage of a network connection

You can make effective use of your network by using the supplied "EPSON Projector Software for Meeting & Monitoring" to perform efficient and varied presentations and meetings.  [Projector Operation Guide](#)

- **Connect a Computer to the projector via a network**

You can project by connecting to an already constructed network system. You can hold efficient meetings by projecting from multiple computers connected to a network system without having to change any cables.

- **Connecting wirelessly to a computer**

When you install the optional wireless LAN unit in the projector, you can connect wirelessly to a computer.

- **Connection method for various networks**

The following methods are available for connecting the projector to a network. Select whichever method suites your environment.

 [Projector Operation Guide](#)

- **Advanced Connection Mode**

Advanced Connection Mode is an infrastructure connection, offering you a method of connecting to an already constructed network.

- **Quick Connection Mode**

Quick Connection Mode is a connection method that can only be executed when the optional wireless LAN unit is installed.

Quick Connection Mode temporarily allocates the projector's SSID to the computer in ad-hoc mode, and restores the computer's network settings after disconnecting.

- **Network connection using Quick Wireless Connection USB Key**

Using the optional Quick Wireless Connection USB Key, you can quickly connect a computer to the projector for projection.

Projecting JPEG images without connecting a computer

You can project a slideshow of JPEG images saved on a USB device such as a USB compatible digital camera, hard disk, or USB memory by simply connecting to the projector.  [Projector Operation Guide](#)









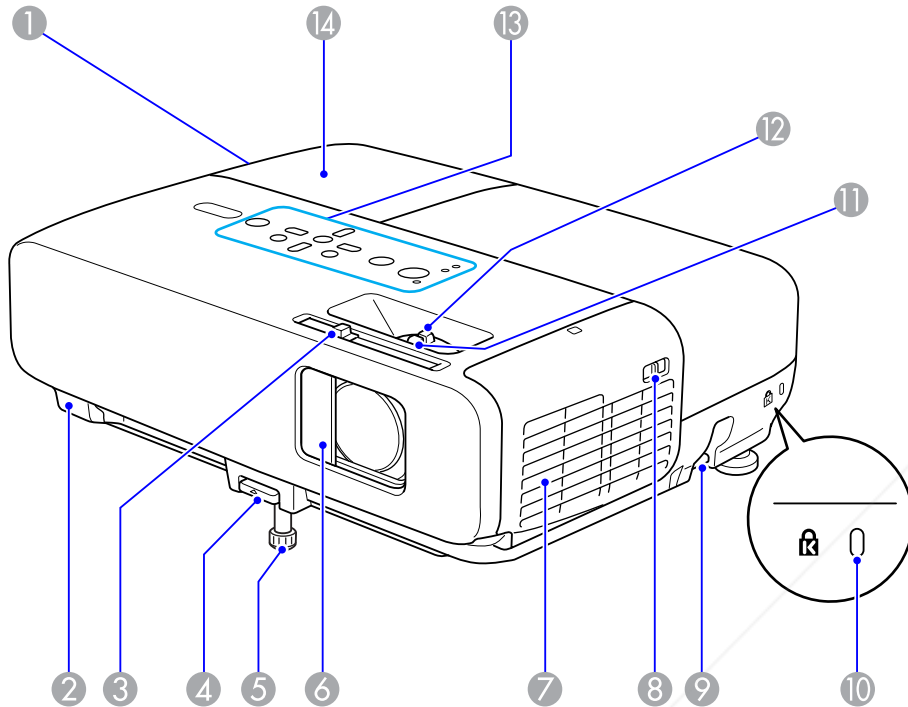







Discount-Merchant.com (800) 281-8860

THE TRUSTED SOURCE FOR PROJECTOR LAMPS AND ACCESSORIES

Front/Top









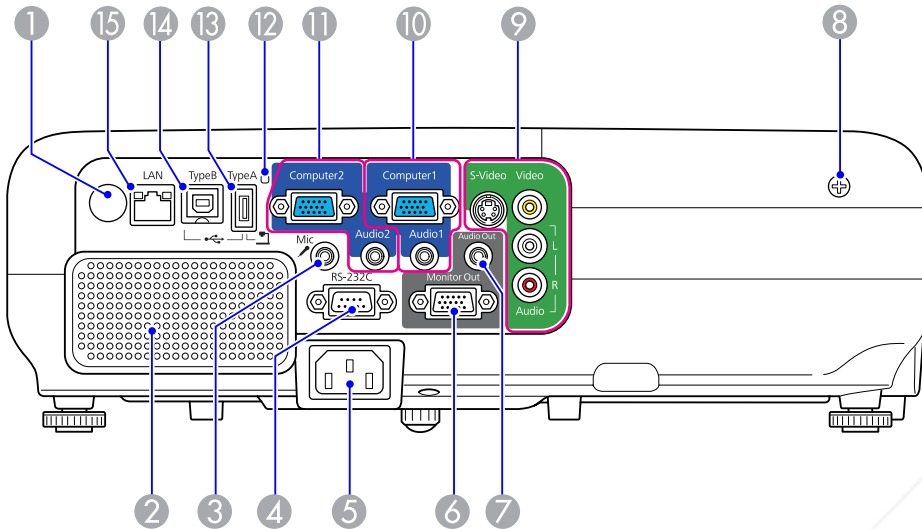



Name	Function
1 Air exhaust vent	Exhaust vent for air used to cool the projector internally. <div style="border: 1px solid black; padding: 5px; margin-top: 10px;">  <p>Caution Do not place objects that may become warped or otherwise affected by heat near the Air exhaust vent and do not put your face or hands near the vent while projection is in progress.</p> </div>
2 Remote Receiver	Receives signals from the remote control.  Quick Start Guide





Name	Function
3 A/V mute slide knob	Slide the knob to open and close the A/V mute slide knob.
4 Foot adjust lever	Pull out the Foot adjust lever to extend and retract the Front adjustable foot.  Quick Start Guide
5 Front adjustable foot	Extend and adjust the position of the projected image when the projector is placed on a surface such as a desk.  Quick Start Guide
6 A/V mute slide knob	Slide shut when not using the projector to protect the lens. By closing during projection you can hide the image and the sound (A/V Mute).  Quick Start Guide ,  p.19
7 Air intake vent (Air filter)	Takes in air to cool the projector internally. If dust collects here it can cause the internal temperature to rise, and this can lead to problems with operation and shorten the optical engine's service life. Be sure to clean the Air filter regularly.  p.67, p.72
8 Air filter cover open/close switch	Opens and closes the air filter cover.  p.72 Open this cover when installing the optional Wireless LAN unit.
9 Security cable installation point	Pass a commercially available wire lock through here and lock it in place.  p.32
10 Security slot	The Security slot is compatible with the Microsaver Security System manufactured by Kensington.  p.32
11 Focus ring	Adjusts the image focus.  Quick Start Guide
12 Zoom ring	Adjusts the image size.  Quick Start Guide
13 Control panel	 p.12
14 Lamp cover	Open this cover when replacing the projector's Lamp.  p.69

Rear





Name	Function
1 Remote Receiver	Receives signals from the remote control.  Quick Start Guide
2 Speaker	Outputs audio from the Mic Input Port and the image currently being projected.
3 Mic Input Port	Connects to a microphone.  p.88
4 RS-232C Port	When controlling the projector from a computer, connect it to the computer with an RS-232C cable. This port is for control use and should not normally be used.  p.90
5 Power inlet	Connect  the power cable.  Quick Start Guide
6 Monitor Out Port (EB-826W/825/85/84 only)	Outputs to an external monitor the image signal from the computer connected to the Computer1/2 input port. This is not available for Component Video signals or other signals being input to any port other than the Computer1/2 input port.  p.87

Name	Function
7 Audio Out Port (EB-826W/825/85/84 only)	Outputs the image currently being projected and audio from the Mic Input Port to an external speaker.  p.88
8 Lamp Cover Fixing Screw	Screw to fix the Lamp cover in place.  p.69
9 S-Video Input Port	For S-video signals from video sources.
Video Input Port	For composite video signals from video sources.
Audio-L/R input port	Connects to the audio out port when you want to output audio from equipment connected to the S-Video Input Port or the Video Input Port.  Quick Start Guide
10 Computer1 Input Port	For video signals from a computer and component video signals from other video sources.
Audio1 Port	Connects to the audio out port when you want to output audio from equipment connected to the Computer1 Input Port.  Quick Start Guide
11 Computer2 Input Port	For video signals from a computer and component video signals from other video sources.
Audio2 Port	Connects to the audio out port when you want to output audio from equipment connected to the Computer2 Input Port. Also, when you want to output audio from the projector for the following Sources, connect the audio source to the Audio2 port. - USB: When playing back a Slideshow from a USB storage device connected to USB port (TypeA), or when projecting from the optional Document Camera - USB Display - LAN  Quick Start Guide

Name	Function
12 USB indicator (EB-826W/825/824/85 only)	The following explains the status of USB devices connected to USB port. (TypeA). OFF: USB device is not connected Orange Light ON: USB device is connected Green Light ON: USB device is operating Red Light ON: Error
13 USB Port (TypeA) (EB-826W/825/824/85 only)	Projects a JPEG image Slideshow when memories or digital cameras are connected to the USB compatible port.  Projector Operation Guide Also when the optional Document Camera is connected.
14 USB Port (TypeB)	Connects the projector to a computer via the supplied USB cable, and the image on the computer is projected.  p.82 Also use this port to connect to a computer via the supplied USB cable to use the wireless mouse function.  p.27
15 LAN Port (EB-826W/825/85/84 only)	Connects to a LAN cable and then to a network.  p.85

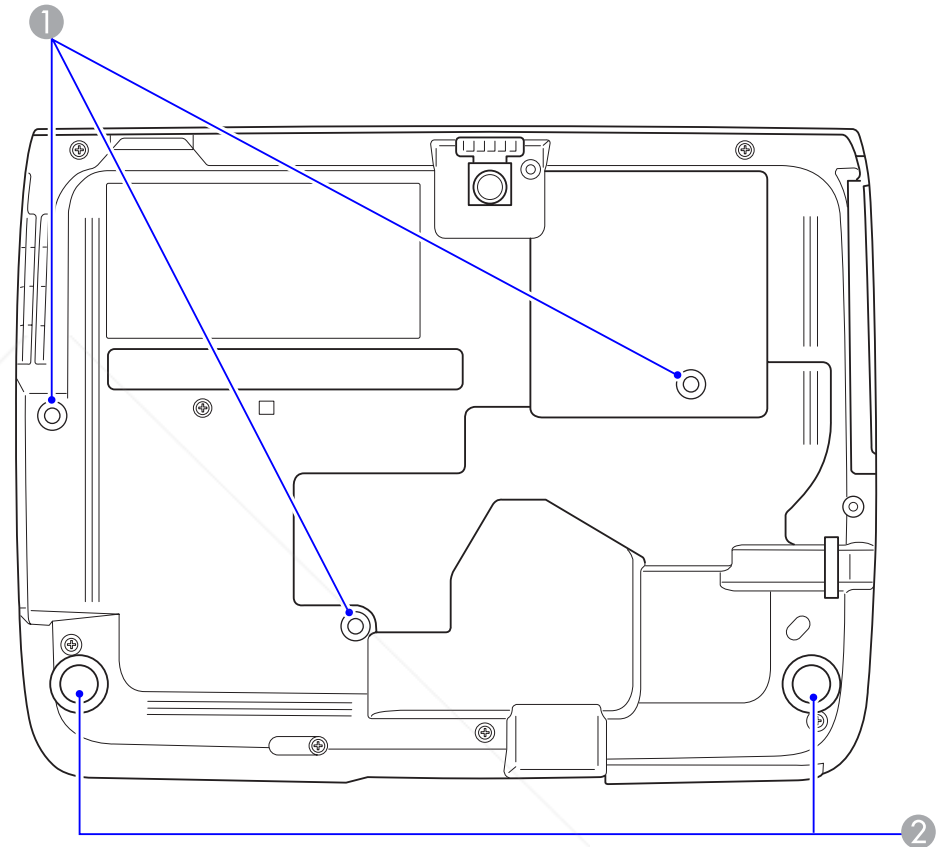



Base



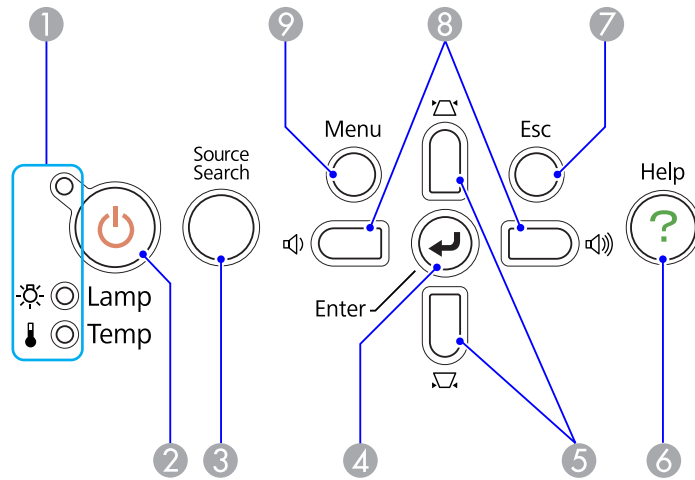



Name	Function
1 Ceiling mount fixing points (3 points)	Attach the optional Ceiling mount here when suspending the projector from a ceiling.  p.66 , p.75
2 Rear foot	When setup on a desk, turn to extend and retract to adjust the horizontal tilt.  Quick Start Guide

Control panel









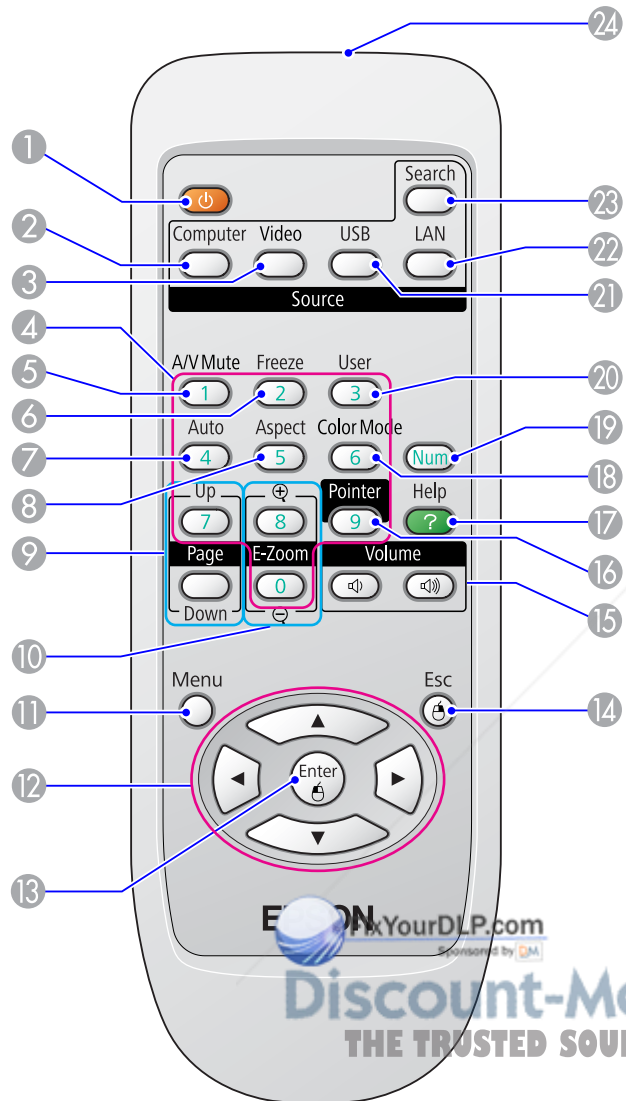



Name	Function
1 Status indicators	The color of the indicators and whether they are flashing or lit indicate the status of the projector.  p.55
2 [Power] button	Turns the projector power on or off.  Quick Start Guide
3 [Source Search] button	Changes to the next input source that is connected to the projector and is sending an image.  p.16
4 [Enter] button	If pressed during projection of computer signal images, it automatically adjusts the Tracking, Sync., and Position to project the optimum image. When a Configuration Menu or a Help screen is displayed, it accepts and enters the current selection and moves to the next level.  p.34



Name	Function
5 [Up/Down] button	Corrects Keystone distortion. In the following cases, however, these buttons only have the [▲] and [▼] functions. - When the projected image is being sent through a Network connection - When the Slideshow function is being used for projection If pressed when a Configuration Menu or a Help screen is displayed, these buttons select menu items and setting values.  Quick Start Guide , p.34
6 [Help] button	Displays and closes the Help screen which shows you how to deal with problems if they occur.  p.54
7 [Return] button	Stops the current function. If pressed when a configuration menu is displayed, it moves to the previous menu level.  p.34
8 [Left/Right] button	Adjusts the volume. If pressed while a Configuration Menu or a Help screen is displayed, these buttons only have the [◀] and [▶] functions which select menu items and setting values.  Quick Start Guide , p.34
9 [Menu] button	Displays and closes the Configuration Menu.  p.34

Remote Control



Name	Function
① [Power] button	Turns the projector power On or Off. Quick Start Guide
② [Computer] button	Each time the button is pressed, the image changes from the Computer1 input port to the Computer2 input port. p.17
③ [Video] button	Each time the button is pressed, the image changes from the Video input port to the S-Video input port. p.17
④ Numeric buttons	Use when entering a password. p.29
⑤ [A/V Mute] button	Turns the video and audio on or off. p.19
⑥ [Freeze] button	Images are paused or unpaused. p.20
⑦ [Auto] button	If pressed during projection of computer signal images, it automatically adjusts the Tracking, Sync., and Position to project the optimum image.
⑧ [Aspect] button	The Aspect Ratio changes each time the button is pressed. p.20
⑨ [Page] buttons (Up) (Down)	Moves the Page Up/Down when using the Wireless Mouse function, or projecting a PowerPoint file or a scenario from LAN as the Source. The LAN Source is only available on the EB-826W/825. p.27, Projector Operation Guide
⑩ [E-Zoom] buttons (⊕)(⊖)	(⊕) Enlarges the image without changing the projection size. (Reduces parts of images that have been enlarged using the (⊖) [⊕] button. p.26
⑪ [Menu] button	Displays and closes the Configuration Menu. p.34
⑫ [Navigation] button	When a Configuration Menu or Help screen is displayed, it selects menu items and setting values. p.34, p.54 During Wireless Mouse function, the mouse pointer moves in the direction the button is pushed. p.27

Name	Function
13 [Enter] button	When a Configuration Menu or a Help screen is displayed, it accepts and enters the current selection and moves to the next level.  p.34, p.54 Acts as a mouse's left button when using the Wireless Mouse function.  p.27
14 [Return] button	Stops the current function. If pressed when a Configuration Menu is displayed, it moves to the previous level.  p.34, p.54 Acts as a mouse's right button when using the Wireless Mouse function.  p.27
15 [Volume] buttons (◀) (▶)	(◀) Decreases the Volume. (▶) Increases the Volume.  <i>Quick Start Guide</i>
16 [Pointer] button	Press to activate the on screen Pointer.  p.25
17 [Help] button	Displays and closes the Help screen which shows you how to deal with problems if they occur.  p.54
18 [Color Mode] button	Each time the button is pressed, the Color Mode changes.  p.18
19 [Num] button	Use when entering a Password.  p.29
20 [User] button	Press to assign a frequently used item from the five available Configuration Menu items. By pressing the button the assigned menu item selection/adjustment screen is displayed, allowing you to make one-touch settings/adjustments.  p.37 Brightness Control is assigned as the default setting.
21 [USB] button	Each time the button is pressed, it changes to the image from equipment connected to USB Display/USB port (TypeA). Only changes to USB Display when using the EB-84.  p.17

Name	Function
22 [LAN] button	Changes to the EMP NS Connection image.(EB-826W/825/85 only)  p.17 When using EB-824/84, this does not function even if the button is pressed.
23 [Search] button	Changes to the next input source that is connected to the projector and is sending an image.  p.16
24 Remote control light-emitting area	Outputs remote control signals.



Useful Functions

This chapter explains useful tips for giving presentations, and the Security functions.



Discount-Merchant.com (800) 281-8860
THE TRUSTED SOURCE FOR PROJECTOR LAMPS AND ACCESSORIES

You can change the projected image in the following two ways.

- Changing by Source Search

The projector automatically detects signals being input from connected equipment, and the image being input from the equipment is projected.

- Changes to the target image.

You can use the Remote Control buttons to change to the target input port.

- 5 USB Display

- 6 USB: When image is from a device connected to USB Port (TypeA).

- 7 LAN: When the projector is connected to a computer via a network, and images from EMP NS Connection are projected.

Skipped when no image signal is being input.

Only EB-826W/825/824/85 can switch to USB.

Only EB-826W/825/85 can switch to LAN.

Automatically Detect Input Signal and Change the Projected Image (Source Search)

You can project the target image quickly as input ports with no image signal being input are ignored when you change by pressing the [Source Search] button.

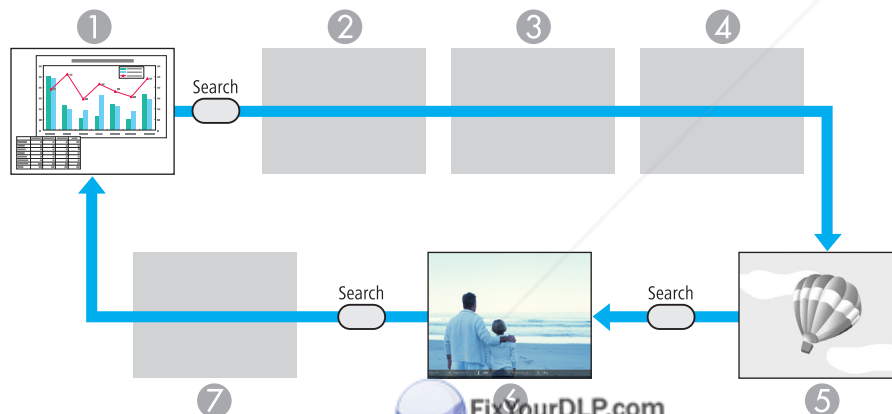

- 1 Computer1
- 2 Computer2
- 3 S-Video
- 4 Video

Procedure

When your video equipment is connected, start playback before beginning this operation.

Using the Remote Control

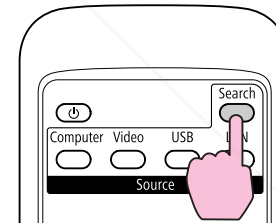

Using the Control panel

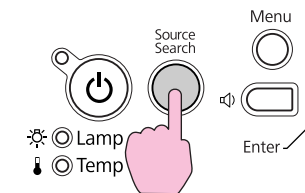

When two or more pieces of equipment are connected, press the [Source Search] button until the target image is projected.

FixYourDLP.com
Sponsored by DM

Discount-Merchant.com (800) 281-8860
THE TRUSTED SOURCE FOR PROJECTOR LAMPS AND ACCESSORIES



The following screen showing the status of image signals is displayed when only the image that the projector is currently displaying is available, or when no image signal can be found. You can select the input port where the equipment you want to use is connected. If no operation is performed after about 10 seconds, the screen closes.

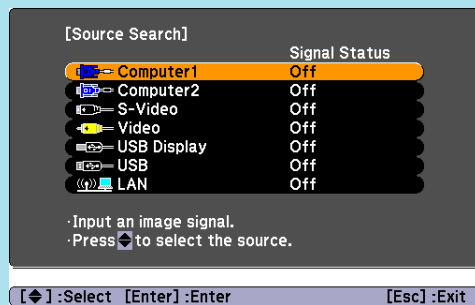

USB is only displayed for EB-826W/825/824/85.
LAN is only displayed for EB-826W/825/85.

Switch to the target image by Remote Control

You can change directly to the target image by pressing the following buttons on the Remote Control.

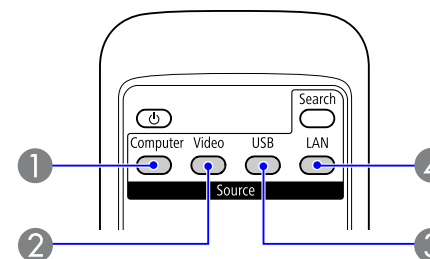

Remote Control



- ① Each time the button is pressed, the image changes from the Computer1 input port to the Computer2 input port.
- ② Each time the button is pressed, the image changes from the Video input port to the S-Video input port.
- ③ Each time the button is pressed, it changes to the image from equipment connected to USB Display/USB port (TypeA). Only changes to USB Display when using the EB-84.
- ④ When the projector is connected to a computer via a network, you can switch to images projected from EMP NS Connection.(EB-826W/825/85 only)
When using EB-824/84, this does not function even if the button is pressed.

Selecting the Projection Quality (Selecting Color Mode)

You can easily obtain the optimum image quality simply by selecting the setting that best corresponds to your surroundings when projecting. The brightness of the image varies depending on the mode selected.

Mode	Application
Dynamic	Ideal for use in a bright room. This is the brightest mode, and reproduces shadow tones well. If you are worried about image delays during projection for games involving speed, try turning off Progressive in the Configuration Menu.  p.36
Presentation	Ideal for making presentations using color materials in a bright room.
Theatre	Ideal for watching films in a dark room. Gives images a natural tone.
Photo	(When the computer image input and the Source are USB or LAN.) Ideal for projecting still pictures, such as photos, in a bright room. The images are vivid and brought into contrast.
Sports	(When Component Video, S-Video, or composite video images are input) Ideal for watching TV programmes in a bright room. The images are vivid and brought to life.
sRGB 	Ideal for images that conform to the sRGB color standard.
Blackboard	Even if you are projecting onto a Blackboard (greenboard), this setting gives your images a natural tint, just like when projecting onto a screen.
Whiteboard	Ideal for making presentations using black-and-white materials in a bright room.

Procedure

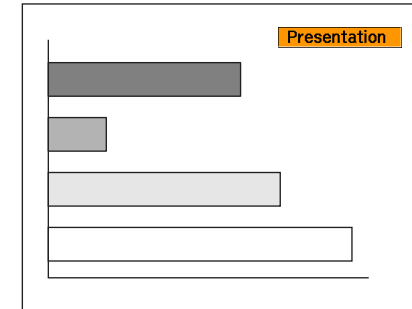
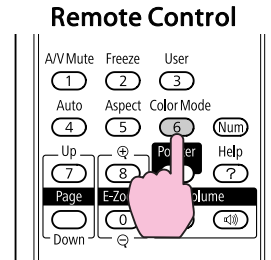

Each time you press the button, the Color Mode name is displayed on the screen and the Color Mode changes.
If you press the button while the Color Mode name is displayed on the screen, it changes to the next Color Mode.



The color mode can also be set using **Color Mode** in the **Image** menu from the Configuration Menu.  p.35

Setting the Auto Iris

By automatically setting the luminance according to the brightness of the displayed image, it lets you enjoy deep and rich images.

Procedure

- 1 Press the [Menu] button and select Image - Auto Iris from the Configuration Menu.  "Using the Configuration Menu"

Using the Remote Control

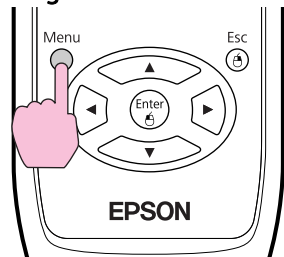

Using the Control panel

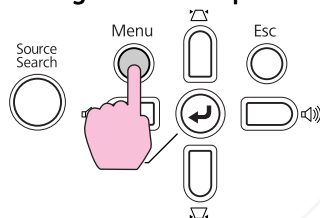

- 2 Select On.

The setting is stored for each Color Mode.

- 3 Press the [Menu] button to close the Configuration Menu.



Auto Iris can be set only when the Color Mode is Dynamic or Theatre.



Procedure

Remote Control

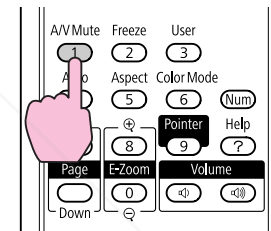

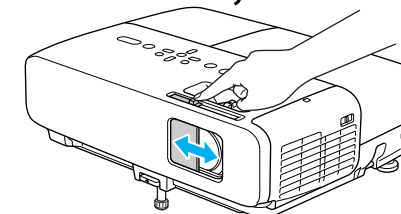

Body



Each time you press the button, or open/close the lens cover A/V Mute turns on or off.



- If you use this function when projecting moving images, the images and sound continue to be played back by the source, and you cannot return to the point where A/V Mute was activated.
- You can choose to display **Black**, **Blue**, or **Logo** as the A/V Mute display using the **Extended - Display - A/V Mute** setting from the configuration menu.  p.39
- When the A/V mute slide knob is closed, or when no operations are made for approximately 30 minutes, Sleep Mode activates and the power is automatically turned off. If you do not want Sleep Mode to activate, change the **Lens Cover Timer** setting to **Off** from **Operation** in the **Extended** menu.  p.39

Hiding the Image and Sound Temporarily (A/V Mute)

You can use this when you want to focus the audience's attention on what you are saying, or if you do not want to show details such as when you are changing between files during presentations from a computer.

Freezing the Image (Freeze)

When the moving image on the screen is frozen, the image continues to project, so you can project a moving image one frame at a time like a still photo. Also, you can perform operations such as changing between files during presentations from a computer without projecting any images if the freeze function is activated beforehand.

Procedure

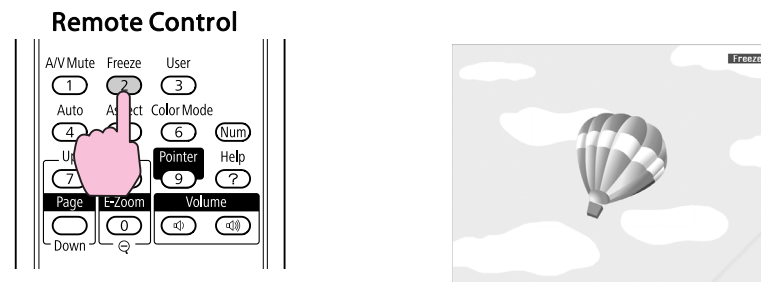

Each time you press the button, Freeze turns on or off.



- Audio does not stop.
- The image source continues to play back the moving images even while the screen is frozen, and so it is not possible to resume projection from the point where it was paused.
- If the [Freeze] button is pressed while the Configuration Menu or a Help screen is displayed, the menu or Help screen being displayed is cleared.
- Freeze still works while a menu is being used.

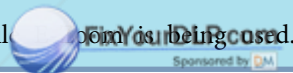

Changing the Aspect Ratio

Change the Aspect Ratio when video equipment is connected so that images that have been recorded in digital video or onto DVDs can be viewed in 16:9 wide-screen format. Change the Aspect Ratio when projecting computer images at full size.

The changing methods and the types of Aspect ratio are as follows.

Changing methods

Procedure

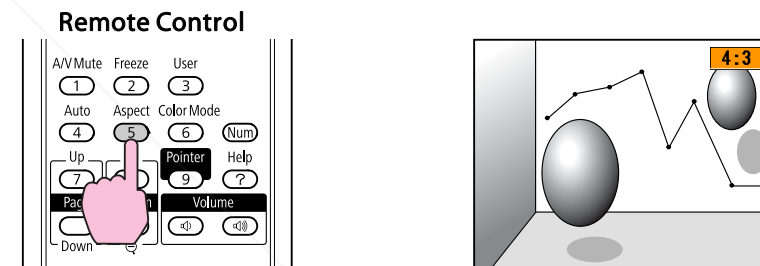

Each time you press the button, the Aspect name is displayed on the screen and the Aspect changes.

If you press the button while the Aspect name is displayed on the screen, it changes to the next Aspect Mode.



The color mode can also be set using **Aspect** in the **Signal** menu from the Configuration Menu.  p.36

Changing the Aspect for video equipment images

- ④ Through
- ⑤ Zoom

EB-825/824/85/84

Each time you press the button, it switches between 4:3 and 16:9.

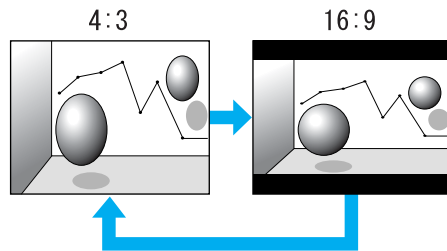

EB-826W

Each time the button is pressed, it changes in the order Normal, 16:9, Full, Zoom, and Through.

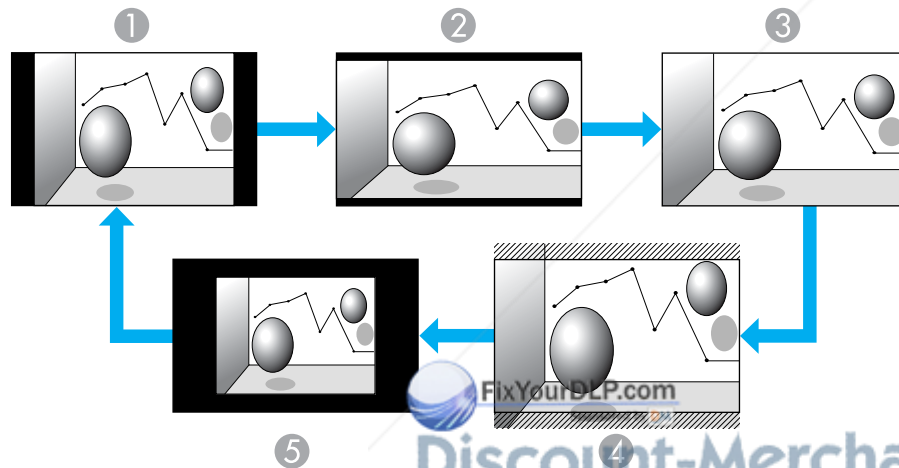



- ① Normal
- ② 16:9
- ③ Full

Discount-Merchant.com (800) 281-8860
THE TRUSTED SOURCE FOR PROJECTOR LAMPS AND ACCESSORIES

Changing the Aspect for computer images (EB-825/824/85/84)

You can change the Aspect as follows.

Set Values	Operation	Projection example
Normal	Projects to the full projection size retaining the Aspect of the input image.	
4:3	Projects to the full projection size at an Aspect of 4:3. This is ideal for when you want to project images at an Aspect of 5:4 (1280 x 1024) to the full projection size.	When a 1280x1024 signal is input 
16:9	Projects at a 16:9 Aspect. This is ideal for projecting at full screen size when using a 16:9 screen.	When a 1280x1024 signal is input 



If parts of the image are missing, set **Wide** or **Normal** in **Resolution** from the Configuration Menu depending on the size of the computer panel.

 p.36

Changing the Aspect for computer images (EB-826W)

You can change the Aspect as follows. EB-826W offers WXGA 1280x800 resolution (Aspect Ratio 16:10). When projecting onto 16:9 screens, set the Aspect to 16:9.

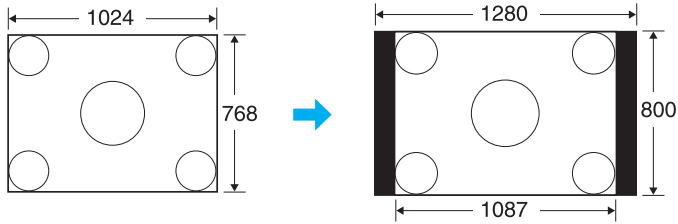
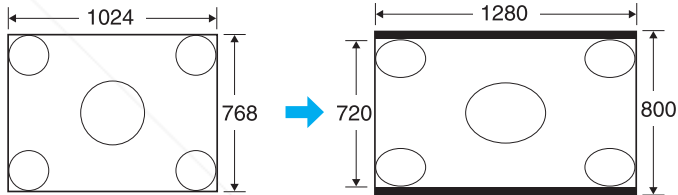
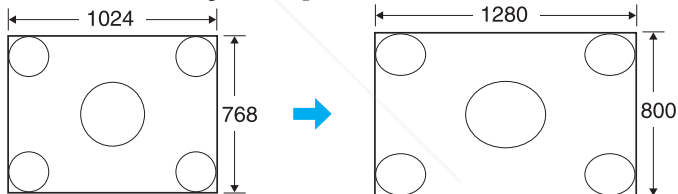
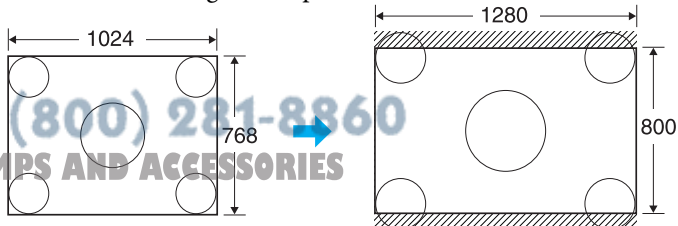
Set Values	Operation	Projection example
Normal	Projects to the full projection size retaining the Aspect of the input image.	When a 1024x768 signal is input 
16:9	Projects to the full projection size at an Aspect of 16:9.	When a 1024x768 signal is input 
Full	Project at full size.	When a 1024x768 signal is input 
Zoom	Projects the input image at the lateral direction aspect size as it is. Parts that extend beyond the projection size are not projected.	When a 1024x768 signal is input 

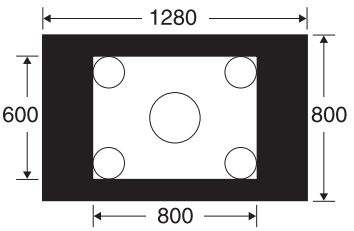
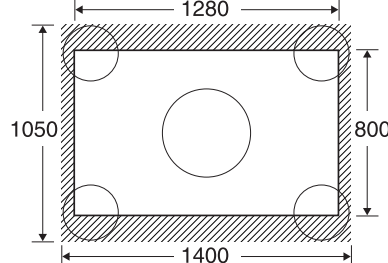
Set Values	Operation	Projection example	
<p>Through</p>	<p>Projects at the resolution of the input image size to the center of the screen. This is ideal for projecting clear images. If the image resolution exceeds 1280x800, the edges of the image are not projected.</p>	<p>When an 800x600 signal is input</p> 	<p>When an 1400x1050 signal is input</p> 



If parts of the image are missing, set **Wide** or **Normal** in **Resolution** from the Configuration Menu depending on the size of the computer panel. [p.36](#)

Pointer Function (Pointer)

This allows you to move a Pointer icon on the projected image, and helps you draw attention to the area you are talking about.

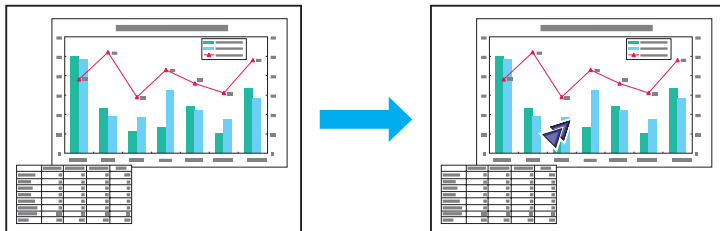

Procedure

1 Display the Pointer.

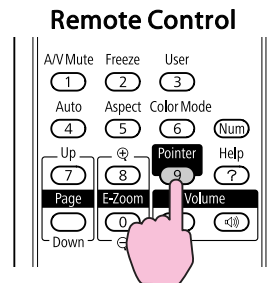

Each time you press the button, the pointer appears or disappears.

2 Move the Pointer icon (↖).

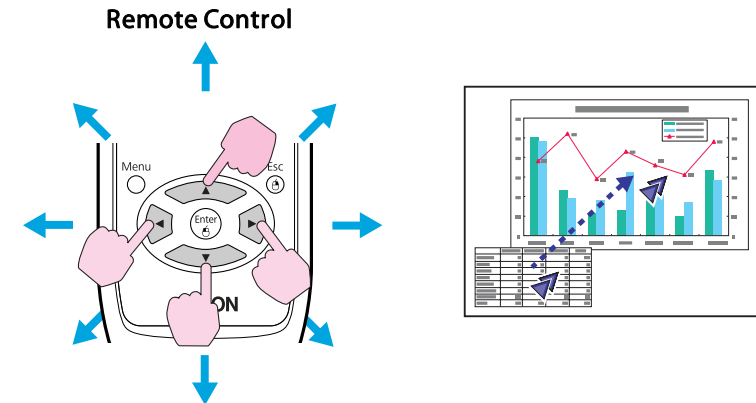

When pressed in conjunction with the adjacent [↕], [↔], [↖], and [↗] buttons, the pointer can be moved diagonally in addition to up/down and left/right.



You can choose from three different kinds of Pointer icon (↖, ↗, or ↘) in **Settings - Pointer Shape** from the Configuration Menu.

[p.37](#)

Enlarging Part of the Image (E-Zoom)

This is useful when you want to expand images to see them in greater detail, such as graphs and tables.

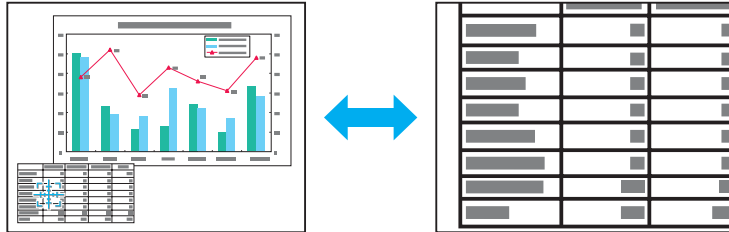

Procedure

- 1 Start E-Zoom.

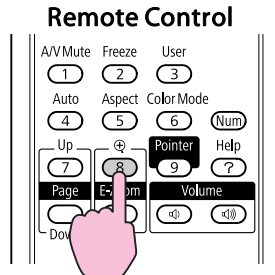

- 2 Move the to the area of the image that you want to enlarge.

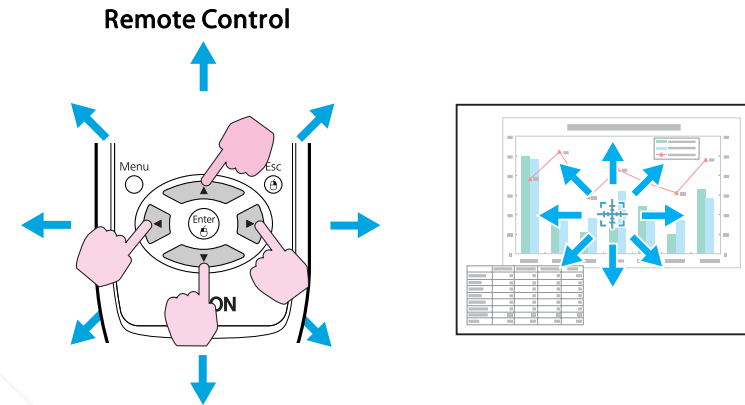

When pressed in conjunction with the adjacent [], [], [], and [] buttons, the pointer can be moved diagonally in addition to up/down and left/right.

3 Enlarge.

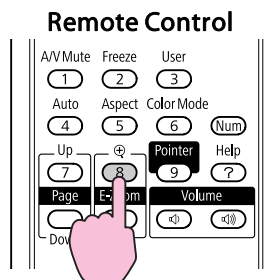

Each time the button is pressed, the area is expanded. You can expand quickly by holding the button down. You can reduce the enlarged image by pressing the [E-Zoom] button. Press the [Return] button to cancel.



- The enlargement ratio appears on the screen. The selected area can be enlarged to between 1 to 4 times in 25 incremental steps.
- Press the [Up], [Down], [Left], or [Right] buttons to scroll the image.
- If E-Zoom is selected, Progressive and Noise Reduction are cancelled.

can use the projector's Remote Control like a Wireless Mouse to control the computer's mouse pointer.

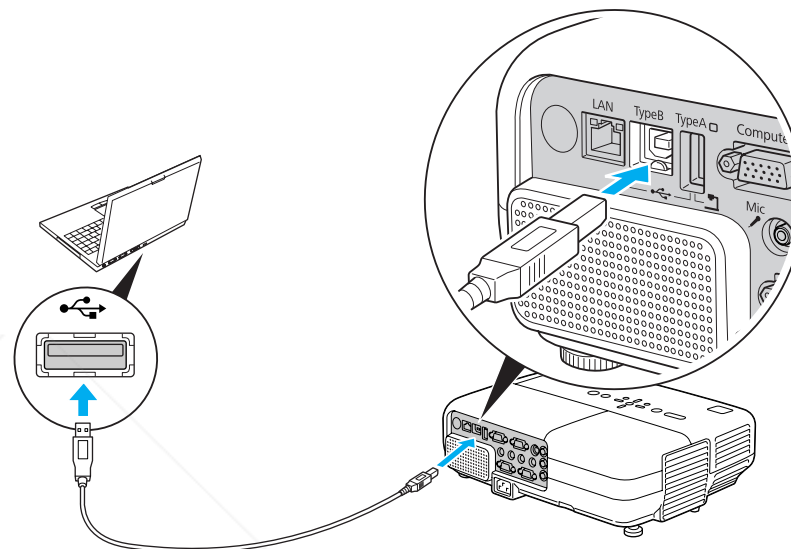

Compatible OS

Windows: 98/98SE/2000/Me/XP Home Edition/
XP Professional/Vista Home Basic/Vista Home Premium/
Vista Business/Vista Enterprise/Vista Ultimate

Macintosh: Mac OS X 10.3 to 10.5

Operating the Mouse Pointer by Remote Control (Wireless Mouse)

To activate the Wireless Mouse function, set USB Type B to Wireless Mouse from Extended in the Configuration Menu. By default, USB Type B is set to USB Display. Change the setting beforehand. [p.39](#)

When the USB port of a computer and the USB port TypeB on the rear of the projector are connected with the supplied USB cable, you



- It may not be possible to use the Wireless Mouse function under some versions of both the Windows and Macintosh operating systems.
- Some computer settings may have to be changed in order for the mouse function to be used. Consult the documentation for the computer for further details.

Once the connection has been made, the mouse pointer can be operated as follows.

Moving the mouse pointer

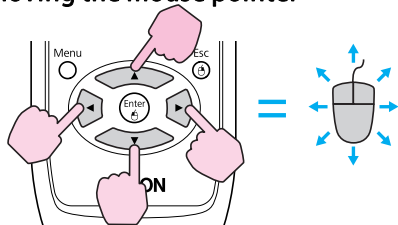

Mouse clicks

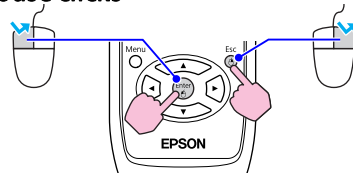

Left click: Press the Enter button.
 Right click: Press the Return button.
 Double click: Press quickly twice.

Drag and drop

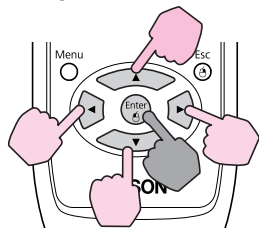

: Keep pressed

1. While holding down the [Enter] button, press the [Up], [Down], [Left], or [Right] button.
2. Release the [Enter] button to drop at the desired location.

Switch PowerPoint screens

This is useful for displaying the previous or next slide in a PowerPoint Slideshow.

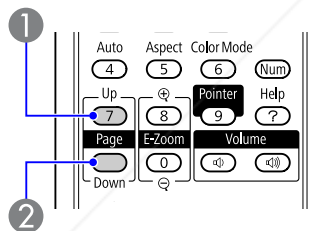

- 1 To previous slide
- 2 To next slide



- When pressed in conjunction with the adjacent [Up], [Down], [Left], and [Right] buttons, the pointer can be moved diagonally in addition to up/down and left/right.
- If the mouse button settings are set to reverse on the computer, the operation of the Remote Control buttons will also be reversed.
- The Wireless Mouse function cannot be used while the following functions are being used.
 - While the Configuration Menu is being displayed
 - While a Help menu is being displayed
 - While the E-Zoom function is being used
 - While a User's Logo is being captured
 - While the Pointer function is being used
 - While the Volume is being adjusted
 - While USB Display is being operated
 - While a Test Pattern is being displayed
 - While Color Mode is being set
 - While the Source name is being displayed





FixYourDLP.com
 Sponsored by DLP

Discount-Merchant.com (800) 281-8860

THE TRUSTED SOURCE FOR PROJECTOR LAMPS AND ACCESSORIES

The projector has the following enhanced security functions.

- **Password Protect**
You can limit who can use the projector.
- **Control Panel Lock**
You can prevent people changing the settings on the projector without permission.  [p.31](#)
- **Anti-Theft Lock**
The projector is equipped with various types of anti-theft security devices.  [p.32](#)

2. **User's Logo Protect**

Even if someone tries to change the User's Logo set by the owner of the projector, it cannot be changed. When **User's Logo Protect** is set to **On**, the following setting changes for the User's Logo are prohibited.

- Capturing a User's Logo
- Settings for **Display Background**, **Startup Screen**, and **A/V Mute** from **Display** in the Configuration Menu.

3. **Network Protect** (EB-826W/825/85/84 only)

When **Network Protect** is set to **On** setting changes for **Network** in the Configuration Menu are prohibited.

Managing Users (Password Protect)

When Password Protect is activated, people who do not know the Password cannot use the projector to project images even if the projector power is on. Furthermore, the user's logo that is displayed when you turn on the projector cannot be changed. This acts as an anti-theft device as the projector cannot be used even if it is stolen. At the time of purchase, Password Protect is not activated.

Type of Password Protect

The following three kinds of Password Protect settings can be made according to how the projector is being used.

1. **Power On Protect**

When **Power On Protect** is **On**, you are required to enter a preset Password after the projector is plugged in and turned on (this also applies to Direct Power On). If the correct Password is not entered, projection does not start.

Setting Password Protect

Use the following procedure to set Password Protect.

Procedure

- 1 During projection, hold down the [Freeze] button for about five seconds.

The Password Protect setting menu is displayed.

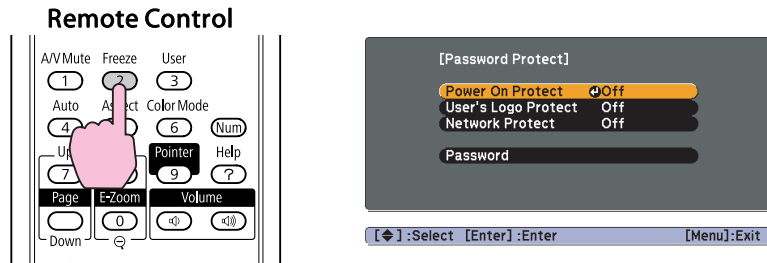

- If Password Protect is already activated, you must enter the Password. If the Password is entered correctly, the Password Protect setting menu is displayed. ➡ "Entering the Password" p.30
- When the Password is set, stick the Password protect sticker in a visible position on the projector as a further theft deterrent.

- 2 Turn on Power On Protect.

- (1) Select **Power On Protect**, and then press the [Enter] button.
- (2) Select **On**, and then press the [Enter] button.
- (3) Press the [Return] button.

- 3 Turn on User's Logo Protect.

- (1) Select **User's Logo Protect**, and then press the [Enter] button.
- (2) Select **On**, and then press the [Enter] button.
- (3) Press the [Return] button.

- 4 Turn on Network Protect.(EB-826W/825/85/84 only)

- (1) Select **Network Protect**, and then press the [Enter] button.
- (2) Select **On**, and then press the [Enter] button.
- (3) Press the [Return] button.

- 5 Set the Password.

- (1) Select **Password**, and then press the [Enter] button.
- (2) The message **Change the password?** is displayed, select **Yes** and then press the [Enter] button. The default setting for the Password is "0000". Change this to your own desired Password. If you select **No**, the screen shown in step 1 is displayed again.
- (3) While holding down the [Num] button, enter a four digit number using the numeric buttons. The number entered is displayed as "* * * *". When you enter the fourth digit, the confirmation screen is displayed.

Remote Control

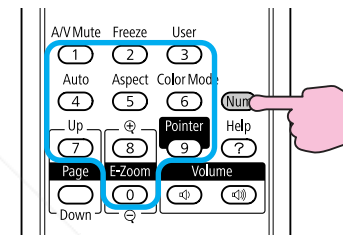

- (4) Re-enter the Password. The message **Password accepted.** is displayed. If you enter the Password incorrectly, a message is displayed prompting you to re-enter the password.

Entering the Password

When the Password entry screen is displayed, enter the Password using the numeric buttons on the Remote Control.

Procedure

While holding down the [Num] button, enter the Password by pressing the numeric buttons.

When you enter the correct Password, projection begins.

Attention

- If an incorrect Password is entered three times in succession, the message **The projector's operation will be locked.** is displayed for about five minutes, and then the projector switches to standby mode. If this happens, disconnect the power plug from the electrical outlet and then reinsert it and turn the projector's power back on. The projector displays the Password entry screen again so that you can enter the correct Password.
- If you have forgotten the password, make a note of the "Request Code: xxxxx" number that appears on the screen and contact the nearest address provided in the Support and Service Guide. [Epson Projector Contact List](#)
- If you continue to repeat the above operation and input the wrong Password thirty times in succession, the following message is displayed and the projector does not accept any more Password entries. **The projector's operation will be locked. Contact Epson as described in your documentation.** [Epson Projector Contact List](#)

• Partial Lock

All of the buttons on the Control panel, except for the [⏻] button, are locked.

This is useful at events or shows when you want to deactivate all buttons and only project, or at schools when you want to limit button operation. The projector can still be operated using the Remote Control.

Procedure

- 1 During projection, press the [Menu] button and select **Settings - Control Panel Lock** from the Configuration Menu. ["Using the Configuration Menu" p.34](#)

Using the Remote Control

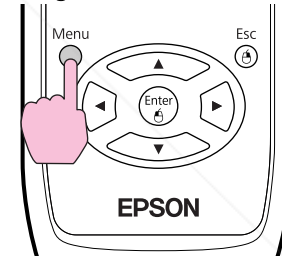

Using the Control panel

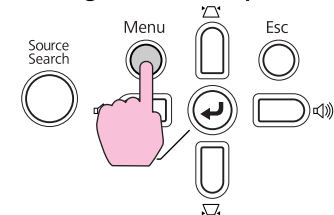

Restricting Operation (Control Panel Lock)

Perform one of the following to lock the operation buttons on the Control panel.

• Full Lock

All of the buttons on the Control panel are locked. You cannot perform any operations from the Control panel, including turning the power on or off.

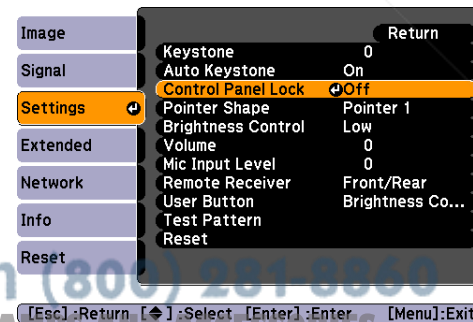

[Esc]:Return [↔]:Select [Enter]:Enter [Menu]:Exit

2 Select either Full Lock or Partial Lock.

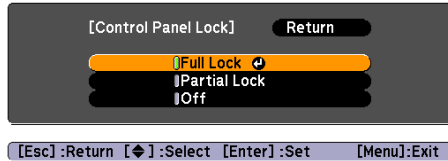

3 Select Yes when the confirmation message is displayed.

The Control panel buttons are locked according to the setting you chose.



You can release the Control panel lock by one of the following two methods.

- From the Remote Control, select **Off** in **Settings - Control Panel Lock** from the Configuration Menu.
- Press and hold down the [Enter] button on the Control panel for about seven seconds, a message is displayed and the lock is released.

• Security cable installation point

A commercially available theft-prevention wire lock can be passed through the installation point to secure the projector to a desk or pillar.

Installing the wire lock

Pass an anti-theft wire lock through the installation point.

See the documentation supplied with the wire lock for locking instructions.

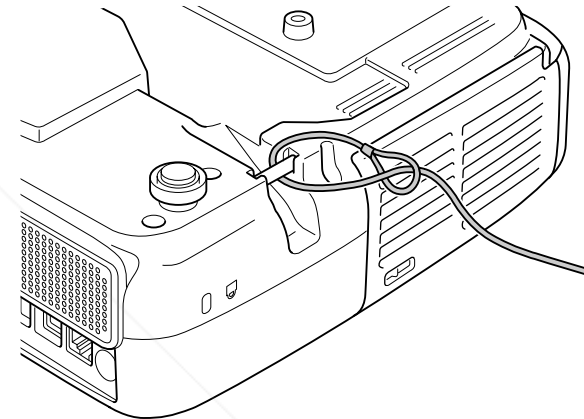

Anti-Theft Lock

As the projector is often setup on ceiling mounts and left in rooms unattended, the projector includes the following security devices to prevent someone from taking the projector.

• Security slot

The Security slot is compatible with the Microsaver Security System manufactured by Kensington. You can find details about the Microsaver Security System on the Kensington homepage <http://www.kensington.com/>.



Configuration Menu

This chapter explains how to use the Configuration Menu and its functions.



Discount-Merchant.com (800) 281-8860
THE TRUSTED SOURCE FOR PROJECTOR LAMPS AND ACCESSORIES

- 1 Selecting from the top menu
- 2 Selecting from the sub menu
- 3 Changing the selected item
- 4 Exit

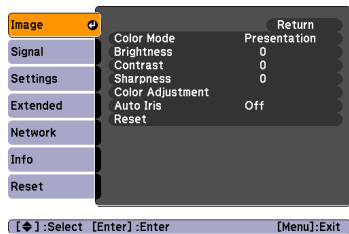

[Left Arrow]:Select [Enter]:Enter [Menu]:Exit

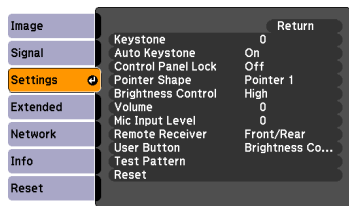
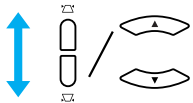

[Left Arrow]:Select [Enter]:Enter [Menu]:Exit

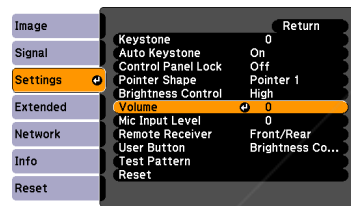
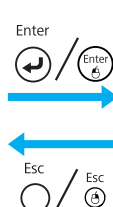

[Esc]:Return [Left Arrow]:Select [Enter]:Enter [Menu]:Exit

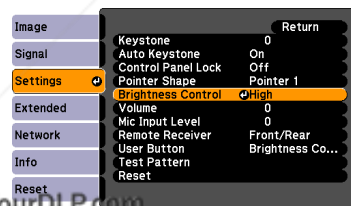
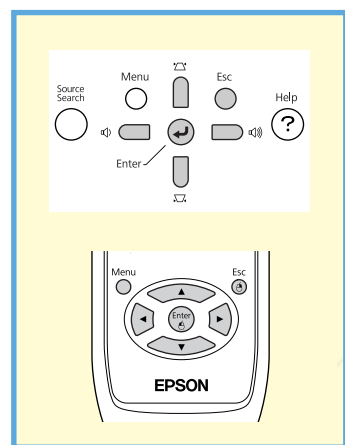
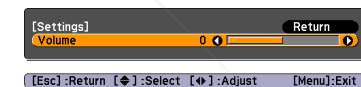

[Esc]:Return [Left Arrow]:Select [Enter]:Enter [Menu]:Exit

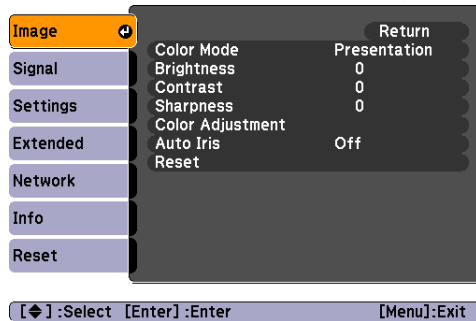

Image Menu

Items that can be set vary depending on the image signal and Source currently being projected as shown in the following screen shots. Setting details are saved for each image signal and Source.



Depending on the model used, some input sources are not supported.  p.16

Computer Signal/USB /USB Display/LAN

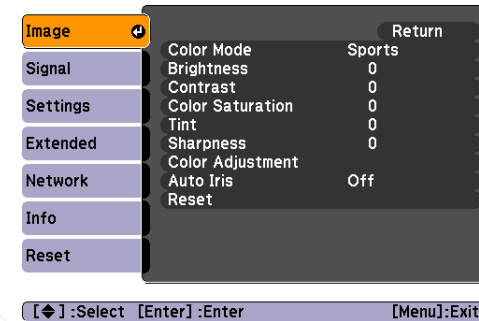

Component Video▶▶/Composite video▶▶/S-Video▶▶



Sub Menu	Function
Color Mode	You can select the quality of the image to suit your surroundings.  p.18
Brightness	You can adjust the image Brightness.
Contrast▶▶	You can adjust the difference between light and shade in the images.
Color Saturation	You can adjust the Color Saturation for the images.
Tint	(Adjustment is only possible when NTSC signals are being input if you use composite video/S-Video.) You can adjust the image Tint.
Sharpness	You can adjust the image sharpness.
Color Adjustment	You can make adjustments by choosing one of the following.(This item cannot be selected if sRGB▶▶ is selected as the Color Mode setting from the Image menu.) Ab Color Temp.: You can adjust the overall tint of the image. You can adjust tints in 10 stages from 5000 K to 10000 K. When a high value is selected the image becomes tinged with blue, when a low value is selected the image becomes tinged with red. Red, Green, Blue: You can adjust the saturation of each color individually.
Auto Iris	(This item is only displayed if Dynamic or Theatre are selected as the Color Mode setting from the Image menu.) Set whether or not (On/Off) to adjust to the optimum light status for images being projected.  p.19

Sub Menu	Function
Reset	You can reset all adjustment values for the Image menu functions to their default settings. To return all menu items to their default settings, see p.52

Signal Menu

Items that can be set vary depending on the image signal currently being projected as shown in the following screen shots. Setting details are saved for each image signal.

You cannot make settings on the **Signal** menu when the source is LAN. (EB-826W/825/85)

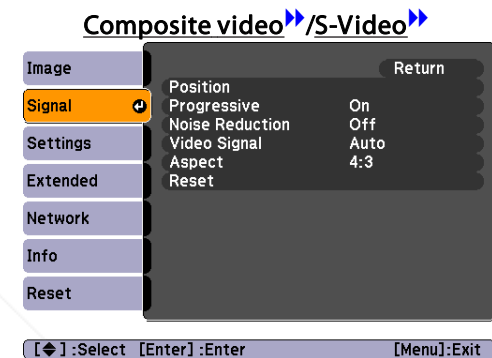
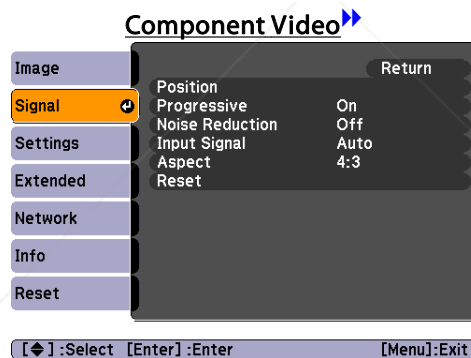
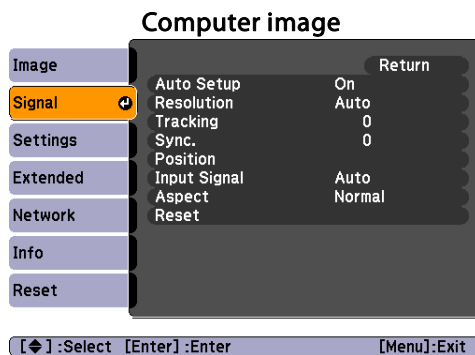





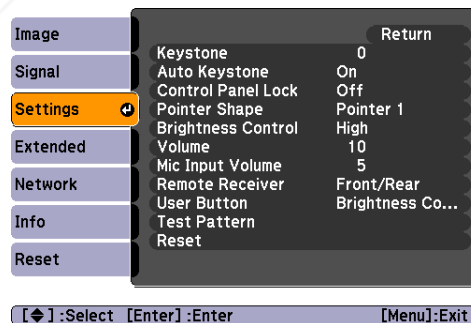

Sub Menu	Function
Auto Setup	You can select whether or not (On/Off) Auto Setup automatically adjusts the image to the optimum state when the Input Signal changes. p.61
Resolution	When set to Auto , the resolution of the input signal is automatically identified. If the images cannot be projected correctly when set to Auto , such as when some of the image is missing, adjust to Wide depending on the connected computer for wide screens, or set to Normal for 4:3 or 5:4 screens.
Tracking	You can adjust computer images when vertical stripes appear in the images. p.61
Sync.	You can adjust computer images when flickering, fuzziness, or interference appear in the images. p.61
Position	You can adjust the display Position up, down, left, and right when a part of the image is missing so that the whole image is projected.

Sub Menu	Function
Progressive	(Component Video can only be adjusted when 480i/576i/1080i signals are being input) Off: IP conversion is carried out for each field in the screen. This is ideal for viewing images with a large amount of movement. On: <u>Interlace</u> (i) signal is converted to <u>Progressive</u> (p). Applies to still images.
Noise Reduction	Smooths out rough images. There are two modes. Select your favorite setting. It is recommended that this is set to Off when viewing image sources in which noise is very low, such as for DVDs.
Input Signal	You can select an input signal from Computer1/2 input port. If set to Auto the input signal is set automatically according to the connected equipment. If colors do not appear correctly when set to Auto , select the appropriate signal according to the connected equipment.
Video Signal	You can select input signal from Video input port. If set to Auto , video signals are recognized automatically. If interference appears in the image or a problem occurs such as no image is being projected when set to Auto , select the appropriate signal according to the connected equipment.
Aspect	You can set the <u>Aspect Ratio</u> for projected images. p.20
Reset	You can reset all adjustment values on the Signal menu to their default settings, except for Input Signal . To return all menu items to their default settings, see p.52

Settings Menu





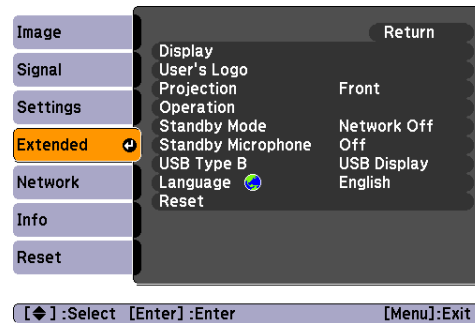

Sub Menu	Function
Keystone	You can correct keystone distortion in the vertical directions. <i>Quick Start Guide</i>
Auto Keystone	Turn On to perform Auto Keystone. (Auto Keystone is only executed when Front is selected from the Extended - Projection menu.)

Sub Menu	Function
Control Panel Lock	You can use this to restrict operation of the projector's Control panel.  p.31
Pointer Shape	You can select the shape of the pointer.  p.25 Pointer 1:  Pointer 2:  Pointer 3: 
Brightness Control	You can set the Lamp brightness to one of two settings. Select Low if the images being projected are too bright such as when projecting images in a dark room or onto a small screen. When Low is selected, the amount of electricity consumed and the lamp's operating life are changed as follows, and fan rotation noise during projection is reduced. Electrical consumption: about 25% decrease, lamp life: about 1.2 times longer
Volume	You can adjust the Volume. Setting details are saved for each image signal.
Mic Input Volume	Adjust if the Mic Input level is too low to hear from the projector's speaker, or if the level is too high making the audio crack. When the Mic Input Volume is turned down to 0, no audio is output from the speaker.
Remote Receiver	You can limit the reception of the operation signal from the Remote Control. When you want to prohibit operation by Remote Control, or if the Remote Receiver has a fluorescent light too close to it, you can make settings to deactivate the remote receiver you do not want to use or that is experiencing interference.
User Button	You can select the item assigned from the Configuration Menu with the Remote Control's [User] button. By pressing the [User] button the assigned menu item selection/adjustment screen is displayed, allowing you to make one-touch settings/adjustments. You can assign one of the following five items to the [User] button. Brightness Control, Info, Progressive, Test Pattern, Resolution
Test Pattern	When the projector is setup, a Test Pattern is displayed so that you can adjust the projection without connecting other equipment. While the Test Pattern is displayed, zoom, focus adjustments, and Keystone correction can be performed. To cancel the Test Pattern, press the [Return] button on the Remote Control or the Control panel.
Reset	You can reset all adjustment values on the Settings menu to their default settings, except for User Button . To return all menu items to their default settings, see  p.52

Extended Menu



Sub Menu	Function
Display	<p>You can make settings related to the projector's display.</p> <p>Messages: You can set whether or not (On/Off) to display the Source name when you change the Source, the Color Mode name when you change the Color Mode, a message when no image signal is input, and so on.</p> <p>Display Background*¹: You can set the screen status for when no image signal is available to Black, Blue, or Logo.</p> <p>Startup Screen*¹: You can set whether or not (On/Off) the Startup Screen (the image projected when starting the projector) is displayed.</p> <p>A/V Mute*¹: You can set the screen displayed during A/V Mute as Black, Blue, or Logo.</p>
User's Logo*¹	You can change the User's Logo that is displayed as a background during Display Background, A/V Mute, and so on.  p.76
Projection	<p>You can set from the following according to the way the projector is setup.  p.66</p> <p>Front, Front/Ceiling, Rear, Rear/Ceiling</p> <p>You can change the setting as follows by pressing down the [A/V Mute] button on the Remote Control for about five seconds.</p> <p>Front↔Front/Ceiling</p> <p>Rear↔Rear/Ceiling</p>

Sub Menu	Function
Operation	<p>Direct Power On: You can set whether or not (On/Off) to enable Direct Power On. When it is set to On and the power cable is plugged in, be aware that the projector turns on automatically in case such as a power outage is restored.</p> <p>Sleep Mode: When set to On, this automatically stops projection when no image signal is being input and no operations are carried out.</p> <p>Sleep Mode Timer: When Sleep Mode is set to On, you can set the time before the projector automatically turns off within a range of 1 to 30 minutes.</p> <p>Lens Cover Timer: When set to On, this turns off the power automatically 30 minutes after the A/V mute slide knob is closed. Lens Cover Timer is set to On at the time of purchase.</p> <p>High Altitude Mode: Set to On when using the projector above an altitude of 1500 m.</p>
Standby Mode	<p>You can use the following functions even when the projector is in standby mode if this is set to Communication On.</p> <ul style="list-style-type: none"> • Monitor and control the status of the projector over the network. • The Mic Input function outputs audio from the projector's speaker when a mic is connected to the Mic Input Port. This is also enabled if this setting is set to Communication On and Standby Microphone is set to On. <p>You can use SNMP to monitor and control the status of the projector over the network, or by using the "EMP Monitor" software*² supplied with this product.</p>
Standby Microphone	<p>(Only possible when the Standby Mode mentioned above is set to Communication On)</p> <p>When Standby Mode is set to Communication On, set whether mic Input is enabled (On) or disabled (Off).*³</p>
USB Type B	<p>Set to USB Display when the projector and a computer are connected by a USB cable and computer images are projected.  Quick Start Guide</p> <p>Set to Wireless Mouse when the mouse pointer is to be operated by the Remote Control.  p.27</p>
Language	<p>You can set the Language for message displays.</p>
Reset	<p>You can reset Display*¹ and Operation*⁴ from the Extended menu to their default settings.</p> <p>To return all menu items to their default settings, see  p.52</p>

*1 When User's Logo Protect is set to On in Password Protect, settings relating to User's Logo cannot be changed. You can make changes after setting "User's Logo Protect" to "Off".  [p.29](#)

2 A commercially available serial IP conversion adapter and connector cable are necessary to allow EB-824 owner's to use EMP Monitor. For supported products, see <http://www.epson.com>.

*3 If **Power On Protect** in **Password Protect** is **On**, mic input is not possible even when Standby Microphone is set to **On**.

*4 Except for "High Altitude Mode".

Network Menu (EB-826W/825/85/84 only)

When **Network Protect** is set to **On** in **Password Protect**, a message is displayed and the settings cannot be changed. You can make changes after setting **Network Protect** to **Off**. [p.29](#)

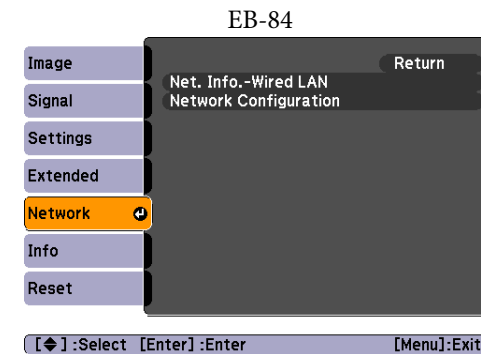
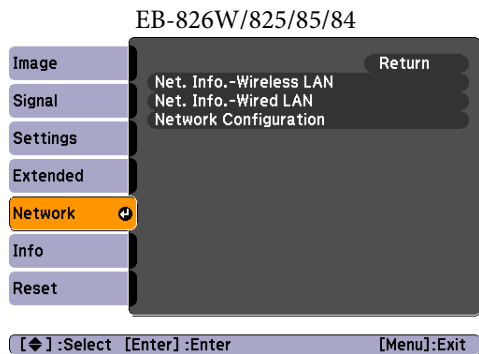

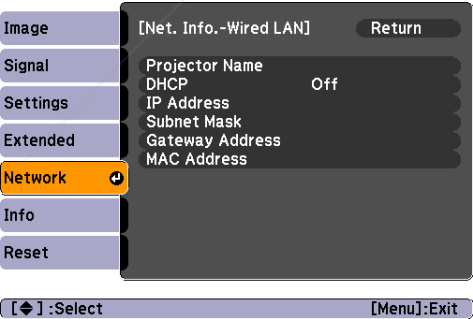
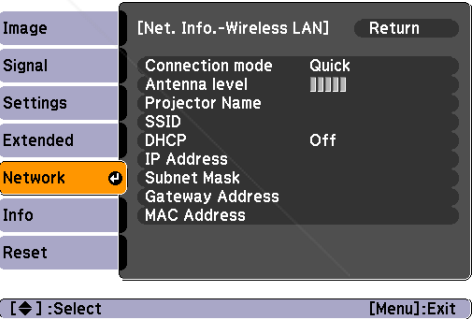
Sub Menu	Function
Network Information	<p>You can confirm the setting status for each network as follows.</p> <div style="display: flex; justify-content: space-around;"> <div style="text-align: center;">  <p>[Left Arrow]:Select [Menu]:Exit</p> </div> <div style="text-align: center;">  <p>[Left Arrow]:Select [Menu]:Exit</p> </div> </div>
Network Configuration	<p>The following menus are available for setting Network items.</p> <p>Basic Menu, Wireless LAN Menu, Security Menu, Wired LAN Menu, Mail Menu, Others Menu, Reset Menu, Setup complete Menu</p>



By using the Web browser of a computer connected to the projector on a network, you can set the functions and control the projector. This function is called Web Control. You can easily enter text using a keyboard to make settings for Web Control such as Security settings. [Projector Operation Guide](#)
 "Changing Settings Using a Web Browser (Web Control)"

Notes on operating the Network menu

Selecting from the top menu and sub menus, and changing of selected items are the same as operations in the Configuration Menu.

When done, make sure you go to the **Setup complete** menu, and select one of **Yes**, **No**, or **Cancel**. When you select **Yes** or **No**, you return to the Configuration Menu.

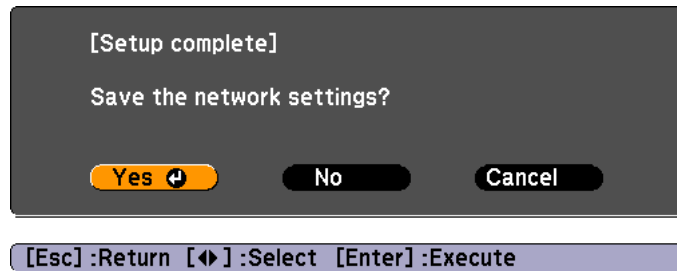

Yes: Saves the settings and exits the Network menu.

No: Does not save the settings and exits the Network menu.

Cancel: Continues displaying the Network menu.

Soft keyboard operations

The Network menu contains items that require input of alphanumerics during setup. In this case, the following software keyboard is displayed.

Use the [Up], [Down], [Left], [Right] buttons on the Remote Control or the [Z], [V], [F], and [M] buttons on the Control panel to move the cursor to the desired key, and then press the [Enter] button to enter the alphanumeric. Enter figures by holding down the [Num] button on the Remote Control, and pressing the numeric buttons. After inputting, press [Finish] on the keyboard to confirm your input. Press [Cancel] on the keyboard to cancel your input.

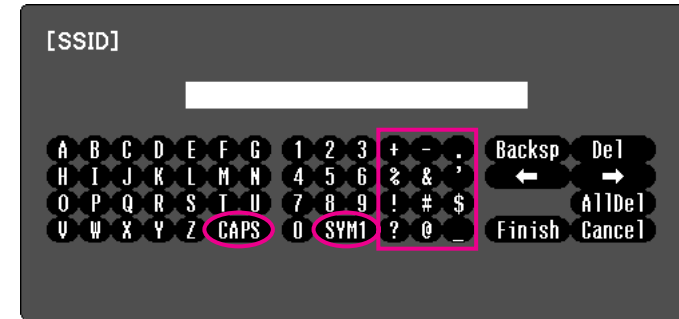

Each time the [CAPS] key is selected, it sets and changes between upper case and lower case letters.

Each time the [SYM1/2] key is selected, it sets and changes the symbol keys for the section enclosed by the frame.

Basic Menu

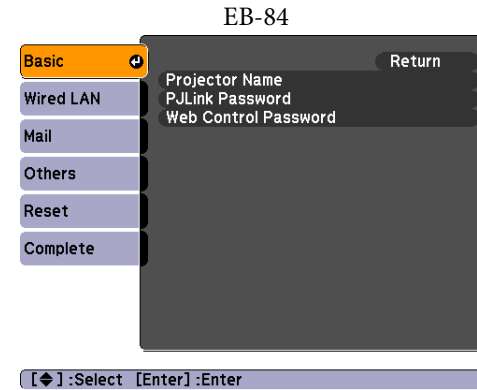
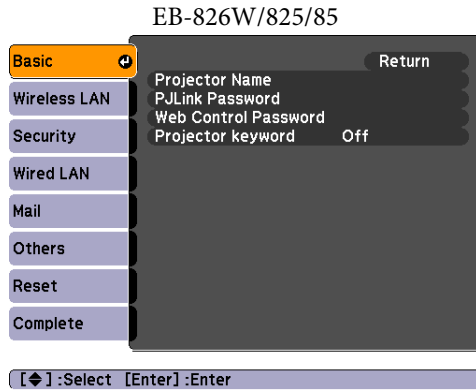

Sub Menu	Function
Projector Name	Displays the projector name used to identify the projector when connected to a Network. When editing, you can enter up to 16 single-byte alphanumeric characters.
PJLink Password	Set a Password to use when you access the projector using compatible PJLink software. p.92 You can enter up to 32 single-byte alphanumeric characters.
Web Control Password	Set a password to use when making settings and controlling the projector using Web Control. You can enter up to 8 single-byte alphanumeric characters. Web Control is a computer function that allows you to set up and control the projector by using the Web browser on a computer connected on a Network. Projector Operation Guide "Changing Settings Using a Web Browser (Web Control)"
Projector keyword (EB-826W/825/85 only)	When set to On , you have to enter the Keyword when you try to connect the projector to a computer on a Network. As a result, EMP NS Connection can prevent presentations from being interrupted by unscheduled connections from a computer during projection. Normally this should be set to On . Projector Operation Guide "Connecting to a Projector on a Network and Projecting"

Wireless LAN Menu (EB-826W/825/85 only)

Settings are enabled when the optional Wireless LAN unit is installed.

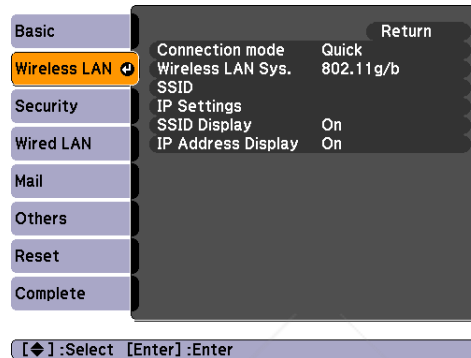

Sub Menu	Function
Connection mode	Use EMP NS Connection to set the mode, how the computer connect to the projector. Set to Quick Connection Mode when you want to make a quick wireless connection. Set to Advanced Connection Mode when you want to connect to a network system via an access point.
Wireless LAN system	Sets the Wireless LAN system.
SSID	Enter an SSID. When an SSID is provided for the Wireless LAN system in which the projector participates, enter the SSID. You can enter up to 32 single-byte alphanumeric characters.
IP Settings	You can make settings related to the following addresses. DHCP : Select whether or not (On/Off) to use DHCP. If this is set to On you cannot set any more addresses. IP Address : You can input the IP Address assigned to the projector. You can input a number from 0 to 255 in each field of the address. However, the following IP Addresses cannot be used. 0.0.0.0, 127.x.x.x, 224.0.0.0 to 255.255.255.255 (where x is a number from 0 to 255) Subnet Mask : You can input the Subnet Mask for the projector. You can input a number from 0 to 255 in each field of the address. However, the following Subnet Masks cannot be used. 0.0.0.0, 255.255.255.255 Gateway Address : You can input the IP Address for the gateway for the projector. You can input a number from 0 to 255 in each field of the address. However, the following Gateway Addresses cannot be used. 0.0.0.0, 127.x.x.x, 224.0.0.0 to 255.255.255.255 (where x is a number from 0 to 255)
SSID Display	To prevent the SSID from being displayed on Network Info in the Network Menu and on the LAN Standby screen, set this to Off .

Sub Menu	Function
IP Address Display	To prevent the IP Address from being displayed on Network Info in the Network Menu and on the LAN Standby screen, set this to Off .

Security Menu (EB-826W/825/85 only)

Settings are enabled when the optional Wireless LAN unit is installed.

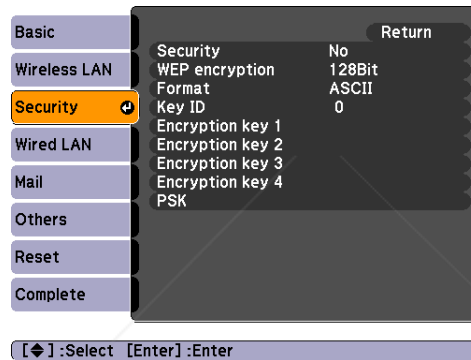

Sub Menu	Function
Security	<p>Select one type of security from the following items.</p> <p>When setting up Security, follow the instructions from the administrator of the network system you are about to access. When using Advanced Connection Mode, it is essential that you make security settings.</p> <p>WEP: Data is encrypted with a code key (WEP key). This mechanism prevents communication unless the encrypted keys for the access point and the projector match.</p> <p>WPA/WPA2: This is an encryption standard that improves security which is a weak point of WEP. Although there are multiple kinds of WPA encryption methods, this projector uses "TKIP" and "AES".</p> <p>WPA also includes user authentication functions. WPA authentication provides two methods: Using an authentication server, or authenticating between a computer and an access point without a server. This projector supports the latter method, without a server.</p>

When WEP is selected

You can set the following items.

Sub Menu	Function
WEP encryption	You can set the encryption for WEP encryption. 128bit: Uses 128 (104) bit encoding 64bit: Uses 64 (40) bit encoding
Format	You can set the input method for the WEP encryption key. ASCII: Input text. HEX: Input in HEX (hexadecimal).
Key ID	Selects the WEP encryption ID key.
Encryption key 1 Encryption key 2 Encryption key 3 Encryption key 4	You can enter the key used for WEP encryption. Enter the key in single-byte characters following instructions from the network administrator for the network in which the projector participates. The type of character and the number that can be entered differ according to the WEP encryption and Format settings. If the number of characters you enter is shorter than the required character length, or if the number of characters you enter is longer than the required character length, it does not connect. 128bit - ASCII: Single-byte alphanumerics, 13 characters. 64bit - ASCII: Single-byte alphanumerics, 5 characters. 128bit - HEX: 0 to 9 and A to F, 26 characters 64 bit - HEX: 0 to 9 and A to F, 10 characters

When WPA-PSK (TKIP) or WPA2-PSK (AES) is selected

You can set the following items.

Sub Menu	Function
PSK	You can enter a PreSharedKey (encrypted key) in single-byte alphanumeric characters. Enter at least 8 and up to 63 characters. When the PreSharedKey is entered and the [Enter] button is pressed, the value is set and displayed as an asterisk (*). You cannot enter more than 32 characters on the Configuration Menu. When setting from Web Control, you can enter more than 32 characters. Projector Operation Guide "Changing Settings Using a Web Browser (Web Control)"

Wired LAN Menu

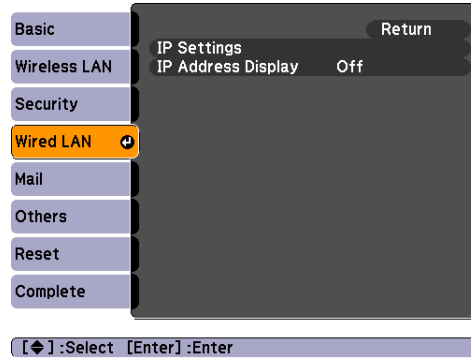

Sub Menu	Function
IP Settings	<p>You can make settings related to the following addresses.</p> <p><u>DHCP</u>▶▶: Select whether or not (On/Off) to use DHCP. If this is set to On you cannot set any more addresses.</p> <p><u>IP Address</u>▶▶: You can input the IP Address assigned to the projector. You can input a number from 0 to 255 in each field of the address. However, the following IP Addresses cannot be used. 0.0.0.0, 127.x.x.x, 224.0.0.0 to 255.255.255.255 (where x is a number from 0 to 255)</p> <p><u>Subnet Mask</u>▶▶: You can input the Subnet Mask for the projector. You can input a number from 0 to 255 in each field of the address. However, the following Subnet Masks cannot be used. 0.0.0.0, 255.255.255.255</p> <p><u>Gateway Address</u>▶▶: You can input the IP Address for the gateway for the projector. You can input a number from 0 to 255 in each field of the address. However, the following Gateway Addresses cannot be used. 0.0.0.0, 127.x.x.x, 224.0.0.0 to 255.255.255.255 (where x is a number from 0 to 255)</p>
IP Address Display	To prevent the IP Address from being displayed on Network Info in the Network Menu and on the LAN Standby screen, set this to Off .

Mail Menu

When this is set, you receive an e-mail notification if a problem or warning occurs in the projector. For information on the contents of the sent Mail, see "[Reading Problem Mail Notification Function \(EB-826W/825/85/84 only\)](#)"  p.89

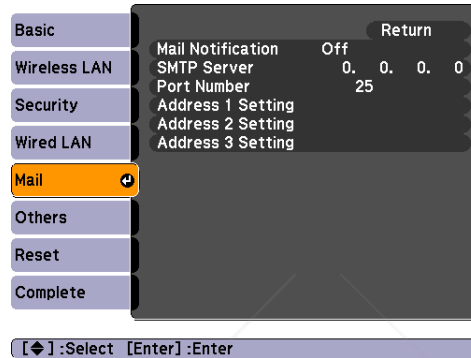

Sub Menu	Function
Mail Notification	You can set whether or not (On/Off) to be notified by e-mail.
SMTP Server	You can input the <u>IP Address</u>  for the SMTP Server for the projector. You can input a number from 0 to 255 in each field of the address. However, the following IP Addresses cannot be used. 127.x.x.x, 224.0.0.0 to 255.255.255.255 (where x is a number from 0 to 255)
Port Number	You can input the Port Number for the SMTP Server. The default value is 25. You can input numbers between 1 to 65535.
Address 1 Setting Address 2 Setting Address 3 Setting	Input the Email Address and the contents of the Mail to receive notification when an abnormality or warning occurs in the projector. You can enter up to 32 single-byte alphanumeric characters for the Email Address. You can select multiple problems or warnings to be notified about by Mail. You can also change each Email Address.

Others Menu

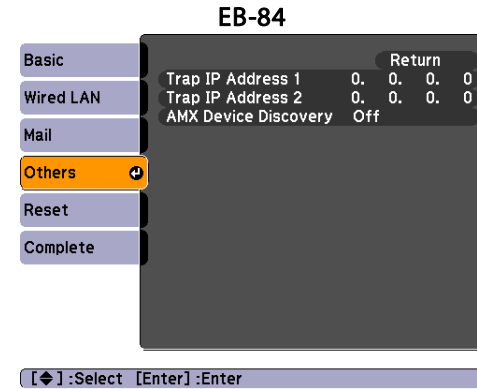
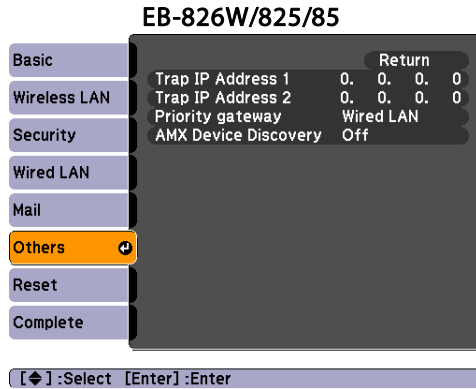

Sub Menu	Function
Trap IP Address 1 Trap IP Address 2	You can register up to two for the SNMP trap notification destination. You can input a number from 0 to 255 in each field of the address. However, the following IP Addresses cannot be used. 127.x.x.x, 224.0.0.0 to 255.255.255.255 (where x is a number from 0 to 255) To use SNMP to monitor the projector, you need to install the SNMP manager program on your computer. SNMP should be managed by a network administrator.
Priority gateway (EB-826W/825/85 only)	For the priority gateway, select either wireless or wired.
AMX Device Discovery	When the projector is connected to a network, set this to On to allow the projector to be detected by AMX Device Discovery. Set this to Off if you are not connected to an environment controlled with a controller from AMX or AMX Device Discovery.

Reset Menu

Resets all of the Network settings.

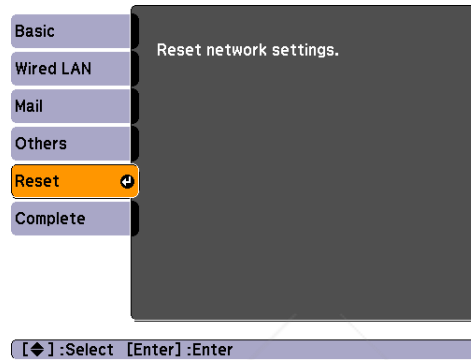

Sub Menu	Function
Reset network settings.	To reset all of the Network settings, select Yes . After you Reset all the settings, the Basic menu appears.

Info Menu (Display Only)

Lets you check the status of the image signals being projected and the status of the projector. Items that can be displayed vary depending on the image signal and Source currently being projected as shown in the following screen shots. Depending on the model used, some input sources are not supported. [p.16](#)

Computer Signal/Component Video▶▶/USB /USB

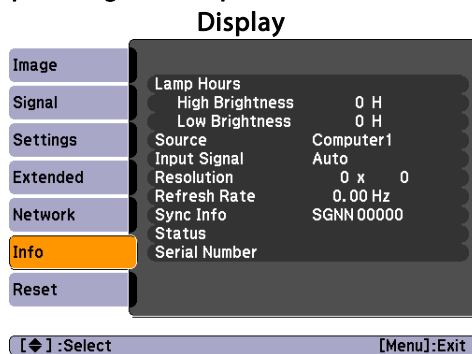

Composite video▶▶/S-Video▶▶

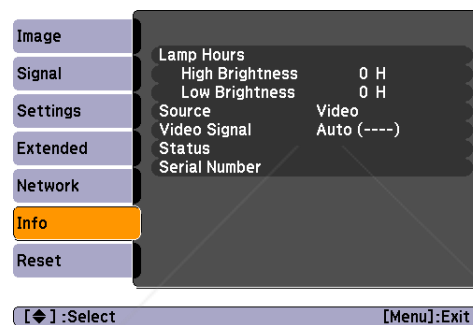

LAN

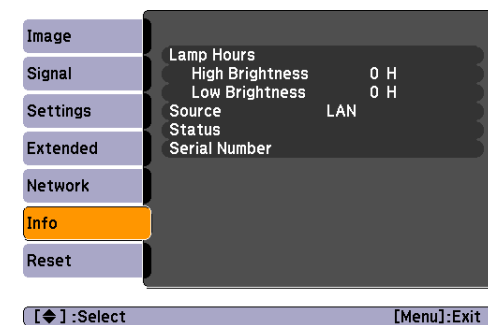

Sub Menu	Function
Lamp Hours	You can display the cumulative Lamp operating time*. When it reaches the lamp warning time, the characters are displayed in yellow.
Source	You can display the Source name for the connected equipment currently being projected.
Input Signal	You can display the content of Input Signal set in the Signal menu according to the Source .
Resolution	You can display the Resolution.
Video Signal	You can display the content of Video Signal set in the Signal menu.
Refresh Rate▶▶	You can display the Refresh Rate.
Sync Info	You can display the image signal Info. This information may be needed if service is required.
Status	This is Info about errors that have occurred on the projector. This information may be needed if service is required.
Serial Number	Displays the projector's serial number.

* The cumulative use time is displayed as "0H" for the first 10 hours. 10 hours and above is displayed as "10H", "11H", and so on.

Reset Menu

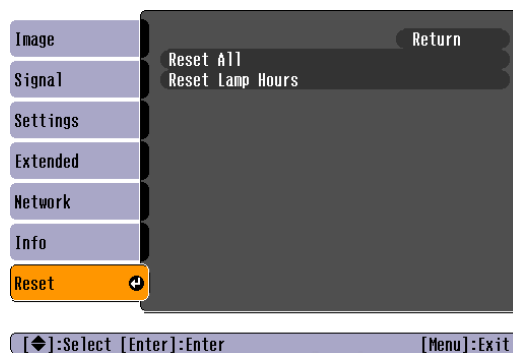

Sub Menu	Function
Reset All	You can reset all items in the Configuration Menu to their default settings. The following items are not reset to their defaults: Input Signal , User's Logo , all items for Network menus, Lamp Hours , and Language .
Reset Lamp Hours	You can clear the cumulative Lamp Hours use time, and return it to "0H". Reset when you replace the Lamp.



Troubleshooting

This chapter explains how to identify problems and what to do if a problem is found.



Discount-Merchant.com (800) 281-8860
THE TRUSTED SOURCE FOR PROJECTOR LAMPS AND ACCESSORIES

If a problem occurs with the projector, the Help screen is displayed to assist you by pressing the [Help] button. You can solve problems by answering the questions.

Procedure

1 Press the [Help] button.

The Help screen is displayed.

Using the Remote Control

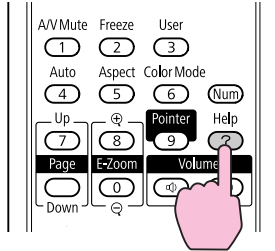

Using the Control panel

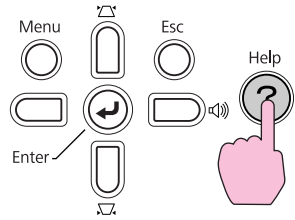

2 Select a menu item.

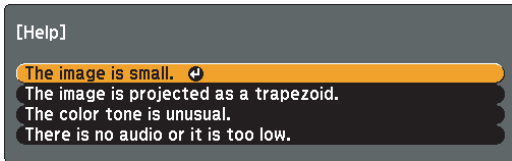

[Left Arrow]:Select [Enter]:Enter [Help]:Exit

Using the Remote Control

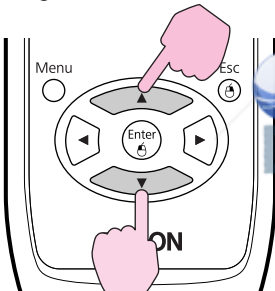

Using the Control panel

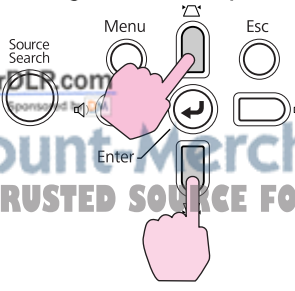

3 Confirm the selection.

Using the Remote Control

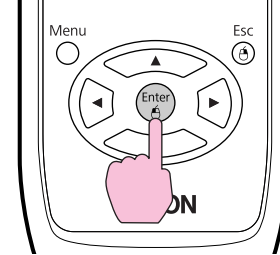

Using the Control panel

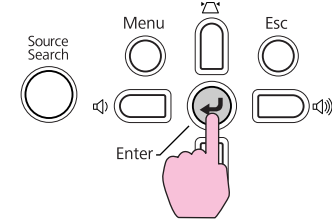

Questions and solutions are displayed as shown on the screen below. Press the [Help] button to exit Help.

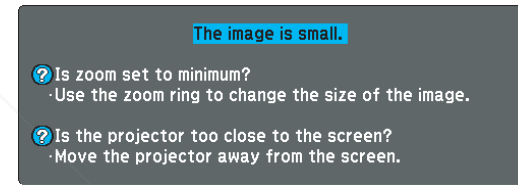

[Esc]:Return [Help]:Exit

If the Help screen does not provide a solution to the problem, refer to "Problem Solving" p.55.

If you are having a problem with the projector, first check the projector's indicators and refer to "Reading the Indicators" below. If the indicators do not show clearly what the problem might be, refer to "When the Indicators Provide No Help". [p.58](#)

Reading the Indicators

The projector is provided with the following three indicators that indicate the operating status of the projector.

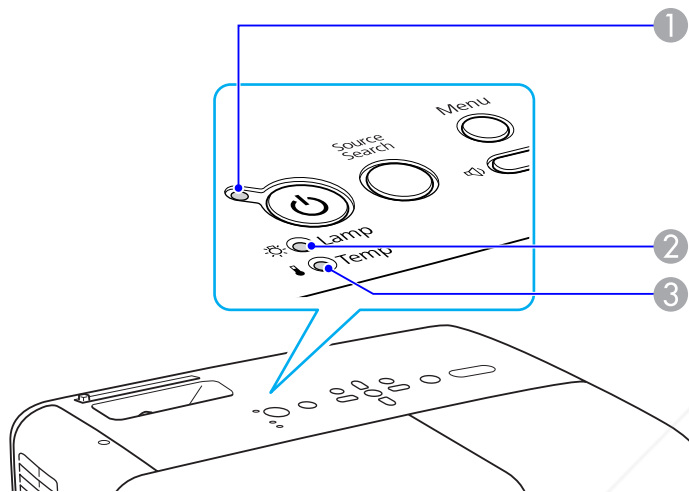

- | | |
|---|--|
| <p>① Indicates the operating status.</p> | <p>● Standby condition
When the [⏻] button is pressed in this condition, projection starts.</p> <p>☀️ Preparing network monitoring or cool down in progress
Buttons are disabled while the indicator is flashing.</p> <p>🌱 Warming up
Warm-up time is about 30 seconds. After warm-up is complete, the indicator stops flashing.</p> <p>● Projecting</p> |
| <p>② Indicates the projection Lamp status.</p> | |
| <p>③ Indicates the internal temperature status.</p> | |





















FixYourDLP.com
 Sponsored by
Discount-Merchant.com (800) 281-8860
THE TRUSTED SOURCE FOR PROJECTOR LAMPS AND ACCESSORIES











Refer to the following table to see what the indicators mean and how to remedy problems that they indicate.

If all indicators are off, check that the power cable is connected correctly and that the power is being supplied normally. Sometimes, when the power cable is unplugged, the  indicator remains lit for a short period, but this is not a fault.

Indicator is lit or flashing red











 : Lit  : Flashing:  : Off

Status	Cause	Remedy or Status
  	Internal Error	Stop using the projector, disconnect the power cable from the electrical outlet, and contact your local dealer or the nearest address provided in the Support and Service Guide.  Epson Projector Contact List
  	Fan Error Sensor Error	Stop using the projector, disconnect the power cable from the electrical outlet, and contact your local dealer or the nearest address provided in the Support and Service Guide.  Epson Projector Contact List
  	High Temp Error (overheating)	<p>The lamp turns off automatically and projection stops. Wait for about five minutes. After about five minutes the projector switches to standby mode, so check the following two points.</p> <ul style="list-style-type: none"> • Check that the air filter and Air exhaust vent are clear, and that the projector is not positioned against a wall. • If the air filter is clogged, clean or replace it.  p.67, p.72 <p>If the error continues after checking the points above, stop using the projector, disconnect the power cable from the electrical outlet, and contact your local dealer or the nearest address provided in the Support and Service Guide.  Epson Projector Contact List</p> <p>When using at an altitude of 1500 m or more, set High Altitude Mode to On.  p.39</p>
  	Lamp Error Lamp Failure Lamp Cover	<p>Check the following two points.</p> <ul style="list-style-type: none"> • Take out the Lamp and check if it is cracked.  p.69 • Clean the air filter.  p.67 <p>If it is not cracked: Re-fit the Lamp and turn on the power.</p> <p>If the error continues: Replace the Lamp with a new lamp and turn on the power.</p> <p>If the error continues: Stop using the projector, disconnect the power cable from the electrical outlet, and contact your local dealer or the nearest address provided in the Support and Service Guide.  Epson Projector Contact List</p>

Status	Cause	Remedy or Status
		<p>If it is cracked: Replace it with a new lamp, or contact your local dealer for further advice. If replacing the lamp yourself, be careful to avoid pieces of broken glass (you cannot continue projecting until the Lamp is replaced).  Epson Projector Contact List</p> <p>Check that the lamp cover and lamp are securely installed.  p.69</p> <p>If the lamp cover or the lamp are not installed correctly, the lamp does not turn on.</p> <p>When using at an altitude of 1500 m or more, set High Altitude Mode to On.  p.39</p>
     	Auto Iris Error Power Err. (Ballast)	Stop using the projector, disconnect the power cable from the electrical outlet, and contact your local dealer or the nearest address provided in the Support and Service Guide.  Epson Projector Contact List

Indicator is flashing or lit orange

● : Lit  : Flashing ○ : Off ◉ : Varies according to the projector status

Status	Cause	Remedy or Status
   ○  	High Temp Warning	(This is not an abnormality. However, if the temperature rises too high again, projection stops automatically.) <ul style="list-style-type: none"> • Check that the air filter and Air exhaust vent are clear, and that the projector is not positioned against a wall. • If the air filter is clogged, clean or replace it.  p.67, p.72
 ◉    ○	Replace Lamp	Replace it with a new Lamp.  p.69 If you continue to use the Lamp after the replacement period has passed, the possibility that the lamp may explode increases. Replace it with a new Lamp as soon as possible.



- If the projector is not operating properly, even though the indicators are all showing normal, refer to "When the Indicators Provide No Help" [p.58](#).
- If the error is not indicated in this table, stop using the projector, disconnect the power cable from the electrical outlet, and contact your local dealer or the nearest address provided in the Support and Service Guide.  [Epson Projector Contact List](#)



FixYourDLP.com











Sponsored by 

Discount-Merchants.com (800) 281-8860
 THE TRUSTED SOURCE FOR PROJECTOR LAMPS AND ACCESSORIES

When the Indicators Provide No Help





If any of the following problems occur and the indicators do not offer a solution, refer to the pages given for each problem.

Problems relating to images

- "No images appear"  p.59
Projection does not start, the projection area is completely black, the projection area is completely blue, and so on.
- "Moving images are not displayed"  p.59
Moving images being projected from a computer appear black and nothing is projected.
- "Projection stops automatically"  p.59
- "The message "Not supported" is displayed."  p.60
- ""No Signal" is displayed."  p.60
- "Images are fuzzy or out of focus"  p.60
- "Interference or distortion appear in images"  p.61
Problems such as interference, distortion, or black & white checked patterns appear.
- "The image is truncated (large) or small, or the aspect is not suitable"  p.61
Only part of the image is displayed, or the height and width ratios of the image are not correct, and so on.
- "Image colors are not right"  p.62
The whole image appears purplish or greenish, images are black & white, colors appear dull, and so on... (Computer monitors and LCD screens have different color reproduction performance, so that the colors projected by the projector and the image appearing on the monitor may not necessarily match, but this is not a sign of a problem.)
- "Images appear dark"  p.62

- "No power supplied"  p.63

Other problems

- "No sound can be heard or the sound is faint"  p.63
- "No sound can be heard from the microphone"  p.63
- "The Remote Control does not work"  p.64
- "I want to change the language for messages and menus"  p.64
- "Mail is not received even if a problem occurs in the projector (EB-826W/825/85)"  p.64

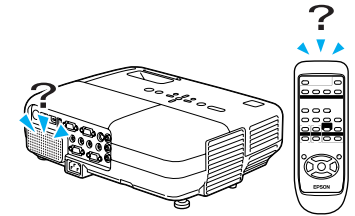

Problems when projection starts

Problems relating to images

No images appear

Check	Remedy
Did you press the [⏻] button?	Press the [⏻] button to turn the power on.
Are the indicators switched off?	The power cable is not connected correctly or power is not being supplied normally. Connect the projector's power cable correctly. 🖱 Quick Start Guide Check that your electrical outlet or power source is functioning correctly.
Is A/V Mute active?	Press the [A/V Mute] button on the Remote Control to cancel A/V Mute. 🖱 p.19
Is the A/V mute slide knob closed?	Open the A/V mute slide knob. 🖱 p.9
Are the Configuration Menu settings correct?	Reset All of the settings. 🖱 Reset Menu - Reset All p.52
Is the projected image completely black? Only when projecting computer images	Some input images, such as screen savers, may be completely black.
Is the image signal format setting correct? Only when projecting images from a video source	Change the setting according to the signal for the connected equipment. 🖱 Signal Menu - Video Signal p.36

Moving images are not displayed

Check	Remedy
Is the computer's image signal being output to the LCD and the monitor? Only when projecting images from a laptop computer or a computer with a built-in LCD screen	Change the image signal to external output only. 🖱 Check your computer's documentation.

Projection stops automatically



Check	Remedy
Is Sleep Mode set to On ?	Press the [⏻] button to turn the power on. If you do not want to use Sleep Mode , change the setting to Off . 🖱 Extended Menu - Operation - Sleep Mode p.39

Discount-Merchant.com (800) 881-8860

THE TRUSTED SOURCE FOR PROJECTOR LAMPS AND ACCESSORIES

The message "Not supported" is displayed.

Check	Remedy
Is the image signal format setting correct? Only when projecting images from a video source	Change the setting according to the signal for the connected equipment. 🖱️ Signal Menu - Video Signal p.36
Do the image signal Resolution and the Refresh Rate correspond to the mode? Only when projecting computer images	Refer to the computer's documentation for how to change the image signal Resolution and the Refresh Rate output from the computer. 🖱️ "Supported Monitor Displays" p.93

"No Signal" is displayed.

Check	Remedy
Are the cables connected correctly?	Check that all the cables required for projection are securely connected. 🖱️ Quick Start Guide
Is the correct input port selected?	Change the image by pressing the [Source Search] button on the Remote Control or the Control panel. 🖱️ p.16
Is the power for the computer or video source turned on?	Turn the power on for the equipment.
Are the image signals being output to the projector? Only when projecting images from a laptop computer or a computer with a built-in LCD screen	If the image signals are only being output to the computer's LCD monitor or to the accessory monitor, you need to change the output to an external destination as well as the computer's own monitor. For some computer models, when the image signals are output externally, they no longer appear on the LCD monitor or accessory monitor. 🖱️ Computer's documentation, under a title such as "External output" or "Connecting an external monitor". If the connection is made while the power of the projector or computer is already turned on, the function [Fn] key that changes the computer's image signal to external output may not work. Turn the power for the computer and the projector off and then back on again.

Images are fuzzy or out of focus

Check	Remedy
Is the focus adjusted correctly?	Turn the Focus ring to adjust the focus. 🖱️ Quick Start Guide
Is the projector at the correct distance?	Is it projecting outside of the recommended projection distance range? Setup within the recommended range. 🖱️ p.78
Is the Keystone adjustment value too large?	Lower the projection angle to reduce the amount of keystone correction. 🖱️ Quick Start Guide

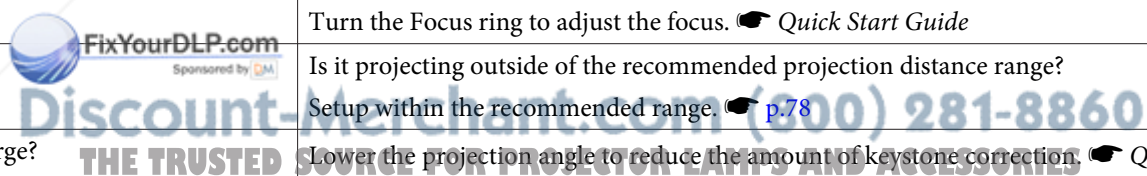

Check	Remedy
Has condensation formed on the lens?	If the projector is suddenly taken from a cold environment to a warm environment, or if sudden ambient temperature changes occur, condensation may form on the surface of the lens, and this may cause the images to appear fuzzy. Set the projector up in the room about one hour before it is used. If condensation forms on the lens, turn the projector off and wait for the condensation to disappear.

Interference or distortion appear in images

Check	Remedy
Is the image signal format setting correct? Only when projecting images from a video source	Change the setting according to the signal for the connected equipment. 🖱️ Signal Menu - Video Signal p.36
Are the cables connected correctly?	Check that all the cables required for projection are securely connected. 🖱️ Quick Start Guide
Is an extension cable being used?	If an extension cable is used, electrical interference may affect the signals. Use the cables supplied with the projector to check if the cables you are using may be causing the problem.
Is the correct resolution selected? Only when projecting computer images	Set the computer so that the signals being output are compatible with the projector. 🖱️ "Supported Monitor Displays" p.93 🖱️ Computer documentation
Are the "Sync.▶▶" and "Tracking▶▶" settings adjusted correctly? Only when projecting computer images	Press the [Auto] button on the Remote Control or the [Enter] button on the Control panel to perform automatic adjustment. If the images are not adjusted correctly after using automatic adjustment, you can make the adjustments using Sync. and Tracking from the Configuration Menu. 🖱️ Signal Menu - Tracking, Sync. p.36

The image is truncated (large) or small, or the aspect is not suitable

Check	Remedy
Is a wide panel computer image being projected? Only when projecting computer images	Change the setting according to the signal for the connected equipment. 🖱️ Signal Menu - Resolution p.36
Is the image still being enlarged by E-Zoom?	Press the [Return] button on the Remote Control to cancel E-Zoom. 🖱️ p.26
Is Position adjusted correctly?	Press the [Auto] button on the Remote Control or the [Enter] button on the Control panel to perform automatic adjustment of the computer image being projected. If the images are not adjusted correctly after using automatic adjustment, you can make the adjustments using Position from the Configuration Menu. Apart from computer image signals, you can adjust other signals while projecting by adjusting Position from the Configuration Menu. 🖱️ Signal Menu - Position p.36

Check	Remedy
Is the computer set for dual display? Only when projecting computer images	If dual display is activated in the "Display Properties" of the computer's Control panel, only about half of the image on the computer screen is projected. To display the entire image on the computer screen, turn off the dual display setting. 🖱️ Computer video driver documentation
Is the correct resolution selected? Only when projecting computer images	Set the computer so that the signals being output are compatible with the projector. 🖱️ "Supported Monitor Displays" p.93 🖱️ Computer documentation

Image colors are not right

Check	Remedy
Do the input signal settings match the signals from the connected device?	Change the following settings according to the signal for the connected equipment. When image is from a device connected to the Computer input port 🖱️ Signal menu - Input Signal p.36 When image is from a device connected to the Video or S-Video input port 🖱️ Signal menu - Video Signal p.36
Is the image Brightness adjusted correctly?	Adjust the Brightness setting from the Configuration Menu. 🖱️ Image menu - Brightness p.35
Are the cables connected correctly?	Check that all the cables required for projection are securely connected. 🖱️ Quick Start Guide
Is Contrast 🖱️ adjusted correctly?	Adjust the Contrast setting from the Configuration Menu. 🖱️ Image Menu - Contrast p.35
Is the Color Adjustment correctly?	Adjust the Color Adjustment setting from the Configuration Menu. 🖱️ Image Menu - Color Adjustment p.35
Are the Color Saturation and Tint adjusted correctly? Only when projecting images from a video source	Adjust the Color Saturation and Tint settings from the Configuration Menu. 🖱️ Image Menu - Color Saturation, Tint p.35

Images appear dark

Check	Remedy
Is the image Brightness set correctly?	Adjust the Brightness and Brightness Control settings from the Configuration Menu. 🖱️ Image Menu - Brightness p.35 🖱️ Settings Menu - Brightness Control p.37
Is Contrast 🖱️ adjusted correctly?	Adjust the Contrast setting from the Configuration Menu. 🖱️ Image Menu - Contrast p.35
Is the Lamp due for replacement?	When the Lamp is nearly ready for replacement, the images become darker and the color quality becomes poorer. When this happens, replace the Lamp with a new lamp. 🖱️ p.69



Discount-Merchant.com (800) 281-8860
 THE TRUSTED SOURCE FOR PROJECTOR LAMPS AND ACCESSORIES

Problems when projection starts

No power supplied

Check	Remedy
Did you press the [⏻] button?	Press the [⏻] button to turn the power on.
Are the indicators switched off?	The power cable is not connected correctly or power is not being supplied normally. Disconnect and then reconnect the power cable. 🖱 Quick Start Guide Check that your electrical outlet or power source is functioning correctly.
Do the indicators turn on and off when the power cable is touched?	There is probably a poor contact in the power cable, or the power cable may be defective. Reinsert the power cable. If this does not solve the problem, stop using the projector, disconnect the power cable from the electrical outlet, and contact your local dealer or the nearest address provided in the Support and Service Guide. 🖱 Epson Projector Contact List
Is the Control Panel Lock set to Full Lock ?	Press the [⏻] button on the Remote Control. If you do not want to use Control Panel Lock , change the setting to Off . 🖱 Settings Menu - Control Panel Lock p.31
Is the correct setting for the remote receiver selected?	Check the Remote Receiver from the Configuration Menu. 🖱 Settings Menu - Remote Receiver p.37

Other problems

No sound can be heard or the sound is faint

Check	Remedy
Is the audio source connected correctly?	Disconnect the cable from the Audio-L/R input port, and then reconnect the cable.
Is the volume adjusted to the minimum setting?	Adjust the volume so that sound can be heard. 🖱 p.37 🖱 Quick Start Guide
Is A/V Mute active?	Press the [A/V Mute] button on the Remote Control to cancel A/V Mute. 🖱 p.19
Is the audio cable's specification "No resistance"?	When using a commercially available audio cable, make sure it is labeled "No resistance".



Discount-Merchant.com (800) 281-8860





THE TRUSTED SOURCE FOR PROJECTOR LAMPS AND ACCESSORIES

No sound can be heard from the microphone

Check	Remedy
Is the microphone connected correctly?	Disconnect the cable from the Mic Input Port, and then reconnect the cable.

Check	Remedy
Is the Mic Input Volume turned down too low?	Adjust the Mic Input Volume so that sound can be heard.  Settings Menu - Mic Input Volume p.37



The Remote Control does not work

Check	Remedy
Is the Remote Control light-emitting area pointing towards the Remote receiver on the projector when it is operated?	Point the remote control towards the Remote Receiver. Operating range  <i>Quick Start Guide</i>
Is the remote control too far from the projector?	The operating range for the remote control is about 6 m.  <i>Quick Start Guide</i>
Is direct sunlight or strong light from fluorescent lamps shining onto the Remote Receiver?	Set the projector up in a location where strong light does not shine onto the Remote Receiver. Or set the remote receiver to Off from Remote Receiver in the Configuration Menu.  Settings Menu - Remote Receiver p.37
Is the correct setting for the Remote Receiver selected?	Check the Remote Receiver from the Configuration Menu.  Settings Menu - Remote Receiver p.37
Are the batteries dead or have the batteries been inserted correctly?	Make sure the batteries are inserted correctly or replace the batteries with new ones if necessary.  p.68

I want to change the language for messages and menus

Check	Remedy
Change the Language setting.	Adjust the Language setting from the Configuration Menu.  p.39

Mail is not received even if a problem occurs in the projector (EB-826W/825/85)

Check	Remedy
Is Standby Mode set to Communication On?	To use the Mail Notification function when the projector is in standby, set Communication On in Standby Mode from the Configuration Menu.  Extended Menu - Standby Mode p.39
Did a fatal abnormality occur and the projector come to a sudden stop?	When the projector comes to a sudden stop, e-mail cannot be sent. If the abnormal state continues, contact your local dealer or the nearest address provided in the Support and Service Guide.  <i>Epson Projector Contact List</i>
Is power being supplied to the projector?	Check that your electrical outlet or power source is functioning correctly.
Is Mail Notification function set correctly in the Configuration Menu?	Mail notification of problems is sent according to the Mail settings in the Configuration Menu. Check if it is set correctly.  Network menu - Mail menu p.48



Appendix

This chapter provides information on maintenance procedures to ensure the best level of performance from the projector for a long time to come.



Discount-Merchant.com (800) 281-8860
THE TRUSTED SOURCE FOR PROJECTOR LAMPS AND ACCESSORIES

The projector supports the following four different projection methods. Install according to the conditions of the installation location.

Warning

- A special method of installation is required when suspending the projector from a ceiling (ceiling mount). If it is not installed correctly, it could fall causing an accident and injury.
- If you use adhesives on the Ceiling mount fixing points to prevent the screws from loosening, or if you use things such as lubricants or oils on the projector, the projector case may crack causing it to fall from its ceiling mount. This could cause serious injury to anyone under the ceiling mount and could damage the projector.
When installing or adjusting the Ceiling mount, do not use adhesives to prevent the screws from loosening and do not use oils or lubricants and so on.

Attention

Do not use the projector on its side. This may cause malfunctions to occur.

- Project images from in front of the screen. (Front projection)

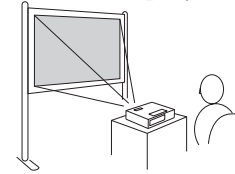

- Project images from behind a translucent screen. (Rear projection)

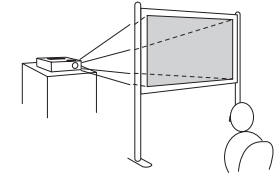

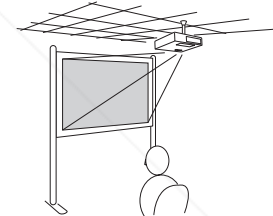

- Suspend the projector from the ceiling and project images from in front of the screen. (Front/Ceiling projection)

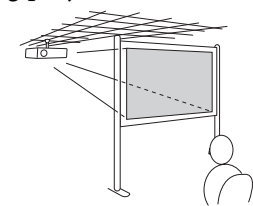

- Suspend the projector from the ceiling and project images from behind a translucent screen. (Rear/Ceiling projection)



- An optional Ceiling mount is required when suspending the projector from a ceiling.  p.75
- You can change the setting as follows by pressing down the [A/V Mute] button on the Remote Control for about five seconds.
Front ↔ Front/Ceiling
Set **Rear** or **Rear/Ceiling** from the Configuration Menu.  p.39

You should clean the projector if it becomes dirty or if the quality of projected images starts to deteriorate.

Cleaning the Projector's Surface

Clean the projector's surface by wiping it gently with a soft cloth. If the projector is particularly dirty, moisten the cloth with water containing a small amount of neutral detergent, and then firmly wring the cloth dry before using it to wipe the projector's surface.

Attention

Do not use volatile substances such as wax, alcohol, or thinner to clean the projector's surface. The quality of the case may change or become discolored.

Cleaning the Lens

Use a commercially available cloth for cleaning glasses to gently wipe the lens.

Attention

Do not rub the lens with harsh materials or subject the lens to shocks, as it can easily become damaged.

Cleaning the Air filter

Clean the air filter and the Air intake vent when the following message is displayed.

The projector is overheating. Make sure nothing is blocking the air vent, and clean or replace the air filter.

Attention

- If dust collects on the air filter it can cause the internal temperature of the projector to rise, and this can lead to problems with operation and shorten the optical engine's service life. Clean the air filter immediately when the message is displayed.
- Do not rinse the air filter in water. Do not use detergents or solvents.

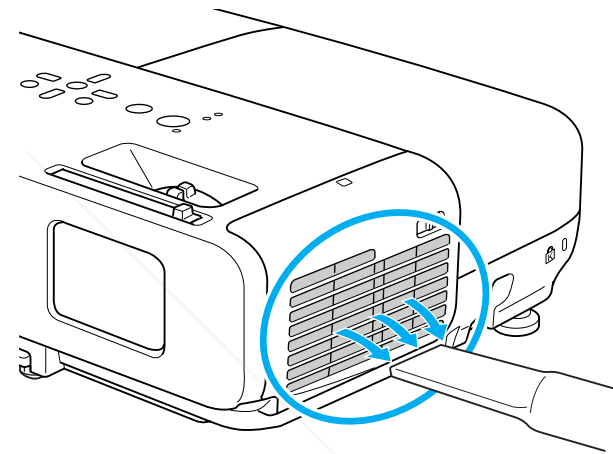

- If a message is frequently displayed, even after cleaning, it is time to replace the air filter. Replace it with a new air filter. [p.72](#)
- It is recommended that you clean these parts at least once every three months. Clean them more often than this if using the projector in a particularly dusty environment.

This section explains how to replace the Remote Control batteries, the Lamp, and the air filter.

Replacing the Remote Control Batteries

If delays in the responsiveness of the Remote Control occur or if it does not operate after it has been used for some time, it probably means that the batteries are becoming flat. When this happens, replace them with new batteries. Have two AA size manganese or alkaline batteries ready. You cannot use other batteries except for the AA size manganese or alkaline.

Attention

Make sure you read the Safety Instructions before handling the batteries. 
Safety Instructions

Procedure

1 Remove the battery cover.

While pushing the battery compartment cover catch, lift the cover up.

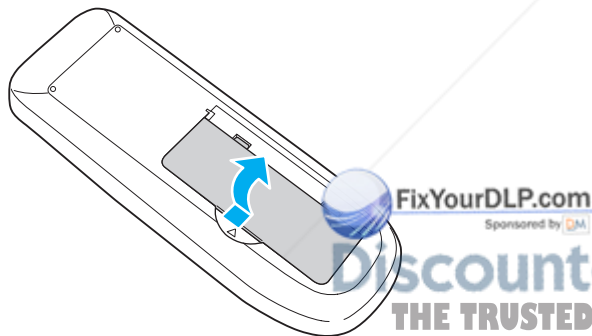

2 Replace the old batteries with new batteries.

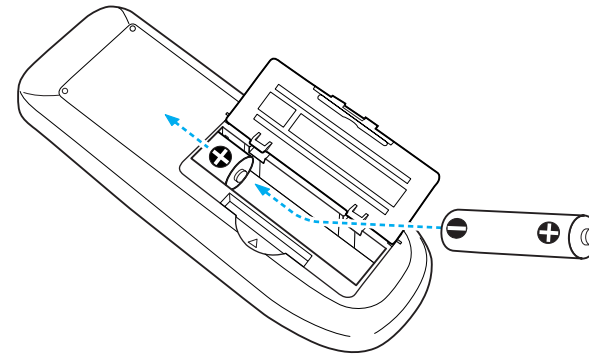

Caution

Check the positions of the (+) and (-) marks inside the battery holder to ensure the batteries are inserted the correct way.

3 Replace the battery cover.

Press the battery compartment cover until it clicks into place.

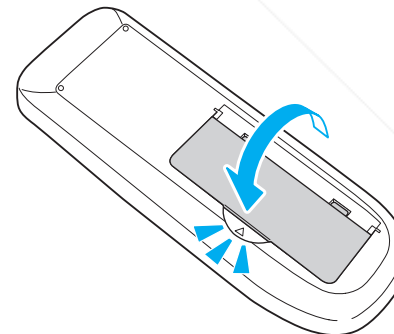

Replacing the Lamp

Lamp replacement period

It is time to replace the Lamp when:

- The message "Replace the lamp. " is displayed when you start projecting.

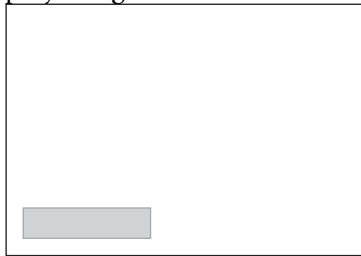

A message is displayed.

- The Lamp indicator flashes orange.

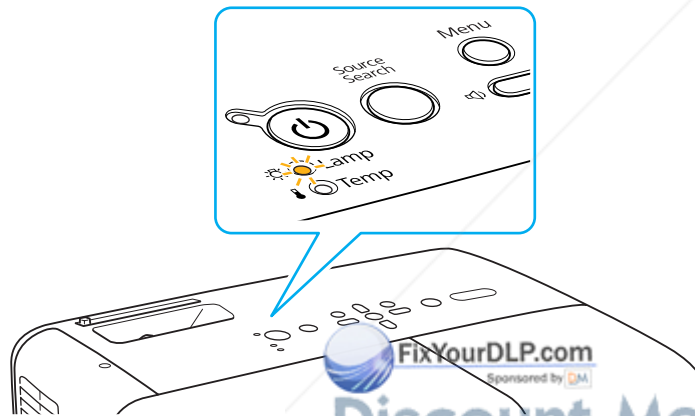

- The projected image gets darker or starts to deteriorate.

Attention

- The lamp replacement message is set to appear after the following time periods in order to maintain the initial brightness and quality of the projected images. [p.37](#)
 When used continually at **High Brightness**: About 5000 hours
 When used continually at **Low Brightness**: About 6000 hours
- If you continue to use the Lamp after the replacement period has passed, the possibility that the lamp may explode increases. When the Lamp replacement message appears, replace the Lamp with a new one as soon as possible, even if it is still working.
- Depending on the characteristics of the Lamp and the way it has been used, the lamp may become darker or stop working before the lamp warning message appears. You should always have a spare lamp unit ready in case it is needed.

How to replace the Lamp

The Lamp can be replaced even when the projector is suspended from a ceiling.

Warning

- When replacing the Lamp because it has stopped illuminating, there is a possibility that the Lamp may be broken. If replacing the Lamp of a projector which has been installed on the ceiling, you should always assume that the Lamp is broken, and you should stand to the side of the Lamp cover, not underneath it. Remove the Lamp cover gently.
- Never disassemble or remodel the Lamp. If a remodeled or reassembled Lamp is installed into the projector and used, it could cause a fire, electric shock, or an accident.



Caution

Wait until the Lamp has cooled down sufficiently before removing the Lamp cover. If the lamp is still hot, burns or other injuries may result. It takes about one hour after the power has been turned off for the Lamp to be cool enough.

Procedure

1

After you turn off the projector's power and the confirmation buzzer beeps twice, disconnect the power cable.

2

Wait until the Lamp has cooled down, then remove the Lamp cover.

Loosen the Lamp cover fixing screw with the screwdriver supplied with the new lamp unit or a + head screwdriver. Then slide the Lamp cover straight forward and lift it to remove.

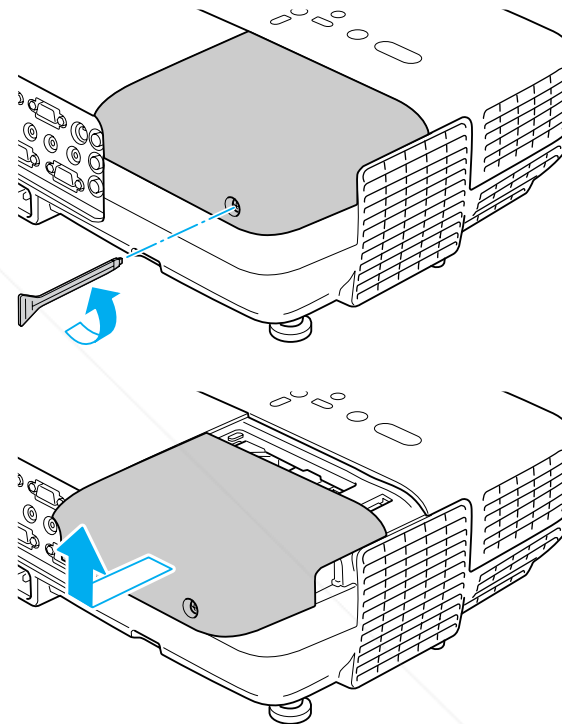

FixYourDLP.com

Sponsored by DM

Discount-Merchant.com (800) 281-8860

THE TRUSTED SOURCE FOR PROJECTOR LAMPS AND ACCESSORIES

- 3** Loosen the two Lamp fixing screws.

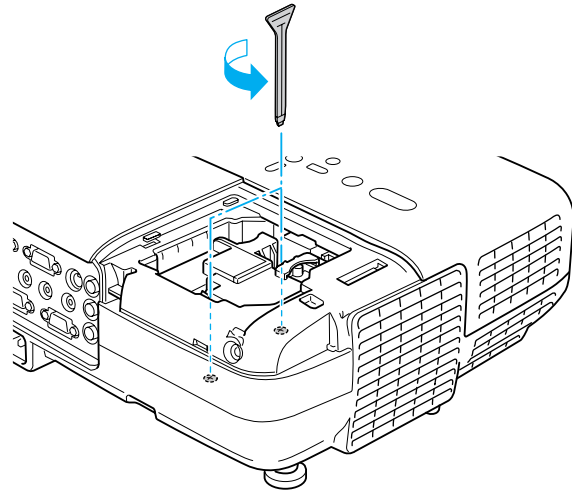

- 4** Take out the old Lamp by pulling the handle.

If the Lamp is cracked, replace it with a new lamp, or contact your local dealer for further advice.  [Epson Projector Contact List](#)

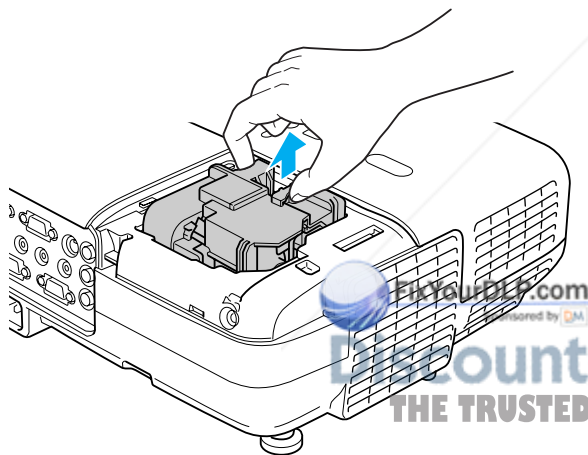

- 5** Install the new Lamp.

Insert the new Lamp along the guide rail in the correct direction so that it fits in place, push down firmly at the location marked "PUSH", and once it is fully inserted tighten the two screws.

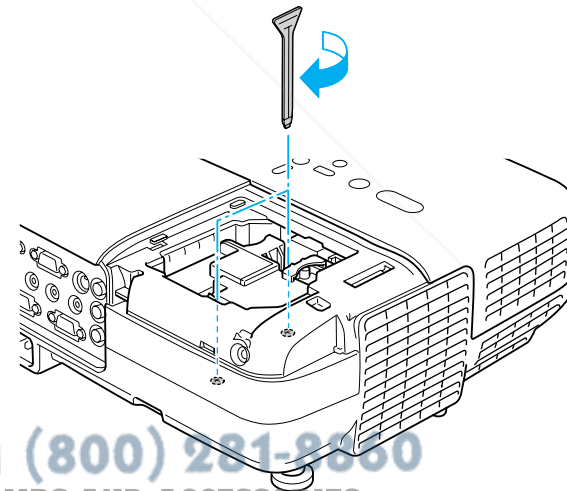
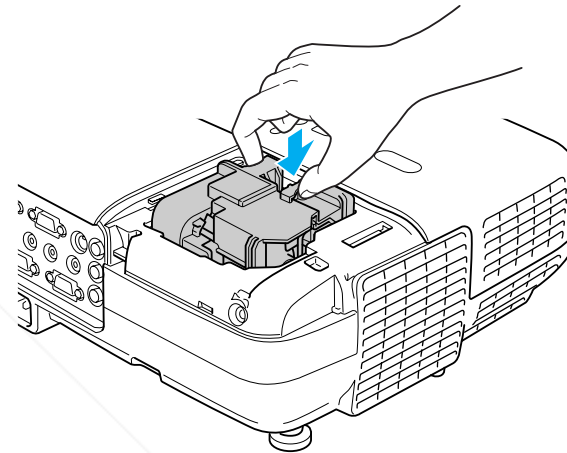

6 Replace the Lamp cover.

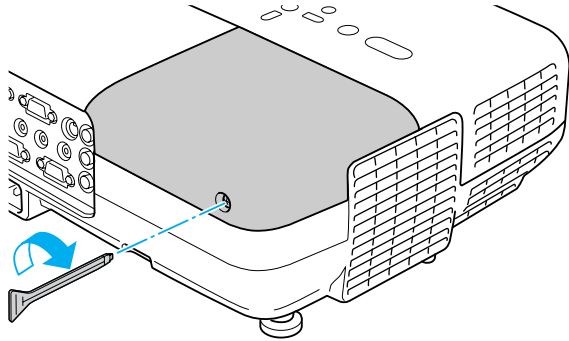

Attention

- Make sure you install the Lamp securely. If the Lamp cover is removed, the Lamp turns off automatically as a safety precaution. If the Lamp or the Lamp cover is not installed correctly, the Lamp does not turn on.
- This product includes a lamp component that contains mercury (Hg). Please consult your local regulations regarding disposal or recycling. Do not dispose of it with normal waste.

Resetting the Lamp Hours

The projector records how long the lamp is turned on and a message and indicator notify you when it is time to replace the lamp. After replacing the Lamp, make sure you reset the Lamp Hours from the Configuration Menu.  [p.52](#)



Only reset the Lamp Hours if the Lamp has been replaced. Otherwise the Lamp replacement period is not indicated correctly.

Replacing the Air Filter

Air filter replacement period

It is time to replace the air filter when:

- The air filter has turned brown.
- The message is displayed even though the air filter has been cleaned.

How to replace the air filter

The air filter can be replaced even when the projector is suspended from a ceiling.

Procedure



After you turn off the projector's power and the confirmation buzzer beeps twice, disconnect the power cable.

2 Open the air filter cover.

Slide the air filter cover open/close switch, and open the air filter cover.

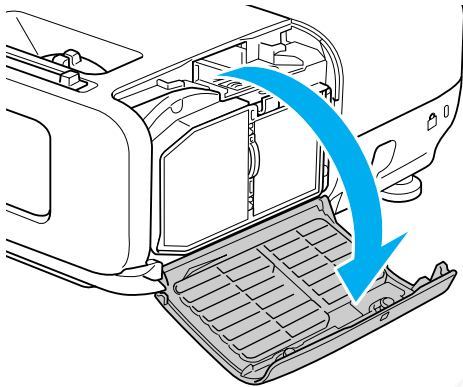
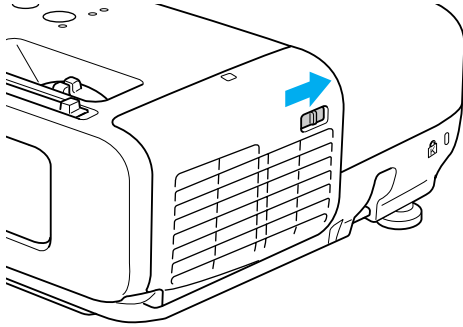

3 Remove the air filter.

Grip the tab in the center of the air filter, and pull it straight out.

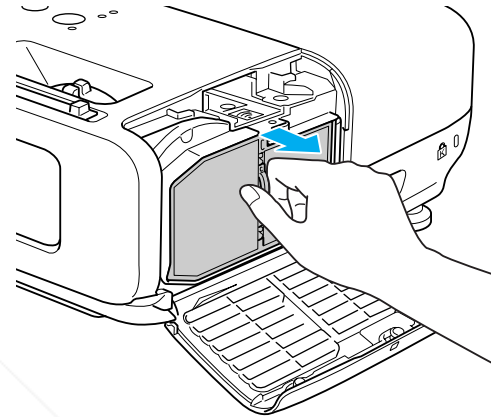

4 Install the new air filter.

Press until it clicks into place.

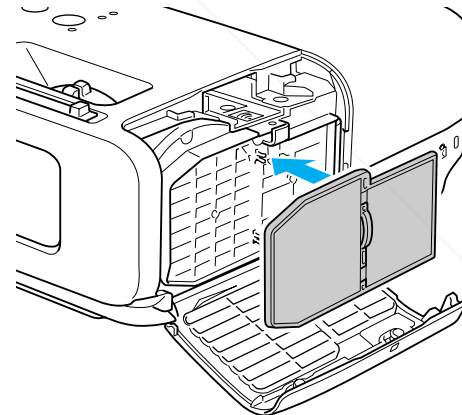

5

Close the air filter cover.



Dispose of used air filters properly in accordance with your local regulations.

Material of the frame part: ABS

Material of the filter part: Polyurethane foam



FixYourDLP.com

Sponsored by 

Discount-Merchant.com (800) 281-8860

THE TRUSTED SOURCE FOR PROJECTOR LAMPS AND ACCESSORIES

The following optional accessories and consumables are available. Please purchase these products as and when needed. The following list of optional accessories and consumables is current as of: 2009.04. Details of accessories are subject to change without notice and availability may vary depending on the country of purchase.

Optional accessories

Soft carrying case ELPKS16B

Use this case if you need to travel with the projector.

60" portable screen ELPSC07

80" portable screen ELPSC08

100" screen ELPSC10

Portable roll-type screens ([Aspect Ratio](#)▶▶ 4:3)

70" portable screen ELPSC23

80" portable screen ELPSC24

90" portable screen ELPSC25

Portable roll-type screens ([Aspect Ratio](#)▶▶ 16:10)

50" portable screen ELPSC06

A compact screen that can be carried easily. (Aspect Ratio 4:3)

Computer cable ELPKC02

(1.8 m - for mini D-Sub15-pin/mini D-Sub 15pin)

This is the same as the computer cable supplied with the projector.

Computer cable ELPKC09

(3 m - for mini D-Sub15-pin/mini D-Sub 15pin)

Computer cable ELPKC10

(20 m - for mini D-Sub15-pin/mini D-Sub 15pin)

Use one of these longer cables if the computer cable supplied with the projector is too short.

Component video cable ELPKC19

(3 m - for mini D-Sub 15-pin/RCA male×3)

Use to connect a [Component Video](#)▶▶ source.

Document Camera ELPDC06

Use when projecting books, OHP documents, or slides.

Wireless LAN Unit ELPAP03 (EB-826W/825/85 only)

Use when connecting the projector to a computer wirelessly and projecting.

Quick Wireless Connection USB Key ELPAP05 (EB-826W/825/85 only)

Use this key to connect to a Windows computer and project images from the computer.

However, the projector needs to be connected to a network before it can be used.

Ceiling pipe (450 mm)* ELPFP13

Ceiling pipe (700 mm)* ELPFP14

Use when installing the projector on a high ceiling.

Ceiling mount* ELPMB23

Use when installing the projector on a ceiling.

* A special method of installation is required to suspend the projector from a ceiling. Contact your dealer or the nearest address provided in the Support and Service Guide if you want to use this installation method.

☛ [Epson Projector Contact List](#)

Consumables

Lamp unit ELPLP50

Use as a replacement for used Lamps.

Air filter ELPAF22

Use as a replacement for used air filters.

You can save the image that is currently being projected as a User's Logo.



When a User's Logo is saved, the previous User's Logo is erased.

Procedure

- 1 Project the image you want to use as the User's Logo, and then press the [Menu] button.

Using the Remote Control

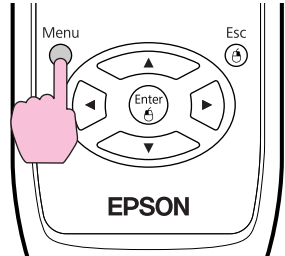

Using the Control panel

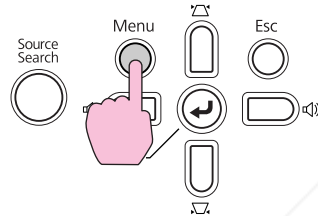

2

- 2 Select **Extended - User's Logo** from the Configuration Menu.  "Using the Configuration Menu" [p.34](#)

Check the buttons you can use and the operations they perform in the guide under the menu.

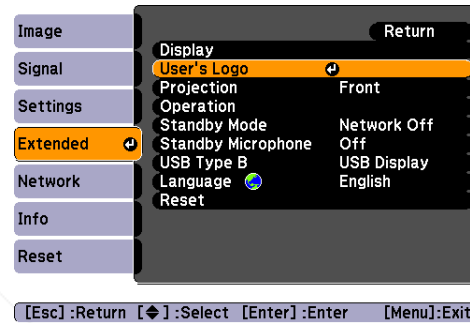

- If **User's Logo Protect** from **Password Protect** is set to **On**, a message is displayed and the user's logo cannot be changed. You can make changes after setting **User's Logo Protect** to **Off**.  [p.29](#)
- If **User's Logo** is selected when **Keystone**, **E-Zoom**, **Aspect**, or **Progressive** are being performed, the function currently being performed is cancelled.

3

- 3 When "Choose this image as the User's Logo?" is displayed, select **Yes**.



When you press the [Enter] button on the Remote Control or the Control panel, the screen size may change according to the signal as it changes to the resolution of the image signal.

- 4** Move the box to select the part of the image to use as the User's Logo.

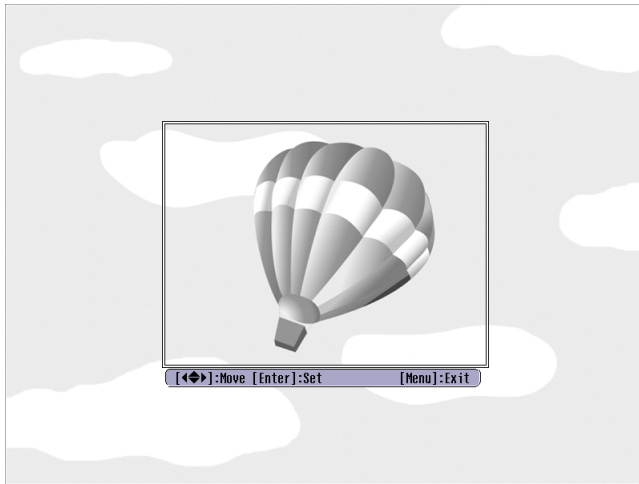

Using the Remote Control

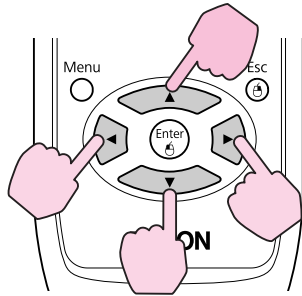

Using the Control panel

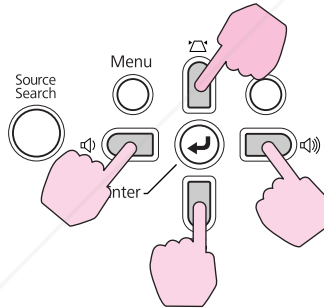

- 6** Select the zoom factor from the zoom setting screen.

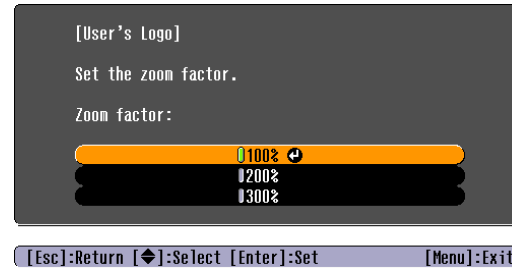

- 7** When the message **Save this image as the User's Logo?** is displayed, select **Yes**.

The image is saved. After the image has been saved, the message **Completed.** is displayed.



- Once a User's Logo has been saved, the logo cannot be returned to the factory default.
- Saving the user's logo may take approximately 15 seconds. Do not use the projector or any connected equipment while it is saving, otherwise malfunctions may occur.



You can save at up to 400 × 300 dots in size.



FixYourDLP.com

Sponsored by DLP

Discount-Merchant.com (800) 281-8860

THE TRUSTED SOURCE FOR PROJECTOR LAMPS AND ACCESSORIES

- 5** When **Select this image?** is displayed, select **Yes**.

To find the appropriate screen size, see the following table to setup the projector. Values are just reference.

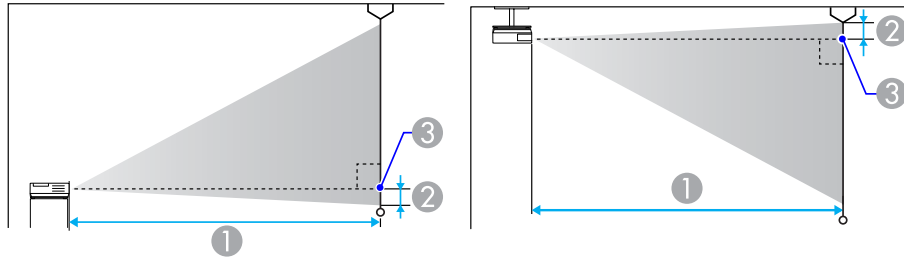

- ① Projection distance
- ② is the distance from the center of the lens to the base of the screen
- ③ Center of lens

Projection Distance (EB-825/824/85/84)

Units: cm

4:3 Screen Size		①	②
		Minimum (Wide) to Maximum (Tele)	
30"	61x46	83 - 136	-5
40"	81x61	111 - 182	-6
50"	100x76	140 - 229	-8
60"	120x90	169 - 275	-9
80"	160x120	226 - 368	-13
100"	200x150	283 - 460	-16
150"	300x230	426 - 692	-23
200"	410x300	568 - 923	-31
250"	500x370	711 - 1155	-39

4:3 Screen Size		①	②
		Minimum (Wide) to Maximum (Tele)	
300"	610x460	854 - 1386	-47

Units: cm

16:9 Screen size		①	②
		Minimum (Wide) to Maximum (Tele)	
30"	66x37	91 - 149	1
40"	89x50	122 - 199	1
50"	110x62	153 - 249	2
60"	130x75	184 - 300	2
80"	180x100	246 - 401	3
100"	220x120	308 - 502	4
150"	330x190	464 - 754	6
200"	440x250	619 - 1006	7
250"	550x310	775 - 1258	9
275"	610x340	853 - 1384	10

Projection Distance (EB-826W)

Units: cm

4:3 Screen Size		①	②
		Minimum (Wide) to Maximum (Tele)	
30"	61x46	100 - 164	-1

4:3 Screen Size		①	②
		Minimum (Wide) to Maximum (Tele)	
40"	81x61	134 - 219	-1
50"	100x76	169 - 275	-2
60"	120x90	203 - 331	-2
80"	160x120	271 - 442	-3
100"	200x150	340 - 553	-4
120"	240x180	408 - 664	-4
150"	300x230	511 - 831	-5
200"	410x300	682 - 1108	-7
250"	500x370	854 - 1386	-9

Units: cm

16:9 Screen size		①	②
		Minimum (Wide) to Maximum (Tele)	
30"	66x37	91 - 149	1
40"	89x50	122 - 199	1
50"	110x62	153 - 249	2
60"	130x75	184 - 300	2
80"	180x100	246 - 401	3
100"	220x120	308 - 502	4
150"	330x190	464 - 754	6
200"	440x250	619 - 1006	7
250"	550x310	775 - 1258	9
275"	610x340	853 - 1384	10

Units: cm

16:10 Screen size		①	②
		Minimum (Wide) to Maximum (Tele)	
30"	60x30	88 - 144	-1
40"	80x50	118 - 193	-1
50"	110x70	149 - 243	-2
60"	130x80	179 - 292	-2
80"	170x110	239 - 390	-2
100"	210x130	300 - 488	-3
150"	320x200	451 - 733	-5
200"	420x260	603 - 979	-6
250"	530x330	754 - 1224	-8
280"	590x370	845 - 1371	-9

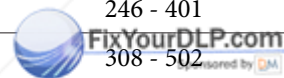

Discount-Merchant.com (800) 281-8860

THE TRUSTED SOURCE FOR PROJECTOR LAMPS AND ACCESSORIES

USB memories and USB compatible digital cameras, hard disk drives, and the optional Document Camera can be connected to the projector. Images on the connected digital camera or JPEG files on the USB storage device can be played back as a Slideshow. [Projector Operation Guide "Slideshow Basic Operations"](#)

When the optional Document Camera is connected, images from the Document Camera will be projected.

Connecting USB Devices

The following procedure describes how to connect USB devices, using the optional Document Camera as an example. Connect the Document Camera to the projector using the USB cable supplied with the Document Camera. When the Document Camera is connected to the projector during projection, press the [USB] button on the remote control or the [Source Search] button on the control panel to switch to images from the Document Camera. [p.16](#)

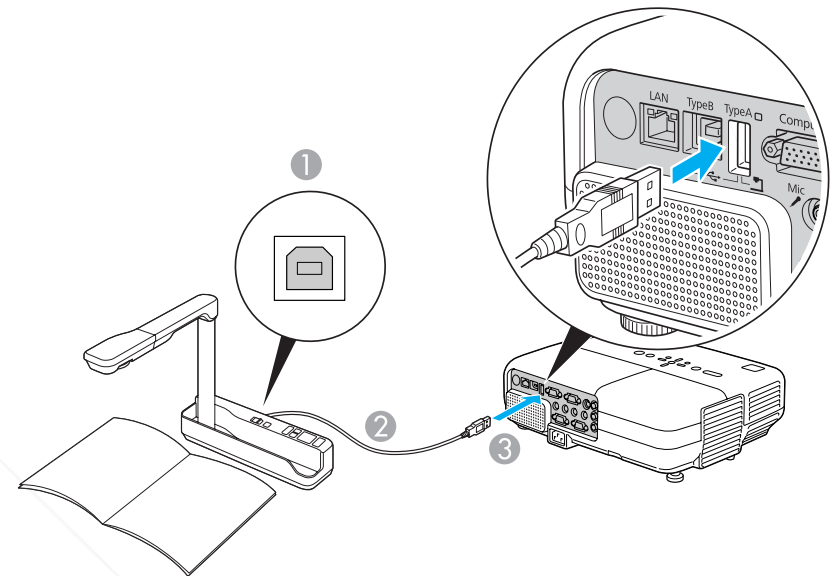

- ① To Document Camera USB port
- ② USB cable
- ③ USB Port (TypeA)

Attention

- If you use a USB hub, the connection may not operate correctly. Devices such as digital cameras and USB storage devices should be connected to the projector directly.
- When connecting and using a USB-compatible hard disk, make sure you connect the AC adaptor supplied with the hard disk.
- Connect a digital camera or hard disk to the projector using a USB cable provided with, or specified for use with the device.
- Use a USB cable less than 3 m in length. If the cable exceeds 3 m, Slideshow may not function correctly.

Removing USB Devices

After finishing projecting, follow the procedure below to remove USB devices from the projector.

Procedure

Remove the optional Document Camera from the projector's USB Port (TypeA).

For digital cameras, hard disks, and so on, turn off the power to the device and then remove.



Discount-Merchant.com (800) 281-8860
THE TRUSTED SOURCE FOR PROJECTOR LAMPS AND ACCESSORIES

By using the supplied USB cable to connect the projector to a Windows computer you can project images from the computer. This function is called USB Display. Simply by connecting via a USB cable, images from the computer can be displayed.

Connecting

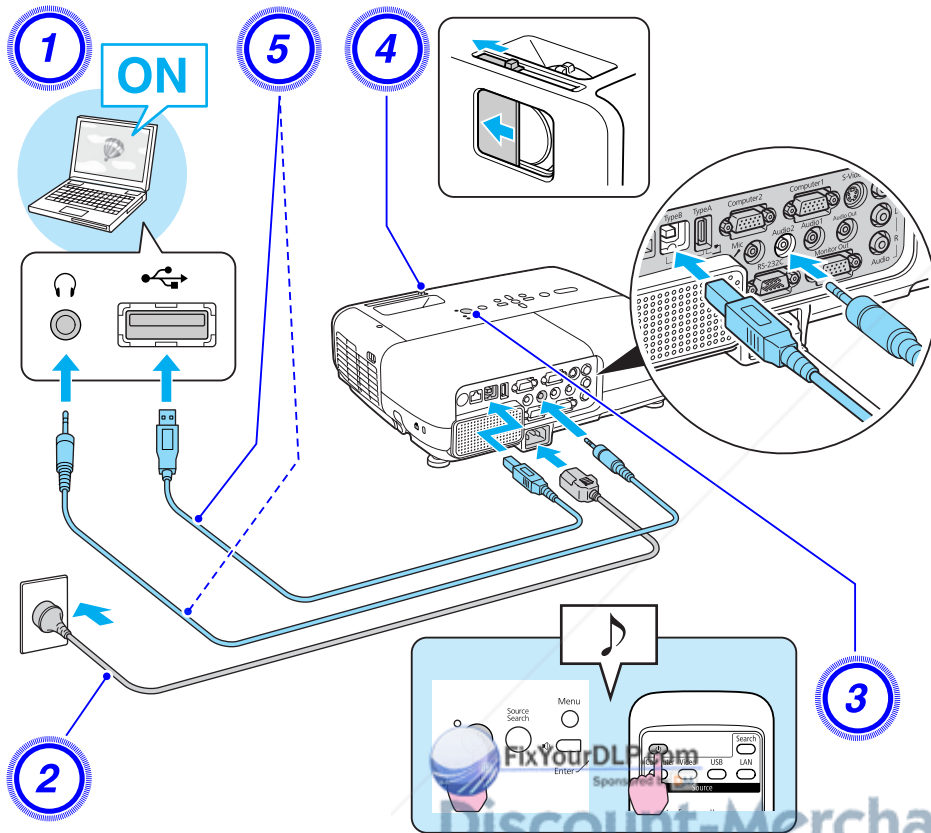

- ② **Connect to the power cable (supplied).**
- ③ **Turn the computer on.**
- ④ **Open the A/V mute slide knob.**
- ⑤ **Connect to the USB cable.**
When audio is output from the projector's speaker, connect an audio cable (commercially available) to the Audio2 Port.
 - ☛ "Connecting for the first time" [p.83](#)
 - ☛ "From the second time" [p.84](#)

Attention
Connect the projector directly to the computer and not via a USB hub.

Procedure

- ① **Turn the computer on.**

Connecting for the first time

Procedure

1 Driver installation starts automatically.

When you are using a Windows 2000 computer, click Computer - All Programs - EPSON Projector - EPSON USB Display - EPSON USB Display Vx.x.

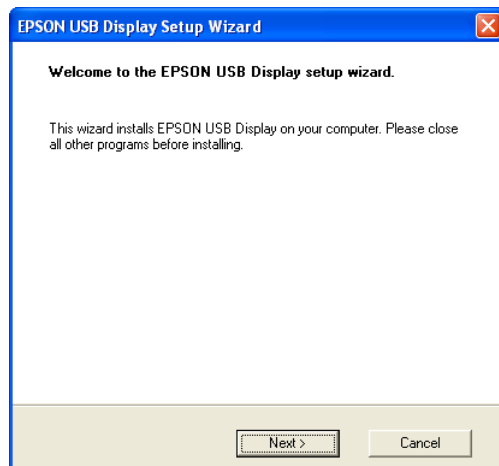

When using a computer running Windows 2000 under user authority, a Windows error message is displayed during installation and you may not be able to install the software. In this case, try updating Windows to the latest version, restart, and then try to connect again. For more details, contact the nearest address provided in the Support and Service Guide.  [Epson Projector Contact List](#)

2 Click "Agree".

If the driver is not installed, you cannot start USB Display. Select **Agree** to install the driver. If you want to cancel installation, click **Disagree**.

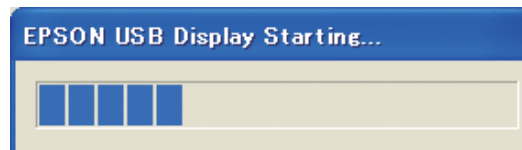

3 Computer images are projected.

It may take a while before computer images are projected. Until computer images are projected, leave the equipment as it is and do not disconnect the USB cable or turn off the power to the projector.

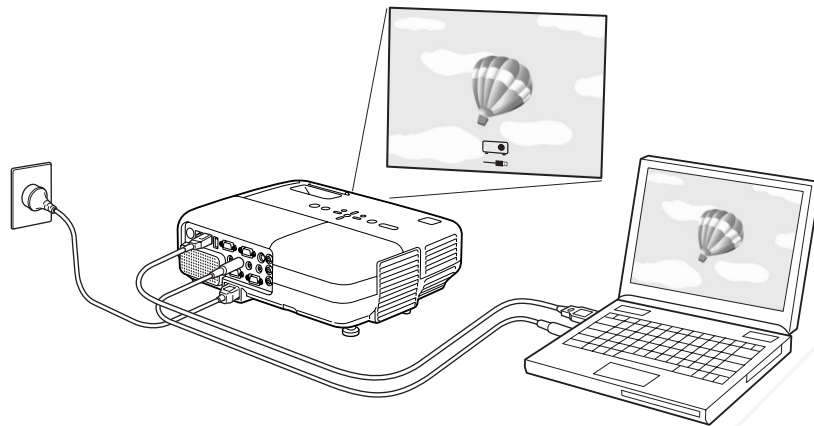

From the second time

Computer images are projected.

It may take a while before computer images are projected. Please wait.



Applications that use part of DirectX functions may not be displayed correctly. (Windows only)



- If nothing is projected for some reason, click **All Programs - EPSON Projector - EPSON USB Display - EPSON USB Display Vx.x**, on your computer.
- If it is not installed automatically, double-click **My Computer - EPSON_PJ_UD - EMP_UDSE.EXE**, on your computer.
- If the mouse pointer flickers on the computer screen, click **All Programs - EPSON Projector - EPSON USB Display - EPSON USB Display Vx.x**, and then clear the **Transfer layered window** checkbox.
- To uninstall the driver, open **Control Panel - Add/Remove Programs** - and uninst **EPSON USB Display Vx.x**.
- **Disconnecting**
The projector can be disconnected simply by disconnecting the USB cable. There is no need to use the **Safely Remove Hardware** feature in Windows.



Sponsored by

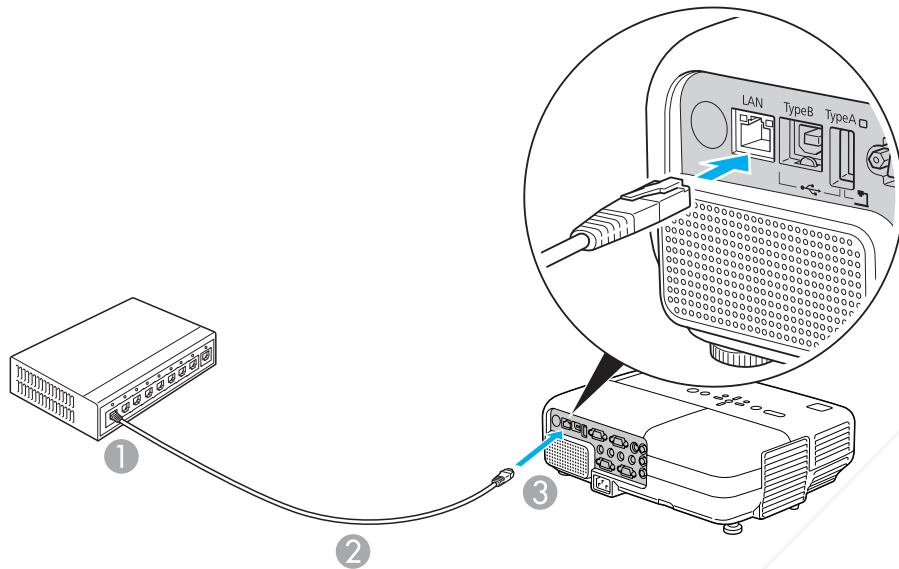

DiscountMerchant.com (800) 281-8860
THE TRUSTED SOURCE FOR PROJECTOR LAMPS AND ACCESSORIES

Connect with a commercially available 100BASE-TX or 10BASE-T LAN cable. Depending on the model, the following diagrams and interfaces may differ.



- ① To LAN port
- ② LAN cable (commercially available)
- ③ To LAN port

Attention
To prevent malfunctions, use a category 5 shielded LAN cable.

 FixYourDLP.com
Sponsored by 

Discount-Merchant.com (800) 281-8860
THE TRUSTED SOURCE FOR PROJECTOR LAMPS AND ACCESSORIES

Procedure

1 Open the air filter cover.

Slide the air filter cover open/close switch, and open the air filter cover.

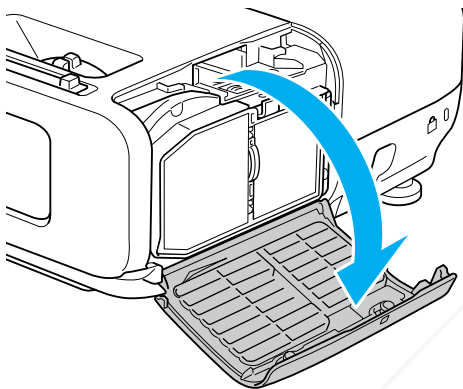
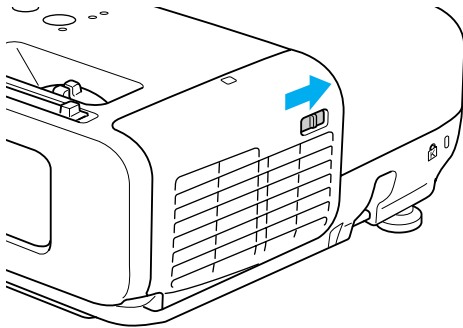

2 Install the Wireless LAN unit.

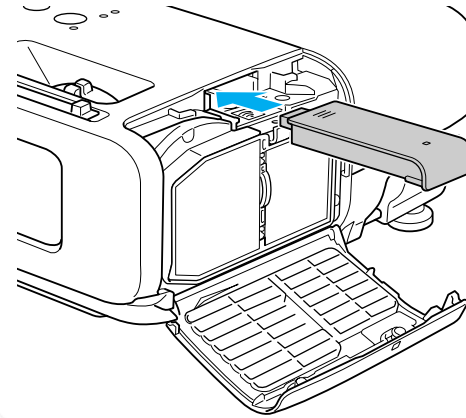

3 Secure the Wireless LAN unit using the screw included to avoid losing the unit.

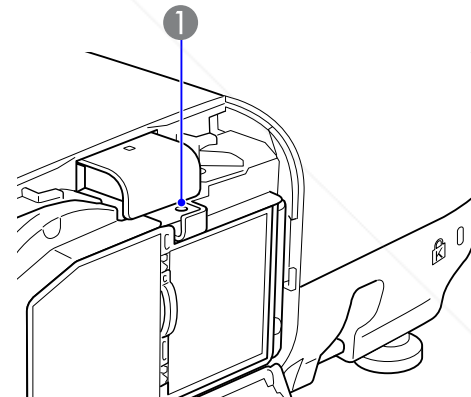

1 Screw hole to fix wireless LAN unit

Connecting to an external monitor (EB-826W/ 825/85/84 only)

You can display computer images input from Computer1/2 Input Port on an external monitor and the screen connected to the projector at the same time. This means that you can check projected images on an external monitor when giving presentations even if you cannot see the screen. Connect using the cable supplied with the external monitor.

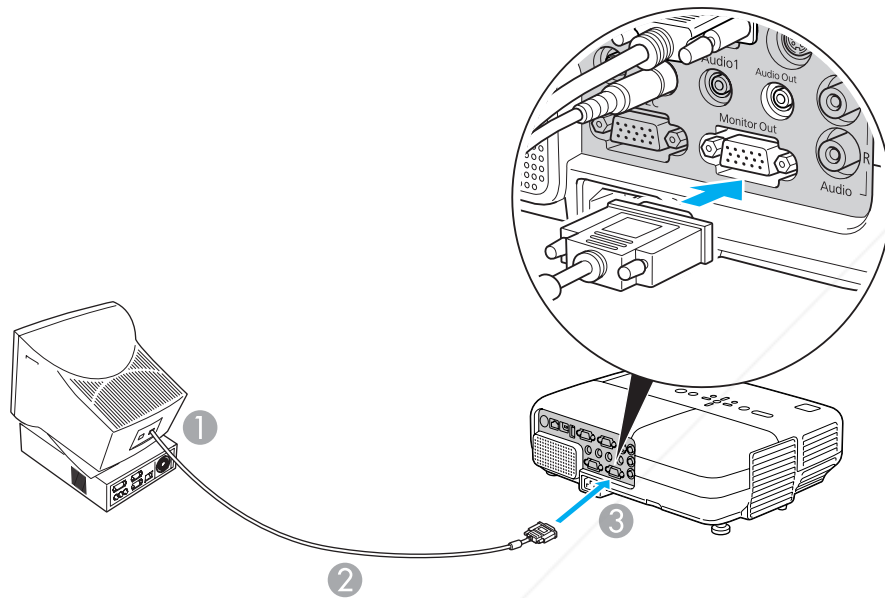

- 1 To Monitor port
- 2 Cable supplied with monitor
- 3 To Monitor Out Port



- You cannot display images from equipment connected to the Component Video signal, Video input port, or S-Video input port on the external monitor.
- Setting gauges, Configuration Menu, or Help screens for functions such as Keystone are not output to the external monitor.

Connecting to an external speaker (EB-826W/825/85/84 only)

You can connect speakers with built-in amplifiers to the projector's Audio Out port to enjoy a fuller quality of sound. Connect with a commercially available audio cable (such as pin plug ↔ 3.5 mm stereo mini plug). Use an audio cable compatible with the connector on the external speakers.

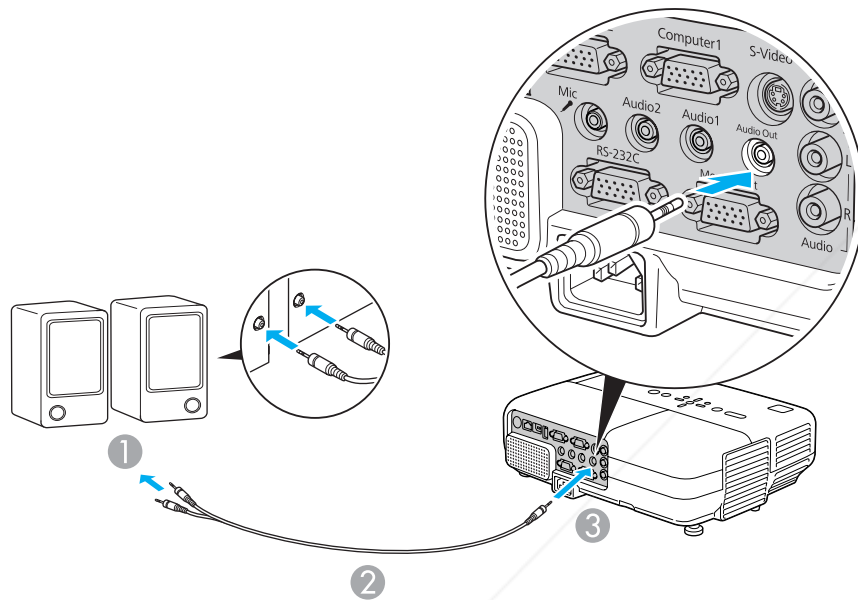

- ① To external audio equipment
- ② Audio cable (commercially available)
- ③ To Audio Out Port



- When the audio cable jack is inserted into the Audio Out Port, audio stops being output from the projector's built-in speakers and switches to external output.
- When using a commercially available 2RCA(L/R)/stereo mini-pin audio cable, make sure it is labeled "No resistance".

Connecting a microphone

You can output microphone audio from the projector's speaker by connecting a dynamic mic to the projector's Mic Input Port. The projector does not support plug-in-power.

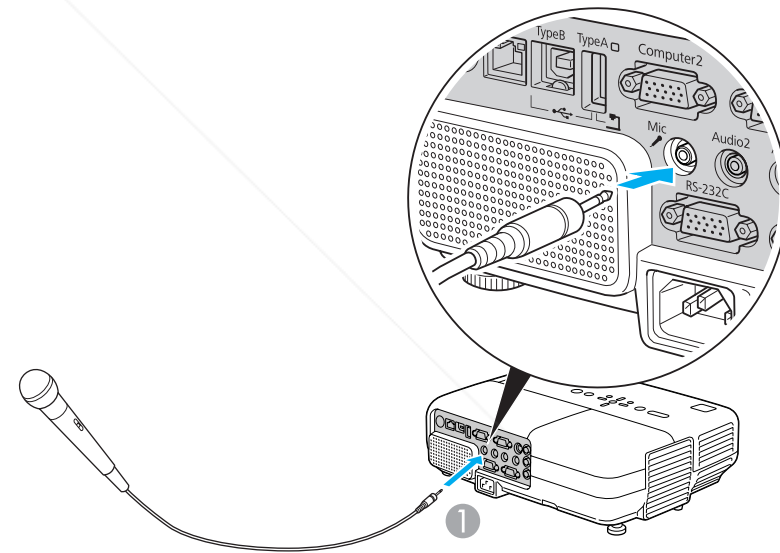

- ① To Mic Input Port

When the Mail Notification function is set to **On** and a problem/warning occurs in the projector, the following e-mail will be sent.

Subject: EPSON Projector

Line 1: The Projector Name where the problem has occurred

Line 2: The IP Address set for the projector where the problem has occurred.

Line 3 and on: Details of the problem

The details of the problem are listed line by line. The following table shows the details that are given in the message for each item. To deal with problems/warnings, see ["Reading the Indicators"](#).  [p.55](#)

Message	Cause
Internal error	Internal Error
Fan related error	Fan Error
Sensor error	Sensor Error
Lamp cover is open.	Lamp Cover Open
Lamp timer failure	Lamp Failure
Lamp out	Lamp Error
Internal temperature error	High Temp Error (Overheating)
High-speed cooling in progress	High Temp Warning
Lamp replacement notification	Replace Lamp
No-signal	No Signal No Signal is input to the projector. Check the connection status or check at the power on the signal source is turned on.
Auto Iris Error	Auto Iris Error

Message	Cause
Power Err. (Ballast)	Power Err. (Ballast)

A (+) or (-) appears at the start of the message.

(+): A projector problem has occurred

(-): A projector problem has been dealt with

Command List

When the power ON command is transmitted to the projector, the power turns on and it enters warm-up mode. When the projector's power has turned on, a colon ":" (3Ah) is returned.

When a command is input, the projector executes the command and returns a ":", and then accepts the next command.

If the command being processed terminates abnormally, an error message is output and a ":" is returned.

Item		Command	
Power ON/OFF	On	PWR ON	
	Off	PWR OFF	
Signal selection	Computer1	Auto	SOURCE 1F
		RGB	SOURCE 11
		Component	SOURCE 14
	Computer2	Auto	SOURCE 2F
		RGB	SOURCE 21
		Component	SOURCE 24
	Video		SOURCE 41
	S-Video		SOURCE 42
	USB Display		SOURCE 51
	USB (EB-826W/825/824/85)		SOURCE 52
	LAN(EB-826W/825/85)		SOURCE 53
A/V Mute On/Off	On	MUTE ON	
	Off	MUTE OFF	
A/V Mute selection	Black	MSEL 00	
	Blue	MSEL 01	

Item	Command
Logo	MSEL 02

Add a Carriage Return (CR) code (0Dh) to the end of each command and transmit.

Cable Layouts

Serial Connection

- Connector shape: D-Sub 9-pin (male)

- Projector input port name: RS-232C

<At the projector>

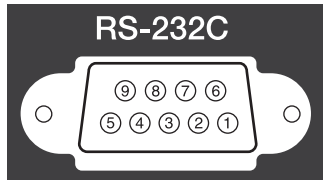

<At the computer>

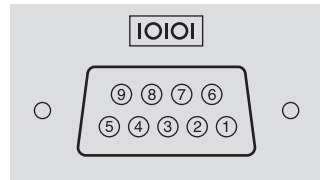

- Data length: 8 bit
- Parity: None
- Stop-bit: 1 bit
- Flow control: None

<At the projector>

(PC serial cable)

<At the computer>

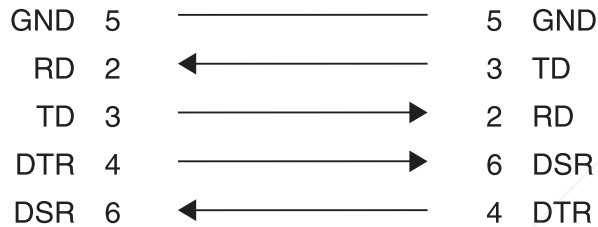

Signal Name	Function
GND	Signal wire ground
TD	Transmit data
RD	Receive data
DSR	Data set ready
DTR	Data terminal ready



Discount-Merchant.com (800) 281-8860
 THE TRUSTED SOURCE FOR PROJECTOR LAMPS AND ACCESSORIES

Communications protocol

- Default baud rate setting: 9600 bps

PJLink Class1 was established by the JBMIA (Japan Business Machine and Information System Industries Association) as a standard protocol for controlling network-compatible projector's as part of their efforts to standardize projector control protocols.

The projector complies with the PJLink Class1 standard established by the JBMIA.

It complies with all commands except for the following commands defined by PJLink Class1, and agreement was confirmed by the PJLink standard adaptability verification.

URL:<http://pjlink.jbmia.or.jp/english/>

• **Non-compatible commands**

Function		PJLink Command
Mute settings	Image muting set	AVMT 11
	Audio muting set	AVMT 21

• **Input names defined by PJLink and corresponding projector sources**

Source	PJLink Command
Computer1	INPT 11
Computer2	INPT 12
Video	INPT 21
S-Video	INPT 22
USB *1	INPT 41
LAN *2	INPT 52
USB Display	INPT 53

*1 Only supported by EB-826W/825/824/85

*2 Only supported by EB-826W/825/85

• Model name displayed for "Product name information query"

EB-826W

EB-825

EB-824

EB-85

EB-84

• Manufacturer name displayed for "Manufacture name information query"

EPSON



Supported Monitor Displays (EB-825/824/85/84)

Computer signals (analog RGB)

Units: dots

Signal	Refresh Rate (Hz)	Resolution	Aspect Mode		
			Normal	4:3	16:9
VGAEGA	70	640x350	1024x560	1024x768	1024x576
VGA	60/72/75/85/iMac*1	640x480/640x360*2	1024x768	1024x768	1024x576
SVGA	56/60/72/75/85/iMac*1	800x600/800x450*2	1024x768	1024x768	1024x576
XGA	60/70/75/85/iMac*1	1024x768/1024x576*2	1024x768	1024x768	1024x576
WXGA	60	1280x768	1024x614	1024x768	1024x576
	60	1360x768	1024x578	1024x768	1024x576
	60/75/85	1280x800	1024x640	1024x768	1024x576
WXGA+	60/75/85	1440x900	1024x640	1024x768	1024x576
SXGA	70/75/85	1152x864	1024x768	1024x768	1024x576
	60/75/85	1280x1024	960x768	1024x768	1024x576
	60/75/85	1280x960	1024x768	1024x768	1024x576
SXGA+	60/75/85	1400x1050	1024x768	1024x768	1024x576
UXGA	60	1600x1200	1024x768	1024x768	1024x576
MAC13"	67	640x480	1024x768	1024x768	1024x576
MAC16"	75	832x624	1024x768	1024x768	1024x576
MAC19"	60	1024x768	1024x768	1024x768	1024x576
	75	1024x768	1024x768	1024x768	1024x576
MAC21"	75	1152x870	1016x768	1024x768	1024x576

*1 Connection is disabled if the equipment does not have a VGA output port.

*2 Letterbox signal

Even when signals other than those mentioned above are input, it is likely that the image can be projected. However, not all functions may be supported.





Component Video

Units: dots

Signal	Refresh Rate (Hz)	Resolution	Aspect Mode	
			4:3	16:9
SDTV(480i)	60	720x480/720x360*	1024x768	1024x576
SDTV(576i)	50	720x576/720x432*	1024x768	1024x576
SDTV(480p)	60	720x480/720x360*	1024x768	1024x576
SDTV(576p)	50	720x576/720x432*	1024x768	1024x576
HDTV(720p)	50/60	1280x720	1024x768	1024x576
HDTV(1080i)	50/60	1920x1080	1024x768	1024x576
HDTV(1080p)	50/60	1920x1080	1024x768	1024x576

* Letterbox signal

Composite Video/S-Video

Units: dots

Signal	Refresh Rate (Hz)	Resolution	Aspect Mode	
			4:3	16:9
TV(NTSC)	60	720x480/720x360*	1024x768	1024x576
TV(PAL,SECAM)	50	720x576/720x432*	1024x768	1024x576

* Letterbox signal



Discount-Merchant.com (800) 281-8860
 THE TRUSTED SOURCE FOR PROJECTOR LAMPS AND ACCESSORIES

Supported Monitor Displays (EB-826W)

Computer signals (analog RGB)

Units: dots

Signal	Refresh Rate (Hz)	Resolution	Aspect Mode				
			Normal	16:9	Full	Zoom	Through
VGAEGA	70	640x350	1280x700	1280x720	1280x800	1280x700	640x350
VGA	60/72/75/85/iMac* ¹	640x480/640x360* ²	1066x800	1280x720	1280x800	1280x800	640x480
SVGA	56/60/72/75/85/iMac* ¹	800x600/800x450* ²	1066x800	1280x720	1280x800	1280x800	800x600
XGA	60/70/75/85/iMac* ¹	1024x768/1024x576* ²	1066x800	1280x720	1280x800	1280x800	1024x768
WXGA	60	1280x768	1280x768	1280x720	1280x800	1280x768	1280x768
	60	1360x768	1280x722	1280x720	1280x800	1280x722	1280x768
	60/75/85	1280x800	1280x800	1280x720	1280x800	1280x800	1280x800
WXGA+	60/75/85	1440x900	1280x800	1280x720	1280x800	1280x800	1280x800
WSXGA+ ^{*3}	60	1680x1050	1280x800	1280x720	1280x800	1280x800	1280x800
SXGA	70/75/85	1152x864	1066x800	1280x720	1280x800	1280x800	1280x800
	60/75/85	1280x1024	1000x800	1280x720	1280x800	1280x800	1280x800
	60/75/85	1280x960	1066x800	1280x720	1280x800	1280x800	1280x800
SXGA+	60/75/85	1400x1050	1066x800	1280x720	1280x800	1280x800	1280x800
UXGA	60	1600x1200	1066x800	1280x720	1280x800	1280x800	1280x800
MAC13"	67	640x480	1066x800	1280x720	1280x800	1280x800	640x480
MAC16"		832x624	1066x800	1280x720	1280x800	1280x800	832x624
MAC19"		1024x768	1066x800	1280x720	1280x800	1280x800	1024x768
	60	1024x768	1066x800	1280x720	1280x800	1280x800	1024x768



FixYourDLP.com

Sponsored by

Discount-Merchant.com (800) 281-8860

THE TRUSTED SOURCE FOR PROJECTOR LAMPS AND ACCESSORIES

Signal	Refresh Rate (Hz)	Resolution	Aspect Mode				
			Normal	16:9	Full	Zoom	Through
MAC21"	75	1152x870	1059x800	1280x720	1280x800	1280x800	1152x800

*1 Connection is disabled if the equipment does not have a VGA output port.

*2 Letterbox signal

*3 Only compatible when **Wide** is selected as the **Resolution** from the Configuration Menu.  p.36

Even when signals other than those mentioned above are input, it is likely that the image can be projected. However, not all functions may be supported.

Component Video

Units: dots

Signal	Refresh Rate (Hz)	Resolution	Aspect Mode				
			Normal	16:9	Full	Zoom	Through
SDTV(480i)	60	720x480/720x360*	1066x800	1280x720	1280x800	1280x800	640x480
SDTV(576i)	50	720x576/720x432*	1066x800	1280x720	1280x800	1280x800	768x576
SDTV(480p)	60	720x480/720x360*	1066x800	1280x720	1280x800	1280x800	640x480
SDTV(576p)	50	720x576/720x432*	1066x800	1280x720	1280x800	1280x800	768x576
HDTV(720p)	50/60	1280x720	1280x720	1280x720	1280x800	1280x720	1280x720
HDTV(1080i)	50/60	1920x1080	1280x720	1280x720	1280x800	1280x720	1280x800
HDTV(1080p)	50/60	1920x1080	1280x720	1280x720	1280x800	1280x720	1280x800

* Letterbox signal

Composite Video/S-Video

Units: dots

Signal	Refresh Rate (Hz)	Resolution	Aspect Mode				
			Normal	16:9	Full	Zoom	Through
TV(NTSC)	60	720x480/720x360*	1066x800	1280x720	1280x800	1280x800	640x480
TV(PAL,SECAM)	50	720x576/720x432*	1066x800	1280x720	1280x800	1280x800	768x576

* Letterbox signal

Projector General Specifications

Product name		EB-826W	EB-825	EB-85	EB-84	EB-824
Dimensions		327 (W) × 95 (H) × 250 (D) mm (not including raised section)				
Panel size		0.59" Wide	0.63"			
Display method		Polysilicon TFT active matrix				
Resolution		1,024,000 pixels WXGA (1280 (W) × 800 (H) dots) × 3	786,432 pixels (1024 (H) × 768 (W) dots) × 3			
Focus adjustment		Manual				
Zoom adjustment		Manual (1 to 1.62)				
Lamp		UHE lamp, 200 W Model No.: ELPLP50				
Max. audio output		10 W monaural				
Speaker		1				
Power supply		100 to 240 V AC ±10%, 50/60 Hz 3.3 to 1.5 A				
Power consumption	100 to 240 V area	Operating: 289 W Standby power consumption (Communication On): 7.9 W Standby power consumption (Communication Off): 1.9 W				Operating: 289 W Standby power consumption: 1.9 W
	200 to 240 V area	Operating: 275 W Standby power consumption (Communication On): 8.9 W Standby power consumption (Communication Off): 3.0 W				Operating: 275 W Standby power consumption: 3.0 W
Operating altitude		Altitude 0 to 2,286 m				
Operating temperature		5 to +35°C (No condensation)				
Storage temperature		-10 to +60°C (No condensation)				
Mass		Approx. 0.0 kg				



FixYourDLP.com

Sponsored by

Discount-Merchant.com (800) 281-8860

THE TRUSTED SOURCE FOR PROJECTOR LAMPS AND ACCESSORIES

Product name			EB-826W	EB-825	EB-85	EB-84	EB-824	
Connectors	Computer1 Input Port	1	Mini D-Sub15-pin (female) blue					
	Computer2 Input Port	1	Mini D-Sub15-pin (female) blue					
	Audio1 Port	1	Stereo mini jack					
	Audio2 Port	1	Stereo mini jack					
	Video input port	1	RCA pin jack					
	S-Video input port	1	Mini DIN 4-pin					
	Audio Port	1	RCA pin jack x 2 (L, R)					
	Mic Input Port	1	Stereo mini jack					
	Audio Out Port	1	Stereo mini jack					-
	Monitor Out Port	1	Mini D-Sub15-pin (female) black					-
	USB Port (TypeB)*	1	USB connector (Type B)					
	USB Port (TypeA)*	1	USB connector (Type A)			-	USB connector (Type A)	
	USB Port	1	USB Connector (Type A) for Optional Wireless LAN Unit			-		
	LAN Port	1	RJ-45					-
	RS-232C Port	1	Mini D-Sub 9-pin (male)					

* Supports USB 2.0. However, USB ports are not guaranteed to operate all devices that support USB.

This product is also designed for IT power distribution system with phase-to-phase voltage 230V.



Pixelworks DNX™ ICs are used in this projector.

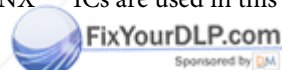

Discount-Merchant.com (800) 281-8860
THE TRUSTED SOURCE FOR PROJECTOR LAMPS AND ACCESSORIES

Angle of tilt

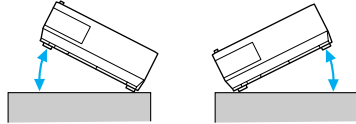

If you use the projector tilted at an angle of more than 30° it could be damaged and cause an accident.

Software Requirement

The software supplied with the projector or the optional accessories runs on computers that meet the following requirements. EMP NS Connection is only supplied with EB-826W/825/85.

	EMP NS Connection	EMP Monitor	USB Display
OS	Windows 2000 SP4/XP/XP SP1/XP SP2/XP SP3/ Vista/Vista SP1 Mac OS X 10.3 or later Recommended: Mac OS X 10.5.1 or later, 10.4.11/10.3.9	Windows 98 SE SP1/Me/NT4.0 SP6/2000SP4/ XP 32Bit (HomeEdition/Professional) SP1 or later Vista/VistaSP1*	Windows 2000 SP4/XP/XP SP1/XP SP2/XP SP3/ Vista/Vista SP1
CPU	Mobile Pentium III 1.2GHz or faster Power PC G3 900MHz or faster Recommended: Pentium M 1.6GHz or faster CoreDuo 1.5GHz or faster	Recommended: Pentium MMX 166MHz or faster Recommended: Pentium II 233MHz or faster	Mobile Pentium III 1.2GHz or faster Recommended: Pentium M 1.6GHz or faster
Amount of Memory	256MB or more Recommended: 512MB or more	64MB or more	256MB or more Recommended: 512MB or more
Hard Disk Free space	20MB or more	50MB or more	20MB or more
Display	Resolution greater than XGA (1024x768) Display color of approx. 32000 colors more than 16 bit colors	Resolution greater than SVGA (800x600) Display color in 32 bit full-color or greater Display Color	Resolution greater than XGA (1024x768) Display color of approx. 32000 colors more than 16 bit colors

* Internet Explorer Ver.5 or later installed, and a user with Administrator authority

DECLARATION of CONFORMITY

According to 47CFR, Part 2 and 15
Class B Personal Computers and Peripherals; and/or
Personal Computers

We: Epson America, Inc.
Located at: 3840 Kilroy Airport Way
MS: 3-13
Long Beach, CA 90806
Tel: 562-290-5254

Declare under sole responsibility that the product identified herein, complies with 47CFR Part 2 and 15 of the FCC rules as a Class B digital device. Each product marketed, is identical to the representative unit tested and found to be compliant with the standards. Records maintained continue to reflect the equipment being produced can be expected to be within the variation accepted, due to quantity production and testing on a statistical basis as required by 47CFR 2.909. Operation is subject to the following two conditions : (1) this device may not cause harmful interference, and (2) this device must accept any interference received, including interference that may cause undesired operation.

Trade Name: EPSON

Type of Product: Projector

Model: H294C/H295C/H296C/H297C/H325C



Discount-Merchant.com (800) 281-8800
THE TRUSTED SOURCE FOR PROJECTOR LAMPS AND ACCESSORIES

**FCC Compliance Statement
For United States Users**

This equipment has been tested and found to comply with the limits for a Class B digital device, pursuant to Part 15 of the FCC Rules. These limits are designed to provide reasonable protection against harmful interference in a residential installation. This equipment generates, uses, and can radiate radio frequency energy and, if not installed and used in accordance with the instructions, may cause harmful interference to radio or television reception. However, there is no guarantee that interference will not occur in a particular installation. If this equipment does cause interference to radio and television reception, which can be determined by turning the equipment off and on, the user is encouraged to try to correct the interference by one or more of the following measures.

- Reorient or relocate the receiving antenna.
- Increase the separation between the equipment and receiver.
- Connect the equipment into an outlet on a circuit different from that to which the receiver is connected.
- Consult the dealer or an experienced radio/TV technician for help.

WARNING

The connection of a non-shielded equipment interface cable to this equipment will invalidate the FCC Certification or Declaration of this device and may cause interference levels which exceed the limits established by the FCC for this equipment. It is the responsibility of the user to obtain and use a shielded equipment interface cable with this device. If this equipment has more than one interface connector, do not leave cables connected to unused interfaces. Changes or modifications not expressly approved by the manufacturer could void the user's authority to operate the equipment.

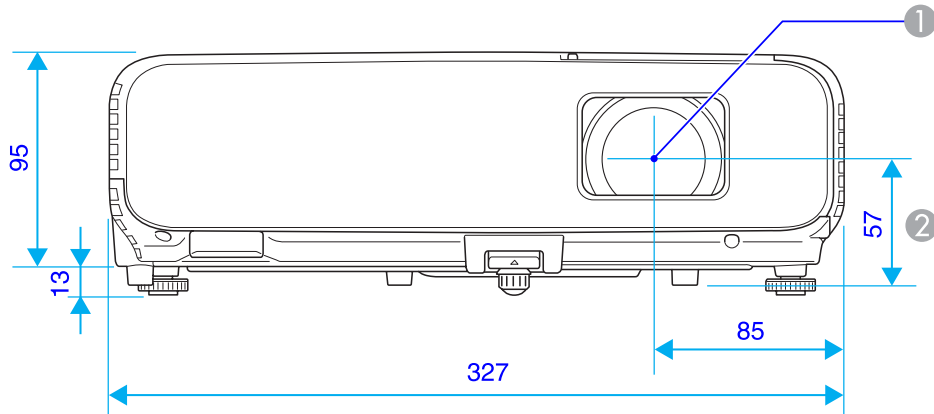

- ① Center of lens
- ② * Distance from center of lens to suspension bracket fixing point

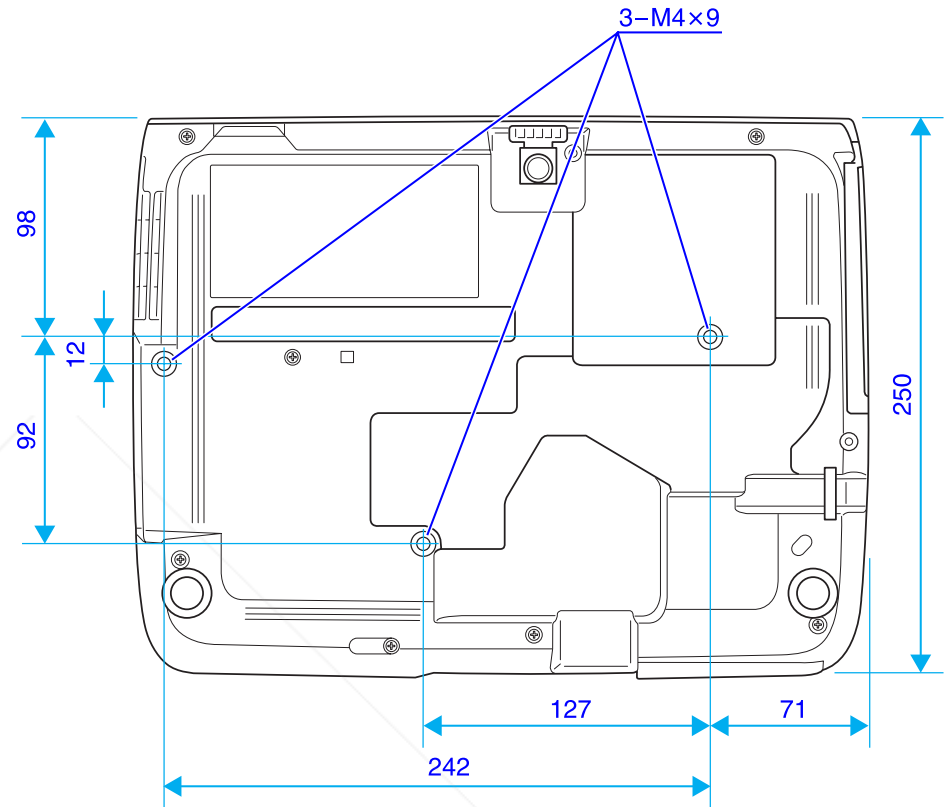

Units: mm

This section explains easily terms that are used with the projector and difficult terms that are not explained in the text of this guide. For details, refer to other commercially available publications.

AMX Device Discovery	AMX Device Discovery is a technology developed by AMX to facilitate AMX control systems for easy operation of the target equipment. Epson have implemented this protocol technology, and have provided a setting to enable the protocol function (ON). See the AMX Web site for more details. URL http://www.amx.com/
Aspect Ratio (Aspect Ratio)	The ratio between an image's length and its height. HDTV images have an aspect ratio of 16:9 and appear elongated. The aspect ratio for standard images is 4:3.
Component Video	A Video signal which has the luminance component and color component separated to provide better image quality. Refers to images that consist of three independent signals: Y (luminance signal), Pb and Pr (color difference signals).
Composite video	Video signals that have the video brightness signals and color signals mixed together. The type of signals commonly used by household video equipment (NTSC, PAL, and SECAM formats). The carrier signal Y (luminance signal) and chroma (color) signal that are contained in the color bar are overlapped to form a single signal.
Contrast	The relative brightness of the light and dark areas of an image can be increased or decreased to make text and graphics stand out more clearly, or to make them appear softer. Adjusting this particular property of an image is called Contrast adjustment.
DHCP	An abbreviation of Dynamic Host Configuration Protocol, this protocol automatically assigns an IP Address to equipment connected to a Network.
Dolby Digital	A sound format developed by Dolby Laboratories. Normal stereo is a 2-channel format that uses two speakers. Dolby Digital is a 6-channel (5.1-channel) system which adds to this a center speaker, two rear speakers, and a sub-woofer.
Gateway address (Gateway Address)	This is a server (router) for communicating across a Network (subnet) divided according to Subnet Mask .
HDTV	An abbreviation for High-Definition Television that refers to high-definition systems which satisfy the following conditions. <ul style="list-style-type: none"> • Vertical resolution of 720p or 1080i or greater (p = Progressive, i = Interlace) • Screen Aspect Ratio of 16:9 • Dolby Digital audio reception and playback (or output)
Interlace	A method of image scanning whereby the image data is divided into fine horizontal lines that are displayed in sequence starting from left to right and then from top to bottom. The even-numbered lines and odd-numbered lines are displayed alternately.
IP Address	A number to identify a computer connected to a Network.
Progressive	A method of image scanning whereby the image data from a single image is scanned sequentially from top to bottom to create a single image.

Refresh Rate	The light-emitting element of a display maintains the same luminosity and color for an extremely short time. Because of this, the image must be scanned many times per second to refresh the light-emitting element. The number of refresh operations per second is called the Refresh Rate and is expressed in hertz (Hz).
SDTV	An abbreviation for Standard Definition Television that refers to standard television systems which do not satisfy the conditions for HDTV High-Definition Television.
SNMP	An abbreviation for Simple Network Management Protocol, which is the protocol for monitoring and controlling devices such as routers and computers connected to a TCP/IP Network.
sRGB	An international standard for color intervals that was formulated so that colors that are reproduced by video equipment can be handled easily by computer operating systems (OS) and the Internet. If the connected source has an sRGB mode, set both the projector and the connected signal source to sRGB.
SSID	SSID is an identification number for connecting with a counterpart on a Wireless LAN. Wireless communication is possible between devices that correspond to SSID.
Subnet mask (Subnet Mask)	This is a numerical value that defines the number of bits used for the Network address on a divided network (subnet) from the IP Address.
SVGA	A type of video signal with a resolution of 800 (horizontal) × 600 (vertical) dots that is used by IBM PC/AT-compatible computers.
S-Video	A Video signal which has the luminance component and color component separated to provide better image quality. Refers to images that consist of two independent signals: Y (luminance signal) and C (color signal).
SXGA	A type of video signal with a resolution of 1,280 (horizontal) × 1,024 (vertical) dots that is used by IBM PC/AT-compatible computers.
Sync.	The signals output from computers have a specific frequency. If the projector frequency does not match this frequency, the resulting images are not of a good quality. The process of matching the phases of these signals (the relative position of the crests and the troughs in the signal) is called Synchronization. If the signals are not synchronized, flickering, blurriness, and horizontal interference occur.
Tracking	The signals output from computers have a specific frequency. If the projector frequency does not match this frequency, the resulting images are not of a good quality. The process of matching the frequency of these signals (the number of crests in the signal) is called Tracking. If Tracking is not carried out correctly, wide vertical stripes appear in the signal.
Trap IP Address	This is the IP Address for the destination computer used for error notification in SNMP.
VGA	A type of video signal with a resolution of 640 (horizontal) × 480 (vertical) dots that is used by IBM PC/AT-compatible computers.
WPS	WPS is an abbreviation of Wi-Fi Protected Setup. Wi-Fi Protected Setup has been devised by the Wi-Fi Alliance as a means of easily setting up and securing a Wireless LAN.
XGA	A type of video signal with a resolution of 1,024 (horizontal) × 768 (vertical) dots that is used by IBM PC/AT-compatible computers.

All rights reserved. No part of this publication may be reproduced, stored in a retrieval system, or transmitted in any form or by any means, electronic, mechanical, photocopying, recording, or otherwise, without the prior written permission of Seiko Epson Corporation. No patent liability is assumed with respect to the use of the information contained herein. Neither is any liability assumed for damages resulting from the use of the information contained herein.

Neither Seiko Epson Corporation nor its affiliates shall be liable to the purchaser of this product or third parties for damages, losses, costs, or expenses incurred by the purchaser or third parties as a result of: accident, misuse, or abuse of this product or unauthorized modifications, repairs, or alterations to this product, or (excluding the U.S.) failure to strictly comply with Seiko Epson Corporation's operating and maintenance instructions.

Seiko Epson Corporation shall not be liable against any damages or problems arising from the use of any options or any consumable products other than those designated as Original Epson Products or Epson Approved Products by Seiko Epson Corporation.

The contents of this guide may be changed or updated without further notice.

Illustrations in this guide and the actual projector may differ.

General Notice:

Windows Vista and the Windows logo are trademarks of the Microsoft group of companies.

IBM, DOS/V, and XGA are trademarks or registered trademarks of International Business Machines Corporation.

Macintosh, Mac, and iMac are registered trademarks of Apple Inc.

Windows, WindowsNT, Windows Vista, and PowerPoint are trademarks or registered trademarks of Microsoft Corporation in the United States.

Dolby is a trademark of Dolby Laboratories.

Pixelworks and DNX are trademarks of Pixelworks Inc.

WPA™ and WPA2™ are registered trademarks of Wi-Fi Alliance.

PJLink trademark is a trademark applied for registration or is already registered in Japan, the United States of America and other countries and areas.

Other product names used herein are also for identification purposes only and may be trademarks of their respective owners. Epson disclaims any and all rights in those marks.

©SEIKO EPSON CORPORATION 2009. All rights reserved.

GNU GPL

This projector product includes the open source software programs which apply the GNU General Public License Version 2 or later version ("GPL Programs").

We provide the source code of the GPL Programs until five (5) years after the discontinuation of same model of this projector product.

If you desire to receive the source code of the GPL Programs, please see the "EPSON Projector Contact List" in the User's Guide, and contact the customer support of your region.

These GPL Programs are WITHOUT ANY WARRANTY; without even the implied warranty of MERCHANTABILITY AND FITNESS FOR A PARTICULAR PURPOSE. See the GNU General Public License for more details.

The list of GPL Programs is as follows and the names of author are described in the source code of the GPL Programs

The list of GPL Programs

busybox-1.7.2

libgcc1(gcc-4.2.3)

linux-2.6.20

patches

udhcp 0.9.8

uvc rev.219

wireless_tools 29

Pixelworks PWC950 SDK drivers

The GNU General Public License Version 2 is as follows. You also can see the GNU General Public License Version 2 at <http://www.gnu.org/licenses/>.

GNU GENERAL PUBLIC LICENSE

Version 2, June 1991

Copyright (C) 1989, 1991 Free Software Foundation, Inc., 51 Franklin Street, Fifth Floor, Boston, MA 02110-1301 USA Everyone is permitted to copy and distribute verbatim copies of this license document, but changing it is not allowed.

Preamble

The licenses for most software are designed to take away your freedom to share and change it. By contrast, the GNU General Public License is intended to guarantee your freedom to share and change free software--to make sure the software is free for all its users. This General Public License applies to most of the Free Software Foundation's software and to any other program whose authors commit to using it. (Some other Free Software Foundation software is covered by the GNU Lesser General Public License instead.) You can apply it to your programs, too.

When we speak of free software, we are referring to freedom, not price. Our General Public Licenses are designed to make sure that you have the freedom to distribute copies of free software (and charge for service if you wish), that you receive source code or can get it if you want it, that you can change the software or use pieces of it in new free programs; and that you know you can do these things.

To protect your rights, we need to make restrictions that forbid anyone to deny you these rights or to ask you to surrender the rights. These restrictions translate to certain responsibilities for you if you distribute copies of the software, or if you modify it.

For example, if you distribute copies of such a program, whether gratis or for a fee, you must give the recipients all the rights that you have. You must make sure that they, too, receive or can get the source code. And you must show them these terms so they know their rights.

We protect your rights with two steps: (1) copyright the software, and (2) offer you this license which gives you legal permission to copy, distribute and/or modify the software.

Also, for each author's protection and ours, we want to make certain that everyone understands that there is no warranty for this free software. If the software is modified by someone else and passed on, we want its recipients to know that what they have is not the original, so that any problems introduced by others will not reflect on the original authors' reputations.

Finally, any free program is threatened constantly by software patents. We wish to avoid the danger that redistributors of a free program will individually obtain patent licenses, in effect making the program proprietary. To prevent this, we have made it clear that any patent must be licensed for everyone's free use or not licensed at all.

The precise terms and conditions for copying, distribution and modification follow.

GNU GENERAL PUBLIC LICENSE TERMS AND CONDITIONS FOR COPYING, DISTRIBUTION AND MODIFICATION

0. This License applies to any program or other work which contains a notice placed by the copyright holder saying it may be distributed under the terms of this General Public License. The "Program", below, refers to any such program or work, and a "work based on the Program" means either the Program or any derivative work under copyright law: that is to say, a work containing the Program or a portion of it, either verbatim or with modifications and/or translated into another language. (Hereinafter, translation is included without limitation in the term "modification".) Each licensee is addressed as "you".
Activities other than copying, distribution and modification are not covered by this License; they are outside its scope. The act of running the Program is not restricted, and the output from the Program is covered only if its contents constitute a work based on the Program (independent of having been made by running the Program). Whether that is true depends on what the Program does.

1. You may copy and distribute verbatim copies of the Program's source code as you receive it, in any medium, provided that you conspicuously and appropriately publish on each copy an appropriate copyright notice and disclaimer of warranty; keep intact all the notices that refer to this License and to the absence of any warranty; and give any other recipients of the Program a copy of this License along with the Program.
You may charge a fee for the physical act of transferring a copy, and you may at your option offer warranty protection in exchange for a fee.
2. You may modify your copy or copies of the Program or any portion of it, thus forming a work based on the Program, and copy and distribute such modifications or work under the terms of Section 1 above, provided that you also meet all of these conditions:
 - a) You must cause the modified files to carry prominent notices stating that you changed the files and the date of any change.
 - b) You must cause any work that you distribute or publish, that in whole or in part contains or is derived from the Program or any part thereof, to be licensed as a whole at no charge to all third parties under the terms of this License.
 - c) If the modified program normally reads commands interactively when run, you must cause it, when started running for such interactive use in the most ordinary way, to print or display an announcement including an appropriate copyright notice and a notice that there is no warranty (or else, saying that you provide a warranty) and that users may redistribute the program under these conditions, and telling the user how to view a copy of this License. (Exception: if the Program itself is interactive but does not normally print such an announcement, your work based on the Program is not required to print an announcement.)

These requirements apply to the modified work as a whole. If identifiable sections of that work are not derived from the Program, and can be reasonably considered independent and separate works in themselves, then this License, and its terms, do not apply to those sections when you distribute them as separate works. But when you distribute the same sections as part of a whole which is a work based on the Program, the distribution of the whole must be on the terms of this License, whose permissions for other licensees extend to the entire whole, and thus to each and every part regardless of who wrote it.

Thus, it is not the intent of this section to claim rights or contest your rights to work written entirely by you; rather, the intent is to exercise the right to control the distribution of derivative or collective works based on the Program.

In addition, mere aggregation of another work not based on the Program with the Program (or with a work based on the Program) on a volume of a storage or distribution medium does not bring the other work under the scope of this License.

3. You may copy and distribute the Program (or a work based on it, under Section 2) in object code or executable form under the terms of Sections 1 and 2 above provided that you also do one of the following:
 - a) Accompany it with the complete corresponding machine-readable source code, which must be distributed under the terms of Sections 1 and 2 above on a medium customarily used for software interchange; or,
 - b) Accompany it with a written offer, valid for at least three years, to give any third party, for a charge no more than your cost of physically performing source distribution, a complete machine-readable copy of the corresponding source code, to be distributed under the terms of Sections 1 and 2 above on a medium customarily used for software interchange; or,
 - c) Accompany it with the information you received as to the offer to distribute corresponding source code. (This alternative is allowed only for noncommercial distribution and only if you received the program in object code or executable form with such an offer, in accord with Subsection b above.)

The source code for a work means the preferred form of the work for making modifications to it. For an executable work, complete source code means all the source code for all modules it contains, plus any associated interface definition files, plus the scripts used to control compilation and installation of the executable. However, as a special exception, the source code distributed need not include anything that is normally distributed (in either source or binary form) with the major components (compiler, kernel, and so on) of the operating system on which the executable runs, unless that component itself accompanies the executable.

If distribution of executable or object code is made by offering access to copy from a designated place, then offering equivalent access to copy the source code from the same place counts as distribution of the source code, even though third parties are not compelled to copy the source along with the object code.

4. You may not copy, modify, sublicense, or distribute the Program except as expressly provided under this License. Any attempt otherwise to copy, modify, sublicense or distribute the Program is void, and will automatically terminate your rights under this License. However, parties who have received copies, or rights, from you under this License will not have their licenses terminated so long as such parties remain in full compliance.
5. You are not required to accept this License, since you have not signed it. However, nothing else grants you permission to modify or distribute the Program or its derivative works. These actions are prohibited by law if you do not accept this License. Therefore, by modifying or distributing the Program (or any work based on the Program), you indicate your acceptance of this License to do so, and all its terms and conditions for copying, distributing or modifying the Program or works based on it.
6. Each time you redistribute the Program (or any work based on the Program), the recipient automatically receives a license from the original licensor to copy, distribute or modify the Program subject to these terms and conditions. You may not impose any further restrictions on the recipients' exercise of the rights granted herein. You are not responsible for enforcing compliance by third parties to this License.
7. If, as a consequence of a court judgment or allegation of patent infringement or for any other reason (not limited to patent issues), conditions are imposed on you (whether by court order, agreement or otherwise) that contradict the conditions of this License, they do not excuse you from the conditions of this License. If you cannot distribute so as to satisfy simultaneously your obligations under this License and any other pertinent obligations, then as a consequence you may not distribute the Program at all. For example, if a patent license would not permit royalty-free redistribution of the Program by all those who receive copies directly or indirectly through you, then the only way you could satisfy both it and this License would be to refrain entirely from distribution of the Program.

If any portion of this section is held invalid or unenforceable under any particular circumstance, the balance of the section is intended to apply and the section as a whole is intended to apply in other circumstances.

It is not the purpose of this section to induce you to infringe any patents or other property right claims or to contest validity of any such claims; this section has the sole purpose of protecting the integrity of the free software distribution system, which is implemented by public license practices. Many people have made generous contributions to the wide range of software distributed through that system in reliance on consistent application of that system; it is up to the author/donor to decide if he or she is willing to distribute software through any other system and a licensee cannot impose that choice.

This section is intended to make thoroughly clear what is believed to be a consequence of the rest of this License.

8. If the distribution and/or use of the Program is restricted in certain countries either by patents or by copyrighted interfaces, the original copyright holder who places the Program under this License may add an explicit geographical distribution limitation excluding those countries, so that distribution is permitted only in or among countries not thus excluded. In such case, this License incorporates the limitation as if written in the body of this License.
9. The Free Software Foundation may publish revised and/or new versions of the General Public License from time to time. Such new versions will be similar in spirit to the present version, but may differ in detail to address new problems or concerns.

Each version is given a distinguishing version number. If the Program specifies a version number of this License which applies to it and "any later version", you have the option of following the terms and conditions either of that version or of any later version published by the Free Software Foundation. If the Program does not specify a version number of this License, you may choose any version ever published by the Free Software Foundation.

10. If you wish to incorporate parts of the Program into other free programs whose distribution conditions are different, write to the author to ask for permission. For software which is copyrighted by the Free Software Foundation, write to the Free Software Foundation; we sometimes make exceptions for this. Our decision will be guided by the two goals of preserving the free status of all derivatives of our free software and of promoting the sharing and reuse of software generally.

NO WARRANTY

11. BECAUSE THE PROGRAM IS LICENSED FREE OF CHARGE, THERE IS NO WARRANTY FOR THE PROGRAM, TO THE EXTENT PERMITTED BY APPLICABLE LAW. EXCEPT WHEN OTHERWISE STATED IN WRITING THE COPYRIGHT HOLDERS AND/OR OTHER PARTIES PROVIDE THE PROGRAM "AS IS" WITHOUT WARRANTY OF ANY KIND, EITHER EXPRESSED OR IMPLIED, INCLUDING, BUT NOT LIMITED TO, THE IMPLIED WARRANTIES OF MERCHANTABILITY AND FITNESS FOR A PARTICULAR PURPOSE. THE ENTIRE RISK AS TO THE QUALITY AND PERFORMANCE OF THE PROGRAM IS WITH YOU. SHOULD THE PROGRAM PROVE DEFECTIVE, YOU ASSUME THE COST OF ALL NECESSARY SERVICING, REPAIR OR CORRECTION.
12. IN NO EVENT UNLESS REQUIRED BY APPLICABLE LAW OR AGREED TO IN WRITING WILL ANY COPYRIGHT HOLDER, OR ANY OTHER PARTY WHO MAY MODIFY AND/OR REDISTRIBUTE THE PROGRAM AS PERMITTED ABOVE, BE LIABLE TO YOU FOR DAMAGES, INCLUDING ANY GENERAL, SPECIAL, INCIDENTAL OR CONSEQUENTIAL DAMAGES ARISING OUT OF THE USE OR INABILITY TO USE THE PROGRAM (INCLUDING BUT NOT LIMITED TO LOSS OF DATA OR DATA BEING RENDERED INACCURATE OR LOSSES SUSTAINED BY YOU OR THIRD PARTIES OR A FAILURE OF THE PROGRAM TO OPERATE WITH ANY OTHER PROGRAMS), EVEN IF SUCH HOLDER OR OTHER PARTY HAS BEEN ADVISED OF THE POSSIBILITY OF SUCH DAMAGES.

END OF TERMS AND CONDITIONS

How to Apply These Terms to Your New Programs

If you develop a new program, and you want it to be of the greatest possible use to the public, the best way to achieve this is to make it free software which everyone can redistribute and change under these terms.

To do so, attach the following notices to the program. It is safest to attach them to the start of each source file to most effectively convey the exclusion of warranty; and each file should have at least the "copyright" line and a pointer to where the full notice is found.

<one line to give the program's name and a brief idea of what it does.>

Copyright (C) <year> <name of author>

This program is free software; you can redistribute it and/or modify it under the terms of the GNU General Public License as published by the Free Software Foundation; either version 2 of the License, or (at your option) any later version.

This program is distributed in the hope that it will be useful, but WITHOUT ANY WARRANTY; without even the implied warranty of MERCHANTABILITY or FITNESS FOR A PARTICULAR PURPOSE. See the GNU General Public License for more details.

You should have received a copy of the GNU General Public License along with this program; if not, write to the Free Software Foundation, Inc., 51 Franklin Street, Fifth Floor, Boston, MA 02110-1301 USA.

Also add information on how to contact you by electronic and paper mail.

If the program is interactive, make it output a short notice like this when it starts in an interactive mode:

```
Gnomovision version 69, Copyright (C) year name of author Gnomovision
comes with ABSOLUTELY NO WARRANTY; for details type `show w'. This is
free software, and you are welcome to redistribute it under certain conditions;
type `show c' for details.
```

The hypothetical commands `show w' and `show c' should show the appropriate parts of the General Public License. Of course, the commands you use may be called something other than `show w' and `show c'; they could even be mouse-clicks or menu items--whatever suits your program.

You should also get your employer (if you work as a programmer) or your school, if any, to sign a "copyright disclaimer" for the program, if necessary. Here is a sample; alter the names:

```
Yoyodyne, Inc., hereby disclaims all copyright interest in the program
`Gnomovision' (which makes passes at compilers) written by James Hacker.
<signature of Ty Coon>, 1 April 1989
Ty Coon, President of Vice
```

This General Public License does not permit incorporating your program into proprietary programs. If your program is a subroutine library, you may consider it more useful to permit linking proprietary applications with the library. If this is what you want to do, use the GNU Lesser General Public License instead of this License.

GNU LGPL

This projector product includes the open source software programs which apply the GNU Lesser General Public License Version 2 or later version ("LGPL Programs").

We provide the source code of the LGPL Programs until five (5) years after the discontinuation of same model of this projector product.

If you desire to receive the source code of the LGPL Programs, please see the "EPSON Projector Contact List" in the User's Guide, and contact the customer support of your region.

These LGPL Programs are WITHOUT ANY WARRANTY; without even the implied warranty of MERCHANTABILITY AND FITNESS FOR A PARTICULAR PURPOSE. See the GNU General Public License for more details.

The list of LGPL Programs is as follows and the names of author are described in the source code of the LGPL Programs.

LGPL Programs

uClibc-0.9.29

SDL-1.2.13

The GNU Lesser General Public License Version 2 is as follows. You also can see the GNU Lesser General Public License Version 2 at <http://www.gnu.org/licenses/>.

GNU LESSER GENERAL PUBLIC LICENSE

Version 2.1, February 1999

Copyright (C) 1991, 1999 Free Software Foundation, Inc. 51 Franklin Street, Fifth Floor, Boston, MA 02110-1301 USA Everyone is permitted to copy and distribute verbatim copies of this license document, but changing it is not allowed.

[This is the first released version of the Lesser GPL. It also counts as the successor of the GNU Library Public License, version 2, hence the version number 2.1.]

Preamble

The licenses for most software are designed to take away your freedom to share and change it. By contrast, the GNU General Public Licenses are intended to guarantee your freedom to share and change free software--to make sure the software is free for all its users.

This license, the Lesser General Public License, applies to some specially designated software packages--typically libraries--of the Free Software Foundation and other authors who decide to use it. You can use it too, but we suggest you first think carefully about whether this license or the ordinary General Public License is the better strategy to use in any particular case, based on the explanations below.

When we speak of free software, we are referring to freedom of use, not price. Our General Public Licenses are designed to make sure that you have the freedom to distribute copies of free software (and charge for this service if you wish); that you receive source code or can get it if you want it; that you can change the software and use pieces of it in new free programs; and that you are informed that you can do these things.

To protect your rights, we need to make restrictions that forbid distributors to deny you these rights or to ask you to surrender these rights. These restrictions translate to certain responsibilities for you if you distribute copies of the library or if you modify it.

For example, if you distribute copies of the library, whether gratis or for a fee, you must give the recipients all the rights that we gave you. You must make sure that they, too, receive or can get the source code. If you link other code with the library, you must provide complete object files to the recipients, so that they can relink them with the library after making changes to the library and recompiling it. And you must show them these terms so they know their rights.

We protect your rights with a two-step method: (1) we copyright the library, and (2) we offer you this license, which gives you legal permission to copy, distribute and/or modify the library.

To protect each distributor, we want to make it very clear that there is no warranty for the free library. Also, if the library is modified by someone else and passed on, the recipients should know that what they have is not the original version, so that the original author's reputation will not be affected by problems that might be introduced by others.

Finally, software patents pose a constant threat to the existence of any free program. We wish to make sure that a company cannot effectively restrict the users of a free program by obtaining a restrictive license from a patent holder. Therefore, we insist that any patent license obtained for a version of the library must be consistent with the full freedom of use specified in this license.

Most GNU software, including some libraries, is covered by the ordinary GNU General Public License. This license, the GNU Lesser General Public License, applies to certain designated libraries, and is quite different from the ordinary General Public License. We use this license for certain libraries in order to permit linking those libraries into non-free programs.

When a program is linked with a library, whether statically or using a shared library, the combination of the two is legally speaking a combined work, a derivative of the original library. The ordinary General Public License therefore permits such linking only if the entire combination fits its criteria of freedom. The Lesser General Public License permits more lax criteria for linking other code with the library.

We call this license the "Lesser" General Public License because it does Less to protect the user's freedom than the ordinary General Public License. It also provides other free software developers Less of an advantage over competing non-free programs. These disadvantages are the reason we use the ordinary General Public License for many libraries. However, the Lesser license provides advantages in certain special circumstances.

For example, on rare occasions, there may be a special need to encourage the widest possible use of a certain library, so that it becomes a de-facto standard. To achieve this, non-free programs must be allowed to use the library. A more frequent case is that a free library does the same job as widely used non-free libraries. In this case, there is little to gain by limiting the free library to free software only, so we use the Lesser General Public License.

In other cases, permission to use a particular library in non-free programs enables a greater number of people to use a large body of free software. For example, permission to use the GNU C Library in non-free programs enables many more people to use the whole GNU operating system, as well as its variant, the GNU/Linux operating system.

Although the Lesser General Public License is Less protective of the users' freedom, it does ensure that the user of a program that is linked with the Library has the freedom and the wherewithal to run that program using a modified version of the Library.

The precise terms and conditions for linking, distribution and modification follow. Pay close attention to the difference between a "work based on the library" and a "work that uses the library". The former contains code derived from the library, whereas the latter must be combined with the library in order to run

GNU LESSER GENERAL PUBLIC LICENSE TERMS AND CONDITIONS FOR COPYING, DISTRIBUTION AND MODIFICATION

0. This License Agreement applies to any software library or other program which contains a notice placed by the copyright holder or other authorized party saying it may be distributed under the terms of this Lesser General Public License (also called "this License"). Each licensee is addressed as "you".

A "library" means a collection of software functions and/or data prepared so as to be conveniently linked with application programs (which use some of those functions and data) to form executables.

The "Library", below, refers to any such software library or work which has been distributed under these terms. A "work based on the Library" means either the Library or any derivative work under copyright law: that is to say, a work containing the Library or a portion of it, either verbatim or with modifications and/or translated straightforwardly into another language. (Hereinafter, translation is included without limitation in the term "modification".)

"Source code" for a work means the preferred form of the work for making modifications to it. For a library, complete source code means all the source code for all modules it contains, plus any associated interface definition files, plus the scripts used to control compilation and installation of the library.

Activities other than copying, distribution and modification are not covered by this License; they are outside its scope. The act of running a program using the Library is not restricted, and output from such a program is covered only if its contents constitute a work based on the Library (independent of the use of the Library in a tool for writing it). Whether that is true depends on what the Library does and what the program that uses the Library does.

1. You may copy and distribute verbatim copies of the Library's complete source code as you receive it, in any medium, provided that you conspicuously and appropriately publish on each copy an appropriate copyright notice and disclaimer of warranty; keep intact all the notices that refer to this License and to the absence of any warranty; and distribute a copy of this License along with the Library.

You may charge a fee for the physical act of transferring a copy, and you may at your option offer warranty protection in exchange for a fee.

2. You may modify your copy or copies of the Library or any portion of it, thus forming a work based on the Library, and copy and distribute such modifications or work under the terms of Section 1 above, provided that you also meet all of these conditions:

- a) The modified work must itself be a software library.
- b) You must cause the files modified to carry prominent notices stating that you changed the files and the date of any change.
- c) You must cause the whole of the work to be licensed at no charge to all third parties under the terms of this License.
- d) If a facility in the modified Library refers to a function or a table of data to be supplied by an application program that uses the facility, other than as an argument passed when the facility is invoked, then you must make a good faith effort to ensure that, in the event an application does not supply such function or table, the facility still operates, and performs whatever part of its purpose remains meaningful.

(For example, a function in a library to compute square roots has a purpose that is entirely well-defined independent of the application. Therefore, Subsection 2d requires that any application-supplied function or table used by this function must be optional: if the application does not supply it, the square root function must still compute square roots.)

These requirements apply to the modified work as a whole. If identifiable sections of that work are not derived from the Library, and can be reasonably considered independent and separate works in themselves, then this License, and its terms, do not apply to those sections when you distribute them as separate works. But when you distribute the same sections as part of a whole which is a work based on the Library, the distribution of the whole must be on the terms of this License, whose permissions for other licensees extend to the entire whole, and thus to each and every part regardless of who wrote it.

Thus, it is not the intent of this section to claim rights or contest your rights to work written entirely by you; rather, the intent is to exercise the right to control the distribution of derivative or collective works based on the Library.

In addition, mere aggregation of another work not based on the Library with the Library (or with a work based on the Library) on a volume of a storage or distribution medium does not bring the other work under the scope of this License.

3. You may opt to apply the terms of the ordinary GNU General Public License instead of this License to a given copy of the Library. To do this, you must alter all the notices that refer to this License, so that they refer to the ordinary GNU General Public License, version 2, instead of to this License. (If a newer version than version 2 of the ordinary GNU General Public License has appeared, then you can specify that version instead if you wish.) Do not make any other change in these notices.

Once this change is made in a given copy, it is irreversible for that copy, so the ordinary GNU General Public License applies to all subsequent copies and derivative works made from that copy.

This option is useful when you wish to copy part of the code of the Library into a program that is not a library.

4. You may copy and distribute the Library (or a portion or derivative of it, under Section 2) in object code or executable form under the terms of Sections 1 and 2 above provided that you accompany it with the complete corresponding machine-readable source code, which must be distributed under the terms of Sections 1 and 2 above on a medium customarily used for software interchange.

If distribution of object code is made by offering access to copy from a designated place, then offering equivalent access to copy the source code from the same place satisfies the requirement to distribute the source code, even though third parties are not compelled to copy the source along with the object code.

5. A program that contains no derivative of any portion of the Library, but is designed to work with the Library by being compiled or linked with it, is called a "work that uses the Library". Such a work, in isolation, is not a derivative work of the Library, and therefore falls outside the scope of this License.

However, linking a "work that uses the Library" with the Library creates an executable that is a derivative of the Library (because it contains portions of the Library), rather than a "work that uses the library". The executable is therefore covered by this License. Section 6 states terms for distribution of such executables.

When a "work that uses the Library" uses material from a header file that is part of the Library, the object code for the work may be a derivative work of the Library even though the source code is not. Whether this is true is especially significant if the work can be linked without the Library, or if the work is itself a library. The threshold for this to be true is not precisely defined by law.

If such an object file uses only numerical parameters, data structure layouts and accessors, and small macros and small inline functions (ten lines or less in length), then the use of the object file is unrestricted, regardless of whether it is legally a derivative work. (Executables containing this object code plus portions of the Library will still fall under Section 6.)

Otherwise, if the work is a derivative of the Library, you may distribute the object code for the work under the terms of Section 6. Any executables containing that work also fall under Section 6, whether or not they are linked directly with the Library itself.

6. As an exception to the Sections above, you may also combine or link a "work that uses the Library" with the Library to produce a work containing portions of the Library, and distribute that work under terms of your choice, provided that the terms permit modification of the work for the customer's own use and reverse engineering for debugging such modifications.

You must give prominent notice with each copy of the work that the Library is used in it and that the Library and its use are covered by this License. You must supply a copy of this License. If the work during execution displays copyright notices, you must include the copyright notice for the Library among them, as well as a reference directing the user to the copy of this License. Also, you must do one of these things:

- a) Accompany the work with the complete corresponding machine-readable source code for the Library including whatever changes were used in the work (which must be distributed under Sections 1 and 2 above); and, if the work is an executable linked with the Library, with the complete machine-readable "work that uses the Library", as object code and/or source code, so that the user can modify the Library and then relink to produce a modified executable containing the modified Library. (It is understood that the user who changes the contents of definitions files in the Library will not necessarily be able to recompile the application to use the modified definitions.)
- b) Use a suitable shared library mechanism for linking with the Library. A suitable mechanism is one that
 - (1) uses at run time a copy of the library already present on the user's computer system, rather than copying library functions into the executable, and
 - (2) will operate properly with a modified version of the library, if the user installs one, as long as the modified version is interface-compatible with the version that the work was made with.

- c) Accompany the work with a written offer, valid for at least three years, to give the same user the materials specified in Subsection 6a, above, for a charge no more than the cost of performing this distribution.
- d) If distribution of the work is made by offering access to copy from a designated place, offer equivalent access to copy the above specified materials from the same place.
- e) Verify that the user has already received a copy of these materials or that you have already sent this user a copy.

For an executable, the required form of the "work that uses the Library" must include any data and utility programs needed for reproducing the executable from it. However, as a special exception, the materials to be distributed need not include anything that is normally distributed (in either source or binary form) with the major components (compiler, kernel, and so on) of the operating system on which the executable runs, unless that component itself accompanies the executable.

It may happen that this requirement contradicts the license restrictions of other proprietary libraries that do not normally accompany the operating system. Such a contradiction means you cannot use both them and the Library together in an executable that you distribute.

7. You may place library facilities that are a work based on the Library side-by-side in a single library together with other library facilities not covered by this License, and distribute such a combined library, provided that the separate distribution of the work based on the Library and of the other library facilities is otherwise permitted, and provided that you do these two things:
 - a) Accompany the combined library with a copy of the same work based on the Library, uncombined with any other library facilities. This must be distributed under the terms of the Sections above.
 - b) Give prominent notice with the combined library of the fact that part of it is a work based on the Library, and explaining where to find the accompanying uncombined form of the same work.
8. You may not copy, modify, sublicense, link with, or distribute the Library except as expressly provided under this License. Any attempt otherwise to copy, modify, sublicense, link with, or distribute the Library is void, and will automatically terminate your rights under this License. However, parties who have received copies, or rights, from you under this License will not have their licenses terminated so long as such parties remain in full compliance.

9. You are not required to accept this License, since you have not signed it. However, nothing else grants you permission to modify or distribute the Library or its derivative works. These actions are prohibited by law if you do not accept this License. Therefore, by modifying or distributing the Library (or any work based on the Library), you indicate your acceptance of this License to do so, and all its terms and conditions for copying, distributing or modifying the Library or works based on it.
10. Each time you redistribute the Library (or any work based on the Library), the recipient automatically receives a license from the original licensor to copy, distribute, link with or modify the Library subject to these terms and conditions. You may not impose any further restrictions on the recipients' exercise of the rights granted herein. You are not responsible for enforcing compliance by third parties with this License.
11. If, as a consequence of a court judgment or allegation of patent infringement or for any other reason (not limited to patent issues), conditions are imposed on you (whether by court order, agreement or otherwise) that contradict the conditions of this License, they do not excuse you from the conditions of this License. If you cannot distribute so as to satisfy simultaneously your obligations under this License and any other pertinent obligations, then as a consequence you may not distribute the Library at all. For example, if a patent license would not permit royalty-free redistribution of the Library by all those who receive copies directly or indirectly through you, then the only way you could satisfy both it and this License would be to refrain entirely from distribution of the Library.
12. If the distribution and/or use of the Library is restricted in certain countries either by patents or by copyrighted interfaces, the original copyright holder who places the Library under this License may add an explicit geographical distribution limitation excluding those countries, so that distribution is permitted only in or among countries not thus excluded. In such case, this License incorporates the limitation as if written in the body of this License.
13. The Free Software Foundation may publish revised and/or new versions of the Lesser General Public License from time to time. Such new versions will be similar in spirit to the present version, but may differ in detail to address new problems or concerns.
Each version is given a distinguishing version number. If the Library specifies a version number of this License which applies to it and "any later version", you have the option of following the terms and conditions either of that version or of any later version published by the Free Software Foundation. If the Library does not specify a license version number, you may choose any version ever published by the Free Software Foundation.
14. If you wish to incorporate parts of the Library into other free programs whose distribution conditions are incompatible with these, write to the author to ask for permission. For software which is copyrighted by the Free Software Foundation, write to the Free Software Foundation; we sometimes make exceptions for this. Our decision will be guided by the two goals of preserving the free status of all derivatives of our free software and of promoting the sharing and reuse of software generally.

If any portion of this section is held invalid or unenforceable under any particular circumstance, the balance of the section is intended to apply, and the section as a whole is intended to apply in other circumstances.

It is not the purpose of this section to induce you to infringe any patents or other property right claims or to contest validity of any such claims; this section has the sole purpose of protecting the integrity of the free software distribution system which is implemented by public license practices. Many people have made generous contributions to a wide range of software distributed through that system in reliance on consistent application of that system; it is up to the author/donor to decide if he or she is willing to distribute software through any other system and a licensee cannot impose that choice.

This section is intended to make thoroughly clear what is believed to be a consequence of the rest of this License.

NO WARRANTY

15. BECAUSE THE LIBRARY IS LICENSED FREE OF CHARGE, THERE IS NO WARRANTY FOR THE LIBRARY, TO THE EXTENT PERMITTED BY APPLICABLE LAW. EXCEPT WHEN OTHERWISE STATED IN WRITING THE COPYRIGHT HOLDERS AND/OR OTHER PARTIES PROVIDE THE LIBRARY "AS IS" WITHOUT WARRANTY OF ANY KIND, EITHER EXPRESSED OR IMPLIED, INCLUDING, BUT NOT LIMITED TO, THE IMPLIED WARRANTIES OF MERCHANTABILITY AND FITNESS FOR A PARTICULAR PURPOSE. THE ENTIRE RISK AS TO THE QUALITY AND PERFORMANCE OF THE LIBRARY IS WITH YOU. SHOULD THE LIBRARY PROVE DEFECTIVE, YOU ASSUME THE COST OF ALL NECESSARY SERVICING, REPAIR OR CORRECTION.

16. IN NO EVENT UNLESS REQUIRED BY APPLICABLE LAW OR AGREED TO IN WRITING WILL ANY COPYRIGHT HOLDER, OR ANY OTHER PARTY WHO MAY MODIFY AND/OR REDISTRIBUTE THE LIBRARY AS PERMITTED ABOVE, BE LIABLE TO YOU FOR DAMAGES, INCLUDING ANY GENERAL, SPECIAL, INCIDENTAL OR CONSEQUENTIAL DAMAGES ARISING OUT OF THE USE OR INABILITY TO USE THE LIBRARY (INCLUDING BUT NOT LIMITED TO LOSS OF DATA OR DATA BEING RENDERED INACCURATE OR LOSSES SUSTAINED BY YOU OR THIRD PARTIES OR A FAILURE OF THE LIBRARY TO OPERATE WITH ANY OTHER SOFTWARE), EVEN IF SUCH HOLDER OR OTHER PARTY HAS BEEN ADVISED OF THE POSSIBILITY OF SUCH DAMAGES.

END OF TERMS AND CONDITIONS

How to Apply These Terms to Your New Libraries

If you develop a new library, and you want it to be of the greatest possible use to the public, we recommend making it free software that everyone can redistribute and change. You can do so by permitting redistribution under these terms (or, alternatively, under the terms of the ordinary General Public License).

To apply these terms, attach the following notices to the library. It is safest to attach them to the start of each source file to most effectively convey the exclusion of warranty; and each file should have at least the "copyright" line and a pointer to where the full notice is found.

<one line to give the library's name and a brief idea of what it does.>

Copyright (C) <year> <name of author>

This library is free software; you can redistribute it and/or modify it under the terms of the GNU Lesser General Public License as published by the Free Software Foundation; either version 2.1 of the License, or (at your option) any later version.

This library is distributed in the hope that it will be useful, but WITHOUT ANY WARRANTY; without even the implied warranty of MERCHANTABILITY or FITNESS FOR A PARTICULAR PURPOSE. See the GNU Lesser General Public License for more details.

You should have received a copy of the GNU Lesser General Public License along with this library; if not, write to the Free Software Foundation, Inc., 51 Franklin Street, Fifth Floor, Boston, MA 02110-1301 USA

Also add information on how to contact you by electronic and paper mail.

You should also get your employer (if you work as a programmer) or your school, if any, to sign a "copyright disclaimer" for the library, if necessary. Here is a sample; alter the names:

Yoyodyne, Inc., hereby disclaims all copyright interest in the library `Frob' (a library for tweaking knobs) written by James Random Hacker.

<signature of Ty Coon>, 1 April 1990

Ty Coon, President of Vice

That's all there is to it!

BSD License (Berkeley Software Distribution License)

This projector product includes the open source software program "University of California, Berkeley License (Berkeley Software Distribution License)" which applies the terms and conditions provided by owner of the copyright to the "BSD License".

The "BSD License" are WITHOUT ANY WARRANTY; without even the implied warranty of MERCHANTABILITY AND FITNESS FOR A PARTICULAR PURPOSE.

List of BSD License programs

busybox_1.7.2

License terms of conditions of each program which are provided by owner of the copyright to the "BSD License" are as follows.

Copyright (c) The Regents of the University of California. All rights reserved.

This code is derived from software contributed to Berkeley by Kenneth Almquist.

Redistribution and use in source and binary forms, with or without modification, are permitted provided that the following conditions are met:

1. Redistributions of source code must retain the above copyright notice, this list of conditions and the following disclaimer.
2. Redistributions in binary form must reproduce the above copyright notice, this list of conditions and the following disclaimer in the documentation and/or other materials provided with the distribution.
3. Neither the name of the University nor the names of its contributors may be used to endorse or promote products derived from this software without specific prior written permission.

THIS SOFTWARE IS PROVIDED BY THE REGENTS AND CONTRIBUTORS ``AS IS'' AND ANY EXPRESS OR IMPLIED WARRANTIES, INCLUDING, BUT NOT LIMITED TO, THE IMPLIED WARRANTIES OF MERCHANTABILITY AND FITNESS FOR A PARTICULAR PURPOSE ARE DISCLAIMED. IN NO EVENT SHALL THE REGENTS OR CONTRIBUTORS BE LIABLE FOR ANY DIRECT, INDIRECT, INCIDENTAL, SPECIAL, EXEMPLARY, OR CONSEQUENTIAL DAMAGES (INCLUDING, BUT NOT LIMITED TO, PROCUREMENT OF SUBSTITUTE GOODS OR SERVICES; LOSS OF USE, DATA, OR PROFITS; OR BUSINESS INTERRUPTION) HOWEVER CAUSED AND ON ANY THEORY OF LIABILITY, WHETHER IN CONTRACT, STRICT LIABILITY, OR TORT (INCLUDING NEGLIGENCE OR OTHERWISE) ARISING IN ANY WAY OUT OF THE USE OF THIS SOFTWARE, EVEN IF ADVISED OF THE POSSIBILITY OF SUCH DAMAGE.

libjpeg

This projector product includes the open source software program "libjpeg" which applies the terms and conditions provided by owner of the copyright to the "libjpeg".

The "libjpeg" are WITHOUT ANY WARRANTY; without even the implied warranty of MERCHANTABILITY AND FITNESS FOR A PARTICULAR PURPOSE.

List of libjpeg programs

libjpeg-6b

License terms of conditions of each program which are provided by owner of the copyright to the "libjpeg" are as follows.

Copyright (C) 1994-1997, Thomas G. Lane. This file is part of the Independent JPEG Group's software. For conditions of distribution and use, see the accompanying README file.

This distribution contains the sixth public release of the Independent JPEG Group's free JPEG software. You are welcome to redistribute this software and to use it for any purpose, subject to the conditions under LEGAL ISSUES, below.

LEGAL ISSUES

=====

In plain English:

1. We don't promise that this software works. (But if you find any bugs, please let us know!)
2. You can use this software for whatever you want. You don't have to pay us.

3. You may not pretend that you wrote this software. If you use it in a program, you must acknowledge somewhere in your documentation that you've used the IJG code.

In legalese:

The authors make NO WARRANTY or representation, either express or implied, with respect to this software, its quality, accuracy, merchantability, or fitness for a particular purpose. This software is provided "AS IS", and you, its user, assume the entire risk as to its quality and accuracy.

This software is copyright (C) 1991-1998, Thomas G. Lane. All Rights Reserved except as specified below.

Permission is hereby granted to use, copy, modify, and distribute this software (or portions thereof) for any purpose, without fee, subject to these conditions:

- (1) If any part of the source code for this software is distributed, then this README file must be included, with this copyright and no-warranty notice unaltered; and any additions, deletions, or changes to the original files must be clearly indicated in accompanying documentation.
- (2) If only executable code is distributed, then the accompanying documentation must state that "this software is based in part on the work of the Independent JPEG Group".
- (3) Permission for use of this software is granted only if the user accepts full responsibility for any undesirable consequences; the authors accept NO LIABILITY for damages of any kind.

These conditions apply to any software derived from or based on the IJG code, not just to the unmodified library. If you use our work, you ought to acknowledge us.

Permission is NOT granted for the use of any IJG author's name or company name in advertising or publicity relating to this software or products derived from it. This software may be referred to only as "the Independent JPEG Group's software".

We specifically permit and encourage the use of this software as the basis of commercial products, provided that all warranty or liability claims are assumed by the product vendor.

ansi2knr.c is included in this distribution by permission of L. Peter Deutsch, sole proprietor of its copyright holder, Aladdin Enterprises of Menlo Park, CA. ansi2knr.c is NOT covered by the above copyright and conditions, but instead by the usual distribution terms of the Free Software Foundation; principally, that you must include source code if you redistribute it. (See the file ansi2knr.c for full details.) However, since ansi2knr.c is not needed as part of any program generated from the IJG code, this does not limit you more than the foregoing paragraphs do.

The Unix configuration script "configure" was produced with GNU Autoconf. It is copyright by the Free Software Foundation but is freely distributable. The same holds for its supporting scripts (config.guess, config.sub, ltconfig, ltmain.sh). Another support script, install-sh, is copyright by M.I.T. but is also freely distributable.

It appears that the arithmetic coding option of the JPEG spec is covered by patents owned by IBM, AT&T, and Mitsubishi. Hence arithmetic coding cannot legally be used without obtaining one or more licenses. For this reason, support for arithmetic coding has been removed from the free JPEG software. (Since arithmetic coding provides only a marginal gain over the unpatented Huffman mode, it is unlikely that very many implementations will support it.) So far as we are aware, there are no patent restrictions on the remaining code.

The IJG distribution formerly included code to read and write GIF files. To avoid entanglement with the Unisys LZW patent, GIF reading support has been removed altogether, and the GIF writer has been simplified to produce "uncompressed GIFs". This technique does not use the LZW algorithm; the resulting GIF files are larger than usual, but are readable by all standard GIF decoders.

We are required to state that

"The Graphics Interchange Format(c) is the Copyright property of CompuServe Incorporated. GIF(sm) is a Service Mark property of CompuServe Incorporated."

libpng

This projector product includes the open source software program "libpng" which applies the terms and conditions provided by owner of the copyright to the "libpng".

The "libpng" are WITHOUT ANY WARRANTY; without even the implied warranty of MERCHANTABILITY AND FITNESS FOR A PARTICULAR PURPOSE.

List of libpng programs

libpng-1.2.7

License terms of conditions of each program which are provided by owner of the copyright to the "libpng" are as follow

For conditions of distribution and use, see copyright notice in png.h Copyright (c) 1998-2004 Glenn Randers-Pehrson (Version 0.96 Copyright (c) 1996, 1997 Andreas Dilger) (Version 0.88 Copyright (c) 1995, 1996 Guy Eric Schalnat, Group 42, Inc.)

This copy of the libpng notices is provided for your convenience. In case of any discrepancy between this copy and the notices in the file png.h that is included in the libpng distribution, the latter shall prevail.

COPYRIGHT NOTICE, DISCLAIMER, and LICENSE:

If you modify libpng you may insert additional notices immediately following this sentence.

libpng version 1.2.6, September 12, 2004, is Copyright (c) 2004 Glenn Randers-Pehrson, and is distributed according to the same disclaimer and license as libpng-1.2.5 with the following individual added to the list of Contributing Authors

Cosmin Truta

libpng versions 1.0.7, July 1, 2000, through 1.2.5 - October 3, 2002, are Copyright (c) 2000-2002 Glenn Randers-Pehrson, and are distributed according to the same disclaimer and license as libpng-1.0.6 with the following individuals added to the list of Contributing Authors

Simon-Pierre Cadieux

Eric S. Raymond

Gilles Vollant

and with the following additions to the disclaimer:

There is no warranty against interference with your enjoyment of the library or against infringement. There is no warranty that our efforts or the library will fulfill any of your particular purposes or needs. This library is provided with all faults, and the entire risk of satisfactory quality, performance, accuracy, and effort is with the user.

libpng versions 0.97, January 1998, through 1.0.6, March 20, 2000, are Copyright (c) 1998, 1999 Glenn Randers-Pehrson, and are distributed according to the same disclaimer and license as libpng-0.96, with the following individuals added to the list of Contributing Authors:

Tom Lane

Glenn Randers-Pehrson

Willem van Schaik

libpng versions 0.89, June 1996, through 0.96, May 1997, are Copyright (c) 1996, 1997 Andreas Dilger Distributed according to the same disclaimer and license as libpng-0.88, with the following individuals added to the list of Contributing Authors:



FixYourDLP.com

powered by

ProjectorLamp.com (800) 281-8860

THE TRUSTED SOURCE FOR PROJECTOR LAMPS AND ACCESSORIES

John Bowler
 Kevin BraceySam Bushell
 Sam Bushell
 Magnus Holmgren
 Greg Roelofs
 Tom Tanner

libpng versions 0.5, May 1995, through 0.88, January 1996, are Copyright (c) 1995, 1996 Guy Eric Schalnat, Group 42, Inc.

For the purposes of this copyright and license, "Contributing Authors" is defined as the following set of individuals:

Andreas Dilger
 Dave Martindale
 Guy Eric Schalnat
 Paul Schmidt
 Tim Wegner

The PNG Reference Library is supplied "AS IS". The Contributing Authors and Group 42, Inc. disclaim all warranties, expressed or implied, including, without limitation, the warranties of merchantability and of fitness for any purpose. The Contributing Authors and Group 42, Inc. assume no liability for direct, indirect, incidental, special, exemplary, or consequential damages, which may result from the use of the PNG Reference Library, even if advised of the possibility of such damage.

Permission is hereby granted to use, copy, modify, and distribute this source code, or portions hereof, for any purpose, without fee, subject to the following restrictions:

1. The origin of this source code must not be misrepresented.
2. Altered versions must be plainly marked as such and must not be misrepresented as being the original source.
3. This Copyright notice may not be removed or altered from any source or altered source distribution.

The Contributing Authors and Group 42, Inc. specifically permit, without fee, and encourage the use of this source code as a component to supporting the PNG file format in commercial products. If you use this source code in a product, acknowledgment is not required but would be appreciated.

A "png_get_copyright" function is available, for convenient use in "about" boxes and the like:

```
printf("%s",png_get_copyright(NULL));
```

Also, the PNG logo (in PNG format, of course) is supplied in the files "pngbar.png" and "pngbar.jpg (88x31) and "pngnow.png" (98x31).

Libpng is OSI Certified Open Source Software. OSI Certified Open Source is a certification mark of the Open Source Initiative.

Glenn Randers-Pehrson
 glennrp@users.sourceforge.net
 September 12, 2004

zlib

This projector product includes the open source software program "zlib" which applies the terms and conditions provided by owner of the copyright to the "zlib".

The "zlib" are WITHOUT ANY WARRANTY; without even the implied warranty of MERCHANTABILITY AND FITNESS FOR A PARTICULAR PURPOSE.

List of zlib programs

zlib-1.1.4

License terms of conditions of each program which are provided by owner of the copyright to the "zlib" are as follows.

Copyright notice:

(C) 1995-1998 Jean-loup Gailly and Mark Adler

This software is provided 'as-is', without any express or implied warranty. In no event will the authors be held liable for any damages arising from the use of this software.

Permission is granted to anyone to use this software for any purpose, including commercial applications, and to alter it and redistribute it freely, subject to the following restrictions:

1. The origin of this software must not be misrepresented; you must not claim that you wrote the original software. If you use this software in a product, an acknowledgment in the product documentation would be appreciated but is not required.
2. Altered source versions must be plainly marked as such, and must not be misrepresented as being the original software.
3. This notice may not be removed or altered from any source distribution.

Jean-loup Gailly
 jloup@gzip.org

Mark Adler
 madler@alummi.caltech.edu

If you use the zlib library in a product, we would appreciate *not* receiving lengthy legal documents to sign. The sources are provided for free but without warranty of any kind. The library has been entirely written by Jean-loup Gailly and Mark Adler; it does not include third-party code.

If you redistribute modified sources, we would appreciate that you include in the file ChangeLog history information documenting your changes.

libmd5-rfc

This projector product includes the open source software program "libmd5-rfc" which applies the terms and conditions provided by owner of the copyright to the "libmd5-rfc".

The "libmd5-rfc" are WITHOUT ANY WARRANTY; without even the implied warranty of MERCHANTABILITY AND FITNESS FOR A PARTICULAR PURPOSE.

List of libmd5-rfc programs

libmd5-rfc

License terms of conditions of each program which are provided by owner of the copyright to the "libmd5-rfc" are as follows.

Copyright (C) 1999, 2002 Aladdin Enterprises. All rights reserved.

This software is provided 'as-is', without any express or implied warranty. In no event will the authors be held liable for any damages arising from the use of this software.

Permission is granted to anyone to use this software for any purpose, including commercial applications, and to alter it and redistribute it freely, subject to the following restrictions:

1. The origin of this software must not be misrepresented; you must not claim that you wrote the original software. If you use this software in a product, an acknowledgment in the product documentation would be appreciated but is not required.
2. Altered source versions must be plainly marked as such, and must not be misrepresented as being the original software.
3. This notice may not be removed or altered from any source distribution.

L. Peter Deutsch ghost@aladdin.com

Independent implementation of MD5 (RFC 1321).

This code implements the MD5 Algorithm defined in RFC 1321, whose text is available at

<http://www.ietf.org/rfc/rfc1321.txt>

The code is derived from the text of the RFC, including the test suite (section A.5) but excluding the rest of Appendix A. It does not include any code or documentation that is identified in the RFC as being copyrighted.

The original and principal author of md5.h is L. Peter Deutsch <ghost@aladdin.com>. Other authors are noted in the change history that follows (in reverse chronological order):

2002-04-13 lpd Removed support for non-ANSI compilers; removed

references to Ghostscript; clarified derivation from RFC 1321; now handles byte order either statically or dynamically.

1999-11-04 lpd Edited comments slightly for automatic TOC extraction.

1999-10-18 lpd Fixed typo in header comment (ansi2knr rather than md5);

added conditionalization for C++ compilation from Martin Purschke <purschke@bnl.gov>.

1999-05-03 lpd Original version.

ncurses

This projector product includes the open source software program "ncurses" which applies the terms and conditions provided by owner of the copyright to the "ncurses".

The "ncurses" are WITHOUT ANY WARRANTY; without even the implied warranty of MERCHANTABILITY AND FITNESS FOR A PARTICULAR PURPOSE.

List of ncurses programs

ncurses-5.6

License terms of conditions of each program which are provided by owner of the copyright to the "ncurses" are as follows.

Copyright (c) 1998-2002,2003 Free Software Foundation, Inc.

Permission is hereby granted, free of charge, to any person obtaining a copy of this software and associated documentation files (the "Software"), to deal in the Software without restriction, including without limitation the rights to use, copy, modify, merge, publish, distribute, distribute with modifications, sublicense, and/or sell copies of the Software, and to permit persons to whom the Software is furnished to do so, subject to the following conditions:

The above copyright notice and this permission notice shall be included in all copies or substantial portions of the Software.

THE SOFTWARE IS PROVIDED "AS IS", WITHOUT WARRANTY OF ANY KIND, EXPRESS OR IMPLIED, INCLUDING BUT NOT LIMITED TO THE WARRANTIES OF MERCHANTABILITY, FITNESS FOR A PARTICULAR PURPOSE AND NONINFRINGEMENT. IN NO EVENT SHALL THE ABOVE COPYRIGHT HOLDERS BE LIABLE FOR ANY CLAIM, DAMAGES OR OTHER LIABILITY, WHETHER IN AN ACTION OF CONTRACT, TORT OR OTHERWISE, ARISING FROM, OUT OF OR IN CONNECTION WITH THE SOFTWARE OR THE USE OR OTHER DEALINGS IN THE SOFTWARE.

Except as contained in this notice, the name(s) of the above copyright holders shall not be used in advertising or otherwise to promote the sale, use or other dealings in this Software without prior written authorization.



Discount-Merchant.com (800) 281-8860
THE TRUSTED SOURCE FOR PROJECTOR LAMPS AND ACCESSORIES

A	Control Panel Lock.....	31, 38	I	Image Menu.....	35
A/V Mute.....	Cross.....	26	Indicators.....	55	
Address 1 Setting.....	D		Info Menu.....	51	
Address 2 Settings.....	DHCP.....	44	Input Signal.....	51	
Address 3 Setting.....	Direct Power On.....	40	IP Address.....	44, 48	
Air exhaust vent.....	Display.....	39	K		
Air filter replacement period.....	Display Background.....	39	Keystone.....	37	
Audio-L/R input port.....	Distance.....	78	L		
Auto Setup.....	E		Lamp cover.....	9	
B	ESC/VP21.....	90	Lamp Hours.....	51	
Basic Menu.....	Extended Menu.....	39	Lamp indicator.....	55	
Blackboard.....	E-Zoom.....	26	Lamp replacement period.....	69	
Brightness.....	F		Language.....	40	
Brightness Control.....	Freeze.....	20	Low.....	38	
C	Front.....	39	M		
Ceiling.....	Front adjustable foot.....	9	Mail Menu.....	48	
Ceiling mount fixing points.....	Full Lock.....	31	Mail Notification.....	48	
Cleaning the Air filter and Air intake vent.....	G		Messages.....	39	
.....	Gateway Address.....	44, 47	Mic Input Port.....	10	
Cleaning the Projector's Surface.....	H		Mic Input Volume.....	38	
Color Adjustment.....	Help function.....	54	Monitor Displays.....	93	
Color Mode.....	High Altitude Mode.....	40	Mouse Pointer.....	27	
Color Saturation.....	How to replace the air filter.....	72	N		
Computer1 Input Port.....	How to replace the lamp.....	69	Network Menu.....	41	
Computer2 Input Port.....			Network Protect.....	30	
Configuration Menu.....					
Connecting USB Devices.....					
Consumables.....					
Contrast.....					
Control panel.....					

 FixYourLamp.com
 Sponsored by DPA
DiscountMerchants.com (800) 281-8860
 THE TRUSTED SOURCE FOR PROJECTOR LAMPS AND ACCESSORIES

O

Operating temperature.....	97
Operation.....	40
Optional accessories.....	75
Others Menu.....	49
Overheating.....	56

P

Part Names and Functions.....	9
Password Protect.....	29
Password protect sticker.....	30
Photo.....	18
PJLink.....	92
Pointer.....	25
Pointer Shape.....	38
Port Number.....	48
Position.....	36
Power indicator.....	55
Power inlet.....	10
Power On Protect.....	29
Presentation.....	18
Problem Solving.....	55
Progressive.....	37
Projection.....	39
Projector Name.....	43

R

Rear.....	39
Rear foot.....	11
Rear screen.....	66
Refresh Rate.....	51
Remote Control.....	13

Remote Receiver.....	9, 10
Replacing batteries.....	68
Reset All.....	52
Reset Menu.....	52
Resetting the lamp operating time.....	52, 72
Resolution.....	51

S

Screen size.....	78
Security menu.....	45
Security slot.....	9
Settings Menu.....	37
Sharpness.....	35
Signal Menu.....	36
Sleep Mode.....	40
SMTP Server.....	48
Soft keyboard.....	42
Source.....	51
Source Search.....	12, 16
Specifications.....	97
Sports.....	18
sRGB.....	18
SSID.....	44
Standby Mode.....	40
Startup Screen.....	39
Storage temperature.....	97
Subnet Mask.....	44, 47
Supported Monitor Displays.....	93
S-Video Input Port.....	10
Sync Info.....	51
Sync.....	66

T

Temp indicator.....	55
Theatre.....	18
Tint.....	35
Tracking.....	36
Trap IP Address.....	49

U

User's Logo.....	76
User's Logo Protect.....	29

V

Video Input Port.....	10
Video Signal.....	37, 51
Volume.....	38

W

Wide-screen projection.....	20
Wired LAN Menu.....	47
Wireless LAN Menu.....	44
Wireless Mouse.....	27

Z

Zoom ring.....	9
----------------	---



FixYourDLP.com

Sponsored by DPA

Discount Merchant.com (800) 281-8860

THE TRUSTED SOURCE FOR PROJECTOR LAMPS AND ACCESSORIES



Disclaimer

This user manual is provided as a free service by FixYourDLP.com. FixYourDLP is in no way responsible for the content of this manual, nor do we guarantee its accuracy. FixYourDLP does not make any claim of copyright and all copyrights remain the property of their respective owners.

About FixYourDLP.com

FixYourDLP.com (<http://www.fixyourdpl.com>) is the World's #1 resource for media product news, reviews, do-it-yourself guides, and manuals.

Informational Blog: <http://www.fixyourdpl.com>

Video Guides: <http://www.fixyourdpl.com/guides>

User Forums: <http://www.fixyourdpl.com/forum>

FixYourDLP's Fight Against Counterfeit Lamps:

<http://www.fixyourdpl.com/counterfeits>

Sponsors:

RecycleYourLamp.org – Free lamp recycling services for used lamps:

<http://www.recycleyourlamp.org>

Lamp Research - The trusted 3rd party lamp research company:

<http://www.lampresearch.com>

Discount-Merchant.com – The worlds largest lamp distributor:

<http://www.discount-merchant.com>



FixYourDLP.com

Sponsored by 