



# Disclaimer

This user manual is provided as a free service by FixYourDLP.com. FixYourDLP is in no way responsible for the content of this manual, nor do we guarantee its accuracy. FixYourDLP does not make any claim of copyright and all copyrights remain the property of their respective owners.

About FixYourDLP.com

FixYourDLP.com (<http://www.fixyourdpl.com>) is the World's #1 resource for media product news, reviews, do-it-yourself guides, and manuals.

Informational Blog: <http://www.fixyourdpl.com>

Video Guides: <http://www.fixyourdpl.com/guides>

User Forums: <http://www.fixyourdpl.com/forum>

FixYourDLP's Fight Against Counterfeit Lamps:

<http://www.fixyourdpl.com/counterfeits>

## Sponsors:

RecycleYourLamp.org – Free lamp recycling services for used lamps:

<http://www.recycleyourlamp.org>

Lamp Research - The trusted 3rd party lamp research company:

<http://www.lampresearch.com>

Discount-Merchant.com – The worlds largest lamp distributor:

<http://www.discount-merchant.com>



**FixYourDLP.com**

Sponsored by 



# User's Guide

## Multimedia Projector

**EB-W8**

**EB-X8**

**EB-S8**

**EB-W7**

**EB-X7**

**EB-S7**



FixYourDLP.com

Sponsored by 

**Discount-Merchant.com (800) 281-8860**



**THE TRUSTED SOURCE FOR PROJECTOR LAMPS AND ACCESSORIES**

## Notations Used in This Guide





- **Safety indications**

The documentation and the projector use graphical symbols to show how to use the projector safely.

The indications and their meaning are as follows. Make sure you understand them properly before reading the guide.

 <b>Warning</b>	This symbol indicates information that, if ignored, could possibly result in personal injury or even death due to incorrect handling.
 <b>Caution</b>	This symbol indicates information that, if ignored, could possibly result in personal injury or physical damage due to incorrect handling.

- **General information indications**

<b>Attention</b>	Indicates procedures which may result in damage or injury if sufficient care is not taken.
	Indicates additional information and points which may be useful to know regarding a topic.
	Indicates a page where detailed information regarding a topic can be found.
	Indicates that an explanation of the underlined word or words in front of this symbol appears in the glossary of terms. See the "Glossary" section of the "Appendix".  <a href="#">p.100</a>
<b>Procedure</b>	Indicates operating methods and the order of operations. The procedure indicated should be carried out in the order of the numbered steps.
[ (Name) ]	Indicates the name of the buttons on the Remote Control or the Control panel. Example: [Esc] button
"(Menu Name)" <b>Brightness</b> (bolded)	Indicates Configuration Menu items. Example: <b>Select "Brightness" from the Image menu.</b> <b>Image menu - Brightness</b>



## Notations Used in This Guide..... 2

### Introduction

#### Projector Features..... 7

Features Common to Each Model. . . . .	7
Designed for easy handling. . . . .	7
Enhanced security functions. . . . .	7
EB-W8/X8 Features. . . . .	8
Projecting JPEG images on a USB storage or a digital camera without using a computer. . . . .	8
Equipped with HDMI port for a wide range of usage, such as watching movies and videos. . . . .	8

#### Part Names and Functions..... 9

Front/Top. . . . .	9
Rear (EB-W8/X8). . . . .	10
Rear (EB-S8). . . . .	11
Rear (EB-W7/X7/S7). . . . .	12
Base. . . . .	13
Control Panel (EB-W8/X8/W7/X7). . . . .	13
Control Panel (EB-S8/S7). . . . .	14
Remote Control. . . . .	15

### Useful Functions

#### Connecting with a USB cable and Projecting (USB Display). . . . . 18

Operating Conditions for USB Display. . . . .	18
Connecting. . . . .	18
Connecting for the first time. . . . .	20
From the second time. . . . .	21

#### Changing the Projected Image. . . . . 22

Automatically Detect Input Signal and Change the Projected Image (Source Search) . . . . .	22
Switch to the target image by Remote Control. . . . .	23

#### Functions for Enhancing Projection..... 24

Selecting the Projection Quality (Selecting Color Mode). . . . .	24
Setting the Auto Iris. . . . .	25
Hiding the Image and Sound Temporarily (A/V Mute). . . . .	25
Freezing the Image (Freeze). . . . .	26
Changing the Aspect Ratio. . . . .	27
Changing methods. . . . .	27
Changing the Aspect for video equipment images. . . . .	28
Changing the aspect for computer images (EB-X8/S8/X7/S7). . . . .	29
Changing the aspect for computer images (EB-W8/W7). . . . .	30
Pointer Function (Pointer). . . . .	32
Enlarging Part of the Image (E-Zoom). . . . .	33
Using the Remote Control as a Mouse. . . . .	34
Wireless Mouse. . . . .	34
Page Up/Down. . . . .	36

#### Security Functions..... 37

Managing Users (Password Protect). . . . .	37
Type of Password Protect. . . . .	37
Setting Password Protect. . . . .	37
Entering the Password. . . . .	38
Restricting Operation (Control Panel Lock). . . . .	39
Anti-Theft Lock. . . . .	40
Installing the wire lock. . . . .	40

#### Making a Presentation with a Slideshow (EB-W8/X8 only). . . . . 41

Specifications of Files that can be Projected in a Slideshow. . . . .	41
Connecting and Removing USB Devices. . . . .	41
Connecting USB devices. . . . .	41
Removing USB devices. . . . .	42
Starting and Ending a Slideshow. . . . .	42
Starting a slideshow. . . . .	42
Ending a slideshow. . . . .	42
Slideshow Basic Operations. . . . .	42
Rotating Images. . . . .	43
Projecting Image Files. . . . .	44
Projecting an image. . . . .	44
Sequentially projecting all image files in a folder (Slideshow). . . . .	45

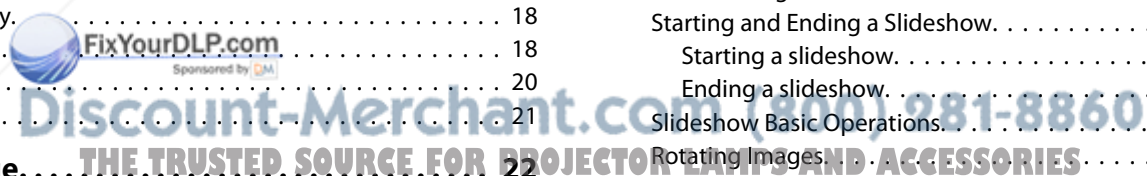

Image File Display Setting and Slideshow Operation Setting. . . . . 46

## Configuration Menu

**Using the Configuration Menu. . . . . 48**

**List of Functions. . . . . 49**

- Image Menu. . . . . 49
- Signal Menu. . . . . 50
- Settings Menu. . . . . 52
- Extended Menu. . . . . 53
- Info Menu (Display Only). . . . . 55
- Reset Menu. . . . . 56

## Troubleshooting

**Using the Help. . . . . 58**

**Problem Solving. . . . . 59**

- Reading the Indicators. . . . . 59
  - ⏻ Indicator is lit or flashing red. . . . . 60
  - 🔊 Indicator is lit or flashing orange. . . . . 61
- When the Indicators Provide No Help. . . . . 62
  - Problems relating to images. . . . . 63
  - Problems when projection starts. . . . . 67
  - Other problems. . . . . 67

## Appendix

**Installation Methods. . . . . 70**

**Cleaning. . . . . 71**

- Cleaning the Projector's Surface. . . . . 71
- Cleaning the Lens. . . . . 71
- Cleaning the Air Filter. . . . . 72

**Replacing Consumables. . . . . 73**

- Replacing the Remote Control Batteries. . . . . 73
- Replacing the Lamp. . . . . 74
  - Lamp replacement period. . . . . 74
  - How to replace the lamp. . . . . 74
  - Resetting the lamp hours. . . . . 77
- Replacing the Air Filter. . . . . 77
  - Air filter replacement period. . . . . 77
  - How to replace the air filter. . . . . 77

**Optional Accessories and Consumables. . . . . 79**

- Optional accessories. . . . . 79
- Consumables. . . . . 79

**Saving a User's Logo. . . . . 80**

**Screen Size and Projection Distance. . . . . 82**

- Projection Distances (EB-W8/W7). . . . . 82
- Projection Distances (EB-X8/X7). . . . . 83
- Projection Distances (EB-S8/S7). . . . . 84

**Connecting to External Equipment (EB-W7/X7/S8/S7 only). . . . . 85**

- Connecting to an External Monitor (EB-W7/X7/S7 only). . . . . 85
- Connecting to External Speakers (EB-S8/W7/X7/S7 only). . . . . 86

**Monitoring and Controlling the Projector Using a Computer (ESC/VP21 Commands). . . . . 87**

- Before You Begin. . . . . 87
- Command List. . . . . 87
  - Communications protocol. . . . . 87

**Supported Monitor Displays. . . . . 88**

- Supported Monitor Displays (EB-W8/W7). . . . . 88
  - Computer signals (analog RGB). . . . . 88
  - Component video. . . . . 89
  - Composite video/S-video. . . . . 89
  - Input signal from the HDMI input port (EB-W8 only). . . . . 90
- Supported Monitor Displays (EB-X8/X7). . . . . 91
  - Computer signals (analog RGB). . . . . 91



Discount-Merchant.com (800) 281-8860  
 THE TRUSTED SOURCE FOR PROJECTOR LAMP AND ACCESSORIES

Component video. . . . .	92
Composite video/S-video. . . . .	92
Input signal from the HDMI input port (EB-X8 only). . . . .	92
Supported Monitor Displays (EB-S8/S7). . . . .	93
Computer signals (analog RGB). . . . .	93
Component video. . . . .	94
Composite video/S-video. . . . .	95
<b>Specifications. . . . .</b>	<b>96</b>
Projector General Specifications. . . . .	96
<b>Appearance. . . . .</b>	<b>99</b>
<b>Glossary. . . . .</b>	<b>100</b>
<b>General Notes. . . . .</b>	<b>102</b>
General Notice: . . . . .	102
<b>Index. . . . .</b>	<b>103</b>



**Discount-Merchant.com (800) 281-8860**  
**THE TRUSTED SOURCE FOR PROJECTOR LAMPS AND ACCESSORIES**



# Introduction

This chapter explains the projector's features and the part names.



**Discount-Merchant.com (800) 281-8860**  
**THE TRUSTED SOURCE FOR PROJECTOR LAMPS AND ACCESSORIES**

## Features Common to Each Model

### Designed for easy handling

- **Connecting with a USB cable and Projecting (USB Display)**  
Simply by connecting the projector to a Windows Computer with the USB cable, you can project images from the computer screen. "Connecting with a USB cable and Projecting (USB Display)" [p.18](#)

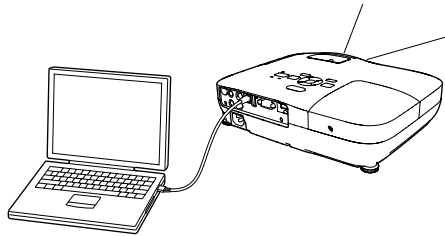

- **Direct power On/Off**  
In places where power is managed centrally, such as in a conference room, the projector can be set to power on and off automatically when the power source to which the projector is connected is switched on or off.
- **The A/V mute slide makes it easy to project and store**  
You can stop and resume projection easily by opening and closing the A/V mute slide which makes giving clear presentations easier.

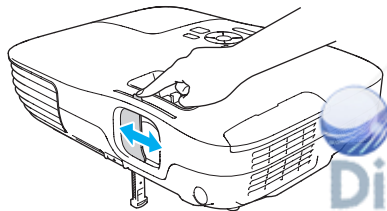

FixYourDLP.com  
Sponsored by DM

Discount-Merchant.com (800) 281-8860  
THE TRUSTED SOURCE FOR PROJECTOR LAMPS AND ACCESSORIES

- **A single foot design means you do not have to make any difficult leveling adjustments**  
You can easily make height adjustments with one hand.

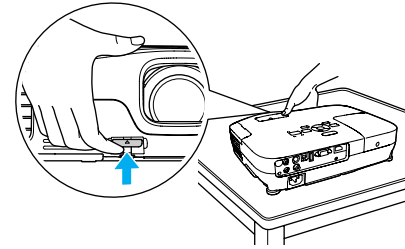

- **Compact and lightweight**  
Its light and compact body makes it easy to carry.

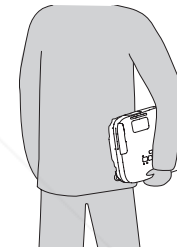

- **No cool down delay**  
After turning the projector's power off, you can disconnect the projector's power cable without having to wait for the projector to cool down.

### Enhanced security functions

- **Password Protect to restrict and manage users**  
By setting a Password you can restrict who can use the projector.
- **Control Panel Lock restricts button operation on the Control panel**  
You can use this to prevent people changing projector settings without permission at events, in schools, and so on.



## EB-W8/X8 Features

### Projecting JPEG images on a USB storage or a digital camera without using a computer

By connecting a USB storage or a digital camera to the projector, you can project a Slideshow of JPEG images, such as pictures taken with a digital camera. Images can be projected quickly and easily, with no need to connect a computer. ["Making a Presentation with a Slideshow \(EB-W8/X8 only\)"](#)

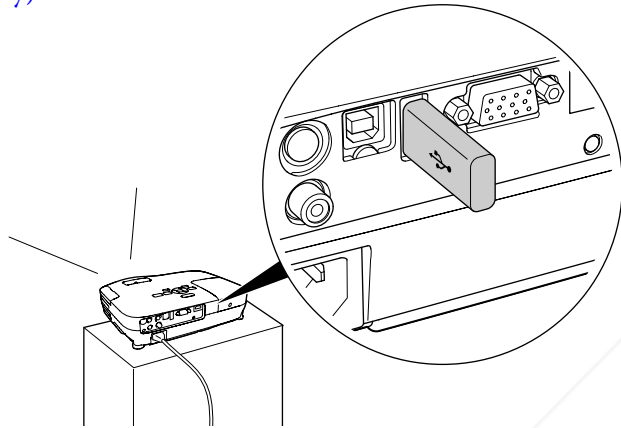



### Equipped with HDMI port for a wide range of usage, such as watching movies and videos





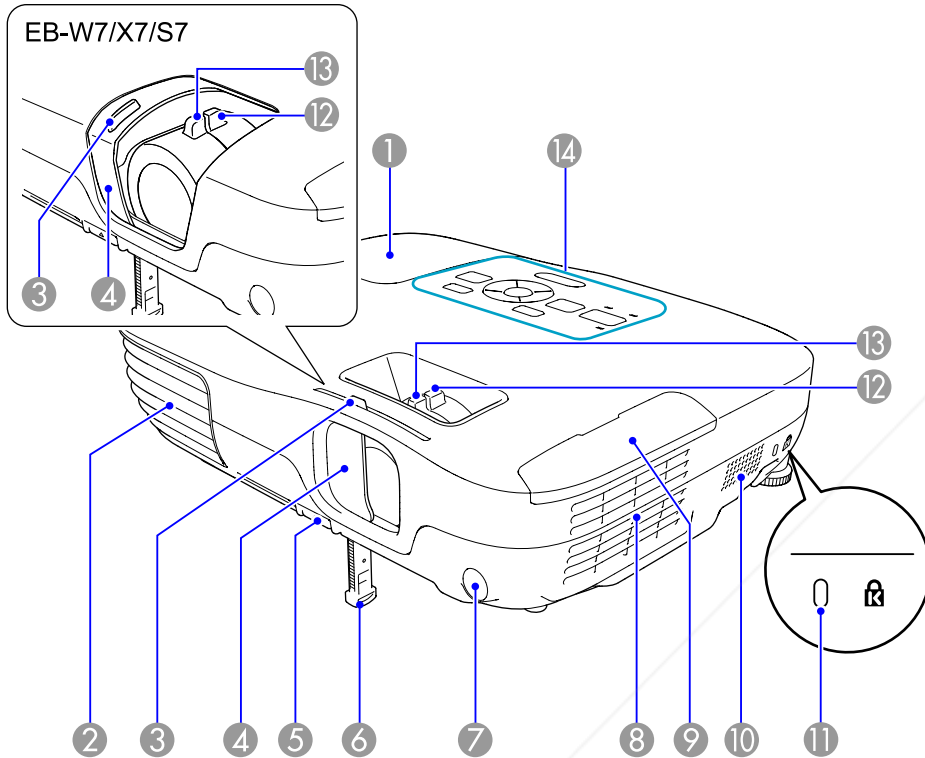





You can project high-quality images and music by connecting various digital RGB equipment to the HDMI port, such as a DVD player, Blu-ray disc player, game console, and needless to mention, a computer.

## Front/Top

The illustration is that of EB-W8/X8. From here on, all features will be explained using illustrations of EB-W8/X8 unless otherwise mentioned.



Name	Function
1 Lamp cover	Open this cover when replacing the projector's Lamp.  p.74

Name	Function
2 Air exhaust vent	Exhaust vent for air used to cool the projector internally. <div style="border: 1px solid black; padding: 5px; margin-top: 10px;">  <b>Caution</b>                      Do not place objects that may become warped or otherwise affected by heat near the Air exhaust vent and do not put your face or hands near the vent while projection is in progress.                 </div>
3 A/V mute slide knob	Slide the knob to open and close the A/V mute slide.
4 A/V mute slide	Close when not using the projector to protect the lens. By closing during projection you can hide the image and the sound (A/V Mute).  p.25
5 Foot adjust lever	Pull the Foot adjust lever to extend and retract the Front adjustable foot.  Quick Start Guide
6 Front adjustable foot	Extend and adjust the position of the projected image when the projector is placed on a surface such as a desk.  Quick Start Guide
7 Remote Receiver	Receives signals from the remote control.  Quick Start Guide
8 Air filter (Air intake vent)	Takes in air to cool the projector internally. If dust collects here it can cause the internal temperature to rise, and this can lead to problems with operation and shorten the optical engine's service life. Be sure to clean the Air filter regularly.  p.72, p.77
9 Air filter cover	Open and close when replacing the air filter.  p.77
10 Speaker	
11 Security slot	The Security slot is compatible with the Microsaver Security System manufactured by Kensington.  p.40
12 Zoom ring (EB-W8/X8/W7/X7 only)	Adjusts the image size.  Quick Start Guide
13 Focus ring	Adjusts the image focus.  Quick Start Guide

Name	Function
14 Control panel	<ul style="list-style-type: none"> <li>"Control Panel (EB-W8/X8/W7/X7)" <a href="#">p.13</a></li> <li>"Control Panel (EB-S8/S7)" <a href="#">p.14</a></li> </ul>

**Rear (EB-W8/X8)**

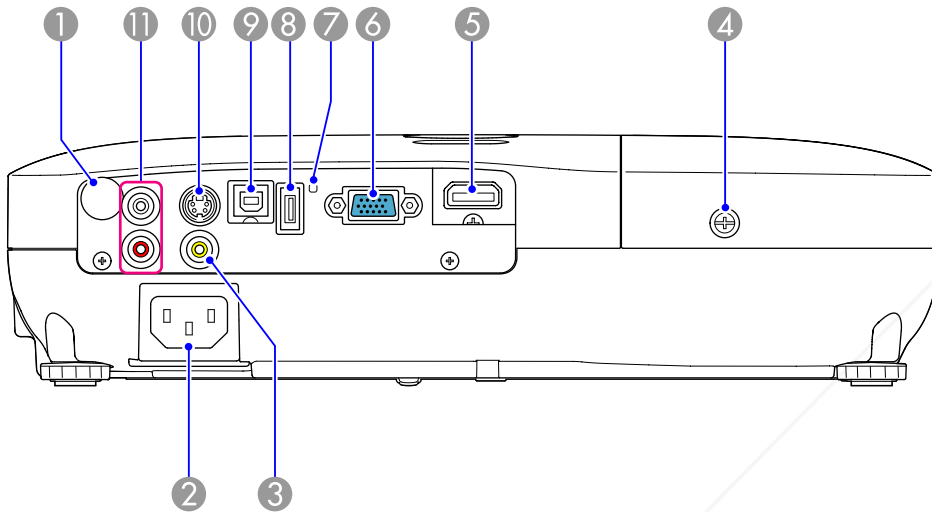







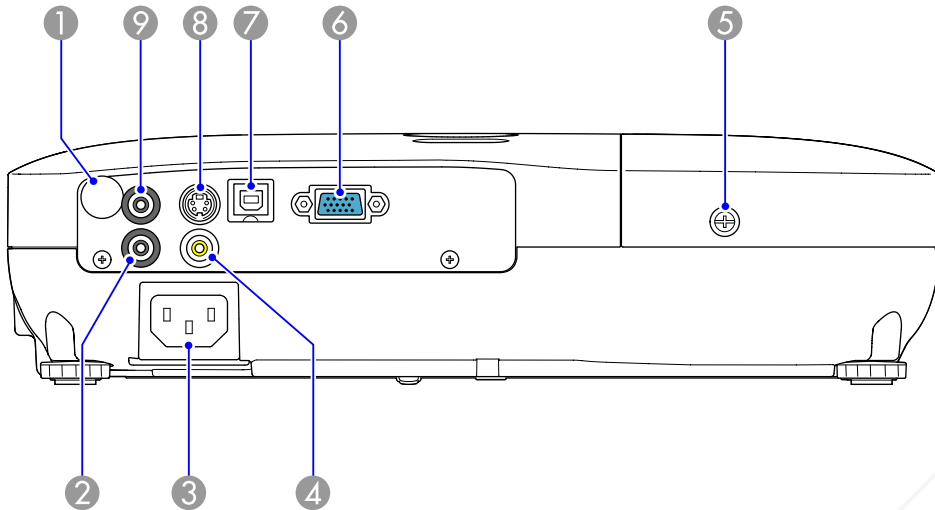

Name	Function
1 Remote Receiver	Receives signals from the remote control. <a href="#">Quick Start Guide</a>
2 Power inlet	Connects to the power cable. <a href="#">Quick Start Guide</a>
3 Video Input Port	For composite video signals from video sources.
4 Lamp Cover Fixing Screw	Screw to <a href="#">the Lamp cover in place.</a> <a href="#">p.74</a>
5 HDMI input port	Inputs video signals from HDMI compatible video equipment and computers. This projector is compatible with HDCP <a href="#">▶▶</a> .

Name	Function
6 Computer input port	For video signals from a computer and component video signals from other video sources.
7 USB indicator	The following explains the status of USB devices connected to USB(TypeA) port. OFF: USB device is not connected Orange Light ON: USB device is connected Green Light ON: USB device is operating Red Light ON: Error
8 USB(TypeA) port	Connects a USB storage device or a digital camera, and projects JPEG images using Slideshow.
9 USB(TypeB) port	You can use the following functions by connecting to a computer with the supplied USB cable. <ul style="list-style-type: none"> <li>• USB Display <a href="#">p.18</a></li> <li>• Wireless Mouse <a href="#">p.34</a></li> <li>• Paging operation of document files such as PowerPoint files <a href="#">p.36</a></li> <li>• Monitoring and controlling of the projector via USB communication <a href="#">p.87</a></li> </ul>
10 S-Video input port	For S-video signals from video sources.
11 Audio-L/R port	Inputs audio from the audio out port on the other equipment. <a href="#">Quick Start Guide</a>

Rear (EB-S8)



Name	Function
1 Remote Receiver	Receives signals from the remote control.  <a href="#">Quick Start Guide</a>
2 Audio port	Inputs audio from the audio out port on the other equipment.  <a href="#">Quick Start Guide</a>
3 Power inlet	Connects to the power cable.  <a href="#">Quick Start Guide</a>
4 Video Input Port	For composite video signals from video sources.
5 Lamp Cover Fixing Screw	Screw to fix the Lamp cover in place.  <a href="#">p.74</a>
6 Computer input port	For video signals from a computer and component video signals from other video sources.

Name	Function
7 USB(TypeB) port	You can use the following functions by connecting to a computer with the supplied USB cable. <ul style="list-style-type: none"> <li>• USB Display  <a href="#">p.18</a></li> <li>• Wireless Mouse  <a href="#">p.34</a></li> <li>• Paging operation of document files such as PowerPoint files  <a href="#">p.36</a></li> <li>• Monitoring and controlling of the projector via USB communication  <a href="#">p.87</a></li> </ul>
8 S-Video input port	For S-video signals from video sources.
9 Audio Out port	Outputs the sound of the image currently being projected to external speakers.  <a href="#">p.86</a>

Rear (EB-W7/X7/S7)

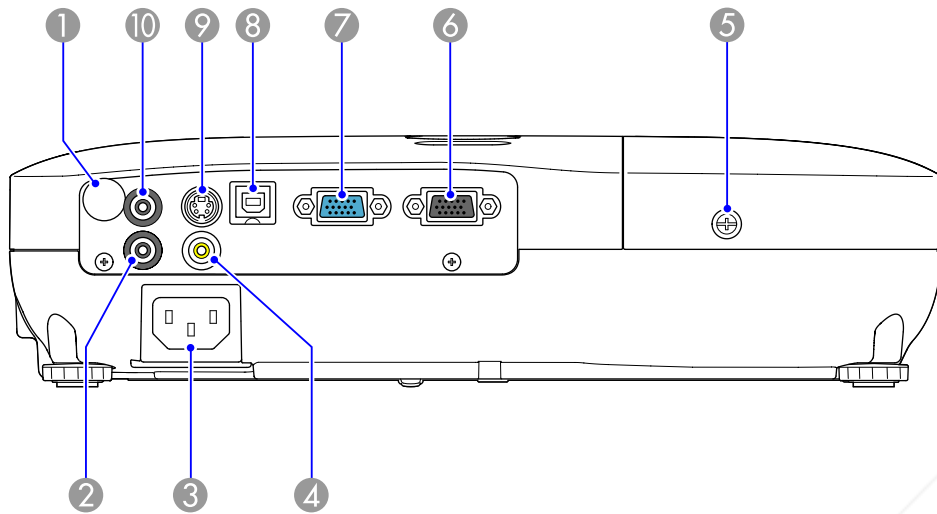

Name	Function
8 <b>USB(TypeB) port</b>	You can use the following functions by connecting to a computer with a commercially available USB cable. <ul style="list-style-type: none"> <li>• USB Display <a href="#">p.18</a></li> <li>• Wireless Mouse <a href="#">p.34</a></li> <li>• Paging operation of document files such as PowerPoint files <a href="#">p.36</a></li> <li>• Monitoring and controlling of the projector via USB communication <a href="#">p.87</a></li> </ul>
9 <b>S-Video input port</b>	For S-video signals from video sources.
10 <b>Audio Out port</b>	Outputs the sound of the image currently being projected to external speakers. <a href="#">Quick Start Guide</a>

Name	Function
1 <b>Remote Receiver</b>	Receives signals from the remote control. <a href="#">Quick Start Guide</a>
2 <b>Audio port</b>	Inputs audio from the audio out port on the other equipment. <a href="#">Quick Start Guide</a>
3 <b>Power inlet</b>	Connects to the power cable. <a href="#">Quick Start Guide</a>
4 <b>Video Input Port</b>	For composite video signals from video sources.
5 <b>Lamp Cover Fixing Screw</b>	Screw to fix the Lamp cover in place. <a href="#">p.74</a>
6 <b>Monitor Out port</b>	Outputs to an external monitor the image signal from the computer connected to the Computer input port. This is not available for component video signals or other signals being input to any port other than the Computer input port. <a href="#">p.85</a>
7 <b>Computer input port</b>	For video signals from a computer and component video signals from other video sources.

Discount Merchant.com (800) 281-8860  
 THE TRUSTED SOURCE FOR PROJECTOR LAMPS AND ACCESSORIES

**Base**

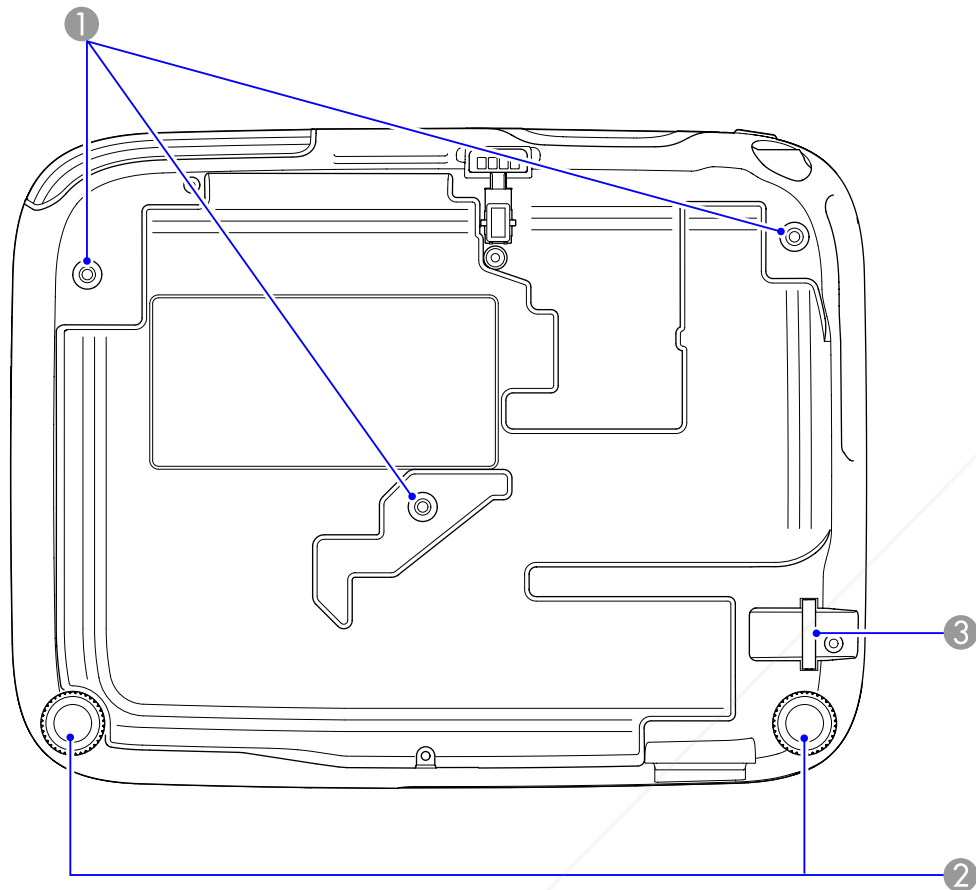

Name	Function
1 Ceiling mount fixing points (three points)	Attach the optional Ceiling mount here when suspending the projector from a ceiling. <a href="#">p.70</a> , <a href="#">p.79</a>
2 Rear foot	When setup on a desk, turn to extend and retract to adjust the horizontal tilt. <a href="#">Quick Start Guide</a>





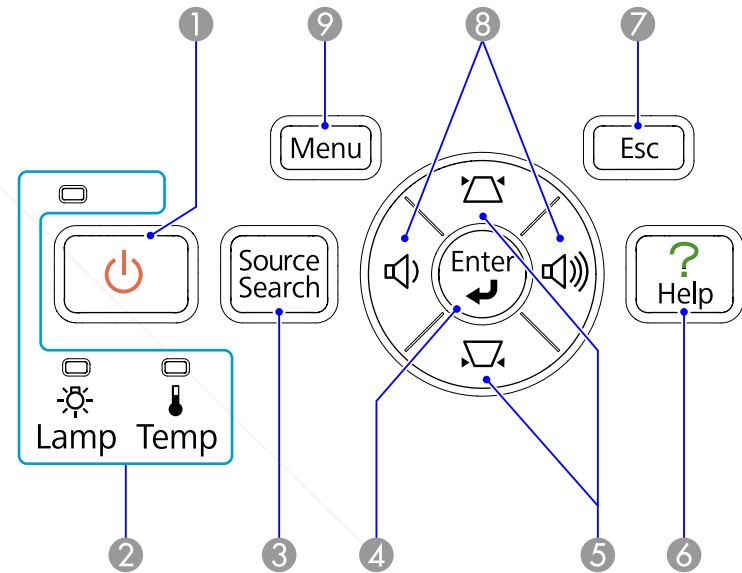

Name	Function
3 Security cable installation point	Pass a commercially available wire lock through here and lock it in place. <a href="#">p.40</a>

**Control Panel (EB-W8/X8/W7/X7)**







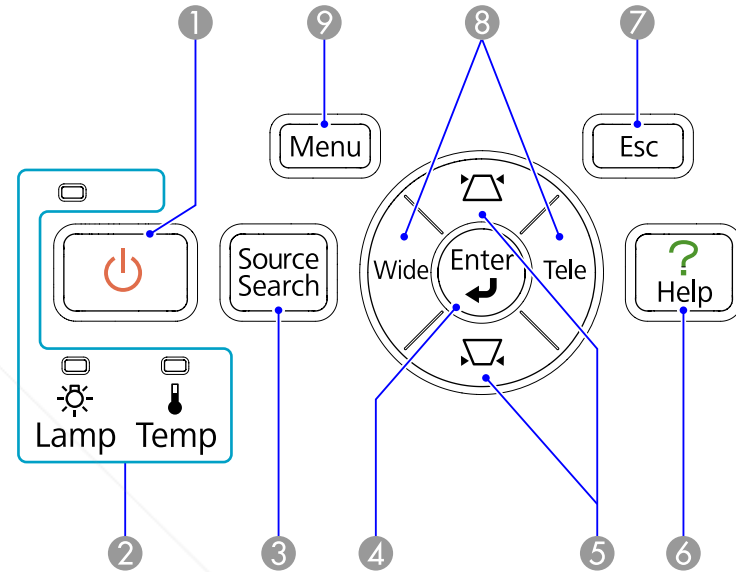

Name	Function
1 [Power] button	Turns the projector power on or off. <a href="#">Quick Start Guide</a>
2 Status indicators	The color of the indicators and whether they are flashing or lit indicate the status of the projector. <a href="#">p.59</a>
3 [Source Search] button	Changes to the next input source that is connected to the projector and is sending an image. <a href="#">p.22</a>

FixYourDLP.com  
 Discount-Merchant.com (800) 251-8880  
 THE TRUSTED SOURCE FOR PROJECTOR LAMPS AND ACCESSORIES

Name	Function
4 [Enter] button	If pressed during projection of computer signal images, it automatically adjusts the <b>Tracking, Sync.,</b> and <b>Position</b> to project the optimum image. When a Configuration Menu or a Help screen is displayed, it accepts and enters the current selection and moves to the next level.
5 [△][▽] buttons	Corrects Keystone distortion.  <i>Quick Start Guide</i> However, when projecting in Slideshow (EB-W8/X8 only), the buttons only have the [ ▲ ] [ ▼ ] functions. If pressed when a Configuration Menu or a Help screen is displayed, these buttons select menu items and setting values.  p.48
6 [Help] button	Displays and closes the Help screen which shows you how to deal with problems if they occur.  p.58
7 [Esc] button	Stops the current function. If pressed when a Configuration menu is displayed, it moves to the previous menu level.  p.48
8 [◀][▶] buttons	Adjusts the volume.  <i>Quick Start Guide</i> However, when projecting in Slideshow (EB-W8/X8 only), the buttons only have the [ ◀ ] [ ▶ ] functions. If pressed when a Configuration Menu or a Help screen is displayed, these buttons select menu items and setting values.  p.48
9 [Menu] button	Displays and closes the Configuration Menu.  p.48

## Control Panel (EB-S8/S7)



Name	Function
1 [⏻] button	Turns the projector power on or off.  <i>Quick Start Guide</i>
2 Status indicators	The color of the indicators and whether they are flashing or lit indicate the status of the projector.  p.59
3 [Source Search] button	Changes to the next input source that is connected to the projector and is sending an image.  p.22
4 [Enter] button	If pressed during projection of computer signal images, it automatically adjusts the <b>Tracking, Sync.,</b> and <b>Position</b> to project the optimum image. When a Configuration Menu or a Help screen is displayed, it accepts and enters the current selection and moves to the next level.
5 [△][▽] buttons	Corrects Keystone distortion.  <i>Quick Start Guide</i> If pressed when a Configuration Menu or a Help screen is displayed, these buttons select menu items and setting values.  p.48



Name	Function
6 [Help] button	Displays and closes the Help screen which shows you how to deal with problems if they occur. <a href="#">p.58</a>
7 [Esc] button	Stops the current function. If pressed when a Configuration menu is displayed, it moves to the previous menu level. <a href="#">p.48</a>
8 [Tele]/[Wide] buttons	Adjusts the projection screen size. Pressing the [Tele] button reduces the projection screen size, and pressing the [Wide] button increases it. <a href="#">Quick Start Guide</a> If pressed when a Configuration Menu or a Help screen is displayed, these buttons select menu items and setting values. <a href="#">p.48</a>
9 [Menu] button	Displays and closes the Configuration Menu. <a href="#">p.48</a>

## Remote Control

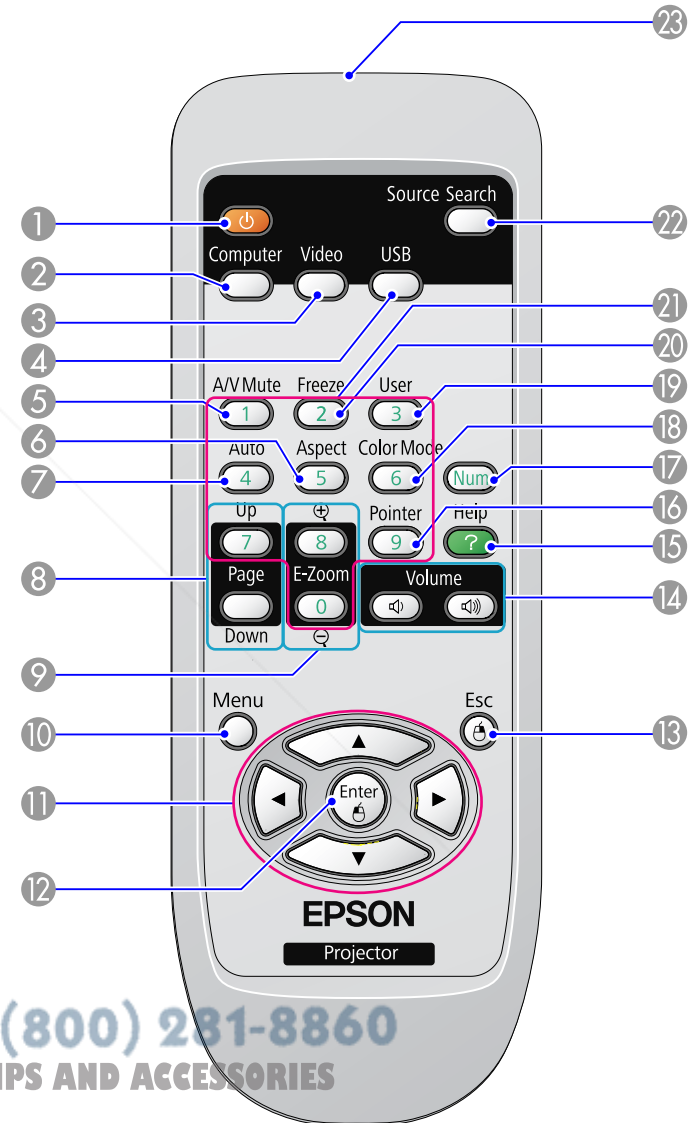



Name	Function
① [⏻] button	Turns the projector power On or Off. 🖱️ <i>Quick Start Guide</i>
② [Computer] button	Changes to images from the Computer input port. 🖱️ p.23
③ [Video] button	Each time the button is pressed, the image cycles through Video, S-Video, and HDMI (EB-W8/X8 only) input ports. 🖱️ p.23
④ [USB] button	Each time the button is pressed, the image changes between USB Display and Slideshow (EB-W8/X8 only). 🖱️ p.23
⑤ [A/V Mute] button	Turns the video and audio on or off. 🖱️ p.25
⑥ [Aspect] button	The Aspect Ratio changes each time the button is pressed. 🖱️ p.27
⑦ [Auto] button	If pressed during projection of computer signal images, it automatically adjusts the <b>Tracking</b> , <b>Sync.</b> , and <b>Position</b> to project the optimum image.
⑧ [Page] buttons (Down) (Up)	<ul style="list-style-type: none"> <li>When pressed while the projector is connected to a computer with a USB cable, you can page up and down on the screen. 🖱️ p.36</li> <li>When projecting in Slideshow, pressing this button displays the previous/next screen. (EB-W8/X8 only) 🖱️ p.44</li> </ul>
⑨ [E-Zoom] buttons (⊕) (⊖)	(⊕) Enlarges the image without changing the projection size. (⊖) Reduces parts of images that have been enlarged using the [⊕] button. 🖱️ p.33
⑩ [Menu] button	Displays the Configuration Menu. 🖱️ p.48
⑪ [⏪][⏩] [⏴][⏵] button	When a Configuration Menu or Help screen is displayed, it selects menu items and setting values. 🖱️ p.48 During Wireless Mouse function, the mouse pointer moves in the direction of the button that was pushed. 🖱️ p.34

Name	Function
⑫ [Enter] button	When a Configuration Menu or a Help screen is displayed, it accepts and enters the current selection and moves to the next level. 🖱️ p.48 Acts as a mouse's left button when using the Wireless Mouse function. 🖱️ p.34
⑬ [Esc] button	Stops the current function. If pressed when a configuration menu is displayed, it moves to the previous level. 🖱️ p.48 Acts as a mouse's right button when using the Wireless Mouse function. 🖱️ p.34
⑭ [Volume] buttons (⏮) (⏭)	(⏮) Decreases the Volume. (⏭) Increases the Volume. 🖱️ <i>Quick Start Guide</i>
⑮ [Help] button	Displays and closes the Help screen which shows you how to deal with problems if they occur. 🖱️ p.58
⑯ [Pointer] button	Press to activate the on-screen pointer. 🖱️ p.32
⑰ [Num] button	Use when entering a Password. 🖱️ p.37
⑱ [Color Mode] button	Each time the button is pressed, the Color Mode changes. 🖱️ p.24
⑲ [User] button	Press to assign a frequently used item from the four available Configuration Menu items. By pressing the button the assigned menu item selection/adjustment screen is displayed, allowing you to make one-touch settings/adjustments. <b>Power Consumption</b> is assigned as the default setting. 🖱️ p.52
⑳ [Freeze] button	Images are paused or unpaused. 🖱️ p.26
㉑ Numeric buttons	Use when entering a Password. 🖱️ p.37
㉒ [Search] button	Changes to the next input source that is connected to the projector and is sending an image. 🖱️ p.22
㉓ Remote control light-emitting area	Outputs remote control signals.



# Useful Functions

This chapter explains useful tips for giving presentations, and the Security functions.



**Discount-Merchant.com (800) 281-8860**  
**THE TRUSTED SOURCE FOR PROJECTOR LAMPS AND ACCESSORIES**

By using a USB cable to connect the projector to a Windows computer you can project images from the computer. This function is called USB Display. Simply by connecting via a USB cable, images from the computer can be displayed.

## Operating Conditions for USB Display

USB Display operates on computers that meet the following requirements.

<b>OS</b>	Windows 2000 SP4/Windows XP/Windows XP SP1 and later/Windows Vista/Windows Vista SP1
<b>CPU</b>	Mobile Pentium III 1.2 GHz or faster Recommended: Pentium M 1.6 GHz or faster
<b>Amount of Memory</b>	256 MB or more Recommended: 512 MB or more
<b>Free Space on Hard Disk</b>	20 MB or more
<b>Display</b>	Resolution greater than XGA (1024x768) Display color of approx. 32000 colors more than 16 bit colors

## Connecting

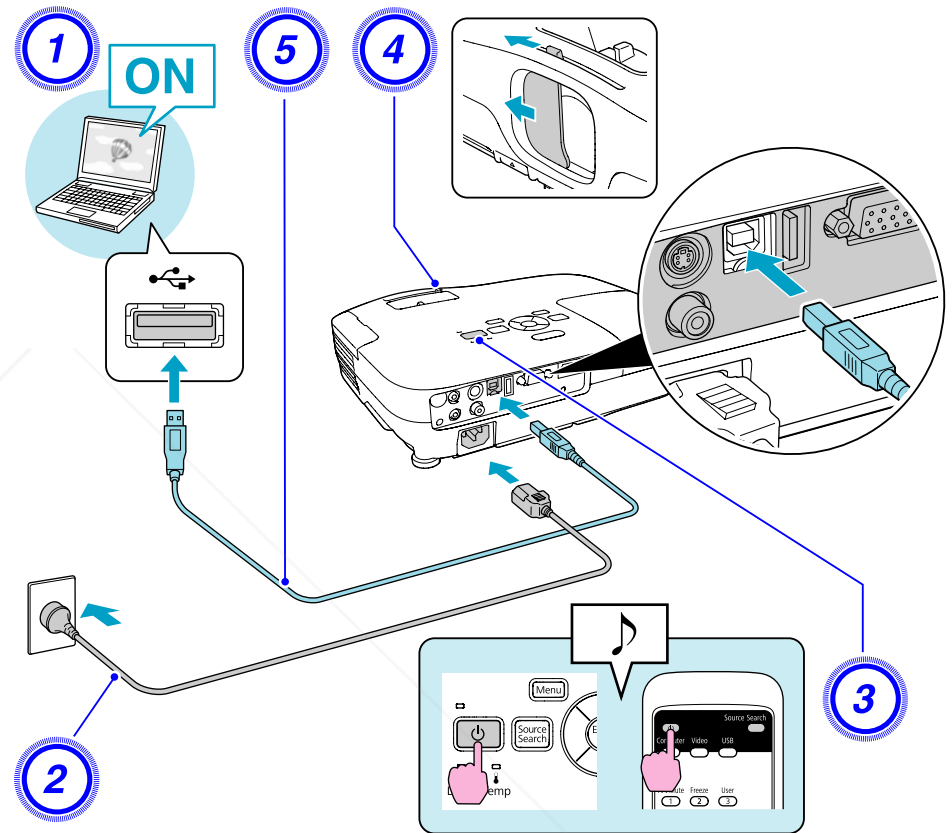

### Procedure

- 1 Turn the computer on.
- 2 Connect to the power cable (supplied).
- 3 Turn the projector on.
- 4 Open the A/V mute slide.
- 5 Connect the supplied (EB-W8/X8/S8 only) or commercially available USB cable.  
To output audio from the projector's speaker, connect an audio cable (commercially available) to the Audio Port.
  - ☛ *Quick Start Guide*
  - ☛ "Connecting for the first time" [p.20](#)
  - ☛ "From the second time" [p.21](#)

### Attention

*Connect the projector directly to the computer and not via a USB hub.*

## Connecting for the first time

### Procedure

#### 1 Driver installation starts automatically.

When you are using a Windows 2000 computer, double-click **My Computer - EPSON\_PJ\_UD - EMP\_UDSE.EXE**, on your computer.

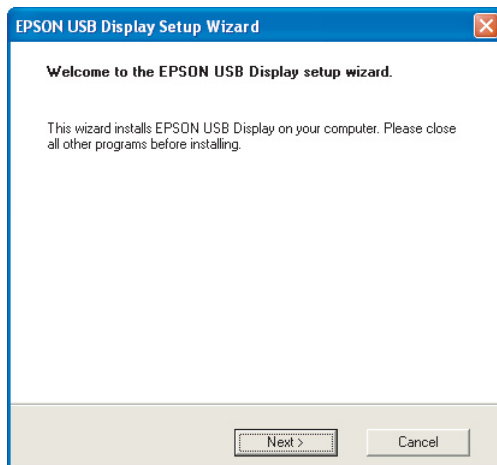

When using a computer running Windows 2000 under user authority, a Windows error message is displayed during installation and you may not be able to install the software. In this case, try updating Windows to the latest version, restart, and then try to connect again. For more details, contact the nearest address provided in the Support and Service Guide.  [Epson Projector Contact List](#)

#### 2 Click "Agree".

If the driver is not installed, you cannot start USB Display. Select **Agree** to install the driver. If you want to cancel installation, click **Disagree**.

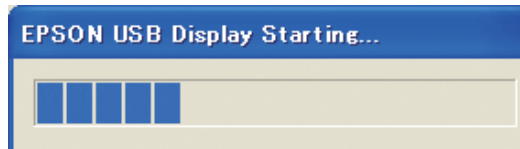

#### 3 Computer images are projected.

It may take a while before computer images are projected. Until computer images are projected, leave the equipment as it is and do not disconnect the USB cable or turn off the power to the projector.

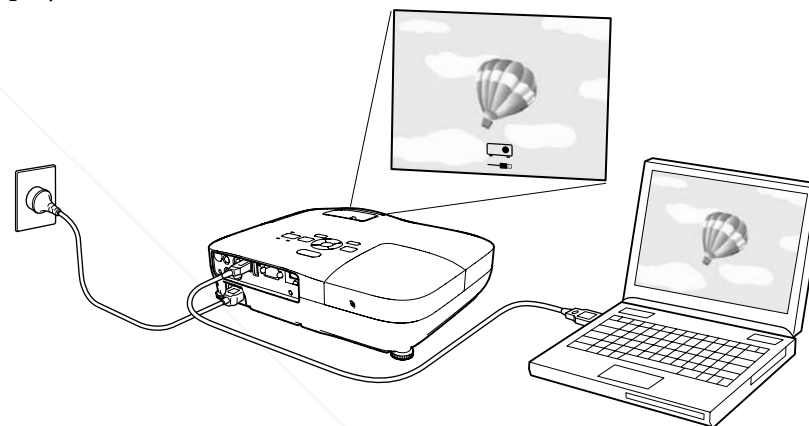



- If nothing is projected for some reason, click **All Programs - EPSON Projector - EPSON USB Display - EPSON USB Display Vx.x**, on your computer.
- If it is not installed automatically, double-click **My Computer - EPSON\_PJ\_UD - EMP\_UDSE.EXE**, on your computer.
- If the mouse pointer flickers on the computer screen, click **All Programs - EPSON Projector - EPSON USB Display - EPSON USB Display Vx.x**, and then clear the **Transfer layered window** checkbox.
- To uninstall the driver, open **Control Panel - Add/Remove Programs** - and uninstall **EPSON USB Display Vx.x**.
- **Disconnecting**  
The projector can be disconnected simply by disconnecting the USB cable. There is no need to use the **Safely Remove Hardware** feature in Windows.

### From the second time

#### Computer images are projected.

It may take a while before computer images are projected. Please wait.



Applications that use part of DirectX functions may not be displayed correctly.



**Discount-Merchant.com (800) 281-8860**  
THE TRUSTED SOURCE FOR PROJECTOR LAMPS AND ACCESSORIES

You can change the projected image in the following two ways.

- Changing by Source Search  
The projector automatically detects signals being input from connected equipment, and the image being input from the equipment is projected.
- Changing directly to the target image  
You can use the Remote Control buttons to change to the target input port.

## Automatically Detect Input Signal and Change the Projected Image (Source Search)

You can project the target image quickly as input ports with no image signal being input are ignored when you change by pressing the [Source Search] button.

### EB-W8/X8

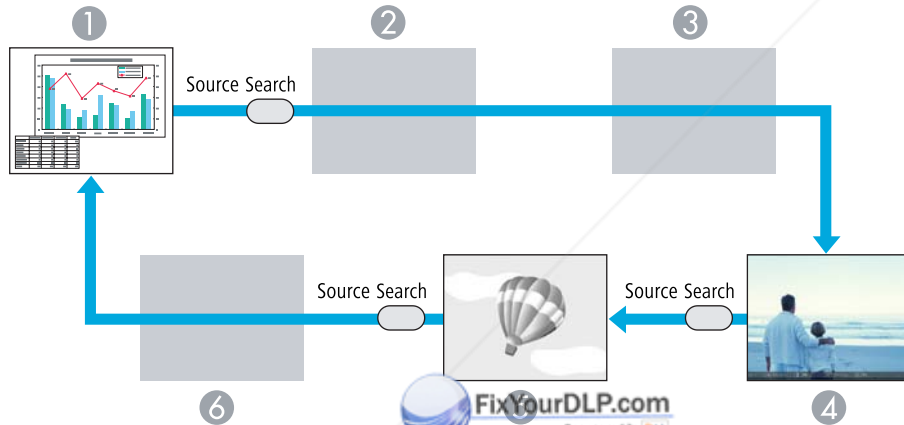

- 1 Computer
- 2 S-Video
- 3 Video
- 4 HDMI
- 5 USB Display

### 6 USB

### EB-S8/W7/X7/S7

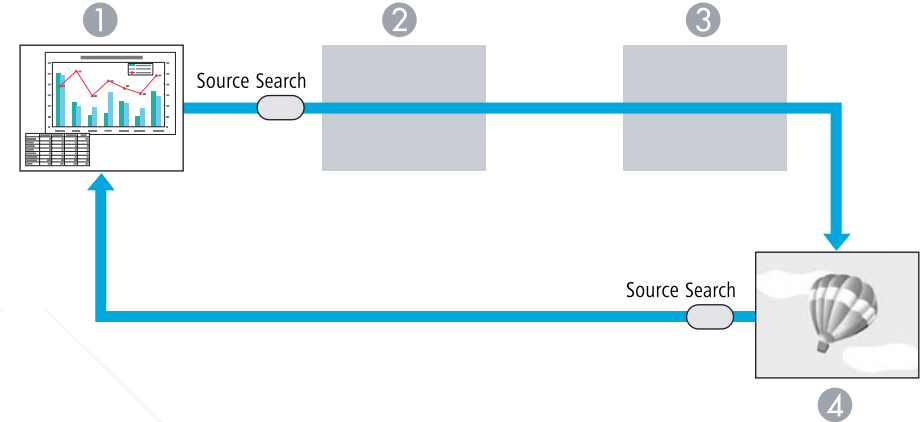

- 1 Computer
- 2 S-Video
- 3 Video
- 4 USB Display

### Procedure

When your video equipment is connected, start playback before beginning this operation.

#### Using the Remote Control

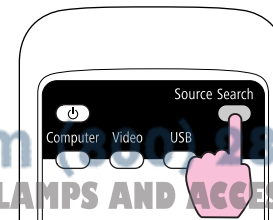

#### Using the Control panel

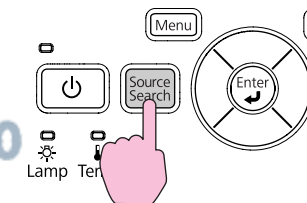

When two or more pieces of equipment are connected, press the [Source Search] button until the target image is projected.



The following screen showing the status of image signals is displayed when only the image that the projector is currently displaying is available, or when no image signal can be found. You can select the input port where the equipment you want to use is connected. If no operation is performed after about 10 seconds, the screen closes.

Example: EB-W8/X8

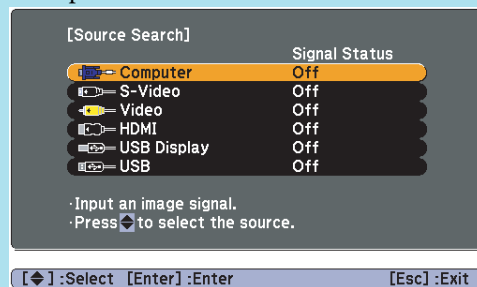

## Switch to the target image by Remote Control

You can change directly to the target image by pressing the following buttons on the Remote Control.

### Remote Control

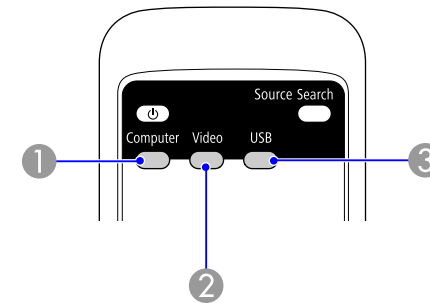

- 1 Changes to images from the Computer input port.
- 2 Each time the button is pressed, the image cycles through Video, S-Video, and HDMI (EB-W8/X8 only) input ports.
- 3 Each time the button is pressed, the image changes between USB Display and Slideshow (EB-W8/X8 only).



## Selecting the Projection Quality (Selecting Color Mode)

You can easily obtain the optimum image quality simply by selecting the setting that best corresponds to your surroundings when projecting. The brightness of the image varies depending on the mode selected.

Mode	Application
<b>Dynamic</b>	Ideal for use in a bright room. This is the brightest mode, and reproduces shadow tones well.
<b>Presentation</b>	Ideal for making presentations using color materials in a bright room.
<b>Theatre</b>	Ideal for watching films in a dark room. Gives images a natural tone.
<b>Photo*1</b>	Ideal for projecting still pictures, such as photos, in a bright room. The images are vivid and brought into contrast.
<b>Sports*2</b>	Ideal for watching TV programmes in a bright room. The images are vivid and brought to life.
<b>sRGB**</b>	Ideal for images that conform to the sRGB color standard.
<b>Blackboard</b>	Even if you are projecting onto a Blackboard (greenboard), this setting gives your images a natural tint, just like when projecting onto a screen.
<b>Whiteboard</b>	Ideal for making presentations using the whiteboard.

\*1 Selectable only when RGB signal is input or the Source is set to USB Display or USB (EB-W8/X8 only)

\*2 Selectable only when component video, DVI-D, S-video, or composite video images are input.

### Procedure

#### Remote Control

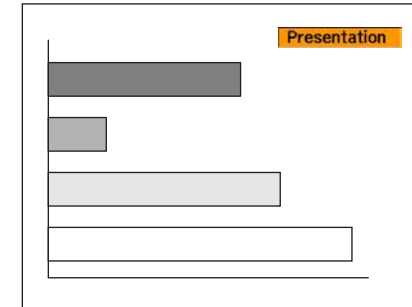
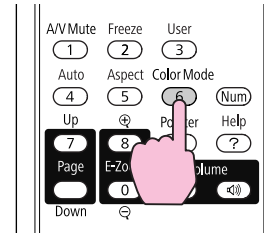

Each time you press the button, the Color Mode name is displayed on the screen and the Color Mode changes.  
If you press the button while the Color Mode name is displayed on the screen, it changes to the next Color Mode.



The color mode can also be set using **Color Mode** in the **Image** menu from the Configuration Menu. [p.49](#)

## Setting the Auto Iris

By automatically setting the luminance according to the brightness of the displayed image, it lets you enjoy deep and rich images.

### Procedure

- 1 Press the [Menu] button and select Image - Auto Iris from the Configuration Menu. ➔ "Using the Configuration Menu" p.48

#### Using the Remote Control

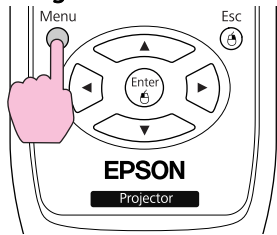

#### Using the Control panel

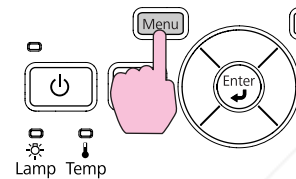

- 2 **Select On.**  
The setting is stored for each Color Mode.

- 3 Press the [Menu] button to close the Configuration Menu.



Auto Iris can be set only when the **Color Mode** is **Dynamic** or **Theatre**.

## Hiding the Image and Sound Temporarily (A/V Mute)

You can use this when you want to focus the audience's attention on what you are saying, or if you do not want to show details such as when you are changing between files during presentations from a computer.

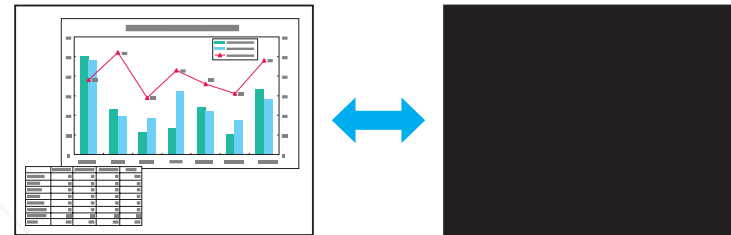

### Procedure

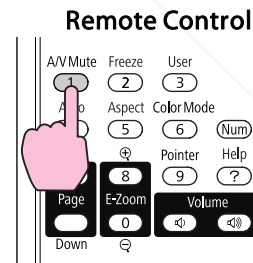

#### Body

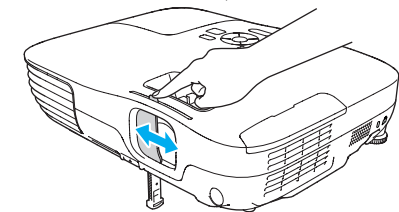

Each time you press the button, or open/close the lens cover A/V Mute turns on or off.



- If you use this function when projecting moving images, the images and sound continue to be played back by the source, and you cannot return to the point where A/V Mute was activated.
- When activated from the remote control, you can choose to display Black, **Blue**, or **Logo** as the **A/V Mute** display using the **Extended - Display - A/V Mute** setting from the Configuration menu. 🗨️ p.53
- When the A/V mute slide is closed, and no operations are made for approximately 30 minutes, Lens Cover Timer activates and the power is automatically turned off. If you do not want Lens Cover Timer to activate, change the **Lens Cover Timer** setting to **Off** from **Operation** in the **Extended** menu. 🗨️ p.53

## Freezing the Image (Freeze)

When Freeze is activated on moving images, the frozen image continues to project on the screen, so you can project a moving image one frame at a time like a still photo. Also, you can perform operations such as changing between files during presentations from a computer without projecting any images if the Freeze function is activated beforehand.

### Procedure

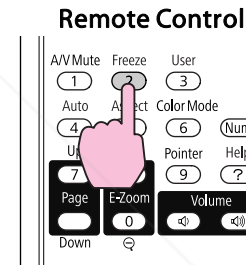

Each time you press the button, Freeze turns on or off.



- Audio does not stop.
- The image source continues to play back the moving images even while the screen is frozen, and so it is not possible to resume projection from the point where it was paused.
- If the [Freeze] button is pressed while the Configuration Menu or a Help screen is displayed, the menu or Help screen being displayed is cleared.
- Freeze still works while E-Zoom is being used.

## Changing the Aspect Ratio

Change the Aspect Ratio when video equipment is connected so that images that have been recorded in digital video or onto DVDs can be viewed in 16:9 wide-screen format. Change the Aspect Ratio when projecting computer images at full size.

The changing methods and the types of Aspect ratio are as follows.

### Changing methods

#### Procedure



Each time you press the button, the Aspect name is displayed on the screen and the Aspect changes.

If you press the button while the Aspect name is displayed on the screen, it changes to the next Aspect Mode.



The aspect ratio can also be set using Aspect in the Signal menu from the Configuration Menu. p.50

## Changing the Aspect for video equipment images

- ④ Zoom
- ⑤ Native

EB-X8/S8/X7/S7

Each time you press the button, it switches between **4:3** and **16:9**.

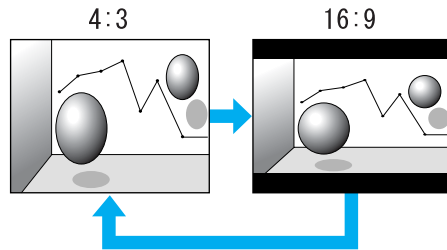

EB-W8/W7

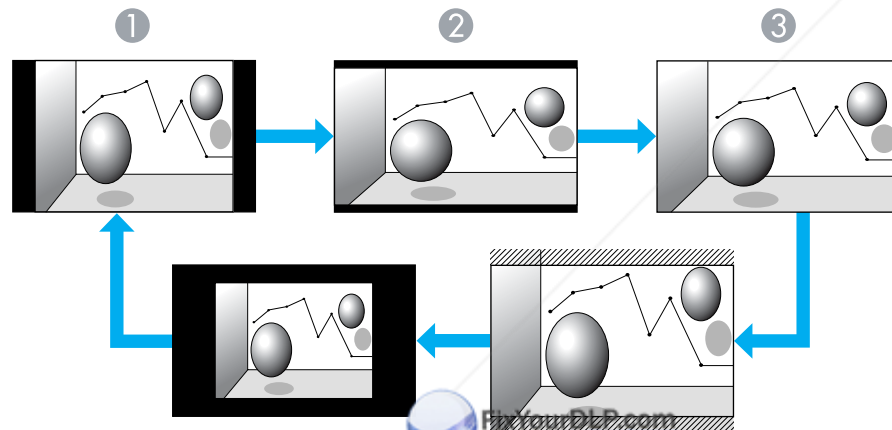

Each time the button is pressed, it changes in the order **Normal**, **16:9**, **Full**, **Zoom**, and **Native**.



- ① Normal
- ② 16:9
- ③ Full

## Changing the aspect for computer images (EB-X8/S8/X7/S7)

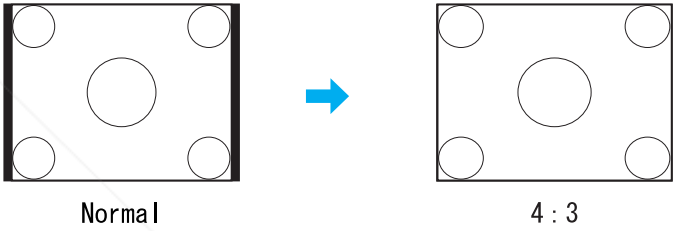
When projecting images from Computer input port or HDMI input port (EB-X8 only), you can change the Aspect as follows.

Set Values	Operation	Projection example
<b>Normal</b> Displayed when the source is a computer.	Projects to the full projection size retaining the Aspect of the input image.	
<b>Auto (EB-X8 only)</b> Displayed only when the source is HDMI.	Projects in an appropriate aspect based on information from the signal being input.	
<b>4:3</b>	Projects to the full projection size at an Aspect of 4:3. This is ideal for when you want to project images at an Aspect of 5:4 (1280 x 1024) to the full projection size.	When a 1280x1024 signal is input 
<b>16:9</b>	Projects at a 16:9 Aspect. This is ideal for projecting at full screen size when using a 16:9 screen.	When a 1280x1024 signal is input 



If parts of the image are missing, set **Wide** or **Normal** in **Resolution** from the Configuration Menu depending on the size of the computer panel.  
 p.50



FixYourDLP.com

Sponsored by DM

**Discount-Merchant.com (800) 281-8860**

**THE TRUSTED SOURCE FOR PROJECTOR LAMPS AND ACCESSORIES**

## Changing the aspect for computer images (EB-W8/W7)

You can change the Aspect as follows. For EB-W8/W7 the projection size is 1280 x 800 dots (aspect ratio 16:10) due to WXGA panel resolution. When projecting onto 16:9 screens, set the Aspect to **16:9**.

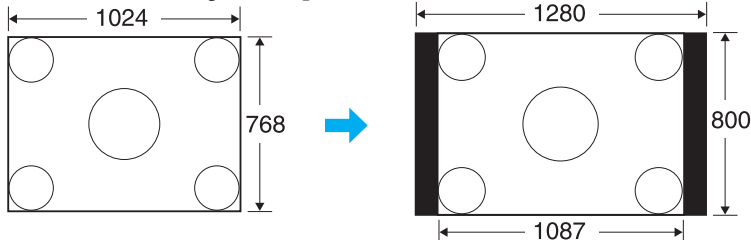
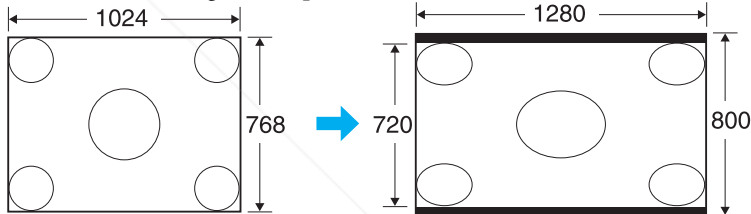
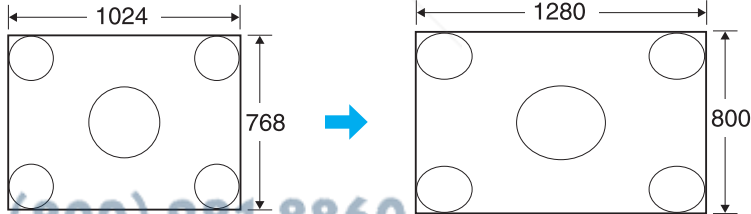
Set Values	Operation	Projection example
<b>Normal</b>	Projects to the full projection size retaining the Aspect of the input image.	When a 1024x768 signal is input 
<b>Auto (EB-W8 only)</b> Displayed only when the source is HDMI.	Projects in an appropriate aspect based on information from the input signal.	
<b>16:9</b>	Projects to the full projection size at an Aspect of 16:9.	When a 1024x768 signal is input 
<b>Full</b>	Project at full size.	When a 1024x768 signal is input 

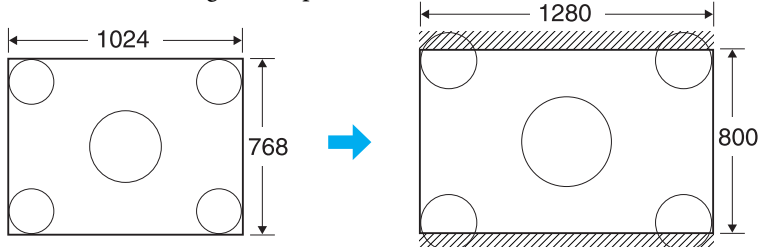
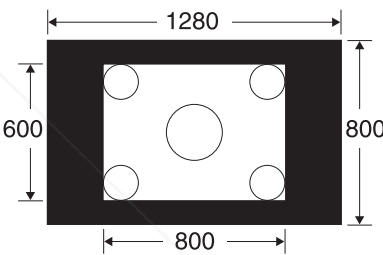
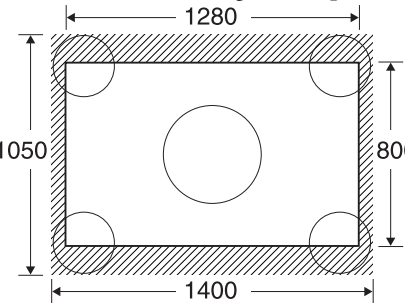
Set Values	Operation	Projection example	
<b>Zoom</b>	Projects the input image at the lateral direction aspect size as it is. Parts that extend beyond the projection size are not projected.	<p>When a 1024x768 signal is input</p> 	
<b>Native</b>	Projects at the resolution of the input image size to the center of the screen. This is ideal for projecting clear images. If the image resolution exceeds 1280x800, the edges of the image are not projected.	<p>When an 800x600 signal is input</p> 	<p>When an 1400x1050 signal is input</p> 



If parts of the image are missing, set **Wide** or **Normal** in **Resolution** from the Configuration Menu depending on the size of the computer panel. [p.50](#)



## Pointer Function (Pointer)

This allows you to move a Pointer icon on the projected image, and helps you draw attention to the area you are talking about.

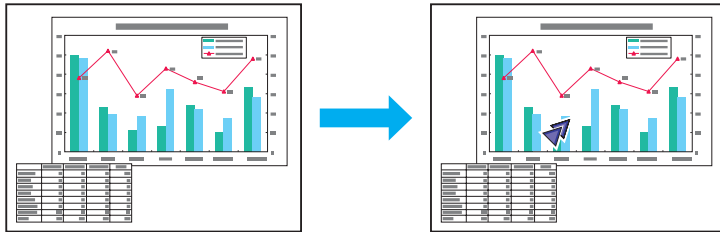

### Procedure

- 1 Display the Pointer.

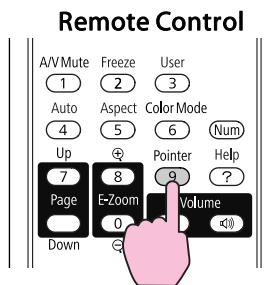

Each time you press the button, the pointer appears or disappears.

- 2 Move the Pointer icon (↗).

### Remote Control

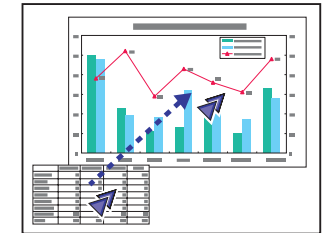
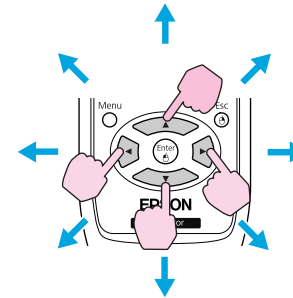

When pressed in conjunction with the adjacent [▲][▼] [◀][▶] buttons, the pointer can be moved diagonally in addition to up/down and left/right.



You can choose from three different kinds of Pointer icon (↗, ✖, or ↘) in **Settings - Pointer Shape** from the Configuration Menu.  
 p.52

## Enlarging Part of the Image (E-Zoom)

This is useful when you want to expand images to see them in greater detail, such as graphs and tables.

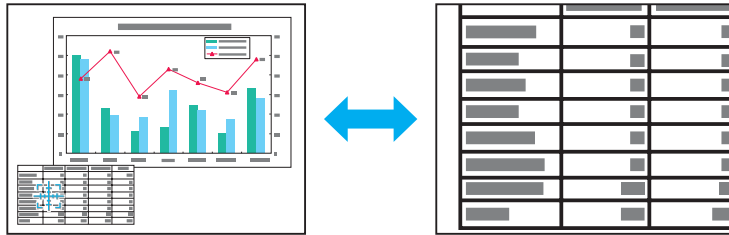

### Procedure

**1 Start E-Zoom.**

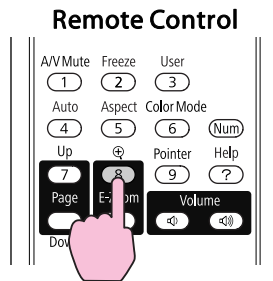

**2 Move the [十字] to the area of the image that you want to enlarge.**

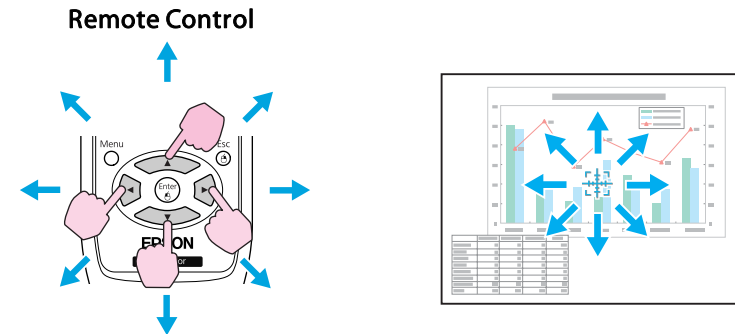

When pressed in conjunction with the adjacent [▲][▼] [◀][▶] buttons, the pointer can be moved diagonally.

**3 Enlarge.**

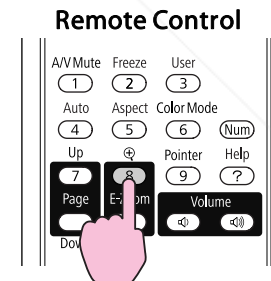





Each time the button is pressed, the area is expanded. You can expand quickly by holding the button down.

You can reduce the enlarged image by pressing the [Q] button.

Press the [Esc] button to cancel.



- The enlargement ratio appears on the screen. The selected area can be enlarged to between 1 to 4 times in 25 incremental steps.
- Press the [  ] [  ] [  ] [  ] buttons to scroll the image.



- You cannot use the Wireless Mouse function and the Page Up/Down function simultaneously.

## Using the Remote Control as a Mouse

When the USB port of a computer and the USB(TypeB) port on the rear of the projector are connected with a USB cable, you can use the projector's Remote Control to control the computer's mouse pointer (Wireless Mouse function) or move the page up/down.

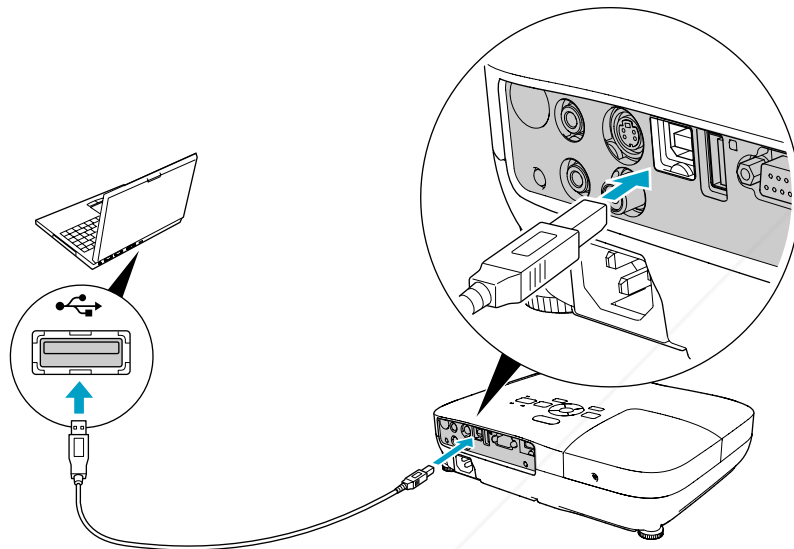

### Compatible OS

Windows: 98/98SE/2000/Me/XP Home Edition/  
XP Professional/Vista Home Basic/Vista Home Premium/  
Vista Business/Vista Enterprise/Vista Ultimate

Macintosh: Mac OS X 10.3 to 10.5

## Wireless Mouse

To activate the Wireless Mouse function, set **USB Type B** to **Wireless Mouse** from **Extended** in the Configuration Menu. By default, **USB Type B** is set to USB Display. Change the setting beforehand. [p.53](#)



- The Wireless Mouse function can be used only when the source is **Computer** or **HDMI** (EB-W8/X8 only). You cannot use this function while projecting in USB Display.
- It may not be possible to use the Wireless Mouse function under some versions of both the Windows and Macintosh operating systems.
- Some computer settings may have to be changed in order for the mouse function to be used. Consult the documentation for the computer for further details.

After the computer and the projector have been connected with a USB cable, the mouse pointer can be operated as follows.

### Moving the mouse pointer

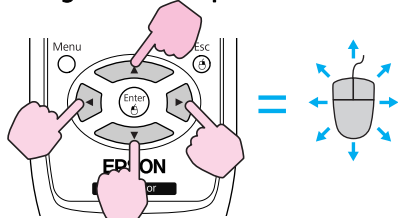

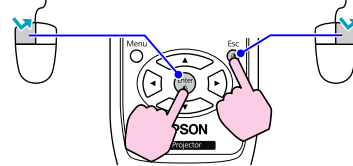

### Mouse clicks



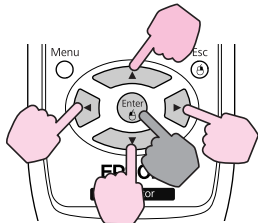

Left click: Press the [Enter] button.  
 Right click: Press the [Esc] button.  
 Double click: Press quickly twice.



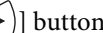
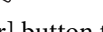

### Drag and drop



: Keep pressed

1. While holding down the [Enter] button, press the [  ] [  ] [  ] [  ] buttons.
2. Release the [Enter] button to drop at the desired location.



- When pressed in conjunction with the adjacent [  ] [  ] [  ] [  ] buttons, the pointer can be moved diagonally.
- If the mouse button settings are set to reverse on the computer, the operation of the Remote Control buttons will also be reversed.
- The Wireless Mouse function cannot be used while the following functions are being used.
  - While the Configuration Menu is being displayed
  - While a Help menu is being displayed
  - While the E-Zoom function is being used
  - While a user's logo is being captured
  - While the Pointer function is being used
  - While adjusting sound volume
  - While USB Display is being operated
  - While a Test Pattern is being displayed
  - While Color Mode is being set
  - While Color Mode name is being displayed
  - While the Source name is being displayed
  - While switching input source

## Page Up/Down

To page up/down with the remote control, set **USB Type B** to **Page Up/Down** from **Extended** in the Configuration Menu. When projecting in USB Display, you can page up/down without changing the setting.

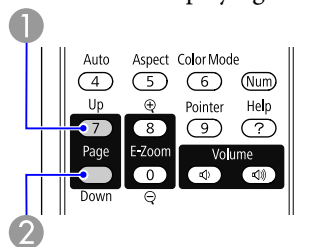

### Example of page up/down operation

This is useful for displaying the previous or next slide in a **PowerPoint** Slideshow.



- 1 To previous slide
- 2 To next slide

The projector has the following enhanced security functions.

- **Password Protect**  
You can limit who can use the projector.
- **Control Panel Lock**  
You can prevent people changing the settings on the projector without permission.  [p.39](#)
- **Anti-Theft Lock**  
The projector is equipped with various types of anti-theft security devices.  [p.40](#)

## 2. User's Logo Protect

Even if someone tries to change the User's Logo set by the owner of the projector, it cannot be changed. When **User's Logo Protect** is set to **On**, the following setting changes for the User's Logo are prohibited.

- Capturing a User's Logo
- Settings for **Display Background**, **Startup Screen**, and **A/V Mute** from **Display** in the Configuration Menu.

## Managing Users (Password Protect)

When Password Protect is activated, people who do not know the Password cannot use the projector to project images even if the projector power is on. Furthermore, the user's logo that is displayed when you turn on the projector cannot be changed. This acts as an anti-theft device as the projector cannot be used even if it is stolen. At the time of purchase, Password Protect is not activated.

### Type of Password Protect

The following two kinds of Password Protect settings can be made according to how the projector is being used.

#### 1. Power On Protect

When **Power On Protect** is **On**, you need to enter a preset Password after the projector is plugged in and turned on (this also applies to Direct Power On). If the correct Password is not entered, projection does not start.

### Setting Password Protect

Use the following procedure to set Password Protect.

#### Procedure



**During projection, hold down the [Freeze] button for about five seconds.**

The Password Protect setting menu is displayed.

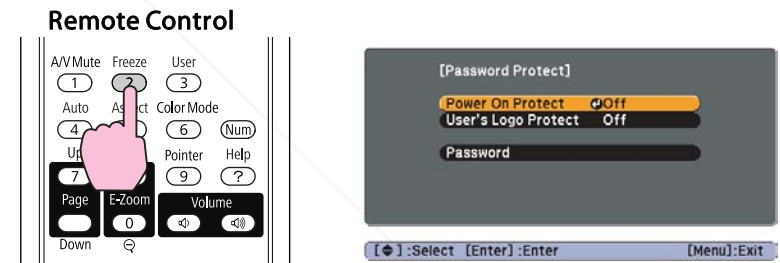

- If Password Protect is already activated, you must enter the Password.
- If the Password is entered correctly, the Password Protect setting menu is displayed.  "Entering the Password" [p.38](#)
- When the Password is set, stick the Password protect sticker in a visible position on the projector as a further theft deterrent.

## 2 Turn on Power On Protect.

- (1) Select **Power On Protect**, and then press the [Enter] button.
- (2) Select **On**, and then press the [Enter] button.
- (3) Press the [Esc] button.

## 3 Turn on User's Logo Protect.

- (1) Select **User's Logo Protect**, and then press the [Enter] button.
- (2) Select **On**, and then press the [Enter] button.
- (3) Press the [Esc] button.

## 4 Set the Password.

- (1) Select **Password**, and then press the [Enter] button.
- (2) The message "**Change the password?**" is displayed, select **Yes** and then press the [Enter] button. The default setting for the Password is "0000". Change this to your own desired Password. If you select **No**, the screen shown in step 1 is displayed again.
- (3) While holding down the [Num] button, enter a four digit number using the numeric buttons. The number entered is displayed as "\* \* \* \*". When you enter the fourth digit, the confirmation screen is displayed.

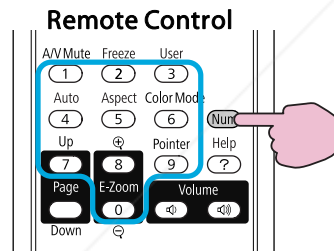

- (4) Re-enter the Password. The message "**Password entered.**" is displayed. If you enter the Password incorrectly, a message is displayed prompting you to re-enter the password.

## Entering the Password



When the Password entry screen is displayed, enter the Password using the numeric buttons on the Remote Control.

### Procedure

**While holding down the [Num] button, enter the Password by pressing the numeric buttons.**

When you enter the correct Password, projection begins.

### Attention

- If an incorrect password is entered three times in succession, the message "**The projector's operation will be locked.**" is displayed for about five minutes, and then the projector switches to standby mode. If this happens, disconnect the power plug from the electrical outlet and then reinsert it and turn the projector's power back on. The projector displays the Password entry screen again so that you can enter the correct Password.
- If you have forgotten the password, make a note of the "**Request Code: xxxxx**" number that appears on the screen and contact the nearest address provided in the Support and Service Guide.  [Epson Projector Contact List](#)
- If you continue to repeat the above operation and input the wrong Password thirty times in succession, the following message is displayed and the projector does not accept any more Password entries. "**The projector's operation will be locked. Contact Epson as described in your documentation.**"  [Epson Projector Contact List](#)

## Restricting Operation (Control Panel Lock)

Perform one of the following to lock the operation buttons on the Control panel.

- Full Lock  
All of the buttons on the Control panel are locked. You cannot perform any operations from the Control panel, including turning the power on or off.
- Partial Lock  
All of the buttons on the Control panel, except for the [⏻] button, are locked.

This is useful at events or shows when you want to deactivate all buttons and only project, or at schools when you want to limit button operation. The projector can still be operated using the Remote Control.

### Procedure

- 1 During projection, press the [Menu] button and select **Settings - Control Panel Lock** from the Configuration Menu.  
☛ "Using the Configuration Menu" p.48

Using the Remote Control

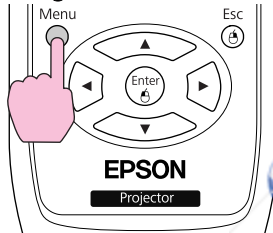

Using the Control panel

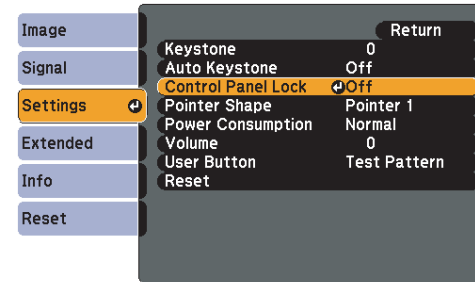
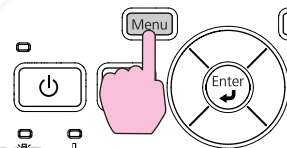

[Esc]:Return [↵]:Select [Enter]:Enter [Menu]:Exit

2

Select either Full Lock or Partial Lock.

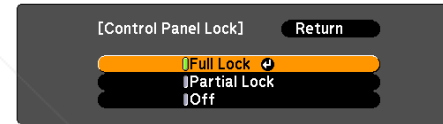

[Esc]:Return [↵]:Select [Enter]:Set [Menu]:Exit

3

Select Yes when the confirmation message is displayed.

The Control panel buttons are locked according to the setting you chose.



You can release the Control panel lock by one of the following two methods.

- From the Remote Control, select **Off** in **Settings - Control Panel Lock** from the Configuration Menu.
- Press and hold down the [Enter] button on the Control panel for about seven seconds, a message is displayed and the lock is released.



### Anti-Theft Lock

As the projector is often setup on ceiling mounts and left in rooms unattended, the projector includes the following security devices to prevent someone from taking the projector.

- Security slot  
The Security slot is compatible with the Microsaver Security System manufactured by Kensington. You can find details about the Microsaver Security System on the Kensington homepage <http://www.Kensington.com/>.
- Security cable installation point  
A commercially available theft-prevention wire lock can be passed through the installation point to secure the projector to a desk or pillar.

### Installing the wire lock

Pass an anti-theft wire lock through the installation point.

See the documentation supplied with the wire lock for locking instructions.

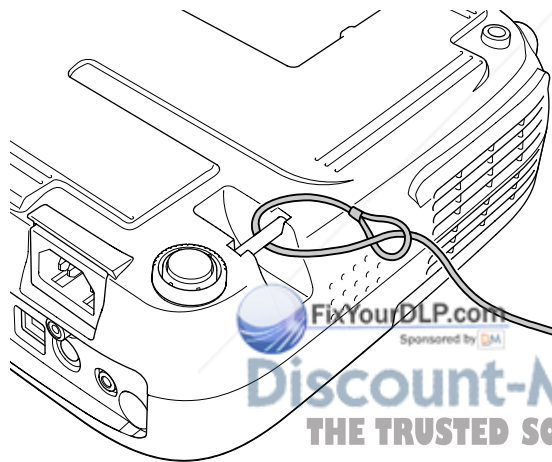

In Slideshow, you can connect a USB storage device or a digital camera to the projector, and directly project the image files saved on the device.



It may not be possible to use USB storage devices with security functions.

## Specifications of Files that can be Projected in a Slideshow

Type	File Type (extension)	Remarks
Still image	.jpg	<p>The following cannot be projected.</p> <ul style="list-style-type: none"> <li>• CMYK color mode format</li> <li>• Progressive format</li> <li>• Resolutions exceeding 8176x6144</li> <li>• Files with extension ".jpeg"</li> </ul> <p>Due to the characteristics of JPEG files, images with high compression ratio may not be projected clearly.</p>



- Use media that have been formatted on Windows, as some file systems may not be supported by the projector.
- Format the media to FAT16 or FAT32.

## Connecting and Removing USB Devices

### Connecting USB devices

Connect the USB device containing the image files to be played back in Slideshow to the projector's USB(TypeA) port. When connecting a digital camera, connect it to the projector using a USB cable provided with, or specified for use with your digital camera.

### Example: Connecting a digital camera

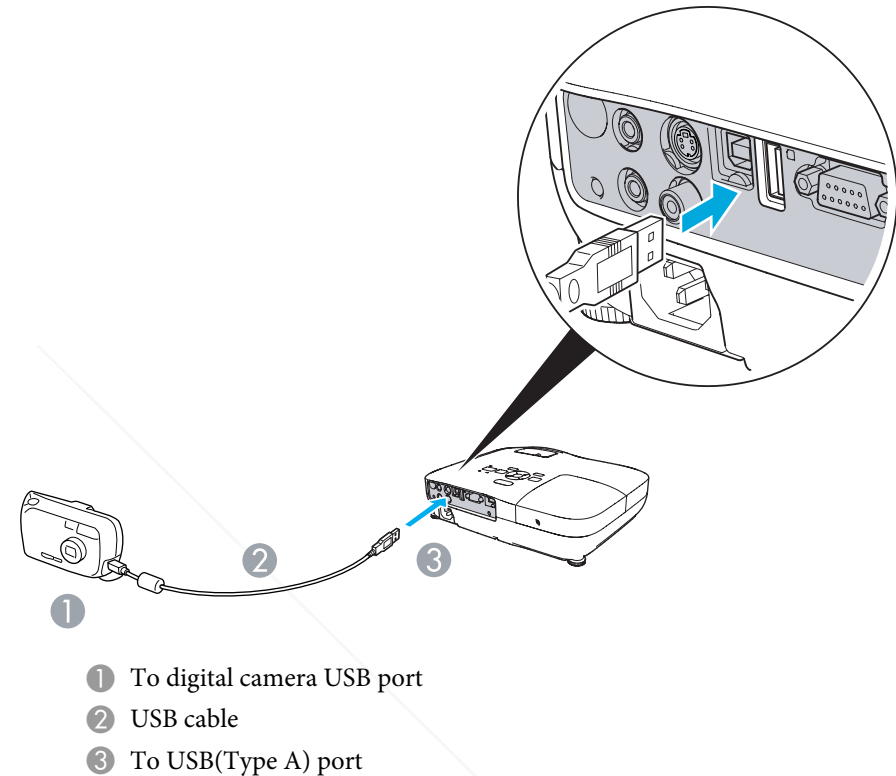

### Attention

- If you use a USB hub, the Slideshow will not function correctly. Devices such as digital cameras and USB storage devices should be connected to the projector directly.
- When connecting and using a USB-compatible hard disk, make sure you connect the AC adaptor supplied with the hard disk.
- Connect a digital camera or hard disk to the projector using a USB cable provided with, or specified for use with the device.
- Use a USB cable less than 3 m in length. If the cable exceeds 3 m, Slideshow may not function correctly.

## Removing USB devices

After finishing projecting, remove the USB device from the projector's USB(TypeA) port.

For digital cameras, hard disks, and so on, turn off the power to the device and then remove.

---

## Starting and Ending a Slideshow

### Starting a slideshow

#### Procedure

- 1 Switch the projected image to USB.  [p.22](#)
- 2 Connect the USB storage device or the digital camera to the projector.  [p.41](#)

The Slideshow starts and displays the file list screen.

### Ending a slideshow

#### Procedure



To end a Slideshow, remove the connected USB device from the projector.

 "Removing USB devices" [p.42](#)



**Discount-Merchant.com (800) 281-8860**  
THE TRUSTED SOURCE FOR PROJECTOR LAMPS AND ACCESSORIES



- You can insert a memory card into a USB card reader and connect it to the projector. However, it may not be possible to use some commercially available USB card readers with the projector.
- If the following screen (Select drive screen) appears, select the drive you want to use by pressing the [][] buttons on the remote control, then press the Enter button.

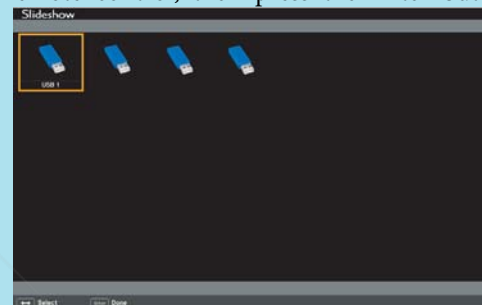

- To display the Select drive screen, set the cursor to Select drive on the top of the file list screen and press the Enter button.
- Up to four drives can be recognized at one time by the projector.

---

## Slideshow Basic Operations

This section explains the procedure for playing back and projecting images in Slideshow.

Although the following steps are explained based on the Remote Control, you can perform the same operations from the projector's Control panel.

#### Procedure

- 1 Press the [][][][] buttons to set the cursor on the file or folder you want to operate.



1 Cursor

- JPEG files are displayed as thumbnails (small images of the files' contents).
- It may not be possible for some JPEG files to be displayed as thumbnails. In this case, an icon of a file is displayed.



If all of the files and folders cannot fit in the current screen, press the [Page] button (Down) on the remote control, or set the cursor to **Next page** on the bottom of the screen, then press the [Enter] button.

To return to the previous screen, press the [Page] button (Up) on the remote control, or set the cursor to **Previous page** on the top of the screen, then press the [Enter] button.

FixYourDLP.com  
Sponsored by DMI

DiscountMerchant.com (800) 281-8860  
THE TRUSTED SOURCE FOR PROJECTOR LAMPS AND ACCESSORIES

2

**Press the [Enter] button.**

The selected image is displayed.

If a folder was selected, the files in the folder are displayed. On the screen showing the contents of the folder, if you select **Back to Top** and press the [Enter] button, the screen prior to opening the folder is displayed again.

## Rotating Images

A JPEG image projected using the Slideshow function can be rotated in 90 degree increments. JPEG images played back in a Slideshow can also be rotated.

Use the following procedure to rotate a JPEG image or JPEG images.

**Procedure**

1

**Start the Slideshow and project a single JPEG image or run a slideshow using more than one JPEG images.**

Projecting a single JPEG image [p.44](#)

Running a Slideshow [p.45](#)

2



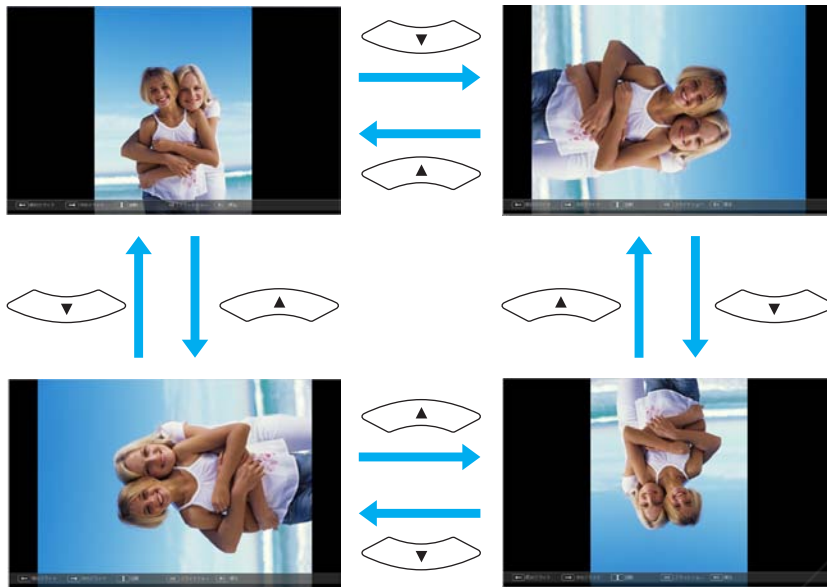

**Once a JPEG image is projected or a slideshow is started, press the [⏪] button or the [⏩] button.**



Although the following steps are explained based on the Remote Control, you can perform the same operations from the projector's Control panel.

## Projecting an image

### Procedure

- 1 Start a Slideshow.  p.42  
The file list screen appears.
- 2 Press the [  ] [  ] [  ] [  ] buttons to set the cursor on the image file you want to project.

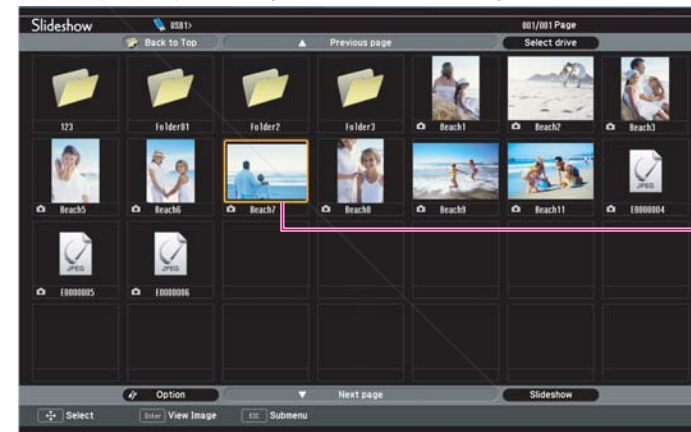

1 Image file

- 3 Press the [Enter] button.  
The image is projected.

## Projecting Image Files

The Slideshow offers you two ways to project image files contained in a USB storage device or a digital camera.



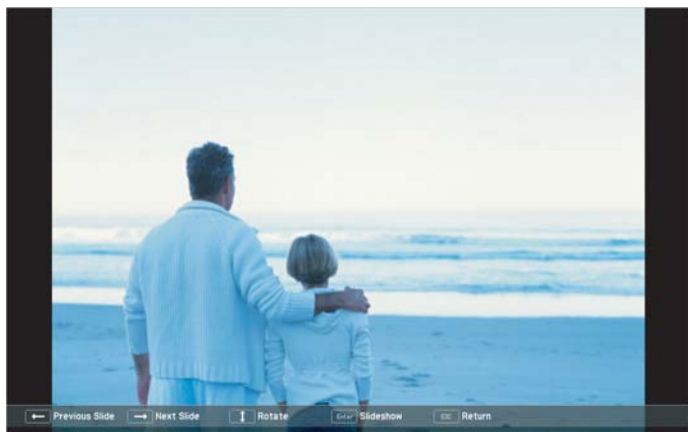

- Projecting the selected single image file  
This function projects the single image file you selected.
- Sequentially projecting image files in a folder (Slideshow)  
This function sequentially plays back image files (runs a slideshow) in the selected folder.  p.45

### Attention

Do not disconnect the USB storage device while it is being accessed. A problem may occur in the Slideshow.



## Procedure

- 1 Start a Slideshow.  p.42  
The file list screen appears.
- 2 Press the [  ] [  ] [  ] [  ] buttons to set the cursor to the folder for which you want to run the Slideshow, then press the [Enter] button.
- 3 Select "Slideshow" on the bottom of the file list screen and press the [Enter] button.

The Slideshow starts, projecting the image files in the folder automatically in sequence, one at a time.

Once the Slideshow reaches the end, the screen automatically returns to the file list screen. If **Continuous Play** is set to **On** in the **Option** screen, once the Slideshow reaches the end, it is repeated from the beginning.  p.45

While projecting a Slideshow, you can go to previous/next screen or cancel playback.

- 4 If you press the [Esc] button, the file list screen is displayed again.

## Sequentially projecting all image files in a folder (Slideshow)

You can project images files in a folder sequentially, one at a time. This function is called Slideshow. Use the following procedure to run a Slideshow.



To change files automatically in the Slideshow, set the **Screen switching time** to any value other than **No** in the **Option** screen. This is set to **No** by default.  p.46







If **Screen switching time** is set to **No** in the **Option** screen, the files will not change automatically after you start the playback of the Slideshow. Press the [Enter] button or the [Page] button (Down) to project the next file.



## Image File Display Setting and Slideshow Operation Setting

You can set the display order of the files and the operation of the Slideshow in the **Option** screen.

### Procedure

**1** Press the [][][][] buttons to set the cursor to the folder for which you want to set the display requirements, then press the [Esc] button. Select "Option" from the displayed sub menu and press the [Enter] button.

**2** Set each item in the following Option screen.





Set the cursor to the setting value of the item you want to change, and press the [Enter] button to make it active.

The following table shows the details of each item.



<b>Display order</b>	Sets the display order of the files. Select from <b>Name order</b> and <b>Date order</b> , in ascending order.
----------------------	--

<b>Continuous Play</b>	Sets whether or not to repeat the Slideshow.
<b>Screen switching time</b>	Sets the display time for each file in a Slideshow playback. Set to any value from <b>No</b> (0) to 60 seconds. When set to <b>No</b> , automatic paging is disabled.
<b>Effect</b>	Sets the screen effect to be used when changing slides.

**3** Press the [][][][] buttons to set the cursor on "OK", then press [Enter].

The settings are applied.

If you do not want to apply the settings, set the cursor to **Cancel** and press the [Enter] button.



# Configuration Menu

This chapter explains how to use the Configuration Menu and its functions.



**Discount-Merchant.com (800) 281-8860**  
**THE TRUSTED SOURCE FOR PROJECTOR LAMPS AND ACCESSORIES**



## 1

Selecting from the top menu

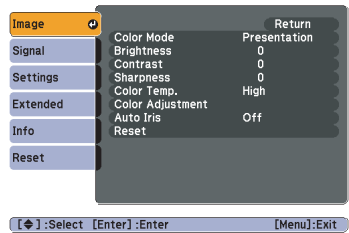

## 2

Selecting from the sub menu

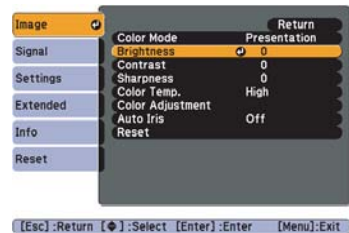

## 3

Changing the selected item



## 4

Exit

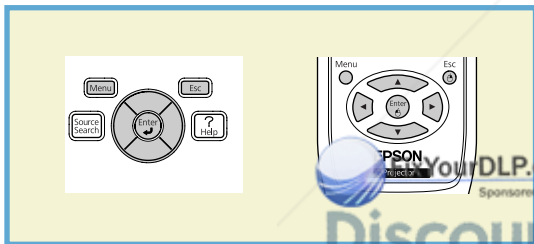
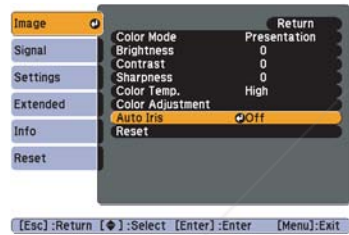
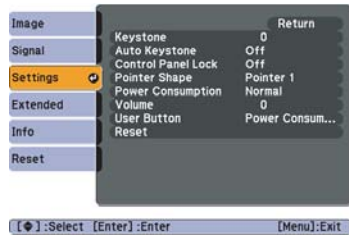

## Image Menu

Items that can be set vary depending on the image signal and Source currently being projected as shown in the following screen shots. Setting details are saved for each image signal.

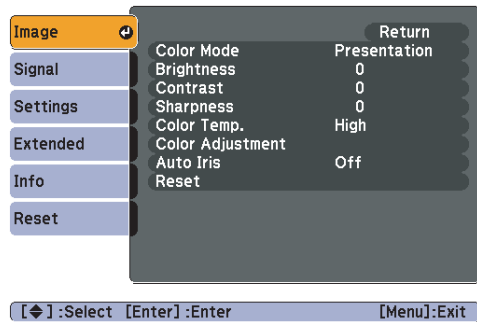

Depending on the model used, some image signals and sources are not supported.  [p.22](#)

**Analog RGB/Digital RGB/RGB Video/  
USB Display/USB**

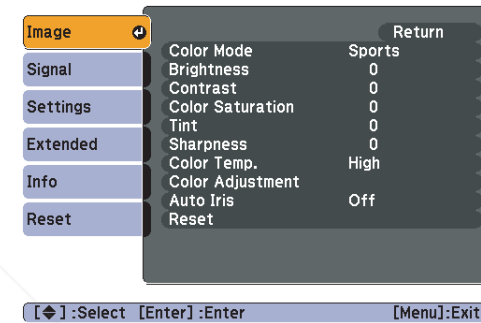

**Component Video▶/Composite video▶/  
S-Video▶▶**



Sub Menu	Function
<b>Color Mode</b>	You can select the quality of the image to suit your surroundings.  <a href="#">p.24</a>
<b>Brightness</b>	You can adjust the image Brightness.
<b>Contrast▶▶</b>	You can adjust the difference between light and shade in the images.
<b>Color Saturation</b>	You can adjust the Color Saturation for the images.
<b>Tint</b>	(Adjustment is only possible when NTSC signals are being input if you use composite video/S-Video.) You can adjust the image Tint.
<b>Sharpness</b>	You can adjust the image sharpness.
<b>Color Temp.</b>	(This item cannot be set when <b>Image - Color Mode</b> is set to <b>sRGB▶▶</b> .) You can adjust the overall tint of the image. When High is selected the image becomes tinged with blue, when Low is selected the image becomes tinged with red.
<b>Color Adjustment</b>	(This item cannot be selected if <b>sRGB▶▶</b> is selected as the <b>Color Mode</b> from the <b>Image</b> menu.) <b>Red, Green, Blue:</b> You can adjust the saturation of each color individually.
<b>Auto Iris</b>	(This item can be selected only if <b>Dynamic</b> or <b>Theatre</b> is selected as the <b>Color Mode</b> from the <b>Image</b> menu.) Set whether or not ( <b>On/Off</b> ) to adjust to the optimum light status for images being projected.  <a href="#">p.25</a>

Sub Menu	Function
Reset	You can reset all adjustment values for the <b>Image</b> menu functions to their default settings. To return all menu items to their default settings, see <a href="#">p.56</a>

## Signal Menu

Items that can be set vary depending on the image signal currently being projected as shown in the following screen shots. Setting details are saved for each image signal.

**Analog RGB**

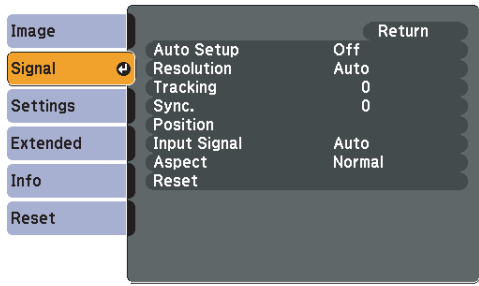

[Left Arrow]:Select [Enter]:Enter [Menu]:Exit

**Digital RGB/RGB Video/  
Component Video\*▶▶  
(EB-W8/X8 only)**

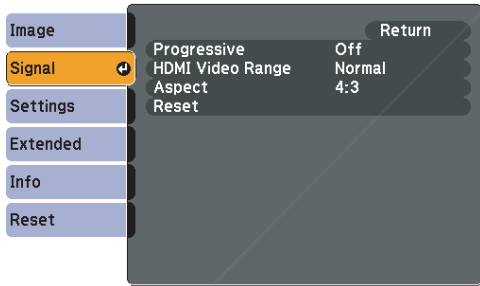

[Left Arrow]:Select [Enter]:Enter [Menu]:Exit

**Component Video▶▶**

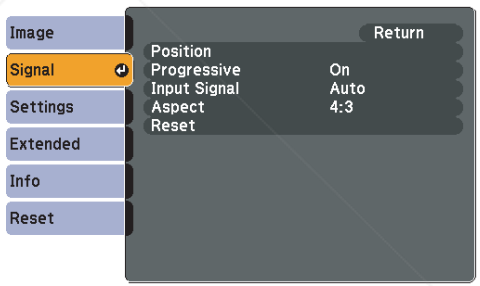

[Left Arrow]:Select [Enter]:Enter [Menu]:Exit

**Composite video▶▶/S-Video▶▶**

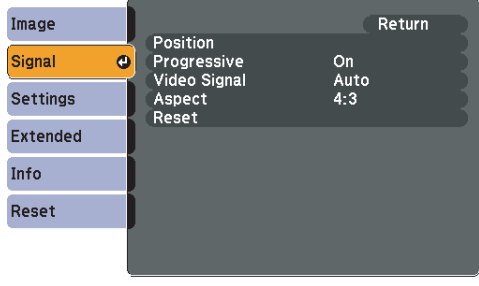

[Left Arrow]:Select [Enter]:Enter [Menu]:Exit





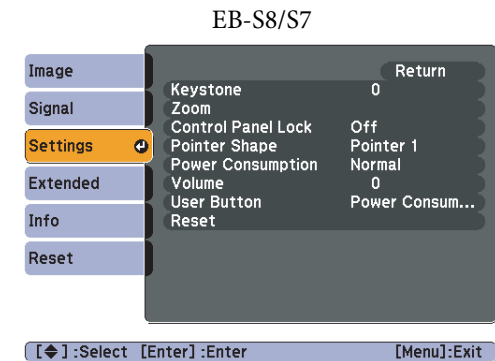
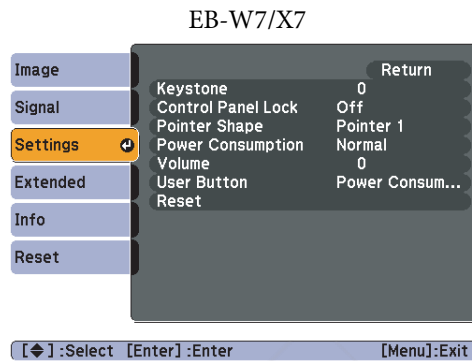
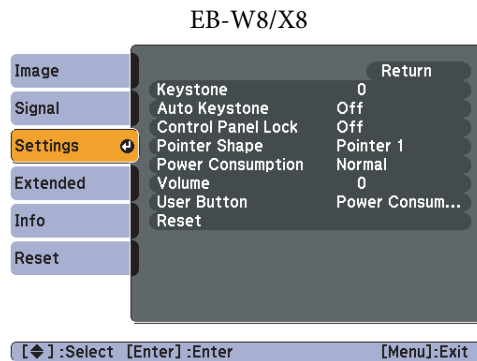

\* When inputting signal from the HDMI input port

Sub Menu	Function
<b>Auto Setup</b>	You can select whether or not ( <b>On/Off</b> ) Auto Setup automatically adjusts the image to the optimum state when the Input Signal changes.
<b>Resolution</b>	When set to <b>Auto</b> , the resolution of the input signal is automatically identified. If the images cannot be projected correctly when set to <b>Auto</b> , such as when some of the image is missing, adjust to <b>Wide</b> depending on the connected computer for wide screens, or set to <b>Normal</b> for 4:3 or 5:4 screens.
<b>Tracking▶▶</b>	You can adjust computer images when vertical stripes appear in the images.
<b>Sync.▶▶</b>	You can adjust computer images when flickering, fuzziness, or interference appear in the images.
<b>Position</b>	You can adjust the display Position up, down, left, and right when a part of the image is missing so that the whole image is projected.

Sub Menu	Function
<b>Progressive</b>	<p>(When component video or RGB video signal is input, this setting can only be adjusted when 480i/576i signals are being input. This cannot be set when a digital RGB signal is input.)</p> <p><b>Off:</b> IP conversion is carried out for each field in the screen. This is ideal for viewing images with a large amount of movement.</p> <p><b>On:</b> <u>Interlace</u> (i) signal is converted to <u>Progressive</u> (p). Applies to still images.</p>
<b>HDMI Video Range (EB-W8/X8 only)</b>	<p>(This cannot be set when a digital RGB signal is input)</p> <p>When the projector's HDMI input port is connected to a DVD player and so on, the projector's video range is set according to the DVD player's video range setting.</p>
<b>Input Signal</b>	<p>You can select input signal from Computer input port.</p> <p>If set to <b>Auto</b> the input signal is set automatically according to the connected equipment.</p> <p>If colors do not appear correctly when set to <b>Auto</b>, select the appropriate signal according to the connected equipment.</p>
<b>Video Signal</b>	<p>You can select input signal from Video input port. If set to <b>Auto</b>, video signals are recognized automatically. If interference appears in the image or a problem occurs such as no image is being projected when set to <b>Auto</b>, select the appropriate signal according to the connected equipment.</p>
<b>Aspect</b>	<p>You can set the <u>Aspect Ratio</u> for projected images. <a href="#">p.27</a></p>
<b>Reset</b>	<p>You can reset all adjustment values on the <b>Signal</b> menu to their default settings, except for <b>Input Signal</b>.</p> <p>To return all menu items to their default settings, see <a href="#">p.56</a></p>

## Settings Menu









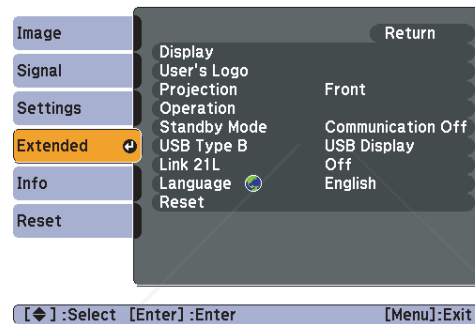

Sub Menu	Function
<b>Keystone</b>	You can correct keystone distortion in the vertical directions.  <a href="#">Quick Start Guide</a>
<b>Auto Keystone</b> (EB-W8/X8 only)	Turn <b>On</b> to perform Auto Keystone. (Auto Keystone is only executed when <b>Front</b> is selected from the <b>Extended - Projection</b> menu.)
<b>Zoom</b> (EB-S8/S7 only)	You can adjust the projection screen size to <b>Wide</b> (Large) or <b>Tele</b> (Small).
<b>Control Panel Lock</b>	You can use this to restrict operation of the projector's Control panel.  <a href="#">p.39</a>
<b>Pointer Shape</b>	You can select the shape of the pointer.  <a href="#">p.32</a> Pointer 1:  Pointer 2:  Pointer 3: 
<b>Power Consumption</b>	You can set the Lamp brightness to one of two settings. Select <b>ECO</b> if the images being projected are too bright such as when projecting images in a dark room or onto a small screen. When <b>ECO</b> is selected, the amount of electricity consumed and the lamp's operating life are changed as follows, and fan rotation noise during projection is reduced. Electrical consumption: about 7 to 19% decrease, lamp life: about 1.3 times longer
<b>Volume</b>	You can adjust the <b>Volume</b> . Setting details are saved for each source.
<b>User Button</b>	You can select the item assigned from the Configuration Menu with the Remote Control's [User] button. By pressing the [User] button the assigned menu item selection/adjustment screen is displayed, allowing you to make one-touch settings/adjustments. You can assign one of the following items to the [User] button. <b>Power Consumption, Info, Progressive, Resolution</b>

Sub Menu	Function
Reset	You can reset all adjustment values on the <b>Settings</b> menu to their default settings, except for <b>User Button</b> . To return all menu items to their default settings, see  <a href="#">p.56</a>

## Extended Menu



Sub Menu	Function
Display	You can make settings related to the projector's display. <b>Messages:</b> When set to <b>Off</b> , the following items will not be displayed. The name of the current selection when changing the <b>Source</b> , <b>Color Mode</b> or <b>Aspect</b> ; a message when no image signal is input; warnings such as the High Temp Warning. <b>Display Background</b> <sup>*1</sup> : You can set the screen status for when no image signal is available to <b>Black</b> , <b>Blue</b> , or <b>Logo</b> . <b>Startup Screen</b> <sup>*1</sup> : You can set whether or not ( <b>On/Off</b> ) the Startup Screen (the image projected when starting the projector) is displayed. <b>A/V Mute</b> <sup>*1</sup> : You can set the screen displayed during A/V Mute as <b>Black</b> , <b>Blue</b> , or <b>Logo</b> .
User's Logo <sup>*1</sup>	You can change the User's Logo that is displayed as a background during Display Background, A/V Mute, and so on.  <a href="#">p.80</a>
Projection	You can set from the following according to the way the projector is setup.  <a href="#">p.70</a> Front ↔ Front/Ceiling, Rear ↔ Rear/Ceiling You can change the setting as follows by pressing down the [A/V Mute] button on the Remote Control for about five seconds. Front ↔ Front/Ceiling Rear ↔ Rear/Ceiling

Sub Menu	Function
<b>Operation</b>	<p><b>Direct Power On:</b> You can set whether or not (<b>On/Off</b>) to enable Direct Power On. When it is set to <b>On</b> and the power cable is plugged in, be aware that the projector turns on automatically in case such as a power outage is restored.</p> <p><b>Sleep Mode:</b> When set to <b>On</b>, this automatically stops projection when no image signal is being input and no operations are carried out.</p> <p><b>Sleep Mode Timer:</b> When <b>Sleep Mode</b> is set to <b>On</b>, you can set the time before the projector automatically turns off within a range of one to 30 minutes.</p> <p><b>Lens Cover Timer:</b> When set to <b>On</b>, this turns off the power automatically 30 minutes after the A/V mute slide is closed. <b>Lens Cover Timer</b> is set to <b>On</b> at the time of purchase.</p> <p><b>High Altitude Mode:</b> Set to <b>On</b> when using the projector above an altitude of 1500 m.</p>
<b>Standby Mode</b>	<p>Set to <b>Communication On</b> when the projector's status is to be monitored and controlled from the computer via USB communication, even when the projector is in standby mode.   <a href="#">p.87</a></p>
<b>USB Type B</b>	<p>Set to <b>USB Display</b> when the projector and a computer are connected by a USB cable and computer images are projected.   <a href="#">Quick Start Guide</a></p> <p>Set to <b>Wireless Mouse</b> when the mouse pointer is to be operated by the Remote Control.  <a href="#">p.34</a></p> <p>Set to <b>Page Up/Down</b> when paging operation is to be performed with the Remote Control.  <a href="#">p.36</a></p>
<b>Link 21L</b>	<p>Set to <b>On</b> when the projector's status is to be monitored and controlled from the computer via USB communication.  <a href="#">p.87</a></p>
<b>Language</b>	<p>You can set the language for message displays.</p>
<b>Reset</b>	<p>You can reset <b>Display</b><sup>*1</sup> and <b>Operation</b><sup>*2</sup> from the <b>Extended</b> menu to their default settings.  To return all menu items to their default settings, see  <a href="#">p.56</a></p>

\*1 When **User's Logo Protect** is set to **On** in **Password Protect**, settings relating to User's Logo cannot be changed. You can make changes after setting **User's Logo Protect** to **Off**.  [p.37](#)

\*2 Except for **High Altitude Mode**.

## Info Menu (Display Only)

Lets you check the status of the image signals being projected and the status of the projector. Items that can be displayed vary depending on the image signal and Source currently being projected as shown in the following screen shots. Depending on the model used, some image signals and sources are not supported. [p.22](#)

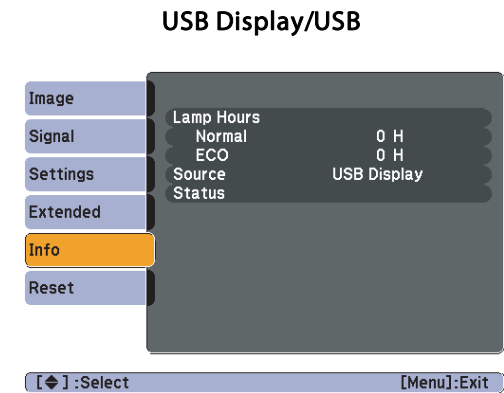
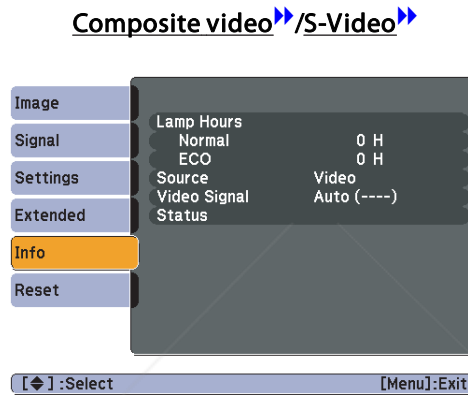
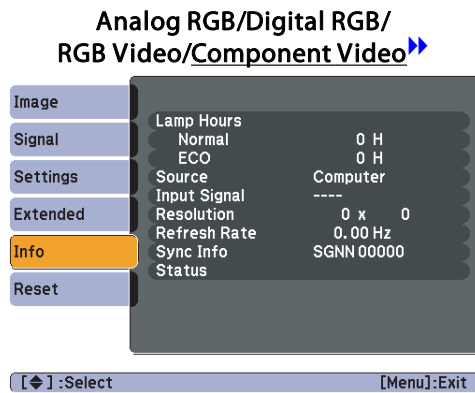

Sub Menu	Function
<b>Lamp Hours</b>	You can display the cumulative Lamp operating time*. When it reaches the lamp warning time, the characters are displayed in yellow.
<b>Source</b>	You can display the Source name for the connected equipment currently being projected.
<b>Input Signal</b>	You can display the content of <b>Input Signal</b> set in the <b>Signal</b> menu according to the Source.
<b>Resolution</b>	You can display the input resolution.
<b>Video Signal</b>	You can display the content of <b>Video Signal</b> set in the <b>Signal</b> menu.
<b>Refresh Rate</b>	You can display the Refresh Rate.
<b>Sync Info</b>	You can display the image signal information. This information may be needed if service is required.
<b>Status</b>	This is information about errors that have occurred on the projector. This information may be needed if service is required.

\* The cumulative use time is displayed as "0H" for the first 10 hours. 10 hours and above is displayed as "10H", "11H", and so on.



## Reset Menu

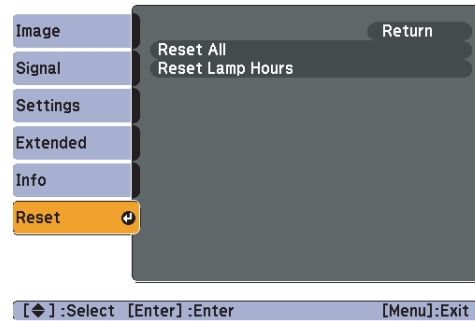

Sub Menu	Function
<b>Reset All</b>	You can reset all items in the Configuration Menu to their default settings. The following items are not reset to their defaults: <b>Input Signal</b> , <b>User's Logo</b> , <b>Lamp Hours</b> , and <b>Language</b> .
<b>Reset Lamp Hours</b>	You can clear the cumulative Lamp Hours use time, and return it to "0H". Reset when you replace the Lamp.



# Troubleshooting

This chapter explains how to identify problems and what to do if a problem is found.



**Discount-Merchant.com (800) 281-8860**  
**THE TRUSTED SOURCE FOR PROJECTOR LAMPS AND ACCESSORIES**

If a problem occurs with the projector, the Help screen is displayed to assist you by pressing the [Help] button. You can solve problems by answering the questions.

## Procedure

### 1 Press the [Help] button.

The Help screen is displayed.

#### Using the Remote Control

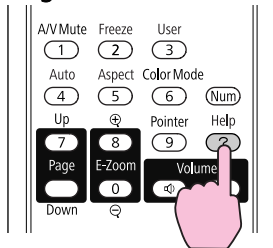

#### Using the Control panel

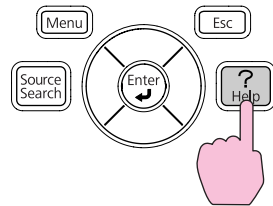

### 2 Select a menu item.

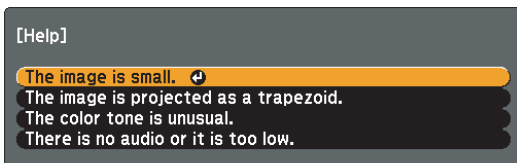

[Left Arrow] :Select [Enter] :Enter [Help] :Exit

#### Using the Remote Control

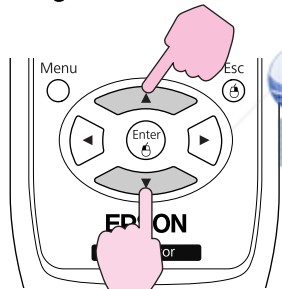

#### Using the Control panel

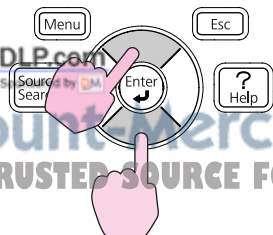

### 3 Confirm the selection.

#### Using the Remote Control

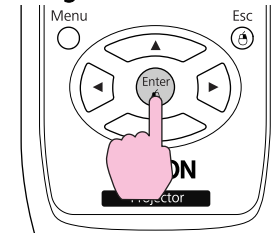

#### Using the Control panel

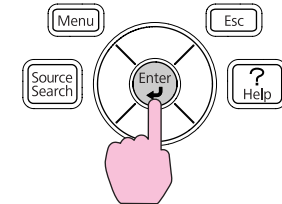

Questions and solutions are displayed as shown on the screen below.

Press the [Help] button to exit Help.

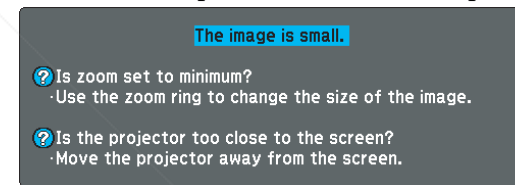

[Esc] :Return [Help] :Exit

 If the Help screen does not provide a solution to the problem, refer to "Problem Solving" p.59.

If you are having a problem with the projector, first check the projector's indicators and refer to "Reading the Indicators" below.

If the indicators do not show clearly what the problem might be, refer to "When the Indicators Provide No Help". [p.62](#)

## Reading the Indicators

The projector is provided with the following three indicators that indicate the operating status of the projector.

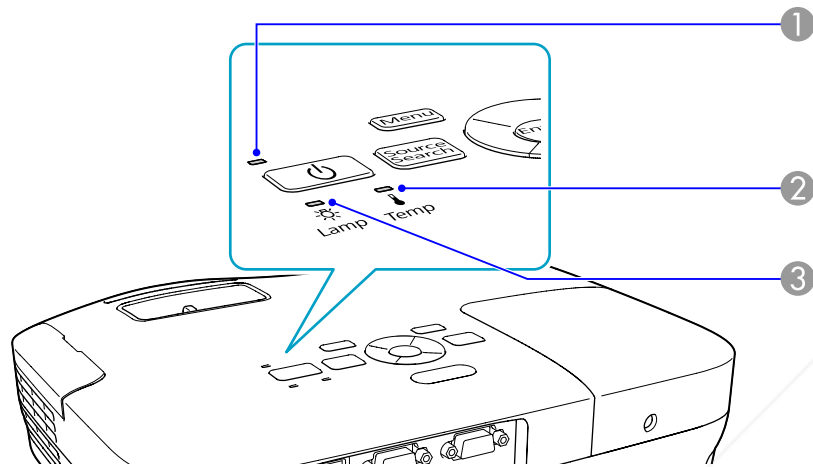

① Indicates the operating status.



Standby condition

When the [⏻] button is pressed in this condition, projection starts.



Preparing monitoring via USB communication or cool down in progress

All buttons are disabled while the indicator is flashing.



Warming up

Warm-up time is about 30 seconds. After warm-up is complete, the indicator stops flashing.

The [⏻] button is disabled during warm-up.

Projecting

② Indicates the internal temperature status.

③ Indicates the projection lamp status.



FixYourDLP.com

Sponsored by

**Discount-Merchant.com (800) 281-8860**

**THE TRUSTED SOURCE FOR PROJECTOR LAMPS AND ACCESSORIES**



























Refer to the following table to see what the indicators mean and how to remedy problems that they indicate.

If all indicators are off, check that the power cable is connected correctly and that the power is being supplied normally.

Sometimes, when the power cable is unplugged, the  indicator remains lit for a short period, but this is not a fault.



## Indicator is lit or flashing red

 : Lit  : Flashing  : Off

Status	Cause	Remedy or Status
  	Internal Error	Stop using the projector, disconnect the power cable from the electrical outlet, and contact your local dealer or the nearest address provided in the Support and Service Guide.  <a href="#">Epson Projector Contact List</a>
  	Fan Error Sensor Error	Stop using the projector, disconnect the power cable from the electrical outlet, and contact your local dealer or the nearest address provided in the Support and Service Guide.  <a href="#">Epson Projector Contact List</a>
  	High Temp Error (overheating)	<p>The lamp turns off automatically and projection stops. Wait for about five minutes. After about five minutes the projector switches to standby mode, so check the following two points.</p> <ul style="list-style-type: none"> <li>• Check that the air filter and Air exhaust vent are clear, and that the projector is not positioned against a wall.</li> <li>• If the air filter is clogged, clean or replace it.  <a href="#">p.72, p.77</a></li> </ul> <p>If the error continues after checking the points above, stop using the projector, disconnect the power cable from the electrical outlet, and contact your local dealer or the nearest address provided in the Support and Service Guide.  <a href="#">Epson Projector Contact List</a></p> <p>When using at an altitude of 1500 m or more, set <b>High Altitude Mode to On.</b>  <a href="#">p.53</a></p>
  	Lamp Error Lamp Failure	<p>Check the following two points.</p> <ul style="list-style-type: none"> <li>• Take out the lamp and check if it is cracked.  <a href="#">p.74</a></li> <li>• Clean the air filter.  <a href="#">p.72</a></li> </ul> <p><b>If it is not cracked:</b> Re-fit the Lamp and turn on the power.</p> <p><b>If the error continues:</b> Replace the Lamp with a new lamp and turn on the power.</p> <p><b>If the error continues:</b> Stop using the projector, disconnect the power cable from the electrical outlet, and contact your local dealer or the nearest address provided in the Support and Service Guide.  <a href="#">Epson Projector Contact List</a></p> <p><b>If it is cracked:</b> Replace it with a new lamp, or contact your local dealer for further advice. If replacing the lamp yourself, be careful to avoid pieces of broken glass (you cannot continue projecting until the lamp is replaced).  <a href="#">Epson Projector Contact List</a></p> <p>When using at an altitude of 1500 m or more, set <b>High Altitude Mode to On.</b>  <a href="#">p.53</a></p>
  	Auto Iris Error Power Err. (Ballast)	Stop using the projector, disconnect the power cable from the electrical outlet, and contact your local dealer or the nearest address provided in the Support and Service Guide.  <a href="#">Epson Projector Contact List</a>

## ⚙️ **Indicator is lit or flashing orange**

■ : Lit 
 ■ (with red lines) : Flashing 
  : Off 
  : Varies according to the projector status

Status	Cause	Remedy or Status
	High Temp Warning	(This is not an abnormality. However, if the temperature rises too high again, projection stops automatically.) <ul style="list-style-type: none"> <li>• Check that the air filter and Air exhaust vent are clear, and that the projector is not positioned against a wall.</li> <li>• If the air filter is clogged, clean or replace it. <a href="#">p.72</a>, <a href="#">p.77</a></li> </ul>
	Replace Lamp	Replace it with a new Lamp. <a href="#">p.74</a> If you continue to use the Lamp after the replacement period has passed, the possibility that the lamp may explode increases. Replace it with a new Lamp as soon as possible.



- If the projector is not operating properly, even though the indicators are all showing normal, refer to "When the Indicators Provide No Help" [p.62](#).
- If the error is not indicated in this table, stop using the projector, disconnect the power cable from the electrical outlet, and contact your local dealer or the nearest address provided in the Support and Service Guide. [Epson Projector Contact List](#)

## When the Indicators Provide No Help

If any of the following problems occur and the indicators do not offer a solution, refer to the pages given for each problem.

### Problems relating to images

- "No images appear" 🖱️ p.63  
Projection does not start, the projection area is completely black, the projection area is completely blue, and so on.
- "Moving images are not displayed" 🖱️ p.63  
Moving images being projected from a computer appear black and nothing is projected.
- "Projection stops automatically" 🖱️ p.63
- "The message "Not Supported." is displayed." 🖱️ p.64
- "The message "No Signal." is displayed." 🖱️ p.64
- "Images are fuzzy or out of focus" 🖱️ p.64
- "Interference or distortion appear in images" 🖱️ p.65  
Problems such as interference, distortion, or black & white checked patterns appear.
- "The image is truncated (large) or small, or the aspect is not suitable" 🖱️ p.65  
Only part of the image is displayed, or the height and width ratios of the image are not correct, and so on.
- "Image colors are not right" 🖱️ p.66  
The whole image appears purplish or greenish, images are black & white, colors appear dull, and so on... (Computer monitors and LCD screens have different color reproduction performance, so that the colors projected by the projector and the colors appearing on the monitor may not necessarily match, but this is not a sign of a problem.)
- "Images appear dark" 🖱️ p.66

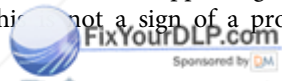

### Other problems





- "No sound can be heard or the sound is faint" 🖱️ p.67
- "The Remote Control does not work" 🖱️ p.67
- "I want to change the language for messages and menus" 🖱️ p.68

### Problems when projection starts

- "The projector does not turn on" 🖱️ p.67

## Problems relating to images

No images appear

Check	Remedy
Did you press the [⏻] button?	Press the [⏻] button to turn the power on.
Are the indicators switched off?	The power cable is not connected correctly or power is not being supplied normally. Connect the projector's power cable correctly.  <a href="#">Quick Start Guide</a> Check that your electrical outlet or power source is functioning correctly.
Is A/V Mute active?	Press the [A/V Mute] button on the Remote Control to cancel A/V Mute.  <a href="#">p.25</a>
Is the A/V mute slide closed?	Open the A/V mute slide.  <a href="#">p.9</a>
Are the Configuration Menu settings correct?	Reset all of the settings.  <a href="#">Reset Menu - Reset All p.56</a>
Is the projected image completely black? <b>Only when projecting computer images</b>	Some input images, such as screen savers, may be completely black.
Is the image signal format setting correct? <b>Only when projecting images from a video source</b>	Change the setting according to the signal for the connected equipment.  <a href="#">Signal Menu - Video Signal p.50</a>

Moving images are not displayed

Check	Remedy
Is the computer's image signal being output to the LCD and the monitor? <b>Only when projecting images from a laptop computer or a computer with a built-in LCD screen</b>	Change the image signal to external output only.  Check your computer's documentation.

Projection stops automatically



Check	Remedy
Is <b>Sleep Mode</b> set to <b>On</b> ?	Press the [⏻] button to turn the power on. If you do not want to use Sleep Mode, change the setting to <b>Off</b> .  <a href="#">Extended Menu - Operation - Sleep Mode p.53</a>

Discount-Merchant.com (800) 981-8860

THE TRUSTED SOURCE FOR PROJECTOR LAMP AND ACCESSORIES



The message "Not Supported." is displayed.

Check	Remedy
Is the image signal format setting correct? <b>Only when projecting images from a video source</b>	Change the setting according to the signal for the connected equipment. 🖱️ <a href="#">Signal Menu - Video Signal p.50</a>
Do the image signal Resolution and the Refresh Rate correspond to the mode? <b>Only when projecting computer images</b>	Refer to the computer's documentation for how to change the image signal Resolution and the Refresh Rate output from the computer. 🖱️ <a href="#">"Supported Monitor Displays" p.88</a>

The message "No Signal." is displayed.

Check	Remedy
Are the cables connected correctly?	Check that all the cables required for projection are securely connected. 🖱️ <a href="#">Quick Start Guide</a>
Is the correct input port selected?	Change the image by pressing the [Source Search] button on the Remote Control or the Control panel. 🖱️ <a href="#">p.22</a>
Is the power for the computer or video source turned on?	Turn the power on for the equipment.
Are the image signals being output to the projector? <b>Only when projecting images from a laptop computer or a computer with a built-in LCD screen</b>	If the image signals are only being output to the computer's LCD monitor or to the accessory monitor, you need to change the output to an external destination as well as the computer's own monitor. For some computer models, when the image signals are output externally, they no longer appear on the LCD monitor or accessory monitor. 🖱️ Computer's documentation, under a title such as "External output" or "Connecting an external monitor". If the connection is made while the power of the projector or computer is already turned on, the function [Fn] key that changes the computer's image signal to external output may not work. Turn the power for the computer and the projector off and then back on again.

Images are fuzzy or out of focus

Check	Remedy
Is the focus adjusted correctly?	Turn the focus ring to adjust the Focus. 🖱️ <a href="#">Quick Start Guide</a>
Is the projector at the correct distance?	Is it projecting outside of the recommended projection distance range? Setup within the recommended range. 🖱️ <a href="#">p.82</a>
Is the Keystone adjustment value too large?	Lower the projection angle to reduce the amount of keystone correction. 🖱️ <a href="#">Quick Start Guide</a>

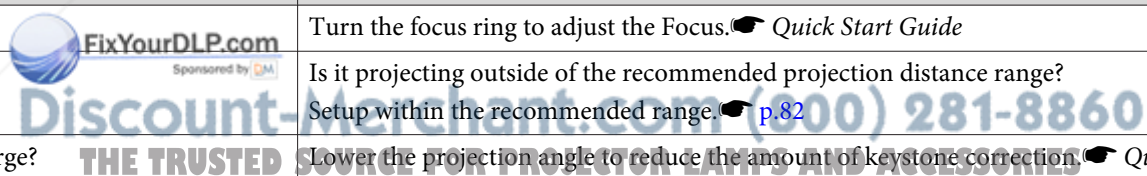

Check	Remedy
Has condensation formed on the lens?	If the projector is suddenly taken from a cold environment to a warm environment, or if sudden ambient temperature changes occur, condensation may form on the surface of the lens, and this may cause the images to appear fuzzy. Set the projector up in the room about one hour before it is used. If condensation forms on the lens, turn the projector off and wait for the condensation to disappear.

## Interference or distortion appear in images

Check	Remedy
Is the image signal format setting correct? <b>Only when projecting images from a video source</b>	Change the setting according to the signal for the connected equipment. 🖱️ <a href="#">Signal Menu - Video Signal p.50</a>
Are the cables connected correctly?	Check that all the cables required for projection are securely connected. 🖱️ <a href="#">Quick Start Guide</a>
Is an extension cable being used?	If an extension cable is used, electrical interference may affect the signals. Use the cables supplied with the projector to check if the cables you are using may be causing the problem.
Is the correct resolution selected? <b>Only when projecting computer images</b>	Set the computer so that the signals being output are compatible with the projector. 🖱️ <a href="#">"Supported Monitor Displays" p.88</a> 🖱️ <a href="#">Computer documentation</a>
Are the "Sync.▶▶" and "Tracking▶▶" settings adjusted correctly? <b>Only when projecting computer images</b>	Press the [Auto] button on the Remote Control or the [Enter] button on the Control panel to perform automatic adjustment. If the images are not adjusted correctly after using automatic adjustment, you can make the adjustments using <b>Sync.</b> and <b>Tracking</b> from the Configuration Menu. 🖱️ <a href="#">Signal Menu - Tracking, Sync. p.50</a>

## The image is truncated (large) or small, or the aspect is not suitable

Check	Remedy
Is a wide panel computer image being projected? <b>Only when projecting computer images</b>	Change the setting according to the signal for the connected equipment. 🖱️ <a href="#">Signal Menu - Resolution p.50</a>
Is the image still being enlarged by E-Zoom?	Press the [Esc] button on the Remote Control to cancel E-Zoom. 🖱️ <a href="#">p.33</a>
Is Position adjusted correctly?	Press the [Auto] button on the Remote Control or the [Enter] button on the Control panel to perform automatic adjustment of the computer image being projected. If the images are not adjusted correctly after using automatic adjustment, you can make the adjustments using <b>Position</b> from the Configuration Menu. Apart from computer image signals, you can adjust other signals while projecting by adjusting <b>Position</b> from the Configuration Menu. 🖱️ <a href="#">Signal Menu - Position p.50</a>

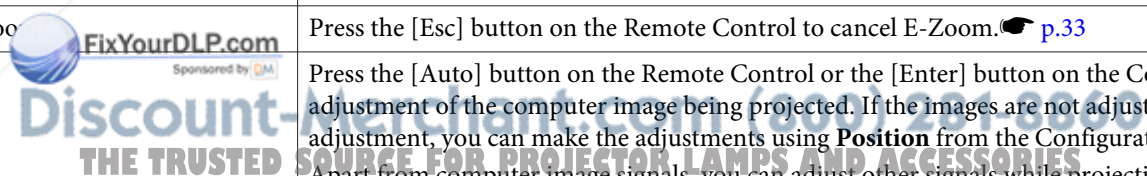

Check	Remedy
Is the computer set for dual display? <b>Only when projecting computer images</b>	If dual display is activated in the "Display Properties" of the computer's Control Panel, only about half of the image on the computer screen is projected. To display the entire image on the computer screen, turn off the dual display setting. 🖱️ Computer video driver documentation
Is the correct resolution selected? <b>Only when projecting computer images</b>	Set the computer so that the signals being output are compatible with the projector. 🖱️ "Supported Monitor Displays" p.88 🖱️ Computer documentation

## Image colors are not right



Check	Remedy
Do the input signal settings match the signals from the connected device?	Change the following settings according to the signal for the connected equipment. When image is from a device connected to the Computer input port 🖱️ <b>Signal Menu - Input Signal p.50</b> When image is from a device connected to the Video or S-Video input port 🖱️ <b>Signal Menu - Video Signal p.50</b>
Is the image Brightness adjusted correctly?	Adjust the <b>Brightness</b> setting from the Configuration Menu. 🖱️ <b>Image menu - Brightness p.49</b>
Are the cables connected correctly?	Check that all the cables required for projection are securely connected. 🖱️ <i>Quick Start Guide</i>
Is <u>Contrast</u> 🖱️ adjusted correctly?	Adjust the <b>Contrast</b> setting from the Configuration Menu. 🖱️ <b>Image Menu - Contrast p.49</b>
Is the Color Adjustment set correctly?	Adjust the <b>Color Adjustment</b> setting from the Configuration Menu. 🖱️ <b>Image Menu - Color Adjustment p.49</b>
Are the Color Saturation and Tint adjusted correctly? <b>Only when projecting images from a video source</b>	Adjust the <b>Color Saturation</b> and <b>Tint</b> settings from the Configuration Menu. 🖱️ <b>Image Menu - Color Saturation, Tint p.49</b>

## Images appear dark

Check	Remedy
Are the image brightness and luminance adjusted correctly?	Adjust the <b>Brightness</b> and <b>Brightness Control</b> settings from the Configuration Menu. 🖱️ <b>Image menu - Brightness p.49</b> 🖱️ <b>Settings menu - Brightness Control p.52</b>
Is <u>Contrast</u> 🖱️ adjusted correctly?	Adjust the <b>Contrast</b> setting from the Configuration Menu. 🖱️ <b>Image Menu - Contrast p.49</b>
Is it time to replace the Lamp?	When the time approaches to replace the Lamp, the images become darker and the color quality becomes poorer. When this happens, replace the Lamp with a new lamp. 🖱️ <b>p.74</b>



## Problems when projection starts

The projector does not turn on

Check	Remedy
Did you press the [⏻] button?	Press the [⏻] button to turn the power on.
Are the indicators switched off?	The power cable is not connected correctly or power is not being supplied normally. Disconnect and then reconnect the power cable.  <a href="#">Quick Start Guide</a> Check that your electrical outlet or power source is functioning correctly.
Do the indicators turn on and off when the power cable is touched?	There is probably a poor contact in the power cable, or the power cable may be defective. Reinsert the power cable. If this does not solve the problem, stop using the projector, disconnect the power cable from the electrical outlet, and contact your local dealer or the nearest address provided in the Support and Service Guide.  <a href="#">Epson Projector Contact List</a>
Is the <b>Control Panel Lock</b> set to <b>Full Lock</b> ?	Press the [⏻] button on the Remote Control. If you do not want to use <b>Control Panel Lock</b> , change the setting to <b>Off</b> .  <a href="#">Settings Menu - Control Panel Lock p.39</a>



## Other problems

No sound can be heard or the sound is faint

Check	Remedy
Is the audio source connected correctly?	Disconnect the cable from the Audio port, and then reconnect the cable.
Is the volume adjusted to the minimum setting?	Adjust the volume so that sound can be heard.  <a href="#">p.52</a>  <a href="#">Quick Start Guide</a>
Is A/V Mute active?	Press the [A/V Mute] button on the Remote Control to cancel A/V Mute.  <a href="#">p.25</a>
Is the audio cable's specification "No resistance"?	When using a commercially available audio cable, make sure it is labeled "No resistance".

The Remote Control does not work

Check	Remedy
Is the Remote Control light-emitting area pointing towards the Remote Receiver on the projector when it is operated?	Point the remote control towards the Remote Receiver. Operating range  <a href="#">Quick Start Guide</a>

Check	Remedy
Is the remote control too far from the projector?	The operating range for the remote control is about 6 m.  <a href="#">Quick Start Guide</a>
Is direct sunlight or strong light from fluorescent lamps shining onto the Remote Receiver?	Set the projector up in a location where strong light does not shine onto the Remote Receiver.
Are the batteries dead or have the batteries been inserted correctly?	Make sure the batteries are inserted correctly or replace the batteries with new ones if necessary.  <a href="#">p.73</a>

I want to change the language for messages and menus

Check	Remedy
Change the Language setting.	Adjust the " <b>Language</b> " setting from the Configuration Menu.  <a href="#">p.53</a>



# Appendix

This chapter provides information on maintenance procedures to ensure the best level of performance from the projector for a long time to come.



**Discount-Merchant.com (800) 281-8860**  
**THE TRUSTED SOURCE FOR PROJECTOR LAMPS AND ACCESSORIES**

The projector supports the following four different projection methods. Install according to the conditions of the installation location.

## Warning

- A special method of installation is required when suspending the projector from a ceiling (ceiling mount). If it is not installed correctly, it could fall causing an accident and injury.
- If you use adhesives on the Ceiling mount fixing points to prevent the screws from loosening, or if you use things such as lubricants or oils on the projector, the projector case may crack causing it to fall from its ceiling mount. This could cause serious injury to anyone under the ceiling mount and could damage the projector.  
When installing or adjusting the Ceiling mount, do not use adhesives to prevent the screws from loosening and do not use oils or lubricants and so on.

## Attention

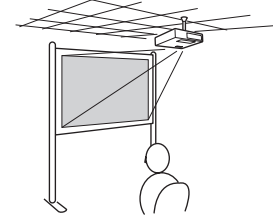

Do not use the projector on its side. This may cause malfunctions to occur.

- Suspend the projector from the ceiling and project images from in front of the screen. (Front/Ceiling projection)

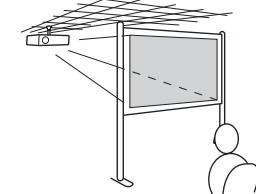

- Suspend the projector from the ceiling and project images from behind a translucent screen. (Rear/Ceiling projection)



- An optional Ceiling mount is required when suspending the projector from a ceiling.  p.79
- You can change the setting as follows by pressing down the [A/V Mute] button on the Remote Control for about five seconds.  
**Front ↔ Front/Ceiling**  
Set **Rear** or **Rear/Ceiling** from the Configuration Menu.  p.53

- Project images from in front of the screen. (Front projection)

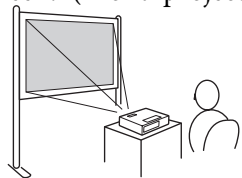

- Project images from behind a translucent screen. (Rear projection)

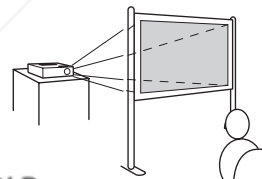

FixYourDLP.com  
Sponsored by 

**Discount-Merchant.com (800) 281-8860**

**THE TRUSTED SOURCE FOR PROJECTOR LAMPS AND ACCESSORIES**

You should clean the projector if it becomes dirty or if the quality of projected images starts to deteriorate.

**Attention**

*Turn off the projector's power before cleaning.*

## Cleaning the Projector's Surface

Clean the projector's surface by wiping it gently with a soft cloth.

If the projector is particularly dirty, moisten the cloth with water containing a small amount of neutral detergent, and then firmly wring the cloth dry before using it to wipe the projector's surface.

**Attention**

*Do not use volatile substances such as wax, alcohol, or thinner to clean the projector's surface. The quality of the case may change or become discolored.*

## Cleaning the Lens

Use a commercially available cloth for cleaning glasses to gently wipe the lens.

**Warning**

*Do not use sprays that contain flammable gas to remove dust and lint from the lens. The projector may catch fire due to the high internal temperature of the lamp.*

**Attention**

*Do not rub the lens with harsh materials or subject the lens to shocks, as it can easily become damaged.*



## Cleaning the Air Filter

Clean the air filter and the Air intake vent when the following message is displayed.

**"The projector is overheating. Make sure nothing is blocking the air vent, and clean or replace the air filter."**

### Attention

- *If dust collects on the air filter it can cause the internal temperature of the projector to rise, and this can lead to problems with operation and shorten the optical engine's service life. Clean the air filter immediately when the message is displayed.*
- *Do not rinse the air filter in water. Do not use detergents or solvents.*

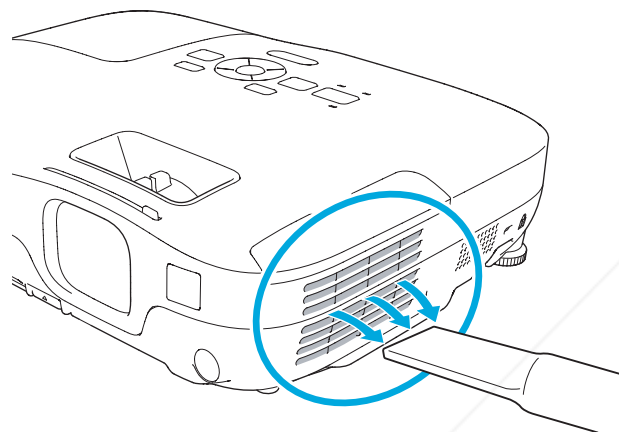

- If a message is frequently displayed, even after cleaning, it is time to replace the air filter. Replace it with a new air filter. [p.77](#)
- It is recommended that you clean these parts at least once every three months. Clean them more often than this if using the projector in a particularly dusty environment.



FixYourDLP.com

Sponsored by DLP

Discount-Merchant.com (800) 281-8860

THE TRUSTED SOURCE FOR PROJECTOR LAMPS AND ACCESSORIES

This section explains how to replace the Remote Control batteries, the Lamp, and the air filter.

## Replacing the Remote Control Batteries

If delays in the responsiveness of the Remote Control occur or if it does not operate after it has been used for some time, it probably means that the batteries are becoming flat. When this happens, replace them with new batteries. Have two AA size manganese or alkaline batteries ready. You cannot use other batteries except for the AA size manganese or alkaline.

### Attention

Make sure you read the Safety Instructions before handling the batteries.   
Safety Instructions

### Procedure

#### 1 Remove the battery cover.

While pushing the battery compartment cover catch, lift the cover up.

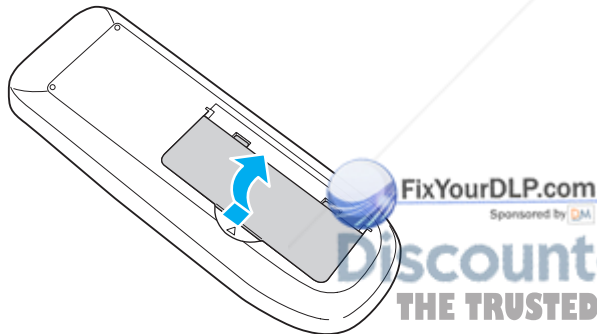

#### 2 Replace the old batteries with new batteries.

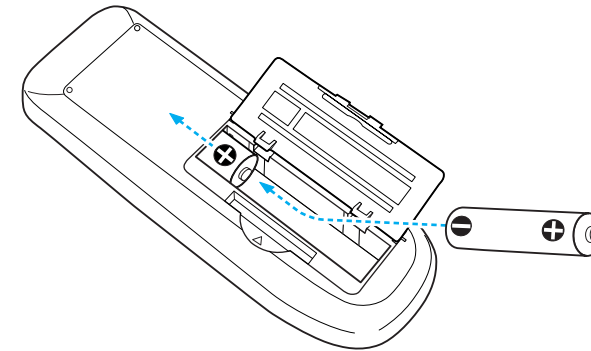

### Caution

Check the positions of the (+) and (-) marks inside the battery holder to ensure the batteries are inserted the correct way.

#### 3 Replace the battery cover.

Press the battery compartment cover until it clicks into place.

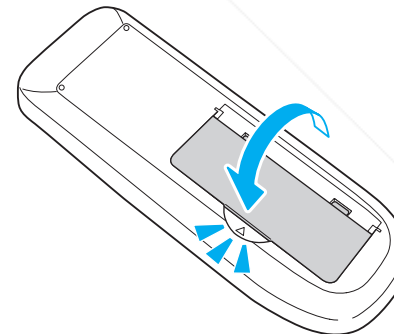

## Replacing the Lamp

### Lamp replacement period

It is time to replace the Lamp when:

- The message "**Replace the lamp.**" is displayed at the lower left of the projection screen when you start projecting.

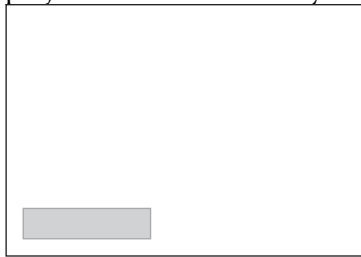

- The Lamp indicator flashes orange.

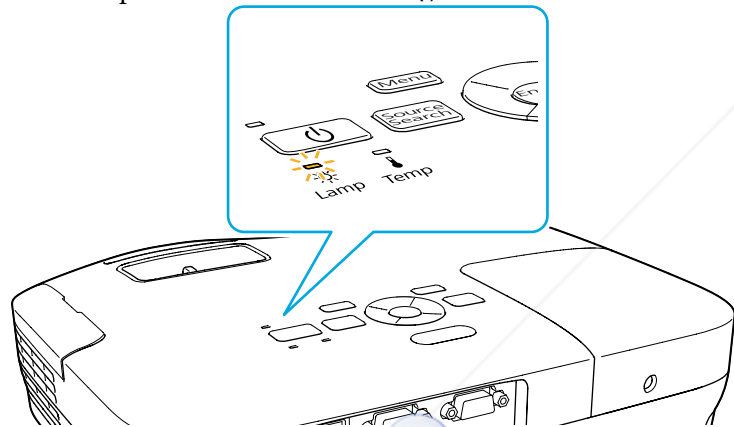

- The projected image gets darker or starts to deteriorate.

### Attention

- The lamp replacement message is set to appear after the following time periods in order to maintain the initial brightness and quality of the projected images. [p.52](#)  
 When **Power Consumption** is set to **Normal**: About 3900 hours  
 When **Power Consumption** is set to **ECO**: About 4900 hours
- If you continue to use the Lamp after the replacement period has passed, the possibility that the lamp may explode increases. When the Lamp replacement message appears, replace the Lamp with a new one as soon as possible, even if it is still working.
- Do not repeatedly turn off the power and immediately back on. Turning the power on and off frequently may shorten the lamp's operating life.
- Depending on the characteristics of the Lamp and the way it has been used, the lamp may become darker or stop working before the lamp warning message appears. You should always have a spare lamp unit ready in case it is needed.

### How to replace the lamp

The Lamp can be replaced even when the projector is suspended from a ceiling.

### Warning

- When replacing the Lamp because it has stopped illuminating, there is a possibility that the Lamp may be broken. If replacing the Lamp of a projector which has been installed on the ceiling, you should always assume that the Lamp is broken, and you should stand to the side of the Lamp cover, not underneath it. Remove the Lamp cover gently.
- Never disassemble or remodel the Lamp. If a remodeled or reassembled Lamp is installed into the projector and used, it could cause a fire, electric shock, or an accident.

## Caution

Wait until the Lamp has cooled down sufficiently before removing the Lamp cover. If the lamp is still hot, burns or other injuries may result. It takes about one hour after the power has been turned off for the Lamp to be cool enough.

## Procedure

**1** After you turn off the projector's power and the confirmation buzzer beeps twice, disconnect the power cable.

**2** Wait until the Lamp has cooled down, then remove the Lamp cover.

Loosen the Lamp cover fixing screw with the screwdriver supplied with the new lamp unit or a + head screwdriver. Then slide the Lamp cover straight forward and lift it to remove.

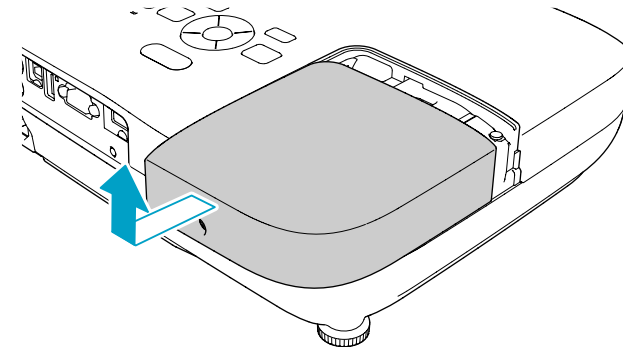
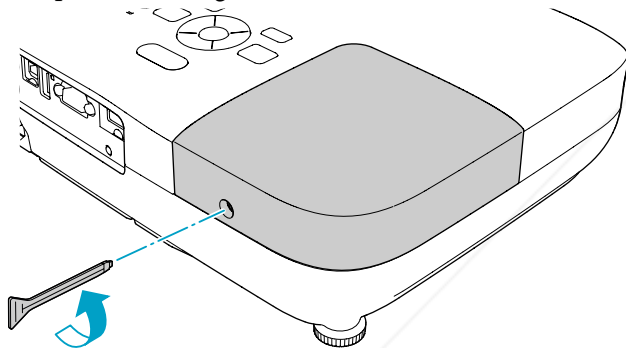

**3** Loosen the two Lamp fixing screws.

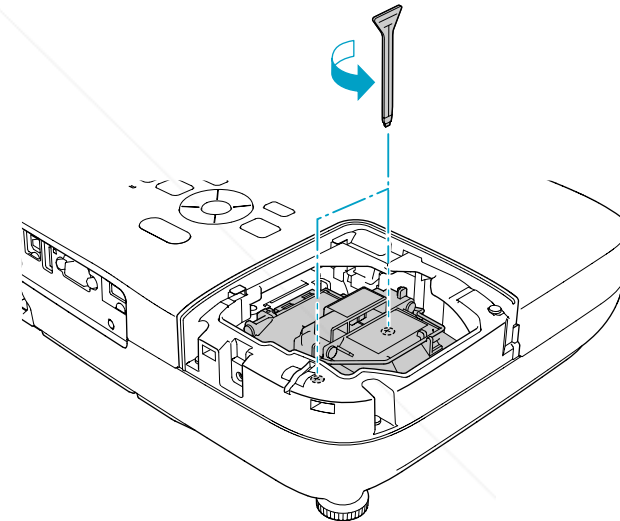

**4** Take out the old Lamp by pulling the handle.

If the Lamp is cracked, replace it with a new lamp, or contact your local dealer for further advice.  [Epson Projector Contact List](#)

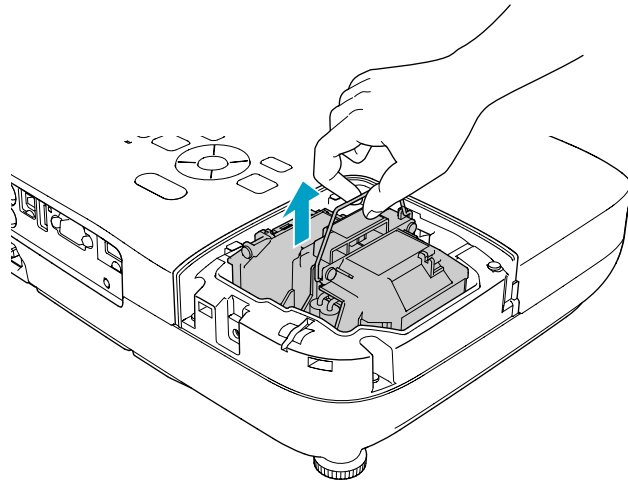

5

## Install the new Lamp.

Insert the new Lamp along the guide rail in the correct direction so that it fits in place securely, and tighten the two screws.

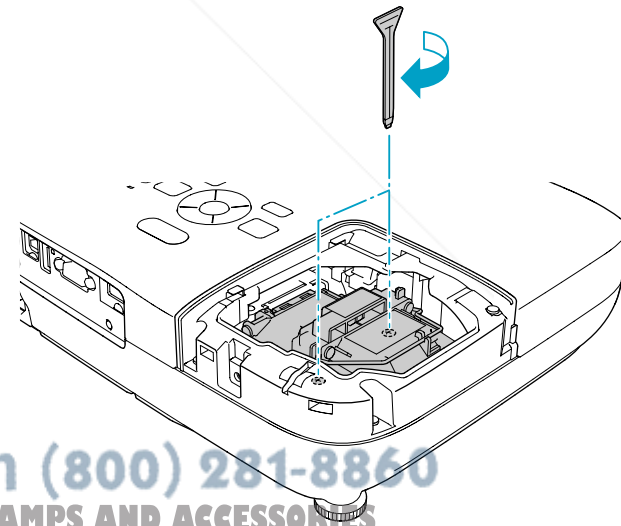
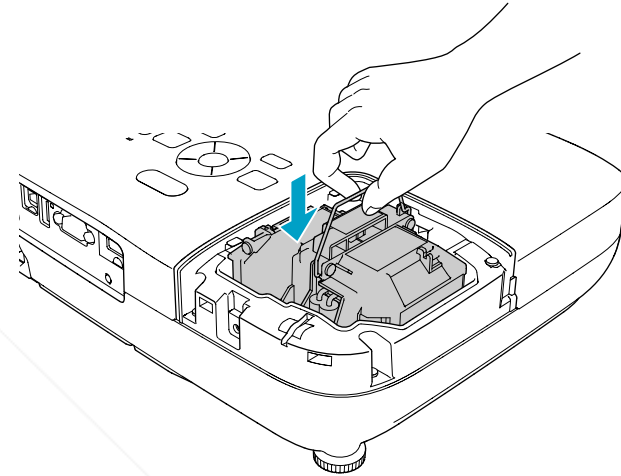

## 6 Replace the Lamp cover.

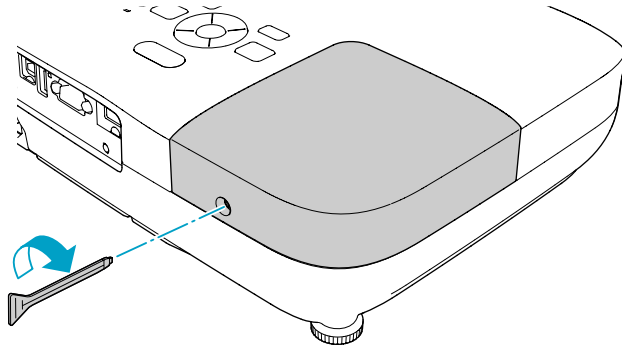

### Attention

- Make sure you install the Lamp securely. If the Lamp cover is removed, the power turns off automatically as a safety precaution. If the Lamp or the Lamp cover is not installed correctly, the power does not turn on.
- This product includes a lamp component that contains mercury (Hg). Please consult your local regulations regarding disposal or recycling. Do not dispose of it with normal waste.

## Resetting the lamp hours

The projector records how long the lamp is turned on and a message and indicator notify you when it is time to replace the lamp. After replacing the Lamp, make sure you reset the Lamp Hours from the Configuration Menu. [p.56](#)



Only reset the Lamp Hours after the Lamp has been replaced. Otherwise the Lamp replacement period is not indicated correctly.

## Replacing the Air Filter

### Air filter replacement period

It is time to replace the air filter when:

- There is a tear in the air filter.
- The message is displayed even though the air filter has been cleaned.

### How to replace the air filter

The air filter can be replaced even when the projector is suspended from a ceiling.

### Procedure

- 1 After you turn off the projector's power and the confirmation buzzer beeps twice, disconnect the power cable.
- 2 Open the air filter cover.

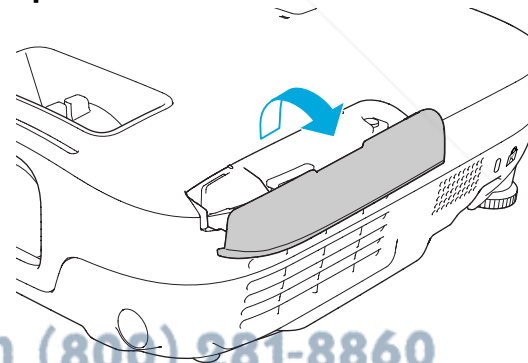

### 3 Remove the air filter.

Grip the air filter cover tab and pull it straight out.

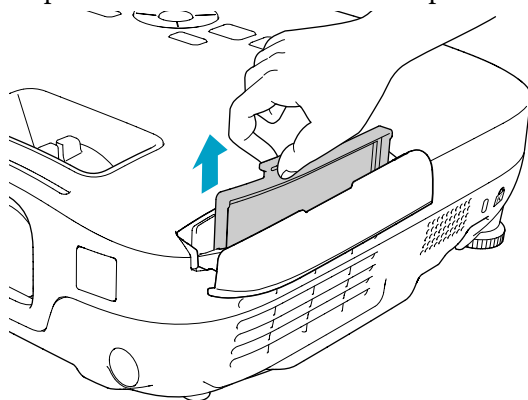

### 4 Install the new air filter.

Slide the air filter from the outside and press in until it firmly clicks into place.

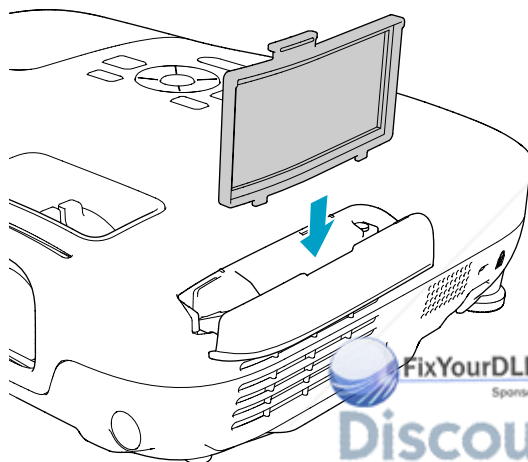

 Dispose of used air filters properly in accordance with your local regulations.  
Material of the frame part: ABS  
Material of the filter part: Polyurethane foam

### 5 Close the air filter cover.



The following optional accessories and consumables are available. Please purchase these products as and when needed. The following list of optional accessories and consumables is current as of: 2009.07. Details of accessories are subject to change without notice and availability may vary depending on the country of purchase.

## Optional accessories

**60" portable screen** ELPSC07

**80" portable screen** ELPSC08

**100" screen** ELPSC10

Portable roll-type screens ([Aspect Ratio](#) ▶ 4:3)

**70" portable screen** ELPSC23

**80" portable screen** ELPSC24

**90" portable screen** ELPSC25

Portable roll-type screens ([Aspect Ratio](#) ▶ 16:10)

**50" portable screen** ELPSC06

A compact screen that can be carried easily. (Aspect Ratio 4:3)

**Computer cable** ELPKC02

(1.8 m - for mini D-Sub15-pin/mini D-Sub 15pin)

This is the same as the computer cable supplied with the projector.

**Computer cable** ELPKC09

(3 m - for mini D-Sub15-pin/mini D-Sub 15pin)

**Computer cable** ELPKC10

(20 m - for mini D-Sub15-pin/mini D-Sub 15pin)

Use one of these longer cables if the computer cable supplied with the projector is too short.

**Component video cable** ELPKC19

(3 m - for mini D-Sub 15-pin/RCA male × 3)

Use to connect a [component video](#) ▶ source.

### Document Camera ELPDC06

Connect to the projector through a computer, and use it for projecting such documents as books, OHP documents, and slides.

### Ceiling pipe (450 mm)\* ELPFP13

### Ceiling pipe (700 mm)\* ELPFP14

Use when installing the projector on a high ceiling.

### Ceiling mount\* ELPMB23

Use when installing the projector on a ceiling.

\* A special method of installation is required to suspend the projector from a ceiling. Contact your dealer or the nearest address provided in the Support and Service Guide if you want to use this installation method.

👉 [Epson Projector Contact List](#)

## Consumables

### Lamp unit ELPLP54

Use as a replacement for used Lamps.

### Air filter ELPAF25

Use as a replacement for used air filters.



You can save the image that is currently being projected as a User's Logo.



Once a User's Logo has been saved, the logo cannot be returned to the factory default.

## Procedure

- 1 Project the image you want to use as the User's Logo, and then press the [Menu] button.

Using the Remote Control

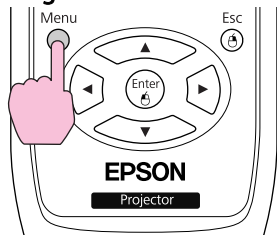

Using the Control panel

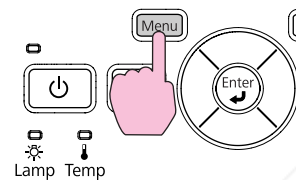

- 2 Select **Extended - User's Logo** from the Configuration Menu.  
☛ "Using the Configuration Menu" p.48

Check the buttons you can use and the operations they perform in the guide under the menu.



[Esc]:Return [↵]:Select [Enter]:Enter [Menu]:Exit



- If **User's Logo Protect** from **Password Protect** is set to **On**, a message is displayed and the user's logo cannot be changed. You can make changes after setting **User's Logo Protect** to **Off**.  
☛ p.37
- If **User's Logo** is selected when **Keystone**, **E-Zoom** or **Aspect** is being performed, the function currently being performed is cancelled.

- 3 When "Choose this image as the User's Logo?" is displayed, select "Yes".



When you press the [Enter] button on the Remote Control or the Control panel, the screen size may change according to the signal as it changes to the resolution of the image signal.

- 4 Move the box to select the part of the image to use as the User's Logo.

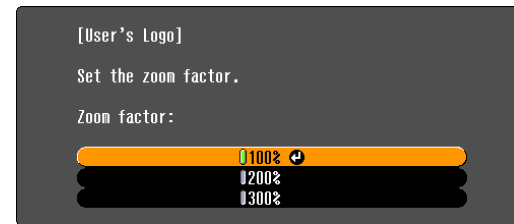
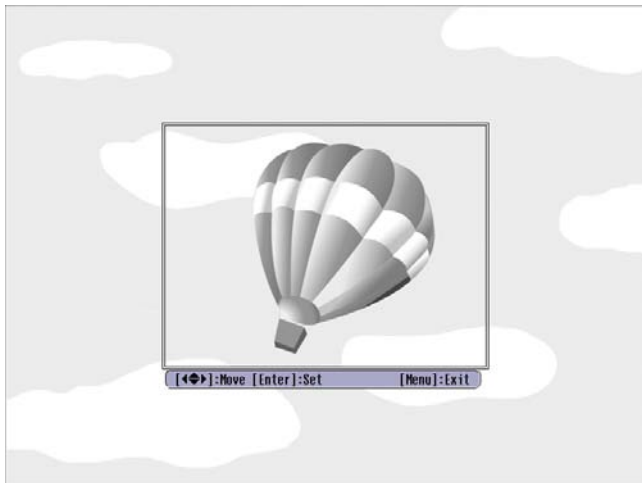

[Esc]:Return [Down]:Select [Enter]:Set [Menu]:Exit

7

**When the message Save this image as the User's Logo? is displayed, select Yes.**

The image is saved. After the image has been saved, the message Completed.is displayed.

### Using the Remote Control

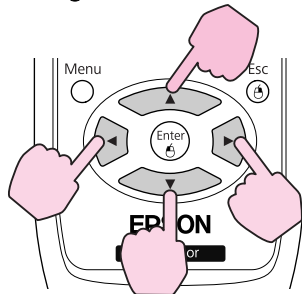

### Using the Control panel

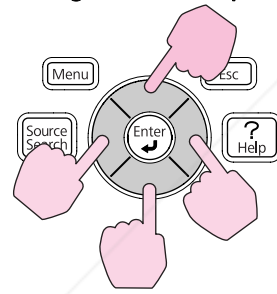

- When a User's Logo is saved, the previous User's Logo is erased.
- Saving the user's logo may take approximately 15 seconds. Do not use the projector or any connected equipment while it is saving, otherwise malfunctions may occur.



You can save at 400 × 300 dots in size.

5

**When Select this image? is displayed, select Yes.**

6

**Select the zoom factor from the zoom setting screen.**

## Projection Distances (EB-W8/W7)

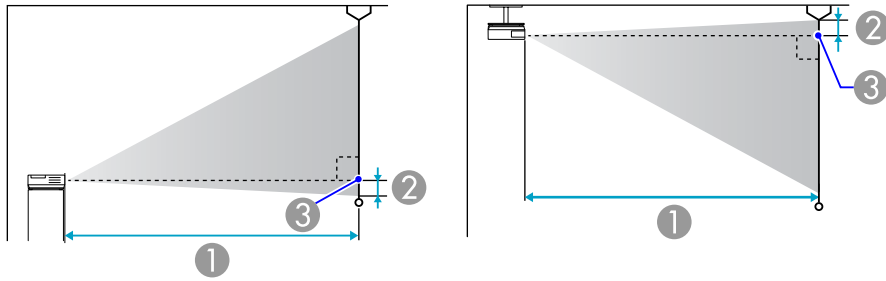

- ① Projection distance
- ② Distance from the center of the lens to the base of the screen  
(or to the top of the screen, if suspended from a ceiling)
- ③ Center of lens

Units: cm

16:9 Screen size		①	②
		Minimum (Wide) to Maximum (Tele)	
40"	89x50	114 - 137	5
50"	110x62	143 - 172	6
60"	130x75	172 - 208	8
80"	180x100	231 - 278	10
100"	220x120	289 - 348	13
120"	270x150	348 - 418	15
150"	330x190	435 - 523	19
200"	440x250	582 - 699	26
250"	550x310	728 - 874	32
310"	690x390	903 - 1084	40

Units: cm

4:3 Screen size		①	②
		Minimum (Wide) to Maximum (Tele)	
40"	81x61	126 - 152	9
50"	100x76	158 - 190	11
60"	120x91	190 - 229	13
80"	160x120	255 - 306	17
100"	200x150	319 - 383	22
120"	240x180	383 - 461	26
150"	300x230	480 - 577	33
200"	410x300	641 - 770	44
250"	500x380	802 - 963	48
280"	570x430	898 - 1079	61

Units: cm

16:10 Screen size		①	②
		Minimum (Wide) to Maximum (Tele)	
40"	86x54	111 - 134	8
50"	110x67	139 - 168	10
60"	130x81	168 - 202	12
80"	170x110	225 - 270	15
100"	220x130	281 - 338	19
120"	260x160	338 - 407	23
150"	320x200	424 - 509	29
200"	430x270	566 - 680	38
250"	540x340	708 - 850	48

Discount-Merchant.com (800) 281-8860  
 THE TRUSTED SOURCE FOR PROJECTOR LAMPS AND ACCESSORIES

16:10 Screen size		①	②
		Minimum (Wide) to Maximum (Tele)	
320"	690x430	907 - 1089	62

4:3 Screen size		①	②
		Minimum (Wide) to Maximum (Tele)	
100"	200x150	302 - 363	-17
120"	240x180	363 - 436	-20
150"	300x230	454 - 546	-25
200"	410x300	607 - 729	-34
250"	510x380	759 - 912	-42
300"	610x460	912 - 1095	-51

## Projection Distances (EB-X8/X7)

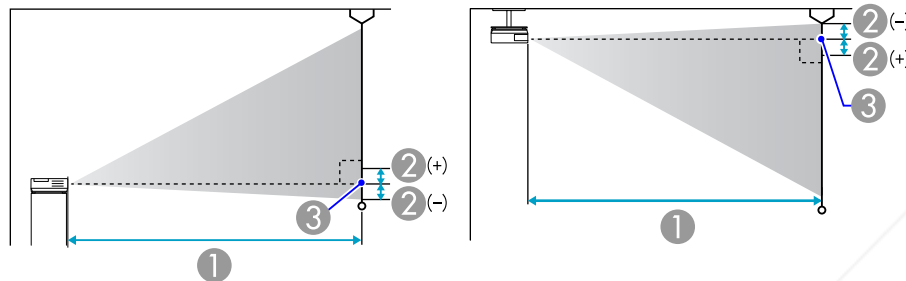

- ① Projection distance
- ② Distance from the center of the lens to the base of the screen (or to the top of the screen, if suspended from a ceiling)
- ③ Center of lens

Units: cm

16:9 Screen size		①	②
		Minimum (Wide) to Maximum (Tele)	
30"	66x37	97 - 117	+1
40"	89x50	130 - 156	+1
50"	110x62	163 - 196	+1
60"	130x75	196 - 236	+1
80"	180x100	263 - 316	+2
100"	220x120	329 - 396	+2
120"	270x150	385 - 462	+3
150"	330x190	495 - 595	+3
200"	440x250	661 - 794	+5
250"	550x310	827 - 994	+6
275"	610x340	910 - 1093	+6

Units: cm

4:3 Screen size		①	②
		Minimum (Wide) to Maximum (Tele)	
30"	61x46	89 - 107	-5
40"	81x61	119 - 143	-7
50"	100x76	150 - 180	-8
60"	120x91	180 - 217	-10
80"	160x120	241 - 290	-14

FixYourDLP.com
   
 Discount-Merchant.com (800) 281-8860
   
 THE TRUSTED SOURCE FOR PROJECTOR LAMPS AND ACCESSORIES

## Projection Distances (EB-S8/S7)

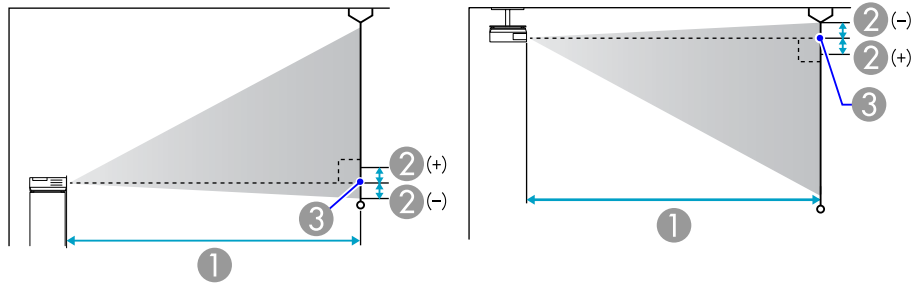

- ① Projection distance
- ② Distance from the center of the lens to the base of the screen  
(or to the top of the screen, if suspended from a ceiling)
- ③ Center of lens

Units: cm

16:9 Screen size		①	②
		Minimum (Wide) to Maximum (Tele)	
30"	66x37	95 - 130	+1
40"	89x50	128 - 174	+1
50"	110x62	161 - 218	+1
60"	130x75	193 - 262	+2
80"	180x100	259 - 350	+2
100"	220x120	324 - 438	+3
120"	270x150	389 - 527	+3
150"	330x190	487 - 659	+4
200"	440x250	651 - 880	+5

Units: cm

4:3 Screen size		①	②
		Minimum (Wide) to Maximum (Tele)	
30"	61x46	87 - 119	-5
40"	81x61	117 - 159	-7
50"	100x76	147 - 200	-8
60"	120x91	177 - 240	-10
80"	160x120	237 - 321	-13
100"	200x150	297 - 402	-17
120"	240x180	357 - 483	-20
150"	300x230	447 - 605	-25
200"	410x300	597 - 807	-33

  
**Discount-Merchant.com (800) 281-8860**
  
 THE TRUSTED SOURCE FOR PROJECTOR LAMPS AND ACCESSORIES

## Connecting to an External Monitor (EB-W7/X7/S7 only)

You can display computer images input from Computer Input Port on an external monitor connected to the projector and the screen at the same time. This means that you can check projected images on an external monitor when giving presentations even if you cannot see the screen. Connect using the cable supplied with the external monitor.

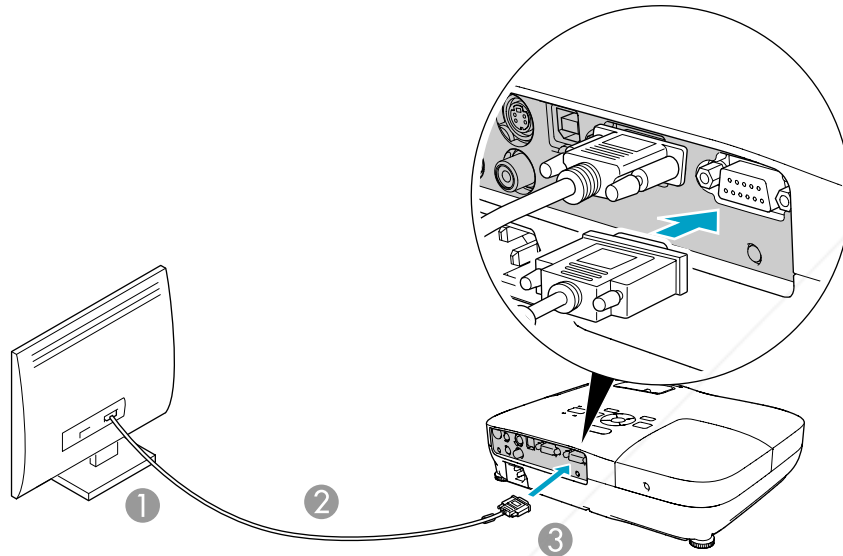

- ① To Monitor port
- ② Cable supplied with monitor
- ③ To Monitor Out Port



- You cannot display images from equipment connected to the component video signal, Video input port, or S-Video input port on the external monitor.
- Setting gauges, Configuration Menu, or Help screens for functions such as Keystone are not output to the external monitor.
- If you want to display images on the external monitor while the projector is in standby mode, set **Extended - Standby Mode** to **Communication On** from the Configuration menu. [p.53](#)

### Connecting to External Speakers (EB-S8/W7/X7/S7 only)

You can connect speakers with built-in amplifiers to the projector's Audio Out port to enjoy a fuller quality of sound. Connect with a commercially available audio cable (such as pin plug ↔ 3.5 mm stereo mini plug and so on). Use an audio cable compatible with the connector on the external speakers.



- When the audio cable jack is inserted into the Audio Out Port, audio stops being output from the projector's built-in speakers and switches to external output.
- When connecting the speakers, turn down the speakers' volume or turn off the its power, as noise is produced during connection.
- When using a commercially available 2RCA(L/R)/stereo mini-pin audio cable, make sure it is labeled "No resistance".

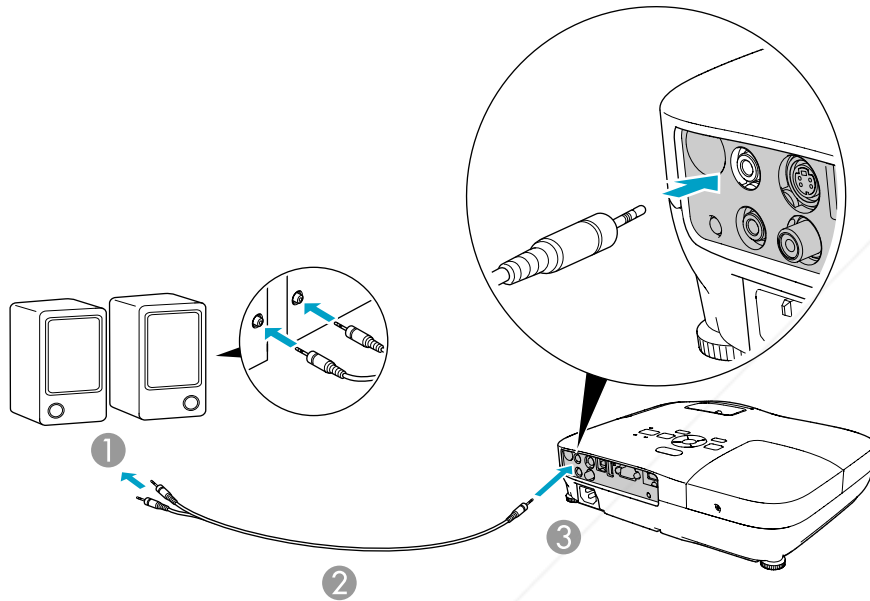

- ① To external audio equipment
- ② Audio cable (commercially available)
- ③ To Audio Out Port

FixYourDLP.com  
Sponsored by DM

**Discount-Merchant.com (800) 281-8860**  
THE TRUSTED SOURCE FOR PROJECTOR LAMPS AND ACCESSORIES

You can monitor and control the projector from a computer, via USB. This is done by connecting the projector and the computer with a USB cable, and entering communication commands (ESC/VP21 commands).

## Before You Begin

To monitor and control the projector with ESC/VP21 commands, the following preparations must be carried out.

### Procedure

- 1 **Install the USB communication driver (EPSON USB-COM Driver) to your computer. For information about the EPSON USB-COM Driver, contact your local dealer or the nearest address provided in the Support and Service Guide.** [Epson Projector Contact List](#)
- 2 **From the projector's Configuration menu, set Extended - USB Type B to Wireless Mouse or Page Up/Down.**
- 3 **Similarly, set Link 21L to On from Extended menu.**
- 4 **Connect the computer's USB port to the projector's USB(TypeB) port with a USB cable.**

From second time on, start from step two.

## Command List

When the power ON command is transmitted to the projector, the power turns on and it enters warm-up mode. When the projector's power has turned on, a colon ':' (3Ah) is returned.

When a command is input, the projector executes the command and returns a ':', and then accepts the next command.

If the command being processed terminates abnormally, an error message is output and a '?' is returned.

Item		Command	
Power ON/OFF	On	PWR ON	
	Off	PWR OFF	
Signal selection	Computer	Auto	SOURCE 1F
		RGB	SOURCE 11
	HDMI (EB-W8/X8 only)		SOURCE 30
	Video		SOURCE 41
	S-Video		SOURCE 42
	USB Display		SOURCE 51
	USB (EB-X8/S8 only)		SOURCE 52
A/V Mute On/Off	On	MUTE ON	
	Off	MUTE OFF	
A/V Mute selection	Black	MSEL 00	
	Blue	MSEL 01	
	Logo	MSEL 02	

Add a Carriage Return (CR) code (0Dh) to the end of each command and transmit.

## Communications protocol

- Default baud rate setting: 9600bps (the speed during communication complies with the USB 1.1 standard.)
- Data length: 8 bit
- Parity: None
- Stop-bit: 1 bit
- Flow control: None



## Supported Monitor Displays (EB-W8/W7)

### Computer signals (analog RGB)

Units: dots

Signal	Refresh Rate (Hz)	Resolution	Aspect Mode				
			Normal	16:9	Full	Zoom	Native
VGAEGA	85	640x350	1280x700	1280x720	1280x800	1280x700	640x350
VGA	60/72/75/85/iMac*1	640x480/640x360*2	1066x800	1280x720	1280x800	1280x800	640x480
SVGA	56/60/72/75/85/iMac*1	800x600/800x450*2	1066x800	1280x720	1280x800	1280x800	800x600
XGA	60/70/75/85/iMac*1	1024x768/1024x576*2	1066x800	1280x720	1280x800	1280x800	1024x768
WXGA	60	1280x768	1280x768	1280x720	1280x800	1280x768	1280x768
	60	1360x768	1280x722	1280x720	1280x800	1280x722	1280x768
	60/75/85	1280x800	1280x800	1280x720	1280x800	1280x800	1280x800
WXGA+	60/75/85	1440x900	1280x800	1280x720	1280x800	1280x800	1280x800
WSXGA+*3	60	1680x1050	1280x800	1280x720	1280x800	1280x800	1280x800
SXGA	70/75/85	1152x864	1066x800	1280x720	1280x800	1280x800	1152x800
	60/75/85	1280x1024	1000x800	1280x720	1280x800	1280x800	1152x800
	60/75/85	1280x960	1066x800	1280x720	1280x800	1280x800	1152x800
SXGA+	60/75/85	1400x1050	1066x800	1280x720	1280x800	1280x800	1280x800
UXGA	60	1600x1200	1066x800	1280x720	1280x800	1280x800	1280x800
MAC13"	67	640x480	1066x800	1280x720	1280x800	1280x800	640x480
MAC16"	75	832x624	1066x800	1280x720	1280x800	1280x800	832x624
MAC19"	60	1024x768	1066x800	1280x720	1280x800	1280x800	1024x768
	60	1024x768	1066x800	1280x720	1280x800	1280x800	1024x768



Discount-Merchant.com (800) 281-8860

THE TRUSTED SOURCE FOR PROJECTOR LAMPS AND ACCESSORIES

Signal	Refresh Rate (Hz)	Resolution	Aspect Mode				
			Normal	16:9	Full	Zoom	Native
MAC21"	75	1152x870	1059x800	1280x720	1280x800	1280x800	1152x800

\*1 Connection is disabled if the equipment does not have a VGA output port.

\*2 Letterbox signal

\*3 Only compatible when **Wide** is selected as the **Resolution** from the Configuration Menu.

Even when signals other than those mentioned above are input, it is likely that the image can be projected. However, not all functions may be supported.

## Component video

Units: dots

Signal	Refresh Rate (Hz)	Resolution	Aspect Mode				
			Normal	16:9	Full	Zoom	Native
SDTV(480i)	60	720x480/720x360*	1066x800	1280x720	1280x800	1280x800	640x480
SDTV(576i)	50	720x576/720x432*	1066x800	1280x720	1280x800	1280x800	768x576
SDTV(480p)	60	720x480/720x360*	1066x800	1280x720	1280x800	1280x800	640x480
SDTV(576p)	50	720x576/720x432*	1066x800	1280x720	1280x800	1280x800	768x576
HDTV(720p)	50/60	1280x720	1280x720	1280x720	1280x800	1280x720	1280x720
HDTV(1080i)	50/60	1920x1080	1280x720	1280x720	1280x800	1280x720	1280x800

\* Letterbox signal

## Composite video/S-video

Units: dots

Signal	Refresh Rate	Resolution	Aspect Mode				
			Normal	16:9	Full	Zoom	Native
TV(NTSC)	60	720x480/720x360*	1066x800	1280x720	1280x800	1280x800	640x480
TV(PAL,SECAM)	50	720x576/720x432*	1066x800	1280x720	1280x800	1280x800	768x576

\* Letterbox signal

## Input signal from the HDMI input port (EB-W8 only)

Units: dots

Signal	Refresh Rate (Hz)	Resolution	Aspect Mode			
			16:9	Full	Zoom	Native
VGA	60	640x480/640x360*	1280x720	1280x800	1280x800	640x480
SVGA	60	800x600	1280x720	1280x800	1280x800	800x600
XGA	60	1024x768	1280x720	1280x800	1280x800	1024x768
WXGA	60	1280x800	1280x720	1280x800	1280x800	1280x800
SXGA	60	1280x960	1280x720	1280x800	1280x800	1280x800
	60	1280x1024	1280x720	1280x800	1280x800	1280x800
SXGA+	60	1400x1050	1280x800	1280x800	1280x800	1280x800
UXGA	60	1600x1200	1280x720	1280x800	1280x800	1280x800
SDTV(480i)	60	720x480/720x360*	1280x720	1280x800	1280x800	640x480
SDTV(480p)	60	720x480/720x360*	1280x720	1280x800	1280x800	640x480
SDTV(576i)	50	720x576/720x432*	1280x720	1280x800	1280x800	768x576
SDTV(576p)	50	720x576/720x432*	1280x720	1280x800	1280x800	768x576
HDTV(720p)	50/60	1280x720	1280x720	1280x800	1280x720	1280x720
HDTV(1080i)	50/60	1920x1080	1280x720	1280x800	1280x720	1280x800
HDTV(1080p)	50/60	1920x1080	1280x720	1280x800	1280x720	1280x800

\* Letterbox signal



**Discount-Merchant.com (800) 281-8860**  
 THE TRUSTED SOURCE FOR PROJECTOR LAMPS AND ACCESSORIES

## Supported Monitor Displays (EB-X8/X7)

### Computer signals (analog RGB)

Units: dots

Signal	Refresh Rate (Hz)	Resolution	Aspect Mode		
			Normal	4:3	16:9
VGAEGA	85	640x350	1024x560	1024x768	1024x576
VGA	60/72/75/85/iMac <sup>*1</sup>	640x480/640x360 <sup>*2</sup>	1024x768	1024x768	1024x576
SVGA	56/60/72/75/85/iMac <sup>*1</sup>	800x600/800x450 <sup>*2</sup>	1024x768	1024x768	1024x576
XGA	60/70/75/85/iMac <sup>*1</sup>	1024x768/1024x576 <sup>*2</sup>	1024x768	1024x768	1024x576
WXGA	60	1280x768	1024x614	1024x768	1024x576
	60	1360x768	1024x578	1024x768	1024x576
	60/75	1280x800	1024x640	1024x768	1024x576
WXGA+	60	1440x900	1024x640	1024x768	1024x576
SXGA	70/75	1152x864	1024x768	1024x768	1024x576
	60	1280x1024	960x768	1024x768	1024x576
	60	1280x960	1024x768	1024x768	1024x576
SXGA+	60	1400x1050	1024x768	1024x768	1024x576
MAC13"	67	640x480	1024x768	1024x768	1024x576
MAC16"	75	832x624	1024x768	1024x768	1024x576
MAC19"	75	1024x768	1024x768	1024x768	1024x576
	60	1024x768	1024x768	1024x768	1024x576
MAC21"		1152x870	1016x768	1024x768	1024x576

\*1 Connection is disabled if the equipment does not have a VGA output port.

\*2 Letterbox signal

Even when signals other than those mentioned above are input, it is likely that the image can be projected. However, not all functions may be supported.

## Component video

Units: dots

Signal	Refresh Rate (Hz)	Resolution	Aspect Mode	
			4:3	16:9
SDTV(480i)	60	720x480/720x360*	1024x768	1024x576
SDTV(576i)	50	720x576/720x432*	1024x768	1024x576
SDTV(480p)	60	720x480/720x360*	1024x768	1024x576
SDTV(576p)	50	720x576/720x432*	1024x768	1024x576
HDTV(720p)	50/60	1280x720	1024x768	1024x576
HDTV(1080i)	50/60	1920x1080	1024x768	1024x576

\* Letterbox signal

## Composite video/S-video

Units: dots

Signal	Refresh Rate (Hz)	Resolution	Aspect Mode	
			4:3	16:9
TV(NTSC)	60	720x480/720x360*	1016x768	1024x576
TV(PAL,SECAM)	50	720x576/720x432*	1016x768	1024x576

\* Letterbox signal

## Input signal from the HDMI input port (EB-X8 only)

Units: dots

Signal	Refresh Rate (Hz)	Resolution	Aspect Mode	
			4:3	16:9
VGA	60	640x480/640x360*	1024x768	1024x576
SVGA	60	800x600	1024x768	1024x576
XGA	60	1024x768	1024x768	1024x576
WXGA	60	1280x800	1024x768	1024x576

Signal	Refresh Rate (Hz)	Resolution	Aspect Mode	
			4:3	16:9
SXGA	60	1280x960	1024x768	1024x576
	60	1280x1024	1024x768	1024x576
SXGA+	60	1400x1050	1024x768	1024x576
SDTV(480i)	60	720x480/720x360*	1024x768	1024x576
SDTV(480p)	60	720x480/720x360*	1024x768	1024x576
SDTV(576i)	50	720x576/720x432*	1024x768	1024x576
SDTV(576p)	50	720x576/720x432*	1024x768	1024x576
HDTV(720p)	50/60	1280x720	1024x768	1024x576
HDTV(1080i)	50/60	1920x1080	1024x768	1024x576
HDTV(1080p)	50/60	1920x1080	1024x768	1024x576

\* Letterbox signal

## Supported Monitor Displays (EB-S8/S7)

### Computer signals (analog RGB)

Units: dots

Signal	Refresh Rate (Hz)	Resolution	Aspect Mode		
			Normal	4:3	16:9
VGAEGA	85	640x350	800x438	800x600	800x450
VGA	60/72/75/85/iMac <sup>*1</sup>	640x480/640x360 <sup>*2</sup>	800x600	800x600	800x450
SVGA	56/60/75/85/iMac <sup>*1</sup>	800x600/800x450 <sup>*2</sup>	800x600	800x600	800x450
XGA	60/70/75/85/iMac <sup>*1</sup>	1024x768/1024x576 <sup>*2</sup>	800x600	800x600	800x450
WXGA	60	1280x768	800x480	800x600	800x450
	60	1360x768	800x451	800x600	800x450
	60/75	1280x800	800x500	800x600	800x450

Signal	Refresh Rate (Hz)	Resolution	Aspect Mode		
			Normal	4:3	16:9
WXGA+	60	1440x900	800x500	800x600	800x450
SXGA	70/75	1152x864	800x600	800x600	800x450
	60	1280x1024	750x600	800x600	800x450
	60	1280x960	800x600	800x600	800x450
SXGA+	60	1400x1050	800x600	800x600	800x450
MAC13"	67	640x480	800x600	800x600	800x450
MAC16"	75	832x624	800x600	800x600	800x450
MAC19"	75	1024x768	800x600	800x600	800x450
	60	1024x768	800x600	800x600	800x450
MAC21"	75	1152x870	794x600	800x600	800x450

\*1 Connection is disabled if the equipment does not have a VGA output port.

\*2 Letterbox signal

Even when signals other than those mentioned above are input, it is likely that the image can be projected. However, not all functions may be supported.

## Component video

Units: dots

Signal	Refresh Rate (Hz)	Resolution	Aspect Mode	
			4:3	16:9
SDTV(480i)	60	720x480/720x360*	800x600	800x450
SDTV(576i)	50	720x576/720x432*	800x600	800x450
SDTV(480p)		720x480/720x360*	800x600	800x450
SDTV(576p)		720x576/720x432*	800x600	800x450
HDTV(720p)	50/60	1280x720	800x600	800x450
HDTV(1080i)	50/60	1920x1080	800x600	800x450

\* Letterbox signal

## Composite video/S-video

Units: dots

Signal	Refresh Rate (Hz)	Resolution	Aspect Mode	
			4:3	16:9
TV(NTSC)	60	720x480/720x360*	800x600	800x450
TV(PAL,SECAM)	50	720x576/720x432*	800x600	800x450

\* Letterbox signal



## Projector General Specifications

Product name		EB-W8	EB-X8	EB-S8	EB-W7	EB-X7	EB-S7
Dimensions		295 (W) × 77 (H) × 228 (D) mm					
Panel size		0.59" Wide	0.55"		0.59" Wide	0.55"	
Display method		Polysilicon TFT active matrix					
Resolution		1,024,000 pixels WXGA (1280 (W) × 800 (H) dots) × 3	786,432 XGA (1024 (W) × 768 (H) dots) × 3	480,000 SVGA (800 (W) × 600 (H) dots) × 3	1,024,000 WXGA (1280 (W) × 800 (H) dots) × 3	786,432 XGA (1024 (W) × 768 (H) dots) × 3	480,000 SVGA (800 (W) × 600 (H) dots) × 3
Focus adjustment		Manual					
Zoom adjustment		Manual (1 to 1.2)		Digital (1 to 1.35)		Manual (1 to 1.2) Digital (1 to 1.35)	
Lamp		UHE lamp, 200 W Model No.: ELPLP54			UHE lamp, 175 W Model No.: ELPLP54		
Max. audio output		1 W monaural					
Speaker		1					
Power supply		100 to 240 V AC ±10% 50/60 Hz 3.2 to 1.4 A			100 to 240 V AC ±10% 50/60 Hz 2.8 to 1.2 A		
Power consumption	100 to 120 V area	Operating: 280 W Standby power consumption (Communication On): 2.6 W Standby power consumption (Communication Off): 0.3 W			Operating: 244 W Standby power consumption (Communication On): 2.6 W Standby power consumption (Communication Off): 0.3 W		
	200 to 240 V area	Operating: 265 W Standby power consumption (Communication On): 3.9 W Standby power consumption (Communication Off): 0.4 W			Operating: 234 W Standby power consumption (Communication On): 3.9 W Standby power consumption (Communication Off): 0.4 W		
Operating altitude		Altitude 0 to 2,286 m					
Operating temperature		5 to +35 (No condensation)					
Storage temperature		-10 to +60 (No condensation)					
Mass		Approx. 2.3kg					

Product name			EB-W8	EB-X8	EB-S8	EB-W7	EB-X7	EB-S7
Connectors	Computer Input Port	1	Mini D-Sub15-pin (female) blue					
	Video input port	1	RCA pin jack					
	S-Video input port	1	Mini DIN 4-pin					
	Audio Port	1	RCA pin jack x 2 (L, R)		Stereo mini jack			
	HDMI port	1	HDMI (Audio is only supported by PCM)		-			
	Monitor Out Port	1	-		Mini D-Sub15-pin (female) black			
	Audio Out Port	1	-		Stereo mini jack			
	USB(TypeA) Port*1	1	USB connector (Type A)		-			
	USB(TypeB) Port*2	1	USB connector (Type B)					

\*1 Supports USB 1.1.

\*2 Supports USB 2.0.

USB(TypeA) and USB(TypeB) ports are not guaranteed to operate all devices that support USB.

This product is also designed for IT power distribution system with phase-to-phase voltage 230V.

Angle of tilt

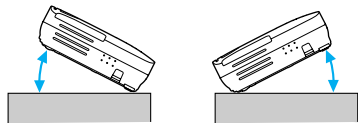

If you use the projector tilted at an angle of more than 30° it could be damaged and cause an accident.



Discount-Merchant.com (800) 281-8860  
 THE TRUSTED SOURCE FOR PROJECTOR LAMPS AND ACCESSORIES

**DECLARATION of CONFORMITY**

According to 47CFR, Part 2 and 15

Class B Personal Computers and Peripherals; and/or  
CPU Boards and Power Supplies used with Class B Personal Computers

We: Epson America, Inc.  
Located at: 3840 Kilroy Airport Way  
MS: 3-13  
Long Beach, CA 90806  
Tel: 562-290-5254

Declare under sole responsibility that the product identified herein, complies with 47CFR Part 2 and 15 of the FCC rules as a Class B digital device. Each product marketed, is identical to the representative unit tested and found to be compliant with the standards. Records maintained continue to reflect the equipment being produced can be expected to be within the variation accepted, due to quantity production and testing on a statistical basis as required by 47CFR 2.909. Operation is subject to the following two conditions : (1) this device may not cause harmful interference, and (2) this device must accept any interference received, including interference that may cause undesired operation.

Trade Name: EPSON  
Type of Product: LCD Projector  
Model: H309C/H310C/H311C/H312C/H327C/H328C/



**Discount-Merchant.com (800) 251-8860**  
THE TRUSTED SOURCE FOR PROJECTOR LAMPS AND ACCESSORIES

**FCC Compliance Statement  
For United States Users**

This equipment has been tested and found to comply with the limits for a Class B digital device, pursuant to Part 15 of the FCC Rules. These limits are designed to provide reasonable protection against harmful interference in a residential installation. This equipment generates, uses, and can radiate radio frequency energy and, if not installed and used in accordance with the instructions, may cause harmful interference to radio communications. However, there is no guarantee that interference will not occur in a particular installation. If this equipment does cause interference to radio or television reception, which can be determined by turning the equipment off and on, the user is encouraged to try to correct the interference by one or more of the following measures.

- Reorient or relocate the receiving antenna.
- Increase the separation between the equipment and receiver.
- Connect the equipment into an outlet on a circuit different from that to which the receiver is connected.
- Consult the dealer or an experienced radio/TV technician for help.

**WARNING**

The connection of a non-shielded equipment interface cable to this equipment will invalidate the FCC Certification or Declaration of this device and may cause interference levels which exceed the limits established by the FCC for this equipment. It is the responsibility of the user to obtain and use a shielded equipment interface cable with this device. If this equipment has more than one interface connector, do not leave cables connected to unused interfaces. Changes or modifications not expressly approved by the manufacturer could void the user's authority to operate the equipment.

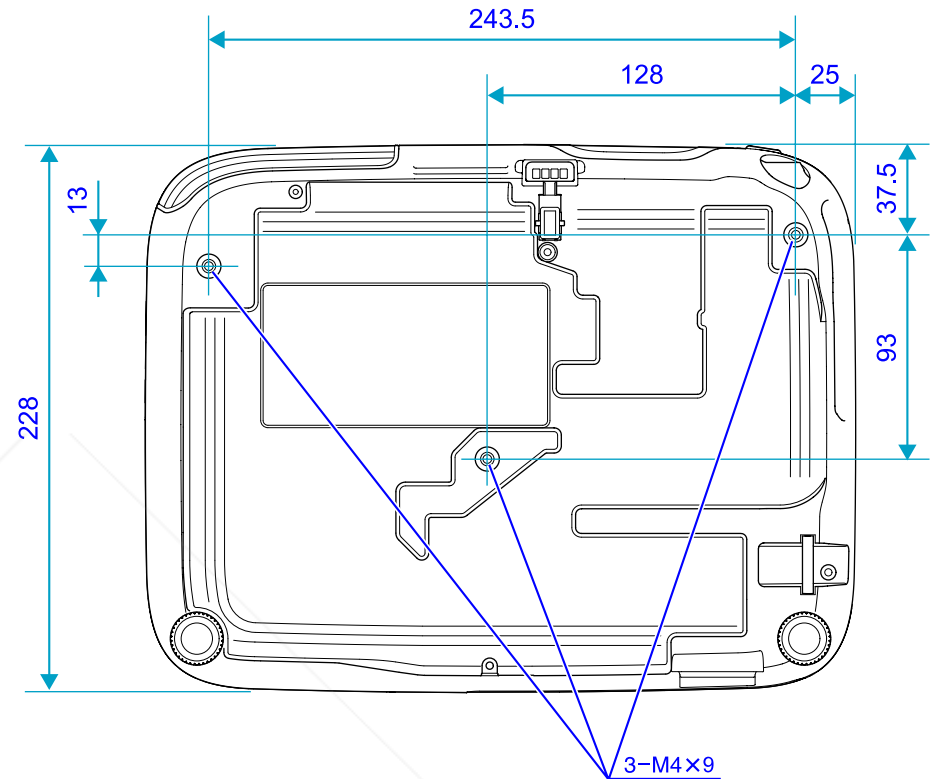
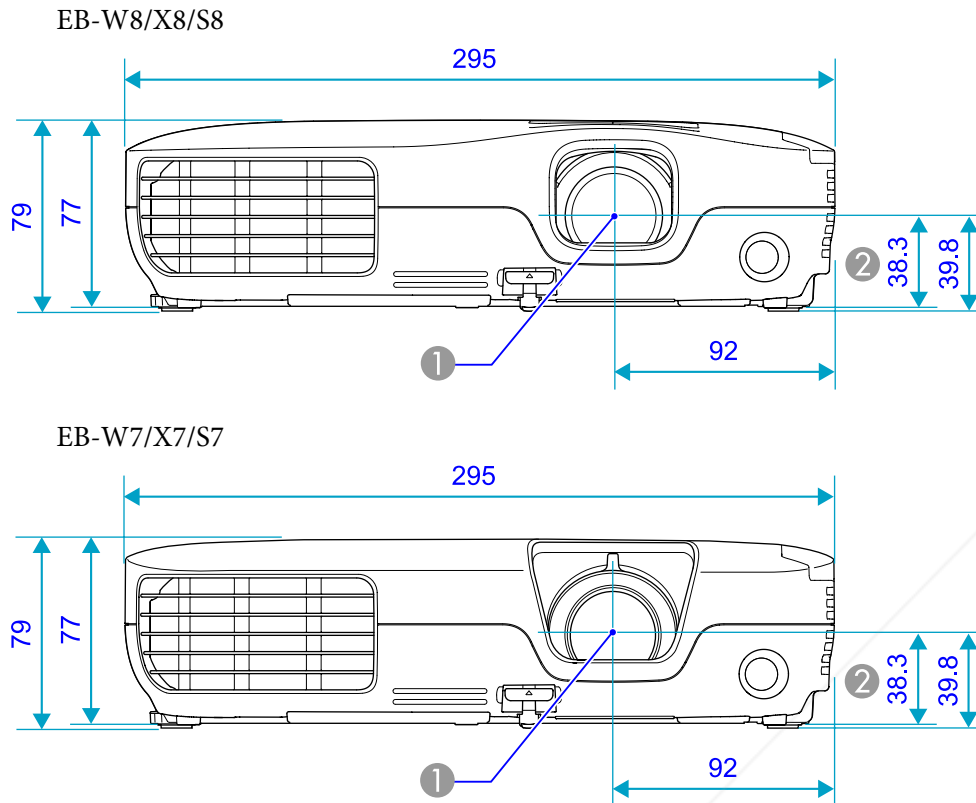

Units: mm

- ① Center of lens
- ② Distance from center of lens to suspension bracket fixing point



**Discount-Merchant.com (800) 281-8860**  
THE TRUSTED SOURCE FOR PROJECTOR LAMPS AND ACCESSORIES

This section explains easily terms that are used with the projector and difficult terms that are not explained in the text of this guide. For details, refer to other commercially available publications.

<b>Aspect Ratio (Aspect Ratio)</b>	The ratio between an image's length and its height. HDTV images have an aspect ratio of 16:9 and appear elongated. The aspect ratio for standard images is 4:3.
<b>Component Video</b>	A Video signal which has the luminance component and color component separated to provide better image quality. Refers to images that consist of three independent signals: Y (luminance signal), Pb and Pr (color difference signals).
<b>Composite video</b>	Video signals that have the video brightness signals and color signals mixed together. The type of signals commonly used by household video equipment (NTSC, PAL, and SECAM formats). The carrier signal Y (luminance signal) and chroma (color) signal that are contained in the color bar are overlapped to form a single signal.
<b>Contrast</b>	The relative brightness of the light and dark areas of an image can be increased or decreased to make text and graphics stand out more clearly, or to make them appear softer. Adjusting this particular property of an image is called Contrast adjustment.
<b>Dolby Digital</b>	A sound format developed by Dolby Laboratories. Normal stereo is a 2-channel format that uses two speakers. Dolby Digital is a 6-channel (5.1-channel) system which adds to this a center speaker, two rear speakers, and a sub-woofer.
<b>HDCP</b>	An abbreviation of High-bandwidth Digital Content Protection, which refers to a copyright protection technology that prevents illegal copying by encrypting the digital signals sent and received via HDMI port. Because the HDMI input port on this projector supports HDCP, it can project digital images protected by HDCP technology, However, if the HDCP standard changes, it may not be possible to project digital images protected by the changed standard.
<b>HDTV</b>	An abbreviation for High-Definition Television that refers to high-definition systems which satisfy the following conditions. <ul style="list-style-type: none"> <li>• Vertical resolution of 720p or 1080i or greater (p = <a href="#">Progressive</a>, i = <a href="#">Interlace</a>)</li> <li>• Screen <a href="#">Aspect Ratio</a> of 16:9</li> </ul>
<b>Interlace</b>	A method of image scanning whereby the image data is divided into fine horizontal lines that are displayed in sequence starting from left to right and then from top to bottom. The even-numbered lines and odd-numbered lines are displayed alternately.
<b>Progressive</b>	A method of image scanning whereby the image data from a single image is scanned sequentially from top to bottom to create a single image.
<b>Refresh Rate</b>	The light-emitting element of a display maintains the same luminosity and color for an extremely short time. Because of this, the image must be scanned many times per second to refresh the light-emitting element. The number of refresh operations per second is called the Refresh Rate and is expressed in hertz (Hz).
<b>SDTV</b>	Abbreviation for Standard Definition Television that refers to standard television systems which do not satisfy the conditions for <a href="#">HDTV</a> High-Definition Television.
<b>sRGB</b>	An international standard for color intervals that was formulated so that colors that are reproduced by video equipment can be handled easily by computer operating systems (OS) and the Internet. If the connected source has an sRGB mode, set both the projector and the connected signal source to sRGB.
<b>SVGA</b>	A type of video signal with a resolution of 800 (horizontal) × 600 (vertical) dots that is used by IBM PC/AT-compatible computers.

<b>S-Video</b>	A Video signal which has the luminance component and color component separated to provide better image quality. Refers to images that consist of two independent signals: Y (luminance signal) and C (color signal).
<b>SXGA</b>	A type of video signal with a resolution of 1,280 (horizontal) × 1,024 (vertical) dots that is used by IBM PC/AT-compatible computers.
<b>Sync.</b>	The signals output from computers have a specific frequency. If the projector frequency does not match this frequency, the resulting images are not of a good quality. The process of matching the phases of these signals (the relative position of the crests and the troughs in the signal) is called Synchronization. If the signals are not synchronized, flickering, blurriness, and horizontal interference occur.
<b>Tracking</b>	The signals output from computers have a specific frequency. If the projector frequency does not match this frequency, the resulting images are not of a good quality. The process of matching the frequency of these signals (the number of crests in the signal) is called Tracking. If Tracking is not carried out correctly, wide vertical stripes appear in the signal.
<b>VGA</b>	A type of video signal with a resolution of 640 (horizontal) × 480 (vertical) dots that is used by IBM PC/AT-compatible computers.
<b>XGA</b>	A type of video signal with a resolution of 1,024 (horizontal) × 768 (vertical) dots that is used by IBM PC/AT-compatible computers.

All rights reserved. No part of this publication may be reproduced, stored in a retrieval system, or transmitted in any form or by any means, electronic, mechanical, photocopying, recording, or otherwise, without the prior written permission of Seiko Epson Corporation. No patent liability is assumed with respect to the use of the information contained herein. Neither is any liability assumed for damages resulting from the use of the information contained herein.

Neither Seiko Epson Corporation nor its affiliates shall be liable to the purchaser of this product or third parties for damages, losses, costs, or expenses incurred by the purchaser or third parties as a result of: accident, misuse, or abuse of this product or unauthorized modifications, repairs, or alterations to this product, or (excluding the U.S.) failure to strictly comply with Seiko Epson Corporation's operating and maintenance instructions.

Seiko Epson Corporation shall not be liable against any damages or problems arising from the use of any options or any consumable products other than those designated as Original Epson Products or Epson Approved Products by Seiko Epson Corporation.

The contents of this guide may be changed or updated without further notice.

Illustrations in this guide and the actual projector may differ.

## General Notice:

Windows Vista and the Windows logo are trademarks of the Microsoft group of companies.

IBM, DOS/V, and XGA are trademarks or registered trademarks of International Business Machines Corporation.

Macintosh, Mac, and iMac are trademarks of Apple Inc.

Windows, Windows NT, and PowerPoint are trademarks or registered trademarks of Microsoft Corporation in the United States.

Dolby is a trademark of Dolby Laboratories.

HDMI and High-Definition Multimedia Interface are the trademarks or registered trademarks of HDMI Licensing LLC. **HDMI**  
HIGH DEFINITION MULTIMEDIA INTERFACE

©SEIKO EPSON CORPORATION 2009. All rights reserved.



**Discount-Merchant.com (800) 281-8860**  
**THE TRUSTED SOURCE FOR PROJECTOR LAMPS AND ACCESSORIES**

- A**
- A/V Mute ..... 25
  - Air exhaust vent ..... 9
  - Air filter replacement period ..... 77
  - Air intake vent ..... 9
  - Angle of tilt ..... 97
  - Appearance ..... 99
  - Aspect ..... 27, 51
  - Audio Out port ..... 11, 12
  - Audio port ..... 11, 12
  - Audio-L/R port ..... 10
  - Auto Iris ..... 25
  - Auto Setup ..... 50
- B**
- Blackboard ..... 24
  - Brightness ..... 49
- C**
- Ceiling ..... 53
  - Ceiling mount fixing points ..... 13
  - Cleaning the Air filter and Air intake vent ..... 72
  - Cleaning the Projector's Surface ..... 71
  - Color Adjustment ..... 49
  - Color Mode ..... 24, 49
  - Color Saturation ..... 49
  - Computer input port ..... 10, 11, 12
  - Configuration Menu ..... 48
  - Connecting and Removing USB Devices ..... 41
  - Consumables ..... 79
- Contrast** ..... 49
- Control Panel** ..... 13, 14
- Control Panel Lock** ..... 39, 52
- Cross** ..... 33
- D**
- Direct Power On ..... 54
  - Display ..... 53
  - Display Background ..... 53
  - Distance ..... 82
  - Dynamic ..... 24
- E**
- ESC/VP21 ..... 87
  - Extended Menu ..... 53
  - E-Zoom ..... 33
- F**
- Focus ring ..... 9
  - Freeze ..... 26
  - Front ..... 53
  - Front adjustable foot ..... 9
  - Full Lock ..... 39
- H**
- HDMI input port ..... 10
  - HDMI Video Range ..... 51
  - Help function ..... 58
  - High Altitude Mode ..... 54
  - How to replace the air filter ..... 77
  - How to replace the lamp ..... 74
- I**
- Image Menu ..... 49
  - Info Menu ..... 55
  - Input Signal ..... 51, 55
- K**
- Keystone ..... 52
- L**
- Lamp Hours ..... 55
  - Lamp replacement period ..... 74
  - Language ..... 54
  - Link 21 ..... 54, 87
- M**
- Messages ..... 53
  - Monitor Displays ..... 88
  - Monitor Out port ..... 12
- O**
- Operating temperature ..... 96
  - Operation ..... 54
  - Optional accessories ..... 79
  - Overheating ..... 60
- P**
- Page Up/Down ..... 36
  - Part Names and Functions ..... 9
  - Password Protect ..... 37
  - Password protect sticker ..... 37
  - Photo ..... 24



Pointer ..... 32  
 Pointer Shape ..... 52  
 Position ..... 50  
 Power Consumption ..... 52  
 Power inlet ..... 10, 11, 12  
 Power On Protect ..... 37  
 Presentation ..... 24  
 Problem Solving ..... 59  
 Progressive ..... 51  
 Projection ..... 53

**R**

Rear ..... 53  
 Rear foot ..... 13  
 Rear screen ..... 70  
 Refresh Rate ..... 55  
 Remote Control ..... 15  
 Remote Receiver ..... 9, 10, 11, 12  
 Replacing batteries ..... 73  
 Reset All ..... 56  
 Reset Menu ..... 56  
 Resetting the lamp operating time ..... 56, 77  
 Resolution ..... 55

**S**

Screen size ..... 82  
 Security slot ..... 9  
 Settings Menu ..... 52  
 Sharpness ..... 49  
 Signal Menu ..... 50  
 Sleep Mode ..... 54  
 Slideshow ..... 41  
 Source ..... 55

Source Search ..... 13, 14, 22  
 Specifications ..... 96  
 Sports ..... 24  
 sRGB ..... 24  
 Standby Mode ..... 54  
 Startup Screen ..... 53  
 Storage temperature ..... 96  
 Supported Monitor Displays ..... 88  
 S-Video input port ..... 10, 11, 12  
 Sync Info ..... 55  
 Sync. .... 50

**T**

Theatre ..... 24  
 Tint ..... 49  
 Tracking ..... 50

**U**

USB(TypeA) port ..... 10  
 USB(TypeB) port ..... 10, 11, 12  
 User's Logo ..... 80  
 User's Logo Protect ..... 37

**V**

Video Input Port ..... 10, 11, 12  
 Video Signal ..... 51, 55  
 Volume ..... 52

**W**

Whiteboard ..... 24  
 Wide-screen projection ..... 27  
 Wireless Mouse ..... 34

**Z**

Zoom ring ..... 9

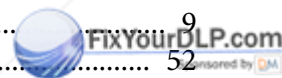

Discount-Merchant.com (800) 281-8860  
 THE TRUSTED SOURCE FOR PROJECTOR LAMPS AND ACCESSORIES



# Disclaimer

This user manual is provided as a free service by FixYourDLP.com. FixYourDLP is in no way responsible for the content of this manual, nor do we guarantee its accuracy. FixYourDLP does not make any claim of copyright and all copyrights remain the property of their respective owners.

About FixYourDLP.com

FixYourDLP.com (<http://www.fixyourdpl.com>) is the World's #1 resource for media product news, reviews, do-it-yourself guides, and manuals.

Informational Blog: <http://www.fixyourdpl.com>

Video Guides: <http://www.fixyourdpl.com/guides>

User Forums: <http://www.fixyourdpl.com/forum>

FixYourDLP's Fight Against Counterfeit Lamps:

<http://www.fixyourdpl.com/counterfeits>

## Sponsors:

RecycleYourLamp.org – Free lamp recycling services for used lamps:

<http://www.recycleyourlamp.org>

Lamp Research - The trusted 3rd party lamp research company:

<http://www.lampresearch.com>

Discount-Merchant.com – The worlds largest lamp distributor:

<http://www.discount-merchant.com>



**FixYourDLP.com**

Sponsored by 