



Disclaimer

This user manual is provided as a free service by FixYourDLP.com. FixYourDLP is in no way responsible for the content of this manual, nor do we guarantee its accuracy. FixYourDLP does not make any claim of copyright and all copyrights remain the property of their respective owners.

About FixYourDLP.com

FixYourDLP.com (<http://www.fixyourdpl.com>) is the World's #1 resource for media product news, reviews, do-it-yourself guides, and manuals.

Informational Blog: <http://www.fixyourdpl.com>

Video Guides: <http://www.fixyourdpl.com/guides>

User Forums: <http://www.fixyourdpl.com/forum>

FixYourDLP's Fight Against Counterfeit Lamps:

<http://www.fixyourdpl.com/counterfeits>

Sponsors:

RecycleYourLamp.org – Free lamp recycling services for used lamps:

<http://www.recycleyourlamp.org>

Lamp Research - The trusted 3rd party lamp research company:

<http://www.lampresearch.com>

Discount-Merchant.com – The worlds largest lamp distributor:

<http://www.discount-merchant.com>



FixYourDLP.com

Sponsored by 



User's Guide

Multimedia Projector

EB-1925W

EB-1920W

EB-1915

EB-1910

EB-1900

EB-1830

 FixYourDLP.com
Sponsored by 



Discount-Merchant.com (800) 281-8860

TRUSTED SOURCE FOR PROJECTOR LAMPS AND ACCESSORIES





Notations Used in This Guide

- **Safety indications**

The documentation and the projector use graphical symbols to show how to use the projector safely. Please understand and respect these caution symbols in order to avoid injury to persons or property.

 Warning	This symbol indicates information that, if ignored, could possibly result in personal injury or even death due to incorrect handling.
 Caution	This symbol indicates information that, if ignored, could possibly result in personal injury or physical damage due to incorrect handling.

- **General information indications**

Attention	Indicates procedures which may result in damage or injury if sufficient care is not taken.
	Indicates additional information and points which may be useful to know regarding a topic.
	Indicates a page where detailed information regarding a topic can be found.
	Indicates that an explanation of the underlined word or words in front of this symbol appears in the glossary of terms. See the "Glossary" section of the "Appendix".  p.138
Procedure	Indicates operating methods and the order of operations. The procedure indicated should be carried out in the order of the numbered steps.
[(Name)]	Indicates the name of the buttons on the Remote Control or the Control panel. Example: [Return] button
"(Menu Name)" Brightness (bolded)	Indicates Configuration Menu items. Example: Select "Brightness" from the Image menu. Image menu - Brightness



FixYourDLP.com
Sponsored by 

Discount-Merchant.com (800) 281-8860
THE TRUSTED SOURCE FOR PROJECTOR LAMPS AND ACCESSORIES



Notations Used in This Guide..... 2

Introduction

Projector Features.....	7
Features Common to Each Model.	7
Easy to handle.	7
Connecting with a USB cable and Projecting (USB Display).	7
Enlarge and project your files with the Document Camera (EB-1925W/1920W/1915/1910/1830 only).	7
Enhanced security functions.	7
EB-1925W/1915 Features.	8
Set up for presentations in no time.	8
Taking full advantage of a network connection.	8
EB-1920W/1910/1830 Features.	9
Taking full advantage of a network connection.	9
Projecting JPEG images without connecting a computer (Slideshow).	9
Part Names and Functions.....	10
Front/Top.	10
Rear (EB-1925W/1915).	11
Rear (EB-1920W/1910/1830).	13
Rear (EB-1900).	14
Base.	15
Control Panel (EB-1925W/1915).	16
Control Panel (EB-1920W/1910/1830).	17
Control Panel (EB-1900).	18
Remote Control.	19

Useful Functions

Correcting the Projected Image Using Screen Fit (EB-1925W/1915 Only).....	23
Correcting Distortions in the Projected Image Using Quick Corner (EB-1925W/1915 Only).....	26
Changing the Projected Image.....	29
Automatically Detect Input Signal and Change the Projected Image (Source Search)	29
Switch to the target image by Remote Control.	30
Functions for Enhancing Projection.....	31
Selecting the Projection Quality (Selecting Color Mode).	31
Setting the Auto Iris.	32
Hiding the Image and Sound Temporarily (A/V Mute).	32
Freezing the Image (Freeze).	33
Changing the Aspect Ratio.	33
Changing methods.	34
Changing the Aspect for video equipment images.	34
Changing the aspect for computer images (EB-1915/1910/1900/1830).	35
Changing the Aspect for computer images (EB-1925W/1920W).	36
Pointer Function (Pointer).	38
Enlarging Part of the Image (E-Zoom).	39
Operating the Mouse Pointer by Remote Control (Wireless Mouse).	40
Limitation of the Number of the Target Projectors when Using Multiple Projectors.....	42
Setting the Projector ID.	42
Setting the Remote Control ID.	43
Correcting Color for Multiple Projectors (Multi-Screen Color Adjustment).....	45
Summary of Correction Procedure.	45
Correction Method.	45
Security Functions.....	47
Managing Users (Password Protect).	47



Discount-Merchant.com (800) 281-8860
 THE TRUSTED SOURCE FOR PROJECTOR LAMP AND ACCESSORIES

Type of Password Protect.	47
Setting Password Protect.	47
Entering the Password.	48
Restricting Operation (Control Panel Lock).	49
Anti-Theft Lock.	50
Installing the wire lock.	50

Configuration Menu

Using the Configuration Menu.	52
--	-----------

List of Functions.	53
-----------------------------------	-----------

Image Menu.	53
Signal Menu.	54
Settings Menu.	56
Extended Menu.	58
Network Menu (EB-1925W/1915 Only).	60
Notes on operating the Network menu.	61
Soft keyboard operations.	61
Basic Menu.	62
Wireless LAN menu (only when the supplied or optional Wireless LAN unit is inserted).	63
Security menu (available when the supplied or optional Wireless LAN unit is inserted).	64
When WEP is selected.	66
When WPA-PSK(TKIP/AES) or WPA2-PSK(TKIP/AES) is selected.	67
When EAP-TLS is selected.	68
When EAP-TTLS/MD5, EAP-TTLS/MS-CHAPv2, PEAP/MS-CHAPv2, PEAP/GTC, LEAP, EAP-Fast/MS-CHAPv2, EAP-Fast/GTC is selected.	68
Wired LAN Menu.	68
Mail menu.	69
Others Menu.	70
Reset menu.	71
Network Menu (EB-1920W/1910/1830 Only).	72
Notes on operating the Network menu.	73
Soft keyboard operations.	73
Basic menu.	74
Wired LAN menu.	75

Mail menu.	76
Others menu.	77
Reset menu.	78
Info Menu (Display Only).	79
Reset Menu.	80

Troubleshooting

Using the Help.	82
--------------------------------	-----------

Problem Solving.	83
---------------------------------	-----------

Reading the Indicators.	83
⏻ Indicator is lit or flashing red.	84
🔔 Indicator is lit or flashing orange.	85
When the Indicators Provide No Help.	86
Problems relating to images.	87
Problems when projection starts.	91
Other problems.	92

Appendix

Installation Methods.	95
--------------------------------------	-----------

Cleaning.	96
--------------------------	-----------

Cleaning the Projector's Surface.	96
Cleaning the Lens.	96
Cleaning the Air filter.	97

Replacing Consumables.	98
---------------------------------------	-----------

Replacing the Remote Control Batteries.	98
Replacing the Lamp.	99
Lamp replacement period.	99
How to replace the Lamp.	99
Resetting the lamp hours.	102
Replacing the Air Filter.	102
Air filter replacement period.	102



Discount-Merchant.com (800) 281-8860
 THE TRUSTED SOURCE FOR PROJECTOR LAMPS AND ACCESSORIES

How to replace the air filter. 102

Optional Accessories and Consumables. 104

 Optional accessories. 104

 Consumables. 104

Saving a User's Logo. 105

Connecting to a Wireless LAN Access Point Using Wi-Fi Protected Setup (EB-1925W/1915 Only). 107

 Connection Setup Method. 107

 Connecting Using the Push Button Method. 108

 Connecting Using the PIN Code Method. 109

Screen Size and Projection Distance. 111

 Projection Distance (EB-1925W/1920W). 111

 Projection Distance (EB-1915/1910/1900/1830). 112

Connecting and Removing USB Devices (EB-1925W/1920W/1915/1910/1830 Only). 113

 Connecting USB Devices. 113

 Removing USB Devices. 114

 Connecting the Document Camera (ELPDC06). 114

 Removing the Document Camera (ELPDC06). 114

Connecting with a USB Cable and Projecting (USB Display). 115

 Operating Conditions for USB Display. 115

 Connecting. 115

 Connecting for the first time. 116

 From the second time. 117

Connecting LAN Cable (EB-1925W/1920W/1915/1910/1830 Only). 118

Connecting to External Equipment. 119

 Connecting to an External Monitor (EB-1925W/1920W/1915/1910/1830 Only). 119

 Connecting to an External Speaker (EB-1925W/1920W/1915/1910/1830 Only). 120

Reading Problem Mail Notification Function (EB-1925W/1920W/1915/1910/1830 Only). 121

ESC/VP21 Commands. 122

 Command List. 122

 Cable Layouts. 122

 Serial Connection. 122

 Communications protocol. 123

About Network Projector (EB-1925W/1915 Only). 124

About PJLink (EB-1925W/1920W/1915/1910/1830 Only). 125

Supported Monitor Displays. 126

 Supported Monitor Displays (EB-1925W/1920W). 126

 Computer signals (analog RGB). 126

 Component Video. 127

 Composite video/S-video. 127

 Input signal from the HDMI input port (EB-1925W only). 128

 Supported Monitor Displays (EB-1915/1910/1900/1830). 129

 Computer signals (analog RGB). 129

 Component video. 130

 Composite video/S-video. 130

 Input signal from the HDMI input port (EB-1915 only). 130

Specifications. 132

 Projector General Specifications. 132

 Software Requirements (EB-1925W/1920W/1915/1910/1830 Only). 135

Appearance. 137

Glossary. 138

General Notes. 140

 General Notice. 140

Index. 157

Discount-Merchant.com (800) 281-8860
 Sponsored by  THE TRUSTED SOURCE FOR PROJECTOR LAMPS AND ACCESSORIES



Introduction

This chapter explains the projector's features and the part names.





Discount-Merchant.com (800) 281-8860
THE TRUSTED SOURCE FOR PROJECTOR LAMPS AND ACCESSORIES

Features Common to Each Model

Easy to handle

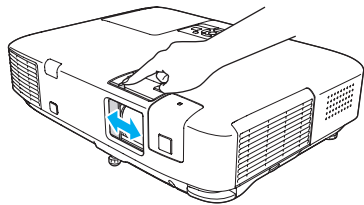
- **The A/V mute slide makes it easy to project and store**
You can stop and resume projection easily by opening and closing the A/V mute slide which makes giving clear presentations easier.



- **A single foot design means you do not have to make any difficult leveling adjustments**
You can easily make height adjustments with one lever.  [Quick Start Guide](#)

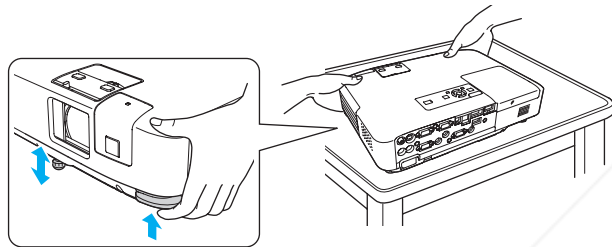

- **Direct power On/Off**
In places where power is managed centrally, such as in a conference room, the projector can be set to power on and off automatically when the power source to which the projector is connected is switched on or off.

Connecting with a USB cable and Projecting (USB Display)

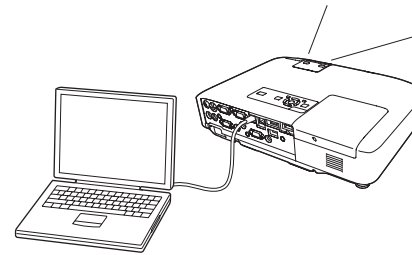

Simply by connecting the projector to a Windows Computer with the USB cable, you can project images from the computer screen.



Enlarge and project your files with the Document Camera (EB-1925W/1920W/1915/1910/1830 only)

A USB compatible Document Camera (ELPDC06) is available as an optional extra. This Document Camera does not require a power cable, and you can connect it easily with one USB cable. With its simple design, this easy-to-use Document Camera allows you to easily project and enlarge your hard documents.  [Optional Accessories and Consumables](#)

Enhanced security functions

- **Password Protect to restrict and manage users**
By setting a Password you can restrict who can use the projector.  [p.47](#)
- **Control Panel Lock restricts button operation on the Control panel**
You can use this to prevent people changing projector settings without permission at events, in schools, and so on.  [p.49](#)

EB-1925W/1915 Features

Set up for presentations in no time

- **No need for time-consuming adjustment of the projected images (Auto H/V-Keystone function)**
This projector automatically corrects keystone distortions and focus problems which occur when positioning or moving the projector, eliminating the hassle of manually adjusting the projected image.
- **Quick setup with one button (Screen Fit)**
Just by pressing the Screen Fit button, you can adjust the projected image to an optimal setting for the screen. This enables you to quickly set up for presentations that uses a screen.
- **Presentations without a computer (PC Free)**
You can project images and movies directly from a USB storage device or a digital camera by connecting it to the projector, enabling you to deliver presentations without using a computer. You can deliver an effective presentation by converting a PowerPoint file to scenarios, using the included application software EasyMP Slide Converter, saving it to a USB storage device and projecting from it.
☛ [Projector Operation Guide](#) (EB-1925W/1915)

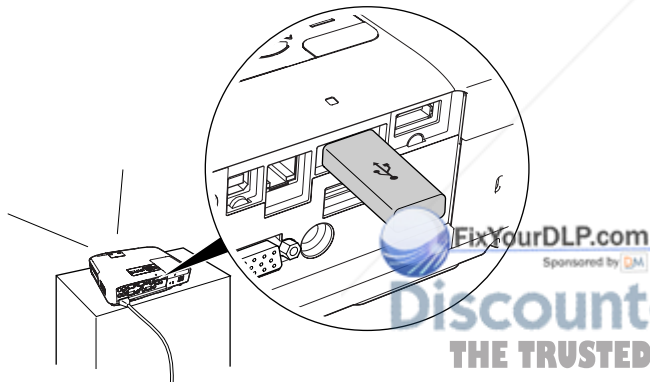

Taking full advantage of a network connection

- You can make effective use of your network by using the supplied "EPSON Projector Software for Meeting & Presentation" to perform efficient and varied presentations and meetings. ☛ [Projector Operation Guide](#) (EB-1925W/1915)
- **Transferring images and audio using the network (EasyMP Network Projection)**
You can project by connecting to an already constructed network system. You can hold efficient meetings by projecting from multiple computers connected to a network system without having to change any cables.
With the ability to transfer and play movies and audio on the projector, the contents of your presentation can now come from a wide range of sources.
 - **Support for Windows Vista Network Projector function**
By connecting the projector to a network and using the Network Projector function in Windows Vista, multiple users on the network can share the projector.
 - **Connect with Quick Wireless Connection USB Key**
By saving the projector information onto the optional Quick Wireless Connection USB Key and inserting it to a computer on the network, you can easily transfer images and audio from the computer and play them on the projector. ☛ [Optional Accessories and Consumables](#)

EB-1920W/1910/1830 Features

Taking full advantage of a network connection

You can make effective use of your network by using the supplied "EPSON Projector Software for Meeting & Monitoring" and collectively manage the projectors in different meeting rooms.

- **Screen transfer using the network** (EasyMP Network Projection)

You can project by connecting to an already constructed network system. You can hold efficient meetings by projecting from multiple computers connected to a network system without having to change any cables.

- **Connect with Quick Wireless Connection USB Key**

By saving the projector information onto the optional Quick Wireless Connection USB Key and inserting it to a computer on the network, you can easily transfer images from the computer over the network and project them from the projector. ➡ [Optional Accessories and Consumables](#)

Projecting JPEG images without connecting a computer (Slideshow)

You can project a slideshow of JPEG images saved on a USB device such as a USB storage device or a USB compatible digital camera, by simply connecting to the projector. ➡ [Projector Operation Guide](#) (EB-1920W/1910/1830)





Discount-Merchant.com (800) 281-8860
THE TRUSTED SOURCE FOR PROJECTOR LAMPS AND ACCESSORIES





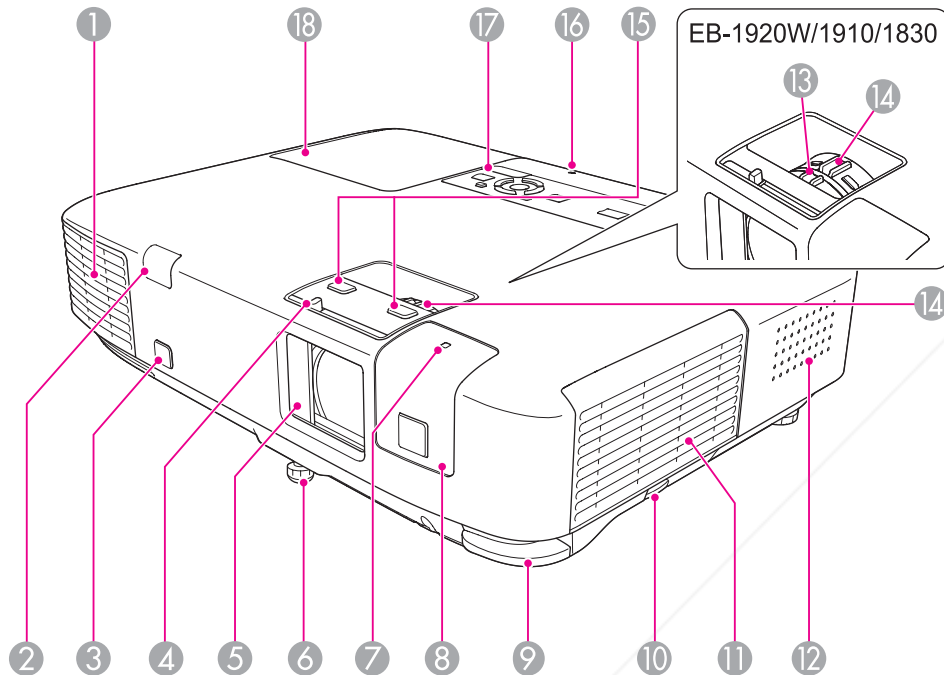



Front/Top

The illustration is that of EB-1925W/1915.

From here on, all features will be explained using illustrations of EB-1925W/1915 unless otherwise mentioned.



Name	Function
1 Air exhaust vent	Exhaust vent for air used to cool the projector internally.
 Caution Do not place objects that may become warped or otherwise affected by heat near the Air exhaust vent and do not put your face or hands near the vent while projection is in progress.	







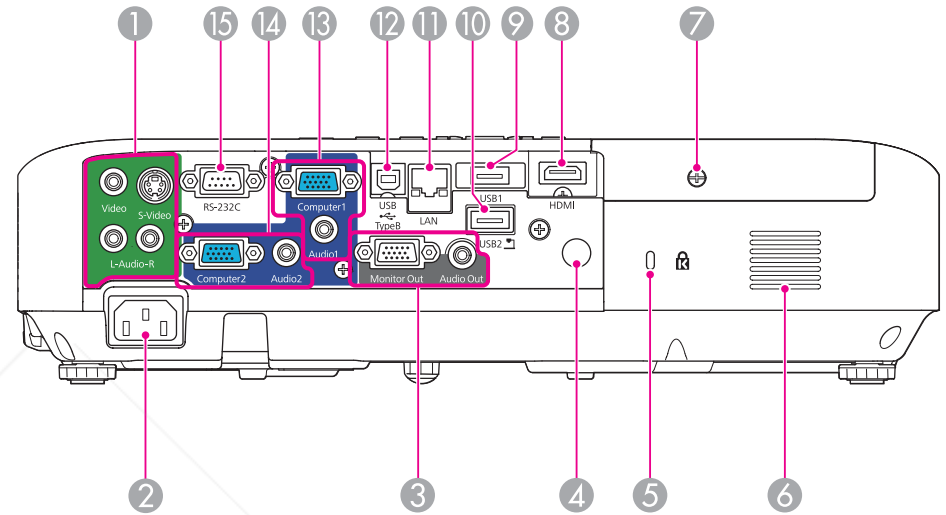



Name	Function
2 Remote Receiver	Receives signals from the remote control.  Quick Start Guide
3 Sensor (EB-1925W/1915 only)	Takes measurements when the projector automatically corrects the projected image.
4 A/V mute slide knob	Slide the knob to open and close the A/V mute slide.
5 A/V mute slide	Close when not using the projector to protect the lens. By closing during projection you can hide the image and the sound (only the image, when using EB-1900) (A/V Mute).  p.32
6 Front adjustable foot	Extend and adjust the position of the projected image when the projector is placed on a surface such as a desk.  Quick Start Guide
7 Wireless LAN indicator (EB-1925W/1915 only)	Displays the access status of the supplied or optional Wireless LAN unit.
8 Wireless LAN unit cover (EB-1925W/1915 only)	When making a wireless connection between the projector and computer, remove this cover to install the included or optional wireless LAN unit.
9 Foot adjust lever	Pull the Foot adjust lever to extend and retract the Front adjustable foot.  Quick Start Guide
10 Air filter cover latch	Opens the Air filter cover.  p.102
11 Air intake vent (Air filter)	Takes in air to cool the projector internally. If dust collects here it can cause the internal temperature to rise, and this can lead to problems with operation and shorten the optical engine's service life. Be sure to clean the Air filter regularly.  p.97, p.102
12 Speaker (EB-1925W/1920W/1915/1910/1830 only)	
13 Focus ring (EB-1920W/1910/1900/1830 only)	Adjusts the image focus.  Quick Start Guide
14 Zoom ring	Adjusts the image size.  Quick Start Guide



Name	Function
15 Focus buttons (EB-1925W/1915 only)	Press these buttons to adjust the image focus. ☛ <i>Quick Start Guide</i>
16 USB indicator	The following explains the status of any USB device connected to USB1 port (EB-1925W/1915 only) or USB(TypeA) port (EB-1920W/1910/1830 only). OFF: USB device is not connected Orange Light ON: USB device is connected Green Light ON: USB device is operating Red Light ON: Error
17 Control panel	☛ p.16
18 Lamp cover	Open this cover when replacing the projector's Lamp. ☛ p.99

Rear (EB-1925W/1915)



Name	Function
1 Video Input Port S-Video Input Port Audio-L/R port	For composite video signals from video sources. For S-video signals from video sources. Connects to the audio out port when you want to output audio from equipment connected to the S-Video Input Port or the Video Input Port. ☛ <i>Quick Start Guide</i>
2 Power inlet	Connects to the power cable. ☛ <i>Quick Start Guide</i>
3 Monitor Out port Audio Out port	Outputs to an external monitor the image signal from the computer connected to the Computer1 input port. This is not available for component video signals or other signals being input to any port other than the Computer1 input port. ☛ p.119 Outputs the sound of the image currently being projected to external speakers. ☛ p.120

Name	Function
④ Remote Receiver	Receives signals from the remote control.  Quick Start Guide
⑤ Security slot	The Security slot is compatible with the Microsaver Security System manufactured by Kensington.  p.50
⑥ Air intake vent	Takes in air to cool the projector internally. If dust collects here it can cause the internal temperature to rise, and this can lead to problems with operation and shorten the optical engine's service life. Be sure to clean the Air intake vent regularly.
⑦ Lamp Cover Fixing Screw	Screw to fix the Lamp cover in place.  p.99
⑧ HDMI input port	Inputs video signals from HDMI compatible video equipment and computers. This projector is compatible with HDCP  .  Quick Start Guide
⑨ USB1 port	Connects a USB storage device or a digital camera, and projects images, movie files, and scenarios using PC Free.  Projector Operation Guide (EB-1925W/1915)
⑩ USB2 port	Connect the optional Document Camera (ELPDC06) here. This is a dedicated port for the Document Camera, and does not support other devices.
⑪ LAN port	Connects to a LAN cable and then to a network.  p.118
⑫ USB(TypeB) port	Connects the projector to a computer via the USB cable, and the image on the computer is projected.  p.115 Also use this port to connect to a computer via the USB cable to use the wireless mouse function.  p.40
⑬ Computer1 Input Port	For video signals from a computer and component video signals from other video sources.
Audio1 Port	Connects to the audio out port when you want to output audio from equipment connected to the Computer1 Input Port.  Quick Start Guide

Name	Function
⑭ Computer2 Input Port	For video signals from a computer and component video signals from other video sources.
Audio2 Port	Connects to the audio out port when you want to output audio from equipment connected to the Computer2 Input Port.  Quick Start Guide Also, when inputting audio from an audio source that is different from the image source, connect it to Audio2 port.
⑮ RS-232C Port	When controlling the projector from a computer, connect it to the computer with an RS-232C cable. This port is for control use and should not normally be used.  p.122

Rear (EB-1920W/1910/1830)

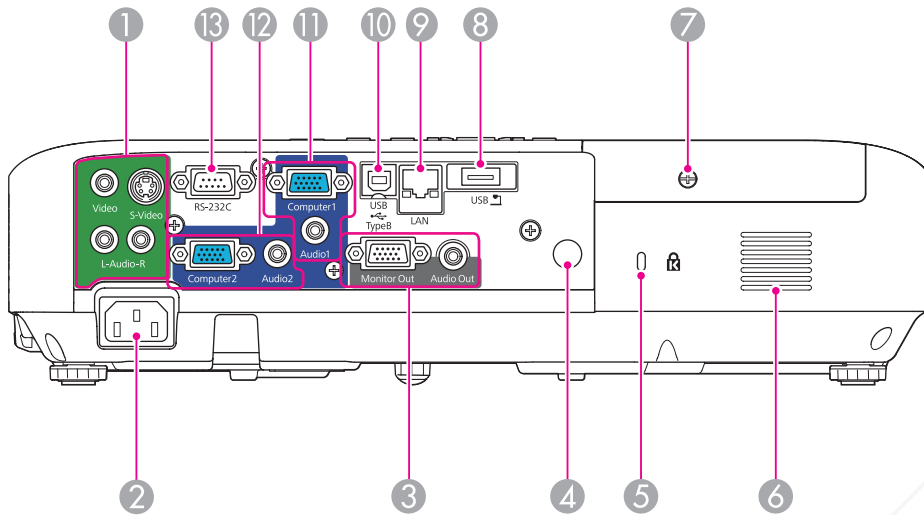

Name	Function
1 Video Input Port S-Video Input Port Audio-L/R port	For composite video signals from video sources. For S-video signals from video sources. Connects to the audio out port when you want to output audio from equipment connected to the S-Video Input Port or the Video Input Port. ☛ <i>Quick Start Guide</i>
2 Power inlet	Connects to the power cable. ☛ <i>Quick Start Guide</i>
3 Monitor Out port	Outputs to an external monitor the image signal from the computer connected to the Computer1 input port. This is not available for component video signals or other signals being input to any port other than the Computer1 input port. ☛ <i>p.119</i>
Audio Out port	Outputs the sound of the image currently being projected to external speakers. ☛ <i>p.120</i>



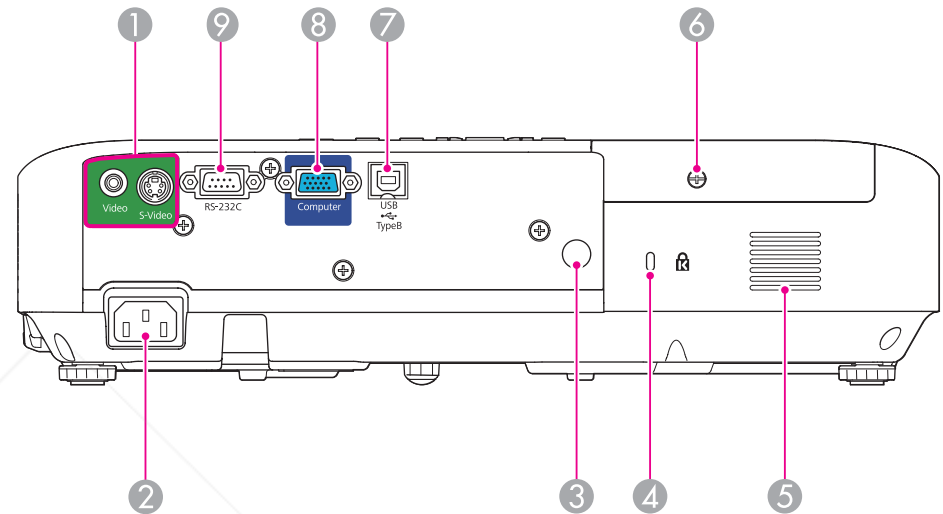

Name	Function
4 Remote Receiver	Receives signals from the remote control. ☛ <i>Quick Start Guide</i>
5 Security slot	The Security slot is compatible with the Microsaver Security System manufactured by Kensington. ☛ <i>p.50</i>
6 Air intake vent	Takes in air to cool the projector internally. If dust collects here it can cause the internal temperature to rise, and this can lead to problems with operation and shorten the optical engine's service life. Be sure to clean the Air intake vent regularly.
7 Lamp Cover Fixing Screw	Screw to fix the Lamp cover in place. ☛ <i>p.99</i>
8 USB(TypeA) port	Connects a USB storage device or a digital camera, and projects JPEG images in a Slideshow. ☛ <i>Projector Operation Guide</i> (EB-1920W/1910) Also connect the optional Document Camera (ELPDC06) here.
9 LAN port	Connects a LAN cable to connect to a network. ☛ <i>p.118</i>
10 USB(TypeB) port	Connects the projector to a computer via the USB cable, and the image on the computer is projected. ☛ <i>Quick Start Guide</i> Also use this port to connect to a computer via the USB cable to use the wireless mouse function. ☛ <i>p.40</i>
11 Computer1 Input Port Audio1 Port	For video signals from a computer and component video signals from other video sources. Connects to the audio out port when you want to output audio from equipment connected to the Computer1 Input Port. ☛ <i>Quick Start Guide</i>

Name	Function
<p>12 Computer2 Input Port</p> <p>Audio2 Port</p>	<p>For video signals from a computer and component video signals from other video sources.</p> <p>Connects to the audio out port when you want to output audio from equipment connected to the Computer2 Input Port. <i>Quick Start Guide</i></p> <p>Also, when inputting audio from an audio source that is different from the image source, connect it to Audio2 port.</p>
13 RS-232C Port	<p>When controlling the projector from a computer, connect it to the computer with an RS-232C cable. This port is for control use and should not normally be used. <i>p.122</i></p>

Rear (EB-1900)





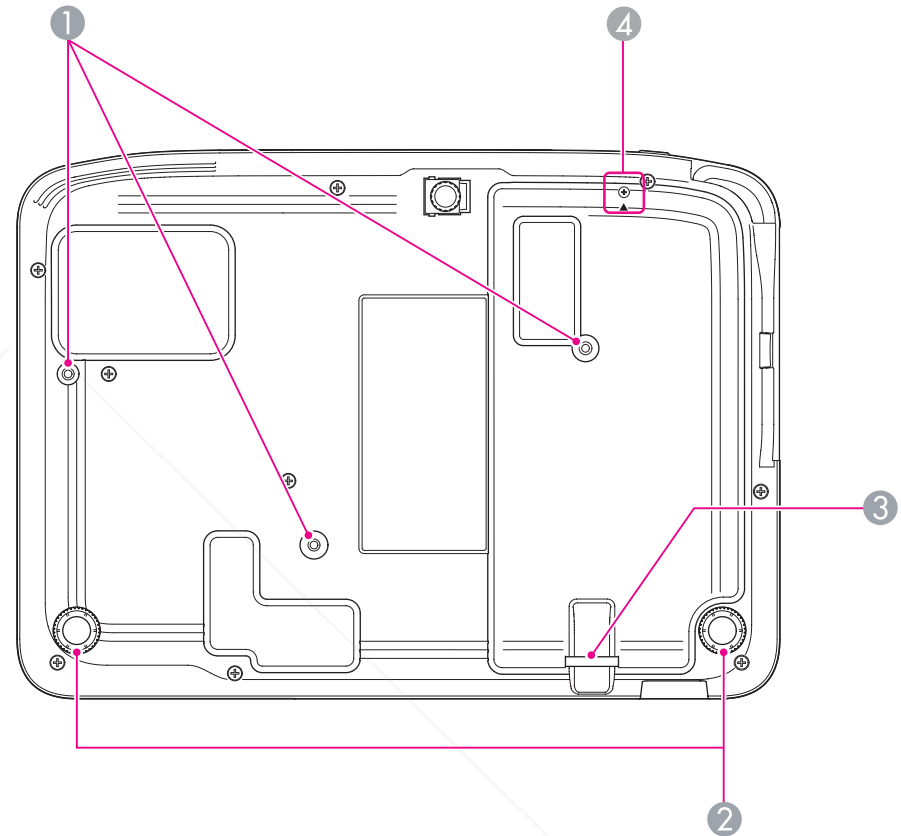

Name	Function
<p>1 Video Input Port</p> <p>S-Video Input Port</p>	<p>For composite video signals from video sources.</p> <p>For S-video signals from video sources. <i>Quick Start Guide</i></p>
2 Power inlet	Connects to the power cable. <i>Quick Start Guide</i>
3 Remote Receiver	Receives signals from the remote control. <i>Quick Start Guide</i>
4 Security slot	The Security slot is compatible with the Microsaver Security System manufactured by Kensington. <i>p.50</i>
5 Air intake vent	Takes in air to cool the projector internally. If dust collects here it can cause the internal temperature to rise, and this can lead to problems with operation and shorten the optical engine's service life. Be sure to clean the Air intake vent regularly.
6 Lamp Cover Fixing Screw	Screw to fix the Lamp cover in place. <i>p.99</i>

Name	Function
7 USB(TypeB) port	Connects the projector to a computer via the USB cable, and the image on the computer is projected.  p.115 Also use this port to connect to a computer via the USB cable to use the wireless mouse function.  p.40
8 Computer Input Port	For video signals from a computer and component video signals from other video sources.  Quick Start Guide
9 RS-232C Port	When controlling the projector from a computer, connect it to the computer with an RS-232C cable. This port is for control use and should not normally be used.  p.122

Base









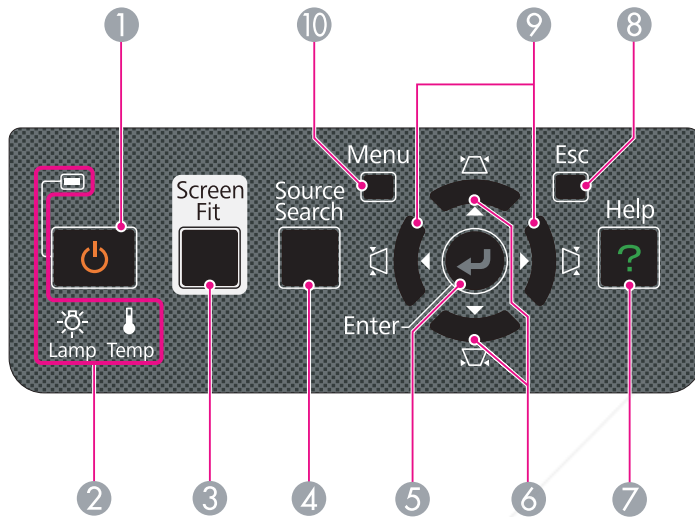

Name	Function
1 Ceiling mount fixing points (3 points)	Attach the optional Ceiling mount here when suspending the projector from a ceiling.  p.95, p.104
2 Rear foot	When setup on a desk, turn to extend and retract to adjust the horizontal tilt.  Quick Start Guide
3 Security cable installation point	Pass a commercially available wire lock through here and lock it in place.  p.50

Name	Function
4 Screw hole for the wireless LAN unit cover (EB-1925W/1915 only)	Screw hole to fix the wireless LAN unit cover.  Quick Start Guide

Control Panel (EB-1925W/1915)



Name	Function
1 [Power] button	Turns the projector power on or off.  Quick Start Guide
2 Status indicators	The color of the indicators and whether they are flashing or lit indicate the status of the projector.  p.83
3 [Screen Fit] button	Use this button to adjust the projected image so that it fits the screen frame.  p.23 This button is disabled when the projector is suspended from a ceiling.

Name	Function
4 [Source Search] button	Changes to the next input source that is connected to the projector and is sending an image.  p.29
5 [Enter] button	If pressed during projection of computer signal images, it automatically adjusts the Tracking , Sync. , and Position to project the optimum image. When a Configuration Menu or a Help screen is displayed, it accepts and enters the current selection and moves to the next level.
6 [Up/Down] buttons	Use these buttons to correct keystone distortions in vertical directions. In the following cases, however, these buttons only have the [Up] and [Down] functions. <ul style="list-style-type: none"> While projecting using the Windows Vista Network Projector function While projecting with PC Free If pressed when a Configuration Menu or a Help screen is displayed, these buttons select menu items and setting values.  p.52 , p.82
7 [Help] button	Displays and closes the Help screen which shows you how to deal with problems if they occur.  p.82
8 [Return] button	Stops the current function. If pressed when a Configuration menu is displayed, it moves to the previous menu level.  p.52
9 [Left/Right] buttons	Use these buttons to correct keystone distortions in horizontal directions. In the following cases, however, these buttons only have the [Left] and [Right] functions. <ul style="list-style-type: none"> While projecting using the Windows Vista Network Projector function While projecting with PC Free If pressed when a Configuration Menu or a Help screen is displayed, these buttons select menu items and setting values.  p.52 , p.82

Name	Function
10 [Menu] button	Displays and closes the Configuration Menu. p.52

Control Panel (EB-1920W/1910/1830)

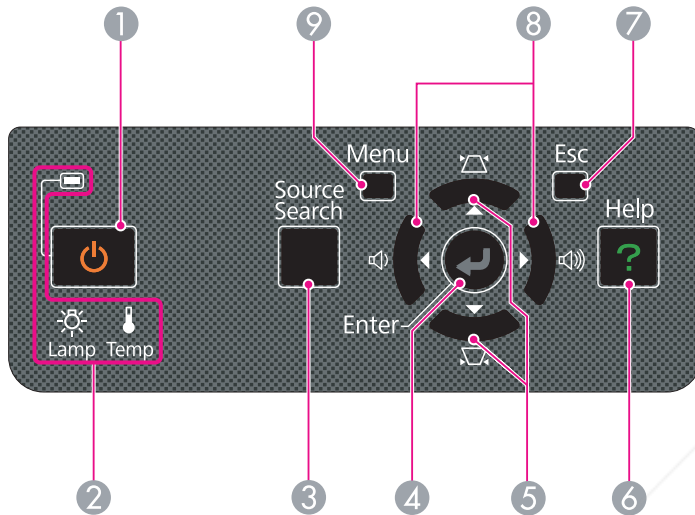

Name	Function
1 [Power] button	Turns the projector power on or off. Quick Start Guide
2 Status indicators	The color of the indicators and whether they are flashing or lit indicate the status of the projector. p.83
3 [Source Search] button	Changes to the next input source that is connected to the projector and is sending an image. p.29
4 [Enter] button	If pressing projection of computer signal images, it automatically adjusts the Tracking , Sync. , and Position to project the optimum image. When a Configuration Menu or a Help screen is displayed, it accepts and enters the current selection and moves to the next level.

Name	Function
5 [Up/Down] buttons	Use these buttons to perform keystone correction. However, these buttons only have the [Up][Down] functions while projecting in Slideshow. If pressed when a Configuration Menu or a Help screen is displayed, these buttons select menu items and setting values. p.52 , p.82
6 [Help] button	Displays and closes the Help screen which shows you how to deal with problems if they occur. p.82
7 [Esc] button	Stops the current function. If pressed when a Configuration menu is displayed, it moves to the previous menu level. p.52
8 [Left/Right] buttons	Adjusts the volume. However, these buttons only have the [Left][Right] functions while projecting in Slideshow. If pressed when a Configuration Menu or a Help screen is displayed, these buttons select menu items and setting values. Quick Start Guide , p.52
9 [Menu] button	Displays and closes the Configuration Menu. p.52

⚠ Caution

Do not start at high volume. A sudden excessive volume may cause loss of hearing. Always lower the volume before powering off, so that you can power on and then gradually increase the volume.

Control Panel (EB-1900)

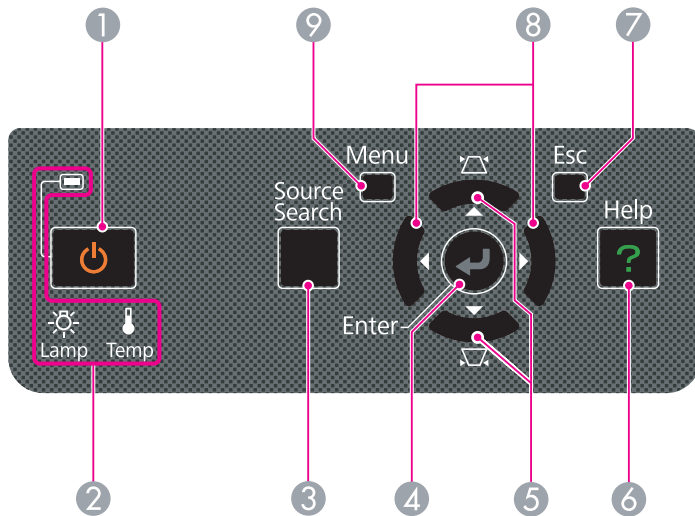







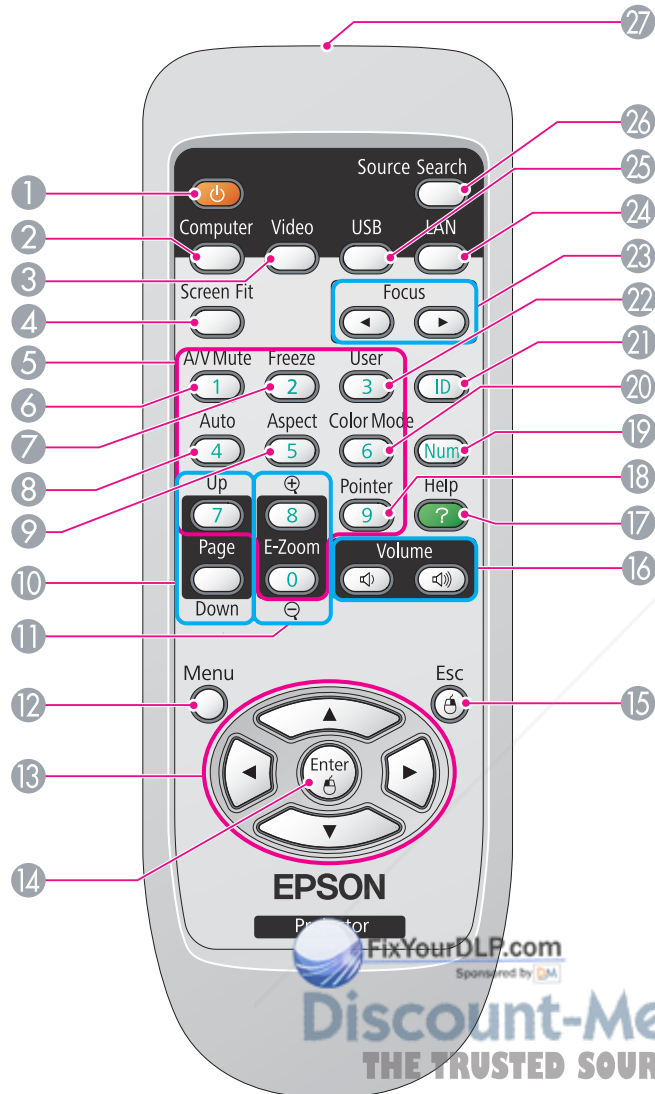

Name	Function
1 [P] button	Turns the projector power on or off. Quick Start Guide
2 Status indicators	The color of the indicators and whether they are flashing or lit indicate the status of the projector. p.83
3 [Source Search] button	Changes to the next input source that is connected to the projector and is sending an image. p.29
4 [Enter] button	If pressed during projection of computer signal images, it automatically adjusts the Tracking , Sync. , and Position to project the optimum image. When a Configuration Menu or a Help screen is displayed, it accepts and enters the current selection and moves to the next level.
5 [▲/▼][△/▽] buttons	Use these buttons to perform keystone correction. If pressed when a Configuration Menu or a Help screen is displayed, these buttons select menu items and setting values. p.52 , p.82

Name	Function
6 [Help] button	Displays and closes the Help screen which shows you how to deal with problems if they occur. p.82
7 [Esc] button	Stops the current function. If pressed when a Configuration menu is displayed, it moves to the previous menu level. p.52
8 [◀][▶] buttons	If pressed when a Configuration Menu or a Help screen is displayed, these buttons select menu items and setting values. Quick Start Guide , p.52
9 [Menu] button	Displays and closes the Configuration Menu. p.52

Remote Control



Name	Function
① [Power] button	Turns the projector power On or Off.  Quick Start Guide
② [Computer] button	Each time the button is pressed, the image changes from the Computer1 input port to the Computer2 input port. (EB-1925W/1920W/1915/1910/1830 only) When using EB-1900, it changes to images from the Computer input port.
③ [Video] button	Each time the button is pressed, the image cycles through Video, S-Video, and HDMI (EB-1925W/1915 only) input ports.
④ [Screen Fit] button	Use this button to adjust the projected image so that it fits the screen frame. (EB-1925W/1915 only)  p.23 When the projector is suspended from a ceiling or when you are using EB-1920W/1910/1900/1830, this does not function even if the button is pressed.
⑤ Numeric buttons	<ul style="list-style-type: none"> • Use when specifying password entry or remote control ID.  p.43, p.47 • Use when entering numbers in the Network menu from the Configuration menu. (EB-1925W/1920W/1915/1910/1830 only)
⑥ [A/V Mute] button	Turns the video and audio on or off. (EB-1925W/1920W/1915/1910/1830 only) If using EB-1900, the image is turned on or off.  p.32
⑦ [Freeze] button	Images are paused or unpaused.  p.33
⑧ [Auto] button	If pressed during projection of computer signal images, it automatically adjusts the Tracking , Sync. , and Position to project the optimum image.
⑨ [Aspect] button	The Aspect Ratio changes each time the button is pressed.

Name	Function
10 [Page] buttons (Down) (Up)	<ul style="list-style-type: none"> When using the Wireless Mouse function or projecting such files as PowerPoint files in USB Display, you can page up and down by pressing these buttons. p.40, p.115 When projecting such files as PowerPoint files in EasyMP Network Projection, you can page up and down by pressing these buttons. (EB-1925W/1920W/1915/1910/1830 only) When projecting images using PC Free (EB-1925W/1915 only) or Slideshow (EB-1920W/1910/1830 only), pressing these buttons displays the previous/next screen.
11 [E-Zoom] buttons (⊕)(⊖)	<p>(⊕) Enlarges the image without changing the projection size.</p> <p>(⊖) Reduces parts of images that have been enlarged using the [⊕] button. p.39</p>
12 [Menu] button	Displays and closes the Configuration Menu. p.52
13  [ [][] buttons	<p>When a Configuration Menu or Help screen is displayed, it selects menu items and setting values. p.52</p> <p>During Wireless Mouse function, the mouse pointer moves in the direction of the button that was pushed. p.40</p>
14 [Enter] button	<p>When a Configuration Menu or a Help screen is displayed, it accepts and enters the current selection and moves to the next level. p.52</p> <p>Acts as a mouse's left button when using the Wireless Mouse function. p.40</p>
15 [Esc] button	<p>Stops the current function. If pressed when a Configuration Menu is displayed, it moves to the previous level. p.52</p> <p>Acts as a mouse's right button when using the Wireless Mouse function. p.40</p>

Name	Function
16 [Volume] buttons (⏮) (⏭)	<p>(⏮) Decreases the Volume.</p> <p>(⏭) Increases the Volume.</p> <p>Quick Start Guide</p> <p>(EB-1925W/1920W/1915/1910/1830 only) When using EB-1900, this does not function even if the button is pressed.</p> <div style="border: 1px solid black; padding: 5px; margin-top: 10px;"> <p>⚠ Caution</p> <p><i>Do not start at high volume. A sudden excessive volume may cause loss of hearing. Always lower the volume before powering off, so that you can power on and then gradually increase the volume.</i></p> </div>
17 [Help] button	Displays and closes the Help screen which shows you how to deal with problems if they occur. p.82
18 [Pointer] button	Press to activate the on-screen pointer. p.38
19 [Num] button	<ul style="list-style-type: none"> Use when entering a Password. p.47 Use when entering numbers in the Network menu from the Configuration menu. (EB-1925W/1920W/1915/1910/1830 only)
20 [Color Mode] button	Each time the button is pressed, the Color Mode changes. p.31
21 [ID] button	Press to set the remote control's ID. p.43
22 [User] button	<p>Press to assign a frequently used item from the five available Configuration Menu items. By pressing the button the assigned menu item selection/adjustment screen is displayed, allowing you to make one-touch settings/adjustments. p.56</p> <p>Power Consumption is assigned as the default setting.</p>

	Name	Function
23	[Focus] buttons [◀][▶]	Adjusts the image focus. (EB-1925W/1915 only) ☛ <i>Quick Start Guide</i> When using EB-1920W/1910/1900/1830, this does not function even if the button is pressed.
24	[LAN] button	Changes to the image projected with EasyMP Network Projection. When projecting via Quick Wireless Connection using the optional Quick Wireless Connection USB Key, this button switches to that image. When using EB-1900, this does not function even if the button is pressed.
25	[USB] button	Each time the button is pressed, it cycles through the following images: <ul style="list-style-type: none"> • USB Display • Images from the device connected to USB1 or USB2 port (EB-1925W/1915 only) • Images from the device connected to the USB(TypeA) port (EB-1920W/1910/1830 only)
26	[Search] button	Changes to the next input source that is connected to the projector and is sending an image. ☛ p.29
27	Remote control light-emitting area	Outputs remote control signals.



Useful Functions

This chapter explains useful tips for giving presentations, and the Security functions.



Discount-Merchant.com (800) 281-8860
THE TRUSTED SOURCE FOR PROJECTOR LAMPS AND ACCESSORIES

This projector (EB-1925W/1915) is equipped with the following two functions for automatically correcting the projected image.

• Auto H/V-Keystone

When the projector senses any movement, for example, when it is moved, repositioned or tilted, it automatically corrects vertical and horizontal keystone distortions and focus problems. This function of the projector is called Auto H/V-Keystone.

When the projector remains still for about two seconds after it sensed a movement, it displays a screen for adjustment and then automatically corrects the projected image. 🖱️ *Quick Start Guide*



- Auto H/V-Keystone only works when **Extended** menu - **Projection** from the Configuration menu is set to **Front**. 🖱️ p.58
- If you do not want to use the Auto H/V-Keystone function, set Configuration menu - **Settings** menu - **Keystone** - **H/V-Keystone** - **Auto H/V-Keystone** to **Off**. 🖱️ p.56

• Screen Fit

Screen Fit is a function that corrects the projected image so that it aligns with the frame (outer border) of the screen, white board and the like. By pressing the [Screen Fit] button on the remote control or the control panel, the projected image is fitted into the screen, and keystone correction and focus adjustments are performed automatically.

This section explains how to correct the projected image using Screen Fit.

The following are the conditions for correcting the projected image using Screen Fit.

Screen size: less than or equal to 100"

Distance between projector and screen: approx. 1.0 to 3.5 m

Correction angle: approx 20° right and left/approx. 30° up and down

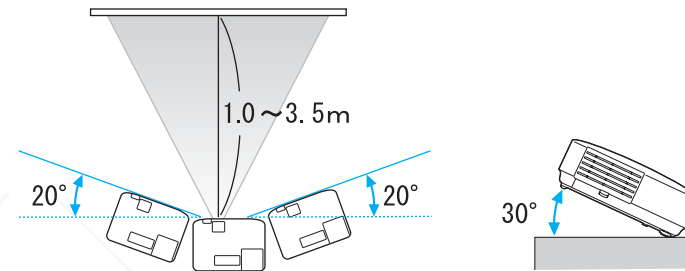

- If you exceed the above mentioned range, the projected image cannot be corrected properly. Correct the projected image manually. Also, depending on the combination of horizontal and vertical angles, the range of correction may be narrower than the above mentioned values.
- Screen Fit does not function if the projector is suspended from a ceiling. Correct the projected image manually.

Procedure

- 1 Press the [Screen Fit] button on the remote control or the control panel.

Using the Remote Control

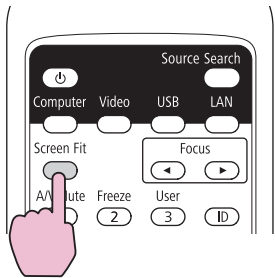

Using the Control panel

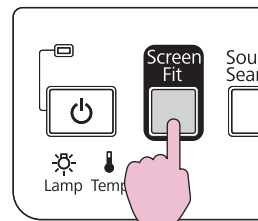

When the following message box appears, move the projector to adjust the position of the projected image, so that the message box is at the center of the screen.

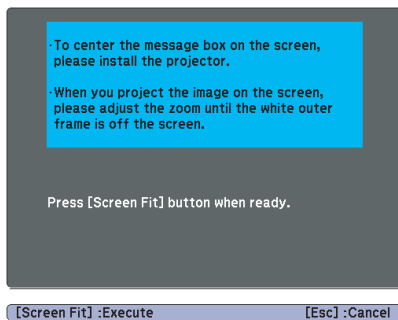

Correction cannot be performed unless the message box fits within the screen frame. If you cannot make the message box fit inside the screen frame even after adjusting the projector position or the Zoom ring, correct the projected image manually.

- 2 Adjust the Zoom ring so that the projected area (defined by outer white border line) is bigger than the screen frame.



If the projected area is still not larger than the frame even after adjusting the Zoom ring to its maximum size, try moving the projector further away from the screen. (If this causes the message box moves away from the center of the screen, adjust it so that it is centered again.)

- 3 Press the [Screen Fit] button again.



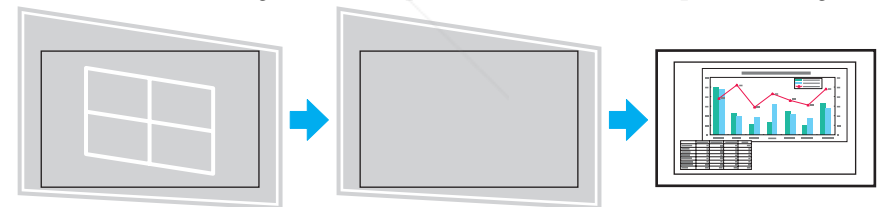

After the adjustment screen appears, the projected image is corrected according to the Aspect Ratio of the inputted image.



Once the adjustment screen appears, do not move the projector or block the image. The projected image will not be corrected properly





4

After the correction is performed, the following message appears. To exit the correction menu, press the [Esc button] on the remote control or the control panel to clear the message.

To fine-tune the projected image after it has been corrected, make the adjustments using the [][][][] buttons on the control panel.  Procedure 3 on [p.26](#)

The revision result can be adjusted by  on the main control panel.

If no operation is performed, the message closes after about 5 seconds.

After Screen Fit is executed, **Keystone** from the Configuration menu is set to **Quick Corner**. After this, any correction of the projected image using [][][][] buttons on the control panel will be done through the Quick Corner function.  [p.26](#)



- Screen Fit corrects the projected image when it detects two or more sides inside the projected area, and aligns with the detected frame. For example, when projecting onto a wide screen in a small room, you can make corrections by fitting the top and bottom sides of the screen into the projected area.



- Screen Fit may not work well in dark environment, such as a room with lights turned off. In this case, make the room brighter, then try executing Screen Fit again.
- Because Screen Fit uses a sensor, it may not work properly depending on the condition of the projected surface (deflections, patterns and the like) or the effects of outside light. In this case, make the adjustments manually.  *Quick Start Guide*

This projector (EB-1925W/1915) provides two ways to correct distortion in projected images as below.

- H/V-Keystone

This allows you to manually correct distortion in the horizontal and vertical directions independently. H/V-Keystone correction is ideal for fine-tuning Keystone distortion. You can perform easy corrections by using the [↶], [↷], [⏪], and [⏩] buttons on the projector's control panel.  *Quick Start Guide*

- Quick Corner

This allows you to manually correct each of the four corners of the projected image separately.

This section explains how to correct the projected image using Quick Corner.

Procedure

- 1 Press the [Menu] button, and then from the Configuration menu select Settings - Keystone.  "Using the Configuration Menu" p.52

Using the Remote Control

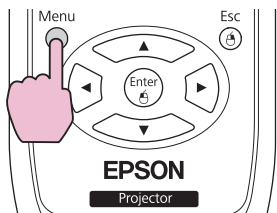

Using the Control panel

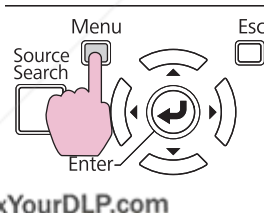

Discount-Merchant.com (800) 281-8860
 THE TRUSTED SOURCE FOR PROJECTOR LAMPS AND ACCESSORIES

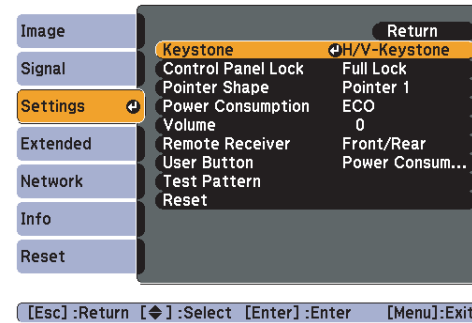

2

Select "Quick Corner", and then press the [Enter] button.

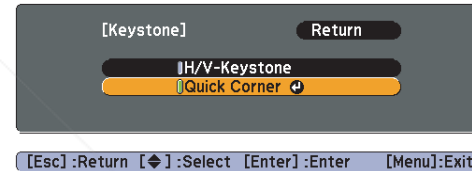

Press the [Enter] button again to display the selection screen from which you can select one of the four corners.

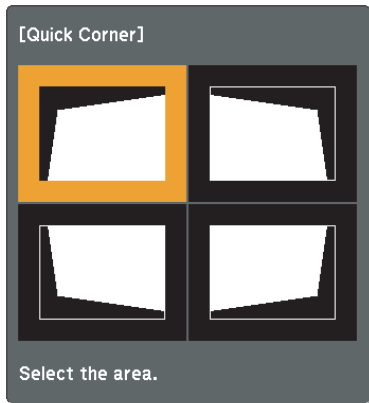

[↙ / ↘] : Select
 [Enter] : Enter
 [Esc] : Return (press for 2 seconds to reset/switch)

3 Using the [↖], [↗], [↵], and [↔] buttons on the remote control, or the [↖], [↗], [↵] and [↔] buttons on the control panel, select the corner to correct, then press the [Enter] button.

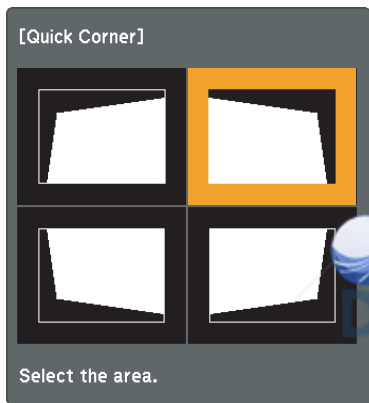

4 Using the [↖], [↗], [↵], and [↔] buttons on the remote control, or the [↖], [↗], [↵] and [↔] buttons on the control panel, correct the position of the corner.

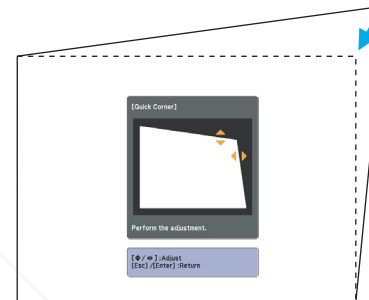

If the triangle in the direction you are adjusting the shape turns gray, as shown in the screenshot below, you cannot adjust the shape any further in that direction.

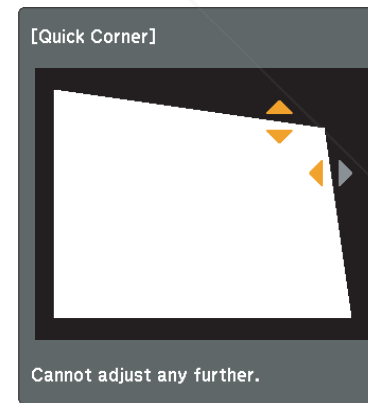

5 Repeat procedures 3 and 4 as needed to adjust any remaining corners.

6 When you are done, press the [Esc] button to exit the correction menu.

Since **Keystone** in the Configuration menu has been changed to **Quick Corner**, pressing the [↶], [↷], [⏪], and [⏩] buttons on the control panel displays the selection screen from which you can select the corner, as shown in procedure 2. If you want to perform H/V-Keystone when you press the [↶], [↷], [⏪], and [⏩] buttons on the control panel, change **Keystone** from the Configuration menu to **H/V-Keystone**.



- In the **Settings** menu - **Keystone** of the Configuration menu, when you have set **Auto H/V-Keystone** to **On**, the message "Do you want to perform Auto H/V-Keystone correction?" is displayed when the projector is moved. After you perform this function, the **Keystone** setting in the Configuration menu changes from **Quick Corner** to **H/V-Keystone**, after which pressing the [↶], [↷], [⏪], and [⏩] on the control panel performs H/V-Keystone. [p.56](#)
- If the [Esc] button is held down for about two seconds while correcting with Quick Corner, the following screen is displayed.

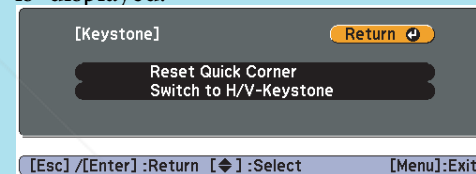

Reset Quick Corner: Resets the result of Quick Corner corrections.

Switch to H/V-Keystone: Switches the correction method to H/V-Keystone.

[p.56](#)

You can change the projected image in the following two ways.

- Changing by Source Search
The projector automatically detects signals being input from connected equipment, and the image being input from the equipment is projected.
- Changing directly to the target image
You can use the Remote Control buttons to change to the target input port.

Automatically Detect Input Signal and Change the Projected Image (Source Search)

You can project the target image quickly as input ports with no image signal being input are ignored when you change by pressing the [Source Search] button.

EB-1925W/1920W/1915/1910/1830

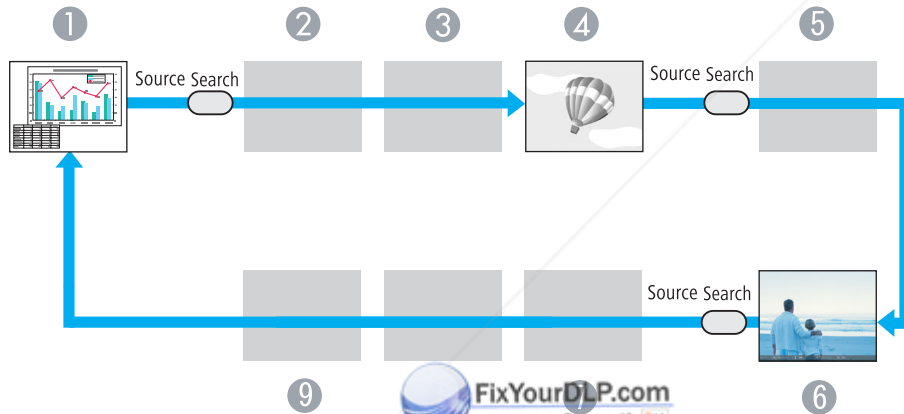

Skipped when no image signal is being input.

- 1 Computer1
- 2 Computer2
- 3 S-Video
- 4 Video

- 5 HDMI (EB-1925W/1915only)
- 6 USB Display
- 7 USB1 (EB-1925W/1915 only)/
USB (EB-1920W/1910/1830 only)
- 8 USB2 (EB-1925W/1915 only)
- 9 LAN

EB-1900

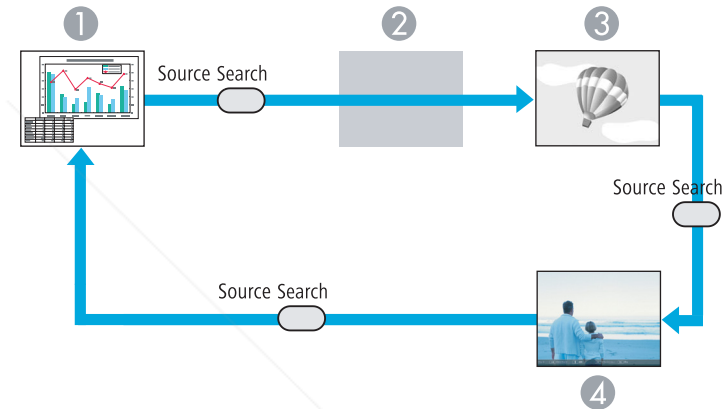

Skipped when no image signal is being input.

- 1 Computer
- 2 Video
- 3 S-Video
- 4 USB Display

Procedure

When your video equipment is connected, start playback before beginning this operation.

Using the Remote Control

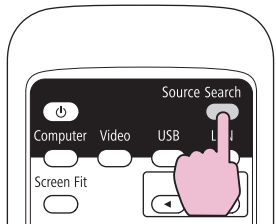

Using the Control panel

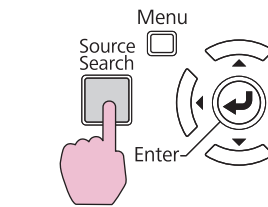

When two or more pieces of equipment are connected, press the [Source Search] button until the target image is projected.



The following screen showing the status of image signals is displayed when only the image that the projector is currently displaying is available, or when no image signal can be found. You can select the input port where the equipment you want to use is connected. If no operation is performed after about 10 seconds, the screen closes.

Example: EB-1925W/1915



Switch to the target image by Remote Control

You can change directly to the target image by pressing the following buttons on the Remote Control.

Remote Control

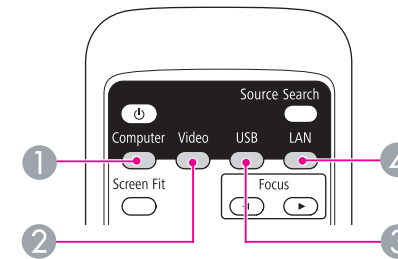

- ① Each time the button is pressed, the image changes from the Computer1 input port to the Computer2 input port. (EB-1925W/1920W/1915/1910/1830 only)
When using EB-1900, it changes to images from the Computer input port.
- ② Each time the button is pressed, the image cycles through Video, S-Video, and HDMI (EB-1925W/1915 only) input ports.
- ③ Each time the button is pressed, it cycles through the following images:
 - USB Display
 - Images from the device connected to USB1 or USB2 port (EB-1925W/1915 only)
 - Images from the device connected to the USB(TypeA) port (EB-1920W/1910/1830 only)
- ④ Changes to the image projected with EasyMP Network Projection. When projecting via Quick Wireless Connection using the optional Quick Wireless Connection USB Key, this button switches to that image. (EB-1925W/1920W/1915/1910/1830 only)
When using EB-1900, this does not function even if the button is pressed.

Selecting the Projection Quality (Selecting Color Mode)

You can easily obtain the optimum image quality simply by selecting the setting that best corresponds to your surroundings when projecting. The brightness of the image varies depending on the mode selected.

Mode	Application
Dynamic	Ideal for use in a bright room. This is the brightest mode, and reproduces shadow tones well.
Presentation	Ideal for making presentations using color materials in a bright room.
Theatre	Ideal for watching films in a dark room. Gives images a natural tone.
Photo*1	Ideal for projecting still pictures, such as photos, in a bright room. The images are vivid and brought into contrast.
Sports*2	Ideal for watching TV programmes in a bright room. The images are vivid and brought to life.
sRGB	Ideal for images that conform to the <u>sRGB</u> color standard.
Blackboard	Even if you are projecting onto a Blackboard (greenboard), this setting gives your images a natural tint, just like when projecting onto a screen.
Whiteboard	Ideal for making presentations using the whiteboard.
Customized	Select Customized if you want to adjust the R , G , B , C M , and Y settings in the Color Adjust sub menu of the Configuration menu.

*1 This selection is only available when the input signal is RGB or when the input source is USB Display, USB1, USB2, USB, or LAN. (Depending on the model used, some input sources are not supported.)

*2 This selection is only available when the input signal is component video, or when the input source is S-Video or Video.

Procedure

Remote Control

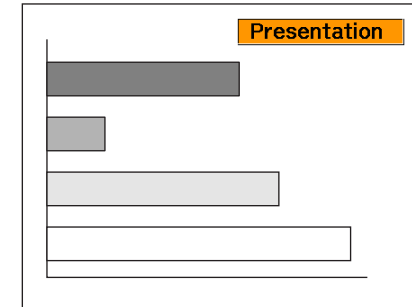
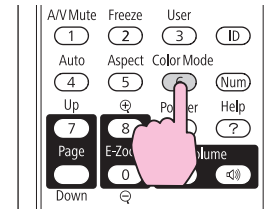

Each time you press the button, the Color Mode name is displayed on the screen and the Color Mode changes.

If you press the button while the Color Mode name is displayed on the screen, it changes to the next Color Mode.



The color mode can also be set using **Color Mode** in the **Image** menu from the Configuration Menu. [p.53](#)

Setting the Auto Iris

By automatically setting the luminance according to the brightness of the displayed image, it lets you enjoy deep and rich images.

Procedure

- 1 Press the [Menu] button and select Image - Auto Iris from the Configuration Menu. "Using the Configuration Menu" p.52

Using the Remote Control

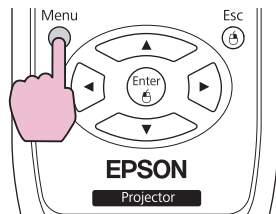

Using the Control panel

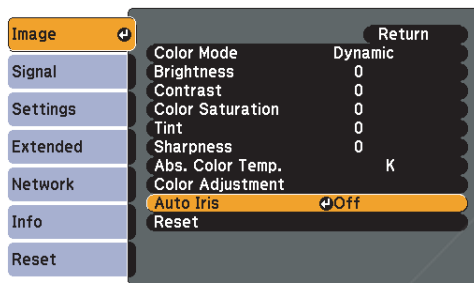
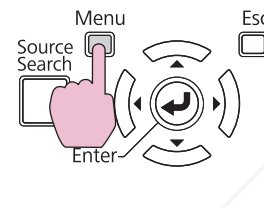

[Esc]:Return [◀▶]:Select [Enter]:Enter [Menu]:Exit

- 2 Select On.

The setting is stored for each Color Mode.

- 3 Press the [Menu] button to close the Configuration Menu.



Auto Iris can be set only when the Color Mode is Dynamic, Theatre, or Customized.

Hiding the Image and Sound Temporarily (A/V Mute)

You can use this when you want to focus the audience's attention on what you are saying, or if you do not want to show details such as when you are changing between files during presentations from a computer.

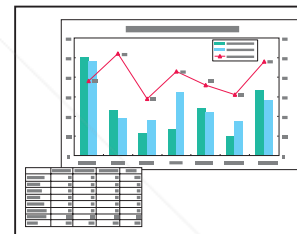

Procedure

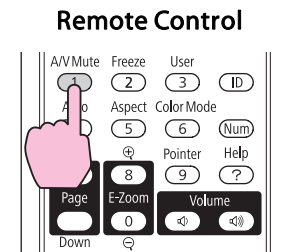

Body

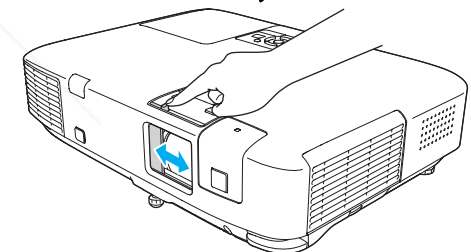

Each time you press the button, or open/close the lens cover A/V Mute turns on or off.



- If you use this function when projecting moving images, the images and sound continue to be played back by the source, and you cannot return to the point where A/V Mute was activated.
- When activated from the remote control, you can choose to display **Black**, **Blue**, or **Logo** as the A/V Mute display using the **Extended - Display - A/V Mute** setting from the Configuration menu. p.58
- When the A/V mute slide is closed for approximately 30 minutes, Lens Cover Timer activates and the power is automatically turned off. If you do not want Lens Cover Timer to activate, change the **Lens Cover Timer** setting to **Off** from **Operation** sub menu of the **Extended** menu. p.58
- The lamp is still lit during A/V Mute, so the lamp hours continue to accumulate.
- For EB-1900, A/V Mute hides only the images. (There is no audio function.)

Procedure

Remote Control

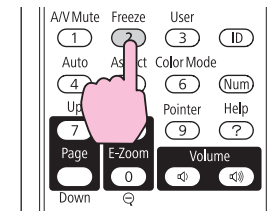

Each time you press the button, Freeze turns on or off.



- Audio does not stop.
- The image source continues to play back the moving images even while the screen is frozen, and so it is not possible to resume projection from the point where it was paused.
- If the [Freeze] button is pressed while the Configuration Menu or a Help screen is displayed, the menu or Help screen being displayed is cleared.
- Freeze still works while E-Zoom is being used.

Freezing the Image (Freeze)

When Freeze is activated on moving images, the frozen image continues to project on the screen, so you can project a moving image one frame at a time like a still photo. Also, you can perform operations such as changing between files during presentations from a computer without projecting any images if the Freeze function is activated beforehand.

Changing the Aspect Ratio

Change the Aspect Ratio when video equipment is connected so that images that have been recorded in digital video or onto DVDs can be viewed in 16:9 wide-screen format. Change the Aspect Ratio when projecting computer images at full size.

The changing methods and the types of Aspect ratio are as follows.

Changing methods

Procedure

Remote Control

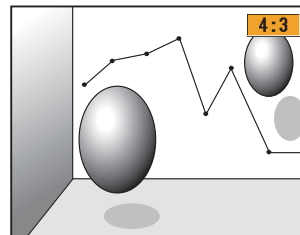
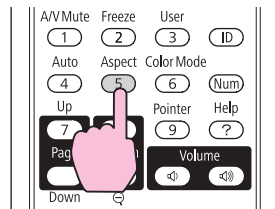

Each time you press the button, the Aspect name is displayed on the screen and the Aspect changes.

If you press the button while the Aspect name is displayed on the screen, it changes to the next Aspect Mode.



The aspect ratio can also be set using **Aspect** in the **Signal** menu from the Configuration Menu. [p.54](#)

Changing the Aspect for video equipment images

EB-1915/1910/1900/1830

Each time you press the button, it switches between **4:3** and **16:9**.

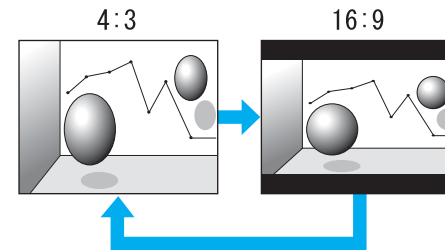

* When a 720p/1080i signal is input, the display is in a zoomed 4:3 format (the image is cut off on the right and left sides).

EB-1925W/1920W

Each time the button is pressed, it changes in the order **Normal** or **Auto**, **16:9**, **Full**, **Zoom**, and **Native**.

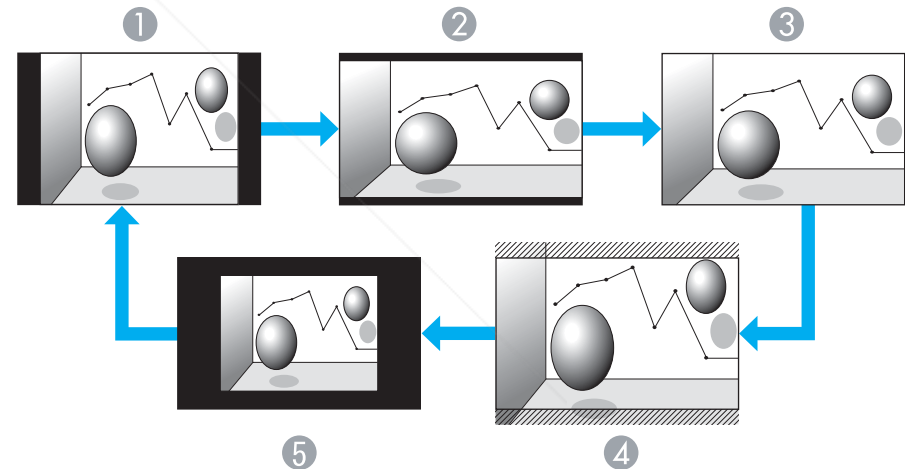

① Normal or Auto

② 16:9



③ Full

④ Zoom

⑤ Native

Changing the aspect for computer images (EB-1915/1910/1900/1830)

When projecting images input from Computer input port (EB-1900 only), Computer1/2 input port (EB-1915/1910/1830 only), or HDMI input port (EB-1915 only), you can change the aspect as follows.

Set Values	Operation	Projection example
Normal Displayed when the source is Computer or Computer1/2.	Projects to the full projection size retaining the Aspect of the input image.	
Auto (EB-1915 only) Displayed only when the source is HDMI.	Projects in an appropriate aspect based on information from the signal being input.	
4:3	Projects to the full projection size at an Aspect of 4:3. This is ideal for when you want to project images at an Aspect of 5:4 (1280 x 1024) to the full projection size.	When a 1280 x 1024 signal is input 
16:9	Projects at a 16:9 Aspect. This is ideal for projecting at full screen size when using a 16:9 screen.	When a 1280 x 1024 signal is input 



If parts of the image are missing, set the **Resolution** setting to **Wide** or **Normal** from the Configuration Menu, according to the size of the computer panel.

FixYourDLP.com
Sponsored by DM

Discount-Merchant.com (800) 281-8860
 THE TRUSTED SOURCE FOR PROJECTOR LAMPS AND ACCESSORIES

Changing the Aspect for computer images (EB-1925W/1920W)

When projecting images from Computer1/2 input port or HDMI input port (EB-1925W only), you can change the Aspect as follows. EB-1925W/1920W offers WXGA 1280x800 resolution (Aspect Ratio 16:10). When projecting onto 16:9 screens, set the Aspect to 16:9.

Set Values	Operation	Projection example
Normal	Projects to the full projection size retaining the Aspect of the input image.	When a 1024 x 768 signal is input
Auto (EB-1925W only) Displayed only when the source is HDMI.	Projects in an appropriate aspect based on information from the signal being input.	
16:9	Projects to the full projection size at an Aspect of 16:9.	When a 1024 x 768 signal is input
Full	Project at full size.	When a 1024 x 768 signal is input

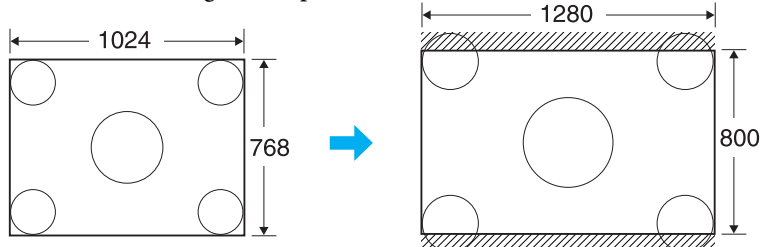
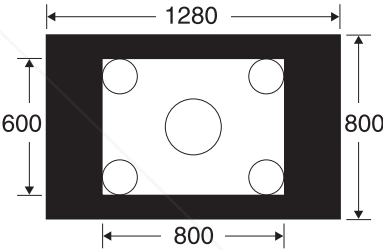
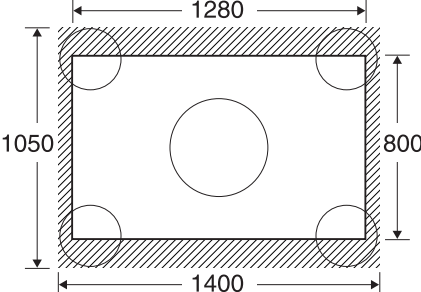
Set Values	Operation	Projection example	
Zoom	Projects the input image at the lateral direction aspect size as it is. Parts that extend beyond the projection size are not projected.	<p>When a 1024 x 768 signal is input</p> 	
Native	Projects at the resolution of the input image size to the center of the screen. This is ideal for projecting clear images. If the image resolution exceeds 1280 x 800, the edges of the image are not projected.	<p>When an 800 x 600 signal is input</p> 	<p>When an 1400 x 1050 signal is input</p> 



If parts of the image are missing, set the **Resolution** setting to **Wide** or **Normal** from the Configuration Menu, according to the size of the computer panel.  [p.54](#)

Pointer Function (Pointer)

This allows you to move a Pointer icon on the projected image, and helps you draw attention to the area you are talking about.

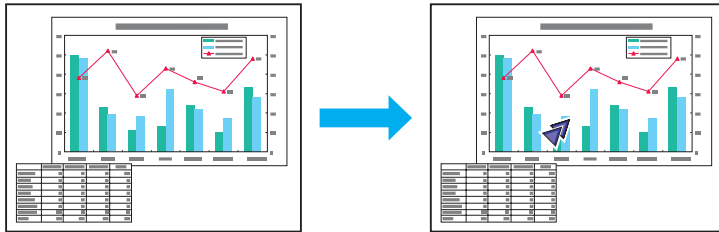

Procedure

1 Display the Pointer.

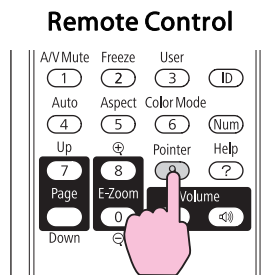

Each time you press the button, the pointer appears or disappears.

2 Move the Pointer icon (↗).

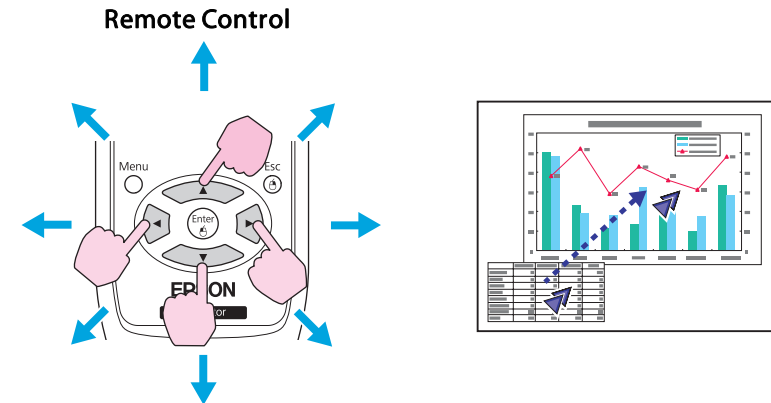

When pressed in conjunction with the adjacent [↖], [↗], [↘], and [↙] buttons, the pointer can be moved diagonally.



You can choose from three different kinds of Pointer icon (↗, ✂, or ↘) in **Settings - Pointer Shape** from the Configuration Menu.

 [p.56](#)

Enlarging Part of the Image (E-Zoom)

This is useful when you want to expand images to see them in greater detail, such as graphs and tables.

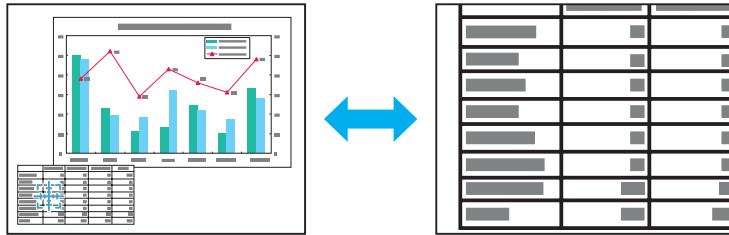

Procedure

1 Start E-Zoom.

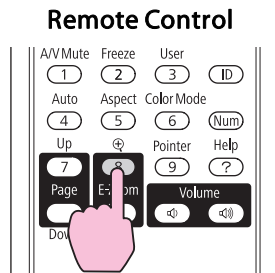

2 Move the [Crosshair] to the area of the image that you want to enlarge.

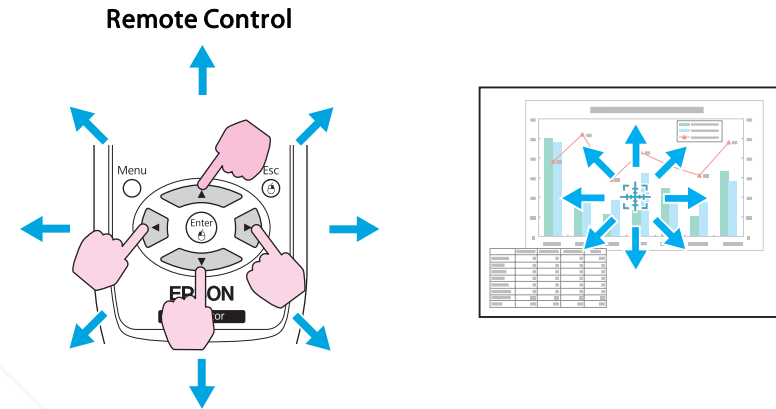

When pressed in conjunction with the adjacent [Up], [Down], [Left], and [Right] buttons, the pointer can be moved diagonally.

3 Enlarge.

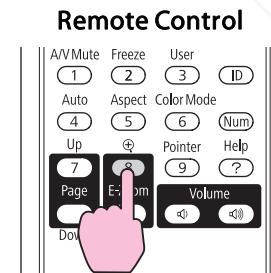

Each time the button is pressed, the area is expanded. You can expand quickly by holding the button down.

You can reduce the enlarged image by pressing the [Reduce] button.

Press the [Return] button to cancel.



- The enlargement ratio appears on the screen. The selected area can be enlarged to between 1 to 4 times in 25 incremental steps.
- Press the [▲], [▼], [◀], and [▶] buttons to scroll the image.
- If E-Zoom is selected, **Progressive** and **Noise Reduction** are cancelled.

Operating the Mouse Pointer by Remote Control (Wireless Mouse)

To activate the Wireless Mouse function, set **USB Type B** to **Wireless Mouse** from **Extended** in the Configuration Menu. By default, **USB Type B** is set to USB Display. Change the setting beforehand. [p.58](#)

When the USB port of a computer and the USB (TypeB) Port on the rear of the projector are connected with the USB cable, you can use the projector's Remote Control like a Wireless Mouse to control the computer's mouse pointer.

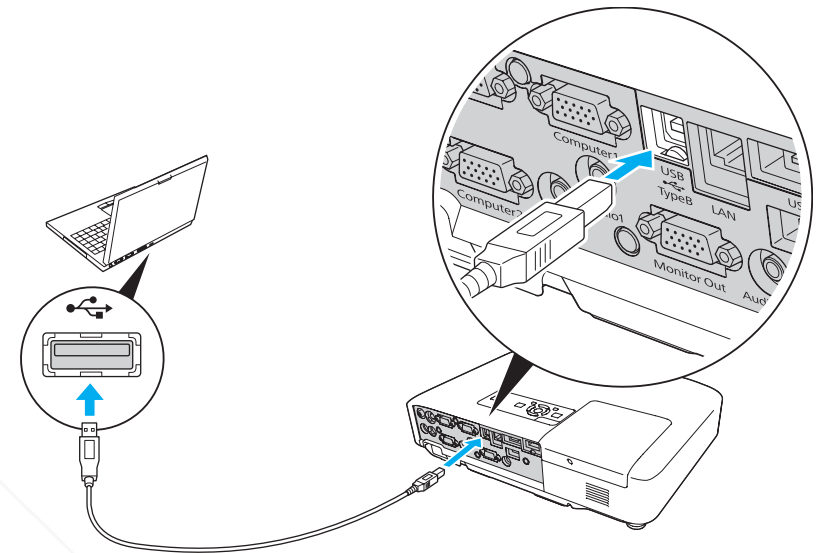

Compatible OS

Windows: 98/98SE/2000/Me/XP Home Edition/
XP Professional/Vista Home Basic/Vista Home Premium/
Vista Business/Vista Enterprise/Vista Ultimate

Macintosh: Mac OS X 10.3 to 10.5



- The Wireless Mouse function can be used only when the source is Computer1, Computer2, or HDMI (EB-1925W/1915 only). For EB-1900, it can be used only when the source is Computer.
- When projecting in USB Display, you can only page up and down.
- It may not be possible to use the Wireless Mouse function under some versions of both the Windows and Macintosh operating systems.
- Some computer settings may have to be changed in order for the mouse function to be used. Consult the documentation for the computer for further details.

Once the connection has been made, the mouse pointer can be operated as follows.

Moving the mouse pointer

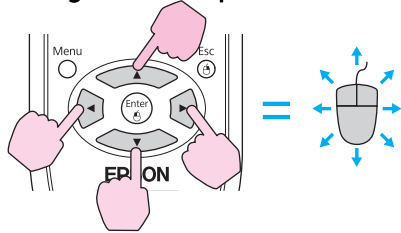

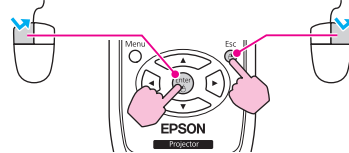

Mouse clicks

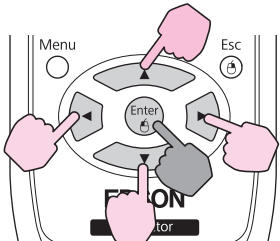

Left click: Press the [Enter] button.
 Right click: Press the [Return] button.
 Double click: Press quickly twice.

Drag and drop



: Keep pressed

1. While holding down the [Enter] button, press the [Up], [Down], [Left], or [Right] button.
2. Release the [Enter] button to drop at the desired location.

Switch PowerPoint screens

This is useful for displaying the previous or next slide in a PowerPoint Slideshow.

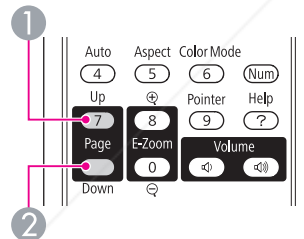

- 1 To previous slide
- 2 To next slide



- When pressed in conjunction with the adjacent [Up], [Down], [Left], and [Right] buttons, the pointer can be moved diagonally.
- If the mouse button settings are set to reverse on the computer, the operation of the Remote Control buttons will also be reversed.
- The Wireless Mouse function cannot be used while the following functions are being used.
 - While the Configuration Menu is being displayed
 - While a Help menu is being displayed
 - While the E-Zoom function is being used
 - While a user's logo is being captured
 - While a pointer function is being used
 - While adjusting sound volume
 - While USB Display is being operated
 - While displaying a Test Pattern
 - While Color Mode is being set
 - While Color Mode name is being displayed
 - While the Source name is being displayed
 - While switching input source





FixYourDLP.com
 Sponsored by DLP

Discount-Merchant.com (800) 281-8860
 THE TRUSTED SOURCE FOR PROJECTOR LAMPS AND ACCESSORIES

When an ID is set for the projector and the remote control, you can use the remote control to operate only the projector with a matching ID. This is very useful when managing multiple projectors.

You can set an ID for the projector within a range of "1" to "9". The default value is Off.

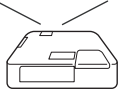
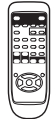
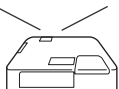
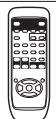
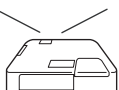
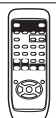
You can set an ID for the remote control within a range of "0" to "9". The default value is "0". The following table shows the possible combinations of projector ID and remote control ID.

Operation	Combinations		Descriptions
Possible		Projector ID: 1	The projector ID and the remote control ID are identical, therefore you can operate the projector with the remote control.
		Remote control ID: 1	
Possible		Projector ID: Off	When the Projector ID is Off, you can operate with the remote control regardless of the remote control ID setting.
		Remote control ID: 1	
Possible		Projector ID: 1	When the remote control ID is "0", you can operate with the remote control regardless of the Projector ID setting.
		Remote control ID: 0	
Not possible		Projector ID: 1	The projector ID and the remote control ID do not match, therefore you cannot

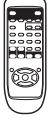
Operation	Combinations	Descriptions
		Remote control ID: 3 operate the projector with the remote control.

Setting the Projector ID

Procedure

1

Press the [Menu] button, and then select **Extended - Projector ID** from the Configuration menu. "Using the Configuration Menu" p.52

Using the Remote Control

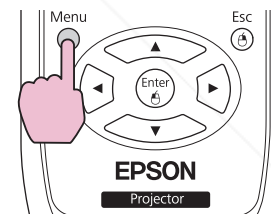

Using the Control panel

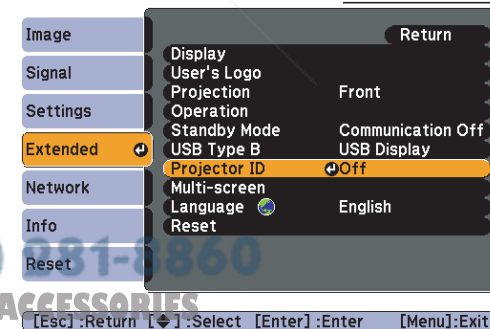
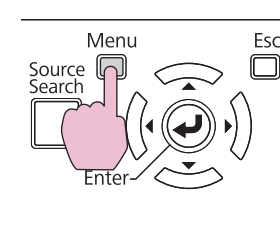

- Choose the ID you want to set and press the [Enter] button.

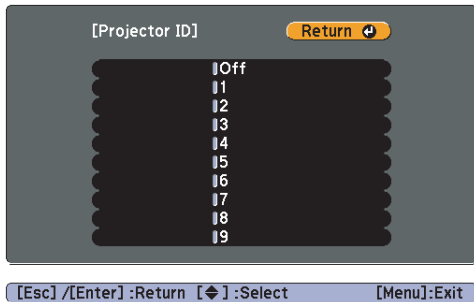

- Press the [Menu] button to close the Configuration Menu.

Setting the Remote Control ID

Set the ID on the remote control each time you switch the projector power on. When the projector is powered on, the remote controller ID is set to "0" (i.e. you can operate the projector with the remote control regardless of the projector ID).

Procedure

- Point the remote control at the remote receiver of the target projector and press the [ID] button on the remote control.

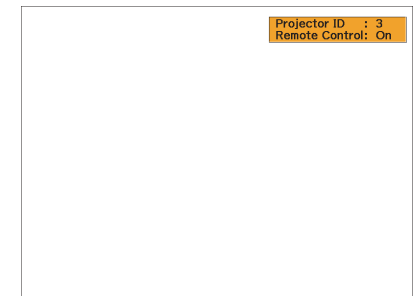
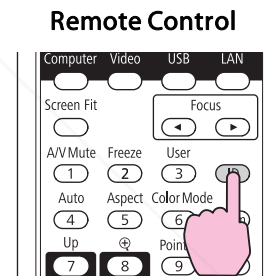

When you press the buttons, the current Projector ID is displayed on the projection screen. It disappears in about three seconds.

- ② While holding the [ID] button, press a number button to select a number to match the ID of the projector you want to operate.

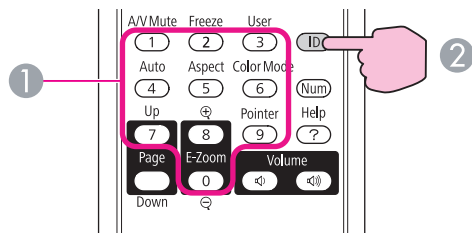

- ① Numeric buttons
- ② Keep pressed

Once this setting has been made, the projector that can be operated by the remote control is limited.



When you power off the projector, the remote control ID is reset to "0" (i.e. you can operate the projector with the remote control regardless of the projector ID).

When multiple projectors are lined up and projecting images, you can correct the brightness and color tone of each projector's image with multi-screen color adjustment so that the colors of images from each projector match closely. In some cases the brightness and color tone may not match completely even after correction.

Summary of Correction Procedure

When multiple projectors are set up and you need to make corrections, use the following procedure to correct one projector at a time.

1. Set the projector ID and the remote control ID.

Set a projector ID for the target projector, then set the same ID for the remote control, so that you can limit the operation to one target projector.

 [p.42](#)

2. Correct the color difference.

You can carry out color correction when projecting from multiple projectors. You can adjust from black to white in five stages called levels 1 to 5, and in each of these 5 levels you can adjust the following two points.

- Correcting brightness

You can correct the image brightness to make them all equal.

- Correcting color

You can adjust the image color to make them match more closely by using Color Correct. (G/R) and Color Correct. (B/Y).

Correction Method

After setting up the projectors, correct the brightness and tone for each projector to reduce the differences.



Sponsored by

Discount-Merchant.com

THE TRUSTED SOURCE FOR PROJECTOR LAMPS AND ACCESSORIES

Procedure

1

Press the [Menu] button and select **Extended - Multi-screen** from the Configuration Menu.  "Using the Configuration Menu" [p.52](#)

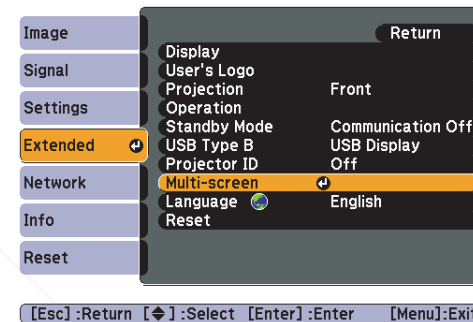

2

Select the level to be corrected in **Adjustment Level**.

- Each time a level is selected, the pattern of the level selected is displayed.
- You can start correcting from any level, usually you can make it darker or lighter by correcting 1 to 5 or 5 to 1.

3

Correct the brightness with **Brightness Correct**.

- When you select **Level 5**, all the images are adjusted to the darkest image from multiple projectors.
- When you select **Level 1**, all the images adjusted to the brightest image from multiple projectors.
- When you select **Level 2 to 4**, all the images are adjusted to the mid-range brightness image from multiple projectors.
- Because each time the [Enter] button is pressed the image displayed changes between the pattern display and the actual image, you can check the correction results and make corrections in the actual image.



4 Correct the Color Correct. (G/R) and Color Correct. (B/Y) settings.

Because each time the [Enter] button is pressed the image displayed changes between the pattern display and the actual image, you can check the correction results and make corrections in the actual image.

5 Repeat procedures 2 to 4 until corrections are finished.

6 When all corrections are finished, press the [Menu] button to close the configuration menu.

The projector has the following enhanced security functions.

- **Password Protect**
You can limit who can use the projector.
- **Control Panel Lock**
You can prevent people changing the settings on the projector without permission.  p.49
- **Anti-Theft Lock**
The projector is equipped with various types of anti-theft security devices.  p.50

2. User's Logo Protect

Even if someone tries to change the User's Logo set by the owner of the projector, it cannot be changed. When **User's Logo Protect** is set to **On**, the following setting changes for the User's Logo are prohibited.

- Capturing a User's Logo
- Settings for **Display Background**, **Startup Screen**, and **A/V Mute** from **Display** in the Configuration Menu.

3. Network Protect (EB-1925W/1920W/1915/1910/1830 only)

When **Network Protect** is set to **On** setting changes for **Network** Menu in the configuration menu are prohibited.

Managing Users (Password Protect)

When Password Protect is activated, people who do not know the Password cannot use the projector to project images even if the projector power is on. Furthermore, the user's logo that is displayed when you turn on the projector cannot be changed. This acts as an anti-theft device as the projector cannot be used even if it is stolen. At the time of purchase, Password Protect is not activated.

Type of Password Protect

The following three kinds of Password Protect settings can be made according to how the projector is being used.

1. Power On Protect

When **Power On Protect** is **On**, you need to enter a preset Password after the projector is plugged in and turned on (this also applies to Direct Power On). If the correct Password is not entered, the projection does not start.

Setting Password Protect

Use the following procedure to set Password Protect.

Procedure



During projection, hold down the [Freeze] button for about five seconds.

The Password Protect setting menu is displayed.

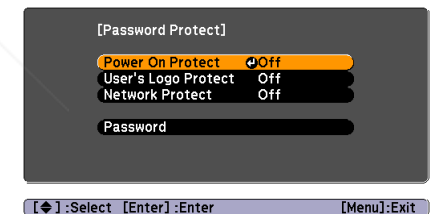
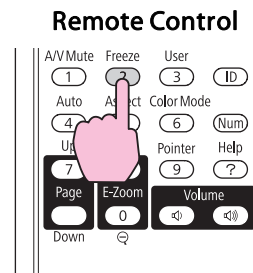



- If Password Protect is already activated, you must enter the Password. If the Password is entered correctly, the Password Protect setting menu is displayed. "Entering the Password" p.48
- When the Password is set, stick the Password protect sticker in a visible position on the projector as a further theft deterrent.

2

Turn on Power On Protect.

- (1) Select **Power On Protect**, and then press the [Enter] button.
- (2) Select **On**, and then press the [Enter] button.
- (3) Press the [Return] button.

3

Turn on User's Logo Protect.

- (1) Select **User's Logo Protect**, and then press the [Enter] button.
- (2) Select **On**, and then press the [Enter] button.
- (3) Press the [Return] button.

4

Turn on Network Protect.(EB-1925W/1920W/1915/1910/1830 only)

- (1) Select **Network Protect**, and then press the [Enter] button.
- (2) Select **On**, and then press the [Enter] button.
- (3) Press the [Return] button.

5

Set the Password.

- (1) Select **Password**, and then press the [Enter] button.
- (2) The message "Change the Password?" is displayed, select **Yes** and then press the [Enter] button. The default setting for the Password is "0000". Change this to your own desired Password. If you select **No**, the screen shown in step 1 is displayed again.
- (3) While holding down the [Num] button, enter a four digit number using the numeric buttons. The number entered is displayed as "* * * *". When you enter the fourth digit, the confirmation screen is displayed.

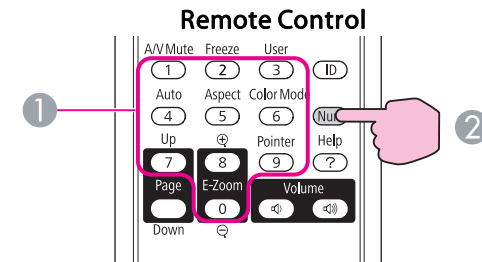

① Numeric buttons

② Keep pressed

(4) Re-enter the Password.

The message "**Password accepted.**" is displayed.

If you enter the Password incorrectly, a message is displayed prompting you to re-enter the password.

Entering the Password

When the Password entry screen is displayed, enter the Password using the numeric buttons on the Remote Control.

Procedure

While holding down the [Num] button, enter the Password by pressing the numeric buttons.

When you enter the correct Password, projection begins.

Attention

- If an incorrect password is entered three times in succession, the message "The projector's operation will be locked." is displayed for about five minutes, and then the projector switches to standby mode. If this happens, disconnect the power plug from the electrical outlet and then reinsert it and turn the projector's power back on. The projector displays the Password entry screen again so that you can enter the correct Password.
- If you have forgotten the password, make a note of the "Request Code: xxxxx" number that appears on the screen and contact the nearest address provided in the Support and Service Guide. [Epson Projector Contact List](#)
- If you continue to repeat the above operation and input the wrong Password thirty times in succession, the following message is displayed and the projector does not accept any more Password entries. "The projector's operation will be locked. Contact Epson as described in your documentation." [Epson Projector Contact List](#)

Procedure

- 1 During projection, press the [Menu] button and select **Settings - Control Panel Lock** from the Configuration Menu. ["Using the Configuration Menu" p.52](#)

Using the Remote Control

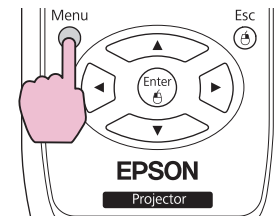

Using the Control panel

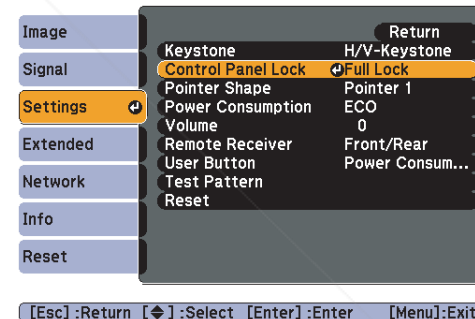
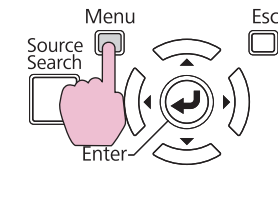

[Esc]:Return [↔]:Select [Enter]:Enter [Menu]:Exit

- 2 Select either **Full Lock** or **Partial Lock** according to your purpose.

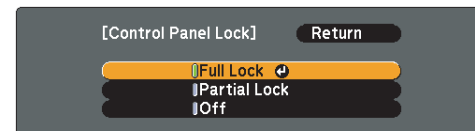

[Esc]:Return [↔]:Select [Enter]:Set [Menu]:Exit

- 3 Select **Yes** when the confirmation message is displayed.

The Control panel buttons are locked according to the setting you chose.

Restricting Operation (Control Panel Lock)

Perform one of the following to lock the operation buttons on the Control panel.

- **Full Lock**
All of the buttons on the Control panel are locked. You cannot perform any operations from the Control panel, including turning the power on or off.
- **Partial Lock**
All of the buttons on the Control panel, except for the [⏻] button, are locked.

This is useful at events or shows when you want to deactivate all buttons during projection or at schools when you want to limit button operation. The projector can still be operated using the Remote Control.



You can release the Control panel lock by one of the following two methods.

- From the Remote Control, select **Off** in **Settings - Control Panel Lock** from the Configuration Menu.
- Press and hold down the [Enter] button on the Control panel for about seven seconds, a message is displayed and the lock is released.

Anti-Theft Lock

As the projector is often setup on ceiling mounts and left in rooms unattended, the projector includes the following security devices to prevent someone from taking the projector.

- **Security slot**
The Security slot is compatible with the Microsaver Security System manufactured by Kensington. You can find details about the Microsaver Security System on the Kensington homepage <http://www.kensington.com/>.
- **Security cable installation point**
A commercially available theft-prevention wire lock can be passed through the installation point to secure the projector to a desk or pillar.

Installing the wire lock

Pass an anti-theft wire lock through the installation point.

See the documentation supplied with the wire lock for locking instructions.

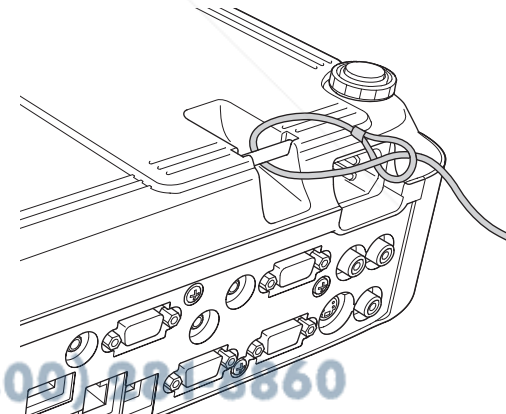



Configuration Menu

This chapter explains how to use the Configuration Menu and its functions.



Discount-Merchant.com (800) 281-8860
THE TRUSTED SOURCE FOR PROJECTOR LAMPS AND ACCESSORIES

1

Selecting from the top menu

2

Selecting from the sub menu

3

Changing the selected item

4

Exit

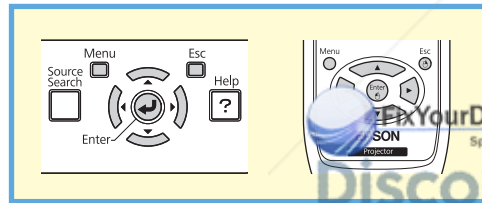
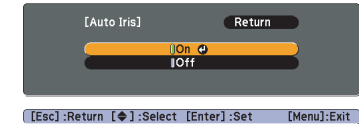
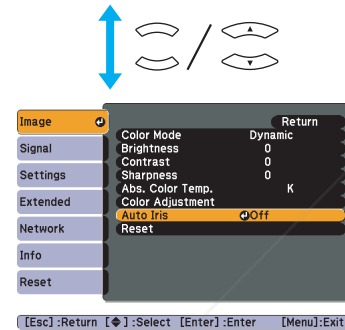
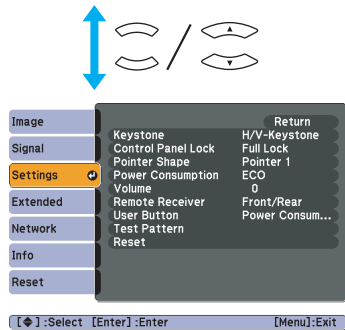
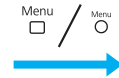
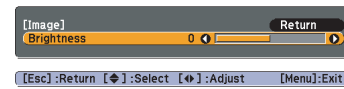
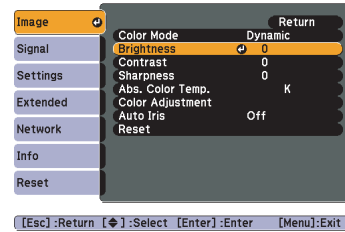
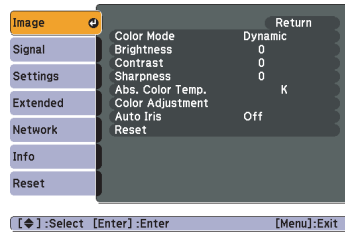

BuyYourDLP.com
Sponsored by DLP

Discount-Merchant.com (800) 281-8860
THE TRUSTED SOURCE FOR PROJECTOR LAMPS AND ACCESSORIES

Image Menu

Items that can be set vary depending on the image signal and Source currently being projected as shown in the following screen shots. Setting details are saved for each image signal.

Depending on the model used, some input sources are not supported. [p.29](#)

RGB Signal/USB Display/USB1/USB2/USB/LAN

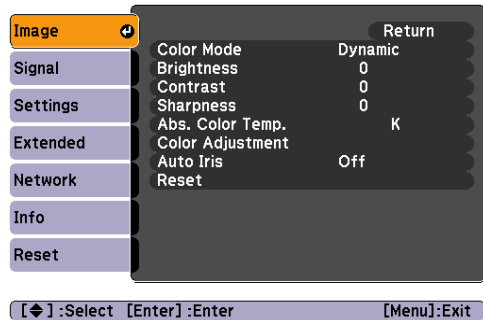

Component Video/S-Video/Video

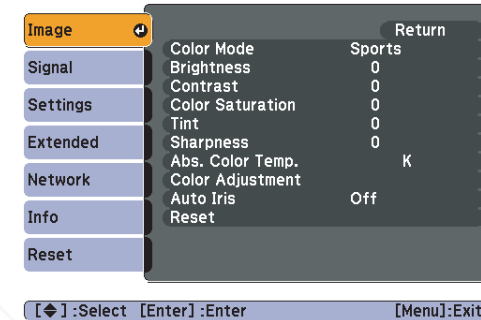

Sub Menu	Function
Color Mode	You can select the quality of the image to suit your surroundings. p.31
Brightness	You can adjust the image Brightness.
Contrast	You can adjust the difference between light and shade in the images.
Color Saturation	You can adjust the Color Saturation for the images.
Tint	(Adjustment is only possible when NTSC signals are being input if you use composite video/S-Video signals.) You can adjust the image Tint.
Sharpness	You can adjust the image sharpness.
Abs. Color Temp.	(This item cannot be selected if Image - Color Mode is set to sRGB .) You can adjust the overall tint of the image. You can adjust tints in 10 stages from 5000 K to 10000 K. When a high value is selected the image becomes tinged with blue, when a low value is selected the image becomes tinged with red.

Sub Menu	Function
Color Adjustment	You can make adjustments by choosing one of the following. Red, Green, Blue: You can adjust the saturation of each color individually. (This item cannot be set if Image - Color Mode is set to sRGB or Customized .) R, G, B, C, M, Y: Adjust the Hue, Saturation, and Brightness for each of R (Red), G (Green), B (Blue), C (Cyan), M (Magenta), and Y (Yellow). (This item can be set only if Image - Color Mode is set to Customized .)
Auto Iris	(This item can be set only if Image - Color Mode is set to Dynamic, Theatre, or Customized .) Set whether or not (On/Off) to adjust to the optimum light status for images being projected. p.32 The setting is stored for each Color Mode.
Reset	You can reset all adjustment values for the Image menu functions to their default settings. To return all menu items to their default settings, see p.80

Signal Menu

Items that can be set vary depending on the image signal and Source currently being projected as shown in the following screen shots. Setting details are saved for each image signal.

You cannot make settings on the Signal menu when the source is USB Display, USB1, USB2, USB, or LAN.

**Computer/Computer1/
Computer2**
(when RGB signal is input)

**Computer/Computer1/
Computer2**
(when component video signal is input)





S-Video/Video

HDMI (EB-1925W/1915only)

[Left Arrow]:Select [Enter]:Enter [Menu]:Exit [Right Arrow]:Select [Enter]:Enter [Menu]:Exit [Left Arrow]:Select [Enter]:Enter [Menu]:Exit [Left Arrow]:Select [Enter]:Enter [Menu]:Exit







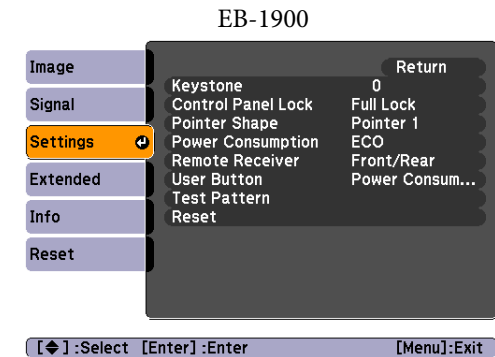
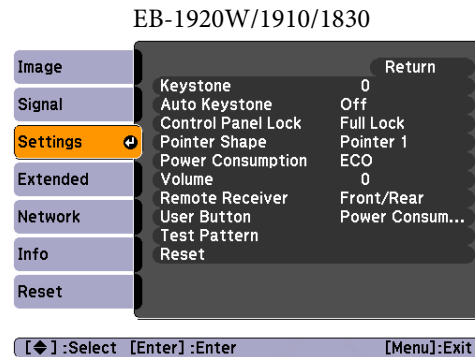
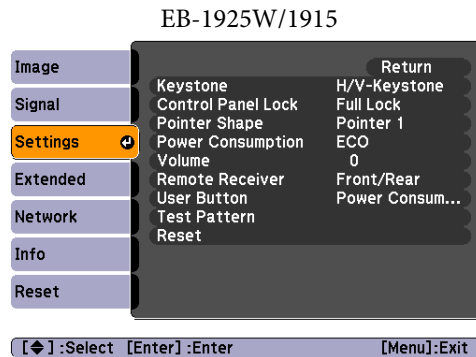

THE TRUSTED SOURCE FOR PROJECTOR LAMPS AND ACCESSORIES

Sub Menu	Function
Auto Setup	You can select whether or not (On/Off) Auto Setup automatically adjusts the image to the optimum state when the Input Signal changes. p.89

Sub Menu	Function
Resolution	When set to Auto , the resolution of the input signal is automatically identified. If the images cannot be projected correctly when set to Auto , such as when some of the image is missing, adjust to Wide depending on the connected computer for wide screens, or set to Normal for 4:3 or 5:4 screens.
Tracking	You can adjust computer images when vertical stripes appear in the images.  p.89
Sync.	You can adjust computer images when flickering, fuzziness, or interference appear in the images.  p.89
Position	You can adjust the display Position up, down, left, and right when a part of the image is missing so that the whole image is projected.
Progressive	(When component video or RGB video signal is input, this setting can only be adjusted when 480i/576i/1080i signals are being input. This cannot be set when a digital RGB signal is input.) Off: IP conversion is carried out for each field in the screen. This is ideal for viewing images with a large amount of movement. On: <u>Interlace</u> (i) signal is converted to <u>Progressive</u> (p). Applies to still images. Video: This is ideal for viewing general video images. Film/Auto: This is ideal for movie films, CG and animation.
Noise Reduction	(This cannot be set when a digital RGB signal is input) Smooths out rough images. There are two modes. Select your favorite setting. It is recommended that this is set to Off when viewing image sources in which noise is very low, such as for DVDs.
HDMI Video Range (EB-1925W/1915 only)	(This cannot be set when a digital RGB signal is input) When the projector's HDMI input port is connected to a DVD player and so on, the projector's video range is set according to the DVD player's video range setting.
Input Signal	You can select an input signal from Computer input port or Computer1/2 input port. If set to Auto the input signal is set automatically according to the connected equipment. If colors do not appear correctly when set to Auto , select the appropriate signal according to the connected equipment.
Video Signal	You can select input signal from Video input port or S-Video input port. If set to Auto , video signals are recognized automatically. If interference appears in the image or a problem occurs such as no image is being projected when set to Auto , select the appropriate signal according to the connected equipment.
Aspect	You can set the <u>Aspect Ratio</u> for projected images.  p.33
Reset	You can reset all adjustment values on the Signal menu to their default settings, except for Input Signal . To reset all menu items to their default settings, see  p.80

Settings Menu



Sub Menu	Function
Keystone (EB-1925W/1915)	You can correct keystone distortion. H/V-Keystone: Corrects horizontal and vertical keystone distortion. Select one of V-Keystone or H-Keystone . If you set Auto H/V-Keystone to On , distortions and focus of the projected image are automatically corrected when the projector is moved. (Only when Front is selected for Extended - Projection) When set to Off , adjust the projected image manually.  Quick Start Guide Quick Corner: Selects and corrects the four corners of the projected image.  p.26
Keystone (EB-1920W/ 1910/1900/1830)	You can correct keystone distortion in the vertical directions.  Quick Start Guide
Auto Keystone (EB-1920W/1910/1830 only)	Turn On to automatically perform Keystone correction in vertical direction. (Only when Front is selected for Extended - Projection)  Quick Start Guide
Control Panel Lock	You can use this to restrict operation of the projector's Control panel.  p.49
Pointer Shape	You can select the shape of the pointer.  p.38 Pointer 1:  Pointer 2:  Pointer 3: 
Power Consumption	You can set the Lamp brightness to one of two settings. Select ECO if the images being projected are too bright such as when projecting images in a dark room or onto a small screen. When ECO is selected, the amount of electricity consumed and the lamp's operating life are changed as follows, and fan rotation noise during projection is reduced. Electrical consumption: about 26% decrease, lamp life: about 1.3 times longer

Sub Menu	Function
Volume (EB-1925W/1920W/ 1915/1910/1830 only)	You can adjust the Volume. Setting details are saved for each source.
Remote Receiver	You can limit the reception of the operation signal from the Remote Control. When you want to prohibit operation by Remote Control, or if the Remote Receiver has a fluorescent light too close to it, you can make settings to deactivate the remote receiver you do not want to use or that is experiencing interference.
User Button	You can select the item assigned from the Configuration Menu with the Remote Control's [User] button. By pressing the [User] button the assigned menu item selection/adjustment screen is displayed, allowing you to make one-touch settings/adjustments. You can assign one of the following items to the [User] button. Power Consumption, Info, Progressive, Test Pattern, Multi-screen, Resolution
Test Pattern	When the projector is setup, a Test Pattern is displayed so that you can adjust the projection without connecting other equipment. While the test pattern is displayed, you can perform Quick Corner (EB-1925W/1915 only), Adjust Zoom , Adjust Focus , and Keystone . To cancel the Test Pattern, press the [Return] button on the Remote Control or the Control panel.
Reset	You can reset all adjustment values on the Settings menu to their default settings, except for User Button . To return all menu items to their default settings, see  p.80

Extended Menu

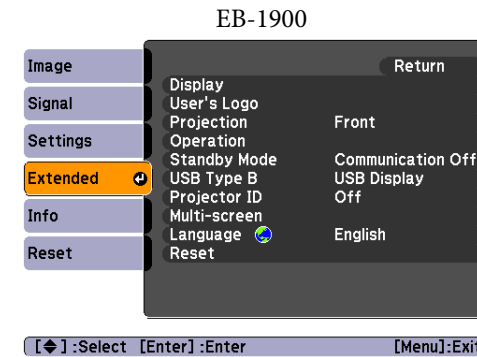
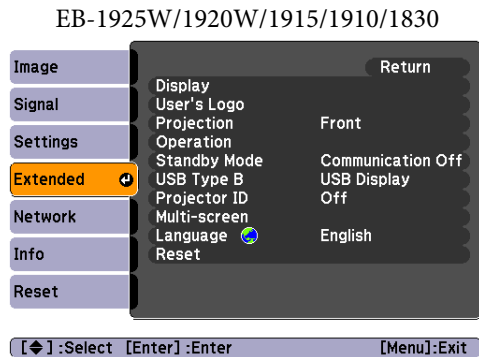

Sub Menu	Function
Display	<p>You can make settings related to the projector's display.</p> <p>Messages: When set to Off, the following items will not be displayed. The name of the current selection when changing the Source, Color Mode or Aspect; a message when no image signal is input; warnings such as the High Temp Warning.</p> <p>Display Background*¹: You can set the screen status for when no image signal is available to Black, Blue, or Logo.</p> <p>Startup Screen*¹: You can set whether or not (On/Off) the Startup Screen (the image projected when starting the projector) is displayed.</p> <p>A/V Mute*¹: You can set the screen displayed during A/V Mute as Black, Blue, or Logo.</p>
User's Logo* ¹	<p>You can change the User's Logo that is displayed as a background during Display Background, A/V Mute, and so on. p.105</p>
Projection	<p>You can set from the following according to the way the projector is setup. p.95</p> <p>Front, Front/Ceiling, Rear, Rear/Ceiling</p> <p>You can change the setting as follows by pressing down the [A/V Mute] button on the Remote Control for about five seconds.</p> <p>Front ↔ Front/Ceiling</p> <p>Rear ↔ Rear/Ceiling</p>



Sub Menu	Function
Operation	<p>Direct Power On: You can set whether or not (On/Off) to enable Direct Power On. When it is set to On and the power cable is plugged in, be aware that the projector turns on automatically in case such as a power outage is restored.</p> <p>Sleep Mode: When set to On, this automatically stops projection when no image signal is being input and no operations are carried out.</p> <p>Sleep Mode Timer: When Sleep Mode is set to On, you can set the time before the projector automatically turns off within a range of one to 30 minutes.</p> <p>Lens Cover Timer: When set to On, this turns off the power automatically 30 minutes after the A/V mute slide is closed. Lens Cover Timer is set to On at the time of purchase.</p> <p>High Altitude Mode: Set to On when using the projector above an altitude of 1500 m.</p>
Standby Mode	<p>You can use network monitoring and control functions while the projector is in standby mode when this is set to Network On. You can use SNMP to monitor and control the status of the projector over the network, or by using the EasyMP Monitor software *2 supplied with this product.</p>
USB Type B	<p>Set to USB Display when the projector and a computer are connected by a USB cable and computer images are projected. p.115</p> <p>Set to Wireless Mouse when the mouse pointer is to be operated by the Remote Control. p.40</p>
Projector ID	<p>Set the ID to a number between 1 and 9. Off indicates that no ID is set. p.42</p>
Multi-screen	<p>You can adjust the hue and brightness of each projected image when multiple projectors are lined up and projecting. p.45</p> <p>Adjustment Level: You can adjust from black to white in five stages called Level 1 to 5, and in each of these 5 levels you can adjust Brightness Correct. and Color Correct.</p> <p>Brightness Correct.: Corrects the difference in the brightness of each projector.</p> <p>Color Correct. (G/R) / Color Correct. (B/Y): You can correct the difference in the color of each projector.</p>
Language	<p>You can set the language for message displays.</p>
Reset	<p>You can reset Display*1 and Operation*3 from the Extended menu to their default settings.</p> <p>To return all menu items to their default settings, see p.80</p>

*1 When **User's Logo Protect** is set to **On** in **Password Protect**, settings relating to User's Logo cannot be changed. You can make changes after setting **User's Logo Protect** to **Off**. p.47

*2 A commercially available serial ↔ IP conversion adapter and connector cable are necessary to allow EB-1900 owners to use EasyMP Monitor. For supported products, see <http://www.epson.com>.

*3 Except for "High Altitude Mode".

Network Menu (EB-1925W/1915 Only)

When **Network Protect** is set to **On** in **Password Protect**, a message is displayed and the network settings cannot be changed. Turn **Network Protect Off** and then configure the network. [p.47](#)

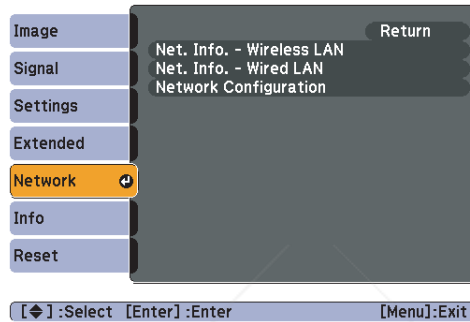

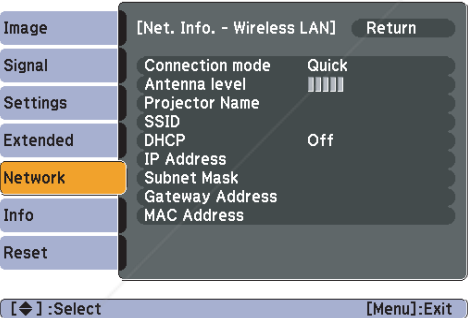
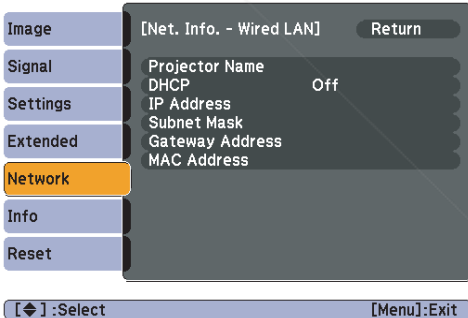
Sub Menu	Function
<p>Net. Info. - Wireless LAN Net. Info. - Wired LAN</p>	<p>You can confirm the setting status for each network as follows.</p> <div style="display: flex; justify-content: space-around;"> <div data-bbox="555 874 1021 1193">  <p>The screenshot shows a vertical menu on the left with options: Image, Signal, Settings, Extended, Network (highlighted), Info, and Reset. The main display area shows: [Net. Info. - Wireless LAN], Return, Connection mode Quick, Antenna level (5 bars), Projector Name, SSID, DHCP Off, IP Address, Subnet Mask, Gateway Address, and MAC Address. A control bar at the bottom shows: [Left Arrow] :Select [Right Arrow] :Menu:Exit</p> </div> <div data-bbox="1191 874 1657 1193">  <p>The screenshot shows a vertical menu on the left with options: Image, Signal, Settings, Extended, Network (highlighted), Info, and Reset. The main display area shows: [Net. Info. - Wired LAN], Return, Projector Name, DHCP Off, IP Address, Subnet Mask, Gateway Address, and MAC Address. A control bar at the bottom shows: [Left Arrow] :Select [Right Arrow] :Menu:Exit</p> </div> </div>
<p>Network Configuration</p>	<p>The following menus are available for setting Network items. Basic Menu, Wireless LAN Menu, Security Menu, Wired LAN Menu, Mail Menu, Others Menu, Reset Menu, Setup complete Menu</p>



By using the Web on a computer connected to the projector on a network, you can set the functions and control the projector. This function is called Web Control. You can easily enter text using a keyboard to make settings for Web Control such as Security settings.

 [Projector Operation Guide "Changing Settings Using a Web Browser \(Web Control\)"\(EB-1925W/1915\)](#)

Notes on operating the Network menu

Selecting from the top menu and sub menus, and changing of selected items are the same as operations in the Configuration Menu.

When done, make sure you go to the **Setup complete** menu, and select one of **Yes**, **No**, or **Cancel**. When you select **Yes** or **No**, you return to the Configuration Menu.

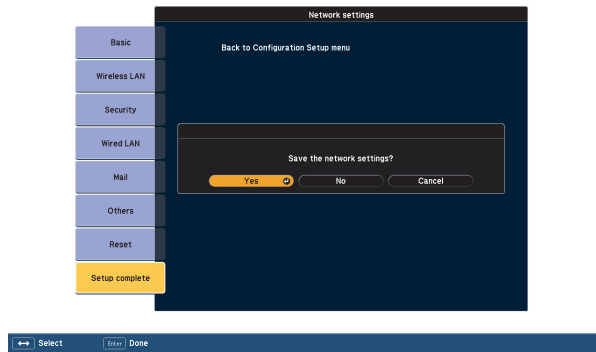

Yes: Saves the settings and exits the Network menu.

No: Does not save the settings and exits the Network menu.

Cancel: Continues displaying the Network menu.

Soft keyboard operations

The Network menu contains items that require input of alphanumerics during setup. In this case, the following software keyboard is displayed.

Use the [▲], [▼], [←], and [→] buttons on the Remote

Control or the [▲], [▼], [←], and [→] buttons on the Control panel to move the cursor to the desired key, and then press the [Enter] button to enter the alphanumeric. Enter figures by holding down the [Num] button on the Remote Control, and pressing the numeric

buttons. After inputting, press [Finish] on the keyboard to confirm your input. Press [Cancel] on the keyboard to cancel your input.

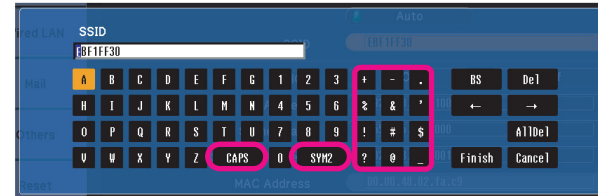

- Each time the [CAPS] key is selected, it sets and changes between upper case and lower case letters.
- Each time the [SYM1/2] key is selected, it sets and changes the symbol keys for the section enclosed by the frame.

Basic Menu

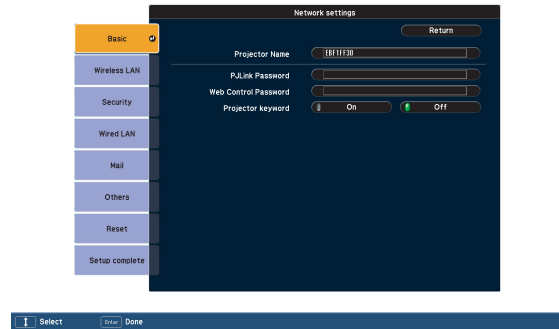

Sub Menu	Function
Projector Name	Displays the projector name used to identify the projector when connected to a Network. When editing, you can enter up to 16 single-byte alphanumeric characters.
PJLink Password	Set a Password to use when you access the projector using compatible PJLink software. You can enter up to 32 single-byte alphanumeric characters.
Web Control Password	Set a password to use when making settings and controlling the projector using Web Control. Enter no more than eight single-byte alphanumeric characters. Web Control is a computer function that allows you to set up and control the projector by using the Web browser on a computer connected on a Network. Projector Operation Guide "Changing Settings Using a Web Browser (Web Control)"(EB-1925W/1915)
Projector keyword	When set to On , you have to enter the Keyword when you try to connect the projector to a computer on a Network. As a result, you can prevent presentations from being interrupted by unscheduled connections from the computer. Normally this should be set to On . Projector Operation Guide "Connecting to a Projector on a Network and Projecting"(EB-1925W/1915)



Discount-Merchant.com (800) 281-8860
THE TRUSTED SOURCE FOR PROJECTOR LAMPS AND ACCESSORIES

Wireless LAN menu (only when the supplied or optional Wireless LAN unit is inserted)



Sub Menu	Function
Wireless LAN Power	Turn On when connecting the projector to the computer over wireless LAN. If you do not want to connect via wireless LAN, turn it Off to prevent unauthorized access by others. This is set to On by default.
Connection mode	When the projector is connected to a computer with EasyMP Network Projection, set so that it is in a permanently connected mode.
Wi-Fi Protected Setup	When using a Wi-Fi Protected Setup compatible access point via a wireless LAN, you can easily connect the projector to the access point and make security settings. p.107
Wireless LAN system	Sets the Wireless LAN system. When set to Auto , whichever of the 802.11g, 802.11b, and 802.11a standards that is compliant to your environment is automatically selected. (Auto can be set only if Connection mode is set to Advanced .) In an area that does not support 802.11a, only 802.11g/b is displayed. (802.11a and Auto are not displayed)
SSID	Enter an SSID . When an SSID is provided for the Wireless LAN system in which the projector participates, enter the SSID. You can enter up to 32 single-byte alphanumeric characters.
DHCP	Set whether or not (On/Off) to use DHCP . If this is set to On you cannot set any more addresses.
IP Address	You can input the IP Address assigned to the projector. You can enter a number from 0 to 255 in each field of the address. However, the following IP Addresses cannot be used. 0.0.0.0, 127.x.x.x, 224.0.0.0 to 255.255.255.255 (where x is a number from 0 to 255)
Subnet Mask	You can input the subnet mask for the projector. You can enter a number from 0 to 255 in each field of the address. However, the following Subnet Masks cannot be used. 0.0.0.0, 255.255.255.255
Gateway Address	You can input the IP address for the gateway for the projector. You can enter a number from 0 to 255 in each field of the address. However, the following gateway addresses cannot be used. 0.0.0.0, 127.x.x.x, 224.0.0.0 to 255.255.255.255 (where x is a number from 0 to 255)

Sub Menu	Function
MAC Address	Displays the MAC address.
SSID Display	To prevent the <u>SSID</u> from being displayed on the LAN Standby screen, set this to Off .
IP Address Display	To prevent the <u>IP Address</u> from being displayed on the LAN Standby screen, set this to Off .

Security menu (available when the supplied or optional Wireless LAN unit is inserted)

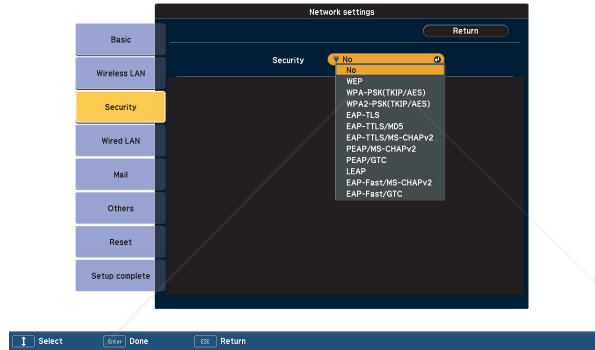

Sub Menu	Function
Security	Select the security type from the items that are displayed. When setting up Security, follow the instructions from the administrator of the network system you are about to access.

Type of security

When the supplied or optional wireless LAN unit is installed and being used in Advanced Connection Mode, it is strongly recommended that you set security. Select one of the following security methods.

- **WEP**

Data is encrypted with a code key (WEP key). This mechanism prevents communication unless the encrypted keys for the access point and the projector match.

- **WPA**

This is an encryption standard that improves security which is a weak point of WEP. Although there are multiple kinds of WPA encryption methods, this projector uses TKIP and AES.

WPA also includes user authentication functions. WPA authentication provides two methods: using an authentication server, or authenticating between a computer and an access point without a server. This projector supports the latter method, without a server.

- **EAP**

EAP is a protocol used for communication between clients and authentication servers. These are multiple protocols, such as EAP-TLS which uses electronic certification for user authentication, and LEAP and EAP-TTLS, which use user ID and password.

System	Authentication
EAP-TLS	Electronic certification, CA certification
EAP-TTLS	User ID, Password
PEAP	User ID, Password
LEAP	User ID, Password
EAP-Fast	User ID, Password



- For setting details, follow the directions from the network administrator of your network.
- If using EAP, you need to make settings at the projector that match the authentication server settings. Check with your network administrator for details on RADIUS settings.
- Save the electronic certificate and the CA certificate onto a USB storage device and register them to the projector with PC Free. Only one pair of electronic certificate and CA certificate can be registered to the projector. These certificates are used with EAP-TLS. [Projector Operation Guide \(EB-1925W/1915\)](#)

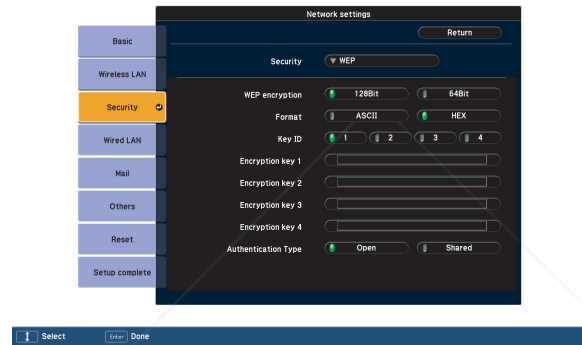

When WEP is selected

Sub Menu	Function
WEP encryption	You can set the encryption for WEP encryption. 128Bit: Uses 128 (104) bit encoding 64Bit: Uses 64 (40) bit encoding.
Format	You can set the input method for the WEP encryption key. ASCII: Input text. HEX: Input in HEX (hexadecimal).
Key ID	Selects the WEP encryption ID key.

Sub Menu	Function
Encryption key 1/ Encryption key 2/ Encryption key 3/ Encryption key 4	<p>You can enter the key used for WEP encryption. Enter the key in single-byte characters following instructions from the network administrator for the network in which the projector participates. The type of character and the number that can be entered differ according to the WEP encryption and Format settings.</p> <p>If the number of characters you enter is shorter than the required character length, no character is encrypted. If the number of characters you enter is longer than the required character length, characters that exceed the permitted number are not encrypted.</p> <p>128Bit - ASCII: Single-byte alphanumeric, 13 characters. 64Bit - ASCII: Single-byte alphanumeric, 5 characters. 128Bit - HEX: 0 to 9 and A to F, 26 characters 64Bit - HEX: 0 to 9 and A to F, 10 characters</p>
Authentication Type	<p>Set the WEP authentication type.</p> <p>Open: Uses open system authentication. Shared: Uses shared key authentication.</p>

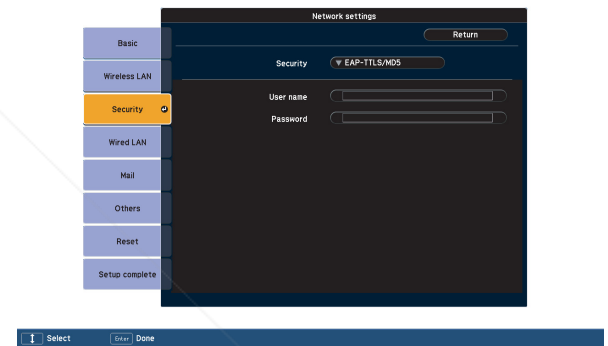
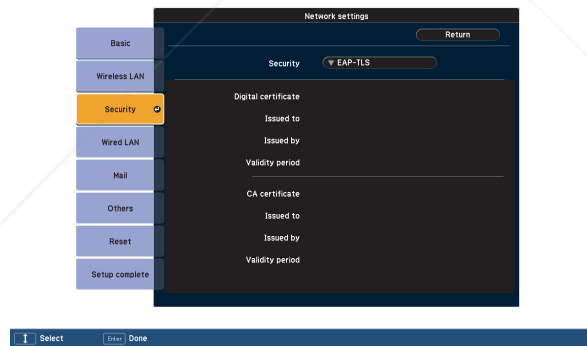
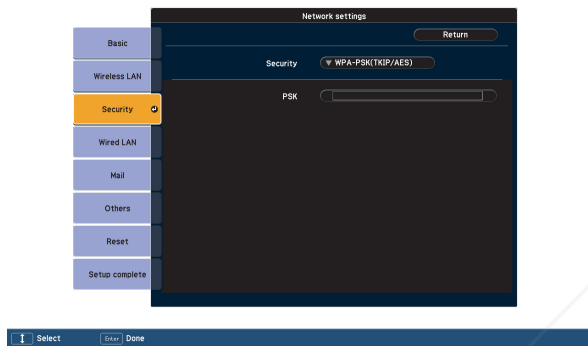

When WPA-PSK(TKIP/AES) or WPA2-PSK(TKIP/AES) is selected

Sub Menu	Function
PSK (Encryption key)	<p>You can enter a Pre-Shared Key (encrypted key) in single-byte alphanumeric characters. Enter at least 8 and up to 32 characters. After entering the Pre-Shared Key, confirming it with the [Enter] button displays the value in asterisks(*).</p>

When EAP-TLS is selected

Sub Menu	Function
Issued by/Issued to/Validity period	Information in the certificate is displayed. You cannot enter.

When EAP-TTLS/MD5, EAP-TTLS/MS-CHAPv2, PEAP/MS-CHAPv2, PEAP/GTC, LEAP, EAP-Fast/MS-CHAPv2, EAP-Fast/GTC is selected

Sub Menu	Function
User name	You can enter a user name to be used for authentication in single-byte alphanumeric characters (no spaces). You can enter up to 32 characters.
Password	You can enter a password to use for authentication in single-byte alphanumeric characters. You can enter up to 32 characters. After entering the password, confirming it with the [Enter] button displays the value in asterisks(*).

Wired LAN Menu



Sub Menu	Function
DHCP	Set whether or not (On/Off) to use DHCP. If this is set to On you cannot set any more addresses.
IP Address	You can input the IP Address assigned to the projector. You can enter a number from 0 to 255 in each field of the address. However, the following IP Addresses cannot be used. 0.0.0.0, 127.x.x.x, 224.0.0.0 to 255.255.255.255 (where x is a number from 0 to 255)

FixYourDLP.com
 Sponsored by 

Discount-Merchant.com (800) 281-8860
 THE TRUSTED SOURCE FOR PROJECTOR LAMPS AND ACCESSORIES

Sub Menu	Function
Subnet Mask	You can input the <u>subnet mask</u> for the projector. You can enter a number from 0 to 255 in each field of the address. However, the following Subnet Masks cannot be used. 0.0.0.0, 255.255.255.255
Gateway Address	You can input the IP address for the gateway for the projector. You can enter a number from 0 to 255 in each field of the address. However, the following <u>gateway addresses</u> cannot be used. 0.0.0.0, 127.x.x.x, 224.0.0.0 to 255.255.255.255 (where x is a number from 0 to 255)
MAC Address	Displays the MAC address.
IP Address Display	To prevent the IP address from being displayed on the LAN Standby screen, set this to Off.

Mail menu

When this is set, you receive an e-mail notification if a problem or warning occurs in the projector. [p.121](#)



Sub Menu	Function
Mail Notification	You can set whether or not (On/Off) to be notified by e-mail.
SMTP Server	You can input the <u>IP Address</u> for the SMTP Server for the projector. You can enter a number from 0 to 255 in each field of the address. However, the following IP Addresses cannot be used. 127.x.x.x, 224.0.0.0 to 255.255.255.255 (where x is a number from 0 to 255)
Port Number	You can input the <u>Port Number</u> for the SMTP Server. The default value is 25. You can input numbers between 1 to 65535.
Email Address 1/Email Address 2/Email Address 3	You can input the e-mail address of the destination to send the notification e-mail to. You can register up to three destinations. You can enter up to 32 single-byte alphanumeric characters for the e-mail addresses.

Sub Menu	Function
Setting a Notification Event	You can select the problems or warnings to be notified about by e-mail. When the selected problem or warning occurs in the projector, an e-mail is sent to the specified Destination address notifying that a problem or warning has occurred. You can select multiple items from the displayed items.

Others Menu



Sub Menu	Function
SNMP Trap IP Address 1/ SNMP Trap IP Address 2	You can register up to two IP addresses for the SNMP trap notification destination. You can enter a number from 0 to 255 in each field of the address. However, the following IP Addresses cannot be used. 127.x.x.x, 224.0.0.0 to 255.255.255.255 (where x is a number from 0 to 255) To use SNMP to monitor the projector, you need to install the SNMP manager program on your computer. SNMP should be managed by a network administrator.
Priority gateway	For the priority gateway, select either wireless or wired.
AMX Device Discovery	When the projector is connected to a network, set this to On to allow the projector to be detected by AMX Device Discovery . Set this to Off if you are in a network environment controlled with a controller from AMX or AMX Device Discovery.

Reset menu

Resets all of the network settings.

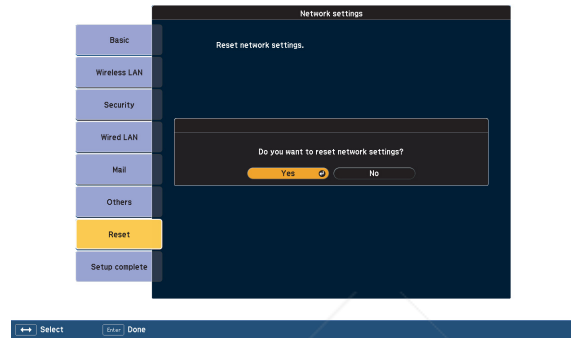

Sub Menu	Function
Reset network settings.	To reset all of the Network settings, select Yes . After you Reset all the settings, the Basic menu appears.

Network Menu (EB-1920W/1910/1830 Only)

When **Network Protect** is set to **On** in **Password Protect**, a message is displayed and the network settings cannot be changed. Turn **Network Protect Off** and then configure the network. [p.47](#)

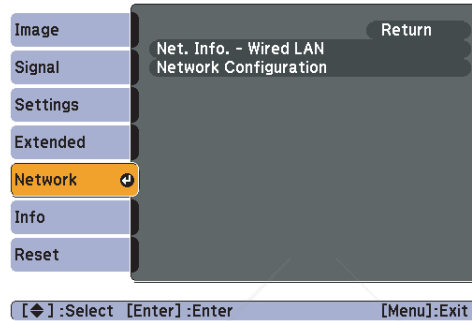

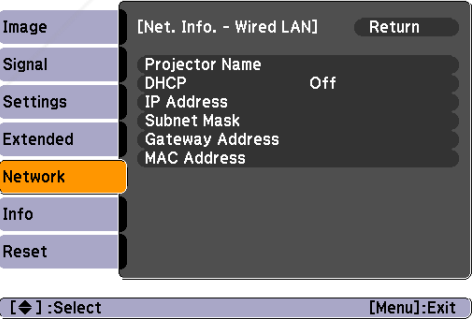
Sub Menu	Function
<p>Net. Info. - Wired LAN</p>	<p>You can confirm the setting status for the network as follows.</p> 
<p>Network Configuration</p>	<p>The following menus are available for setting Network items. Basic menu, Wired LAN menu, Mail menu, Others menu, Reset menu, Setup complete menu</p>

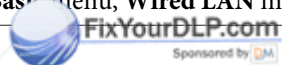

By using the Web browser of a computer connected to the projector on a network, you can set the functions and control the projector. This function is called Web Control. You can easily enter text using a keyboard to make settings for Web Control such as Security settings. [Projector Operation Guide](#)
 "Changing Settings Using a Web Browser (Web Control)" (EB-1920W/1910/1830)

Discount Merchant.com (800) 281-8860
 THE TRUSTED SOURCE FOR PROJECTOR LAMPS AND ACCESSORIES

Notes on operating the Network menu

Selecting from the top menu and sub menus, and changing of selected items are the same as operations in the Configuration Menu.

When done, make sure you go to the **Setup complete** menu, and select one of **Yes**, **No**, or **Cancel**. When you select **Yes** or **No**, you return to the Configuration Menu.

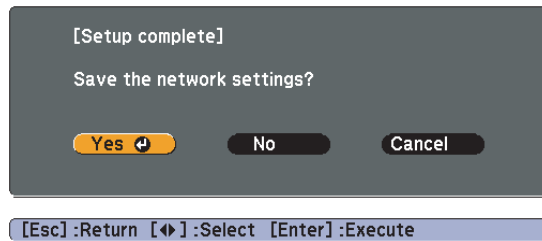



Yes: Saves the settings and exits the Network menu.



No: Does not save the settings and exits the Network menu.

Cancel: Continues displaying the Network menu.

Soft keyboard operations

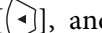
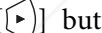
The Network menu contains items that require input of alphanumerics during setup. In this case, the following software keyboard is displayed.

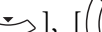
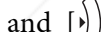
Use the , , , and  buttons on the Remote

Control or the , , , and  buttons on the Control

panel to move the cursor to the desired key, and then press the [Enter] button to enter the alphanumeric. Enter figures by holding down the [Num] button on the Remote Control, and pressing the numeric buttons. After inputting, press [Finish] on the keyboard to confirm your input. Press [Cancel] on the keyboard to cancel your input.

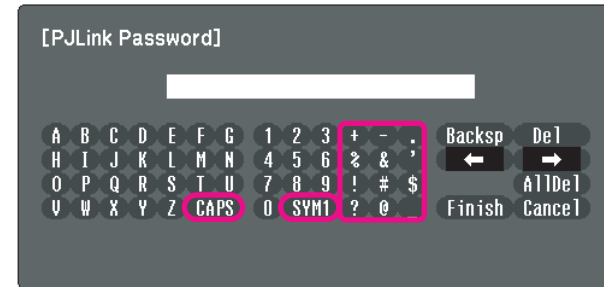

- Each time the [CAPS] key is selected, it sets and changes between upper case and lower case letters.
- Each time the [SYM1/2] key is selected, it sets and changes the symbol keys for the section enclosed by the frame.

Basic menu

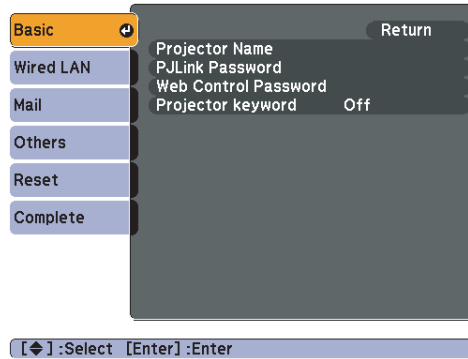

Sub Menu	Function
Projector Name	Displays the projector name used to identify the projector when connected to a network. When editing, you can enter up to 16 single-byte alphanumeric characters.
PJLink Password	Set a Password to use when you access the projector using compatible PJLink software. p.125 You can enter up to 32 single-byte alphanumeric characters.
Web Control Password	Set a password to use when making settings and controlling the projector using Web Control. You can enter up to 8 single-byte alphanumeric characters. Web Control is a computer function that allows you to set up and control the projector by using the Web browser on a computer connected on a Network. Projector Operation Guide "Changing Settings Using a Web Browser (Web Control)" (EB-1920W/1910/1830)
Projector keyword	When set to On , you have to enter the Keyword when you try to connect the projector to a computer on a Network. As a result, EasyMP Network Projection can prevent presentations from being interrupted by unscheduled connections from a computer during projection. Normally this should be set to On . Projector Operation Guide "Connecting to a Projector on a Network and Projecting" (EB-1920W/1910/1830)



Discount-Merchant.com (800) 281-8860
THE TRUSTED SOURCE FOR PROJECTOR LAMPS AND ACCESSORIES

Wired LAN menu

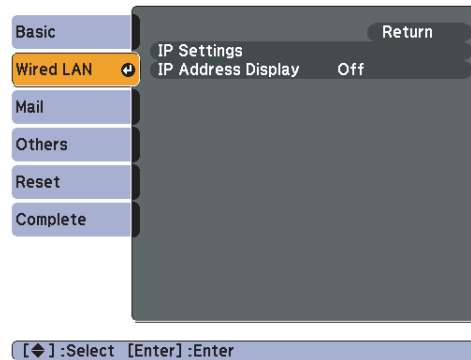

Sub Menu	Function
IP Settings	<p>You can make network settings.</p> <p>DHCP: Select whether or not (On/Off) to use DHCP. If this is set to On you cannot set any more addresses.</p> <p>IP Address: You can input the IP Address assigned to the projector. You can enter a number from 0 to 255 in each field of the address. However, the following IP Addresses cannot be used. 0.0.0.0, 127.x.x.x, 224.0.0.0 to 255.255.255.255 (where x is a number from 0 to 255)</p> <p>Subnet Mask: You can input the Subnet Mask for the projector. You can enter a number from 0 to 255 in each field of the address. However, the following Subnet Masks cannot be used. 0.0.0.0, 255.255.255.255</p> <p>Gateway Address: You can input the IP Address for the gateway for the projector. You can enter a number from 0 to 255 in each field of the address. However, the following gateway addresses cannot be used. 0.0.0.0, 127.x.x.x, 224.0.0.0 to 255.255.255.255 (where x is a number from 0 to 255)</p>
IP Address Display	To prevent the IP Address from being displayed on Network Info in the Network Menu and on the LAN Standby screen, set this to Off .

Mail menu

When this is set, you receive an e-mail notification if a problem or warning occurs in the projector. For information on the contents of the sent Mail, see "[Reading Problem Mail Notification Function \(EB-1925W/1920W/1915/1910/1830 Only\)](#)" p.121

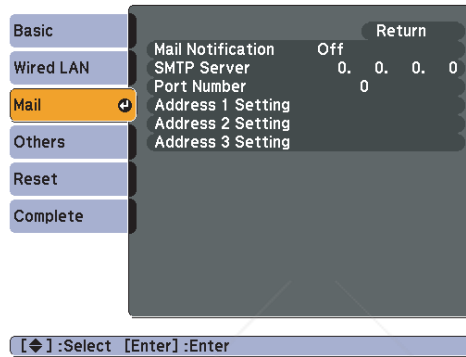

Sub Menu	Function
Mail Notification	You can set whether or not (On/Off) to be notified by e-mail.
SMTP Server	You can input the <u>IP Address</u> for the SMTP Server for the projector. You can enter a number from 0 to 255 in each field of the address. However, the following IP Addresses cannot be used. 127.x.x.x, 224.0.0.0 to 255.255.255.255 (where x is a number from 0 to 255)
Port Number	You can input the Port Number for the SMTP Server. The default value is 25. You can input numbers between 1 to 65535.
Address 1 Setting Address 2 Setting Address 3 Setting	Input the Email Address and the contents of the Mail to receive notification when an abnormality or warning occurs in the projector. You can enter up to 32 single-byte alphanumeric characters for the e-mail addresses. You can select multiple problems or warnings to be notified about by Mail. You can also change each Email Address.

Others menu

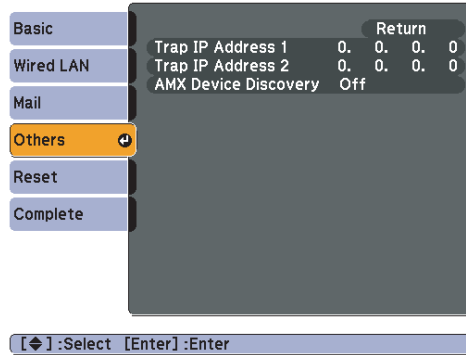

Sub Menu	Function
<p>Trap IP Address 1 Trap IP Address 2</p>	<p>You can register up to two IP addresses for the SNMP trap notification destination. You can enter a number from 0 to 255 in each field of the address. However, the following IP Addresses cannot be used. 127.x.x.x, 224.0.0.0 to 255.255.255.255 (where x is a number from 0 to 255) To use SNMP to monitor the projector, you need to install the SNMP manager program on your computer. SNMP should be managed by a network administrator.</p>
<p>AMX Device Discovery</p>	<p>When the projector is connected to a network, set this to On to allow the projector to be detected by AMX Device Discovery. Set this to Off if you are not connected to an environment controlled with a controller from AMX or AMX Device Discovery.</p>



Discount-Merchant.com (800) 281-8860
THE TRUSTED SOURCE FOR PROJECTOR LAMPS AND ACCESSORIES

Reset menu

Resets all of the network settings.

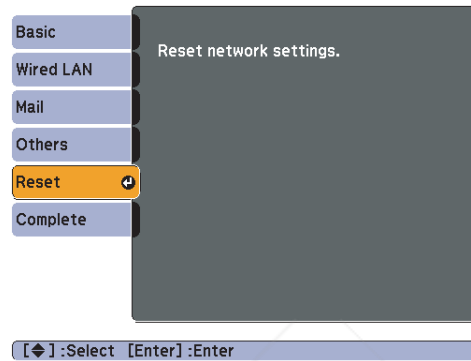

Sub Menu	Function
Reset network settings.	To reset all of the Network settings, select Yes . After you Reset all the settings, the Basic menu appears.

Info Menu (Display Only)

Lets you check the status of the image signals being projected and the status of the projector. Items that can be displayed vary depending on the Source currently being projected as shown in the following screen shots. Depending on the model used, some input sources are not supported. [p.29](#)

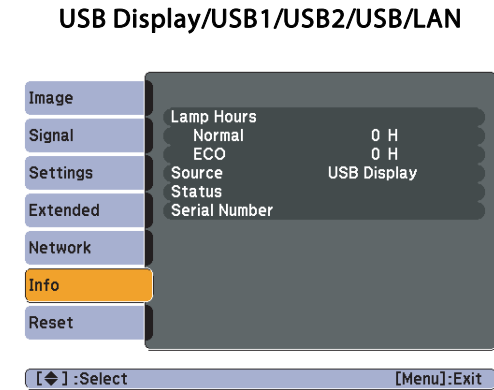
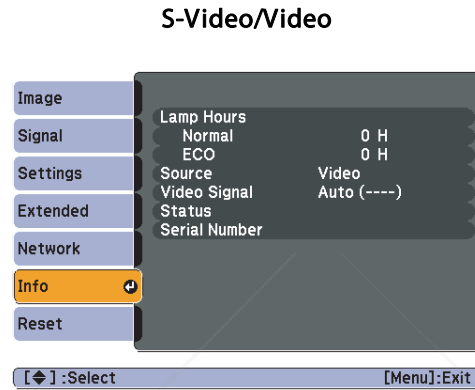
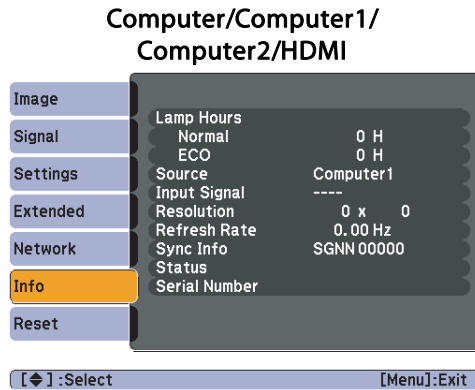

Sub Menu	Function
Lamp Hours	You can display the cumulative Lamp operating time*. When it reaches the lamp warning time, the characters are displayed in yellow.
Source	You can display the Source name for the connected equipment currently being projected.
Input Signal	You can display the content of Input Signal set in the Signal menu according to the Source.
Resolution	You can display the Resolution.
Video Signal	You can display the content of Video Signal set in the Signal menu.
Refresh Rate	You can display the <u>refresh rate</u> ».
Sync Info	You can display the image signal info. This information may be needed if service is required.
Status	This information about errors that have occurred on the projector. This information may be needed if service is required.
Serial Number	Displays the projector's serial number.

* The cumulative use time is displayed as "0H" for the first 10 hours. 10 hours and above is displayed as "10H", "11H", and so on.

Reset Menu

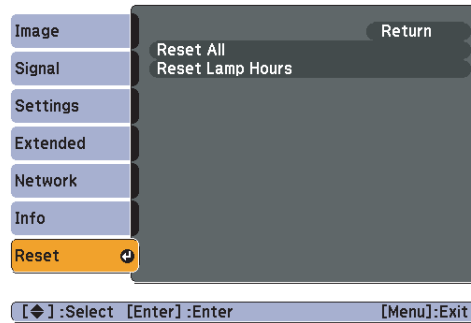

Sub Menu	Function
Reset All	You can reset all items in the Configuration Menu to their default settings. The following items are not reset to their defaults: Input Signal , User's Logo , all items for Network menus*, Lamp Hours , and Language .
Reset Lamp Hours	You can clear the cumulative Lamp Hours use time, and return it to "0H". Reset when you replace the Lamp.

* (EB-1925W/1920W/1915/1910/1830 only)



Troubleshooting

This chapter explains how to identify problems and what to do if a problem is found.



Discount-Merchant.com (800) 281-8860
THE TRUSTED SOURCE FOR PROJECTOR LAMPS AND ACCESSORIES

If a problem occurs with the projector, the Help screen is displayed to assist you by pressing the Help button. You can solve problems by answering the questions.

Procedure

1 Press the [Help] button.

The Help screen is displayed.

Using the Remote Control

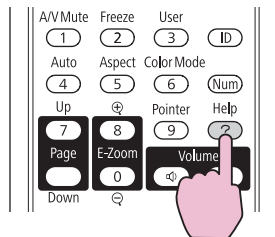

Using the Control panel

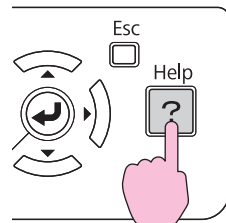

2 Select a menu item.

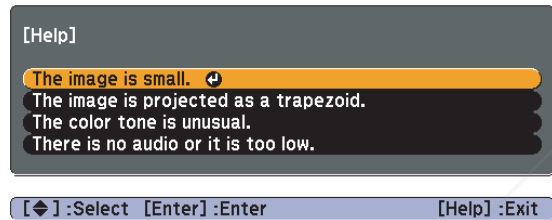

3 Confirm the selection.

Using the Remote Control

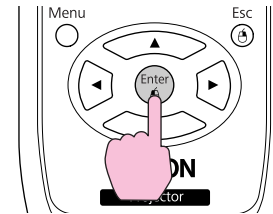

Using the Control panel

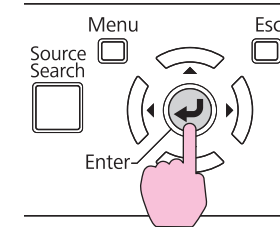

Questions and solutions are displayed as shown on the screen below. Press the [Help] button to exit Help.

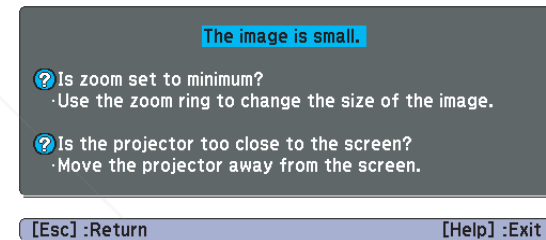

If the Help screen does not provide a solution to the problem, refer to "Problem Solving" p.83.

Using the Remote Control

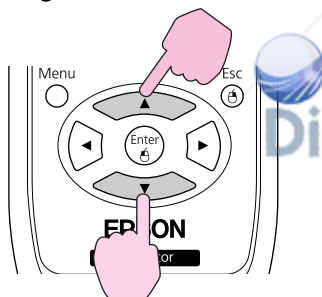

Using the Control panel

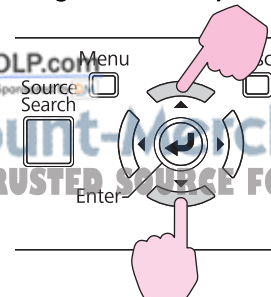





If you are having a problem with the projector, first check the projector's indicators and refer to "Reading the Indicators" below.

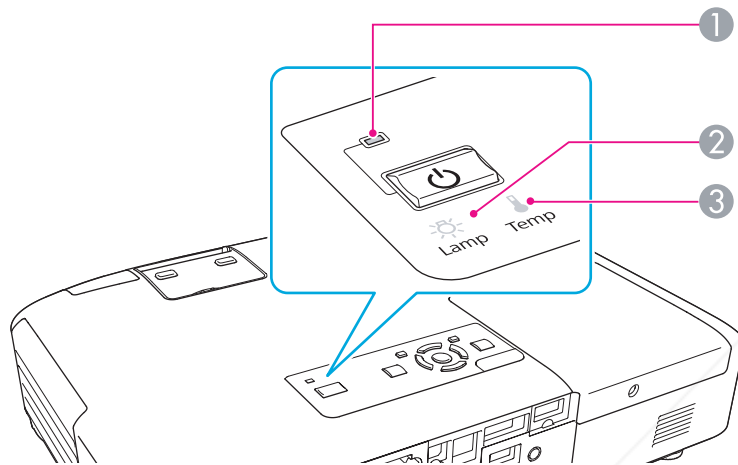

If the indicators do not show clearly what the problem might be, refer to "When the Indicators Provide No Help". [p.86](#)

Reading the Indicators

The projector is provided with the following three indicators that indicate the operating status of the projector.



- | | |
|---|--|
| <p>① Indicates the operating status.</p> | <p> Standby condition
When the [⏻] button is pressed in this condition, projection starts.</p> <p> Preparing network monitoring or cool down in progress
All buttons are disabled while the indicator is flashing.</p> <p> Warming up
Warm-up time is about 30 seconds. After warm-up is complete, the indicator stops flashing.</p> <p> The [⏻] button is disabled during warm-up.
Projecting</p> |
| <p>② Indicates the projection lamp status.</p> | |
| <p>③ Indicates the internal temperature status.</p> | |

FixYourDLP.com
 Sponsored by

Discount-Merchant.com (800) 281-8860
THE TRUSTED SOURCE FOR PROJECTOR LAMPS AND ACCESSORIES



Refer to the following table to see what the indicators mean and how to remedy problems that they indicate.

If all indicators are off, check that the power cable is connected correctly and that the power is being supplied normally. Sometimes, when the power cable is unplugged, the indicator remains lit for a short period, but this is not a fault.





Indicator is lit or flashing red





: Lit : Flashing : Off

Status	Cause	Remedy or Status
	Internal Error	Stop using the projector, disconnect the power cable from the electrical outlet, and contact your local dealer or the nearest address provided in the Support and Service Guide. Epson Projector Contact List
	Fan Error Sensor Error	Stop using the projector, disconnect the power cable from the electrical outlet, and contact your local dealer or the nearest address provided in the Support and Service Guide. Epson Projector Contact List
	High Temp Error (overheating)	<p>The lamp turns off automatically and projection stops. Wait for about five minutes. After about five minutes the projector switches to standby mode, so check the following two points.</p> <ul style="list-style-type: none"> • Check that the air filter and Air exhaust vent are clear, and that the projector is not positioned against a wall. • If the air filter is clogged, clean or replace it. p.97,p.102 <p>If the error continues after checking the points above, stop using the projector, disconnect the power cable from the electrical outlet, and contact your local dealer or the nearest address provided in the Support and Service Guide. Epson Projector Contact List</p> <p>When using at an altitude of 1500 m or more, set High Altitude Mode to On. p.58</p>
	Lamp Error Lamp Failure	<p>Check the following two points.</p> <ul style="list-style-type: none"> • Take out the Lamp and check if it is cracked. p.99 • Clean the air filter. p.97 <p>If it is not cracked: Re-fit the Lamp and turn on the power.</p> <p>If the error continues: Replace the Lamp with a new lamp and turn on the power.</p> <p>If the error continues: Stop using the projector, disconnect the power cable from the electrical outlet, and contact your local dealer or the nearest address provided in the Support and Service Guide. Epson Projector Contact List</p> <p>If it is cracked: Replace it with a new lamp, or contact your local dealer for further advice. If replacing the lamp yourself, be careful to avoid pieces of broken glass (you cannot continue projecting until the lamp is replaced). Epson Projector Contact List</p>

Status	Cause	Remedy or Status
		When using at an altitude of 1500 m or more, set High Altitude Mode to On.  p.58
	Auto Iris Error Power Err. (Ballast)	Stop using the projector, disconnect the power cable from the electrical outlet, and contact your local dealer or the nearest address provided in the Support and Service Guide.  Epson Projector Contact List

Indicator is lit or flashing orange

 : Lit  : Flashing  : Off  : Varies according to the projector status

Status	Cause	Remedy or Status
	High Temp Warning	(This is not an abnormality. However, if the temperature rises too high again, projection stops automatically.) <ul style="list-style-type: none"> • Check that the air filter and Air exhaust vent are clear, and that the projector is not positioned against a wall. • If the air filter is clogged, clean or replace it.  p.97, p.102
	Replace Lamp	Replace it with a new Lamp.  p.99 If you continue to use the Lamp after the replacement period has passed, the possibility that the lamp may explode increases. Replace it with a new Lamp as soon as possible.



- If the projector is not operating properly, even though the indicators are all showing normal, refer to "When the Indicators Provide No Help" [p.86](#).
- If the error is not indicated in this table, stop using the projector, disconnect the power cable from the electrical outlet, and contact your local dealer or the nearest address provided in the Support and Service Guide.  [Epson Projector Contact List](#)

When the Indicators Provide No Help

If any of the following problems occur and the indicators do not offer a solution, refer to the pages given for each problem.

Problems relating to images

- "No images appear" 🖱️ p.87
Projection does not start, the projection area is completely black, the projection area is completely blue, and so on.
- "Moving images are not displayed (only the moving image portion turns black)" 🖱️ p.87
Moving images being projected from a computer appear black and nothing is projected.
- "Projection stops automatically" 🖱️ p.87
- "The message "Not Supported." is displayed." 🖱️ p.88
- ""No Signal" is displayed." 🖱️ p.88
- "Images are fuzzy, out of focus, or distorted" 🖱️ p.88
- "Interference or distortion appear in images" 🖱️ p.89
Problems such as interference, distortion, or black & white checked patterns appear.
- "The image is truncated (large) or small, or the aspect is not suitable" 🖱️ p.89
Only part of the image is displayed, or the height and width ratios of the image are not correct, and so on.
- "Image colors are not right" 🖱️ p.90
The whole image appears purplish or greenish, images are black & white, colors appear dull, and so on... (Computer monitors and LCD screens have different color reproduction performance, so that the colors projected by the projector and colors appearing on the monitor may not necessarily match, but this is not a sign of a problem.)
- "Images appear dark" 🖱️ p.90
- "Nothing appears on the external monitor (EB-1925W/1920W/1915/1910/1830 only)" 🖱️ p.91

Problems when projection starts





- "The projector does not turn on" 🖱️ p.91

Other problems

- "No sound can be heard or the sound is faint" 🖱️ p.92
- "The Remote Control does not work" 🖱️ p.92
- "I want to change the language for messages and menus" 🖱️ p.92
- "Mail is not received even if a problem occurs in the projector (EB-1925W/1920W/1915/1910/1830)" 🖱️ p.93

Problems relating to images

No images appear

Check	Remedy
Did you press the [⏻] button?	Press the [⏻] button to turn the power on.
Are the indicators switched off?	The power cable is not connected correctly or power is not being supplied normally. Connect the projector's power cable correctly.  Quick Start Guide Check that your electrical outlet or power source is functioning correctly.
Is A/V Mute active?	Press the [A/V Mute] button on the Remote Control to cancel A/V Mute.  p.32
Is the A/V mute slide closed?	Open the A/V mute slide.  p.10
Are the Configuration Menu settings correct?	Reset all of the settings.  Reset Menu - Reset All p.80
Is the projected image completely black? Only when projecting computer images	Some input images, such as screen savers, may be completely black.
Is the image signal format setting correct? Only when projecting images from a video source	Change the setting according to the signal for the connected equipment.  Signal Menu - Video Signal p.54

Moving images are not displayed (only the moving image portion turns black)

Check	Remedy
Is the computer's image signal being output to the LCD and the monitor? Only when projecting images from a laptop computer or a computer with a built-in LCD screen	Change the image signal from the computer to external output only.  Check your computer's documentation.

Projection stops automatically



Check	Remedy
Is Sleep Mode set to On ?	Press the [⏻] button to turn the power on. If you do not want to use Sleep Mode, change the setting to Off .  Extended Menu - Operation - Sleep Mode p.58

Discount-Merchant.com (800) 991-8860

THE TRUSTED SOURCE FOR PROJECTOR LAMP AND ACCESSORIES

The message "Not Supported." is displayed.



Check	Remedy
Is the image signal format setting correct? Only when projecting images from a video source	Change the setting according to the signal for the connected equipment. 🖱️ Signal Menu - Video Signal p.54
Do the image signal Resolution and the Refresh Rate correspond to the mode? Only when projecting computer images	Refer to the computer's documentation for how to change the image signal Resolution and the Refresh Rate output from the computer. 🖱️ "Supported Monitor Displays" p.126

"No Signal" is displayed.





Check	Remedy
Are the cables connected correctly?	Check that all the cables required for projection are securely connected. 🖱️ Quick Start Guide
Is the correct input port selected?	Change the image by pressing the [Source Search] button on the Remote Control or the Control panel. 🖱️ p.29
Is the power for the computer or video source turned on?	Turn the power on for the equipment.
Are the image signals being output to the projector? Only when projecting images from a laptop computer or a computer with a built-in LCD screen	If the image signals are only being output to the computer's LCD monitor or to the accessory monitor, you need to change the output to an external destination as well as the computer's own monitor. For some computer models, when the image signals are output externally, they no longer appear on the LCD monitor or accessory monitor. 🖱️ Computer's documentation, under a title such as "External output" or "Connecting an external monitor". If the connection is made while the power of the projector or computer is already turned on, the function [Fn] key that changes the computer's image signal to external output may not work. Turn the power for the computer and the projector off and then back on again.

Images are fuzzy, out of focus, or distorted

Check	Remedy
Is the distance between the projector and screen over 3.5 m? (EB-1925W/1915)	In order for the projected image to be automatically adjusted by Auto H/V-Keystone or Screen Fit, the projector cannot be more than approximately 1.0 to 3.5 m away from the screen. If the projector must be placed further away than this, manually adjust the projected image.
In Settings menu - Keystone of the Configuration menu, is Auto H/V-Keystone set to Off ? (EB-1925W/1915 only)	Setting it to On enables Auto H/V-Keystone. 🖱️ p.56 If you are using the projector with this setting off, manually adjust the projected image. 🖱️ Quick Start Guide
Is the focus adjusted correctly?	Adjust the focus using the [Focus buttons] (EB-1925W/1915 only) or Focus ring (EB-1920W/1910/1900/1830 only). 🖱️ Quick Start Guide

Check	Remedy
Is the projector at the correct distance?	Is it projecting outside of the recommended projection distance range? Setup within the recommended range.  p.111
Is the Keystone adjustment value too large?	Lower the projection angle to reduce the amount of keystone correction.  Quick Start Guide
Has condensation formed on the lens?	If the projector is suddenly taken from a cold environment to a warm environment, or if sudden ambient temperature changes occur, condensation may form on the surface of the lens, and this may cause the images to appear fuzzy. Set the projector up in the room about one hour before it is used. If condensation forms on the lens, turn the projector off and wait for the condensation to disappear.

Interference or distortion appear in images

Check	Remedy
Is the image signal format setting correct? Only when projecting images from a video source	Change the setting according to the signal for the connected equipment.  Signal Menu - Video Signal p.54
Are the cables connected correctly?	Check that all the cables required for projection are securely connected.  Quick Start Guide
Is an extension cable being used?	If an extension cable is used, electrical interference may affect the signals. Use the cables supplied with the projector to check if the cables you are using may be causing the problem.
Is the correct resolution selected? Only when projecting computer images	Set the computer so that the signals being output are compatible with the projector.  "Supported Monitor Displays" p.126  Computer documentation
Are the "Sync.▶" and "Tracking▶" settings adjusted correctly? Only when projecting computer images	Press the [Auto] button on the Remote Control or the [Enter] button on the Control panel to perform automatic adjustment. If the images are not adjusted correctly after using automatic adjustment, you can make the adjustments using Sync. and Tracking from the Configuration Menu.  Signal Menu - Tracking, Sync. p.54

The image is truncated (large) or small, or the aspect is not suitable

Check	Remedy
Is a wide panel computer image being projected? Only when projecting computer images	Change the setting according to the signal for the connected equipment.  Signal Menu - Resolution p.54
Is the image still being enlarged by E-Zoom?	Press the [Esc] button on the Remote Control to cancel E-Zoom.  p.39

















Check	Remedy
Is Position adjusted correctly?	Press the [Auto] button on the Remote Control or the [Enter] button on the Control panel to perform automatic adjustment of the computer image being projected. If the images are not adjusted correctly after using automatic adjustment, you can make the adjustments using Position from the Configuration Menu. Apart from computer image signals, you can adjust other signals while projecting by adjusting Position from the Configuration Menu.  Signal Menu - Position p.54
Is the computer set for dual display? Only when projecting computer images	If dual display is activated in the "Display Properties" of the computer's Control panel, only about half of the image on the computer screen is projected. To display the entire image on the computer screen, turn off the dual display setting.  Computer video driver documentation
Is the correct resolution selected? Only when projecting computer images	Set the computer so that the signals being output are compatible with the projector.  "Supported Monitor Displays" p.126  Computer documentation

Image colors are not right

Check	Remedy
Do the input signal settings match the signals from the connected device?	Change the following settings according to the signal for the connected equipment. When image is from a device connected to the Computer1/2 or Computer input port  Signal menu - Input Signal p.54 When image is from a device connected to the Video or S-Video input port  Signal menu - Video Signal p.54
Is the image Brightness adjusted correctly?	Adjust the Brightness setting from the Configuration Menu.  Image menu - Brightness p.53
Are the cables connected correctly?	Check that all the cables required for projection are securely connected.  <i>Quick Start Guide</i>
Is Contrast  adjusted correctly?	Adjust the Contrast setting from the Configuration Menu.  Image Menu - Contrast p.53
Is the Color Adjustment correctly?	Adjust the Color Adjustment setting from the Configuration Menu.  Image Menu - Color Adjustment p.53
Are the Color Saturation and Tint adjusted correctly? Only when projecting images from a video source	Adjust the Color Saturation and Tint settings from the Configuration Menu.  Image Menu - Color Saturation, Tint p.53

Images appear dark

Check	Remedy
Is the image Brightness set correctly?	Adjust the Brightness and Power Consumption settings from the Configuration Menu.  Image Menu - Brightness p.53  Settings Menu - Power Consumption p.56

Check	Remedy
Is Contrast adjusted correctly?	Adjust the Contrast setting from the Configuration Menu. ☛ Image Menu - Contrast p.53
Is it time to replace the Lamp?	When the Lamp is nearly ready for replacement, the images become darker and the color quality becomes poorer. When this happens, replace the Lamp with a new lamp.☛ p.99

Nothing appears on the external monitor (EB-1925W/1920W/1915/1910/1830 only)

Check	Remedy
Are images input from a port other than the Computer1 input port?	The only images that can be displayed on an external monitor are computer images from the Computer1 input port.



Problems when projection starts

The projector does not turn on







Check	Remedy
Did you press the [⏻] button?	Press the [⏻] button to turn the power on.
Are the indicators switched off?	The power cable is not connected correctly or power is not being supplied normally. Disconnect and then reconnect the power cable.☛ Quick Start Guide Check that your electrical outlet or power source is functioning correctly.
Do the indicators turn on and off when the power cable is touched?	There is probably a poor contact in the power cable, or the power cable may be defective. Reinsert the power cable. If this does not solve the problem, stop using the projector, disconnect the power cable from the electrical outlet, and contact your local dealer or the nearest address provided in the Support and Service Guide.☛ Epson Projector Contact List
Is the Control Panel Lock set to Full Lock ?	Press the [⏻] button on the Remote Control. If you do not want to use Control Panel Lock , change the setting to Off .☛ Settings Menu - Control Panel Lock p.56
Is the correct setting for the remote receiver selected?	Check the Remote Receiver from the Configuration Menu.☛ Settings Menu - Remote Receiver p.56

Other problems

No sound can be heard or the sound is faint

Check	Remedy
Is the audio source connected correctly?	Disconnect the cable from the Audio port, and then reconnect the cable.
Is the volume adjusted to the minimum setting?	Adjust the volume so that sound can be heard.  p.56, Quick Start Guide
Is A/V Mute active?	Press the [A/V Mute] button on the Remote Control to cancel A/V Mute.  p.32
Is the audio cable's specification "No resistance"?	When using a commercially available audio cable, make sure it is labeled "No resistance".
Is it connected with an HDMI cable? (EB-1925W/1915 only)	If no audio is output when connecting via an HDMI cable, set the connected equipment to PCM output.

The Remote Control does not work





Check	Remedy
Is the Remote Control light-emitting area pointing towards the Remote receiver on the projector when it is operated?	Point the remote control towards the Remote Receiver. Operating range  Quick Start Guide
Is the remote control too far from the projector?	The operating range for the remote control is about 8 m.  Quick Start Guide
Is direct sunlight or strong light from fluorescent lamps shining onto the Remote Receiver?	Set the projector up in a location where strong light does not shine onto the Remote Receiver. Or set the remote receiver to Off from Remote Receiver in the configuration menu.  Settings Menu - Remote Receiver p.56
Is the correct setting for the Remote Receiver selected?	Check the Remote Receiver from the Configuration Menu.  Settings Menu - Remote Receiver p.56
Are the batteries dead or have the batteries been inserted correctly?	Make sure the batteries are inserted correctly or replace the batteries with new ones if necessary.  p.98
Are the remote control ID and the projector ID matched?	Make sure the ID for the projector you want to operate and the ID for the remote control match. To operate all projectors by remote control regardless of the ID setting, set the remote control ID to "0".  p.42

I want to change the language for messages and menus

Check	Remedy
Change the Language setting.	Adjust the Language setting from the configuration menu.  Extended Menu - Language p.58



Mail is not received even if a problem occurs in the projector (EB-1925W/1920W/1915/1910/1830)

Check	Remedy
Is Standby Mode set to Communication On ?	To use the Mail Notification function when the projector is in standby, set Communication On in Standby Mode from the Configuration Menu.  Extended Menu - Standby Mode p.58
Did a fatal abnormality occur and the projector come to a sudden stop?	When the projector comes to a sudden stop, e-mail cannot be sent. If the abnormal state continues, contact your local dealer or the nearest address provided in the Support and Service Guide.  <i>Quick Start Guide</i>
Is power being supplied to the projector?	Check that your electrical outlet or power source is functioning correctly.
Is Mail Notification function set correctly in the Configuration Menu?	Mail notification of problems is sent according to the Mail settings in the Configuration Menu. Check if it is set correctly. If using EB-1925W/1915  p.69 If using EB-1920W/1910/1830  p.76



Discount-Merchant.com (800) 281-8860
THE TRUSTED SOURCE FOR PROJECTOR LAMPS AND ACCESSORIES



Appendix

This chapter provides information on maintenance procedures to ensure the best level of performance from the projector for a long time to come.



Discount-Merchant.com (800) 281-8860
THE TRUSTED SOURCE FOR PROJECTOR LAMPS AND ACCESSORIES

The projector supports the following four different projection methods. Install according to the conditions of the installation location.

Warning

- A special method of installation is required when suspending the projector from a ceiling (ceiling mount). If it is not installed correctly, it could fall causing an accident and injury.
- If you use adhesives on the Ceiling mount fixing points to prevent the screws from loosening, or if you use things such as lubricants or oils on the projector, the projector case may crack causing it to fall from its ceiling mount. This could cause serious injury to anyone under the ceiling mount and could damage the projector.
When installing or adjusting the Ceiling mount, do not use adhesives to prevent the screws from loosening and do not use oils or lubricants and so on.

Attention

Do not use the projector on its side. This may cause malfunctions to occur.

- Project images from in front of a screen (Front projection)

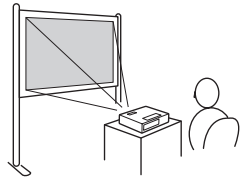

- Project images from behind a translucent screen. (Rear projection)

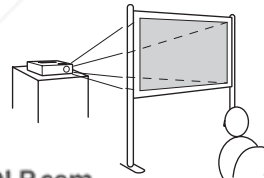

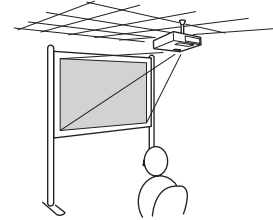

- Suspend the projector from the ceiling and project images from in front of a screen (Front/Ceiling projection)

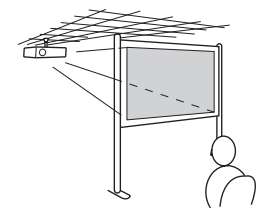

- Suspend the projector from the ceiling and project images from behind a translucent screen. (Rear/Ceiling projection)



- An optional Ceiling mount is required when suspending the projector from a ceiling.  p.104
- You can change the setting as follows by pressing down the [A/V Mute] button on the Remote Control for about five seconds.
Front ↔ Front/Ceiling
Set **Rear** or **Rear/Ceiling** from the Configuration Menu.  p.58

You should clean the projector if it becomes dirty or if the quality of projected images starts to deteriorate.

Attention

Turn off the projector's power before cleaning.

Cleaning the Projector's Surface

Clean the projector's surface by wiping it gently with a soft cloth.

If the projector is particularly dirty, moisten the cloth with water containing a small amount of neutral detergent, and then firmly wring the cloth dry before using it to wipe the projector's surface.

Attention

Do not use volatile substances such as wax, alcohol, or thinner to clean the projector's surface. The quality of the case may change or become discolored.

Cleaning the Lens

Use a commercially available cloth for cleaning glasses to gently wipe the lens.

**Warning**

Do not use sprays that contain flammable gas to remove dust and lint from the lens. The projector may catch fire due to the high internal temperature of the lamp.

Attention

Do not rub the lens with harsh materials or subject the lens to shocks, as it can easily become damaged.

Cleaning the Air filter

Clean the air filter and the Air intake vent when the following message is displayed.

"The projector is overheating. Make sure nothing is blocking the air vent, and clean or replace the air filter."

Attention

- *If dust collects on the air filter it can cause the internal temperature of the projector to rise, and this can lead to problems with operation and shorten the optical engine's service life. Clean the air filter immediately when the message is displayed.*
- *Do not rinse the air filter in water. Do not use detergents or solvents.*

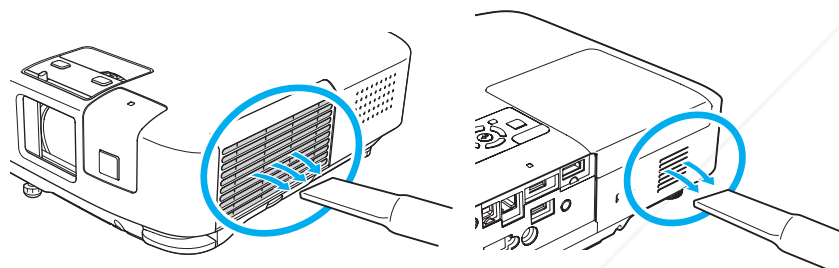

- If a message is frequently displayed, even after cleaning, it is time to replace the air filter. Replace it with a new air filter.
👉 p.102
- It is recommended that you clean these parts at least once every three months. Clean them more often than this if using the projector in a particularly dusty environment.

This section explains how to replace the Remote Control batteries, the Lamp, and the air filter.

Replacing the Remote Control Batteries

If delays in the responsiveness of the Remote Control occur or if it does not operate after it has been used for some time, it probably means that the batteries are becoming flat. When this happens, replace them with new batteries. Have two AA size manganese or alkaline batteries ready. You cannot use other batteries except for the AA size manganese or alkaline.

Attention

Make sure you read the Safety Instructions before handling the batteries.  Safety Instructions

Procedure

1 Remove the battery cover.

While pushing the battery compartment cover catch, lift the cover up.

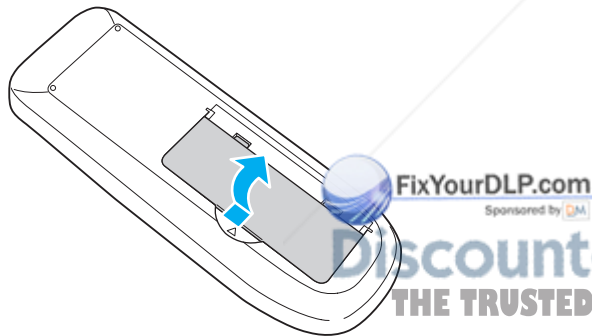

2 Replace the old batteries with new batteries.

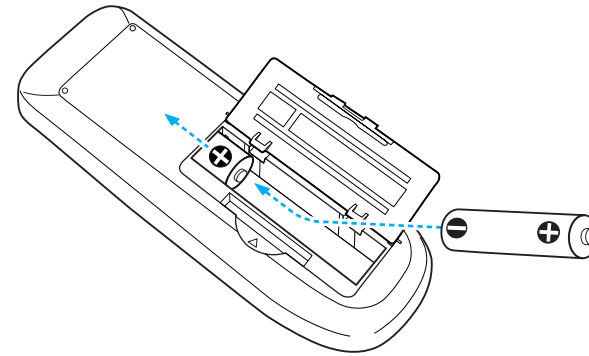

Caution

Check the positions of the (+) and (-) marks inside the battery holder to ensure the batteries are inserted the correct way.

3 Replace the battery cover.

Press the battery compartment cover until it clicks into place.

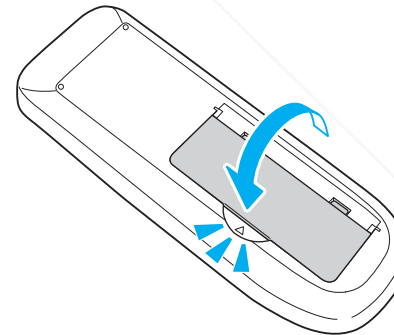

Replacing the Lamp

Lamp replacement period

It is time to replace the Lamp when:

- The message "**Replace the lamp.**" is displayed at the lower left of the projection screen when you start projecting.

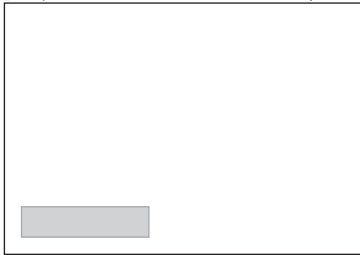

A message is displayed.

- The Lamp indicator flashes orange.

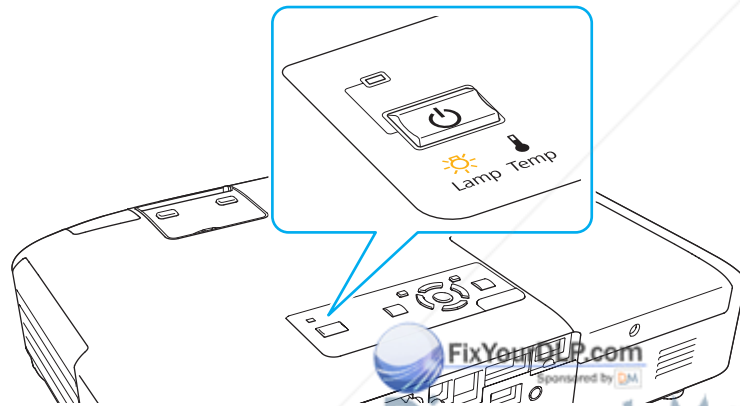

- The projected image gets darker or starts to deteriorate.

Attention

- The lamp replacement message is set to appear after the following time periods in order to maintain the initial brightness and quality of the projected images. [p.56](#)
 - When **Power Consumption** is set to **Normal**: About 2400 hours
 - When **Power Consumption** is set to **ECO**: About 3400 hours
- If you continue to use the Lamp after the replacement period has passed, the possibility that the lamp may explode increases. When the Lamp replacement message appears, replace the Lamp with a new one as soon as possible, even if it is still working.
- Do not repeatedly turn off the power and immediately back on. Turning the power on and off frequently may shorten the lamp's operating life.
- Depending on the characteristics of the Lamp and the way it has been used, the lamp may become darker or stop working before the lamp warning message appears. You should always have a spare lamp unit ready in case it is needed.

How to replace the Lamp

The Lamp can be replaced even when the projector is suspended from a ceiling.

Warning

- When replacing the Lamp because it has stopped illuminating, there is a possibility that the Lamp may be broken. If replacing the Lamp of a projector which has been installed on the ceiling, you should always assume that the Lamp is broken, and you should stand to the side of the Lamp cover, not underneath it. Remove the Lamp cover gently.
- Never disassemble or remodel the Lamp. If a remodeled or reassembled Lamp is installed into the projector and used, it could cause a fire, electric shock, or an accident.

Caution

Wait until the Lamp has cooled down sufficiently before removing the Lamp cover. If the lamp is still hot, burns or other injuries may result. It takes about one hour after the power has been turned off for the Lamp to be cool enough.

Procedure

1 After you turn off the projector's power and the confirmation buzzer beeps twice, disconnect the power cable.

2 Wait until the Lamp has cooled down, then remove the Lamp cover.

Loosen the Lamp cover fixing screw with the screwdriver supplied with the new lamp unit or a + head screwdriver. Then slide the Lamp cover straight forward and lift it to remove.

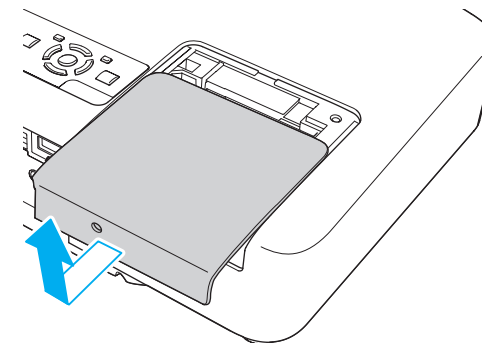
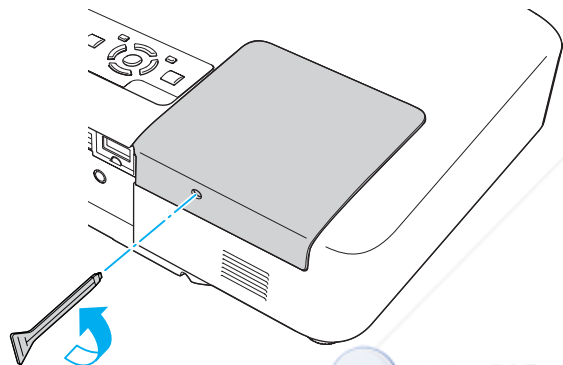

3 Loosen the two Lamp fixing screws.

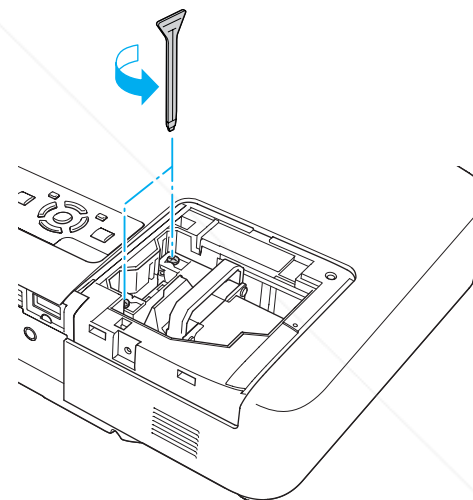

4 Take out the old Lamp by pulling the handle.

If the Lamp is cracked, replace it with a new lamp, or contact your local dealer for further advice. [Epson Projector Contact List](#)

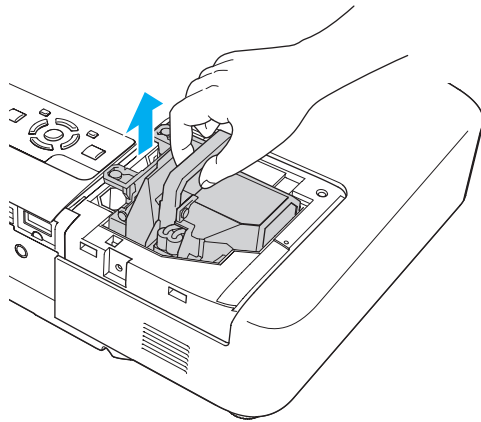

5 Install the new Lamp.

Insert the new Lamp along the guide rail in the correct direction so that it fits in place, push in firmly, and once it is fully inserted tighten the two screws.

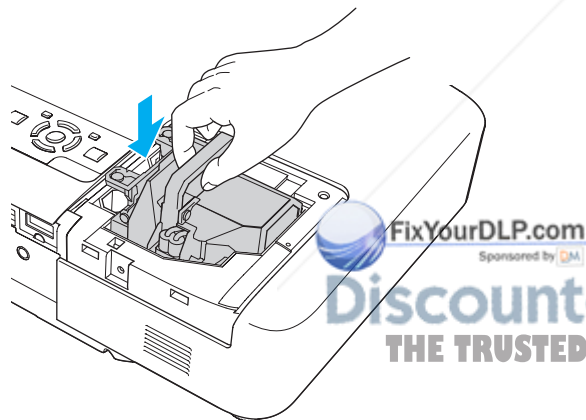

6 Replace the Lamp cover.

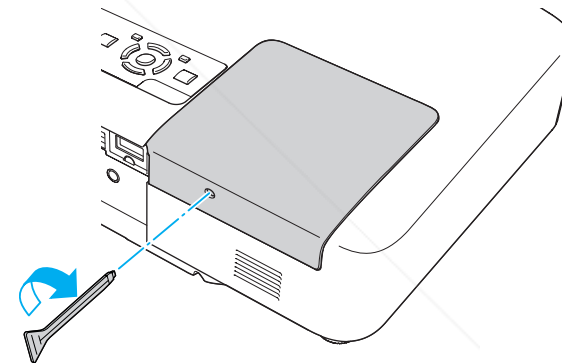
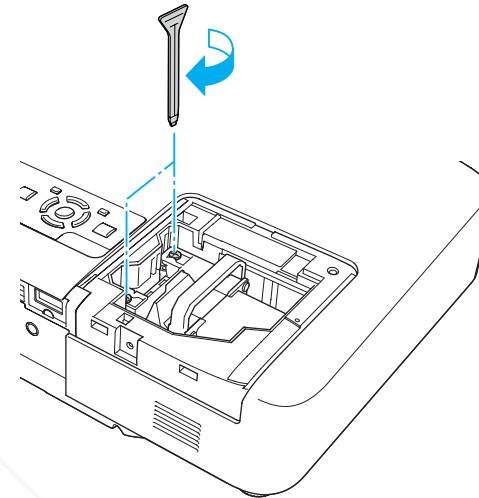

Attention

- Make sure you install the Lamp securely. If the Lamp cover is removed, the power turns off automatically as a safety precaution. If the Lamp or the Lamp cover is not installed correctly, the power does not turn on.
- This product includes a lamp component that contains mercury (Hg). Please consult your local regulations regarding disposal or recycling. Do not dispose of it with normal waste.

Resetting the lamp hours

The projector records how long the lamp is turned on and a message and indicator notify you when it is time to replace the lamp. After replacing the Lamp, make sure you reset the Lamp Hours from the Configuration Menu.  p.80



Only reset the Lamp Hours after the Lamp has been replaced. Otherwise the Lamp replacement period is not indicated correctly.

Replacing the Air Filter

Air filter replacement period

It is time to replace the air filter when:

- There is a tear in the air filter.
- The message is displayed even though the air filter has been cleaned.

How to replace the air filter

The air filter can be replaced even when the projector is suspended from a ceiling.

Procedure

1

After you turn off the projector's power and the confirmation buzzer beeps twice, disconnect the power cable.

2

Open the air filter cover.

Push the latch in the direction of the triangle to open the air filter cover. The air filter cover gets temporarily fixed in place at horizontal position.

When suspended from a ceiling

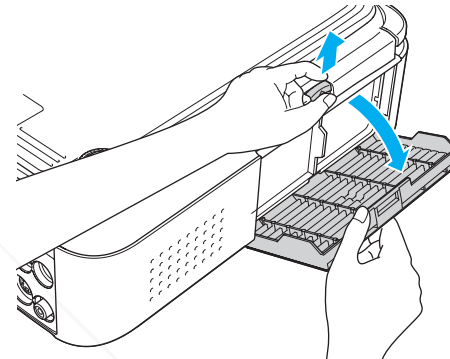

When placed on a table

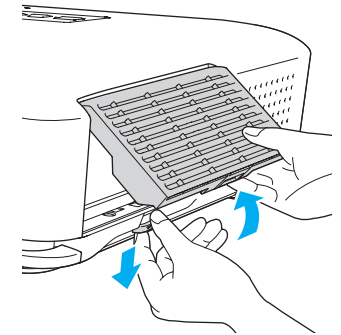

3

Remove the air filter.

Grip the tab in the center of the air filter, and pull it straight out.

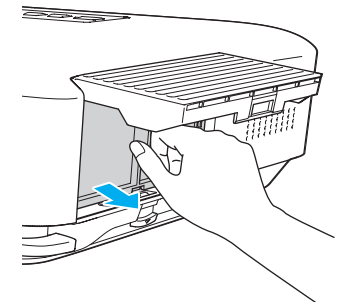
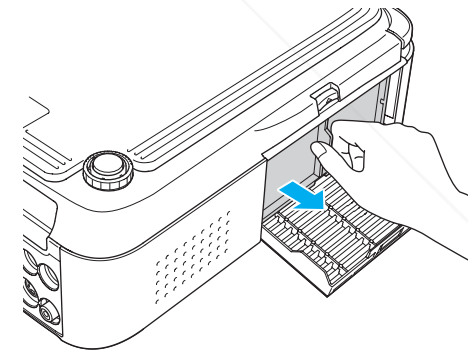

4 Install the new air filter.

Push in the air filter until it clicks into place.

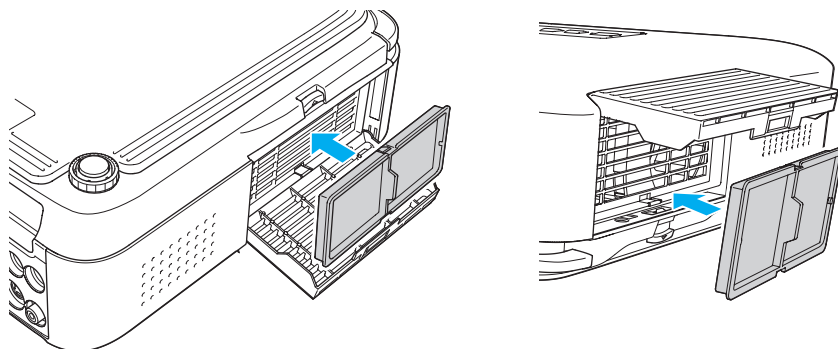

5 Close the air filter cover.

Push in the air filter cover until it clicks into place.



Dispose of used air filters properly in accordance with your local regulations.

Material of the frame part: Polypropylene

Material of the filter part: Polypropylene



Discount-Merchant.com (800) 281-8860

THE TRUSTED SOURCE FOR PROJECTOR LAMPS AND ACCESSORIES

The following optional accessories and consumables are available. Please purchase these products as and when needed. The following list of optional accessories and consumables is current as of: 2009.07. Details of accessories are subject to change without notice and availability may vary depending on the country of purchase.

Optional accessories

60" portable screen ELPSC07
80" portable screen ELPSC08
100" screen ELPSC10
 Portable roll-type screens ([Aspect Ratio](#)▶ 4:3)

For EB-1925W/1920W
70" portable screen ELPSC23
80" portable screen ELPSC24
90" portable screen ELPSC25
 Portable roll-type screens ([Aspect Ratio](#)▶ 16:10)

50" portable screen ELPSC06
 A compact screen that can be carried easily. (Aspect Ratio 4:3)

Computer cable ELPKC02
(1.8 m - for mini D-Sub15-pin/mini D-Sub 15pin)
 This is the same as the computer cable supplied with the projector.

Computer cable ELPKC09
(3 m - for mini D-Sub15-pin/mini D-Sub 15pin)
Computer cable ELPKC10
(20 m - for mini D-Sub15-pin/mini D-Sub 15pin)

Use one of these longer cables if the computer cable supplied with the projector is too short.

Component video cable ELPKC19
(3 m - for mini D-Sub 15-pin/RCA male×3)
 Use to connect a [component video](#)▶ source.

Document camera ELPDC06
 Use when projecting books, OHP documents, or slides.

Wireless LAN unit ELPAP03 (EB-1925W/1915 only)
 Use when connecting the projector to a computer wirelessly and projecting.

Quick Wireless Connection USB Key ELPAP06 (EB-1925W/1920W/1915/1910/1830only)
 Use when you want to quickly establish one-to-one connection between the projector and a computer with Windows installed and project images.

Ceiling pipe (450 mm)* ELPFP13
Ceiling pipe (700 mm)* ELPFP14
 Use when installing the projector on a high ceiling.

Ceiling mount* ELPMB23
 Use when installing the projector on a ceiling.

* A special method of installation is required to suspend the projector from a ceiling. Contact your dealer or the nearest address provided in the Support and Service Guide if you want to use this installation method.
 ▶ [Epson Projector Contact List](#)

Consumables

Lamp unit ELPLP53
 Use as a replacement for used Lamps.

Air filter ELPAF24
 Use as a replacement for used air filters.

You can save the image that is currently being projected as a User's Logo.



Once a User's Logo has been saved, the logo cannot be returned to the factory default.

Procedure

- 1 Project the image you want to use as the User's Logo, and then press the [Menu] button.

Using the Remote Control

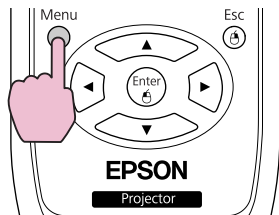

Using the Control panel

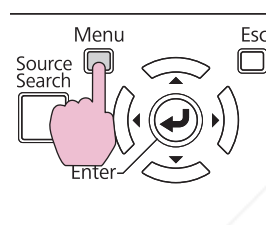

- 2 Select **Extended - User's Logo** from the Configuration Menu.
 ➔ "Using the Configuration Menu" [p.52](#)

Check the buttons you can use and the operations they perform in the guide under the menu.

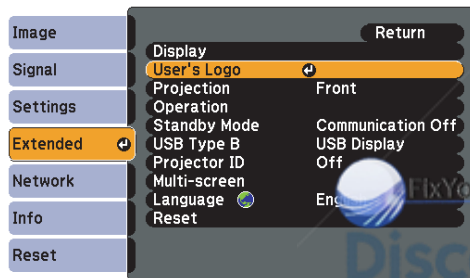

[Esc]:Return [↵]:Select [Enter]:Enter [Menu]:Exit



- If **User's Logo Protect** from **Password Protect** is set to **On**, a message is displayed and the user's logo cannot be changed. You can make changes after setting **User's Logo Protect** to **Off**.
 ➔ [p.47](#)
- If **User's Logo** is selected when **Keystone**, **E-Zoom**, **Aspect**, or **Progressive** are being performed, the function currently being performed is cancelled.

- 3 When "Choose this image as the User's Logo?" is displayed, select **Yes**.



When you press the [Enter] button on the Remote Control or the Control panel, the screen size may change according to the signal as it changes to the resolution of the image signal.

- 4 Move the box to select the part of the image to use as the User's Logo.



Using the Remote Control

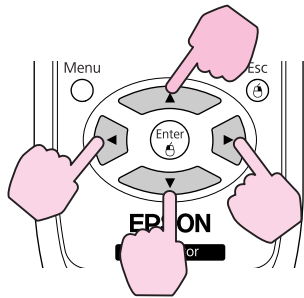

Using the Control panel

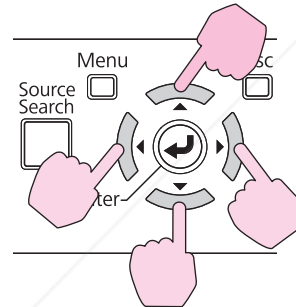

6

Select the zoom factor from the zoom setting screen.

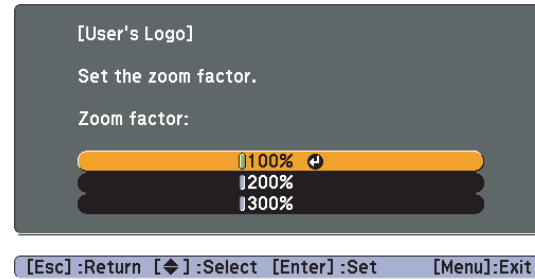

7

When the message "Save this image as the User's Logo?" is displayed, select Yes.

The image is saved. After the image has been saved, the message "Completed." is displayed.

- When a User's Logo is saved, the previous User's Logo is erased.
- Saving the user's logo may take approximately 15 seconds. Do not use the projector or any connected equipment while it is saving, otherwise malfunctions may occur.



You can save at 400 x 300 dots in size.

5

When "Select this image?" is displayed, select Yes.

There are two methods for setting Wi-Fi Protected Setup.

- Push Button Method

SSID and security are set automatically when the [Enter] button is pressed on the projector's control panel and the dedicated button on the access point equipment. This method is recommended when the projector and access point are close together.

- PIN Code Method

SSID and security are set automatically by inputting an 8-digit code that was assigned to the projector from the computer to the access point in advance. Make connection settings between the computer and the access point in advance. For details on how to make this connection, refer to the manual provided with the access point. This method is recommended when the projector is mounted on the ceiling.

Connection Setup Method

Procedure

- 1 Press the [Menu] button, and then from the Configuration menu select Network - Network Configuration.

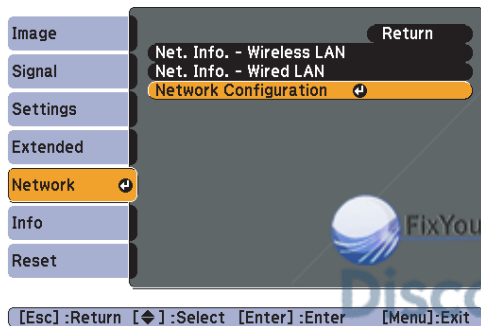

[Esc]:Return [Left]:Select [Enter]:Enter [Menu]:Exit

The configuration screen is displayed.

2

Select Wireless LAN - To Setup Wizard.



The following screen is displayed.

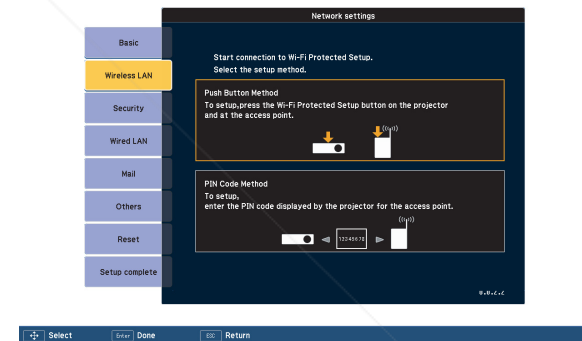

When connecting using the Push Button Method, follow the steps given below. To connect using the PIN Code Method see "Connecting Using the PIN Code Method" p.109

Connecting Using the Push Button Method

Procedure

1 Select Push Button Method.

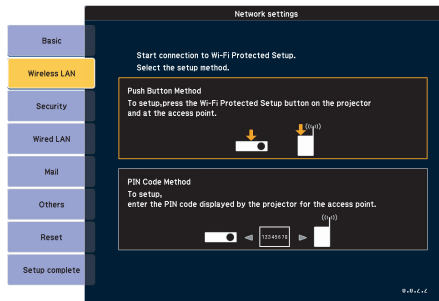

The Push Button Method screen is displayed.

2 Press the [Enter] button on the projector's control panel when prompted by the screen.

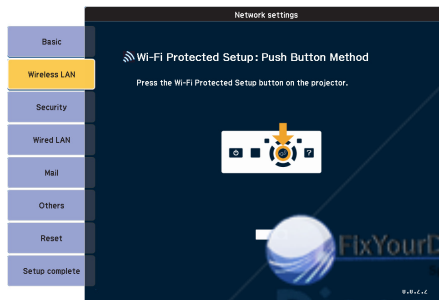

Then, the Push Button Method screen is displayed.

3 Press the button on the access point when prompted by the screen.

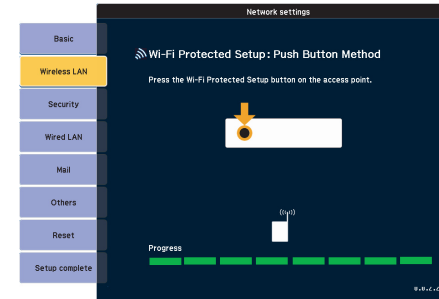

This completes the setup.

4 Press the [Enter] button or the [Esc] button.

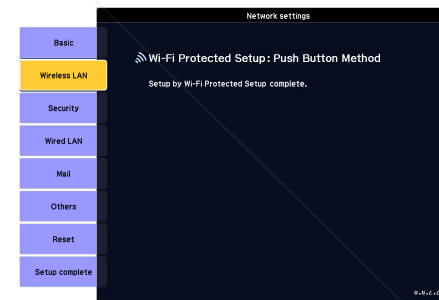

It returns to the Wireless LAN menu screen.

5 Select Setup complete - Yes.

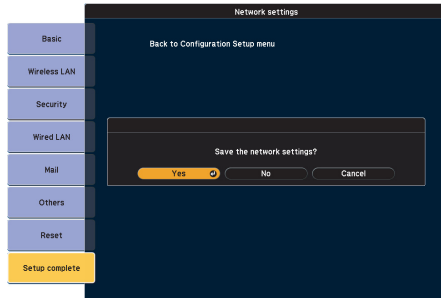

This completes the setup of the connection between the projector and the access point. Press the [Menu] button to close the Configuration Menu.

Connecting Using the PIN Code Method



Before you can make a connection using the PIN Code Method, a connection must have already been setup between the computer and the access point.

Procedure

1 Select PIN Code Method.

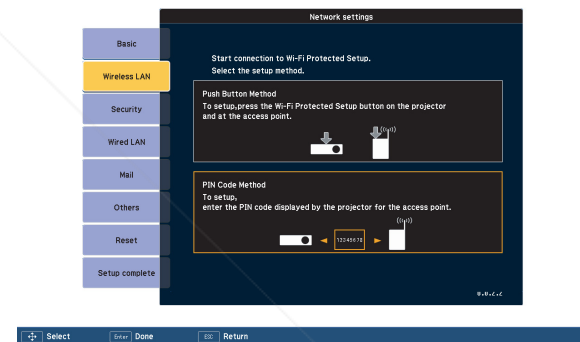

The PIN Code Method screen is displayed.

2 Enter the PIN code displayed on the PIN Code Method screen from the computer to the access point, and then select Start Setup.



The progress is displayed.

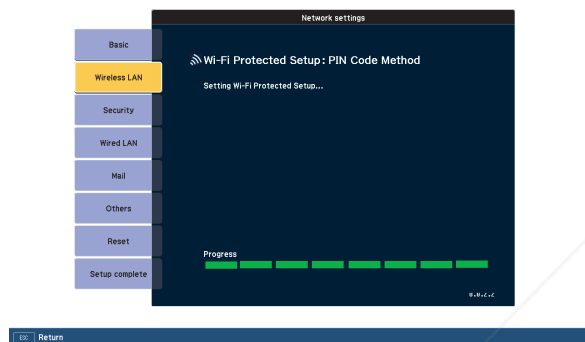

3 When the message "Setup by Wi-Fi Protected Setup complete." appears, press the [Enter] button or the [Esc] button.

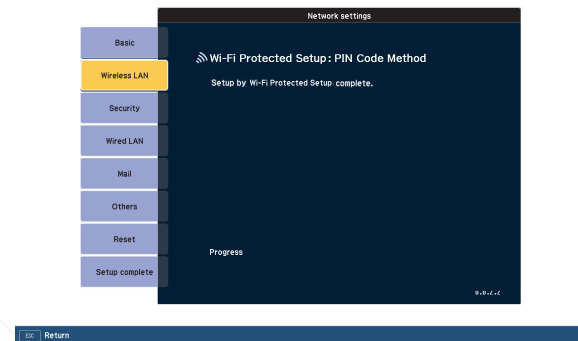

It returns to the Wireless LAN menu screen.

4 Select Setup complete - Yes.

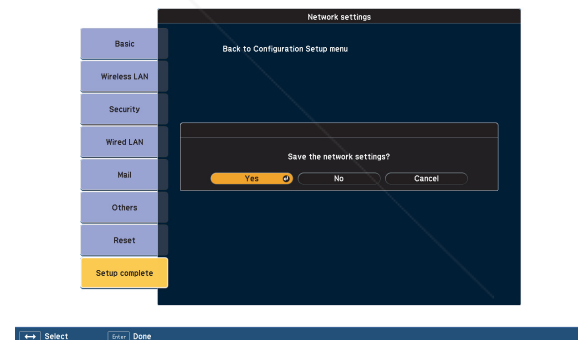

This completes the setup of the connection between the projector and the access point. Press the [Menu] button to close the Configuration Menu.

Projection Distance (EB-1925W/1920W)

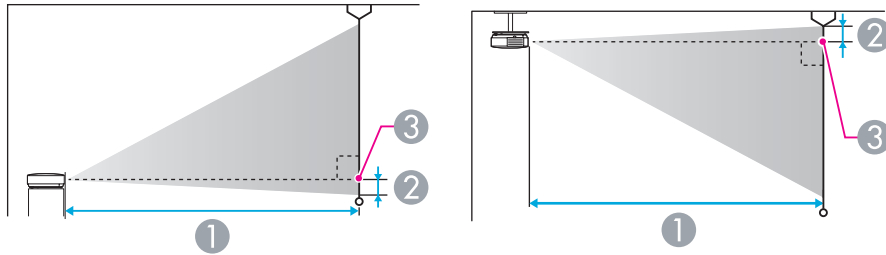

- ① Projection distance
- ② Distance from the center of the lens to the base of the screen (or to the top of the screen, if suspended from a ceiling)
- ③ Center of lens

4:3 Screen Size		① Minimum (Wide) to Maximum (Tele)	②
30"	61x46	104 - 170	3
40"	81x61	140 - 229	4
50"	100x76	176 - 287	5
60"	120x91	213 - 345	5
80"	160x120	285 - 462	7
100"	200x150	358 - 579	9
120"	240x180	430 - 696	10
150"	300x230	539 - 871	14
200"	410x300	720 - 1163	18
250"	500x380	902 - 1455	23
260"	520x400	938 - 1513	24

16:9 Screen size		① Minimum (Wide) to Maximum (Tele)	②
30"	66x37	94 - 154	0
40"	89x50	127 - 207	1
50"	110x62	160 - 260	1
60"	130x75	193 - 313	1
80"	180x100	258 - 419	1
100"	220x120	324 - 525	1
120"	270x150	390 - 631	2
150"	330x190	489 - 790	2
200"	440x250	654 - 1055	3
250"	550x310	818 - 1320	3
280"	620x350	917 - 1479	4

16:10 Screen size		① Minimum (Wide) to Maximum (Tele)	②
30"	64x40	91 - 150	2
40"	86x54	123 - 201	3
50"	110x67	155 - 253	4
60"	130x81	187 - 305	5
80"	170x110	251 - 408	6
100"	220x130	315 - 511	8
120"	260x160	379 - 614	10
150"	320x200	476 - 769	12
200"	430x270	636 - 1027	16
250"	540x340	796 - 1285	20

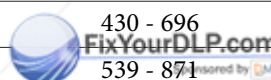
Discount-Merchant.com (800) 281-8860
 THE TRUSTED SOURCE FOR PROJECTOR LAMPS AND ACCESSORIES

16:10 Screen size		①	②
		Minimum (Wide) to Maximum (Tele)	
300"	640x400	956 - 1542	24

4:3 Screen size		①	②
		Minimum (Wide) to Maximum (Tele)	
150"	300x230	501 - 810	-21
200"	410x300	670 - 1081	-28
250"	510x380	839 - 1353	-35
300"	610x460	1007 - 1624	-42

Projection Distance (EB-1915/1910/1900/1830)

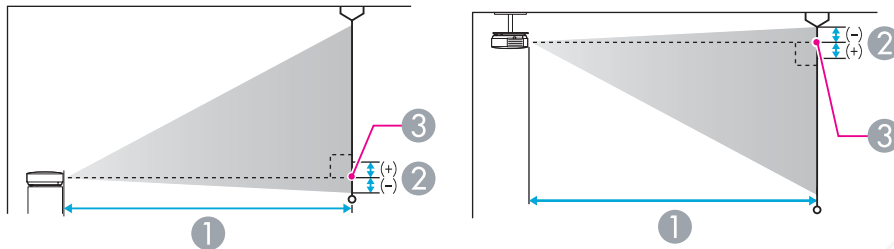

- ① Projection distance
- ② Distance from the center of the lens to the base of the screen (or to the top of the screen, if suspended from a ceiling)
- ③ Center of lens

4:3 Screen size		①	②
		Minimum (Wide) to Maximum (Tele)	
30"	61x46	96 - 158	-4
40"	81x61	130 - 212	-6
50"	100x76	164 - 267	-7
60"	120x91	197 - 321	-8
80"	160x120	265 - 430	-11
100"	200x150	332 - 538	-14
120"	240x180	400 - 647	-17

16:9 Screen size		①	②
		Minimum (Wide) to Maximum (Tele)	
30"	66x37	102 - 167	+2
40"	89x50	142 - 232	+2
50"	110x62	179 - 291	+3
60"	130x75	216 - 350	+3
80"	180x100	289 - 468	+5
100"	220x120	363 - 578	+6
120"	270x150	436 - 705	+7
150"	330x190	546 - 883	+9
200"	440x250	730 - 1178	+11
250"	550x310	914 - 1474	+14
275"	610x340	1006 - 1622	+16

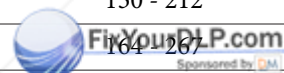

Discount-Merchant.com (800) 281-8860
 THE TRUSTED SOURCE FOR PROJECTOR LAMPS AND ACCESSORIES

USB memories and USB compatible digital cameras, hard disk drives, and the optional Document Camera can be connected to the projector.

On EB-1925W/1915, you can use PC Free to project scenarios, images and movie files on the connected USB storage device, and image files in your digital camera. [Projector Operation Guide "PC Free Basic Operations"](#)(EB-1925W/1915)

On EB-1920W/1910/1830, you can use Slideshow to project JPEG files on your USB storage device and image files on your digital camera. [Projector Operation Guide "Slideshow Basic Operations"](#)(EB-1920W/1910/1830)

Connecting USB Devices

The following procedure describes how to connect USB devices, using a digital camera as an example.

Procedure

Connect the USB cable that was supplied with or specified for your digital camera to the projector's USB1 port (EB-1925W/1915 only) or USB(TypeA) port (EB-1920W/1910/1830 only).

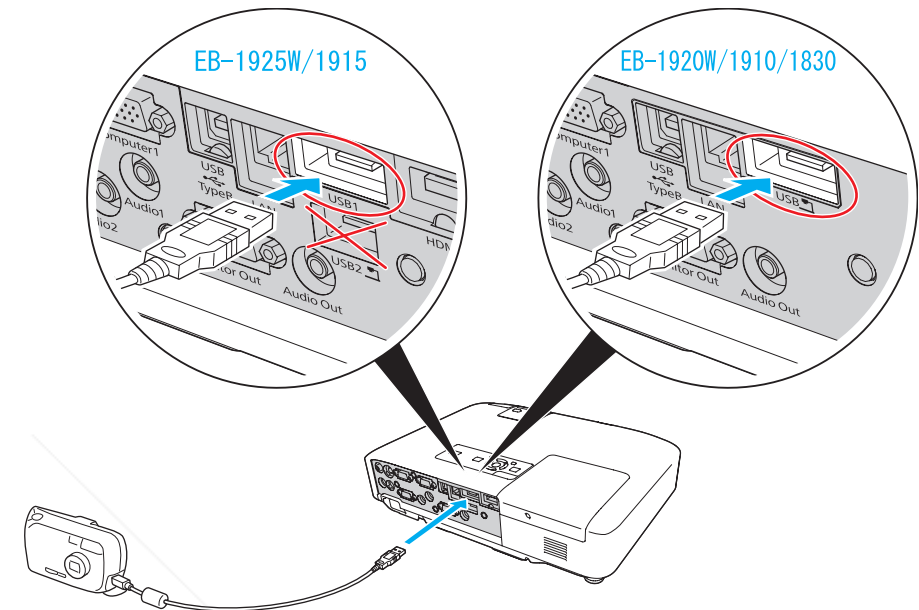

Attention

- If you use a USB hub, the connection may not operate correctly. Devices such as digital cameras and USB storage devices should be connected to the projector directly.
- When connecting and using a USB-compatible hard disk, make sure you connect the AC adaptor supplied with the hard disk.
- Connect a digital camera or hard disk to the projector using a USB cable provided with, or specified for use with the device.
- Use a USB cable less than 3 m in length. If the cable exceeds 3 m, PC Free (EB-1925W/1915 only) or Slideshow (EB-1920W/1910/1830 only) may not function correctly.

Removing USB Devices

Procedure

After finishing projecting, remove USB devices from the projector. For digital cameras, hard disks, and so on, turn off the power to the device and then remove.

Connecting the Document Camera (ELPDC06)

When the optional Document Camera (ELPDC06) is connected, images from the Document Camera will be projected. When the Document Camera is connected to the projector while projecting other images, press the [USB] button on the remote control or the [Source Search] button on the control panel to switch to images from the Document Camera.

Procedure

Connect the optional Document Camera (ELPDC06) to the USB2 port (EB-1925W/1915 only) or USB(TypeA) port (EB-1920W/1910/1830 only), using the USB cable that was supplied with the Document Camera.

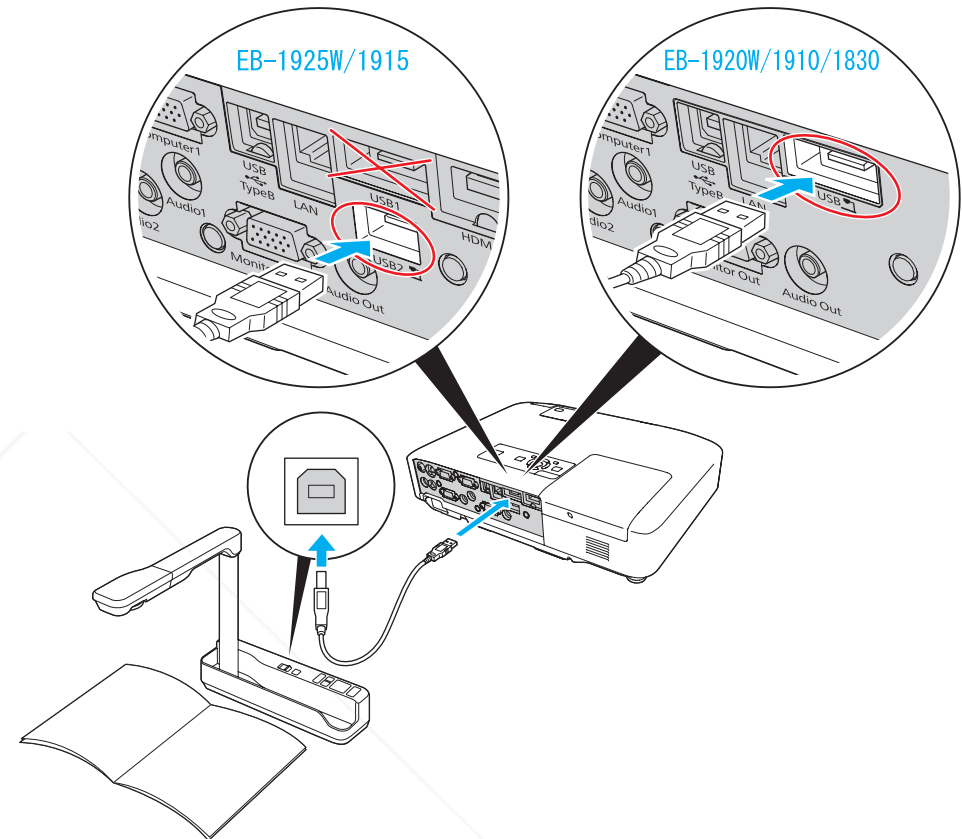

Removing the Document Camera (ELPDC06)

Procedure

After finishing projecting, remove from the projector the USB cable that is connected to the optional Document Camera (ELPDC06).

By using a USB cable to connect the projector to a Windows computer you can project images from the computer. This function is called USB Display. Simply by connecting via a USB cable, images from the computer can be displayed.

Attention
Connect the projector directly to the computer and not via a USB hub.

Operating Conditions for USB Display

USB Display operates on computers that meet the following requirements.

OS	Windows 2000 SP4/Windows XP/Windows XP SP1 and later/Windows Vista/Windows Vista SP1
CPU	Mobile Pentium III 1.2 GHz or faster Recommended: Pentium M 1.6 GHz or faster
Amount of Memory	256 MB or more Recommended: 512 MB or more
Free Space on Hard Disk	20 MB or more
Display	Resolution greater than XGA (1024x768) Display color in 16-bit color or greater About 32,000 display colors

Connecting

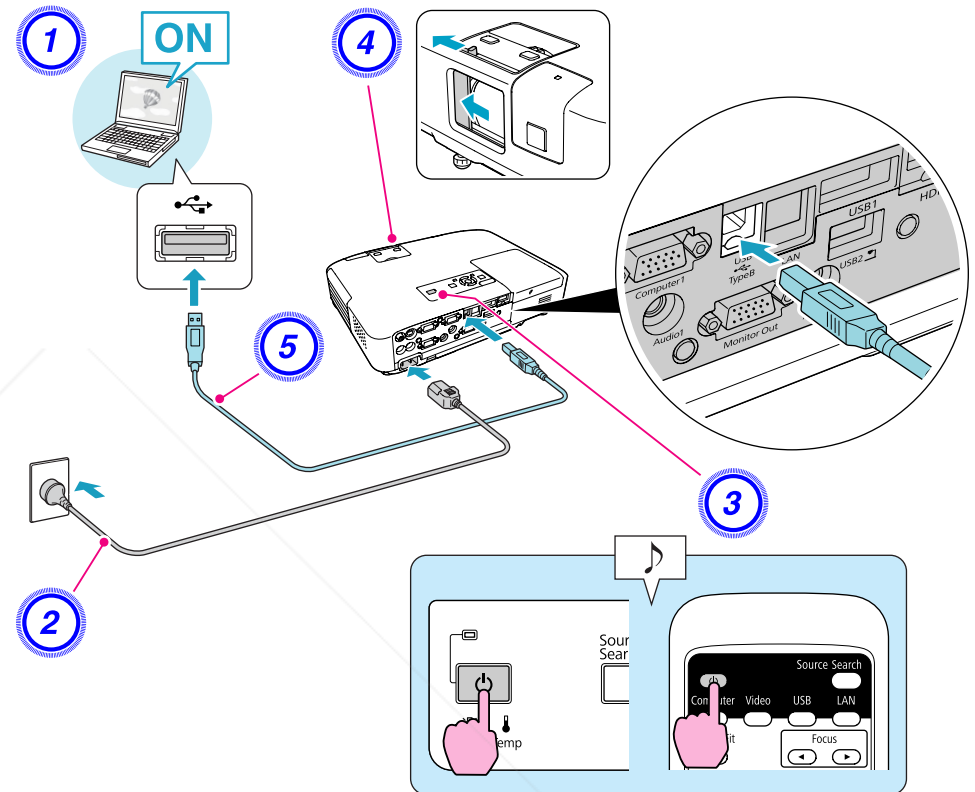

Procedure

- 1 Turn the computer on.
- 2 Connect to the power cable (supplied).
- 3 Turn the projector on.
- 4 Open the A/V mute slide.

5 Connect to the USB cable.

- ☛ "Connecting for the first time" p.116
- ☛ "From the second time" p.117



- On EB-1925W/1915, you can output the computer's audio to the projector's speaker by simply connecting the USB cable. If you do not want the audio be output from the projector, click Start - EPSON Projector - EPSON USB Display - EPSON USB Display Vx.xx on the computer, then uncheck **Output audio from the projector** on the configuration screen.
- On EB-1920W/1910/1830, you can output the computer's audio to the projector's speaker by connecting an audio cable (commercially available) to the projector's Audio2 port. ☛ *Quick Start Guide*

Connecting for the first time

Procedure

1 Driver installation starts automatically.

When you are using a Windows 2000 computer, click My Computer - EPSON_PJ_UD - EMP_UDSE.EXE, on your computer.

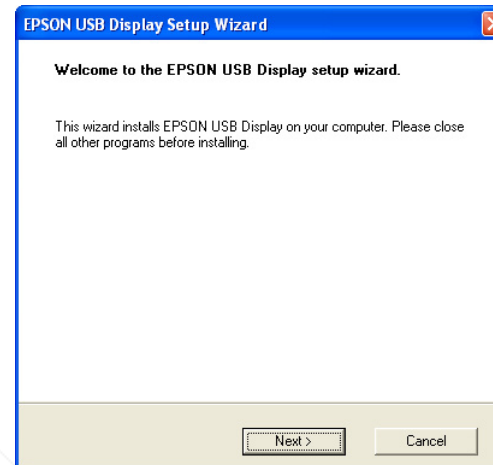

When using a computer running Windows 2000 under user authority, a Windows error message is displayed during installation and you may not be able to install the software. In this case, try updating Windows to the latest version, restart, and then try to connect again. For more details, contact the nearest address provided in the Support and Service Guide. ☛ [Epson Projector Contact List](#)

2 Click "Agree".

If the driver is not installed, you cannot start USB Display. Select Agree to install the driver. If you want to cancel installation, click Disagree.

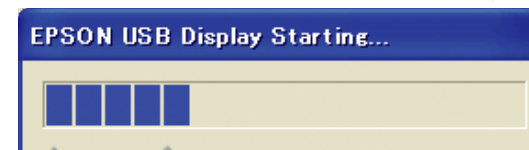

3

Computer images are projected.

It may take a while before computer images are projected. Until computer images are projected, leave the equipment as it is and do not disconnect the USB cable or turn off the power to the projector.

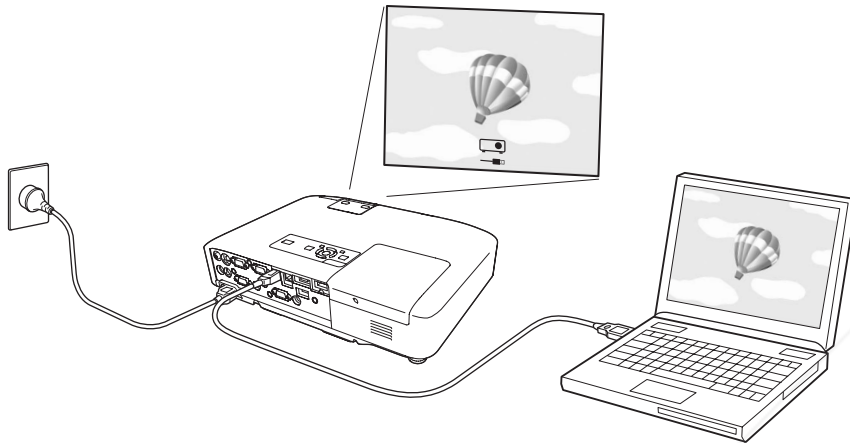

From the second time

Computer images are projected.

It may take a while before computer images are projected. Please wait.



Applications that use part of DirectX functions may not be displayed correctly. (Windows only)



- If nothing is projected for some reason, click **All Programs - EPSON Projector - EPSON USB Display - EPSON USB Display Vx.x**, on your computer.
- If it is not installed automatically, double-click **My Computer - EPSON_PJ_UD - EMP_UDSE.EXE**, on your computer.
- If the mouse pointer flickers on the computer screen, click **All Programs - EPSON Projector - EPSON USB Display - EPSON USB Display Vx.x**, and then clear the Transfer layered window checkbox.
- To uninstall the driver, open **Control Panel - Add/Remove Programs** - and uninst. **EPSON USB Display Vx.x**.
- Disconnecting
The projector can be disconnected simply by disconnecting the USB cable. There is no need to use the **Safely Remove Hardware** feature in Windows.

Connect with a commercially available 100BASE-TX or 10BASE-T LAN cable.

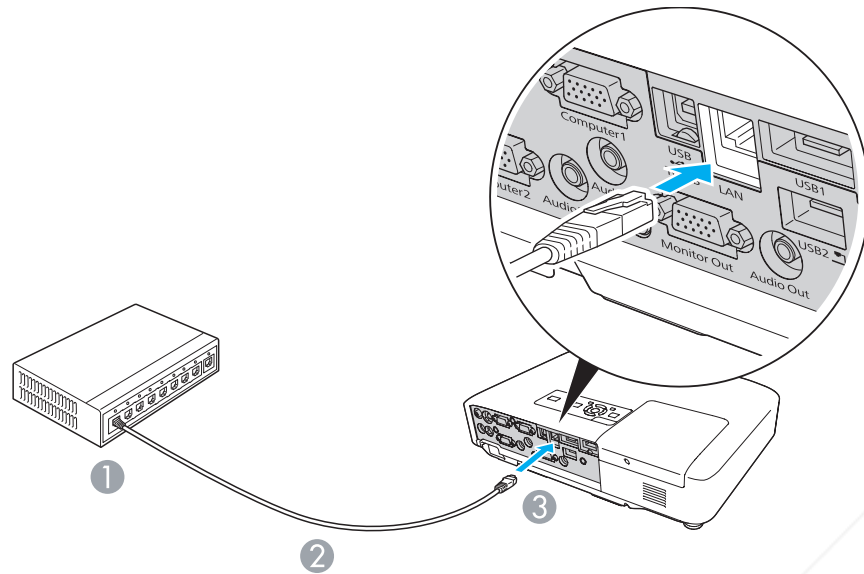

- ① To LAN port
- ② LAN cable (commercially available)
- ③ To LAN port

Attention

To prevent malfunctions, use a category 5 shielded LAN cable.

Connecting to an External Monitor (EB-1925W/1920W/1915/1910/1830 Only)

You can display computer images input from Computer1 Input Port on an external monitor and the screen connected to the projector at the same time. This means that you can check projected images on an external monitor when giving presentations even if you cannot see the screen. Connect using the cable supplied with the external monitor.

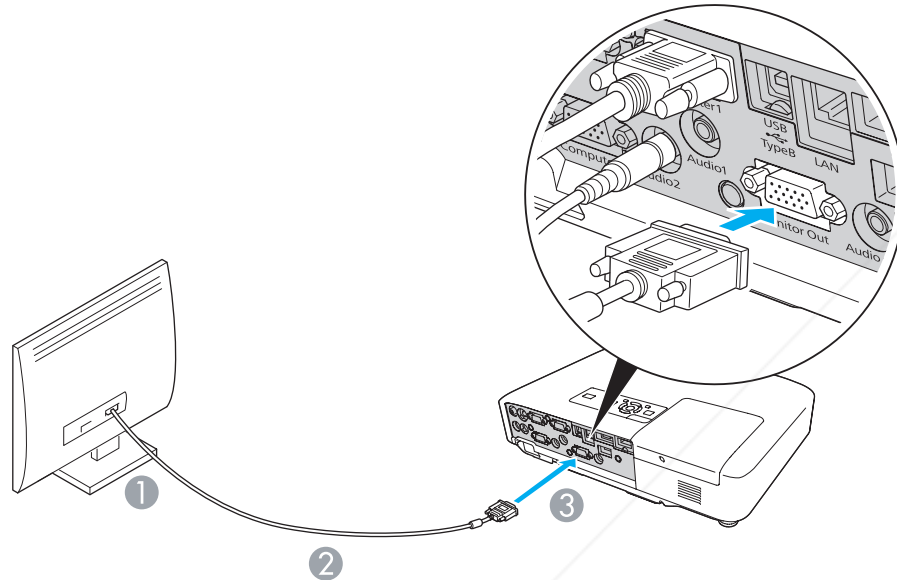

- ① To Monitor port
- ② Cable supplied with monitor
- ③ To Monitor Out Port



- Component video signals and signals from equipment connected to ports other than Computer1 input port cannot be output to an external monitor.
- If you want to display images on the external monitor while the projector is in standby mode, set **Extended - Standby Mode** to **Communication On** from the Configuration menu.
- Setting gauges, Configuration Menu, or Help screens for functions such as Keystone are not output to the external monitor.

Connecting to an External Speaker (EB-1925W/1920W/1915/1910/1830 Only)

You can connect speakers with built-in amplifiers to the projector's Audio Out port to enjoy a fuller quality of sound. Connect with a commercially available audio cable (such as pin plug ↔ 3.5 mm stereo mini plug). Use an audio cable compatible with the connector on the external speakers.



- When the audio cable jack is inserted into the Audio Out Port, audio stops being output from the projector's built-in speakers and switches to external output.
- When using a commercially available 2RCA(L/R)/stereo mini-pin audio cable, make sure it is labeled "No resistance".

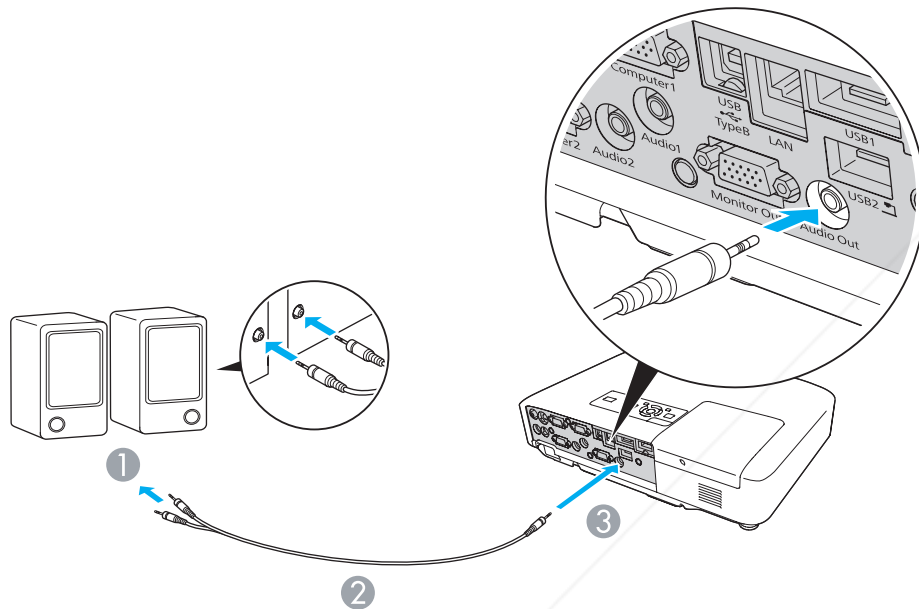

- 1 To external audio equipment
- 2 Audio cable (commercially available)
- 3 To Audio Out Port

 FixYourDLP.com
Sponsored by 

Discount-Merchant.com (800) 281-8860
THE TRUSTED SOURCE FOR PROJECTOR LAMPS AND ACCESSORIES

When the Mail Notification function is set to On and a problem/warning occurs in the projector, the following e-mail will be sent.

Subject: EPSON Projector

Line 1: The Projector Name where the problem has occurred

Line 2: The IP Address set for the projector where the problem has occurred.

Line 3 and on: Details of the problem

The details of the problem are listed line by line. The following table shows the details that are given in the message for each item. To deal with problems/warnings, see ["Reading the Indicators".](#) p.83

Message	Cause
Internal error	Internal Error
Fan related error	Fan Error
Sensor error	Sensor Error
Lamp timer failure	Lamp Failure
Lamp out	Lamp Error
Internal temperature error	High Temp Error (Overheating)
High-speed cooling in progress	High Temp Warning
Lamp replacement notification	Replace Lamp
No-signal	No Signal No Signal is input to the projector. Check the connection status or check that the power for the signal source is turned on.
Auto Iris Error	Auto Iris Error
Power Err. (Ballast)	Power Err. (Ballast)

A (+) or (-) appears at the start of the message.

(+): A projector problem has occurred

(-): A projector problem has been dealt with



Command List

When the power ON command is transmitted to the projector, the power turns on and it enters warm-up mode. When the projector's power has turned on, a colon ":" (3Ah) is returned.

When a command is input, the projector executes the command and returns a ":", and then accepts the next command.

If the command being processed terminates abnormally, an error message is output and a ":" is returned.

Item		Command	
Power ON/OFF	On	PWR ON	
	Off	PWR OFF	
Signal selection	Computer1 (EB-1925W/1920W/ 1915/1910/1830 only) Computer (EB-1900 only)	Auto	SOURCE 1F
		RGB	SOURCE 11
		Component	SOURCE 14
	Computer2 (EB-1925W/1920W/ 1915/1910/1830 only)	Auto	SOURCE 2F
		RGB	SOURCE 21
		Component	SOURCE 24
	HDMI (EB-1925W/1915only)		SOURCE 30
	Video		SOURCE 41
	S-Video		SOURCE 42
	USB Display		SOURCE 51
	USB1 (EB-1925W/1915 only) USB (EB-1920W/1910/1830 only)		SOURCE 52
LAN (EB-1925W/1920W/ 1915/1910/1830 only)		SOURCE 53	

Item		Command
	USB2 (EB-1925W/1915 only)	SOURCE 54
A/V Mute On/Off	On	MUTE ON
	Off	MUTE OFF
A/V Mute selection	Black	MSEL 00
	Blue	MSEL 01
	Logo	MSEL 02

Add a Carriage Return (CR) code (0Dh) to the end of each command and transmit.

Cable Layouts

Serial Connection

- Connector shape: D-Sub 9-pin (male)



Discount-Merchant.com (800) 281-8860
THE TRUSTED SOURCE FOR PROJECTOR LAMPS AND ACCESSORIES

- Projector input port name: RS-232C

<At the projector>

<At the computer>

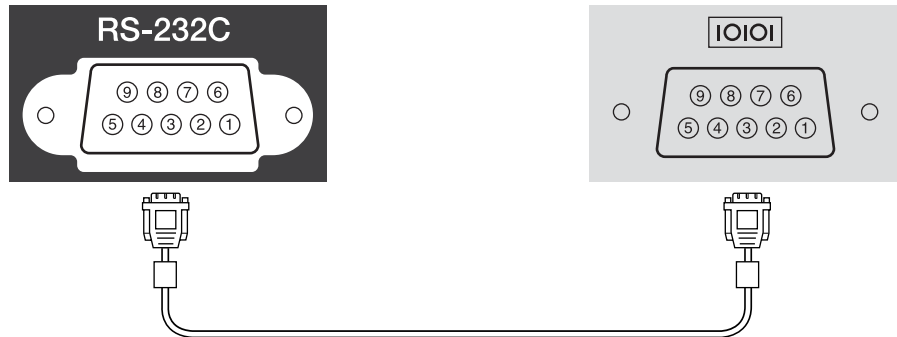

<At the projector>

(PC serial cable)

<At the computer>

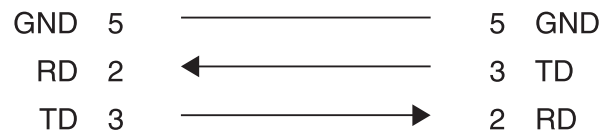

Signal Name	Function
GND	Signal wire ground
TD	Transmit data
RD	Receive data

Communications protocol

- Default baud rate setting: 9600
- Data length: 8 bit
- Parity: None
- Stop-bit: 1 bit
- Flow control: None



Discount-Merchant.com (800) 281-8860
 THE TRUSTED SOURCE FOR PROJECTOR LAMPS AND ACCESSORIES

There are two methods connecting the projector to a computer via a network and project images from the computer screen.

- Use EasyMP Network Projection

EasyMP Network Projection on the supplied "EPSON Projector Software for Meeting & Presentation" provides various screen and audio transfer functions, such as Distribution function, Multi-screen display, Movie Sending Mode, and Presentation Mode. By using EasyMP Network Projection, you can not only project, but also hold successful meetings and make presentations simply by connecting the projector to a computer.  [Projector Operation Guide](#) (EB-1925W/1915)

- Use Network Projector

Network projector is a standard function in Windows Vista. Therefore, you can project images from the computer by detecting the projector on the network only by using a function of the OS without having to install any special software.

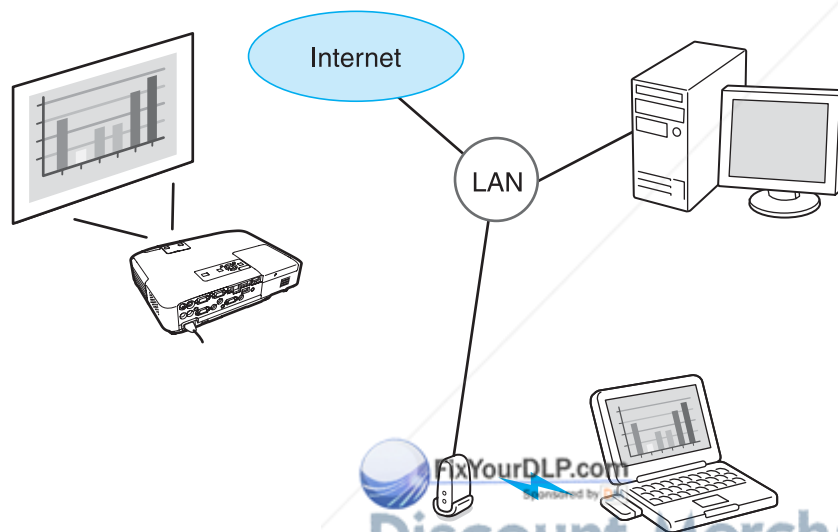

This section provides an easy explanation of Network Projector.

Check that the projector and computer are connected to the network, and carry out the following operations.

Procedure

- 1 Turn the projector on, and then press the [LAN] button on the remote control.**
- 2 Start Windows on your computer and select "Start"- "All Programs" - "Accessories" - "Connect to a Network Projector".**

The connection setting screen is displayed.

The projector is identified by inputting its IP address, or by allowing the OS to automatically identify all of the connected projectors.

- 3 Once the OS has identified all of the connected projectors, select the one that you want to use and click "Connect".**

When the projector password screen is displayed, enter the Projector keyword shown at the bottom of the LAN standby screen.



- You can only connect one projector to a computer.
- When using Network Projector from Options in Windows Meeting Space, set the colors for the computer screen you are using to the highest level (32bit). If it is not capable of a 32bit display, a message is displayed and you cannot connect.

Compatible OS

Windows: Vista Home Premium/Vista Business/Vista Enterprise/Vista Ultimate

Discount-Merchant.com (800) 281-8860

TRUSTED SOURCE FOR PROJECTOR LAMPS AND ACCESSORIES

PJLink Class1 was established by the JBMIA (Japan Business Machine and Information System Industries Association) as a standard protocol for controlling network-compatible projector's as part of their efforts to standardize projector control protocols.

The projector complies with the PJLink Class1 standard established by the JBMIA.

It complies with all commands except for the following commands defined by PJLink Class1, and agreement was confirmed by the PJLink standard adaptability verification.

URL:<http://pjlink.jbmia.or.jp/english/>

• **Non-compatible commands**

Function		PJLink Command
Mute settings	Image muting set	AVMT 11
	Audio muting set	AVMT 21

• **Input names defined by PJLink and corresponding projector sources**

Source	PJLink Command
Computer1	INPT 11
Computer2	INPT 12
Video	INPT 21
S-Video	INPT 22
HDMI (EB-1925W/1915only)	IMPT 32
USB1 (EB-1925W/1915 only) USB (EB-1920W/1910/1830 only)	INPT 41
USB2 (EB-1925W/1915 only)	INPT 42
LAN (EB-1925W/1920W/1915/1910/1830 only)	INPT 52
USB Display	INPT 53

- Manufacturer name displayed for "Manufacture name information query"
EPSON

- Model name displayed for "Product name information query"

EB-1925W

EB-1920W

EB-1915

EB-1910

EB-1830



Supported Monitor Displays (EB-1925W/1920W)

Computer signals (analog RGB)

Units: dots

Signal	Refresh Rate (Hz)	Resolution	Aspect Mode				
			Normal	16:9	Full	Zoom	Native
VGAEGA	85	640x350	1280x700	1280x720	1280x800	1280x700	640x350
VGA	60/72/75/85/iMac ^{*1}	640x480/640x360 ^{*2}	1066x800	1280x720	1280x800	1280x800	640x480
SVGA	56/60/72/75/85/iMac ^{*1}	800x600/800x450 ^{*2}	1066x800	1280x720	1280x800	1280x800	800x600
XGA	60/70/75/85/iMac ^{*1}	1024x768/1024x576 ^{*2}	1066x800	1280x720	1280x800	1280x800	1024x768
WXGA	60	1280x768	1280x768	1280x720	1280x800	1280x768	1280x768
	60	1360x768	1280x722	1280x720	1280x800	1280x722	1280x768
	60/75/85	1280x800	1280x800	1280x720	1280x800	1280x800	1280x800
WXGA+	60/75/85	1440x900	1280x800	1280x720	1280x800	1280x800	1280x800
WSXGA+ ^{*3}	60	1680x1050	1280x800	1280x720	1280x800	1280x800	1152x800
SXGA	70/75/85	1152x864	1066x800	1280x720	1280x800	1280x800	1152x800
	60/75/85	1280x1024	1000x800	1280x720	1280x800	1280x800	1152x800
	60/75/85	1280x960	1066x800	1280x720	1280x800	1280x800	1280x800
SXGA+	60/75/85	1400x1050	1066x800	1280x720	1280x800	1280x800	1280x800
UXGA	60	1600x1200	1066x800	1280x720	1280x800	1280x800	1280x800
MAC13"	67	640x480	1066x800	1280x720	1280x800	1280x800	640x480
MAC16"	75	832x624	1066x800	1280x720	1280x800	1280x800	832x624
MAC19"	60	1024x768	1066x800	1280x720	1280x800	1280x800	1024x768
	60	1024x768	1066x800	1280x720	1280x800	1280x800	1024x768



Signal	Refresh Rate (Hz)	Resolution	Aspect Mode				
			Normal	16:9	Full	Zoom	Native
MAC21"	75	1152x870	1059x800	1280x720	1280x800	1280x800	1152x800

*1 Connection is disabled if the equipment does not have a VGA output port.

*2 Letterbox signal

*3 Only compatible when **Wide** is selected as the **Resolution** from the Configuration Menu.

Even when signals other than those mentioned above are input, it is likely that the image can be projected. However, not all functions may be supported.

Component Video

Units: dots

Signal	Refresh Rate (Hz)	Resolution	Aspect Mode				
			Normal	16:9	Full	Zoom	Native
SDTV(480i)	60	720x480/720x360*	1066x800	1280x720	1280x800	1280x800	640x480
SDTV(576i)	50	720x576/720x432*	1066x800	1280x720	1280x800	1280x800	768x576
SDTV(480p)	60	720x480/720x360*	1066x800	1280x720	1280x800	1280x800	640x480
SDTV(576p)	50	720x576/720x432*	1066x800	1280x720	1280x800	1280x800	768x576
HDTV(720p)	50/60	1280x720	1280x720	1280x720	1280x800	1280x720	1280x720
HDTV(1080i)	50/60	1920x1080	1280x720	1280x720	1280x800	1280x720	1280x800
HDTV(1080p)	50/60	1920x1080	1280x720	1280x720	1280x800	1280x720	1280x800

* Letterbox signal

Composite video/S-video

Units: dots

Signal	Refresh Rate (Hz)	Resolution	Aspect Mode				
			Normal	16:9	Full	Zoom	Native
TV(NTSC)	60	720x480/720x360*	1066x800	1280x720	1280x800	1280x800	640x480
TV(PAL,SECAM)	50	720x576/720x432*	1066x800	1280x720	1280x800	1280x800	768x576

* Letterbox signal



Input signal from the HDMI input port (EB-1925W only)

Units: dots

Signal	Refresh Rate (Hz)	Resolution	Aspect Mode			
			16:9	Full	Zoom	Native
VGA	60	640x480/640x360*	1280x720	1280x800	1280x800	640x480
SVGA	60	800x600	1280x720	1280x800	1280x800	800x600
XGA	60	1024x768	1280x720	1280x800	1280x800	1024x768
WXGA	60	1280x800	1280x720	1280x800	1280x800	1280x800
SXGA	60	1280x960	1280x720	1280x800	1280x800	1280x800
	60	1280x1024	1280x720	1280x800	1280x800	1280x800
SXGA+	60	1400x1050	1280x800	1280x800	1280x800	1280x800
UXGA	60	1600x1200	1280x720	1280x800	1280x800	1280x800
SDTV(480i)	60	720x480/720x360*	1280x720	1280x800	1280x800	640x480
SDTV(480p)	60	720x480/720x360*	1280x720	1280x800	1280x800	640x480
SDTV(576i)	50	720x576/720x432*	1280x720	1280x800	1280x800	768x576
SDTV(576p)	50	720x576/720x432*	1280x720	1280x800	1280x800	768x576
HDTV(720p)	50/60	1280x720	1280x720	1280x800	1280x720	1280x720
HDTV(1080i)	50/60	1920x1080	1280x720	1280x800	1280x720	1280x800
HDTV(1080p)	24/50/60	1920x1080	1280x720	1280x800	1280x720	1280x800

* Letterbox signal



Discount-Merchant.com (800) 281-8860
THE TRUSTED SOURCE FOR PROJECTOR LAMPS AND ACCESSORIES

Supported Monitor Displays (EB-1915/1910/1900/1830)

Computer signals (analog RGB)

Units: dots

Signal	Refresh Rate (Hz)	Resolution	Aspect Mode		
			Normal	4:3	16:9
VGAEGA	85	640x350	1024x560	1024x768	1024x576
VGA	60/72/75/85/iMac ^{*1}	640x480/640x360 ^{*2}	1024x768	1024x768	1024x576
SVGA	56/60/72/75/85/iMac ^{*1}	800x600/800x450 ^{*2}	1024x768	1024x768	1024x576
XGA	60/70/75/85/iMac ^{*1}	1024x768/1024x576 ^{*2}	1024x768	1024x768	1024x576
WXGA	60	1280x768	1024x614	1024x768	1024x576
	60	1360x768	1024x578	1024x768	1024x576
	60/75/85	1280x800	1024x640	1024x768	1024x576
WXGA+	60/75/85	1440x900	1024x640	1024x768	1024x576
SXGA	70/75/85	1152x864	1024x768	1024x768	1024x576
	60/75/85	1280x1024	960x768	1024x768	1024x576
	60/75/85	1280x960	1024x768	1024x768	1024x576
SXGA+	60/75/85	1400x1050	1024x768	1024x768	1024x576
UXGA	60	1600x1200	1024x768	1024x768	1024x576
MAC13"	67	640x480	1024x768	1024x768	1024x576
MAC16"	75	832x624	1024x768	1024x768	1024x576
MAC19"	75	1024x768	1024x768	1024x768	1024x576
	75	1024x768	1024x768	1024x768	1024x576
MAC21"	75	1152x870	1016x768	1024x768	1024x576

*1 Connection is disabled if the equipment does not have a VGA output port.

*2 Letterbox signal

Even when signals other than those mentioned above are input, it is likely that the image can be projected. However, not all functions may be supported.

Component video

Units: dots

Signal	Refresh Rate (Hz)	Resolution	Aspect Mode	
			4:3	16:9
SDTV(480i)	60	720x480/720x360*	1024x768	1024x576
SDTV(576i)	50	720x576/720x432*	1024x768	1024x576
SDTV(480p)	60	720x480/720x360*	1024x768	1024x576
SDTV(576p)	50	720x576/720x432*	1024x768	1024x576
HDTV(720p)	50/60	1280x720	1024x768	1024x576
HDTV(1080i)	50/60	1920x1080	1024x768	1024x576
HDTV(1080p)	50/60	1920x1080	1024x768	1024x576

* Letterbox signal

Composite video/S-video

Units: dots

Signal	Refresh Rate (Hz)	Resolution	Aspect Mode	
			4:3	16:9
TV(NTSC)	60	720x480/720x360*	1024x768	1024x576
TV(PAL,SECAM)	50	720x576/720x432*	1024x768	1024x576

* Letterbox signal

Input signal from the HDMI input port (EB-1915 only)

Units: dots

Signal	Refresh Rate (Hz)	Resolution	Aspect Mode	
			16:9	Zoom
VGA	60	640x480/640x360*	1024x768	1024x576
SVGA	60	800x600	1024x768	1024x576
XGA	60	1024x768	1024x768	1024x576



FixYourDLP.com

Sponsored by

Discount-Merchant.com (800) 281-8860

THE TRUSTED SOURCE FOR PROJECTOR LAMPS AND ACCESSORIES



Signal	Refresh Rate (Hz)	Resolution	Aspect Mode	
			16:9	Zoom
WXGA	60	1280x800	1024x768	1024x576
SXGA	60	1280x960	1024x768	1024x576
	60	1280x1024	1024x768	1024x576
SXGA+	60	1400x1050	1024x768	1024x576
UXGA	60	1600x1200	1024x768	1024x576
SDTV(480i)	60	720x480/720x360*	1024x768	1024x576
SDTV(480p)	60	720x480/720x360*	1024x768	1024x576
SDTV(576i)	50	720x576/720x432*	1024x768	1024x576
SDTV(576p)	50	720x576/720x432*	1024x768	1024x576
HDTV(720p)	50/60	1280x720	1024x768	1024x576
HDTV(1080i)	50/60	1920x1080	1024x768	1024x576
HDTV(1080p)	24/50/60	1920x1080	1024x768	1024x576

* Letterbox signal



Discount-Merchant.com (800) 281-8860

THE TRUSTED SOURCE FOR PROJECTOR LAMPS AND ACCESSORIES

Projector General Specifications

Product name		EB-1915	EB-1925W	EB-1910	EB-1920W	EB-1830	EB-1900
Dimensions		357 (W) x 86 (H) x 257 (D) mm (not including raised section)					
Panel size		0.7"	0.74" Wide	0.7"	0.74" Wide	0.7"	
Display method		Polysilicon TFT active matrix					
Resolution		786,432 pixels XGA (1024 (W)x 768 (H) dots)x 3	1,024,000 pixels WXGA (1280 (W)x 800 (H) dots)x 3	786,432 pixels XGA (1024 (W)x 768 (H) dots)x 3	1,024,000 pixels WXGA (1280 (W)x 800 (H) dots)x 3	786,432 pixels XGA (1024 (W) x 768 (H) dots)x 3	
Focus adjustment		Automatic			Manual		
Zoom adjustment		Manual (1 to 1.6)					
Lamp		UHE lamp, 230 W Model No.: ELPLP53					
Max. audio output		10 W monaural					-
Speaker		1					-
Power supply		100 to 240 V AC \pm 10%, 50/60 Hz 3.9 to 1.7 A					100 to 240 V AC \pm 10%, 50/60Hz 3.7 to 1.6A
Power consumption	100 to 120 V area	Operating: 341 W Standby power consumption (Communication On): 5.5 W Standby power consumption (Communication Off): 0.2 W		Operating: 341 W Standby power consumption (Communication On): 7.2 W Standby power consumption (Communication Off): 0.2 W		Operating: 317 W Standby power consumption (Communication On): 7.2 W Standby power consumption (Communication Off): 0.2 W	
	200 to 240 V area	Operating: 319 W Standby power consumption (Communication On): 6.8 W Standby power consumption (Communication Off): 0.3 W		Operating: 319 W Standby power consumption (Communication On): 8.8 W Standby power consumption (Communication Off): 0.3 W		Operating: 298 W Standby power consumption (Communication On): 8.8 W Standby power consumption (Communication Off): 0.3 W	

Product name			EB-1915	EB-1925W	EB-1910	EB-1920W	EB-1830	EB-1900
Operating altitude			Altitude 0 to 2,286 m					
Operating temperature			5 to +35°C (No condensation)					
Storage temperature			-10 to +60°C (No condensation)					
Mass			Approx. 3.5kg		Approx. 3.4kg			Approx. 3.2kg
Conne- ctors	Computer Input Port	1	-					Mini D-Sub15-pin (fe- male) blue
	Computer1 Input Port	1	Mini D-Sub15-pin (female) blue					-
	Audio1 Port	1	Stereo mini jack					-
	Computer2 Input Port	1	Mini D-Sub15-pin (female) blue					-
	Audio2 Port	1	Stereo mini jack					-
	Video input port	1	RCA pin jack					RCA pin jack
	S-Video input port	1	Mini DIN 4-pin					Mini DIN 4-pin
	Audio Port	1	RCA pin jack x 2 (L, R)					-
	HDMI input port	1	HDMI (Audio is only supported by PCM)	-				
Monitor Out Port	1	Mini D-Sub15-pin (female) black					-	
Audio Out Port	1	Stereo mini jack					-	



Product name			EB-1915	EB-1925W	EB-1910	EB-1920W	EB-1830	EB-1900
Connectors	USB1 port*	1	USB connector (Type A)		-			
	USB2 port*	1	USB connector (Type A)		-			
	USB (TypeA) Port*	1	-		USB connector (Type A)			-
	USB (TypeB) Port*	1	USB connector (Type B)					
	USB Port (dedicated to Wireless LAN unit)	1	USB connector (Type A)		-			
	LAN Port	1	RJ-45					-
	RS-232C Port	1	Mini D-Sub 9-pin (male)					

* Supports USB 2.0. However, USB ports are not guaranteed to operate all devices that support USB.

This product is also designed for IT power distribution system with phase-to-phase voltage 230V.



Pixelworks DNX™ ICs are used in this projector.

Angle of tilt

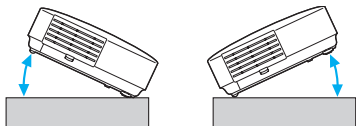

If you use the projector tilted at an angle of more than 45° it could be damaged and cause an accident.



Discount-Merchant.com (800) 281-8860
THE TRUSTED SOURCE FOR PROJECTOR LAMPS AND ACCESSORIES

Software Requirements (EB-1925W/1920W/1915/1910/1830 Only)

The software supplied with the projector runs on computers that meet the following requirements.

EasyMP Slide Converter is only included in EB-1925W/1915.

	EasyMP Network Projection	EasyMP Slide Converter* ¹	EasyMP Monitor
OS	Windows 2000 SP4/Windows XP/Windows XP SP1 and later/Windows Vista/Windows Vista SP1 Mac OS X 10.3 or later Recommended: Mac OS X 10.5.1 or later, 10.4.11/10.3.9	Windows 2000 SP4/Windows XP SP2 and later/Windows Vista SP1 and later	Windows 98 SE SP1/Windows Me/Windows NT4.0 SP6/Windows 2000 SP4/Windows XP 32Bit version SP2 or later/Windows Vista/Windows Vista SP1* ³
CPU	Mobile Pentium III 1.2 GHz or faster Power PC G3 900MHz or faster Recommended: Pentium M 1.6GHz or faster CoreDuo 1.5GHz or faster	Pentium M 1.6GHz or faster	Pentium MMX 166MHz or more Recommended: Pentium II 233MHz or more
Amount of Memory	256MB or more Recommended: 512MB or more	512 MB or more	64MB or more
Hard Disk Free space	20MB or more	50 MB or more* ²	50MB or more
Display	Resolution greater than XGA (1024x768) Display color of approx. 32000 colors more than 16 bit colors	Resolution greater than XGA (1024x768) Display color in 16 bit/32 bit full-color	Resolution greater than SVGA (800x600) Display color in 32 bit full-color or greater

*1 PowerPoint 2002 or later and Visual Basic for Applications (VBA) must be installed.

*2 Required space at the time of install. When converting a PowerPoint file, the space requirement varies according to the type and number of animations that are configured in the PowerPoint file.

*3 Internet Explorer Ver.5 or later, and a user with Administrator rights



DECLARATION of CONFORMITY

According to 47CFR, Part 2 and 15

Class B Personal Computers and Peripherals; and/or
CPU Boards and Power Supplies used with Class B Personal Computers

We: Epson America, Inc.
Located at: 3840 Kilroy Airport Way
MS: 3-13
Long Beach, CA 90806
Tel: 562-290-5254

Declare under sole responsibility that the product identified herein, complies with 47CFR Part 2 and 15 of the FCC rules as a Class B digital device. Each product marketed, is identical to the representative unit tested and found to be compliant with the standards. Records maintained continue to reflect the equipment being produced can be expected to be within the variation accepted, due to quantity production and testing on a statistical basis as required by 47CFR 2.909. Operation is subject to the following two conditions : (1) this device may not cause harmful interference, and (2) this device must accept any interference received, including interference that may cause undesired operation.

Trade Name: EPSON
Type of Product: Projector
Model: H313C/H314C/H315C/H316C/H326C/H341C



Discount-Merchant.com (800) 251-8860
THE TRUSTED SOURCE FOR PROJECTOR LAMPS AND ACCESSORIES

**FCC Compliance Statement
For United States Users**

This equipment has been tested and found to comply with the limits for a Class B digital device, pursuant to Part 15 of the FCC Rules. These limits are designed to provide reasonable protection against harmful interference in a residential installation. This equipment generates, uses, and can radiate radio frequency energy and, if not installed and used in accordance with the instructions, may cause harmful interference to radio or television reception. However, there is no guarantee that interference will not occur in a particular installation. If this equipment does cause interference to radio and television reception, which can be determined by turning the equipment off and on, the user is encouraged to try to correct the interference by one or more of the following measures.

- Reorient or relocate the receiving antenna.
- Increase the separation between the equipment and receiver.
- Connect the equipment into an outlet on a circuit different from that to which the receiver is connected.
- Consult the dealer or an experienced radio/TV technician for help.

WARNING

The connection of a non-shielded equipment interface cable to this equipment will invalidate the FCC Certification or Declaration of this device and may cause interference levels which exceed the limits established by the FCC for this equipment. It is the responsibility of the user to obtain and use a shielded equipment interface cable with this device. If this equipment has more than one interface connector, do not leave cables connected to unused interfaces. Changes or modifications not expressly approved by the manufacturer could void the user's authority to operate the equipment.

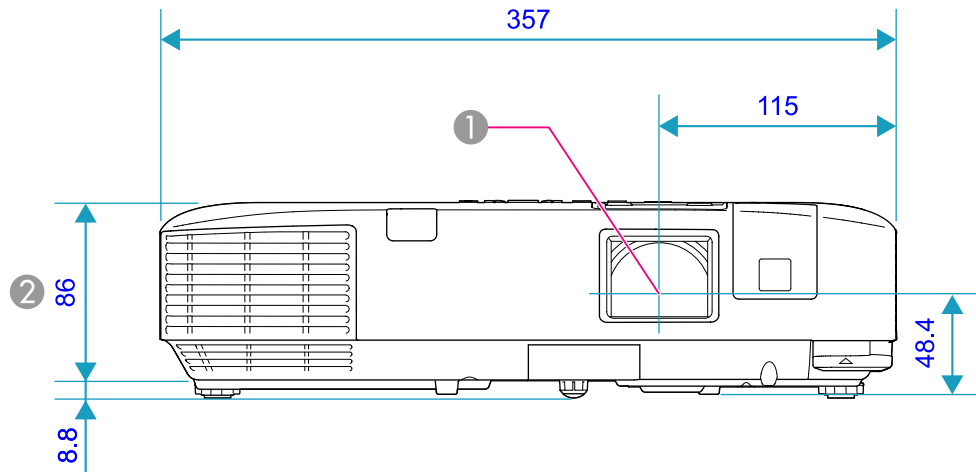

- ① Center of lens
- ② * Distance from center of lens to suspension bracket fixing point

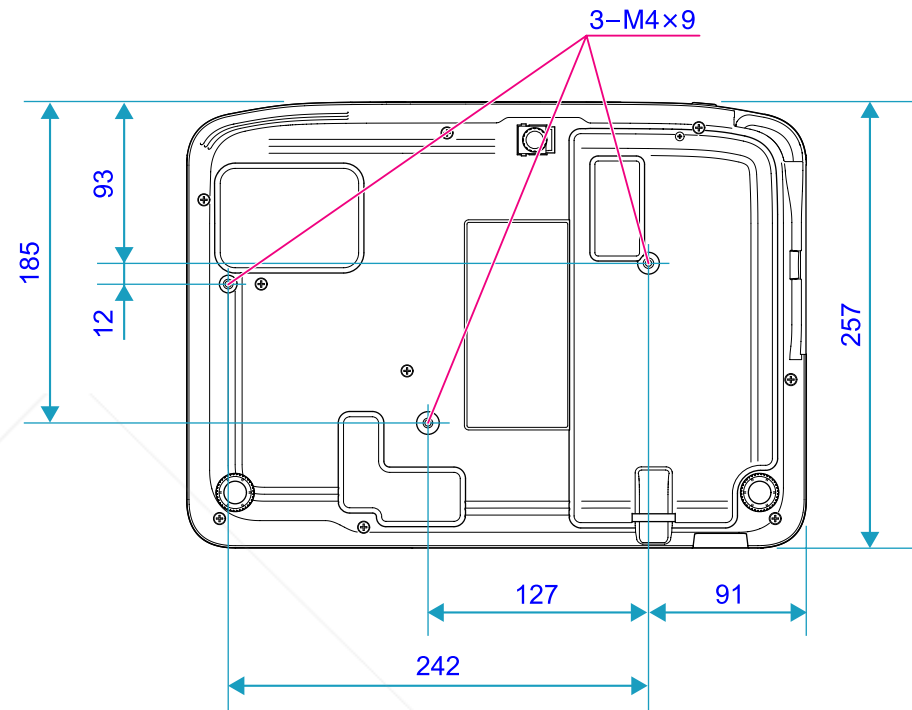

Units: mm

This section explains easily terms that are used with the projector and difficult terms that are not explained in the text of this guide. For details, refer to other commercially available publications.

AMX Device Discovery	AMX Device Discovery is a technology developed by AMX to facilitate AMX control systems for easy operation of the target equipment. Epson have implemented this protocol technology, and have provided a setting to enable the protocol function (ON). See the AMX Web site for more details. URL http://www.amx.com/
Aspect Ratio (Aspect Ratio)	The ratio between an image's length and its height. HDTV images have an aspect ratio of 16:9 and appear elongated. The aspect ratio for standard images is 4:3.
Component Video	A Video signal which has the luminance component and color component separated to provide better image quality. Refers to images that consist of three independent signals: Y (luminance signal), Pb and Pr (color difference signals).
Composite video	Video signals that have the video brightness signals and color signals mixed together. The type of signals commonly used by household video equipment (NTSC, PAL, and SECAM formats). The carrier signal Y (luminance signal) and chroma (color) signal that are contained in the color bar are overlapped to form a single signal.
Contrast	The relative brightness of the light and dark areas of an image can be increased or decreased to make text and graphics stand out more clearly, or to make them appear softer. Adjusting this particular property of an image is called Contrast adjustment.
DHCP	An abbreviation of Dynamic Host Configuration Protocol, this protocol automatically assigns an IP Address to equipment connected to a Network.
Dolby Digital	A sound format developed by Dolby Laboratories. Normal stereo is a 2-channel format that uses two speakers. Dolby Digital is a 6-channel (5.1-channel) system which adds to this a center speaker, two rear speakers, and a sub-woofer.
Gateway address (Gateway Address)	This is a server (router) for communicating across a Network (subnet) divided according to Subnet Mask .
HDCP	HDCP is an abbreviation for High-bandwidth Digital Content Protection. It is used to prevent illegal copying and protect copyrights by encrypting digital signals sent over DVI and HDMI ports. Because the HDMI input port on this projector supports HDCP, it can project digital images protected by HDCP technology. However, the projector may not be able to project images protected with updated or revised versions of HDCP encryption.
HDTV	An abbreviation for High-Definition Television that refers to high-definition systems which satisfy the following conditions. <ul style="list-style-type: none"> • Screen Resolution of 720p or 1080i or greater (p = Progressive, i = Interlace) • Screen Aspect Ratio of 16:9
Interlace	A method of image scanning whereby the image data is divided into fine horizontal lines that are displayed in sequence starting from left to right and then from top to bottom. The even-numbered lines and odd-numbered lines are displayed alternately.
IP Address	A number to identify a computer connected to a Network.
Progressive	A method of image scanning whereby the image data from a single image is scanned sequentially from top to bottom to create a single image.

Refresh Rate	The light-emitting element of a display maintains the same luminosity and color for an extremely short time. Because of this, the image must be scanned many times per second to refresh the light-emitting element. The number of refresh operations per second is called the Refresh Rate and is expressed in hertz (Hz).
SDTV	An abbreviation for Standard Definition Television that refers to standard television systems which do not satisfy the conditions for HDTV High-Definition Television.
SNMP	An abbreviation for Simple Network Management Protocol, which is the protocol for monitoring and controlling devices such as routers and computers connected to a TCP/IP Network.
sRGB	An international standard for color intervals that was formulated so that colors that are reproduced by video equipment can be handled easily by computer operating systems (OS) and the Internet. If the connected source has an sRGB mode, set both the projector and the connected signal source to sRGB.
SSID	SSID is an identification number for connecting with a counterpart on a Wireless LAN. Wireless communication is possible between devices that correspond to SSID.
Subnet mask (Subnet Mask)	This is a numerical value that defines the number of bits used for the Network address on a divided network (subnet) from the IP Address.
SVGA	A type of video signal with a resolution of 800 (horizontal) × 600 (vertical) dots that is used by IBM PC/AT-compatible computers.
S-Video	A Video signal which has the luminance component and color component separated to provide better image quality. Refers to images that consist of two independent signals: Y (luminance signal) and C (color signal).
SXGA	A type of video signal with a resolution of 1,280 (horizontal) × 1,024 (vertical) dots that is used by IBM PC/AT-compatible computers.
Sync.	The signals output from computers have a specific frequency. If the projector frequency does not match this frequency, the resulting images are not of a good quality. The process of matching the phases of these signals (the relative position of the crests and the troughs in the signal) is called Synchronization. If the signals are not synchronized, flickering, blurriness, and horizontal interference occur.
Tracking	The signals output from computers have a specific frequency. If the projector frequency does not match this frequency, the resulting images are not of a good quality. The process of matching the frequency of these signals (the number of crests in the signal) is called Tracking. If Tracking is not carried out correctly, wide vertical stripes appear in the signal.
Trap IP Address	This is the IP Address for the destination computer used for error notification in SNMP.
VGA	A type of video signal with a resolution of 640 (horizontal) × 480 (vertical) dots that is used by IBM PC/AT-compatible computers.
Wi-Fi Protected Setup	Wi-Fi Protected Setup has been devised by the Wi-Fi Alliance as a means of easily setting up and securing a Wireless LAN.
XGA	A type of video signal with a resolution of 1,024 (horizontal) × 768 (vertical) dots that is used by IBM PC/AT-compatible computers.

All rights reserved. No part of this publication may be reproduced, stored in a retrieval system, or transmitted in any form or by any means, electronic, mechanical, photocopying, recording, or otherwise, without the prior written permission of Seiko Epson Corporation. No patent liability is assumed with respect to the use of the information contained herein. Neither is any liability assumed for damages resulting from the use of the information contained herein.

Neither Seiko Epson Corporation nor its affiliates shall be liable to the purchaser of this product or third parties for damages, losses, costs, or expenses incurred by the purchaser or third parties as a result of: accident, misuse, or abuse of this product or unauthorized modifications, repairs, or alterations to this product, or (excluding the U.S.) failure to strictly comply with Seiko Epson Corporation's operating and maintenance instructions.

Seiko Epson Corporation shall not be liable against any damages or problems arising from the use of any options or any consumable products other than those designated as Original Epson Products or Epson Approved Products by Seiko Epson Corporation.

The contents of this guide may be changed or updated without further notice.

Illustrations in this guide and the actual projector may differ.

General Notice:

Windows Vista and the Windows logo are trademarks of the Microsoft group of companies.

IBM, DOS/V, and XGA are trademarks or registered trademarks of International Business Machines Corporation.

Macintosh, Mac, and iMac are trademarks of Apple Inc.

Windows, Windows NT, and PowerPoint are trademarks or registered trademarks of Microsoft Corporation in the United States.

Dolby is a trademark of Dolby Laboratories.

Pixelworks and DNX are trademarks of Pixelworks Inc.

This product includes RSA, BSAFE™ Cryptographic software from RSA Security Inc. RSA is a registered trademark of RSA Security Inc. BSAFE RSA Security Inc. is a registered trade mark in the United States and other countries.

This product includes **NetNucleus**® **WPA** software from TOSHIBA INFORMATION SYSTEMS CORPORATION.

NetNucleus is a registered trademark of TOSHIBA INFORMATION SYSTEMS CORPORATION in Japan.

WPA™, WPA2™ and Wi-Fi Protected Setup™ are registered trademarks of Wi-Fi Alliance.

HDMI and High-Definition Multimedia Interface are the trademarks or registered trademarks of HDMI Licensing LLC. **HDMI**™
HIGH DEFINITION MULTIMEDIA INTERFACE

PJLink trademark is a trademark applied for registration or is already registered in Japan, the United States of America and other countries and areas.

Other product names used herein are also for identification purposes only and may be trademarks of their respective owners. Epson disclaims any and all rights in those marks.



Software Copyright:

This product uses free software as well as software to which this company holds the rights.

The following is information on the free software used by this product.

1. LGPL

- (1) This company uses free software for this product under the terms of the GNU LESSER General Public License Version 2, June 1991 (henceforth "LGPL") or later versions.

You can see the full text of the LGPL on the following Web sites.

[LGPL]<http://www.gnu.org/licenses/gpl.html>

This company, under the terms of the LGPL, discloses the source code for the free software used in this product based on the LGPL.

Contact the support personnel as provided in the Epson Projector Contact list to reproduce, modify, and/or distribute the free software concerned.

Please follow the conditions of the LGPL when reproducing, modifying, and/or distributing the free software concerned.

Also, the free software concerned is offered "as is" with no guarantee or warranty what so ever. The term guarantee includes, but is not limited to, appropriate commercialization, business potential, purpose of use, and does not infringe on third person rights (including, but not limited to, patent rights, copyrights, and trade secrets).

- (2) Furthermore, as stated in (1), there is no guarantee for free software that is included in this product to which the LGPL applies because of the characteristics of the free software that has already used in this product; any problems in this product (including problems that originate with the free software concerned) do not influence the conditions of the guarantee (written guarantee) issued by this company.
- (3) Under the terms of the LGPL, the source code as well as authorship for the free software used in this product is disclosed as stated in (1).

2. Other free software

As well as the free software used under the terms of the LGPL, this company also uses the following free software for this product.

Hereafter, each author, the conditions, and so on are described in the original. Furthermore, there is no guarantee for free software because of the characteristics of the free software that has already been used in this product; any problems in this product (including problems that originate with the free software concerned) do not influence the conditions of the guarantee (written guarantee) issued by this company.

- (1) libpng

Copyright© 1998-2004 Glenn Randers-Pehrson

Copyright© 1996-1997 Andreas Dilger

Copyright© 1995-1996 Guy Eric Schalnat, Group 42, Inc.

- (2) zlib

Copyright© 1995-2003 Jean-loup Gailly and Mark Adler

GNU GPL

This projector product includes the open source software programs which apply the GNU General Public License Version 2 or later version ("GPL Programs"). We provide the source code of the GPL Programs until five (5) years after the discontinuation of same model of this projector product.

If you desire to receive the source code of the GPL Programs, please see the "EPSON Projector Contact List" in the User's Guide, and contact the customer support of your region.

These GPL Programs are WITHOUT ANY WARRANTY; without even the implied warranty of MERCHANTABILITY AND FITNESS FOR A PARTICULAR PURPOSE. See the GNU General Public License for more details.

The list of GPL Programs is as follows and the names of author are described in the source code of the GPL Programs

The list of GPL Programs



FixYourDLP.com

Discount-Merchant.com (800) 281-8860

THE TRUSTED SOURCE FOR PROJECTOR LAMPS AND ACCESSORIES

busybox-1.7.2

libgcc1(gcc-4.2.3)

linux-2.6.20

patches

udhcp 0.9.8

uvc rev.219

wireless_tools 29

Pixelworks PWC950 SDK drivers

The GNU General Public License Version 2 is as follows. You also can see the GNU General Public License Version 2 at <http://www.gnu.org/licenses/>.

GNU GENERAL PUBLIC LICENSE

Version 2, June 1991

Copyright (C) 1989, 1991 Free Software Foundation, Inc., 51 Franklin Street, Fifth Floor, Boston, MA 02110-1301 USA Everyone is permitted to copy and distribute verbatim copies of this license document, but changing it is not allowed.

Preamble

The licenses for most software are designed to take away your freedom to share and change it. By contrast, the GNU General Public License is intended to guarantee your freedom to share and change free software--to make sure the software is free for all its users. This General Public License applies to most of the Free Software Foundation's software and to any other program whose authors commit to using it. (Some other Free Software Foundation software is covered by the GNU Lesser General Public License instead.) You can apply it to your programs, too.

When we speak of free software, we are referring to freedom, not price. Our General Public Licenses are designed to make sure that you have the freedom to distribute copies of free software (and charge for this service if you wish), that you receive source code or can get it if you want it, that you can change the software or use pieces of it in new free programs; and that you know you can do these things.

To protect your rights, we need to make restrictions that forbid anyone to deny you these rights or to ask you to surrender the rights. These restrictions translate to certain responsibilities for you if you distribute copies of the software, or if you modify it.

For example, if you distribute copies of such a program, whether gratis or for a fee, you must give the recipients all the rights that you have. You must make sure that they, too, receive or can get the source code. And you must show them these terms so they know their rights.

We protect your rights with two steps: (1) copyright the software, and (2) offer you this license which gives you legal permission to copy, distribute and/or modify the software.

Also, for each author's protection and ours, we want to make certain that everyone understands that there is no warranty for this free software. If the software is modified by someone else and passed on, we want its recipients to know that what they have is not the original, so that any problems introduced by others will not reflect on the original authors' reputations.

Finally, any free program is threatened constantly by software patents. We wish to avoid the danger that redistributors of a free program will individually obtain patent licenses, in effect making the program proprietary. To prevent this, we have made it clear that any patent must be licensed for everyone's free use or not licensed at all.

The precise terms and conditions for copying, distribution and modification follow.

GNU GENERAL PUBLIC LICENSE TERMS AND CONDITIONS FOR COPYING, DISTRIBUTION AND MODIFICATION

0. This License applies to any program or other work which contains a notice placed by the copyright holder saying it may be distributed under the terms of this General Public License. The "Program", below, refers to any such program or work, and a "work based on the Program" means either the Program or any derivative work under copyright law: that is to say, a work containing the Program or a portion of it, either verbatim or with modifications and/or translated into another language. (Hereinafter, translation is included without limitation in the term "modification".) Each licensee is addressed as "you".

Activities other than copying, distribution and modification are not covered by this License; they are outside its scope. The act of running the Program is not restricted, and the output from the Program is covered only if its contents constitute a work based on the Program (independent of having been made by running the Program). Whether that is true depends on what the Program does.

1. You may copy and distribute verbatim copies of the Program's source code as you receive it, in any medium, provided that you conspicuously and appropriately publish on each copy an appropriate copyright notice and disclaimer of warranty; keep intact all the notices that refer to this License and to the absence of any warranty; and give any other recipients of the Program a copy of this License along with the Program.

You may charge a fee for the physical act of transferring a copy, and you may at your option offer warranty protection in exchange for a fee.

2. You may modify your copy or copies of the Program or any portion of it, thus forming a work based on the Program, and copy and distribute such modifications or work under the terms of Section 1 above, provided that you also meet all of these conditions:
 - a) You must cause the modified files to carry prominent notices stating that you changed the files and the date of any change.
 - b) You must cause any work that you distribute or publish, that in whole or in part contains or is derived from the Program or any part thereof, to be licensed as a whole at no charge to all third parties under the terms of this License.
 - c) If the modified program normally reads commands interactively when run, you must cause it, when started running for such interactive use in the most ordinary way, to print or display an announcement including an appropriate copyright notice and a notice that there is no warranty (or else, saying that you provide a warranty) and that users may redistribute the program under these conditions, and telling the user how to view a copy of this License. (Exception: if the Program itself is interactive but does not normally print such an announcement, your work based on the Program is not required to print an announcement.)

These requirements apply to the modified work as a whole. If identifiable sections of that work are not derived from the Program, and can be reasonably considered independent and separate works in themselves, then this License, and its terms, do not apply to those sections when you distribute them as separate works. But when you distribute some sections as part of a whole which is a work based on the Program, the distribution of the whole must be on the terms of this License, whose permissions for other licensees extend to the entire whole, and thus to each and every part regardless of who wrote it.

Thus, it is not the intent of this section to claim rights or contest your rights to work written entirely by you; rather, the intent is to exercise the right to control the distribution of derivative or collective works based on the Program.

In addition, mere aggregation of another work not based on the Program with the Program (or with a work based on the Program) on a volume of a storage or distribution medium does not bring the other work under the scope of this License.

3. You may copy and distribute the Program (or a work based on it, under Section 2) in object code or executable form under the terms of Sections 1 and 2 above provided that you also do one of the following:
 - a) Accompany it with the complete corresponding machine-readable source code, which must be distributed under the terms of Sections 1 and 2 above on a medium customarily used for software interchange; or,
 - b) Accompany it with a written offer, valid for at least three years, to give any third party, for a charge no more than your cost of physically performing source distribution, a complete machine-readable copy of the corresponding source code, to be distributed under the terms of Sections 1 and 2 above on a medium customarily used for software interchange; or,
 - c) Accompany it with the information you received as to the offer to distribute corresponding source code. (This alternative is allowed only for noncommercial distribution and only if you received the program in object code or executable form with such an offer, in accord with Subsection b above.)

The source code for a work means the preferred form of the work for making modifications to it. For an executable work, complete source code means all the source code for all modules it contains, plus any associated interface definition files, plus the scripts used to control compilation and installation of the executable. However, as a special exception, the source code distributed need not include anything that is normally distributed (in either source or binary form) with the major components (compiler, kernel, and so on) of the operating system on which the executable runs, unless that component itself accompanies the executable.

If distribution of executable or object code is made by offering access to copy from a designated place, then offering equivalent access to copy the source code from the same place counts as distribution of the source code, even though third parties are not compelled to copy the source along with the object code.

4. You may not copy, modify, sublicense, or distribute the Program except as expressly provided under this License. Any attempt otherwise to copy, modify, sublicense or distribute the Program is void, and will automatically terminate your rights under this License. However, parties who have received copies, or rights, from you under this License will not have their licenses terminated so long as such parties remain in full compliance.
5. You are not required to accept this License, since you have not signed it. However, nothing else grants you permission to modify or distribute the Program or its derivative works. These actions are prohibited by law if you do not accept this License. Therefore, by modifying or distributing the Program (or any work based on the Program), you indicate your acceptance of this License to do so, and all its terms and conditions for copying, distributing or modifying the Program or works based on it.
6. Each time you redistribute the Program (or any work based on the Program), the recipient automatically receives a license from the original licensor to copy, distribute or modify the Program subject to these terms and conditions. You may not impose any further restrictions on the recipients' exercise of the rights granted herein. You are not responsible for enforcing compliance by third parties to this License.
7. If, as a consequence of a court judgment or allegation of patent infringement or for any other reason (not limited to patent issues), conditions are imposed on you (whether by court order, agreement or otherwise) that contradict the conditions of this License, they do not excuse you from the conditions of this License. If you cannot distribute so as to satisfy simultaneously your obligations under this License and any other pertinent obligations, then as a consequence you may not distribute the Program at all. For example, if a patent license would not permit royalty-free redistribution of the Program by all those who receive copies directly or indirectly through you, then the only way you could satisfy both it and this License would be to refrain entirely from distribution of the Program. If any portion of this section is held invalid or unenforceable under any particular circumstance, the balance of the section is intended to apply and the section as a whole is intended to apply in other circumstances.

It is not the purpose of this section to induce you to infringe any patents or other property right claims or to contest validity of any such claims; this section has the sole purpose of protecting the integrity of the free software distribution system, which is implemented by public license practices. Many people have made generous contributions to the wide range of software distributed through that system in reliance on consistent application of that system; it is up to the author/donor to decide if he or she is willing to distribute software through any other system and a licensee cannot impose that choice.

This section is intended to make thoroughly clear what is believed to be a consequence of the rest of this License.

8. If the distribution and/or use of the Program is restricted in certain countries either by patents or by copyrighted interfaces, the original copyright holder who places the Program under this License may add an explicit geographical distribution limitation excluding those countries, so that distribution is permitted only in or among countries not thus excluded. In such case, this License incorporates the limitation as if written in the body of this License.
9. The Free Software Foundation may publish revised and/or new versions of the General Public License from time to time. Such new versions will be similar in spirit to the present version, but may differ in detail to address new problems or concerns. Each version is given a distinguishing version number. If the Program specifies a version number of this License which applies to it and "any later version", you have the option of following the terms and conditions either of that version or of any later version published by the Free Software Foundation. If the Program does not specify a version number of this License, you may choose any version ever published by the Free Software Foundation.
10. If you wish to incorporate parts of the Program into other free programs whose distribution conditions are different, write to the author to ask for permission. For software which is copyrighted by the Free Software Foundation, write to the Free Software Foundation; we sometimes make exceptions for this. Our decision will be guided by the two goals of preserving the free status of all derivatives of our free software and of promoting the sharing and reuse of software generally.

NO WARRANTY

11. BECAUSE THE PROGRAM IS LICENSED FREE OF CHARGE, THERE IS NO WARRANTY FOR THE PROGRAM, TO THE EXTENT PERMITTED BY APPLICABLE LAW. EXCEPT WHEN OTHERWISE STATED IN WRITING THE COPYRIGHT HOLDERS AND/OR OTHER PARTIES PROVIDE THE PROGRAM "AS IS" WITHOUT WARRANTY OF ANY KIND, EITHER EXPRESSED OR IMPLIED, INCLUDING, BUT NOT LIMITED TO, THE IMPLIED WARRANTIES OF MERCHANTABILITY AND FITNESS FOR A PARTICULAR PURPOSE. THE ENTIRE RISK AS TO THE QUALITY AND PERFORMANCE OF THE PROGRAM IS WITH YOU. SHOULD THE PROGRAM PROVE DEFECTIVE, YOU ASSUME THE COST OF ALL NECESSARY SERVICING, REPAIR OR CORRECTION.
12. IN NO EVENT UNLESS REQUIRED BY APPLICABLE LAW OR AGREED TO IN WRITING WILL ANY COPYRIGHT HOLDER, OR ANY OTHER PARTY WHO MAY MODIFY AND/OR REDISTRIBUTE THE PROGRAM AS PERMITTED ABOVE, BE LIABLE TO YOU FOR DAMAGES, INCLUDING ANY GENERAL, SPECIAL, INCIDENTAL OR CONSEQUENTIAL DAMAGES ARISING OUT OF THE USE OR INABILITY TO USE THE PROGRAM (INCLUDING BUT NOT LIMITED TO LOSS OF DATA OR DATA BEING RENDERED INACCURATE OR LOSSES SUSTAINED BY YOU OR THIRD PARTIES OR A FAILURE OF THE PROGRAM TO OPERATE WITH ANY OTHER PROGRAMS), EVEN IF SUCH HOLDER OR OTHER PARTY HAS BEEN ADVISED OF THE POSSIBILITY OF SUCH DAMAGES.

END OF TERMS AND CONDITIONS

How to Apply These Terms to Your New Programs

If you develop a new program, and you want it to be of the greatest possible use to the public, the best way to achieve this is to make it free software which everyone can redistribute and change under these terms.

To do so, attach the following notices to the program. It is safest to attach them to the start of each source file to most effectively convey the exclusion of warranty; and each file should have at least the "copying" line and a pointer to where the full notice is found.

<one line to give the program's name and a brief idea of what it does.>

Copyright (C) <year> <name of author>

This program is free software; you can redistribute it and/or modify it under the terms of the GNU General Public License as published by the Free Software Foundation; either version 2 of the License, or (at your option) any later version.

This program is distributed in the hope that it will be useful, but WITHOUT ANY WARRANTY; without even the implied warranty of MERCHANTABILITY or FITNESS FOR A PARTICULAR PURPOSE. See the GNU General Public License for more details.

You should have received a copy of the GNU General Public License along with this program; if not, write to the Free Software Foundation, Inc., 51 Franklin Street, Fifth Floor, Boston, MA 02110-1301 USA.

Also add information on how to contact you by electronic and paper mail.

If the program is interactive, make it output a short notice like this when it starts in an interactive mode:

```
Gnomovision version 69, Copyright (C) year name of author Gnomovision
comes with ABSOLUTELY NO WARRANTY; for details type `show w'. This is
free software, and you are welcome to redistribute it under certain conditions;
type `show c' for details.
```

The hypothetical commands `show w' and `show c' should show the appropriate parts of the General Public License. Of course, the commands you use may be called something other than `show w' and `show c'; they could even be mouse-clicks or menu items--whatever suits your program.

You should also get your employer (if you work as a programmer) or your school, if any, to sign a "copyright disclaimer" for the program, if necessary. Here is a sample; alter the names:

```
Yoyodyne, Inc., hereby disclaims all copyright interest in the program
`Gnomovision' (which makes passes at compilers) written by James Hacker.

<signature of Ty Coon>, 1 April 1989
Ty Coon, President of Vice
```

This General Public License does not permit incorporating your program into proprietary programs. If your program is a subroutine library, you may consider it more useful to permit linking proprietary applications with the library. If this is what you want to do, use the GNU Lesser General Public License instead of this License.

GNU LGPL

This projector product includes the open source software programs which apply the GNU Lesser General Public License Version 2 or later version ("LGPL Programs").

We provide the source code of the LGPL Programs until five (5) years after the discontinuation of same model of this projector product.

If you desire to receive the source code of the LGPL Programs, please see the "EPSON Projector Contact List" in the User's Guide, and contact the customer support of your region.

These LGPL Programs are WITHOUT ANY WARRANTY; without even the implied warranty of MERCHANTABILITY AND FITNESS FOR A PARTICULAR PURPOSE. See the GNU General Public License for more details.

The list of LGPL Programs is as follows and the names of author are described in the source code of the LGPL Programs.

LGPL Programs

uClibc-0.9.29

SDL-1.2.13

The GNU Lesser General Public License Version 2 is as follows. You also can see the GNU Lesser General Public License Version 2 at <http://www.gnu.org/licenses/>.

GNU LESSER GENERAL PUBLIC LICENSE

Version 2.1, February 1999

Copyright (C) 1991, 1999 Free Software Foundation, Inc. 51 Franklin Street, Fifth Floor, Boston, MA 02110-1301 USA Everyone is permitted to copy and distribute verbatim copies of this license document, but changing it is not allowed.

[This is the first released version of the Lesser GPL. It also counts as the successor of the GNU Library Public License, version 2, hence the version number 2.1.]

Preamble

The licenses for most software are designed to take away your freedom to share and change it. By contrast, the GNU General Public Licenses are intended to guarantee your freedom to share and change free software--to make sure the software is free for all its users.

This license, the Lesser General Public License, applies to some specially designated software packages--typically libraries--of the Free Software Foundation and other authors who decide to use it. You can use it too, but we suggest you first think carefully about whether this license or the ordinary General Public License is the better strategy to use in any particular case, based on the explanations below.

When we speak of free software, we are referring to freedom of use, not price. Our General Public Licenses are designed to make sure that you have the freedom to distribute copies of free software (and charge for this service if you wish); that you receive source code or can get it if you want it; that you can change the software and use pieces of it in new free programs; and that you are informed that you can do these things.

To protect your rights, we need to make restrictions that forbid distributors to deny you these rights or to ask you to surrender these rights. These restrictions translate to certain responsibilities for you if you distribute copies of the library or if you modify it.

For example, if you distribute copies of the library, whether gratis or for a fee, you must give the recipients all the rights that we gave you. You must make sure that they, too, receive or can get the source code. If you link other code with the library, you must provide complete object files to the recipients, so that they can relink them with the library after making changes to the library and recompiling it. And you must show them these terms so they know their rights.

We protect your rights with a two-step method: (1) we copyright the library, and (2) we offer you this license, which gives you legal permission to copy, distribute and/or modify the library.

To protect each distributor, we want to make it very clear that there is no warranty for the free library. Also, if the library is modified by someone else and passed on, the recipients should know that what they have is not the original version, so that the original author's reputation will not be affected by problems that might be introduced by others.

Finally, software patents pose a constant threat to the existence of any free program. We wish to make sure that a company cannot effectively restrict the users of a free program by obtaining a restrictive license from a patent holder. Therefore, we insist that any patent license obtained for a version of the library must be consistent with the full freedom of use specified in this license.

Most GNU software, including some libraries, is covered by the ordinary GNU General Public License. This license, the GNU Lesser General Public License, applies to certain designated libraries, and is quite different from the ordinary General Public License. We use this license for certain libraries in order to permit linking those libraries into non-free programs.

When a program is linked with a library, whether statically or using a shared library, the combination of the two is legally speaking a combined work, a derivative of the original library. The ordinary General Public License therefore permits such linking only if the entire combination fits its criteria of freedom. The Lesser General Public License permits more lax criteria for linking other code with the library.

We call this license the "Lesser" General Public License because it does Less to protect the user's freedom than the ordinary General Public License. It also provides other free software developers Less of an advantage over competing non-free programs. These disadvantages are the reason we use the ordinary General Public License for many libraries. However, the Lesser license provides advantages in certain special circumstances.

For example, on rare occasions, there may be a special need to encourage the widest possible use of a certain library, so that it becomes a de-facto standard. To achieve this, non-free programs must be allowed to use the library. A more frequent case is that a free library does the same job as widely used non-free libraries. In this case, there is little to gain by limiting the free library to free software only, so we use the Lesser General Public License.

In other cases, permission to use a particular library in non-free programs enables a greater number of people to use a large body of free software. For example, permission to use the GNU C Library in non-free programs enables many more people to use the whole GNU operating system, as well as its variant, the GNU/Linux operating system.

Although the Lesser General Public License is Less protective of the users' freedom, it does ensure that the user of a program that is linked with the Library has the freedom and the wherewithal to run that program using a modified version of the Library.

The precise terms and conditions for linking, distribution and modification follow. Pay close attention to the difference between a "work based on the library" and a "work that uses the library". The former contains code derived from the library, whereas the latter must be combined with the library in order to run

GNU LESSER GENERAL PUBLIC LICENSE TERMS AND CONDITIONS FOR COPYING, DISTRIBUTION AND MODIFICATION

0. This License Agreement applies to any software library or other program which contains a notice placed by the copyright holder or other authorized party saying it may be distributed under the terms of this Lesser General Public License (also called "this License"). Each licensee is addressed as "you".

A "library" means a collection of software functions and/or data prepared so as to be conveniently linked with application programs (which use some of those functions and data) to form executables.

The "Library", below, refers to any such software library or work which has been distributed under these terms. A "work based on the Library" means either the Library or any derivative work under copyright law: that is to say, a work containing the Library or a portion of it, either verbatim or with modifications and/or translated straightforwardly into another language. (Hereinafter, translation is included without limitation in the term "modification".)

"Source code" for a work means the preferred form of the work for making modifications to it. For a library, complete source code means all the source code for all modules it contains, plus any associated interface definition files, plus the scripts used to control compilation and installation of the library.

Activities other than copying, distribution and modification are not covered by this License; they are outside its scope. The act of running a program using the Library is not restricted, and output from such a program is covered only if its contents constitute a work based on the Library (independent of the use of the Library in a tool for writing it). Whether that is true depends on what the Library does and what the program that uses the Library does.

1. You may copy and distribute verbatim copies of the Library's complete source code as you receive it, in any medium, provided that you conspicuously and appropriately publish on each copy an appropriate copyright notice and disclaimer of warranty; keep intact all the notices that refer to this License and to the absence of any warranty; and distribute a copy of this License along with the Library. You may charge a fee for the physical act of transferring a copy, and you may at your option offer warranty protection in exchange for a fee.
2. You may modify your copy or copies of the Library or any portion of it, thus forming a work based on the Library, and copy and distribute such modifications or work under the terms of Section 1 above, provided that you also meet all of these conditions:
 - a) The modified work must itself be a software library.

- b) You must cause the files modified to carry prominent notices stating that you changed the files and the date of any change.
- c) You must cause the whole of the work to be licensed at no charge to all third parties under the terms of this License.
- d) If a facility in the modified Library refers to a function or a table of data to be supplied by an application program that uses the facility, other than as an argument passed when the facility is invoked, then you must make a good faith effort to ensure that, in the event an application does not supply such function or table, the facility still operates, and performs whatever part of its purpose remains meaningful.

(For example, a function in a library to compute square roots has a purpose that is entirely well-defined independent of the application. Therefore, Subsection 2d requires that any application-supplied function or table used by this function must be optional: if the application does not supply it, the square root function must still compute square roots.)

These requirements apply to the modified work as a whole. If identifiable sections of that work are not derived from the Library, and can be reasonably considered independent and separate works in themselves, then this License, and its terms, do not apply to those sections when you distribute them as separate works. But when you distribute the same sections as part of a whole which is a work based on the Library, the distribution of the whole must be on the terms of this License, whose permissions for other licensees extend to the entire whole, and thus to each and every part regardless of who wrote it.

Thus, it is not the intent of this section to claim rights or contest your rights to work written entirely by you; rather, the intent is to exercise the right to control the distribution of derivative or collective works based on the Library.

In addition, mere aggregation of another work not based on the Library with the Library (or with a work based on the Library) on a volume of a storage or distribution medium does not bring the other work under the scope of this License.

- 3. You may opt to apply the terms of the ordinary GNU General Public License instead of this License to a given copy of the library. To do this, you must alter all the notices that refer to this License so that they refer to the ordinary GNU General Public License, version 2, instead of to this License. (If a newer version than version 2 of the ordinary GNU General Public License has appeared, then you can specify that version instead if you wish.) Do not make any other change in these notices.

Once this change is made in a given copy, it is irreversible for that copy, so the ordinary GNU General Public License applies to all subsequent copies and derivative works made from that copy.

This option is useful when you wish to copy part of the code of the Library into a program that is not a library.

- 4. You may copy and distribute the Library (or a portion or derivative of it, under Section 2) in object code or executable form under the terms of Sections 1 and 2 above provided that you accompany it with the complete corresponding machine-readable source code, which must be distributed under the terms of Sections 1 and 2 above on a medium customarily used for software interchange.

If distribution of object code is made by offering access to copy from a designated place, then offering equivalent access to copy the source code from the same place satisfies the requirement to distribute the source code, even though third parties are not compelled to copy the source along with the object code.

- 5. A program that contains no derivative of any portion of the Library, but is designed to work with the Library by being compiled or linked with it, is called a "work that uses the Library". Such a work, in isolation, is not a derivative work of the Library, and therefore falls outside the scope of this License.

However, linking a "work that uses the Library" with the Library creates an executable that is a derivative of the Library (because it contains portions of the Library), rather than a "work that uses the library". The executable is therefore covered by this License. Section 6 states terms for distribution of such executables.

When a "work that uses the Library" uses material from a header file that is part of the Library, the object code for the work may be a derivative work of the Library even though the source code is not. Whether this is true is especially significant if the work can be linked without the Library, or if the work is itself a library. The threshold for this to be true is not precisely defined by law.

If such an object file uses only numerical parameters, data structure layouts and accessors, and small macros and small inline functions (ten lines or less in length), then the use of the object file is unrestricted, regardless of whether it is legally a derivative work. (Executables containing this object code plus portions of the Library will still fall under Section 6.)

Otherwise, if the work is a derivative of the Library, you may distribute the object code for the work under the terms of Section 6. Any executables containing that work also fall under Section 6, whether or not they are linked directly with the Library itself.

6. As an exception to the Sections above, you may also combine or link a "work that uses the Library" with the Library to produce a work containing portions of the Library, and distribute that work under terms of your choice, provided that the terms permit modification of the work for the customer's own use and reverse engineering for debugging such modifications.

You must give prominent notice with each copy of the work that the Library is used in it and that the Library and its use are covered by this License. You must supply a copy of this License. If the work during execution displays copyright notices, you must include the copyright notice for the Library among them, as well as a reference directing the user to the copy of this License. Also, you must do one of these things:

- a) Accompany the work with the complete corresponding machine-readable source code for the Library including whatever changes were used in the work (which must be distributed under Sections 1 and 2 above); and, if the work is an executable linked with the Library, with the complete machine-readable "work that uses the Library", as object code and/or source code, so that the user can modify the Library and then relink to produce a modified executable containing the modified Library. (It is understood that the user who changes the contents of definitions files in the Library will not necessarily be able to recompile the application to use the modified definitions.)
- b) Use a suitable shared library mechanism for linking with the Library. A suitable mechanism is one that (1) uses at run time a copy of the library already present on the user's computer system, rather than copying library functions into the executable, and (2) will operate properly with a modified version of the library, if the user installs one, as long as the modified version is interface-compatible with the version that the work was made with.
- c) Accompany the work with a written offer, valid for at least three years, to give the same user the materials specified in Subsection 6a, above, for a charge no more than the cost of performing this distribution.
- d) If distribution of the work is made by offering access to copy from a designated place, offer equivalent access to copy the above specified materials from the same place.
- e) Verify that the user has already received a copy of these materials or that you have already sent this user a copy.

For an executable, the required form of the "work that uses the Library" must include any data and utility programs needed for reproducing the executable from it. However, as a special exception, the materials to be distributed need not include anything that is normally distributed (in either source or binary form) with the major components (compiler, kernel, and so on) of the operating system on which the executable runs, unless that component itself accompanies the executable.

It may happen that this requirement contradicts the license restrictions of other proprietary libraries that do not normally accompany the operating system. Such a contradiction means you cannot use both them and the Library together in an executable that you distribute.

7. You may place library facilities that are a work based on the Library side-by-side in a single library together with other library facilities not covered by this License, and distribute such a combined library, provided that the separate distribution of the work based on the Library and of the other library facilities is otherwise permitted, and provided that you do these two things:
 - a) Accompany the combined library with a copy of the same work based on the Library, uncombined with any other library facilities. This must be distributed under the terms of the Sections above.
 - b) Give prominent notice with the combined library of the fact that part of it is a work based on the Library, and explaining where to find the accompanying uncombined form of the same work.
8. You may not copy, modify, sublicense, link with, or distribute the Library except as expressly provided under this License. Any attempt otherwise to copy, modify, sublicense, link with, or distribute the Library is void, and will automatically terminate your rights under this License. However, parties who have received copies, or rights, from you under this License will not have their licenses terminated so long as such parties remain in full compliance.
9. You are not required to accept this License, since you have not signed it. However, nothing else grants you permission to modify or distribute the Library or its derivative works. These actions are prohibited by law if you do not accept this License. Therefore, by modifying or distributing the Library (or any work based on the Library), you indicate your acceptance of this License to do so, and all its terms and conditions for copying, distributing or modifying the Library or works based on it.

10. Each time you redistribute the Library (or any work based on the Library), the recipient automatically receives a license from the original licensor to copy, distribute, link with or modify the Library subject to these terms and conditions. You may not impose any further restrictions on the recipients' exercise of the rights granted herein. You are not responsible for enforcing compliance by third parties with this License.

11. If, as a consequence of a court judgment or allegation of patent infringement or for any other reason (not limited to patent issues), conditions are imposed on you (whether by court order, agreement or otherwise) that contradict the conditions of this License, they do not excuse you from the conditions of this License. If you cannot distribute so as to satisfy simultaneously your obligations under this License and any other pertinent obligations, then as a consequence you may not distribute the Library at all. For example, if a patent license would not permit royalty-free redistribution of the Library by all those who receive copies directly or indirectly through you, then the only way you could satisfy both it and this License would be to refrain entirely from distribution of the Library.

If any portion of this section is held invalid or unenforceable under any particular circumstance, the balance of the section is intended to apply, and the section as a whole is intended to apply in other circumstances.

It is not the purpose of this section to induce you to infringe any patents or other property right claims or to contest validity of any such claims; this section has the sole purpose of protecting the integrity of the free software distribution system which is implemented by public license practices. Many people have made generous contributions to the wide range of software distributed through that system in reliance on consistent application of that system; it is up to the author/donor to decide if he or she is willing to distribute software through any other system and a licensee cannot impose that choice.

This section is intended to make thoroughly clear what is believed to be a consequence of the rest of this License.

12. If the distribution and/or use of the Library is restricted in certain countries either by patents or by copyrighted interfaces, the original copyright holder who places the Library under this License may add an explicit geographical distribution limitation excluding those countries, so that distribution is permitted only in or among countries not thus excluded. In such case, this License incorporates the limitation as if written in the body of this License.

13. The Free Software Foundation may publish revised and/or new versions of the Lesser General Public License from time to time. Such new versions will be similar in spirit to the present version, but may differ in detail to address new problems or concerns.

Each version is given a distinguishing version number. If the Library specifies a version number of this License which applies to it and "any later version", you have the option of following the terms and conditions either of that version or of any later version published by the Free Software Foundation. If the Library does not specify a license version number, you may choose any version ever published by the Free Software Foundation.

14. If you wish to incorporate parts of the Library into other free programs whose distribution conditions are incompatible with these, write to the author to ask for permission. For software which is copyrighted by the Free Software Foundation, write to the Free Software Foundation; we sometimes make exceptions for this. Our decision will be guided by the two goals of preserving the free status of all derivatives of our free software and of promoting the sharing and reuse of software generally.

NO WARRANTY

15. BECAUSE THE LIBRARY IS LICENSED FREE OF CHARGE, THERE IS NO WARRANTY FOR THE LIBRARY, TO THE EXTENT PERMITTED BY APPLICABLE LAW. EXCEPT WHEN OTHERWISE STATED IN WRITING THE COPYRIGHT HOLDERS AND/OR OTHER PARTIES PROVIDE THE LIBRARY "AS IS" WITHOUT WARRANTY OF ANY KIND, EITHER EXPRESSED OR IMPLIED, INCLUDING, BUT NOT LIMITED TO, THE IMPLIED WARRANTIES OF MERCHANTABILITY AND FITNESS FOR A PARTICULAR PURPOSE. THE ENTIRE RISK AS TO THE QUALITY AND PERFORMANCE OF THE LIBRARY IS WITH YOU. SHOULD THE LIBRARY PROVE DEFECTIVE, YOU ASSUME THE COST OF ALL NECESSARY SERVICING, REPAIR OR CORRECTION.

16. IN NO EVENT UNLESS REQUIRED BY APPLICABLE LAW OR AGREED TO IN WRITING WILL ANY COPYRIGHT HOLDER, OR ANY OTHER PARTY WHO MAY MODIFY AND/OR REDISTRIBUTE THE LIBRARY AS PERMITTED ABOVE, BE LIABLE TO YOU FOR DAMAGES, INCLUDING ANY GENERAL, SPECIAL, INCIDENTAL OR CONSEQUENTIAL DAMAGES ARISING OUT OF THE USE OR INABILITY TO USE THE LIBRARY (INCLUDING BUT NOT LIMITED TO LOSS OF DATA OR DATA BEING RENDERED INACCURATE OR LOSSES SUSTAINED BY YOU OR THIRD PARTIES OR A FAILURE OF THE LIBRARY TO OPERATE WITH ANY OTHER SOFTWARE), EVEN IF SUCH HOLDER OR OTHER PARTY HAS BEEN ADVISED OF THE POSSIBILITY OF SUCH DAMAGES.

END OF TERMS AND CONDITIONS

How to Apply These Terms to Your New Libraries

If you develop a new library, and you want it to be of the greatest possible use to the public, we recommend making it free software that everyone can redistribute and change. You can do so by permitting redistribution under these terms (or, alternatively, under the terms of the ordinary General Public License).

To apply these terms, attach the following notices to the library. It is safest to attach them to the start of each source file to most effectively convey the exclusion of warranty; and each file should have at least the "copyright" line and a pointer to where the full notice is found.

<one line to give the library's name and a brief idea of what it does.>

Copyright (C) <year> <name of author>

This library is free software; you can redistribute it and/or modify it under the terms of the GNU Lesser General Public License as published by the Free Software Foundation; either version 2.1 of the License, or (at your option) any later version.

This library is distributed in the hope that it will be useful, but WITHOUT ANY WARRANTY; without even the implied warranty of MERCHANTABILITY or FITNESS FOR A PARTICULAR PURPOSE. See the GNU Lesser General Public License for more details.

You should have received a copy of the GNU Lesser General Public License along with this library; if not, write to the Free Software Foundation, Inc., 51 Franklin Street, Fifth Floor, Boston, MA 02110-1301 USA

Also add information on how to contact you by electronic and paper mail.

You should also get your employer (if you work as a programmer) or your school, if any, to sign a "copyright disclaimer" for the library, if necessary. Here is a sample; alter the names:

Yoyodyne, Inc., hereby disclaims all copyright interest in the library `Frob' (a library for tweaking knobs) written by James Random Hacker.

<signature of Ty Coon>, 1 April 1990

Ty Coon, President of Vice

That's all there is to it!

BSD License (Berkeley Software Distribution License)

This projector product includes the open source software program "University of California, Berkeley License (Berkeley Software Distribution License)" which applies the terms and conditions provided by owner of the copyright to the "BSD License".

The "BSD License" are WITHOUT ANY WARRANTY; without even the implied warranty of MERCHANTABILITY AND FITNESS FOR A PARTICULAR PURPOSE.

List of BSD License programs

busybox_1.7.2

License terms of conditions of each program which are provided by owner of the copyright to the "BSD License" are as follows.

Copyright (c) The Regents of the University of California. All rights reserved.

This code is derived from software contributed to Berkeley by Kenneth Almquist.

Redistribution and use in source and binary forms, with or without modification, are permitted provided that the following conditions are met:

1. Redistributions of source code must retain the above copyright notice, this list of conditions and the following disclaimer.
2. Redistributions in binary form must reproduce the above copyright notice, this list of conditions and the following disclaimer in the documentation and/or other materials provided with the distribution.
3. Neither the name of the University nor the names of its contributors may be used to endorse or promote products derived from this software without specific prior written permission.

THIS SOFTWARE IS PROVIDED BY THE REGENTS AND CONTRIBUTORS "AS IS" AND ANY EXPRESS OR IMPLIED WARRANTIES, INCLUDING, BUT NOT LIMITED TO, THE IMPLIED WARRANTIES OF MERCHANTABILITY AND FITNESS FOR A PARTICULAR PURPOSE ARE DISCLAIMED. IN NO EVENT SHALL THE REGENTS OR CONTRIBUTORS BE LIABLE FOR ANY DIRECT, INDIRECT, INCIDENTAL, SPECIAL, EXEMPLARY, OR CONSEQUENTIAL DAMAGES (INCLUDING, BUT NOT LIMITED TO, PROCUREMENT OF SUBSTITUTE GOODS OR SERVICES; LOSS OF USE, DATA, OR PROFITS; OR BUSINESS INTERRUPTION) HOWEVER CAUSED AND ON ANY THEORY OF LIABILITY, WHETHER IN CONTRACT, STRICT LIABILITY, OR TORT (INCLUDING NEGLIGENCE OR OTHERWISE) ARISING IN ANY WAY OUT OF THE USE OF THIS SOFTWARE, EVEN IF ADVISED OF THE POSSIBILITY OF SUCH DAMAGE.

libjpeg

This projector product includes the open source software program "libjpeg" which applies the terms and conditions provided by owner of the copyright to the "libjpeg".

The "libjpeg" are WITHOUT ANY WARRANTY; without even the implied warranty of MERCHANTABILITY AND FITNESS FOR A PARTICULAR PURPOSE.

List of libjpeg programs

libjpeg-6b

License terms of conditions of each program which are provided by owner of the copyright to the "libjpeg" are as follows.

Copyright (C) 1994-1997, Thomas G. Lane. This file is part of the Independent JPEG Group's software. For conditions of distribution and use, see the accompanying README file.

This distribution contains the sixth public release of the Independent JPEG Group's free JPEG software. You are welcome to redistribute this software and to use it for any purpose, subject to the conditions under LEGAL ISSUES, below.

LEGAL ISSUES

=====

In plain English:

1. We don't promise that this software works. (But if you find any bugs, please let us know!)
2. You can use this software for whatever you want. You don't have to pay us.

3. You may not pretend that you wrote this software. If you use it in a program, you must acknowledge somewhere in your documentation that you've used the IJG code.

In legalese:

The authors make NO WARRANTY or representation, either express or implied, with respect to this software, its quality, accuracy, merchantability, or fitness for a particular purpose. This software is provided "AS IS", and you, its user, assume the entire risk as to its quality and accuracy.

This software is copyright (C) 1991-1998, Thomas G. Lane. All Rights Reserved except as specified below.

Permission is hereby granted to use, copy, modify, and distribute this software (or portions thereof) for any purpose, without fee, subject to these conditions:

- (1) If any part of the source code for this software is distributed, then this README file must be included, with this copyright and no-warranty notice unaltered; and any additions, deletions, or changes to the original files must be clearly indicated in accompanying documentation.
- (2) If only executable code is distributed, then the accompanying documentation must state that "this software is based in part on the work of the Independent JPEG Group".
- (3) Permission for use of this software is granted only if the user accepts full responsibility for any undesirable consequences; the authors accept NO LIABILITY for damages of any kind.

These conditions apply to any software derived from or based on the IJG code, not just to the unmodified library. If you use our work, you ought to acknowledge us.

Permission is NOT granted for the use of any IJG author's name or company name in advertising or publicity relating to this software or products derived from it. This software may be referred to only as "the Independent JPEG Group's software".

We specifically permit and encourage the use of this software as the basis of commercial products, provided that all warranty or liability claims are assumed by the product vendor.

ansi2knr.c is included in this distribution by permission of L. Peter Deutsch, sole proprietor of its copyright holder, Aladdin Enterprises of Menlo Park, CA. ansi2knr.c is NOT covered by the above copyright and conditions, but instead by the usual distribution terms of the Free Software Foundation; principally, that you must include source code if you redistribute it. (See the file ansi2knr.c for full details.) However, since ansi2knr.c is not needed as part of any program generated from the IJG code, this does not limit you more than the foregoing paragraphs do.

The Unix configuration script "configure" was produced with GNU Autoconf. It is copyright by the Free Software Foundation but is freely distributable. The same holds for its supporting scripts (config.guess, config.sub, ltconfig, ltmain.sh). Another support script, install-sh, is copyright by M.I.T. but is also freely distributable.

It appears that the arithmetic coding option of the JPEG spec is covered by patents owned by IBM, AT&T, and Mitsubishi. Hence arithmetic coding cannot legally be used without obtaining one or more licenses. For this reason, support for arithmetic coding has been removed from the free JPEG software. (Since arithmetic coding provides only a marginal gain over the unpatented Huffman mode, it is unlikely that very many implementations will support it.) So far as we are aware, there are no patent restrictions on the remaining code.

The IJG distribution formerly included code to read and write GIF files. To avoid entanglement with the Unisys LZW patent, GIF reading support has been removed altogether, and the GIF writer has been simplified to produce "uncompressed GIFs". This technique does not use the LZW algorithm; the resulting GIF files are larger than usual, but are readable by all standard GIF decoders.

We are required to state that

"The Graphics Interchange Format(c) is the Copyright property of CompuServe Incorporated. GIF(sm) is a Service Mark property of CompuServe Incorporated."

libpng

This projector product includes the open source software program "libpng" which applies the terms and conditions provided by owner of the copyright to the "libpng".

The "libpng" are WITHOUT ANY WARRANTY; without even the implied warranty of MERCHANTABILITY AND FITNESS FOR A PARTICULAR PURPOSE.

List of libpng programs

libpng-1.2.7

License terms of conditions of each program which are provided by owner of the copyright to the "libpng" are as follows.

For conditions of distribution and use, see copyright notice in png.h Copyright (c) 1998-2004 Glenn Randers-Pehrson (Version 0.96 Copyright (c) 1996, 1997 Andreas Dilger) (Version 0.88 Copyright (c) 1995, 1996 Guy Eric Schalnat, Group 42, Inc.)

This copy of the libpng notices is provided for your convenience. In case of any discrepancy between this copy and the notices in the file png.h that is included in the libpng distribution, the latter shall prevail.

COPYRIGHT NOTICE, DISCLAIMER, and LICENSE:

If you modify libpng you may insert additional notices immediately following this sentence.

libpng version 1.2.6, September 12, 2004, is Copyright (c) 2004 Glenn Randers-Pehrson, and is distributed according to the same disclaimer and license as libpng-1.2.5 with the following individual added to the list of Contributing Authors

Cosmin Truta

libpng versions 1.0.7, July 1, 2000, through 1.2.5 - October 3, 2002, are Copyright (c) 2000-2002 Glenn Randers-Pehrson, and are distributed according to the same disclaimer and license as libpng-1.0.6 with the following individuals added to the list of Contributing Authors

Simon-Pierre Cadieux

Eric S. Raymond

Gilles Vollant

and with the following additions to the disclaimer:

There is no warranty against interference with your enjoyment of the library or against infringement. There is no warranty that our efforts or the library will fulfill any of your particular purposes or needs. This library is provided with all faults, and the entire risk of satisfactory quality, performance, accuracy, and effort is with the user.

libpng versions 0.97, January 1998, through 1.0.6, March 20, 2000, are Copyright (c) 1998, 1999 Glenn Randers-Pehrson, and are distributed according to the same disclaimer and license as libpng-0.96, with the following individuals added to the list of Contributing Authors:

Tom Lane

Glenn Randers-Pehrson

Willem van Schaik

libpng versions 0.89, June 1996, through 0.96, May 1997, are Copyright (c) 1996, 1997 Andreas Dilger Distributed according to the same disclaimer and license as libpng-0.88, with the following individuals added to the list of Contributing Authors:



FixYourDLP.com

powered by DLP

FixYourDLP.com (800) 281-8860

THE TRUSTED SOURCE FOR PROJECTOR LAMPS AND ACCESSORIES

John Bowler
 Kevin BraceySam Bushell
 Sam Bushell
 Magnus Holmgren
 Greg Roelofs
 Tom Tanner

libpng versions 0.5, May 1995, through 0.88, January 1996, are Copyright (c) 1995, 1996 Guy Eric Schalnat, Group 42, Inc.

For the purposes of this copyright and license, "Contributing Authors" is defined as the following set of individuals:

Andreas Dilger
 Dave Martindale
 Guy Eric Schalnat
 Paul Schmidt
 Tim Wegner

The PNG Reference Library is supplied "AS IS". The Contributing Authors and Group 42, Inc. disclaim all warranties, expressed or implied, including, without limitation, the warranties of merchantability and of fitness for any purpose. The Contributing Authors and Group 42, Inc. assume no liability for direct, indirect, incidental, special, exemplary, or consequential damages, which may result from the use of the PNG Reference Library, even if advised of the possibility of such damage.

Permission is hereby granted to use, copy, modify, and distribute this source code, or portions hereof, for any purpose, without fee, subject to the following restrictions:

1. The origin of this source code must not be misrepresented.
2. Altered versions must be plainly marked as such and must not be misrepresented as being the original source.
3. This Copyright notice may not be removed or altered from any source or altered source distribution.

The Contributing Authors and Group 42, Inc. specifically permit, without fee, and encourage the use of this source code as a component to supporting the PNG file format in commercial products. If you use this source code in a product, acknowledgment is not required but would be appreciated.

A "png_get_copyright" function is available, for convenient use in "about" boxes and the like:

```
printf("%s",png_get_copyright(NULL));
```

Also, the PNG logo (in PNG format, of course) is supplied in the files "pngbar.png" and "pngbar.jpg (88x31) and "pngnow.png" (98x31).

Libpng is OSI Certified Open Source Software. OSI Certified Open Source is a certification mark of the Open Source Initiative.

Glenn Randers-Pehrson
 glennrp@users.sourceforge.net
 September 12, 2004

zlib

This projector product includes the open source software program "zlib" which applies the terms and conditions provided by owner of the copyright to the "zlib".

The "zlib" are WITHOUT ANY WARRANTY; without even the implied warranty of MERCHANTABILITY AND FITNESS FOR A PARTICULAR PURPOSE.

List of zlib programs

zlib-1.1.4

License terms of conditions of each program which are provided by owner of the copyright to the "zlib" are as follows.

Copyright notice:

(C) 1995-1998 Jean-loup Gailly and Mark Adler

This software is provided 'as-is', without any express or implied warranty. In no event will the authors be held liable for any damages arising from the use of this software.

Permission is granted to anyone to use this software for any purpose, including commercial applications, and to alter it and redistribute it freely, subject to the following restrictions:

1. The origin of this software must not be misrepresented; you must not claim that you wrote the original software. If you use this software in a product, an acknowledgment in the product documentation would be appreciated but is not required.
2. Altered source versions must be plainly marked as such, and must not be misrepresented as being the original software.
3. This notice may not be removed or altered from any source distribution.

Jean-loup Gailly
 jloup@gzip.org

Mark Adler
 madler@alumni.caltech.edu

If you use the zlib library in a product, we would appreciate *not* receiving lengthy legal documents to sign. The sources are provided for free but without warranty of any kind. The library has been entirely written by Jean-loup Gailly and Mark Adler; it does not include third-party code.

If you redistribute modified sources, we would appreciate that you include in the file ChangeLog history information documenting your changes.

libmd5-rfc

This projector product includes the open source software program "libmd5-rfc" which applies the terms and conditions provided by owner of the copyright to the "libmd5-rfc".

The "libmd5-rfc" are WITHOUT ANY WARRANTY; without even the implied warranty of MERCHANTABILITY AND FITNESS FOR A PARTICULAR PURPOSE.

List of libmd5-rfc programs

libmd5-rfc

License terms of conditions of each program which are provided by owner of the copyright to the "libmd5-rfc" are as follows.

Copyright (C) 1999, 2002 Aladdin Enterprises. All rights reserved.

This software is provided 'as-is', without any express or implied warranty. In no event will the authors be held liable for any damages arising from the use of this software.

Permission is granted to anyone to use this software for any purpose, including commercial applications, and to alter it and redistribute it freely, subject to the following restrictions:

1. The origin of this software must not be misrepresented; you must not claim that you wrote the original software. If you use this software in a product, an acknowledgment in the product documentation would be appreciated but is not required.
2. Altered source versions must be plainly marked as such, and must not be misrepresented as being the original software.
3. This notice may not be removed or altered from any source distribution.

L. Peter Deutsch ghost@aladdin.com

Independent implementation of MD5 (RFC 1321).

This code implements the MD5 Algorithm defined in RFC 1321, whose text is available at

<http://www.ietf.org/rfc/rfc1321.txt>

The code is derived from the text of the RFC, including the test suite (section A.5) but excluding the rest of Appendix A. It does not include any code or documentation that is identified in the RFC as being copyrighted.

The original and principal author of md5.h is L. Peter Deutsch <ghost@aladdin.com>. Other authors are noted in the change history that follows (in reverse chronological order):

2002-04-13 lpd Removed support for non-ANSI compilers; removed

references to Ghostscript; clarified derivation from RFC 1321; now handles byte order either statically or dynamically.

1999-11-04 lpd Edited comments slightly for automatic TOC extraction.

1999-10-18 lpd Fixed typo in header comment (ansi2knr rather than md5);

added conditionalization for C++ compilation from Martin Purschke <purschke@bnl.gov>.

1999-05-03 lpd Original version.

ncurses

This projector product includes the open source software program "ncurses" which applies the terms and conditions provided by owner of the copyright to the "ncurses".

The "ncurses" are WITHOUT ANY WARRANTY; without even the implied warranty of MERCHANTABILITY AND FITNESS FOR A PARTICULAR PURPOSE.

List of ncurses programs

ncurses-5.6

License terms of conditions of each program which are provided by owner of the copyright to the "ncurses" are as follows.

Copyright (c) 1998-2002,2003 Free Software Foundation, Inc.

Permission is hereby granted, free of charge, to any person obtaining a copy of this software and associated documentation files (the "Software"), to deal in the Software without restriction, including without limitation the rights to use, copy, modify, merge, publish, distribute, distribute with modifications, sublicense, and/or sell copies of the Software, and to permit persons to whom the Software is furnished to do so, subject to the following conditions:

The above copyright notice and this permission notice shall be included in all copies or substantial portions of the Software.

THE SOFTWARE IS PROVIDED "AS IS", WITHOUT WARRANTY OF ANY KIND, EXPRESS OR IMPLIED, INCLUDING BUT NOT LIMITED TO THE WARRANTIES OF MERCHANTABILITY, FITNESS FOR A PARTICULAR PURPOSE AND NONINFRINGEMENT. IN NO EVENT SHALL THE ABOVE COPYRIGHT HOLDERS BE LIABLE FOR ANY CLAIM, DAMAGES OR OTHER LIABILITY, WHETHER IN AN ACTION OF CONTRACT, TORT OR OTHERWISE, ARISING FROM, OUT OF OR IN CONNECTION WITH THE SOFTWARE OR THE USE OR OTHER DEALINGS IN THE SOFTWARE.

Except as contained in this notice, the name(s) of the above copyright holders shall not be used in advertising or otherwise to promote the sale, use or other dealings in this Software without prior written authorization.

For embedded multimedia software:

This product contains embedded multimedia software licensed from Ingenient Technologies, Inc. (www.ingenient.com).

Copyright© 2000-2007 Ingenient Technologies, Inc. All rights reserved.

For MPEG-4 ASP:

With respect to a Licensee offering MPEG-4 Video Decoders and/or Encoders the following notice shall be given: THIS PRODUCT IS LICENSED UNDER THE MPEG-4 VISUAL PATENT PORTFOLIO LICENSE FOR THE PERSONAL AND NON-COMMERCIAL USE OF A CONSUMER FOR (i) ENCODING VIDEO IN COMPLIANCE WITH THE MPEG-4 VISUAL STANDARD ("MPEG-4 VIDEO") AND/OR (ii) DECODING MPEG-4 VIDEO THAT WAS ENCODED BY A CONSUMER ENGAGED IN A PERSONAL AND NON-COMMERCIAL ACTIVITY AND/OR WAS OBTAINED FROM A VIDEO PROVIDER LICENSED BY MPEG LA TO PROVIDE MPEG-4 VIDEO. NO LICENSE IS GRANTED OR SHALL BE IMPLIED FOR ANY OTHER USE. ADDITIONAL INFORMATION INCLUDING THAT RELATING TO PROMOTIONAL, INTERNAL AND COMMERCIAL USES AND LICENSING MAY BE OBTAINED FROM MPEG LA,LLC. SEE [HTTP://WWW.MPEGLA.COM](http://WWW.MPEGLA.COM).

For MPEG-4 AVC:

THIS PRODUCT IS LICENSED UNDER THE AVC PATENT PORTFOLIO LICENSE FOR THE PERSONAL AND NON-COMMERCIAL USE OF A CONSUMER TO (i) ENCODE VIDEO IN COMPLIANCE WITH THE AVC STANDARD ("AVC VIDEO") AND/OR (ii) DECODE AVC VIDEO THAT WAS ENCODED BY A CONSUMER ENGAGED IN A PERSONAL AND NON-COMMERCIAL ACTIVITY AND/OR WAS OBTAINED FROM A VIDEO PROVIDER LICENSED TO PROVIDE AVC VIDEO. NO LICENSE IS GRANTED OR SHALL BE IMPLIED FOR ANY OTHER USE. ADDITIONAL INFORMATION MAY BE OBTAINED FROM MPEG LA, L.L.C. SEE [HTTP://WWW.MPEGLA.COM](http://WWW.MPEGLA.COM)

For WMV/WMA (Microsoft):

This product is protected by certain intellectual property rights of Microsoft.

Use or distribution of such technology outside of this product is prohibited without a license from Microsoft.

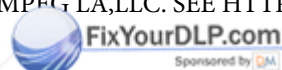

Discount-Merchant.com (800) 281-8860
THE TRUSTED SOURCE FOR PROJECTOR LAMPS AND ACCESSORIES

A

A/V Mute	32
Abs. Color Temp.	53
Address 1 Setting	76
Address 2 Setting	76
Address 3 Setting	76
Air exhaust vent	10
Air filter cover latch	10
Air filter replacement period	102
Air intake vent	12, 13, 14
Aspect	33, 55
Audio Out port	11, 13
Audio-L/R port	11, 13
Auto	35, 36
Auto H/V-Keystone	23, 56
Auto Iris	32, 54
Auto Keystone	56
Auto Setup	54

B

Basic menu	62, 74
Blackboard	31
Brightness	53

C

Ceiling	58, 95
Ceiling mount fixing points	15
Cleaning	96
Cleaning the Air filter and Air intake vent	97
Cleaning the Projector's Surface	96
Color Adjustment	54

Color Mode	31, 53
Color Saturation	53
Computer1 Input Port	12, 13, 15
Computer2 Input Port	12, 13, 15
Configuration Menu	52
Connecting LAN Cable	118
Connecting to an External Monitor	119
Connecting USB Devices	113
Connection mode	63
Consumables	104
Contrast	53
Control Panel	16, 17, 18
Control Panel Lock	49, 56
Cross	39
Customized	31

D

DHCP	63, 68
Direct Power On	59
Display	58
Display Background	58
Distance	111
Document camera	104
Dynamic	31

E

EAP-Fast/GTC	68
EAP-Fast/MS-CHAPv2	68
EAP-TLS	68
EAP-TTLS/MD5	68
EAP-TTLS/MS-CHAPv2	68
Email Address	69
ESC/VP21	122

Extended Menu	58
E-Zoom	39

F

Focus buttons	11
Focus ring	10
Foot adjust lever	10
Freeze	33
Front	58, 95
Front adjustable foot	10
Full	36
Full Lock	49

G

Gateway Address	63, 69, 75
-----------------------	------------

H

H/V-Keystone	26
HDMI input port	12
HDMI Video Range	55
Help function	82
High Altitude Mode	59
How to replace the air filter	102
How to replace the lamp	99

I

Image Menu	53
Indicators	16, 17, 18, 83
Info Menu	79
Input Signal	55, 79
IP Address	63, 68, 69, 76

K

Keystone 56

L

Lamp cover 11
 Lamp Hours 79
 Lamp replacement period 99
 LAN port 12, 13
 Language 59
 LEAP 68
 Lens Cover Timer 59

M

MAC Address 64, 69
 Mail Notification 69, 76
 Mail Notification menu 69, 76
 Messages 58
 Monitor Displays 126
 Monitor Out port 11, 13
 Mouse Pointer 40
 Multiple Projectors 45
 Multi-screen 45, 59

N

Native 37
 Network Configuration 60, 72
 Network information 60, 72
 Network Menu 60, 72
 Network Projector 124
 Network Protect 48
 Noise Reduction 55
 Normal 35, 36

O

Operating temperature 133
 Operation 59
 Optional accessories 104
 Others menu 70, 77
 Overheating 84

P

Part Names and Functions 10
 Password Protect 47
 Password protect sticker 48
 PEAP/GTC 68
 PEAP/MS-CHAPv2 68
 Photo 31
 PIN Code Method 107, 109
 PJLink 124, 125
 PJLink Password 62, 74
 Pointer 38
 Pointer Shape 56
 Port Number 69, 76
 Position 55
 Power Consumption 56
 Power inlet 11, 13, 14
 Power On Protect 47
 Presentation 31
 Problem Solving 83
 Progressive 55
 Projection 58
 Projector ID 42, 59
 Projector keyword 62, 74
 Projector Name 62, 74
 Push Button Method 107, 108

Q

Quick Corner 26, 56

R

Reading Problem Mail Notification 121
 Rear 58, 95
 Rear foot 15
 Rear screen 95
 Refresh Rate 79
 Remote Control 19
 remote control ID 43
 Remote Receiver 10, 12, 13, 14
 Replacing batteries 98
 Reset All 80
 Reset menu 71, 78, 80
 Resetting the lamp operating time
 80, 102
 Resolution 79

S

Screen Fit 23
 Screen size 111
 Security menu 64
 Security slot 12, 13, 14
 Settings Menu 56
 Sharpness 53
 Signal Menu 54
 Sleep Mode 59
 SMTP Server 69, 76
 Soft keyboard 61, 73
 Software Requirements 135
 Source 79

Source Search 16, 17, 18, 29
 Specifications 132
 Sports 31
 sRGB 12, 31
 SSID 63
 Standby Mode 59
 Startup Screen 58
 Storage temperature 133
 Subnet Mask 63, 69, 75
 Supported Monitor Displays 126
 S-Video Input Port 11, 13
 Sync Info 79
 Sync. 55

T

Test Pattern 57
 Theatre 31
 Tint 53
 Tracking 55
 Trap IP Address 70, 77

U

USB Display 115
 USB indicator 11
 USB Type B 59
 USB(TypeA) port 13
 USB(TypeB) port 12, 13, 15
 USB1 port 12
 USB2 port 12
 User Button 57
 User's Logo 105, 107
 User's Logo Protect 47

V

Video Input Port 11, 13, 14
 Video Signal 55, 79
 Volume 57

W

Web Control Password 62, 74
 WEP 66
 Whiteboard 31
 Wide-screen projection 33
 Wi-Fi Protected Setup 107
 Wired LAN menu 68, 75
 Wireless LAN indicator 10
 Wireless LAN menu 63
 Wireless LAN Power 63
 Wireless LAN system 63
 Wireless LAN unit cover 10
 Wireless Mouse 40
 WPA2-PSK(AES) 67
 WPA-PSK(TKIP) 67

Z

Zoom 37
 Zoom ring 10

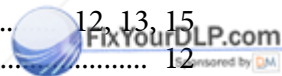

Discount-Merchant.com (800) 281-8860

THE TRUSTED SOURCE FOR PROJECTOR LAMPS AND ACCESSORIES



Disclaimer

This user manual is provided as a free service by FixYourDLP.com. FixYourDLP is in no way responsible for the content of this manual, nor do we guarantee its accuracy. FixYourDLP does not make any claim of copyright and all copyrights remain the property of their respective owners.

About FixYourDLP.com

FixYourDLP.com (<http://www.fixyourdlp.com>) is the World's #1 resource for media product news, reviews, do-it-yourself guides, and manuals.

Informational Blog: <http://www.fixyourdlp.com>

Video Guides: <http://www.fixyourdlp.com/guides>

User Forums: <http://www.fixyourdlp.com/forum>

FixYourDLP's Fight Against Counterfeit Lamps:

<http://www.fixyourdlp.com/counterfeits>

Sponsors:

RecycleYourLamp.org – Free lamp recycling services for used lamps:

<http://www.recycleyourlamp.org>

Lamp Research - The trusted 3rd party lamp research company:

<http://www.lampresearch.com>

Discount-Merchant.com – The worlds largest lamp distributor:

<http://www.discount-merchant.com>



FixYourDLP.com

Sponsored by 